

DMX4707S

MONITOR WITH RECEIVER
INSTRUCTION MANUAL

JVCKENWOOD Corporation

- Updated information (the latest Instruction Manual, etc.) is available from <http://www.kenwood.com/cs/ce/>.



Contents

Before Use 3

Precautions.....	3
How to read this manual	3

Basic Operations 4

Functions of the Buttons on the Front Panel ...	4
Turning on the Unit	4
Initial Settings.....	5
Adjusting the volume	6
Touch screen operations	6
HOME screen descriptions.....	7
Source selection screen descriptions.....	7
Source control screen descriptions	9
MENU screen.....	9
List screen	10

APPS-Android Auto™/ Apple CarPlay 11

Apple CarPlay Operation	11
Android Auto™ Operation.....	12

USB 13

Connecting a USB device	13
USB Basic Operation.....	13
Search Operation.....	15

Radio 16

Radio Basic Operation	16
Memory Operation	17
Selecting Operation	17
Traffic Information (FM only).....	18
Radio Setup	18

Bluetooth Control 19

Information for using Bluetooth® devices.....	19
Register from the Bluetooth device.....	20
Bluetooth Setup.....	20
Playing Bluetooth Audio Device	21
Using Hands-Free Unit.....	23

Other External Components 27

View Camera	27
External audio/video players—AV-IN	28

Setting Up 29

Monitor Screen Setup.....	29
System Setup	29
User Interface Setup.....	30
Special Setup	30
Display Setup.....	31
AV Setup	32

Controlling Audio 33

Speaker/ X'over setup	33
Controlling General Audio.....	34
Equalizer Control.....	35
Volume Offset.....	36
Sound Effect	36
Listening Position/ DTA.....	37

Remote control 38

Functions of the Remote control Buttons.....	38
--	----

Connection/Installation 39

Before Installation	39
Installing the unit	39

Troubleshooting 44

Problems and Solutions	44
Error Messages	44

Appendix 45

Playable Media and Files.....	45
Specifications.....	46
About this Unit	48

Before Use

Precautions

▲ WARNINGS

■ To prevent injury or fire, take the following precautions:

- To prevent a short circuit, never put or leave any metallic objects (such as coins or metal tools) inside the unit.
- Do not watch or fix your eyes on the unit's display when you are driving for any extended period.
- If you experience problems during installation, consult your KENWOOD dealer.

■ Precautions on using this unit

- When you purchase optional accessories, check with your KENWOOD dealer to make sure that they work with your model and in your area.
- You can select language to display menus, audio file tags, etc. See **User Interface Setup (P.30)**.
- The Radio Data System or Radio Broadcast Data System feature won't work where the service is not supported by any broadcasting station.

■ Protecting the monitor

- To protect the monitor from damage, do not operate the monitor using a ball point pen or similar tool with the sharp tip.

■ Cleaning the unit

- If the faceplate of this unit is stained, wipe it with a dry soft cloth such as a silicon cloth. If the faceplate is stained badly, wipe the stain off with a cloth moistened with neutral cleaner, then wipe it again with a clean soft dry cloth.

NOTE

- Applying spray cleaner directly to the unit may affect its mechanical parts. Wiping the faceplate with a hard cloth or using a volatile liquid such as thinner or alcohol may scratch the surface or erase screened print.

■ How To Reset Your Unit

- If the unit or the connected unit fails to operate properly, reset the unit.1 Press the <Reset> button. The unit returns to factory settings.



Reset button

NOTE

- Disconnect the USB device before pressing the <Reset> button. Pressing the <Reset> button with the USB device connected can damage the data stored in the USB device. For how to disconnect the USB device, see **Disconnect the USB device (P.13)**.
- When the unit is turned on after resetting, the Initial SETUP screen appears. See **Initial setup (P.6)**.

How to read this manual

- The screens and panels shown in this manual are examples used to provide clear explanations of the operations. For this reason, they may be different from the actual screens or panels used, or some display patterns may be different.
- **Indication language:** English indications are used for the purpose of explanation. You can select the indication language from the **SETUP** menu. See **User Interface Setup (P.34)**.

Basic Operations

Functions of the Buttons on the Front Panel

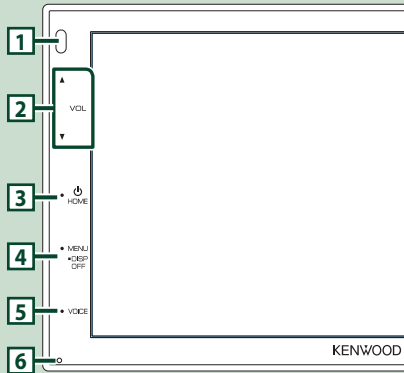

NOTE

- The panels shown in this guide are examples used to provide clear explanations of the operations. For this reason, they may be different from the actual panels.

	Name • Motion
1	Remote Sensor • Receives the remote control signal.
2	▼, ▲(VOL) • Adjusts volume. The volume will go up until 15 when you keep pressing ▲.
3	HOME • Displays the HOME screen (P.7). • Pressing for 1 second turns the power off. • When the power off, turns the power on.
4	MENU • Displays the MENU screen. • Pressing for 1 second turns the screen off.
5	VOICE • Displays the Voice Recognition screen (P.26).
6	Reset • If the unit or the connected unit fails to operate properly, the unit returns to initial settings when this button is pressed.

Turning on the Unit

The method of turning on is different depending on the model.

- 1 Press the **HOME** button.

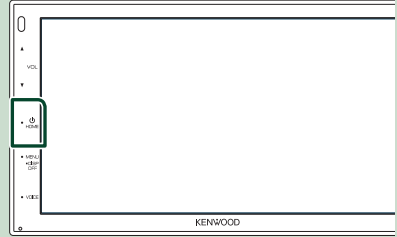

- The unit is turned on.

- To turn off the unit:

- 1 Press the **HOME** button for 1 second.

NOTE

- If it is your first time turning the unit on after installation, it will be necessary to perform Initial setup (P.7).

Initial Settings

Initial setup

Perform this setup when you use this unit first time.

1 Set each item as follows.

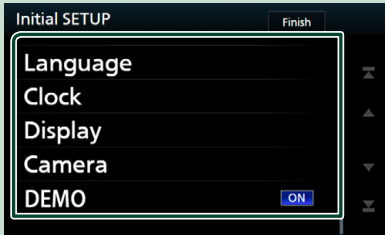

■ Language

Select the language used for the control screen and setting items. Default is "British English(en)".

- ① Touch **Language**.
- ② Touch **Language Select**.
- ③ Select the desired language.
- ④ Touch .

For detailed operation, see **User Interface Setup (P.30)**.

■ Clock

Adjusts clock.

For detailed operation, see **Calendar/clock settings (P.6)**.

■ Display

Set the image on the screen.

- ① Touch **Display**.
- ② Touch **Background**.
- ③ Select the image.
- ④ Touch .

For detailed operation, see **Display Setup (P.31)**.

■ Camera

Set the parameters for the camera.

- ① Touch **Camera**.
- ② Set each item and touch .

For detailed operation, see **Camera Setup (P.27)**.

■ DEMO

Set the demonstration mode. Default is "ON".

- ① Touch **DEMO** and set ON or OFF.

2 Touch Finish.

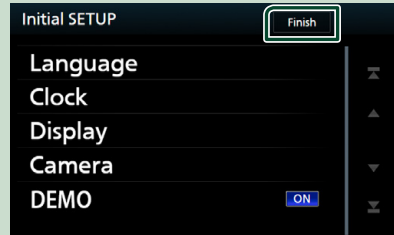

NOTE

- These settings can be set from the SETUP menu. See **Setting Up (P.29)**.

Calendar/clock settings

- 1 Press the **MENU** button.
➤ MENU screen appears.

- 2 Touch .



- SETUP Menu screen appears.

- 3 Touch **User Interface**.



- User Interface screen appears.

- 4 Touch **Clock Adjust**.



- 5 Adjust the date, then adjust the time.



- 6 Touch **Set**.

NOTE

- Deactivate **RDS CT** before adjusting the clock. See **Radio Setup (P.16)**.

Adjusting the volume

To adjust the volume (0 to 40),
Press ▲ to increase, and press ▼ to decrease.
Holding ▲ increases the volume continuously
to level 15.



Touch screen operations

To perform operations on the screen, you need to touch, touch and hold, flick or swipe to select an item, display setting menu screen or to change the page, etc.

● Touch

Touch the screen gently to select an item on the screen.



HOME screen descriptions

Most functions can be performed from the HOME screen.



- | | |
|---|---|
| 1 | • Displays the control screen of current source. |
| 2 | • Current source information |
| 3 | • Displays the source selection screen. |
| 4 | • Short-cut playback source icons |
| 5 | • Displays the Hands Free screen.
• When connecting as Apple CarPlay or Android Auto, it works as a phone provided in Apple CarPlay or Android Auto. |

Display the HOME

- 1 Press the **HOME** button.

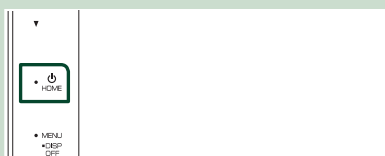

- HOME screen appears.

Source selection screen descriptions

You can display all playback sources and options on the source selection screen.

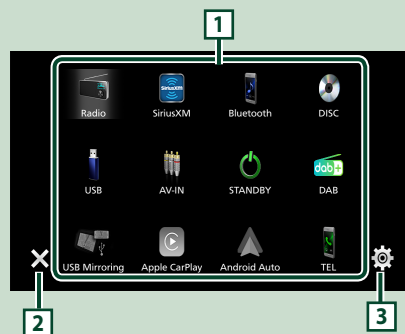









- | | |
|---|--|
| 1 | • Changes the playback source.
For playback sources, see . |
| 2 | • Returns to previous screen. |
| 3 | • Displays the SETUP Menu screen. |

Select the playback source

1 Touch on the HOME screen.

From the screen, you can select the following sources and functions.

	• Switches to the Apple CarPlay screen from the connected iPhone. (P.##)
	• Switches to the Android Auto screen from the connected Android device. (P.##)
	• Displays the Hands Free screen. (P.##) When neither Apple CarPlay, Android Auto, nor a Bluetooth Hands-Free phone is connected, displays Bluetooth pairing waiting dialog.* (P.##)
	• Switches to the Radio broadcast.
	• Switches to the Digital Radio broadcast. (P.##)
	• Plays a Bluetooth audio player.
	• USB Plays files on a USB device. (P.##)
	• Switches to an external component connected to the AV-IN input terminal.

* When connecting as Apple CarPlay or Android Auto, it works as a phone provided in Apple CarPlay or Android Auto.



To select the playback source on the HOME screen



The 4 items displayed on the source selection screen as the large icons are shown on the HOME screen.

To select the playback source on the source control screen



Display source selection buttons by touching  /  or flicking left or right on the source control screen, then select a playback source.

Source control screen descriptions

There are some functions which can be operated from most screens.

Indicators

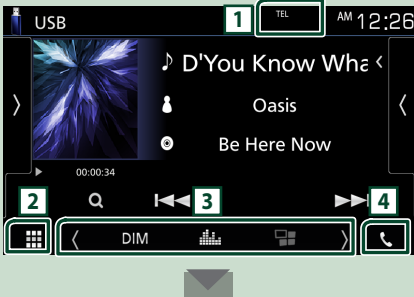

Short-cut buttons



Connected Bluetooth device information.

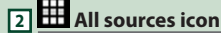

Displays all sources.



- : The Secondary screen changes every time you touch it. You can also change the Secondary screen by flicking left or right on the screen.

- Indicators: Displays the current source condition and so on.

- **ATT**: The attenuator is active.
- **LOUD**: The loudness control function is on.



Touch to display the Hands Free screen.

(P.27)

When connecting as Apple CarPlay or Android Auto, it works as a phone provided in Apple CarPlay or Android Auto.

MENU screen

1 Press the **MENU** button.

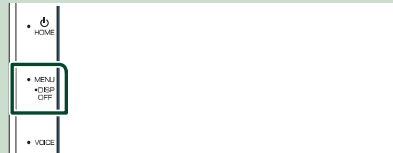

> MENU screen appears.

2 Touch to display the MENU screen.



Turn off the screen

- 1 Select  on the MENU screen.



- To turn on the screen

- 1 Touch the display.

List screen

There are some common function keys in the list screens of most sources.

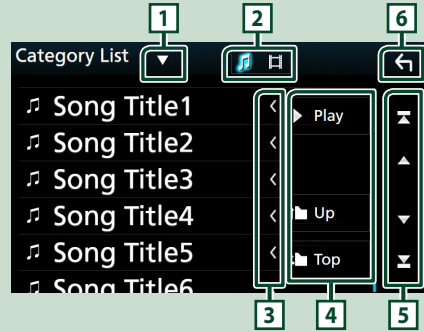

Displays list type selection window.

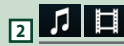



Displays music/movie file list.

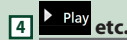

Scrolls the displayed text.





Keys with various functions are displayed here.

-  **Play**: Plays all tracks in the folder containing the current track.
-  **Up** /  **Top**: Moves to the upper hierarchy.



You can change the page to display more items by pressing  / .

-  / : Displays the top or bottom page.



Returns to previous screen.

NOTE

- Buttons which cannot be activated from the list screen are not displayed.

APPS-Android Auto™/ Apple CarPlay

Apple CarPlay Operation

CarPlay is a smarter, safer way to use your iPhone in the car. CarPlay takes the things you want to do with iPhone while driving and displays them on the screen of the product. You can get directions, make calls, send and receive messages, and listen to the music from iPhone while driving. You can also use Siri voice control to make it easier to operate iPhone.

For details about CarPlay, visit <https://ssl.apple.com/ios/carplay/>.

Compatible iPhone devices

You can use CarPlay with the following iPhone models.

- iPhone 7 Plus
- iPhone 7
- iPhone SE
- iPhone 6s Plus
- iPhone 6s
- iPhone 6 Plus
- iPhone 6
- iPhone 5s
- iPhone 5c
- iPhone 5

Preparation

1 Connect iPhone using KCA-iP103 via USB terminal. (P.47)

When iPhone compatible with CarPlay is connected to the USB terminal, the Bluetooth smartphone currently connected is disconnected.

2 Unlock your iPhone.

Operation buttons and available Apps on the home screen of CarPlay

You can use the Apps of the connected iPhone. The items displayed and the language used on the screen differ among the connected devices.

To enter CarPlay mode, touch **Apple CarPlay** icon in the HOME screen.

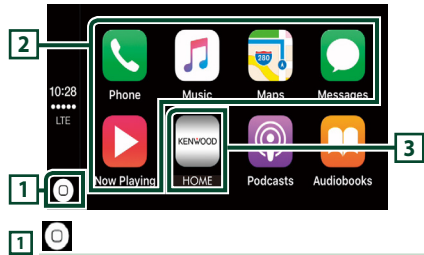

- Displays the home screen of CarPlay.
- Touch and hold to activates Siri.

2 Application buttons

Starts the application.

3 HOME

Exits the CarPlay screen and displays the Home screen.

To exit the CarPlay screen

1 Press the **HOME** button.

Use Siri

You can activate Siri.

1 Press the **VOICE** button.

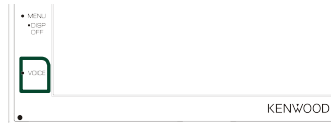

2 Talk to Siri.

Switch to the Apple CarPlay screen while listening to another source

1 Press the **HOME** button.

➤ HOME screen appears.

2 Touch **Apple CarPlay**.

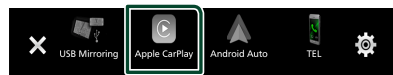

NOTE

- If sound is output using Apple CarPlay when the Apple CarPlay screen is displayed, the source is switched to Apple CarPlay.

Android Auto™ Operation

Android Auto enables you to use functions of your Android device convenient for driving. You can easily access route guidance, make calls, listen to music, and access convenient functions on the Android device while driving.

For details about Android Auto, visit <https://www.android.com/auto/> and <https://support.google.com/androidauto>.

Compatible Android devices

You can use Android Auto with Android devices of Android version 5.0 (Lollipop) or later.

NOTE

- Android Auto may not be available on all devices and is not available in all countries or regions.

Preparation

1 Connect an Android device via USB terminal. (P.47)

To use the hands-free function, connect the Android device via Bluetooth.

When an Android device compatible with Android Auto is connected to the USB terminal, the device is connected via Bluetooth automatically, and the Bluetooth smartphone currently connected is disconnected.

2 Unlock your Android device.

Operation buttons and available Apps on the Android Auto screen

You can perform the operations of the Apps of the connected Android device.

The items displayed on the screen differ among the connected Android devices.

To enter Android Auto mode, touch **Android Auto** icon in the HOME screen. (P.9)

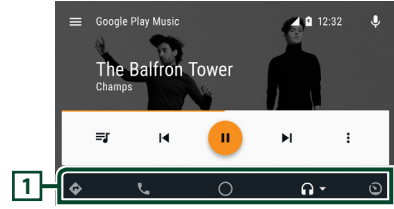

1 Application/information buttons

Starts the application or displays information.

To exit the Android Auto screen

1 Press the HOME button.

Using voice control

1 Press the VOICE button .

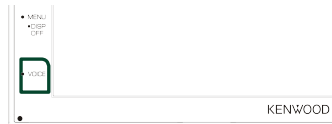

To cancel

1 Press the VOICE button.

Switch to the Android Auto screen while listening to another source

1 Press the HOME button.

➤ HOME screen appears.

2 Touch Android Auto .

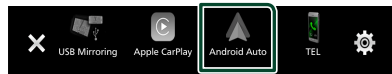

NOTE

- If sound is output using Android Auto when the Android Auto screen is displayed, the source is switched to Android Auto.

USB

Connecting a USB device

- 1 Connect the USB device with the USB cable. (P.46)

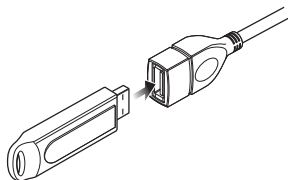

- 2 Press the **HOME** button.
- 3 Touch .
- 4 Touch **USB**.

Disconnect the USB device

- 1 Press the **HOME** button.
- 2 Touch a source other than **USB**.
- 3 Detach the USB device.

Usable USB device

You can use a mass-storage-class USB device on this unit.

The word "USB device" appearing in this manual indicates a flash memory device.

● About file system

The file system should be the one of the following.

- FAT16
- FAT32
- NTFS

NOTE

- Install the USB device in the place where it will not affect safe driving.
- You cannot connect a USB device via a USB hub and Multi Card Reader.
- Take backups of the audio files used with this unit. The files can be erased depending on the operating conditions of the USB device. We shall have no compensation for any damage arising from any erased data.

USB Basic Operation





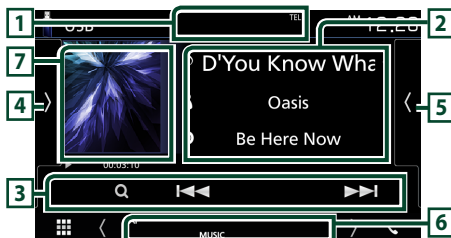

Most functions can be controlled from the source control screen and playback screen.

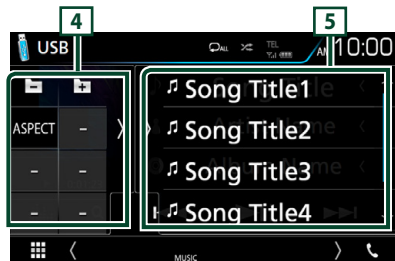
Control screen



Open the drawer



- : Repeats the current track/folder. Each time you touch the key, repeat mode switches in the following sequence; File repeat () , Folder repeat () , Repeat all ()
- : Randomly plays all tracks in current folder. Each time you touch the key, random mode switches in the following sequence; File random () , Random off ()
- When a high-resolution source is played, its format information is displayed.

2 Track information

Displays the information of the current file.

Only a file name and a folder name are displayed if there is no tag information.

3 Operation keys

- **Q** : Searches track/file. For details on search operation
- **◀◀ ▶▶** : Searches the previous/next track/file.
Touch and hold to fast forward or fast backward.
- **▶ ||** : Plays or pauses.
- **🔊** : Touch to attenuates/restores the sound.

4 Function panel

Touch on the left side of the screen to display the function panel. Touch again to close the panel.

- **[-] [+]** : Searches previous/next folder.
- **Aspect**: Select screen mode.
Full: Changes the aspect ratio of video and displays fully on the screen.
Normal: Display with 4:3 ratio.
Auto: Displays video fully on vertical or horizontal with no ratio change.

5 Content list

Touch on the right side of the screen to display the Content list. Touch again to close the list.

Displays the playing list. When you touch a track/file name on the list, playback will start.

6 Indicator Items

- **VIDEO**: Identifies the video file.
- **MUSIC**: Identifies the music file.

7 Artwork/ Play mode indicator/ Playing time

The jacket of the currently playing file is displayed.

- **▶, ▶▶**, etc.: Current play mode indicator
The meanings of each icon are as follows;
▶ (play), **▶▶** (fast forward), **◀◀** (fast backward), **||** (pause).

Video screen



8 Searching file area (Video file only)

Touch to search the next/previous file.

9 Key display area (Video file only)

Touch to display the control screen.

Search Operation

You can search music or video files by the following operations.

1 Touch **Q**.

2 Touch **▼**.



3 Select the list type.

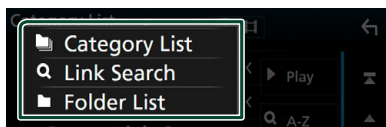

NOTE

- For operations in the list screen, see *List screen (P.11)*.

Category search

You can search a file by selecting category.

1 Touch **Category List**.

2 Select whether you search by audio files or video files .

3 Touch the desired category.

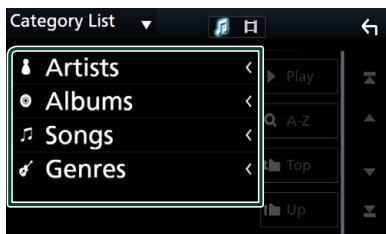

- The list corresponding to your selection appears.

4 Touch to select desired item in the list. Repeat this step until you find the desired file.

Link search

You can search a file of same artist/album/genre as the current track.

1 Touch **Link Search**.

2 Touch the desired tag type. You can select from artist, album and genre.

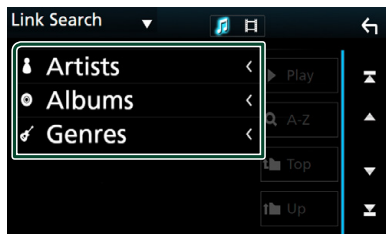

- The list corresponding to your selection appears.

3 Touch desired item from the content list.

Folder search

You can search a file according to hierarchy.

1 Touch **Folder List**.

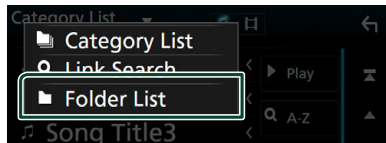

2 Touch the desired folder.

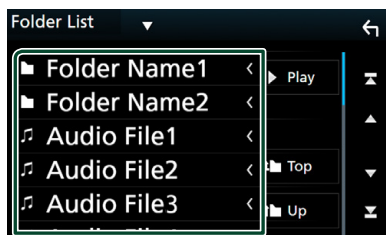

When you touch a folder its contents are displayed.

3 Touch to select desired item in the list. Repeat this step until you find the desired file.

Radio

Radio Basic Operation

Most functions can be controlled from the source control screen.

To enter Radio source, touch **Radio** icon in the source selection screen.

Control screen

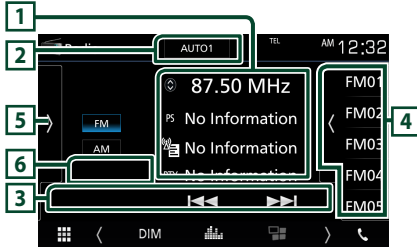

Open the drawer

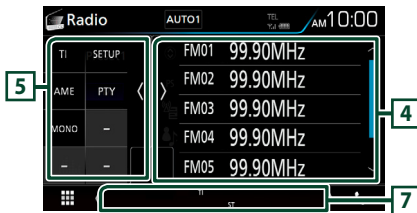

1 Information display

Displays the information of the current station:
Frequency

Touching allows you to switch between Content A and Content B.

Content A: PS name, Radio Text, PTY Genre

Content B: Radio Text plus, Title Artist

Preset#: Preset number

2 Seek mode

Switches the seek mode in the following sequence; **AUTO1**, **AUTO2**, **MANUAL**.

- **AUTO1** : Tunes in a station with good reception automatically.
- **AUTO2** : Tunes in stations in memory one after another.
- **MANUAL** : Switches to the next frequency manually.

3 Operation keys

- : Tunes in a station. The method of frequency switching can be changed (see 2 in table).
- : Touch to attenuates/restores the sound.

4 Preset list

- Touch on the right side of the screen to display the Preset list. Touch again to close the list.
- Recalls the memorized station.
- When touched for 2 seconds, stores the current receiving station in memory.

5 Function panel

Touch on the left side of the screen to display the function panel. Touch again to close the panel.

- **TI** (FM only): Sets the traffic information mode on. For details, see **Traffic Information**
- **SETUP**: Displays the TUNER SETUP screen. For details, see **Radio Setup (P)**.
- **AME** : Presets stations automatically. For details, see **Auto memory (P)**.
- **PTY** (FM only): Searches a program by setting program type. For details, see **Search by program type (P)**.
- **MONO** (FM only): Select the Monaural reception.
- **LO.S** (FM only): Turns the Local Seek function on or off.

6 FM AM

Switches the band.

7 Indicator Items

- **ST**: A stereo broadcast is being received.
- **MONO**: The forced monaural function is on.
- **AF**: The AF search function is on.
- **LOS**: The Local Seek function is on.
- **RDS**: Indicates the state of the Radio Data System station when the AF function is on.
 - White: Radio Data System is being received.
 - Orange: Radio Data System is not being received.
- **TI**: Indicates the reception state of traffic information.
 - White: TP is being received.
 - Orange: TP is not being received.

Memory Operation

Auto memory

You can store stations with good reception in memory automatically.

- 1 Touch desired band key.

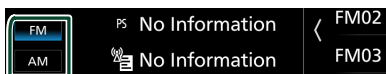

- 2 Touch **>** on the left side of the screen. Touch **AME**.

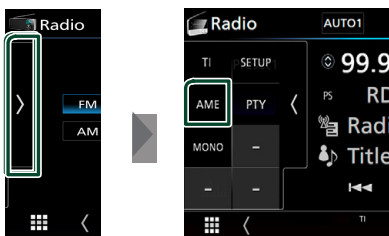

> Auto memory starts.

Manual memory

You can store the current receiving station in memory.

- 1 Select a station you wish to store in memory.
- 2 Touch **FM#** (#:1-24) or **AM#** (#:1-12) in which you want to store the station for 2 seconds until a beep sounds.

Selecting Operation

Preset select

You can list and select memorized station.

- 1 Touch **<** on the right side of the screen. Select a station from the list.

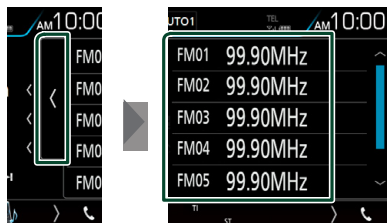

Search by program type (FM only)

You can tune to a station with a specific program type when listening to FM.

- 1 Touch **>** on the left side of the screen. Touch **PTY**.

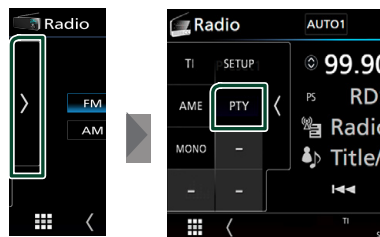

> PTY Search screen appears.

- 2 Select a program type from the list.
- 3 Touch **Search**.

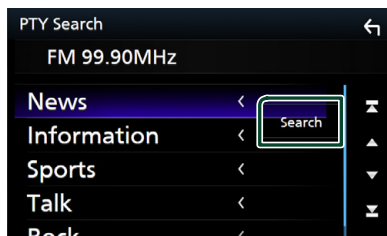

You can search a station of the selected program type.

Traffic Information (FM only)

You can listen and watch the traffic information automatically when a traffic bulletin starts. However, this feature requires a Radio Broadcast Data System that includes the TI information.

- 1 Touch **>** on the left side of the screen. Touch **TI**.

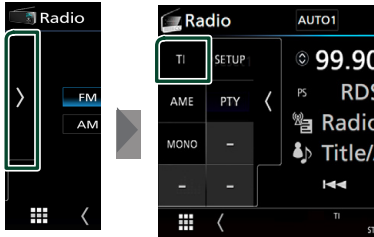

➤ Traffic information mode is set.

When the traffic bulletin starts

The Traffic Information screen appears automatically.

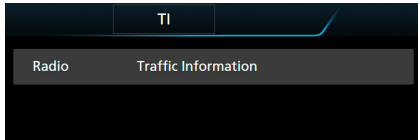

Radio Setup

You can set tuner related parameters.

- 1 Touch **>** on the left side of the screen. Touch **SETUP**.

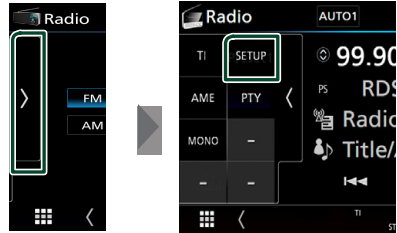

➤ Radio SETUP screen appears.

- 2 Set each item as follows.

■ AF

When station reception is poor, automatically switches to the station that is broadcasting the same program over the same Radio Data System network. Default is "ON".

■ RDS CT

Synchronizing the Radio Data System station time data and this unit's clock. "ON" (Default), "OFF"

Bluetooth Control

Using the Bluetooth function, various functions can be used: listening to the audio file, making/receiving a call.

Information for using Bluetooth® devices



Bluetooth is a short-range wireless radio communication technology for mobile devices such as mobile phones, portable PCs, and other devices.

Bluetooth devices can be connected without cables and communicate with each other.

NOTE

- While driving, do not perform complicated operations such as dialing numbers, using the phone book, etc. When you perform these operations, stop your car in a safe place.
- Some Bluetooth devices may not connect to this unit depending on the Bluetooth version of the device.
- This unit may not work for some Bluetooth devices.
- Connecting conditions may vary depending on your environment.
- For some Bluetooth devices, the device is disconnected when the unit is turned off.

About the cell-phone and Bluetooth audio player

This unit conforms to the following Bluetooth specifications:

Version

Bluetooth Ver. 4.1

Profile

Cell-phone:

HFP (Hands Free Profile)

SPP (Serial Port Profile)

PBAP (Phonebook Access Profile)

Audio player:

A2DP (Advanced Audio Distribution Profile)

AVRCP (Audio/Video Remote Control Profile)

Sound codec

SBC, AAC

NOTE

- The units supporting the Bluetooth function have been certified for conformity with the Bluetooth Standard following the procedure prescribed by Bluetooth SIG.
- However, it may be impossible for such units to communicate with your cell-phone depending on its type.

Register from the Bluetooth device

It is necessary to register the Bluetooth audio player or cell-phone to this unit before using the Bluetooth function.

You can register up to 7 Bluetooth devices.

NOTE

- Up to 7 Bluetooth devices can be registered. If an attempt is made to register the 8th Bluetooth device, the Bluetooth device connected on the earliest date will be deleted to register the 8th one.
- This unit is compatible with the Apple Easy Pairing function. When an iPod touch or iPhone is connected to this unit, an authentication dialog appears. Performing operation for authentication on this unit or iOS smartphone registers the smartphone as a Bluetooth device.

- 1 Turn on the Bluetooth function on your smartphone/cell-phone.**
- 2 Search the unit from your smartphone /cell-phone.**
- 3 Operate your smartphone/cell-phone according to the displayed messages.**
 - **Confirm the request on the smartphone/cell-phone.**



- If a PIN code is required, enter the PIN code ("0000").

When data transmission and connection have completed, the Bluetooth connection icon appears on the screen.

Bluetooth Setup

- 1 Press the **MENU** button.**
 - MENU screen appears.

- 2 Touch .**



- SETUP Menu screen appears.

- 3 Touch **Bluetooth**.**

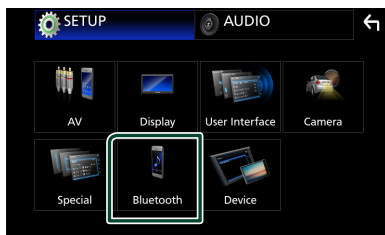

- Bluetooth SETUP screen appears.
See the following section for each setting.
- Connect the Bluetooth device

Connect the Bluetooth device

- 1 Touch **Select Device** in the Bluetooth SETUP screen.

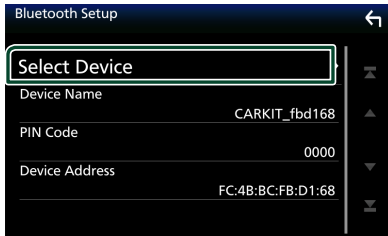

- 2 Touch the device name you want to connect.

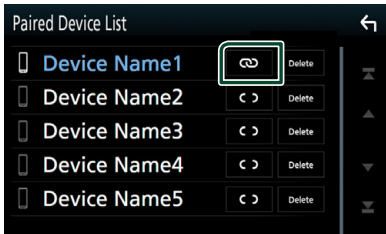

NOTE

- If the icon is lighted, it means that the unit will use that device.

To delete the registered Bluetooth device

- 1 Touch **Delete**.

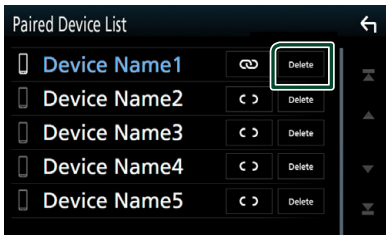

- 2 Touch **Delete**.
 - Confirmation message appears.

- 3 Touch **Yes**.

Playing Bluetooth Audio Device

Most function can be controlled from the source control screen.

To enter Bluetooth source, touch **Bluetooth** icon in the source selection screen.

Bluetooth basic operation

Control screen

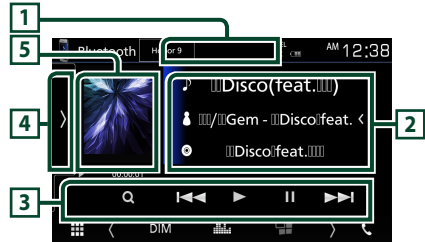

1 Device name/ [Repeat] / [Random]

- Connected device name.
- [Repeat]: Repeats the current track/folder. Each time you touch the key, repeat mode switches in the following sequence; File repeat ([Repeat]), Folder repeat ([Repeat]), All songs repeat ([Repeat ALL]), Repeat off ([Repeat]).
- [Random]: Randomly plays all tracks in current folder. Each time you touch the key, random mode switches in the following sequence; All random ([Random ALL]), Random off ([Random]).
- Operations and display indications may differ according to their availability on the connected device.

2 Information display *

Displays the name of the track information.

3 Operation keys *

- [Search]: Searches file. See **File search (P)**.
- [Previous/Next]: Searches the previous/next content. Touch and hold to fast forward or fast backward.
- [Play]: Plays.
- [Pause]: Pauses.
- [Mute]: Touch to attenuates/restores the sound.

Bluetooth Control

4 Function panel

Touch on the left side of the screen to display the function panel. Touch again to close the panel.

- **BT DEVICE CHANGE** : Selects the device to connect via Bluetooth audio (A2DP) or APP (SPP). See **Connect the Bluetooth audio**

5 Play mode indicator/ Playing time

▶, ||: Current play mode indicator

The meanings of each icon are as follows;

▶ (play), ▶▶ (fast forward), ◀◀ (fast backward), || (pause).

* These items appear only when the audio player which supports AVRCP profile is connected.

NOTE

- If the operation keys do not appear, operate from the player.
- Depending on your cell-phone or audio player, audio may be heard and controlled but text information may not appear.
- If the volume is too low, raise it on your cell-phone or audio player.

Connect the Bluetooth audio

Selects the device to connect via Bluetooth audio (A2DP).

- 1 Touch on the left side of the screen.
Touch **BT DEVICE CHANGE**.

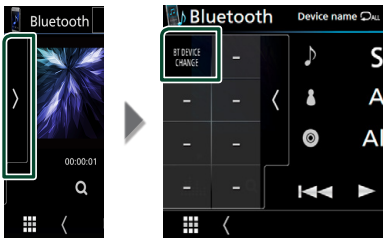

Using Hands-Free Unit

You can use telephone function by connecting the Bluetooth telephone to this unit.

NOTE

- While Apple CarPlay or Android Auto is being connected, Bluetooth Hands-Free function and two Bluetooth devices connections cannot be used. Only Apple CarPlay or Android Auto Hands-Free function can be used.

Make a call

1 Touch .







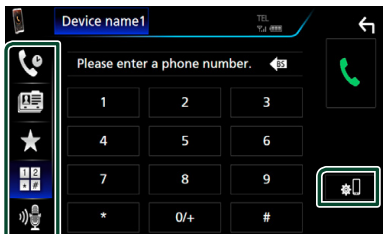

► Hands Free screen appears.

NOTE

- If your mobile phone supports PBAP, you can display the phone book and call lists on the touch panel screen when the mobile phone is connected.
 - Phone book: up to 1000 entries
 - Up to 20 entries including dialed calls, received calls, and missed calls

2 Select a dialing method.



- : Call using call records
- : Call using the phonebook
- : Call using the preset number
- : Call by entering a phone number
- : Voice Recognition

Bluetooth SETUP

1) Touch .

Bluetooth SETUP screen appears.

NOTE

- The status icons such as battery and antenna displayed may differ from those displayed on the cell-phone.
- Setting the cell-phone in the private mode can disable the hands-free function.

Call using call records

1 Touch .

2 Select the phone number from the list.



Call by entering a phone number

1 Touch .

2 Enter a phone number with number keys.

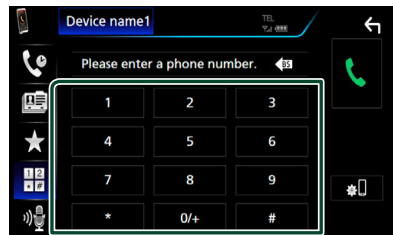

3 Touch .

Bluetooth Control

Call using the preset number

- 1 Touch .
- 2 Touch the Name or phone number.

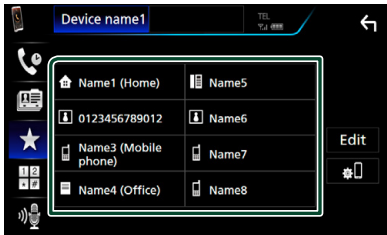

Call using the phonebook

- 1 Touch .
- 2 Select the person you want to call from the list.

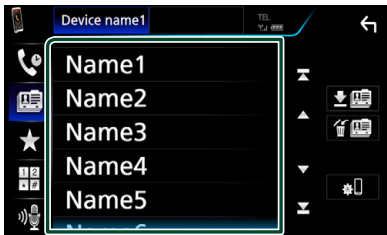

- 3 Select the phone number from the list.



NOTE

- If no Phonebook has been downloaded, touching **Download Phonebook Now** will start downloading the Phonebook.

Voice Recognition

You can access the voice recognition function of the cell-phone connected to this unit. You can search the cell-phone phonebook by voice. (The functionality depends on the cell-phone.)

- 1 Press the **VOICE** button.





> Voice Recognition screen appears.

- 2 Start speaking.

NOTE

- You can use voice recognition function by touching  on the Hands Free screen.

Receive a call

- 1 Touch  to answer a phone call or  to reject an incoming call.

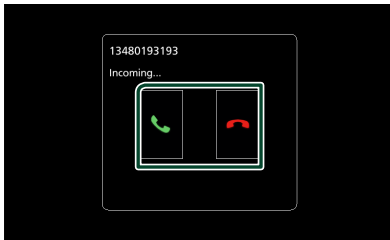

NOTE

- While monitoring the view camera, this screen does not appear even if a call comes in. To display this screen, press the **TEL** button or return the shift knob of car to the driver position.

To end call

- 1 While talking, touch .

Operations during a call



● Adjust the receiver volume





Press the ▼ or ▲ button.



● Output the dial tone

Touch **DTMF** to display the tone input screen. You can send tones by touching desired keys on the screen.

● Switching the speaking voice output

Touching   /   each time switches the speaking voice output between cell-phone and speaker.

● Call-waiting

When you receive a call while talking on another call, you can answer the newly received call by touching . The current call is on hold.

Each time you touch  , the caller will change.

When you touch  , the current call will end and switch to the call in hold.

Phone number preset

You can register frequently used phone numbers to this unit.

1 Touch .

2 Touch **Edit**.

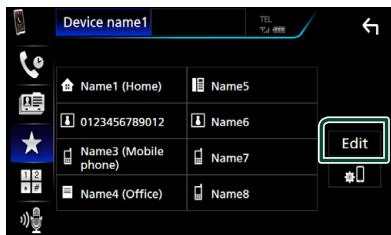

3 Select where to preset.

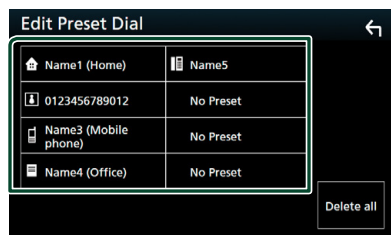

4 Select how to preset.

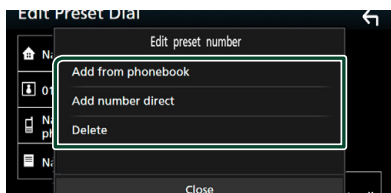

Add number from phonebook

Select the number to preset from the phonebook. See **Call using the phonebook (P.32)**.

Add number direct

Enter the telephone number directly and touch **SET**. See **Call by entering a phone number**.

Delete

To delete a preset number, touch **Delete** and then touch **OK** on the confirmation screen.

Phonebook transfer

You can transfer the phonebook in your Bluetooth smartphone via PBAP.

1 Touch .

2 Touch .

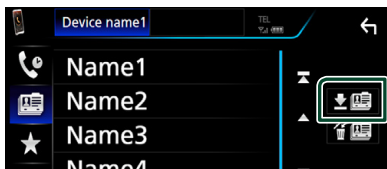

> The phonebook data transmission starts.

NOTE

- If the Phonebook contains more than 1000 entries, Phonebook data cannot be transferred.

Phonebook deletion

1 Touch .

> Confirmation message appears.

2 Touch **Yes**.