



KD-X560BT

MONITOR WITH RECEIVER

INSTRUCTION MANUAL

JVC KENWOOD Corporation

- Updated information (the latest Instruction Manual, etc.) is available from <http://www.jvc.net/cs/car/>.



Contents

Before use	2
How to read this manual	2
Precautions	2
Getting Started	3
Initial Settings	3
Clock settings	3
Basics	4
Common operations	4
How to attach/detach the faceplate	4
Select a source	4
USB	5
Preparation	5
Playback operations	5
Function settings	6
iPod/iPhone	7
Preparation	7
Playback operations	7
Function settings	7
Tuner	8
Tuner Basic Operation	8
Tuner function settings	8
External Components	9
Using external audio players	9
Rear view camera	9
Bluetooth smartphone	10
Register your smartphone to the unit	10
Receive a phone call	10
Make a phone call	11
Playing Bluetooth Audio Device	11
Function settings	12
Setup	12
Settings	12
Sound settings	13
Remote control	14
Functions of the Remote control Buttons	14
Installation	15
Before Installation	15
Installing the unit	16
About this Unit	20
Maintenance	20
More information	20
Troubleshooting	20
Copyrights	21
Specifications	22

Before use

Precautions

▲WARNING

■ To prevent injury or fire, take the following precautions:

- To prevent a short circuit, never put or leave any metallic objects (such as coins or metal tools) inside the unit.
- Do not watch or fix your eyes on the unit's display when you are driving for any extended period.
- If you experience problems during installation, consult your JVC dealer.

■ Precautions on using this unit

- When you purchase optional accessories, check with your JVC dealer to make sure that they work with your model and in your area.
- The Radio Data System or Radio Broadcast Data System feature won't work where the service is not supported by any broadcasting station.

■ Protecting the monitor

- To protect the monitor from damage, do not operate the monitor using a ballpoint pen or similar tool with the sharp tip.

■ How to reset your unit

If the unit or the connected unit fails to operate properly, reset the unit.

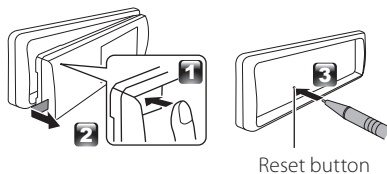

How to read this manual

- The panels shown in this guide are examples used to provide clear explanations of the operations. For this reason, they may be different from the actual panels.
- In operation procedures, bracket shape indicates the item you should control.
[]: indicates the selected items or menu.
< >: indicates the name of panel buttons.

Getting Started

Initial Settings

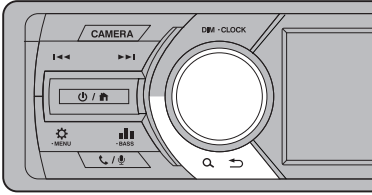

- 1 Turn the ignition key of your car to ACC.
The unit is turned on.
- 2 Turn the volume knob to select the item to set (see the table below), then press the knob to make a selection.

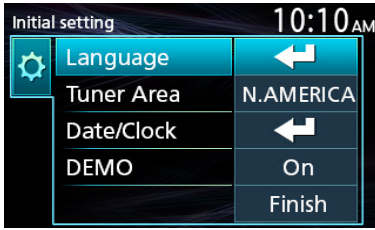

Language

Select the language used for the control screen and setting items. Default is "English".

Tuner Area

N.AMERICA (Default): For North America, AM/FM intervals: 10 kHz/200 kHz

S.AMERICA: For Central/South America, AM/FM intervals: 10 kHz/200 kHz

EUROPE: For Europe, AM/FM intervals: 9 kHz/50 kHz.

Date/Clock

Adjust the date, then adjust the time.

Hour / Minute / Month / Day / Year

DEMO

Set the demonstration mode. Default is "ON".

- 3 Press <Q ➤> to exit.

Clock settings

- 1 Press an hold <⚙> to display the general setting.
- 2 Press <◀◀◀/▶▶▶> to select [⚙].
- 3 Turn the volume knob to select [Time Format], then press the knob to select the time format ([12h] or [24h]).

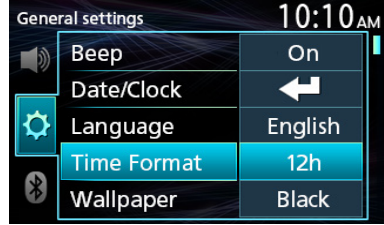

- 4 Turn the volume knob to select [Date/Clock], then press the knob.
Clock screen appears.



- 5 Turn the volume knob to adjust the hour, then press the knob.
- 6 Turn the volume knob to adjust the minute, then press the knob.
- 7 Turn the volume knob to adjust the month, then press the knob.
- 8 Turn the volume knob to adjust the day, then press the knob.
- 9 Turn the volume knob to adjust the year, then press the knob.
- 10 Press <Q ➤>.

Basics

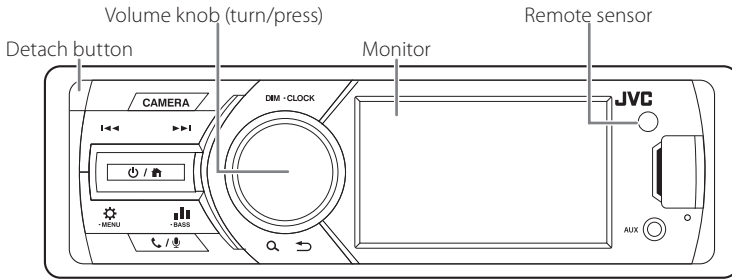

Common operations

Turning on the power

- 1 Press <power / home>.

Turning off the power

- 1 Press and hold <power / home>.

Adjusting the volume

- 1 Turn the volume knob.

Mutes the sound

- 1 Press and hold the volume knob.
 - appears when the mute function is active.
 - To restore the sound, press and hold again, or adjust the volume.

Display the clock

- 1 Press and hold the <DIM> button.

Select dimmer mode

- 1 Press the <DIM> button.
Dim 1, Dim 2, Not dim

How to attach/detach the faceplate

Detach

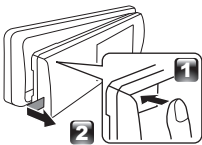

Attach

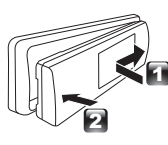

Select a source

- 1 Press <power / home> to display the HOME screen. HOME screen appears.
- 2 Turn the volume knob to select the source, then press the knob.



- 1 Clock display
- 2 Switches to the FM tuner broadcast. (P.8)
- 3 Switches to the AM tuner broadcast. (P.8)
- 4 Plays a Bluetooth audio player. (P.11)
- 5 **[USB]** Plays files on a USB device. (P.5)
- 6 **[iPod]** Plays an iPod/iPhone. (P.7)
 - When iPod/iPhone is connected.
- 6 Switches to an external component connected to the AV-IN input terminal. (P.9)

NOTE

- If no operation is done for about 10 seconds, the operation will be canceled.

USB

Preparation

■ Connecting a USB device

- 1 Open the front port cover.
- 2 Connect the USB device with the USB cable.

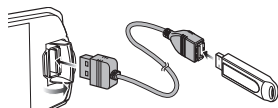

The unit reads the device and playback starts.

- USB maximum power supply current :
DC 5 V = 1 A

■ To disconnect the USB device:

- 1 Press **<⏻ / 🏠>** to display the HOME screen.
- 2 Turn the volume knob to select other than [USB], then press the knob.
- 3 Detach the USB device.

■ Usable USB device

This unit can play MPEG1/ MPEG2/ MPEG4/ MP3/ WMA/ AAC/ JPEG/ BMP files stored in a USB mass storage class device. **(P.20)**

- File system: FAT16/ FAT32
- This unit can recognize a total of 9 999 files and 320 folders (a maximum of 9 999 files per folder).
- The maximum number of characters:
 - Folder names : 24 characters
 - File names : 24 characters
 - Tag : 30 characters

📎 NOTE

- When the USB device is connected to this unit, it can be charged through the USB cable.
- Install the USB device in the place where it will not affect safe driving.
- You cannot connect a USB device via a USB hub and Multi Card Reader.
- Take backups of the audio files used with this unit. The files may be erased depending on the operating conditions of the USB device. We shall have no compensation for any damage arising from any erased data.
- No USB device comes with this unit. You need to purchase a commercially available USB device.
- Cap the USB terminal whenever not using.

Playback operations

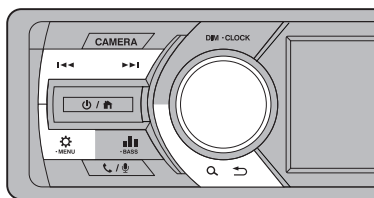

Audio files/Video files

To	Do this
Play/pause	Press the volume knob.
Select a file	Press <⏪>/<⏩> repeatedly.
Fast-backward/ Fast-forward	Press and hold <⏪>/<⏩> . <ul style="list-style-type: none">• Video files: Each time you press the button, the search speed changes.

Picture files

To	Do this
Rotates the image	Turn the volume knob.
Zoom	Press the volume knob. x2, x3, x4, x1/2, x1/3, x1/4, x1 <ul style="list-style-type: none">• Turn the volume knob to move the position up and down.• Press <⏪>/<⏩> to move the position left and right.

■ Source screen (Audio files)



- 1 Playback status/Playing time/Total playing time
Play time bar : For confirmation of current playing position
↺ : Repeat playback mode indicator
⌘ : Random playback mode indicator
- 2 Displays the information of the current file. Only a file name is displayed if there is no tag information.

USB

■ Selecting a track in a list (Searches file)

- 1 Press <Q> <↵> to display the LIST screen.
- 2 Press <◀◀>/<▶▶> to select whether you search by audio files [🎵], video files [📺] or picture files [🖼️].



3 Turn the volume knob to select the desired folder, then press the knob.

- When you select a folder its contents are displayed.
- To return to the previous layer, press <Q> <↵>.

4 Turn the volume knob to select the desired item, then press the knob.

Playback starts.

Function settings

- 1 Press <⚙️> to display the function menu.
- 2 Turn the volume knob to select the item to set (see the table below), then press the knob to make a selection.
- 3 Press <Q> <↵> to exit.

📎 NOTE

- If no operation is done for about 10 seconds, the operation will be canceled.

Audio files (MP3/WMA/AAC)

Repeat	All: Repeats all files. (🔁 indicator lights up.)
	One: Repeats current file. (🔁 indicator lights up.)
	Folder: Repeats all files in the current folder. (🔁 indicator lights up.)
Random	OFF: Normal playback.
	ON: Randomly plays all files. (🔁 indicator lights up.)

Video files (MPEG1/ MPEG2/ MPEG4)

Screen Ratio	Auto/Full/16:9/4:3 : Selects the aspect ratio.
Repeat	All: Repeats all files. One: Repeats current file.
Video Settings	Brightness/Contrast/Color/Tint (0 to 8 : Default 4) : You can adjust image quality. Reset: To clear the adjustment.

Picture files (JPEG/ BMP)

Sideshow	Auto/Full/16:9/4:3 : Selects the aspect ratio.
Video Settings	Brightness/Contrast/Color/Tint (0 to 8 : Default 4) : You can adjust image quality. Reset: To clear the adjustment.

📎 NOTE

- If no operation is done for about 10 seconds, the operation will be canceled.

iPod/iPhone

Preparation

Connecting iPod/iPhone

- 1 Open the front port cover.
- 2 Connect the iPod/iPhone using the KS-U62 (optional accessory).

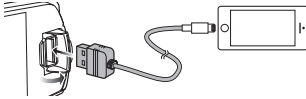

The unit reads the device and playback starts.

- USB maximum power supply current : DC 5 V = 1 A

To disconnect the iPod/iPhone

- 1 Press **<⏻ / ⏮>** to display the HOME screen.
- 2 Turn the volume knob to select other than [iPod], then press the knob.
- 3 Detach the iPod/iPhone.

Connectable iPod/iPhone

The following models can be connected to this unit.

Made for

- iPhone X
- iPhone SE
- iPhone 5s
- iPhone 8 Plus
- iPhone 6s Plus
- iPhone 6 Plus
- iPhone 8
- iPhone 6s
- iPhone 6
- iPhone 7 Plus
- iPod touch (6th generation)
- iPhone 7

NOTE

- If you start playback after connecting the iPod, the music that has been played by the iPod is played first.
- Cap the USB terminal whenever not using.

Playback operations

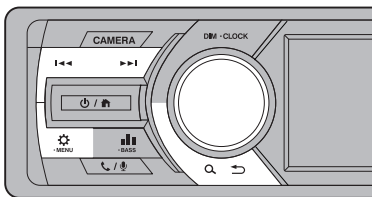

To	Do this
Play/pause	Press the volume knob.
Select a file	Press < ◀◀>> > repeatedly.
Fast-backward/ Fast-forward	Press and hold < ◀◀>> > .

Source screen

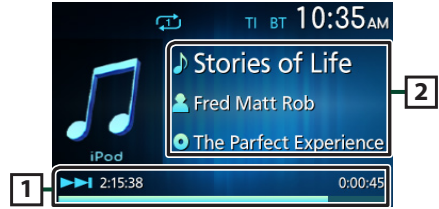

- 1 Playback status/Playing time/Total playing time
Play time bar : For confirmation of current playing position
 : Repeat playback mode indicator
 : Random playback mode indicator
- 2 Displays the information of the current file.

Selecting a content in a list

- 1 Press **<Q ⏪>** to display the LIST screen.
- 2 Turn the volume knob to select category, then press the knob.
 - To return to the previous layer, press **<Q ⏪>**.
- 3 Turn the volume knob to select the desired item, then press the knob.

Function settings

- 1 Press **<⚙>** to display the function menu.
- 2 Turn the volume knob to select the item to set (see the table below), then press the knob to make a selection.
- 3 Press **<Q ⏪>**.

NOTE

- If no operation is done for about 10 seconds, the operation will be canceled.

Repeat	All: Repeats all files. indicator lights up.) One: Repeats current file. indicator lights up.)
Random	OFF: Normal playback. Songs: Functions the same as "Shuffle Songs". (indicator lights up.)
Audiobook	Normal/Slow/Fast: Selects the speed of audiobooks.

Tuner

Tuner Basic Operation

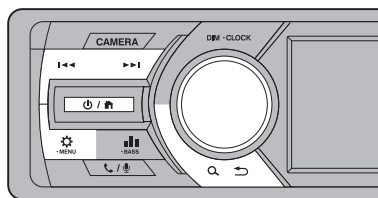

- 1 Press **<⏻ / 🏠>** to display the HOME screen.
- 2 Turn the volume knob to select **[FM]** or **[AM]**, then press the knob.
- 3 Press **<⏪>/<⏩>** to search for a station automatically.
"Auto Seek" appears.
(or)
Press and hold **<⏪>/<⏩>** repeatedly to search for a station manually.
"Manual Seek" appears.

NOTE

- The **ST** indicator lights up when receiving an FM stereo broadcast with sufficient signal strength.
- To store stations, perform [Manual Store] or [Auto Store].

Source screen



- 1 LOCAL indicator
- 2 ST (Stereo) indicator
- 3 Displays the information of the current station: PS name, Frequency, PTY Genre, Indicator Items

Select a stored station

You can preset 15 stations for FM and 15 stations for AM.

- 1 Press **<🔍 ↶>** to display the LIST screen.
- 2 Turn the volume knob to select a preset number, then press the knob.

NOTE

- If no operation is done for about 10 seconds, the operation will be canceled.
- To exit, press **<🔍 ↶>**.

Tuner function settings

- 1 Press **<⚙️>** to display the function menu.
- 2 Turn the volume knob to select the item to set (see the table below), then press the knob to make a selection.
- 3 Press **<🔍 ↶>**.

NOTE

- If no operation is done for about 10 seconds, the operation will be canceled.

Manual Store	Stores a station manually. While listening to a station you want to store, turn the volume knob to select a preset number, then press the knob. • The preset number, band, and "Stored OK!" appear.
Auto Store	Automatically searches and stores the 6 stations with the strongest signals for the selected band. • "Auto Store" appears.
Local Seek	Tunes in only to the stations with sufficient signal strength. (LOCAL indicator lights up.) "ON", "OFF" (Default)
Area	N.AMERICA (Default): For North America, AM/FM intervals: 10 kHz/200 kHz S.AMERICA: For Central/South America, AM/FM intervals: 10 kHz/200 kHz EUROPE: For Europe, AM/FM intervals: 9 kHz/50 kHz.
Mono*1	Determines whether to receive stereo broadcasts in the stereo mode or monaural mode (the MONO indicator lights up). "ON" (Default), "OFF"

*1 FM only

External Components

Using external audio players

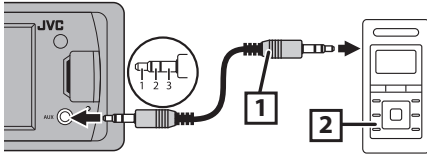

- 1 3.5 mm stereo mini plug (Sold separately)
Use a 3-core plug head stereo mini plug for optimum audio output.
- 2 Portable audio player (Sold separately)

Starting playback

- 1 Connect an external component to the AUX input terminal.
- 2 Press **<⏪ / 🏠>** to display the HOME screen.
- 3 Turn the volume knob to select [AUX], then press the knob.
- 4 Turn on the connected component and start playing the source.

Rear view camera

To use a rear view camera, the REVERSE lead connection is required. For connecting a rear view camera. (P.18)

Displaying the picture from the rear view camera

The rear view screen is displayed when you shift the gear to the reverse (R) position.



- To erase the caution message, touch the screen.

To display the picture from the rear view camera manually

- 1 Press **<CAMERA>**.

Bluetooth smartphone

About the Bluetooth smartphone and Bluetooth audio player

This unit conforms to the following Bluetooth specifications:

Version

Bluetooth Ver.4.2

Profile

Smartphone/ Cell-phone:

HFP (Hands Free Profile)

PBAP (Phonebook Access Profile)

Audio player:

A2DP (Advanced Audio Distribution Profile)

AVRCP (Audio/Video Remote Control Profile)

Sound codec

SBC

About mobile phones compatible with Phone book Access Profile (PBAP)

If your mobile phone supports PBAP, you can display the following items on the touch panel screen when the mobile phone is connected.

- Phone book (up to 1000 entries)
- Dialed calls, received calls, and missed calls (up to 20 entries in total)

Register your smartphone to the unit

You can use your Bluetooth smartphone when paired to this unit.

- You can pair the device and the unit using SSP (Secure Simple Pairing) which only requires confirmation.
- One device can be connected at a time.
- When you register a new Bluetooth device, disconnect the Bluetooth device currently connected and then register the new device.

1 Turn on the Bluetooth function on your smartphone/cell-phone.

2 Search the unit ("KD-X56*") from your smartphone/cell-phone.

If a PIN code is required, enter the PIN code ("0000").

Disconnecting the device

- Turn off the Bluetooth function from your smartphone/cell-phone.
- Turn off the ignition switch.

Receive a phone call

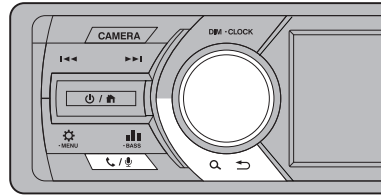

To	Do this
Answer a call	Press .
Operations during a call	
To	Do this
End a call	Press .
Adjust the phone volume	Turn the volume knob.
Switching between hands-free mode and phone mode	Press . Each time you press the button, "Transfer!" appears and talking method is switched between hands-free mode and phone mode.

Bluetooth smartphone

Make a phone call

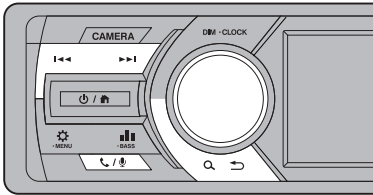

1 Press <📞 / 📞> to enter Bluetooth mode.



2 Press <⏪ / ⏩> to select a method to make a call (📞: from the calls history/[📞]: from the phone book).

3 Turn the volume knob to select the target, then press the knob to make a call.

NOTE

- Calls history icon: 📞 (Incoming Calls), 📞 (Outgoing Calls), 📞 (Missed Calls).

Call by voice

1 Press and hold <📞 / 📞> to display the voice dialing screen.

You can also display the voice dialing screen by selecting [📞] as the method to make a call on the phone screen.

2 Press the volume knob to activate voice recognition function.

“Please speak after the beep” appears and the beep sounds.

3 Say the name of the person you want to call.

Playing Bluetooth Audio Device

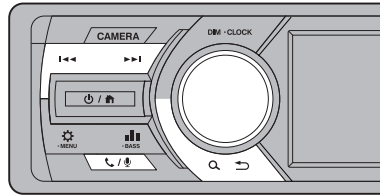

1 Press <🏠 / 🏠> to display the HOME screen.

2 Turn the volume knob to select [BT Audio], then press the knob.

To	Do this
Play/pause	Press the volume knob.
Select a file	Press <⏪>/<⏩> repeatedly.
Fast-backward/ Fast-forward	Press and hold <⏪>/<⏩>.

Source screen



- 1 Playback status/Playing time/Total playing time
Play time bar : For confirmation of current playing position
🔄 : Repeat playback mode indicator
🎲 : Random playback mode indicator
- 3 Displays the information of the current file.

NOTE

- Operations and display indications may differ according to their availability on the connected device.

Selecting a content in a list

1 Press <🔍 / 🔍> to display the LIST screen.

2 Turn the volume knob to select an item, then press the knob.

- To return to the previous layer, press <🔍 / 🔍>.

Setup

Function settings

- 1 Press **<⚙>** to display the function menu.
- 2 Turn the volume knob to select the item to set (see the table below), then press the knob to make a selection.
- 3 Press **<Q ⏪>** to exit.

NOTE

- If no operation is done for about 10 seconds, the operation will be canceled.

Repeat	All: Repeats all files. (🔁 indicator lights up.) One: Repeats current file. (🔁 indicator lights up.)
Random	OFF: Normal playback. ON: Randomly plays all files. (🔀 indicator lights up.)

Setup

Settings

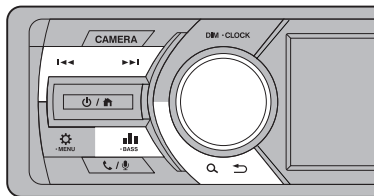

- 1 Press a hold **<⚙>** to display the general setting.

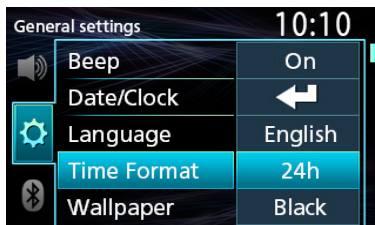

- 2 Press **<◀◀◀/▶▶▶>** to select the category.
- 3 Turn the volume knob to select an item (see the following table), then press the knob.
- 4 Repeat step 3 until the desired item is selected/activated or follow the instructions stated on the selected item.
- 5 Press **<Q ⏪>**.

Audio Settings

Fader	R12 — F12 (00): Adjusts the front and rear speaker output balance.
Balance	L12 — R12 (00): Adjusts the left and right speaker output balance.

General Settings

Beep	ON/OFF: Activates or deactivates the keypress tone.
Date/Clock	Adjusts the date and clock. (P.3)
Language	Selects the text language used for on-screen information.
Time Format	12h/24h: Selects time format.
Wallpaper	BLACK/BLUE: Selects the wallpaper image.
Demo	Set the demonstration mode. Default is "ON".
Initialize	Select [Initialize] and then select [Yes] to set all the settings to the initial default settings.

Setup

Bluetooth Settings

Sync	ON/OFF: Activates or deactivates the synchronization of the phonebook in the connected mobile phone with the unit.
Phonebook	Displays the information about the connected Bluetooth device (device name, phone name, Bluetooth version, and mac address).

Sound settings

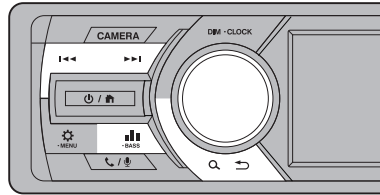













1 Press  to display the sound setting.



2 Turn the volume knob to select an item (see the following table), then press the knob.

3 Repeat step 2 until the desired item is selected/activated or follow the instructions stated on the selected item.

4 Press  .

Graphic Equalizer	Selects a preset equalizer suitable to the music genre. CLASSIC / Flat / DRVN2 / HARD / hiphop / Jazz / pop/ R&B / User Select [User] to use the settings made 1) Press the volume knob to select the frequency. 2) Turn the volume knob to adjust the level. 3) Press   .
Loudness	Sets the amounts of boost of low and high tones. "ON", "OFF" (Default)
X'over	1) Press   to select the speaker. 2) Press the volume knob to select the item. 3) Turn the volume knob to adjust the value. 4) Press   .
Delay	1) Press   to select the speaker. 2) Turn the volume knob to adjust the value. 3) Press   .

Remote control

This unit can be operated using the remote control. The remote control RM-RK258 (optional accessory) can be used.

⚠ WARNING

- Do not ingest the battery, Chemical Burn Hazard. The remote control supplied with this product contains a coin / button cell battery. If the coin/ button cell battery is swallowed, it can cause severe internal burns in just 2 hours and can lead to death. Keep new and used batteries away from children. If the battery compartment does not close securely, stop using the product and keep it away from children.

If you think batteries might have been swallowed or placed inside any part of the body, seek immediate medical attention.

⚠ CAUTION

- Put the remote control in a place where it will not move during braking or other operations. A dangerous situation could result, if the remote control falls down and gets wedged under the pedals while driving.
- Do not leave the battery near fire or under direct sunlight. A fire, explosion or excessive heat generation may result.
- Do not recharge, short, break up or heat the battery or place it in an open fire. Such actions may cause the battery to leak fluid. If spilled fluid comes in contact with your eyes or on clothing, immediately rinse with water and consult a physician.

📄 Removing the battery sheet

Pull the battery sheet out from the remote controller to activate the battery.

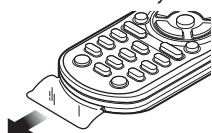

📄 Changing the battery of the remote controller



- Use a commercially available button battery (CR2025).
- Insert the battery with the + and – poles aligned properly.
 - If the effectiveness of the remote controller decreases, replace the battery.

Functions of the Remote control Buttons

- Aim the remote control directly at the remote sensor on the faceplate.
- DO NOT expose the remote sensor to bright light (direct sunlight or artificial lighting).

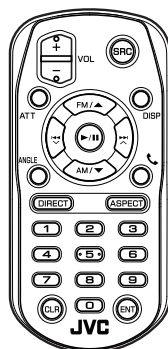

SRC	Switches to the source to be played.
VOL + -	Adjusts the volume.
ATT	Mutes/restores the sound
DISP	Not used.
FM/▲	Selects the folder to be played.
AM/▼	During tuner source, select FM/ AM band to be received.
⏪ ▼	Selects the track or file to be played.
▶ ⏩ ▲	During tuner source, switches to broadcast stations received by the unit.
ANGLE	Not used.
☎	When a call comes in, answers the call.
DIRECT	Not used.
ASPECT	Not used.
Numeric Keypad	Not used.
CLR	Not used.
ENT	Not used.

Installation

Before Installation

Before installation of this unit, please note the following precautions.

▲WARNINGS

- If you connect the ignition wire (red) and the battery wire (yellow) to the car chassis (ground), you may cause a short circuit, that in turn may start a fire. Always connect those wires to the power source running through the fuse box.
- Do not cut out the fuse from the ignition wire (red) and the battery wire (yellow). The power supply must be connected to the wires via the fuse.

▲CAUTION

- Install this unit in the console of your vehicle.
- Do not touch the metal part of this unit during and shortly after the use of the unit. Metal part such as the heat sink and enclosure become hot.

🔧 NOTE







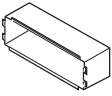

- Mounting and wiring this product requires skills and experience. For best safety, leave the mounting and wiring work to professionals.
- Make sure to ground the unit to a negative 12V DC power supply.
- Do not install the unit in a spot exposed to direct sunlight or excessive heat or humidity. Also avoid places with too much dust or the possibility of water splashing.
- Do not use your own screws. Use only the screws provided. If you use the wrong screws, you could damage the unit.
- If the power is not turned ON ("There is an error in the speaker wiring. Please check the connections." is displayed), the speaker wire may have a short-circuit or touched the chassis of the vehicle and the protection function may have been activated. Therefore, the speaker wire should be checked.
- If your car's ignition does not have an ACC position, connect the ignition wires to a power source that can be turned on and off with the ignition key. If you connect the ignition wire to a power source with a constant voltage supply, such as with battery wires, the battery may be drained.
- If the console has a lid, make sure to install the unit so that the front panel will not hit the lid when closing and opening.
- If the fuse blows, first make sure the wires aren't touching to cause a short circuit, then replace the old fuse with one with the same rating.
- Insulate unconnected wires with vinyl tape or other similar material. To prevent a short circuit, do not remove the caps on the ends of the unconnected wires or the terminals.

- Secure the wires with cable clamps and wrap vinyl tape around the wires that comes into contact with metal parts to protect the wires and to prevent short circuit.
- Connect the speaker wires correctly to the terminals to which they correspond. The unit may be damaged or fail to work if you share the ⊖ wires or ground them to any metal part in the car.
- When only two speakers are being connected to the system, connect the connectors either to both the front output terminals or to both the rear output terminals (do not mix front and rear). For example, if you connect the ⊕ connector of the left speaker to a front output terminal, do not connect the ⊖ connector to a rear output terminal.
- After the unit is installed, check whether the brake lamps, blinkers, wipers, etc. on the car are working properly.
- Mount the unit so that the mounting angle is 30° or less.
- Do not press hard on the panel surface when installing the unit to the vehicle. Otherwise scars, damage, or failure may result.
- Reception may drop if there are metal objects near the Bluetooth antenna.



Bluetooth antenna unit

■ Supplied accessories for installation

①		x1	②		x1
③		x2	④		x1
⑤	 (3 m)	x1	⑥		x1
⑦		x1	⑧	 (M5 × 6 mm)	x4
⑨	 (M5 × 7 mm)	x4			

Installation

Installation procedure

- 1) To prevent a short circuit, remove the key from the ignition and disconnect the ⊖ terminal of the battery.
- 2) Make the proper input and output wire connections for each unit.
- 3) Connect the wire on the wiring harness.
- 4) Take Connector B on the wiring harness and connect it to the speaker connector in your vehicle.
- 5) Take Connector A on the wiring harness and connect it to the external power connector on your vehicle.
- 6) Connect the wiring harness connector to the unit.
- 7) Install the unit in your car.
- 8) Reconnect the ⊖ terminal of the battery.
- 9) Press the reset button.

Installing the unit

Non-Japanese cars

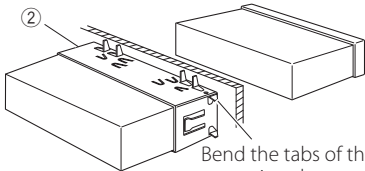

Bend the tabs of the mounting sleeve with a screwdriver or similar utensil and attach it in place.

NOTE

- Make sure that the unit is installed securely in place. If the unit is unstable, it may malfunction (eg, the sound may skip).

Japanese cars (North America, South America sales area only)

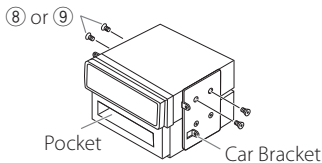

Trim plate

- 1) Attach accessory ① to the unit.

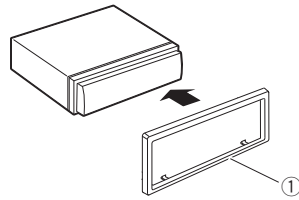

Microphone unit

- 1) Check the installation position of the microphone (accessory ⑤).
- 2) Clean the installation surface.
- 3) Remove the separator of the microphone (accessory ⑤), and stick the microphone to the place shown below.
- 4) Wire the microphone cable up to the unit with it secured at several positions using tape or other desired method.
- 5) Adjust the direction of the microphone (accessory ⑤) to the driver.

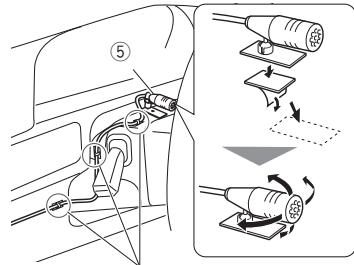

Fix a cable with a commercial item of tape.

NOTE

- Use the clips if necessary.

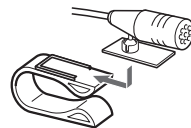

Installation

■ Removing the trim plate

- 1) Use the extraction key (accessory ④) to lever out the four tabs (two on the left part, two on the right part).

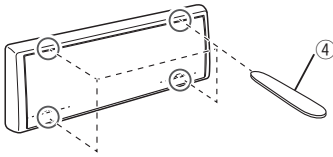

- 2) Pull the trim plate forward.

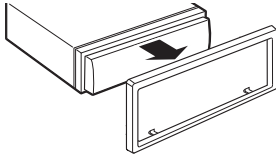

■ Removing the unit

- 1) Remove the trim plate by referring to step 1 in "Removing the trim plate".
- 2) Insert the two extraction key (accessory ③) deeply into the slots on each side, as shown.

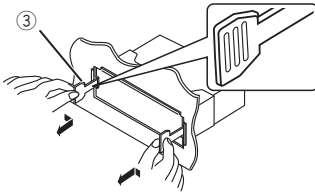

- 3) Pull out the unit halfway.

🔗 NOTE

- Be careful to avoid injury from the catch pins on the extraction key.
- 4) Pull the unit all the way out with your hands, being careful not to drop it.

Installation

■ Connecting wires to terminals

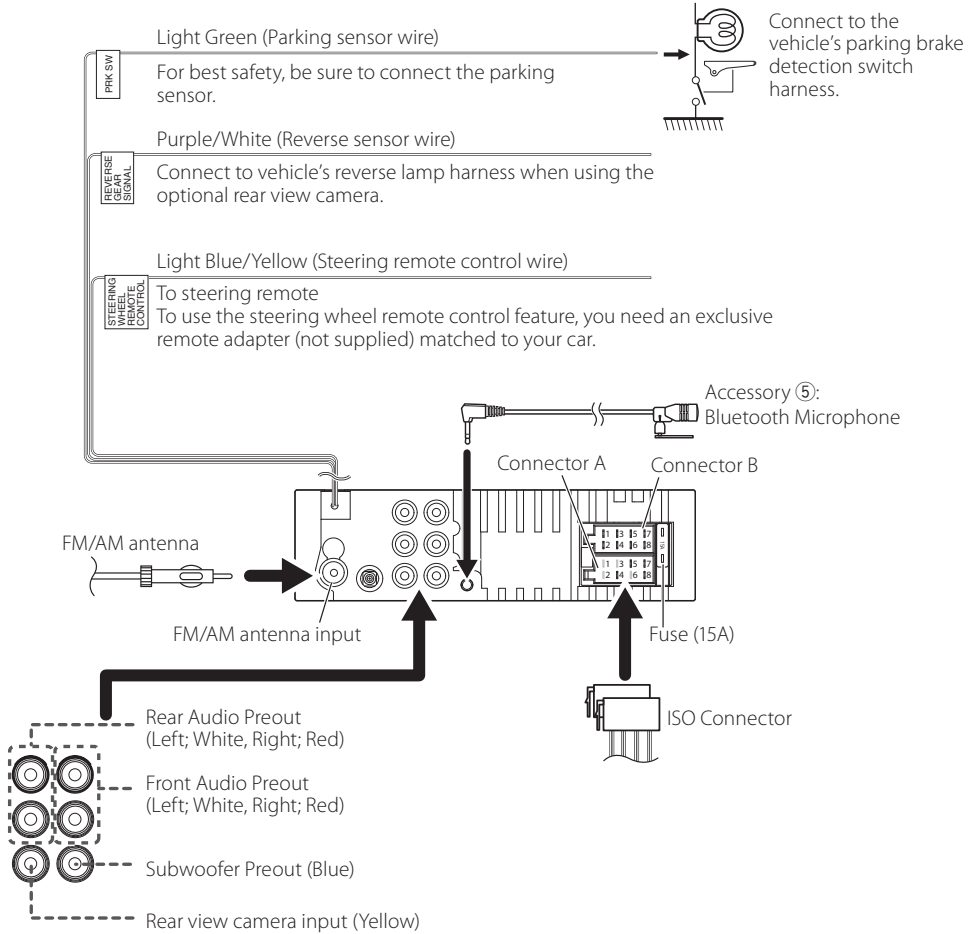

Installation

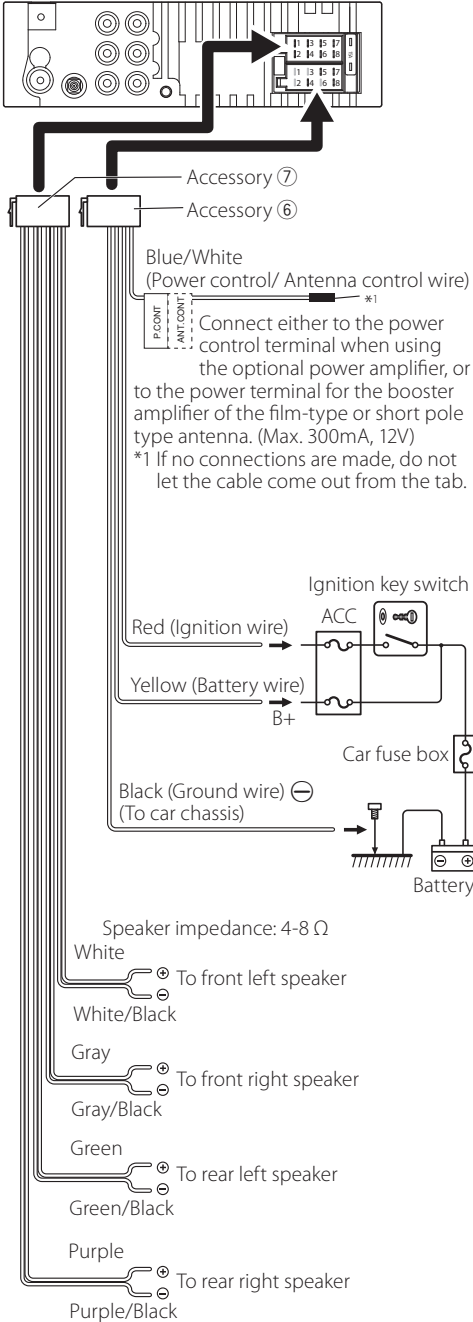

About this Unit

Maintenance

Cleaning the Unit

If the front panel of this unit is stained, wipe it with a dry soft cloth such as a silicon cloth. If the front panel is stained badly, wipe the stain off with a cloth moistened with neutral cleaner, then wipe it again with a clean soft dry cloth.

CAUTION

- Applying spray cleaner directly to the unit may affect its mechanical parts. Wiping the front panel with a hard cloth or using a volatile liquid such as thinner or alcohol may scratch the surface or erase screened print.

Cleaning the connector

Detach the faceplate and clean the connector gently with a cotton swab. Be careful not to damage the connector.



Connector (on the reverse side of the faceplate)

More information

Playable Audio files

Audio format	Bit rate	Sampling frequency
MP3 (.mp3)	16 – 320kbps, VBR	16 – 48 kHz
WMA (.wma)	16 – 320kbps	16 – 48 kHz
AAC-LC (.m4a)	16 – 320kbps	16 – 48 kHz

- This unit can show ID3 Tag Version 1.0/1.1/2.2/2.3/2.4 (for MP3).
- The maximum number of characters:
 - Tag : 30 characters

NOTE

- WMA and AAC of which is covered with DRM cannot be played.
- Although the audio files are complied with the standards listed above, the play may be impossible depending on the types or conditions of media or device.

Acceptable Video files

Video format	Video codec	Audio codec
MPEG-1 (.mpg, .mpeg)	MPEG-1	MPEG Audio Layer 2
MPEG-2 (.mpg, .mpeg)	MPEG-2	MPEG Audio Layer 2
MPEG-4 (.mp4, .avi)	MPEG-4	MP3, AAC-LC (2ch)

Acceptable Picture files

- JPEG (.jpg)
 - 32 x 32 to 8,192 x 7,680 resolution
 - It may take time to display the file.
 - Progressive JPEG files or lossless JPEG files cannot be played.
- BMP (.bmp)
 - 32 x 32 to 8,192 x 7,680 resolution
 - It may take time to display the file.

Troubleshooting

What appears to be trouble is not always serious. Check the following points before calling a service center.

- For operations with the external components, refer also to the instructions supplied with the adapters used for the connections (as well as the instructions supplied with the external components).

General

No sound comes out of the speakers.

- Adjust the volume to the optimum level.
- Check the cords and connections.

The unit does not work at all.

- Reset the unit. (P.2)

The remote controller does not work.

- Replace the battery.

USB

While playing a track, sound is sometimes interrupted.

- The tracks are not properly copied into the USB device. Copy the tracks again, and try again.

About this Unit

iPod/iPhone

No sound comes out of the speakers.

- Disconnect the iPod/iPhone, then connect it again.
- Select another source, then reselect “iPod”.

The iPod/iPhone does not turn on or does not work.

- Check the connecting cable and its connection.
- Update the firmware version of iPod/iPhone.
- Charge the battery of iPod/iPhone.
- Reset the iPod/iPhone.

Sound is distorted.

- Deactivate the equalizer either on this unit or the iPod/iPhone.

A lot of noise is generated.

- Turn off (uncheck) “VoiceOver” on the iPod/iPhone. For details, visit <<http://www.apple.com>>.

Tuner

Automatic presetting does not work.

- Store stations manually. **(P.8)**

Static noise while listening to the radio.

- Connect the antenna firmly.

Bluetooth

Phone sound quality is poor.

- Reduce the distance between the unit and the Bluetooth mobile phone.
- Move the car to a place where you can get a better signal reception.

The sound is interrupted or skipped while using a Bluetooth audio player.

- Reduce the distance between the unit and the Bluetooth audio player.
- Turn off, then turn on the unit. (When the sound is not yet restored) connect the player again.

The connected audio player cannot be controlled.

- Check whether the connected audio player supports AVRCP (Audio/Video Remote Control Profile).

The Bluetooth device does not detect the unit.

- Search from the Bluetooth device again.

The unit does not pair with the Bluetooth device.

- Turn off, then turn on the Bluetooth device.
- Disconnect the Bluetooth device currently connected and then register the new device. **(P.10)**

Copyrights

- The Bluetooth word mark and logos are registered trademarks owned by the Bluetooth SIG, Inc. and any use of such marks by JVC KENWOOD Corporation is under license. Other trademarks and trade names are those of their respective owners.
- “Use of the Made for Apple badge means that an accessory has been designed to connect specifically to the Apple product(s) identified in the badge, and has been certified by the developer to meet Apple performance standards. Apple is not responsible for the operation of this device or its compliance with safety and regulatory standards. Please note that the use of this accessory with an Apple product may affect wireless performance.
- Apple, iPhone, iPod, iPod touch, and Lightning are trademarks of Apple Inc., registered in the U.S. and other countries.
- Microsoft and Windows Media are either registered trademarks or trademarks of Microsoft Corporation in the United States and/or other countries.
- THIS PRODUCT IS LICENSED UNDER THE MPEG-4 VISUAL PATENT PORTFOLIO LICENSE FOR THE PERSONAL AND NON-COMMERCIAL USE OF A CONSUMER FOR (i) ENCODING VIDEO IN COMPLIANCE WITH THE MPEG-4 VISUAL STANDARD (“MPEG-4 VIDEO”) AND/OR (ii) DECODING MPEG-4 VIDEO THAT WAS ENCODED BY A CONSUMER ENGAGED IN A PERSONAL AND NON-COMMERCIAL ACTIVITY AND/OR WAS OBTAINED FROM A VIDEO PROVIDER LICENSED BY MPEG LA TO PROVIDE MPEG-4 VIDEO. NO LICENSE IS GRANTED OR SHALL BE IMPLIED FOR ANY OTHER USE. ADDITIONAL INFORMATION INCLUDING THAT RELATING TO PROMOTIONAL, INTERNAL AND COMMERCIAL USES AND LICENSING MAY BE OBTAINED FROM MPEG LA, LLC. SEE [HTTP://WWW.MPEGLA.COM](http://www.mpegla.com).

About this Unit

Specifications

■ Monitor section

Picture Size

: 3.0 inches (diagonal) wide

Drive System

: TFT active matrix system

Number of Pixels

: 320H x 240V x RGB

Aspect Ratio

: 16:9(wide)

Back Lighting

: LED

■ USB interface section

USB Standard

: USB 2.0 High Speed

File System

: FAT 16/ 32, NTFS

Maximum Power Supply Current

: DC 5 V  1 A

Audio Decoder

: MP3/ WMA/ AAC/ WAV/ FLAC/ OGG

Video Decoder

: MPEG1/ MPEG2/ MPEG4/ H.264/ MKV/ JPEG/ BMP/
PNG

Frequency Response

: 20 – 20,000 Hz

■ Bluetooth section

Technology

: Bluetooth Ver.4.2

Frequency

: 2.402 – 2.480 GHz

Output Power

: +4 dBm (MAX), Power Class1

Maximum Communication range

: Line of sight approx. 10m (32.8 ft)

Audio Codec

SBC

Profile (Multi Profile support)

- HFP (Hands Free Profile)
- A2DP (Advanced Audio Distribution Profile)
- AVRCP (Audio/Video Remote Control Profile)
- PBAP (Phonebook Access Profile)

■ FM tuner section

Frequency Range (step)

: 87.9 MHz – 107.9 MHz (200 kHz)

Frequency Response

: 30 Hz – 15 kHz

■ AM tuner section

Frequency Range (step)

: 530 – 1700 kHz (10 kHz)

■ DSP section

Graphics equalizer

Band :13 Band

Frequency: 62.5/100/160/250/400/630/1k/1.6k/2.5k/
4k/6.3k/10k/16kHz

Gain: -9 — 9 dB (1 dB/Step)

2Way X'Over

High pass filter

Frequency: Through, 40/60/80/120/160 Hz

Slope: -6/-12/-18/-24 dB/Oct.

Gain: -8/-7/-6/-5/-4/-3/-2/-1/0 dB

Low pass filter

Frequency: Through, 40/60/80/120/160 Hz

Slope: -6/-12/-18/-24 dB/Oct.

Gain: -8/-7/-6/-5/-4/-3/-2/-1/0 dB

Position

Front/Rear/Subwoofer Delay:

0-18 mS (0.03 mS/Step)

■ Video section

Video Input Level

: 1.0 Vp-p/ 75 Ω

■ AUX section

External Audio Max input Level

: 2 V/ 25 kΩ

About this Unit

Audio section

Maximum Power (Front & Rear)

: 45 W

Full Bandwidth Power (1% THD)

: 17 W × 4

Speaker Impedance

: 4 – 8 Ω

Equalizer

: 7 Band

Band

Frequency: 62.5/ 160/ 400/ 1k/ 2.5k/ 6.3k/ 16k Hz

Level: -7 – +7 (-7 dB – +7 dB)

LPF

Frequency: 80/ 120/ 160 Hz

General

Operating Voltage

: 12 V

Maximum Current Consumption

: 15 A

Installation Dimensions (W × H × D)

: 182 × 52 × 117 mm (with sleeve)

7-3/16 × 2-1/16 × 4-5/8 inch

Weight

: 0.66 kg (1.5 lbs)

NOTE

- Although the effective pixels for the liquid crystal panel is given as 99.99% or more, 0.01% of pixels may not light or may light incorrectly.
- Specifications subject to change without notice.

About this Unit

For USA

CAUTION

Use of controls or adjustments or performance of procedures other than those specified herein may result in hazardous radiation exposure. In compliance with Federal Regulations, following are reproductions of labels on, or inside the product relating to laser product safety.

JVC KENWOOD Corporation
2967-3, ISHIKAWA-MACHI,
HACHIOJI-SHI, TOKYO, JAPAN

THIS PRODUCT COMPLIES WITH DHHS RULES
21 CFR SUBCHAPTER J IN EFFECT AT DATE OF
MANUFACTURE.

Location: Bottom plate

This transmitter must not be co-located or operated in conjunction with any other antenna or transmitter.

For Canada

Supplier's Declaration of Conformity

Trade Name: KENWOOD
Products: MONITOR WITH RECEIVER
Model Name: KD-X560BT
Responsible Party: JVCKENWOOD USA
CORPORATION
2201 East Dominguez Street,
Long Beach, CA 90810, U.S.A.
PHONE: 310 639-9000

THIS DEVICE COMPLIES WITH PART 15 OF THE FCC
RULES. OPERATION IS SUBJECT TO THE FOLLOWING
TWO CONDITIONS:

- (1) THIS DEVICE MAY NOT CAUSE HARMFUL INTERFERENCE, AND
- (2) THIS DEVICE MUST ACCEPT ANY INTERFERENCE RECEIVED, INCLUDING INTERFERENCE THAT MAY CAUSE UNDESIRED OPERATION.

CALIFORNIA, USA

which contains Perchlorate Material – special handling may apply.
This product contains a CR Coin Cell Lithium Battery
See www.dtsc.ca.gov/hazardouswaste/perchlorate

For Argentina

Información acerca de la eliminación de equipos eléctricos y electrónicos al final de la vida útil (aplicable a los países que hayan adoptado sistemas independientes de recogida de residuos)



Los productos con el símbolo de un contenedor con ruedas tachado no podrán ser desechados como residuos domésticos.

Los equipos eléctricos y electrónicos al final de la vida útil, deberán ser reciclados en instalaciones que puedan dar el tratamiento adecuado a estos productos y a sus subproductos residuales correspondientes. Póngase en contacto con su administración local para obtener información sobre el punto de recogida más cercano. Un tratamiento correcto del reciclaje y la eliminación de residuos ayuda a conservar los recursos y evita al mismo tiempo efectos perjudiciales en la salud y el medio ambiente.

For Mexico

Para cumplimiento de la IFT:

La operación de este equipo esta sujeta a las siguientes dos condiciones:

- (1) es posible que este equipo o dispositivo no cause interferencia perjudicial y
- (2) este equipo o dispositivo debe aceptar cualquier interferencia, incluyendo la que pueda causar su operación no deseada.

About this Unit

FCC STATEMENT

1. This device complies with Part 15 of the FCC Rules. Operation is subject to the following two conditions:
(1) This device may not cause harmful interference, and
(2) This device must accept any interference received, including interference that may cause undesired operation.
2. Changes or modifications not expressly approved by the party responsible for compliance could void the user's authority to operate the equipment.

NOTE: This equipment has been tested and found to comply with the limits for a Class B digital device, pursuant to Part 15 of the FCC Rules. These limits are designed to provide reasonable protection against harmful interference in a residential installation.

This equipment generates uses and can radiate radio frequency energy and, if not installed and used in accordance with the instructions, may cause harmful interference to radio communications. However, there is no guarantee that interference will not occur in a particular installation. If this equipment does cause harmful interference to radio or television reception, which can be determined by turning the equipment off and on, the user is encouraged to try to correct the interference by one or more of the following measures: Reorient or relocate the receiving antenna. Increase the separation between the equipment and receiver. Connect the equipment into an outlet on a circuit different from that to which the receiver is connected. Consult the dealer or an experienced radio / TV technician for help.

IC warning

- English:

This device contains licence-exempt transmitter(s)/ receiver(s) that comply with Innovation, Science and Economic Development Canada's licence-exempt RSS(s). Operation is subject to the following two conditions:
(1) This device may not cause interference; and
(2) This device must accept any interference, including Interference that may cause undesired operation of the device.

FCC/ IC Radiation Exposure Statement

This equipment complies with FCC and IC radiation exposure limits set forth for an uncontrolled environment. This equipment should be installed and operated with minimum distance 20cm between the radiator & your body

- French:

Cet appareil contient des metteurs / rcepteurs exempts de licence conformes aux RSS (RSS) d'Innovation, Sciences et Dveloppement conomique Canada. L'exploitation est autorisée aux deux conditions suivantes:
(1) l'appareil ne doit pas produire de brouillage, et
(2) l'utilisateur de l'appareil doit accepter tout brouillage radio électrique subi, même si le brouillage est susceptible d'en compromettre le fonctionnement."

FCC/ IC Déclaration d'exposition aux rayonnements

Cet appareil est conforme à FCC et IC l'exposition aux rayonnements limites fixées pour un environnement non contrôlé. Cet appareil doit être installé et utilisé avec une distance minimale de 20 cm entre le radiateur et votre corps. Cet transmetteur ne doit pas être co-situé ou opérant en liaison avec toute autre antenne ou transmetteur.

JVC