

**ELECTROMAGNETIC EMISSIONS COMPLIANCE REPORT
INTENTIONAL RADIATOR CERTIFICATION TO
FCC PART 15 SUBPART C REQUIREMENT**

OF

USB/MP3/WMA DIGITAL MEDIA RECEIVER

Model No.: FZ105BT

Trade Mark: Clarion

FCC ID: 2AB7S-FZ105BT

Report No.: KAD141119068E

Issue Date: April 16, 2015

Prepared for

**Soundmax Electronics Limited
17/F., Eu Yang Sang Tower, 11-15 Chatham Road South, Tsim Sha Tsui ,
Kowloon., Hong Kong**

Prepared by

DONGGUAN EMTEK CO., LTD.

**No.281, Guantai Road, Nancheng District,
Dongguan, Guangdong, China
TEL: 86-769-22807078
FAX: 86-769-22807079**

**This report shall not be reproduced, except in full, without the written approval of
DONGGUAN EMTEK CO., LTD.**

VERIFICATION OF COMPLIANCE

Applicant:	Soundmax Electronics Limited 17/F.,Eu Yang Sang Tower, 11-15 Chatham Road South, Tsim Sha Tsui , Kowloon., Hong Kong
Manufacturer:	Soundmax Electronics Limited 17/F.,Eu Yang Sang Tower, 11-15 Chatham Road South, Tsim Sha Tsui , Kowloon., Hong Kong
Product Description:	USB/MP3/WMA DIGITAL MEDIA RECEVIER
Trade Mark:	Clarion
Model Number:	FZ105BT
Kind of Device:	Bluetooth Ver.2.1+EDR
Date of Test:	November 19, 2014 to March 26, 2015

We hereby certify that:

The above equipment was tested by DONGGUAN EMTEK CO., LTD. The test data, data evaluation, test procedures, and equipment configurations shown in this report were made in accordance with the procedures given in ANSI C63.4 (2014) and the energy emitted by the sample EUT tested as described in this report is in compliance with conducted and radiated emission limits of FCC Rules Part 15.247(2014).

Approved By



**Sam Lv / Q.A. Manager
DONGGUAN EMTEK CO., LTD.**

Modified Information

Version	Summary	Revision Date	Report No.
Ver.1.0	Original Report	/	KAD141119068E

Table of Contents

1. GENERAL INFORMATION	6
1.1 PRODUCT DESCRIPTION.....	6
1.2 RELATED SUBMITTAL(S) / GRANT (S).....	6
1.3 TEST METHODOLOGY.....	6
1.4 SPECIAL ACCESSORIES.....	6
1.5 EQUIPMENT MODIFICATIONS	7
1.6 TEST FACILITY	7
2. SYSTEM TEST CONFIGURATION.....	8
2.1 EUT CONFIGURATION.....	8
2.2 EUT EXERCISE.....	8
2.3 TEST PROCEDURE	8
2.4 LIMITATION.....	8
2.5 CONFIGURATION OF TESTED SYSTEM	12
3. SUMMARY OF TEST RESULTS	13
4. DESCRIPTION OF TEST MODES	13
5. RADIATED EMISSION TEST.....	14
5.1 MEASUREMENT PROCEDURE	14
5.2 TEST SET-UP (BLOCK DIAGRAM OF CONFIGURATION).....	15
5.3 MEASUREMENT EQUIPMENT USED:	16
5.4 MEASUREMENT RESULT	16
5.5 RADIATED MEASUREMENT PHOTOS:	28
6. CHANNEL SEPARATION TEST.....	29
6.1 MEASUREMENT PROCEDURE	29
6.2 TEST SET-UP (BLOCK DIAGRAM OF CONFIGURATION).....	29
6.3 MEASUREMENT EQUIPMENT USED:	29
6.4 MEASUREMENT RESULTS:.....	29
7. 20DB BANDWIDTH TEST	36
7.1 MEASUREMENT PROCEDURE	36
7.2 TEST SET-UP (BLOCK DIAGRAM OF CONFIGURATION).....	36
7.3 MEASUREMENT EQUIPMENT USED:	36
7.4 MEASUREMENT RESULTS:.....	36
8. QUANTITY OF HOPPING CHANNEL TEST	43
8.1 MEASUREMENT PROCEDURE	43
8.2 TEST SET-UP (BLOCK DIAGRAM OF CONFIGURATION).....	43
8.3 MEASUREMENT EQUIPMENT USED:	43
8.4 MEASUREMENT RESULTS:.....	43

9. TIME OF OCCUPANCY (DWELL TIME) TEST	44
9.1 TEST DESCRIPTION.....	44
9.2 TEST SET-UP (BLOCK DIAGRAM OF CONFIGURATION).....	44
9.3 MEASUREMENT EQUIPMENT USED:	44
9.4 TEST REQUIREMENTS / LIMITS	44
9.5 MEASUREMENT RESULTS:.....	45
10. MAXIMUM PEAK OUTPUT POWER TEST	47
10.1 MEASUREMENT PROCEDURE	47
10.2 TEST SET-UP (BLOCK DIAGRAM OF CONFIGURATION).....	47
10.3 MEASUREMENT EQUIPMENT USED:	47
10.4 MEASUREMENT RESULTS:.....	48
11. BAND EDGE TEST	54
11.1 MEASUREMENT PROCEDURE	54
11.2 TEST SET-UP (BLOCK DIAGRAM OF CONFIGURATION).....	54
11.3 MEASUREMENT EQUIPMENT USED:	55
11.4 MEASUREMENT RESULTS:.....	56
12. ANTENNA APPLICATION	58
12.1 ANTENNA REQUIREMENT	58
12.2 RESULT	58

1. GENERAL INFORMATION

1.1 Product Description

A major technical descriptions of EUT is described as following:

Characteristics	Description
Product Name	USB/MP3/WMA DIGITAL MEDIA RECEVIER
Model number	FZ105BT
Power Supply	DC 12V
Modulation	GFSK, $\pi/4$ -DQPSK, 8DPSK
Operating Frequency Range	2402-2480MHz
Number of Channels	79
Transmit Power Max	0.03dBm(0.001007W)
Antenna Type	Inverted-E antenna
Antenna Gain	4dBi
Hardware Version	DC-00
Software Version	V00.22

1.2 Related Submittal(s) / Grant (s)

This submittal(s) (test report) is intended for FCC ID: 2AB7S-FZ105BT filing to comply with Section 15.247 of the FCC Part 15, Subpart C Rules and FCC Public Notice DA 00-705.

1.3 Test Methodology

Both conducted and radiated testing were performed according to the procedures in ANSI C63.4 (2014). Radiated testing was performed at an antenna to EUT distance 3 meters.

1.4 Special Accessories

Not available for this EUT intended for grant.

1.5 Equipment Modifications

Not available for this EUT intended for grant.

1.6 Test Facility

Site Description

EMC Lab. :
Registered on FCC, June 18, 2014
The Certificate Number is 247565

Registered on Industry Canada, February 19, 2014
The Certificate Number is 9444A.

Name of Firm : DONGGUAN EMTEK CO., LTD.
Site Location : No.281, Guantai Road, Nancheng District,
Dongguan, Guangdong, China

2. System Test Configuration

2.1 EUT Configuration

The EUT configuration for testing is installed on RF field strength measurement to meet the Commissions requirement and operating in a manner which intends to maximize its emission characteristics in a continuous normal application.

2.2 EUT Exercise

The Transmitter was operated in the normal operating mode. the Tx frequency was fixed which was for the purpose of the measurements.

2.3 Test Procedure

2.3.1 Conducted Emissions

The EUT is a placed on as turn table which is 0.8 m above ground plane. According to the requirements in Section 13.1.4.1 of ANSI C63.4-2014. Conducted emissions from the EUT measured in the frequency range between 0.15 MHz and 30MHz using CISPR Quasi-Peak and average detector mode.

2.3.2 Radiated Emissions

The EUT is a placed on as turn table which is 0.8 m above ground plane. The turn table shall rotate 360 degrees to determine the position of maximum emission level. EUT is set 3m away from the receiving antenna which varied from 1m to 4m to find out the highest emission. And also, each emission was to be maximized by changing the polarization of receiving antenna both horizontal and vertical. In order to find out the max. emission, the relative positions of this transmitter(EUT) was rotated through three orthogonal axes according to the requirements in Section 13.1.4.1 of ANSI C63.4-2014.

2.4 Limitation

(1) Channel Separation test

FCC Part 15, Subpart C Section 15.247(a)(1). Frequency hopping systems shall have hopping channel carrier frequencies separated by a minimum of 25kHz or the 20 Bandwidth of the hopping channel, whichever is greater.

Frequency Range (MHz)	Limit(kHz)
902-928	>25kHz
2400-2483.5	>25kHz
5725-5850	>25kHz

(2) 20dB Bandwidth

Frequency Range(MHz)	Quantity of Hopping Channel	Limit(kHz)			
		50	25	15	75
902-928		<250	>250	NA	NA
2400-2483.5		NA	NA	>1000	<1000

(3) Quantity of Hopping Channel

FCC Part 15, Subpart C Section 15.247

Frequency Range (MHz)	20dB bandwidth <250kHz	Limit(Quantity of Hopping Channel)		
		20dB bandwidth >25 0kHz	20dB bandwidth <1MHz	20dB bandwidth >1MHz z
902-928	50	25	NA	NA
2400-2483.5	NA	NA	15	15
5725-5850	NA	NA	75	NA

(4) Time of Occupancy(Dwell Time)

FCC Part 15, Subpart C Section 15.247

Frequency Range (MHz)	20dB bandwidth <250kHz(50Channel)	LIMIT(rms)	
		20dB bandwidth >250kHz(25Channel)	20dB bandwidth <1MHz(75Channel)
902-928	400(20S)	400(10S)	NA
2400-2483.5	NA	NA	400(30S)
5725-5850	NA	NA	400(30S)

Note: The “()”is all channel’s average time of occupancy.

(5) Maximum Peak Output Power

FCC Part 15, Subpart C Section 15.247

Frequency Range (MHz)	Quantity of Hopping Channel	LIMIT(W)			
		50	25	15	75
902-928		1(30dBm)	0.125(21dBm)	NA	NA
2400-2483.5		NA	NA	0.125(21dBm)	1(30dBm)
5725-5850		NA	NA	NA	1(30dBm)

(6) Band edge

FCC Part15, Subpart C Section 15.247, In any 100kHz bandwidth outside the frequency band in with the spread spectrum intentional radiator is operating, the radio frequency power that is produced by the intentional radiator shall be at least 20dB below that in the 100kHz bandwidth within the band that contains the highest level of the desired power, based on either an RF conducted or a radiated measurement, attenuation below the general limits specified in section 15.209(a) is not required. In addition, radiated emissions which fall in the restricted bands, as defined in section 15.205(a), must also comply with the radiated emission limits specified in section 15.209(a).

Operating Frequency Range(MHz)	Spurious emission frequency	Peak power ration to emission(dBc)	Limit Emission level(dBuV/m)
902-928	<902	>20	NA
	>928	>20	NA
	960-1240	NA	54
2400-2483.5	<2400	>20	NA
	>2483.5-2500	NA	54
5725-5850	<5350-5460	NA	54
	<5725	>20	NA
	>5850	>20	NA

(7) Conducted Emission

Frequency(MHz)	Quasi-peak	Average
0.15-0.5	66-56	56-46
0.5-5.0	56	46
5.0-30.0	60	50

Note:

1. The lower limit shall apply at the transition frequencies
2. The limit decreases in line with the logarithm of the frequency in the range of 0.15 to 0.50MHz.

(8) Radiated Emission

FCC Part 15, Subpart C Section 15.209 limit of radiated emission for frequency below 1000GHz. The emissions from an intentional radiator shall not exceed the field strength level specified in the following table:

Frequency (MHz)	Field strength $\mu\text{V/m}$	Distance(m)	Field strength at 3m $\text{dB}\mu\text{V/m}$
0.009-0.490	2400/F(kHz)	300	/
0.490-1.705	24000/F(kHz)	30	/
1.705-30.0	30	30	/
30-88	100	3	40
88-216	150	3	43.5
216-960	200	3	46
Above 960	500	3	54

Remark 1. Emission level in $\text{dB}\mu\text{V/m} = 20 \log (\mu\text{V/m})$

: 2. Measurement was performed at an antenna to the closed point of EUT distance of meters.

FCC Part 15, Section 15.35(b) limit of radiated emission for frequency above 1000MHz

Frequency(MHz)	Class A($\text{dB}\mu\text{V/m}$)(at 3m)		Class B($\text{dB}\mu\text{V/m}$)(at 3m)	
	PEAK	AVERAGE	PEAK	AVERAGE
Above 1000	80.0	60.0	74.0	54.0

FCC Part 15, Subpart C Section 15.249. The field strength of emissions from intentional radiators operated within these frequency bands shall comply with the following:

Frequency(MHz)	Filed Strength of Fundamental(at 3m)		Filed Strength of Harmonics(at 3m)	
	PEAK	AVERAGE	PEAK	AVERAGE
902-928	114	94	74.0	54.0
2400-2483.5	114	94	74.0	54.0
5725-5875	114	94	74.0	54.0
24000-24250	128	108	88.0	68.0

2.5 Configuration of Tested System

Fig. 2-1 Configuration of Tested System

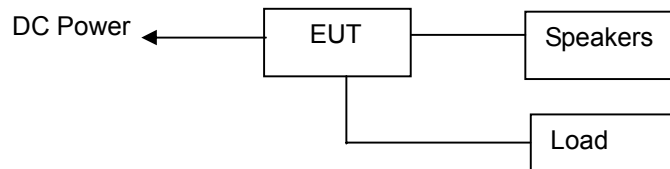

Table 2-1 Equipment Used in Tested System

Item	Equipment	Trade Mark	Model No.	FCC ID	Note
1.	USB/MP3/WMA DIGITAL MEDIA RECEVIER	Clarion	FZ-105BT	2AB7S-FZ105BT	<i>EUT</i>
2	Speakers	Qisheng	HF 210	N/A	Support Equipment

Note:

- (1) Unless otherwise denoted as EUT in 『Remark』 column , device(s) used in tested system is a support equipment.

3. Summary of Test Results

FCC Rules	Description Of Test	Result
§15.247(a)(1)	Channel Separation test	Compliant
§15.247(a)(1)	20dB Bandwidth	Compliant
§15.247(a)(1)(iii)	Quantity of Hopping Channel	Compliant
§15.247(a)(1)(iii)	Time of Occupancy(Dwell Time)	Compliant
§15.247(b)	Max Peak output Power test	Compliant
§15.247(d)	Band edge test	Compliant
§15.207	AC Power Conducted Emission	N/A
§15.247(d),§15.209	Radiated Emission	Compliant
§15.203	Antenna Requirement	Compliant
§1.1310	RF Exposure	Compliant

Remark: The EUT is supplied by Battery, there is no need for AC Power Conducted Emission test to be performed on this product.

4. Description of test modes

The EUT has been tested under TX operating condition.

This EUT is a FHSS system, were conducted to determine the final configuration from all possible combinations. We use software control the EUT, Let EUT hopping on and transmit with highest power, All the modes GFSK, $\pi/4$ -DQPSK, 8DPSK have been tested. 79 Channels are provided by EUT. The 3 channels of lower, medium and higher were chosen for test.

Channel	Frequency(MHz)
1	2402
40	2441
79	2480

5. Radiated Emission Test

5.1 Measurement Procedure

1. The EUT was placed on a turn table which is 0.8m above ground plane.
2. Maximum procedure was performed on the six highest emissions to ensure EUT compliance.
3. And also, each emission was to be maximized by changing the polarization of receiving antenna both horizontal and vertical.
4. Repeat above procedures until all frequency measured were complete.
5. For range 9KHz~30MHz, The measured value is really too low to be recorded.

When spectrum scanned from 30MHz to 1GHz setting resolution bandwidth 120KHz and video bandwidth 300KHz:

EMI Test Receiver	Setting
Attenuation	Auto
RB	120KHz
VB	300KHz
Detector	QP
Trace	Max hold

When spectrum scanned above 1GHz setting resolution bandwidth 1MHz, video bandwidth 3MHz:

EMI Test Receiver	Setting
Attenuation	Auto
RB	1MHz
VB	3MHz
Detector	Peak
Trace	Max hold

When spectrum scanned above 1GHz setting resolution bandwidth 1MHz, video bandwidth 10Hz:

EMI Test Receiver	Setting
Attenuation	Auto
RB	1MHz
VB	10Hz
Detector	Peak
Trace	Max hold

5.2 Test SET-UP (Block Diagram of Configuration)

(A) Radiated Emission Test Set-Up, Frequency Below 30MHz

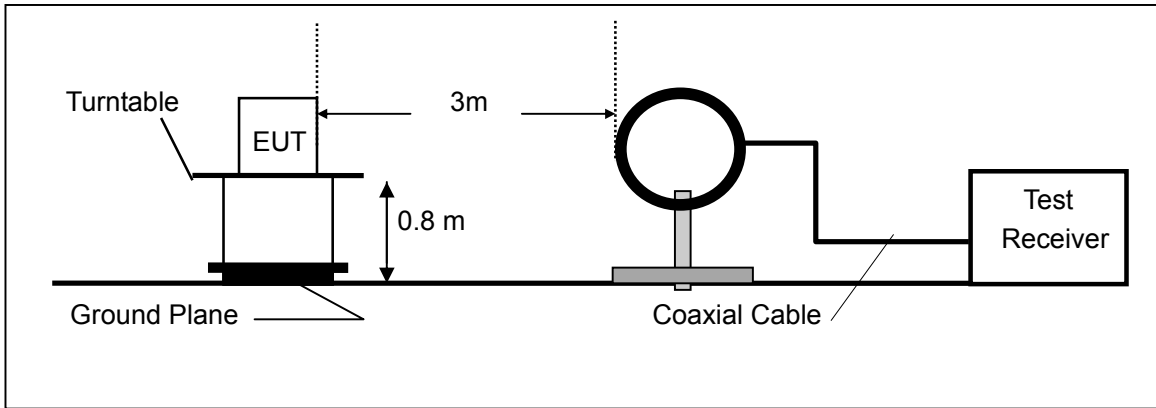

(B) Radiated Emission Test Set-Up, Frequency Below 1000MHz

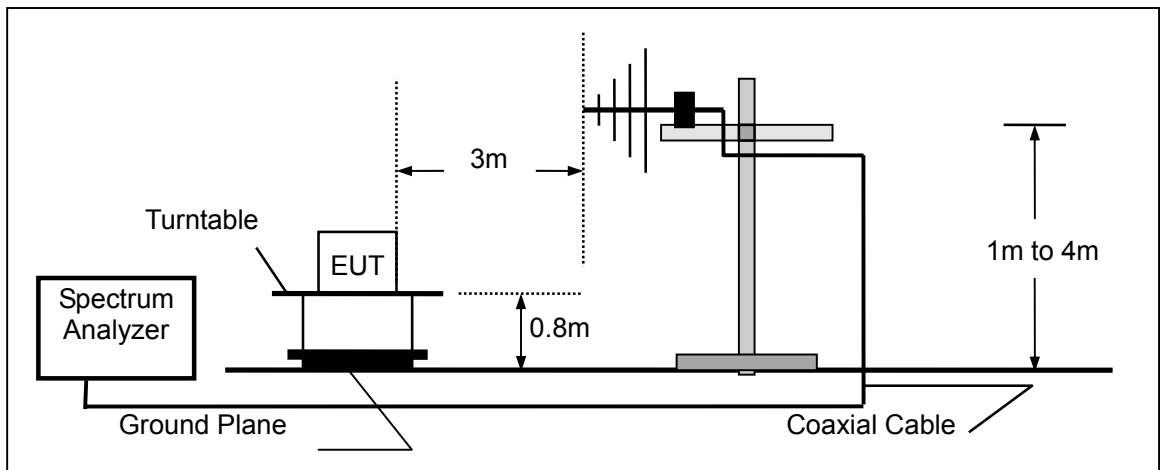

(C) Radiated Emission Test Set-Up, Frequency above 1000MHz

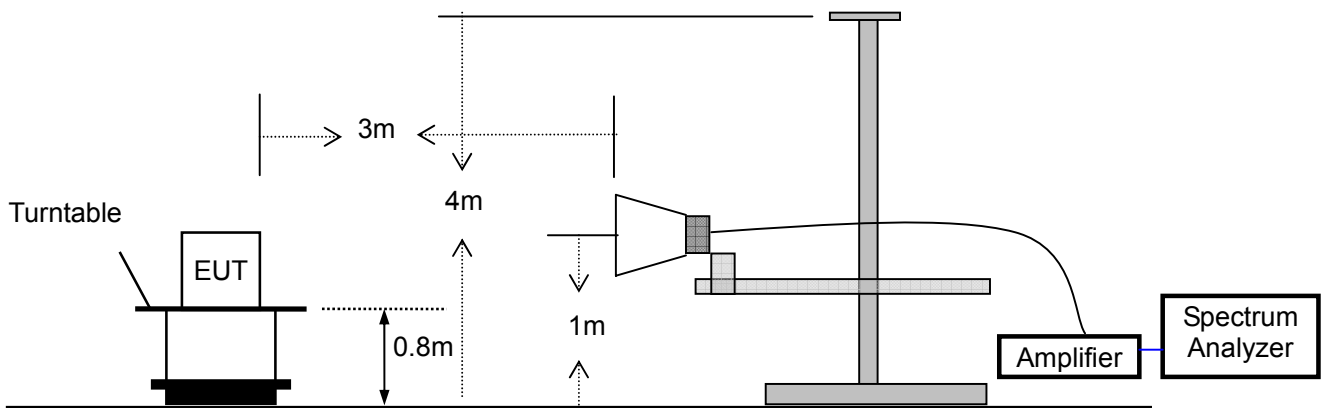

5.3 Measurement Equipment Used:

EQUIPMENT TYPE	MFR	MODEL NUMBER	SERIAL NUMBER	LAST CAL.	CAL DUE.
EMI Test Receiver	Rohde & Schwarz	ESU	1302.6005.26	05/16/2014	05/15/2015
Pre-Amplifier	HP	8447D	2944A07999	05/16/2014	05/15/2015
Bilog Antenna	SCHWARZBECK	VULB9163	142	05/16/2014	05/15/2015
Loop Antenna	ARA	PLA-1030/B	1029	05/16/2014	05/15/2015
Horn Antenna	Schwarzbeck	BBHA9170	BBHA9170399	05/16/2014	05/15/2015
Horn Antenna	Schwarzbeck	BBHA9120D	D143	05/16/2014	05/15/2015
Cable	Schwarzbeck	AK9513	ACRX1	05/19/2014	05/18/2015
Cable	Schwarzbeck	AK9513	FP2RX2	05/19/2014	05/18/2015
Cable	Schwarzbeck	AK9513	CRPX1	05/19/2014	05/18/2015
Cable	Schwarzbeck	AK9513	CRRX2	05/19/2014	05/18/2015

5.4 Measurement Result

Below 30MHz:

All the modulation modes were tested the data of the test mode are recorded in the following pages.

Operation Mode: TX Mode Test Date : November 20, 2014
 Frequency Range: 9KHz~30MHz Temperature : 28°C
 Test Result: PASS Humidity : 60 %
 Measured Distance: 3m Test By: Andy

Freq. (MHz)	Ant.Pol. H/V	Emission Level (dBuV/m)	Limit 3m (dBuV/m)	Over (dB)
--	--	--	--	--

Note: the amplitude of spurious emission that is attenuated by more than 20dB below the permissible limit has no need to be reported.

Distance extrapolation factor = $40 \log(\text{Specific distance} / \text{test distance})$ (dB);

Limit line = Specific limits (dBuV) + distance extrapolation factor.

Below 1000MHz:

Pass.

All the modulation modes were tested the data of the worst mode (TX 2402MHz) are recorded in the following pages and the others modulation methods do not exceed the limits.

Please refer to the following data.

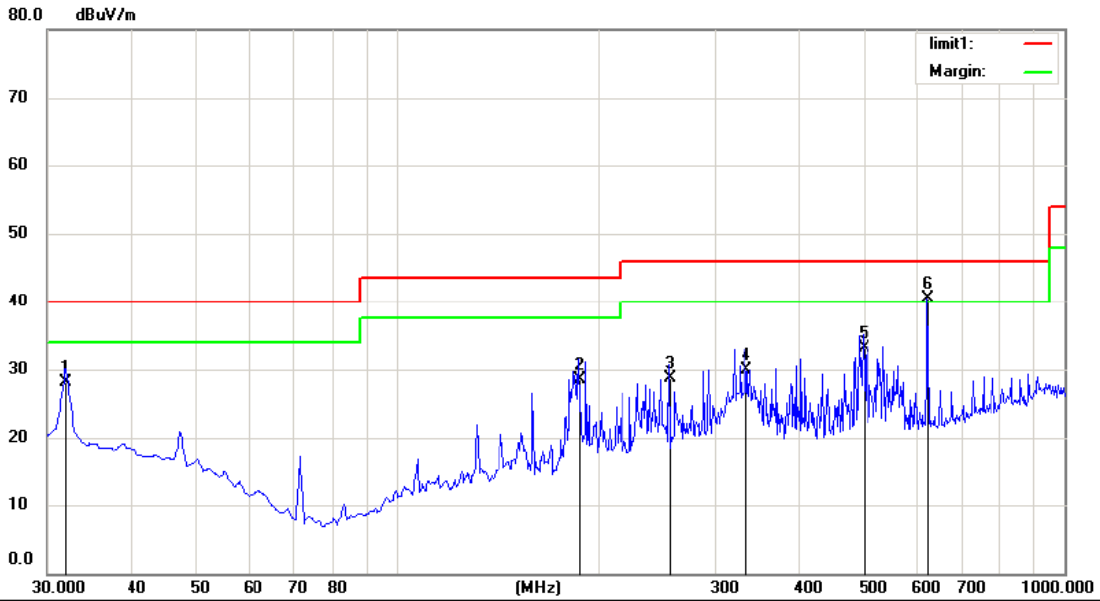

Site Chamber #1 Polarization: **Horizontal** Temperature: 26
 Limit: (RE)FCC PART 15 class B 3m Power: DC 12V Humidity: 55 %
 Mode: TX 2402(GFSK)
 Note:

No.	Mk.	Freq.	Reading Level	Correct Factor	Measurement	Limit	Over	Antenna Height	Table Degree	
		MHz	dBuV	dB	dBuV/m	dBuV/m	dB	cm	degree	Comment
1		31.9400	42.76	-14.63	28.13	40.00	-11.87	QP		
2		187.1400	46.83	-18.41	28.42	43.50	-15.08	QP		
3		256.0100	44.22	-15.58	28.64	46.00	-17.36	QP		
4		332.6400	43.01	-13.13	29.88	46.00	-16.12	QP		
5		499.4800	43.54	-10.37	33.17	46.00	-12.83	QP		
6	*	623.6400	48.67	-8.25	40.42	46.00	-5.58	QP		

*:Maximum data x:Over limit !:over margin

Operator: QIU

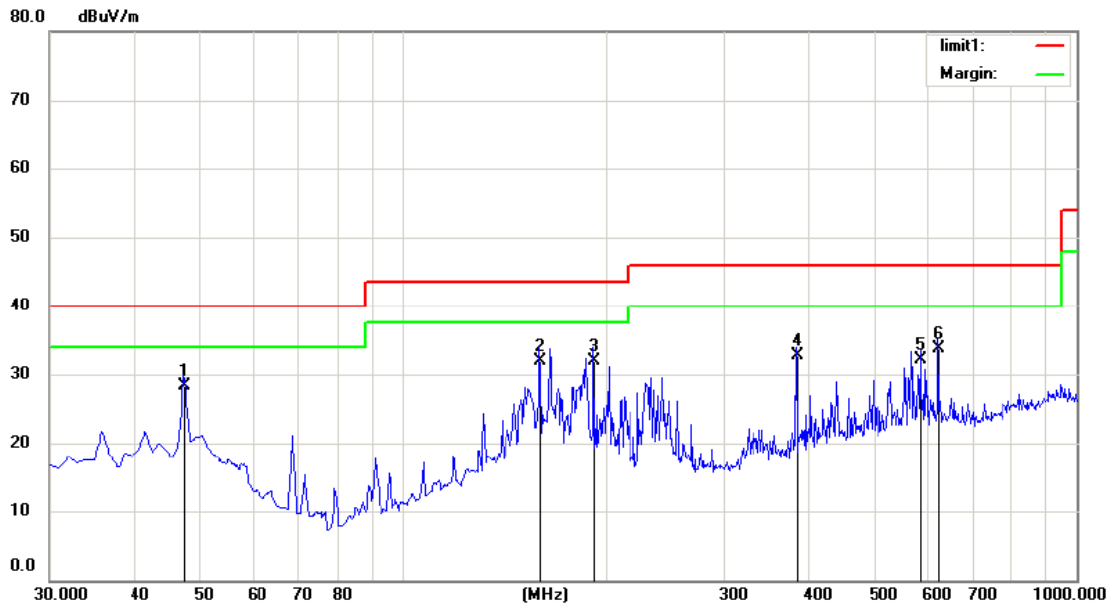

Site Chamber #1 Polarization: **Vertical** Temperature: 26
 Limit: (RE)FCC PART 15 class B 3m Power: DC 12V Humidity: 55 %
 Mode: TX 2402(GFSK)
 Note:

No.	Mk.	Freq. MHz	Reading Level dBuV	Correct Factor dB	Measure- ment dBuV/m	Limit dBuV/m	Over dB	Antenna Height cm	Table Degree degree	Comment
1		47.4600	42.71	-14.38	28.33	40.00	-11.67	QP		
2	*	159.9800	50.41	-18.44	31.97	43.50	-11.53	QP		
3		191.9900	50.00	-18.14	31.86	43.50	-11.64	QP		
4		384.0500	44.76	-11.96	32.80	46.00	-13.20	QP		
5		588.7200	40.61	-8.55	32.06	46.00	-13.94	QP		
6		624.6100	41.92	-8.25	33.67	46.00	-12.33	QP		

*:Maximum data x:Over limit !:over margin

Operator: QIU

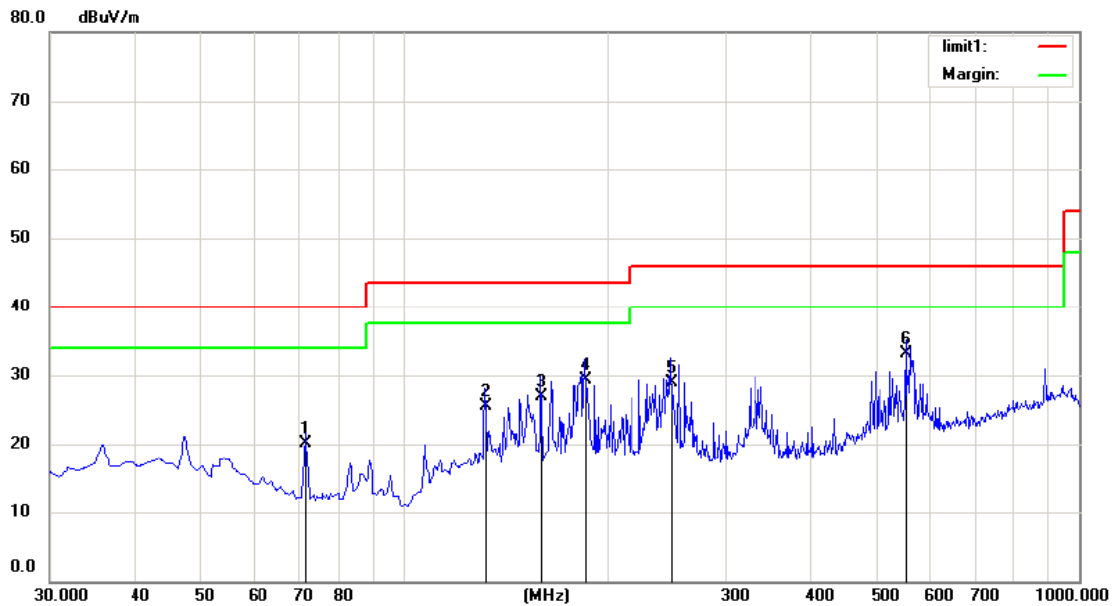

Site Chamber #1 Polarization: **Horizontal** Temperature: 26
 Limit: (RE)FCC PART 15 class B 3m Power: DC 12V Humidity: 55 %
 Mode: TX 2402(Pi/4-DQPSK)
 Note:

No.	Mk.	Freq.	Reading Level	Correct Factor	Measurement	Limit	Over	Antenna Height	Table Degree	
		MHz	dBuV	dB	dBuV/m	dBuV/m	dB	cm	degree	Comment
1		71.7100	42.43	-22.31	20.12	40.00	-19.88	QP		
2		131.8500	41.89	-16.34	25.55	43.50	-17.95	QP		
3		159.9800	45.39	-18.44	26.95	43.50	-16.55	QP		
4		185.2000	47.78	-18.47	29.31	43.50	-14.19	QP		
5		249.2200	44.45	-15.49	28.96	46.00	-17.04	QP		
6	*	556.7100	42.04	-8.92	33.12	46.00	-12.88	QP		

*:Maximum data x:Over limit !:over margin

Operator: QIU

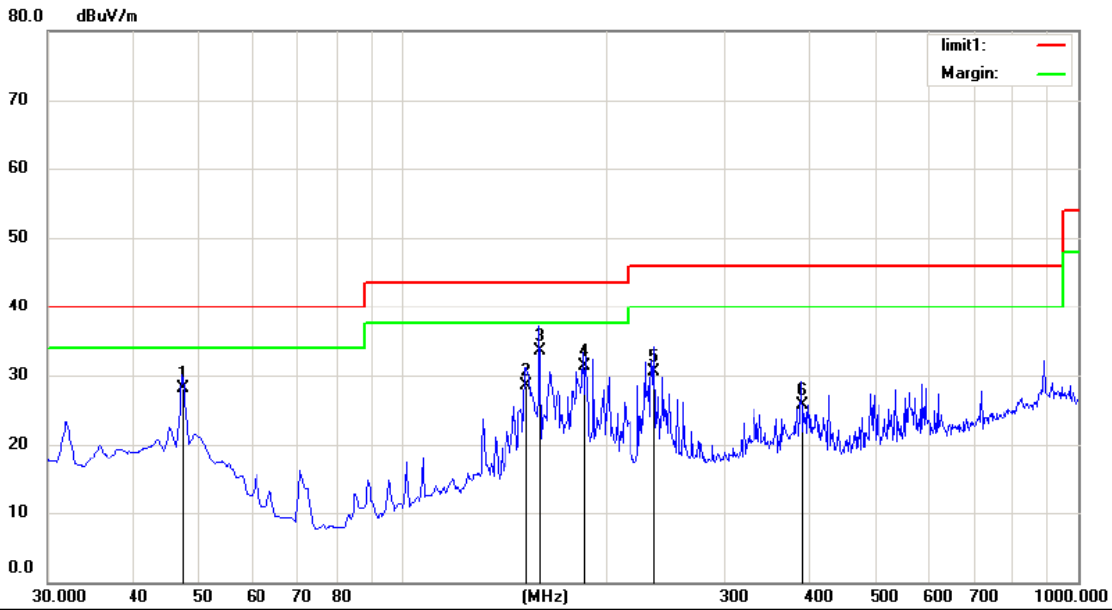

Site Chamber #1 Polarization: **Vertical** Temperature: 26
 Limit: (RE)FCC PART 15 class B 3m Power: DC 12V Humidity: 55 %
 Mode: TX 2402(Pi/4-DQPSK)
 Note:

No.	Mk.	Freq.	Reading Level	Correct Factor	Measurement	Limit	Over	Antenna Height	Table Degree	
		MHz	dBuV	dB	dBuV/m	dBuV/m	dB	cm	degree	Comment
1		47.4600	42.52	-14.38	28.14	40.00	-11.86	QP		
2		153.1900	46.58	-18.03	28.55	43.50	-14.95	QP		
3	*	159.9800	51.94	-18.44	33.50	43.50	-10.00	QP		
4		185.2000	49.85	-18.47	31.38	43.50	-12.12	QP		
5		236.6100	46.43	-15.83	30.60	46.00	-15.40	QP		
6		389.8700	37.35	-11.72	25.63	46.00	-20.37	QP		

*:Maximum data x:Over limit !:over margin

Operator: QIU

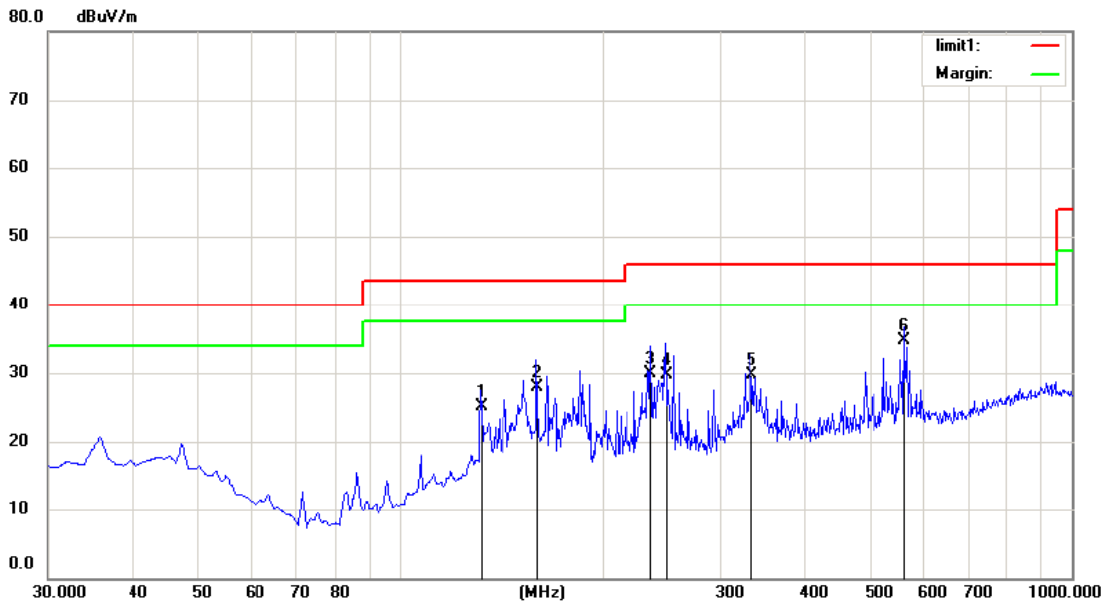

Site Chamber #1 Polarization: **Horizontal** Temperature: 26
 Limit: (RE)FCC PART 15 class B 3m Power: DC 12V Humidity: 55 %
 Mode: TX 2402(8DPSK)
 Note:

No.	Mk.	Freq.	Reading Level	Correct Factor	Measurement	Limit	Over	Antenna Height	Table Degree	
		MHz	dBuV	dB	dBuV/m	dBuV/m	dB	cm	degree	Comment
1		131.8500	41.40	-16.34	25.06	43.50	-18.44			QP
2		159.9800	46.26	-18.44	27.82	43.50	-15.68			QP
3		236.6100	45.67	-15.83	29.84	46.00	-16.16			QP
4		249.2200	45.26	-15.49	29.77	46.00	-16.23			QP
5		332.6400	42.76	-13.13	29.63	46.00	-16.37			QP
6	*	563.5000	43.51	-8.84	34.67	46.00	-11.33			QP

*:Maximum data x:Over limit !:over margin

Operator: QIU

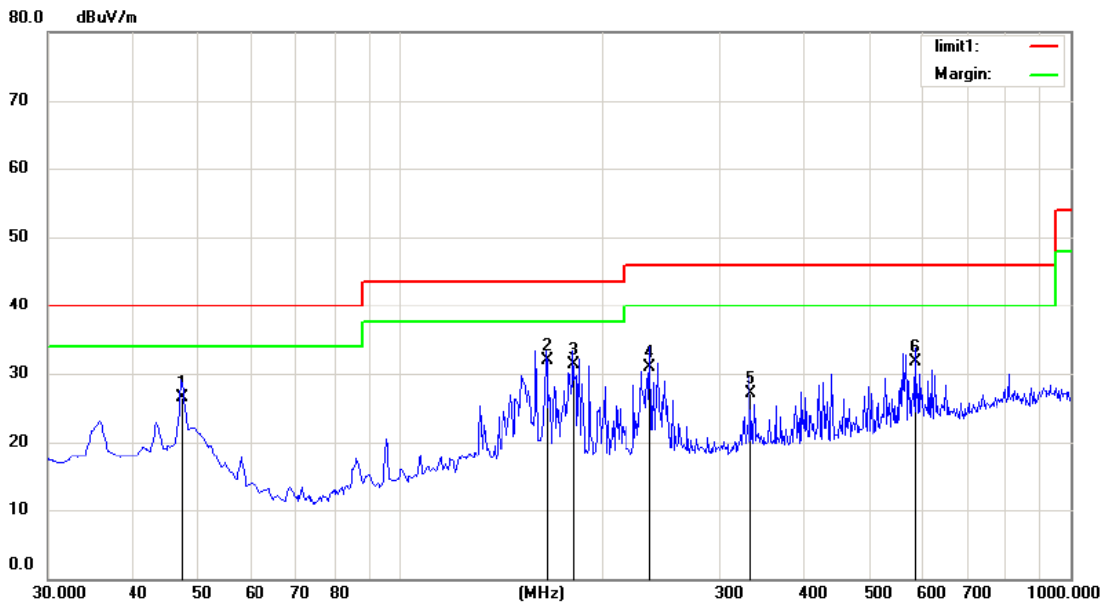

Site Chamber #1 Polarization: **Vertical** Temperature: 26
 Limit: (RE)FCC PART 15 class B 3m Power: DC 12V Humidity: 55 %
 Mode: TX 2402(8DPSK)
 Note:

No.	Mk.	Freq.	Reading Level	Correct Factor	Measurement	Limit	Over	Antenna Height	Table Degree	
		MHz	dBuV	dB	dBuV/m	dBuV/m	dB	cm	degree	Comment
1		47.4600	40.90	-14.38	26.52	40.00	-13.48			QP
2	*	165.8000	50.28	-18.40	31.88	43.50	-11.62			QP
3		181.3200	50.01	-18.73	31.28	43.50	-12.22			QP
4		236.6100	46.70	-15.83	30.87	46.00	-15.13			QP
5		332.6400	40.28	-13.21	27.07	46.00	-18.93			QP
6		588.7200	40.28	-8.55	31.73	46.00	-14.27			QP

*:Maximum data x:Over limit !:over margin

Operator: QIU

Above 1000MHz~10th Harmonics:

Operation Mode: GFSK (CH1: 2402MHz) Test Date : November 20, 2014

Freq. (MHz)	Ant. Pol. H/V	Emission Level(dBuV/m)		Limit 3m(dBuV/m)		Over(dB)	
		PK	AV	PK	AV	PK	AV
4804	V	65.36	44.19	74	54	-8.64	-9.81
7206	V	64.06	43.05	74	54	-9.94	-10.95
9608	V	63.59	42.95	74	54	-10.41	-11.05
12010	V	62.01	41.19	74	54	-11.99	-12.81
14412	V	61.09	40.59	74	54	-12.91	-13.41
16814	V	60.55	39.72	74	54	-13.45	-14.28
4804	H	64.09	43.34	74	54	-9.91	-10.66
7206	H	63.29	42.69	74	54	-10.71	-11.31
9608	H	62.37	41.18	74	54	-11.63	-12.82
12010	H	61.13	40.27	74	54	-12.87	-13.73
14412	H	60.59	39	74	54	-13.41	-15
16814	H	59.38	38.49	74	54	-14.62	-15.51

Operation Mode: GFSK (CH40: 2441MHz) Test Date : November 20, 2014

Freq. (MHz)	Ant. Pol. H/V	Emission Level(dBuV/m)		Limit 3m(dBuV/m)		Over(dB)	
		PK	AV	PK	AV	PK	AV
4882	V	66.33	45.95	74	54	-7.67	-8.05
7323	V	65.29	44.17	74	54	-8.71	-9.83
9764	V	64.07	43.59	74	54	-9.93	-10.41
12205	V	63.49	42.07	74	54	-10.51	-11.93
14646	V	62.95	41.72	74	54	-11.05	-12.28
17087	V	61.03	40.59	74	54	-12.97	-13.41
4882	H	65.07	46.59	74	54	-8.93	-7.41
7323	H	64.29	45.85	74	54	-9.71	-8.15
9764	H	63.85	44.17	74	54	-10.15	-9.83
12205	H	63.71	43.92	74	54	-10.29	-10.08
14646	H	62.59	42.07	74	54	-11.41	-11.93
17087	H	61.07	41.52	74	54	-12.93	-12.48

Operation Mode: GFSK (CH79: 2480MHz) Test Date : November 20, 2014

Freq. (MHz)	Ant. Pol. H/V	Emission Level(dBuV/m)		Limit 3m(dBuV/m)		Over(dB)	
		PK	AV	PK	AV	PK	AV
4960	V	67.59	44.08	74	54	-6.41	-9.92
7440	V	66.22	43.13	74	54	-7.78	-10.87
9920	V	65.07	42.95	74	54	-8.93	-11.05
12400	V	64.18	41.07	74	54	-9.82	-12.93
14880	V	63.89	40.22	74	54	-10.11	-13.78
17360	V	62.73	39.83	74	54	-11.27	-14.17
4960	H	66.72	46.28	74	54	-7.28	-7.72
7440	H	65.38	45.1	74	54	-8.62	-8.9
9920	H	64.08	44.29	74	54	-9.92	-9.71
12400	H	63.92	43.92	74	54	-10.08	-10.08
14880	H	62.17	42.72	74	54	-11.83	-11.28
17360	H	61.07	41.13	74	54	-12.93	-12.87

Operation Mode: Pi/4-DQPSK (CH1: 2402MHz) Test Date : March 20, 2015

Freq. (MHz)	Ant. Pol. H/V	Emission Level(dBuV/m)		Limit 3m(dBuV/m)		Over(dB)	
		PK	AV	PK	AV	PK	AV
4804	V	66.33	45	74	54	-7.67	-9
7206	V	65.71	44.13	74	54	-8.29	-9.87
9608	V	64.71	43.25	74	54	-9.29	-10.75
12010	V	63.05	42.59	74	54	-10.95	-11.41
14412	V	62.95	41.36	74	54	-11.05	-12.64
16814	V	61.58	40.87	74	54	-12.42	-13.13
4804	H	65.71	44.35	74	54	-8.29	-9.65
7206	H	64.35	43.59	74	54	-9.65	-10.41
9608	H	63.25	42.18	74	54	-10.75	-11.82
12010	H	62.15	41.82	74	54	-11.85	-12.18
14412	H	61.05	40.35	74	54	-12.95	-13.65
16814	H	60.72	37.89	74	54	-13.28	-16.11

Operation Mode: Pi/4-DQPSK (CH40: 2441MHz) Test Date : March 20, 2015

Freq. (MHz)	Ant. Pol. H/V	Emission Level(dBuV/m)		Limit 3m(dBuV/m)		Over(dB)	
		PK	AV	PK	AV	PK	AV
4882	V	65.33	45.13	74	54	-8.67	-8.87
7323	V	64.05	44.05	74	54	-9.95	-9.95
9764	V	63.71	43.18	74	54	-10.29	-10.82
12205	V	62.85	42.95	74	54	-11.15	-11.05
14646	V	61.04	41.07	74	54	-12.96	-12.93
17087	V	60.33	40.32	74	54	-13.67	-13.68
4882	H	66.74	45.18	74	54	-7.26	-8.82
7323	H	65.15	44.72	74	54	-8.85	-9.28
9764	H	64.08	43.18	74	54	-9.92	-10.82
12205	H	63.71	42.05	74	54	-10.29	-11.95
14646	H	62.15	41.92	74	54	-11.85	-12.08
17087	H	60.59	40.38	74	54	-13.41	-13.62

Operation Mode: Pi/4-DQPSK (CH79: 2480MHz) Test Date : March 20, 2015

Freq. (MHz)	Ant. Pol. H/V	Emission Level(dBuV/m)		Limit 3m(dBuV/m)		Over(dB)	
		PK	AV	PK	AV	PK	AV
4960	V	65.33	44.25	74	54	-8.67	-9.75
7440	V	64.15	43.92	74	54	-9.85	-10.08
9920	V	63.72	42.15	74	54	-10.28	-11.85
12400	V	62.59	41.05	74	54	-11.41	-12.95
14880	V	61.05	40.92	74	54	-12.95	-13.08
17360	V	60.35	39.72	74	54	-13.65	-14.28
4960	H	65.82	45.72	74	54	-8.18	-8.28
7440	H	64.35	44.18	74	54	-9.65	-9.82
9920	H	62.71	43.25	74	54	-11.29	-10.75
12400	H	60.59	42.92	74	54	-13.41	-11.08
14880	H	59.72	41.08	74	54	-14.28	-12.92
17360	H	58.42	40.39	74	54	-15.58	-13.61

Operation Mode: 8DPSK (CH1: 2402MHz) Test Date : March 20, 2015

Freq. (MHz)	Ant. Pol. H/V	Emission Level(dBuV/m)		Limit 3m(dBuV/m)		Over(dB)	
		PK	AV	PK	AV	PK	AV
4804	V	65.03	45.72	74	54	-8.97	-8.28
7206	V	64.15	44.15	74	54	-9.85	-9.85
9608	V	63.82	43.05	74	54	-10.18	-10.95
12010	V	62.74	42.92	74	54	-11.26	-11.08
14412	V	61.08	41.02	74	54	-12.92	-12.98
16814	V	60.59	40.36	74	54	-13.41	-13.64
4804	H	66.18	46.25	74	54	-7.82	-7.75
7206	H	65.03	45.71	74	54	-8.97	-8.29
9608	H	64.82	44.36	74	54	-9.18	-9.64
12010	H	63.95	43.92	74	54	-10.05	-10.08
14412	H	62.71	42.15	74	54	-11.29	-11.85
16814	H	60.58	41.28	74	54	-13.42	-12.72

Operation Mode: 8DPSK (CH40: 2441MHz) Test Date : March 20, 2015

Freq. (MHz)	Ant. Pol. H/V	Emission Level(dBuV/m)		Limit 3m(dBuV/m)		Over(dB)	
		PK	AV	PK	AV	PK	AV
4882	V	65.72	45.15	74	54	-8.28	-8.85
7323	V	64.13	44.05	74	54	-9.87	-9.95
9764	V	63.82	43.92	74	54	-10.18	-10.08
12205	V	62.49	42.82	74	54	-11.51	-11.18
14646	V	61.05	41.04	74	54	-12.95	-12.96
17087	V	60.35	40.39	74	54	-13.65	-13.61
4882	H	65.36	44.18	74	54	-8.64	-9.82
7323	H	64.18	43.62	74	54	-9.82	-10.38
9764	H	63.58	42.18	74	54	-10.42	-11.82
12205	H	62.71	41.08	74	54	-11.29	-12.92
14646	H	61.92	40.39	74	54	-12.08	-13.61
17087	H	60.39	38.64	74	54	-13.61	-15.36

Operation Mode: 8DPSK (CH79: 2480MHz) Test Date : March 20, 2015

Freq. (MHz)	Ant. Pol. H/V	Emission Level(dBuV/m)		Limit 3m(dBuV/m)		Over(dB)	
		PK	AV	PK	AV	PK	AV
4960	V	66.33	44.02	74	54	-7.67	-9.98
7440	V	65.15	42.62	74	54	-8.85	-11.38
9920	V	64.05	41.08	74	54	-9.95	-12.92
12400	V	63.82	40.35	74	54	-10.18	-13.65
14880	V	61.72	38.49	74	54	-12.28	-15.51
17360	V	60.59	37.49	74	54	-13.41	-16.51
4960	H	65.74	44.55	74	54	-8.26	-9.45
7440	H	64.03	43.19	74	54	-9.97	-10.81
9920	H	63.82	42.92	74	54	-10.18	-11.08
12400	H	62.19	41.05	74	54	-11.81	-12.95
14880	H	61.7	40.39	74	54	-12.3	-13.61
17360	H	60.39	38.46	74	54	-13.61	-15.54

Other harmonics emissions are lower than 20dB below the allowable limit.

- Note:**
- (1) All Readings are Peak Value and AV.
 - (2) Emission Level= Reading Level+ Probe Factor +Cable Loss.
 - (3) The average measurement was not performed when the peak measured data under the limit of average detection.

5.5 Radiated Measurement Photos:

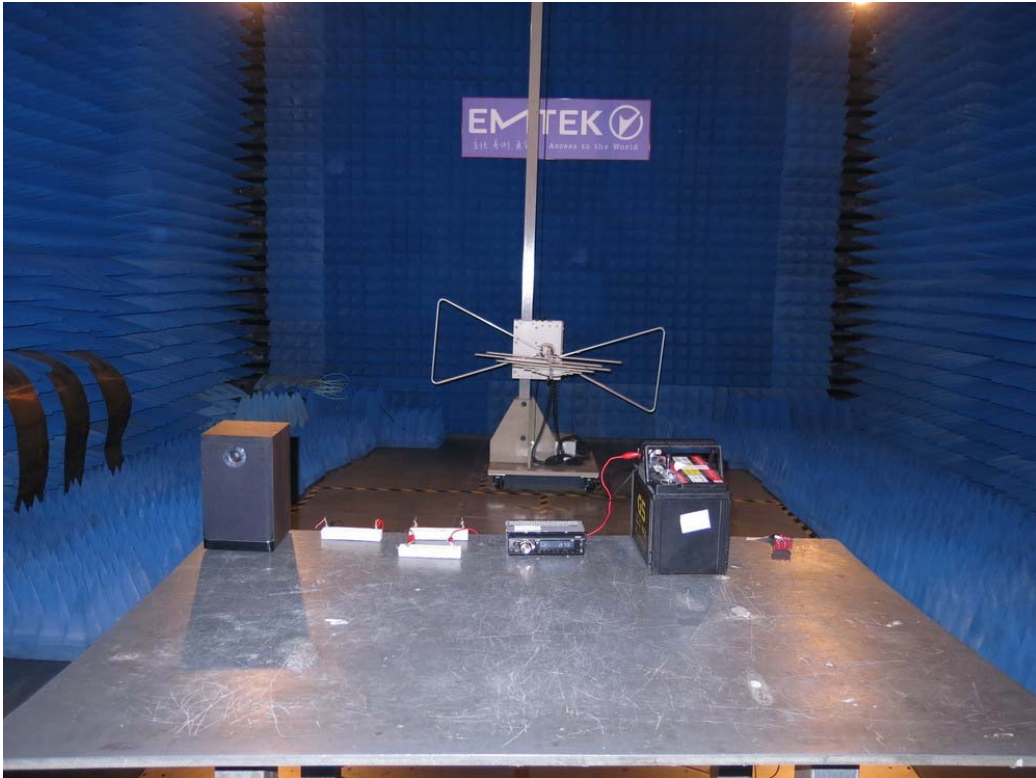

6. Channel Separation test

6.1 Measurement Procedure

The EUT was operating in hopping mode or could be controlled its channel. Printed out the test result from the spectrum by hard copy function.

6.2 Test SET-UP (Block Diagram of Configuration)

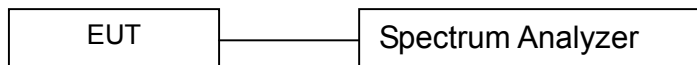

6.3 Measurement Equipment Used:

EQUIPMENT TYPE	MFR	MODEL NUMBER	SERIAL NUMBER	LAST CAL.	CAL DUE.
Spectrum Analyzer	Rohde & Schwarz	FSV30	1321.3008K	05/16/2014	05/15/2015
Coaxial Cable	CDS	79254	46107086	05/16/2014	05/15/2015
Antenna Connector	ARTHUR-YANG	2244-N1TG1	N/A	05/16/2014	05/15/2015

6.4 Measurement Results:

Refer to attached data chart.

Spectrum Detector:	PK	Test Date :	November 20, 2014
Test By:	Andy	Temperature :	24°C
Test Result:	PASS	Humidity :	53 %
Modulation:	GFSK		

Channel number	Channel frequency (MHz)	Separation Read Value (kHz)	Separation Limit 20dB Down BW(kHz)
1	2402	1001	>818
40	2441	1001	>818
79	2480	1001	>821

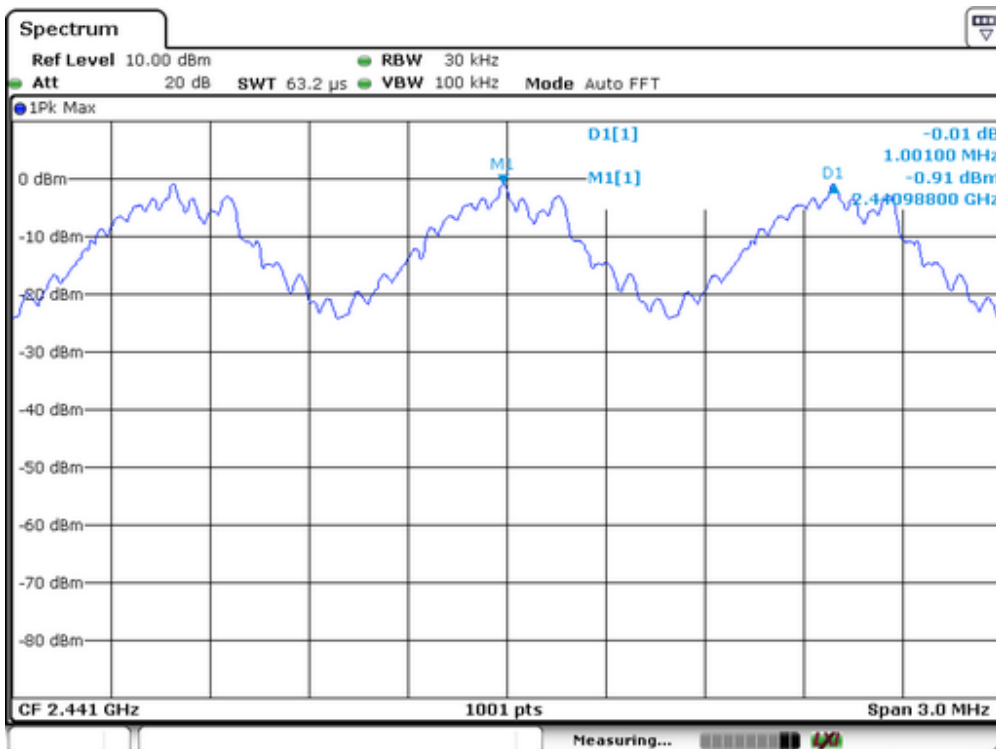
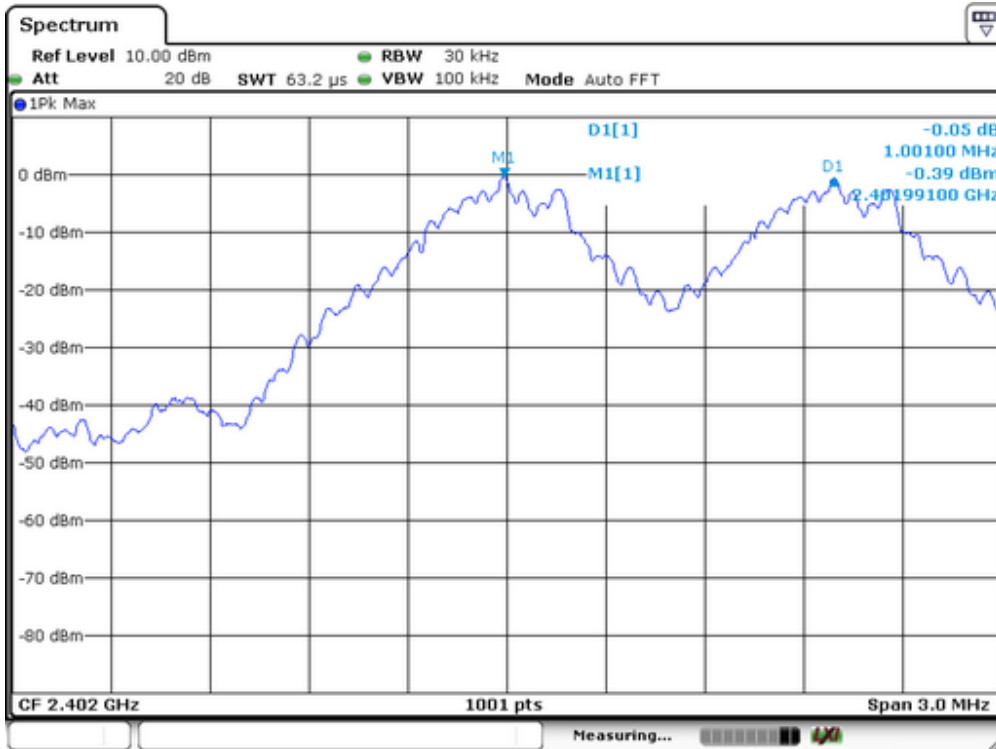

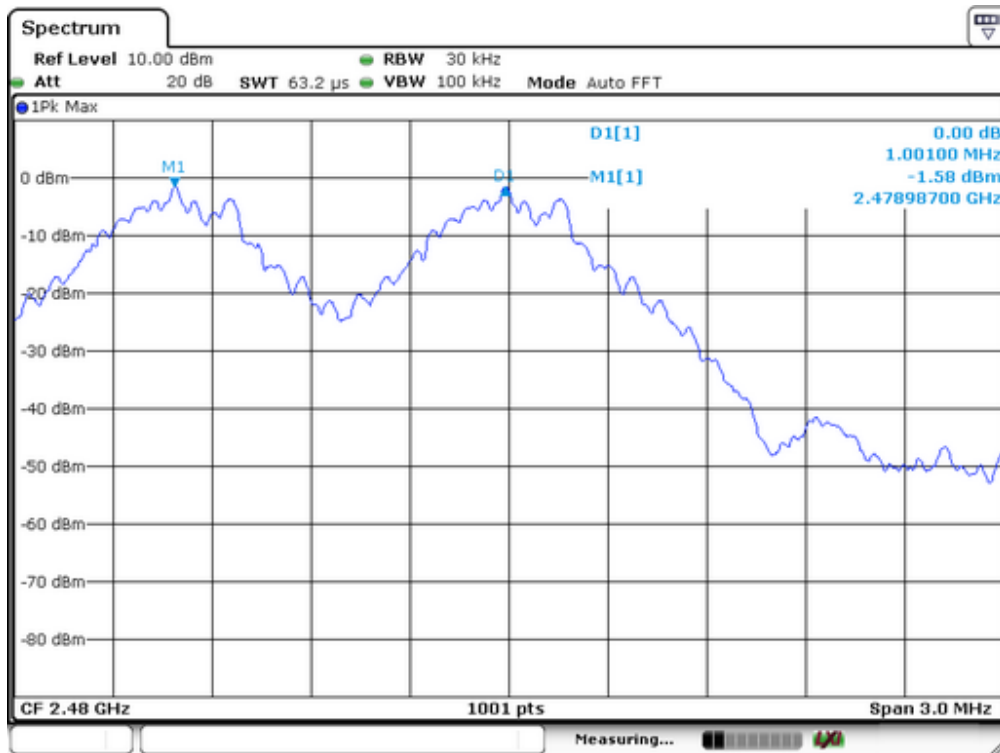

Spectrum Detector: PK Test Date : November 20, 2014
 Test By: Andy Temperature : 24°C
 Test Result: PASS Humidity : 53 %
 Modulation: 1/4 Π -DQPSK

Channel number	Channel frequency (MHz)	Separation Read Value (kHz)	Separation Limit 2/3 20dB Down BW(kHz)
1	2402	1001	>832
40	2441	1001	>838
79	2480	1001	>822

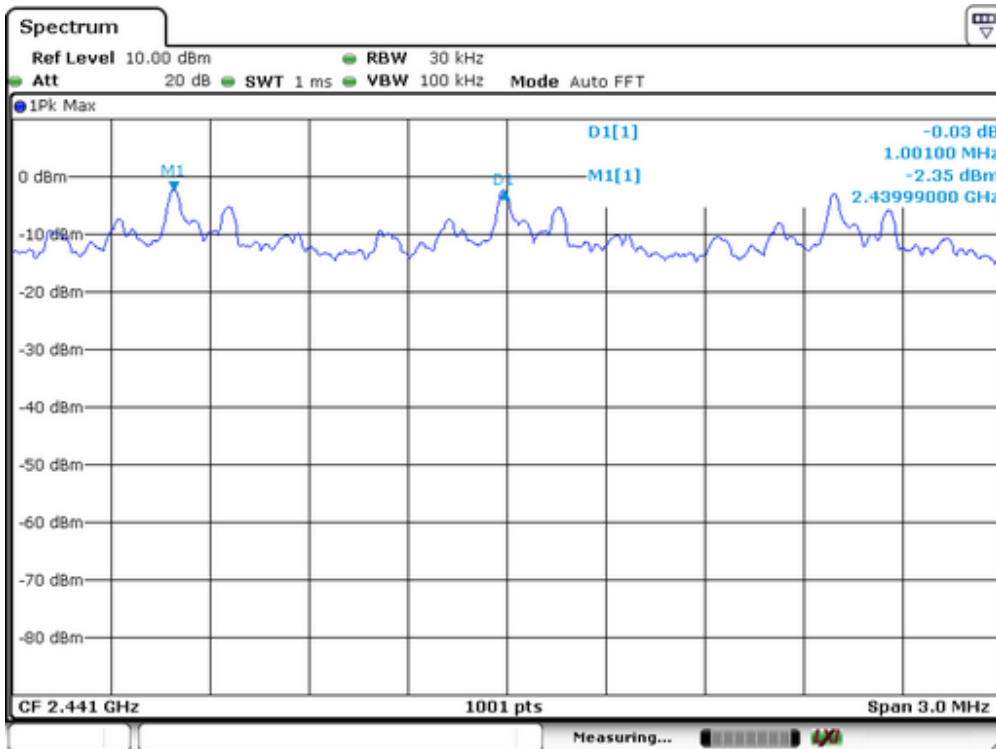
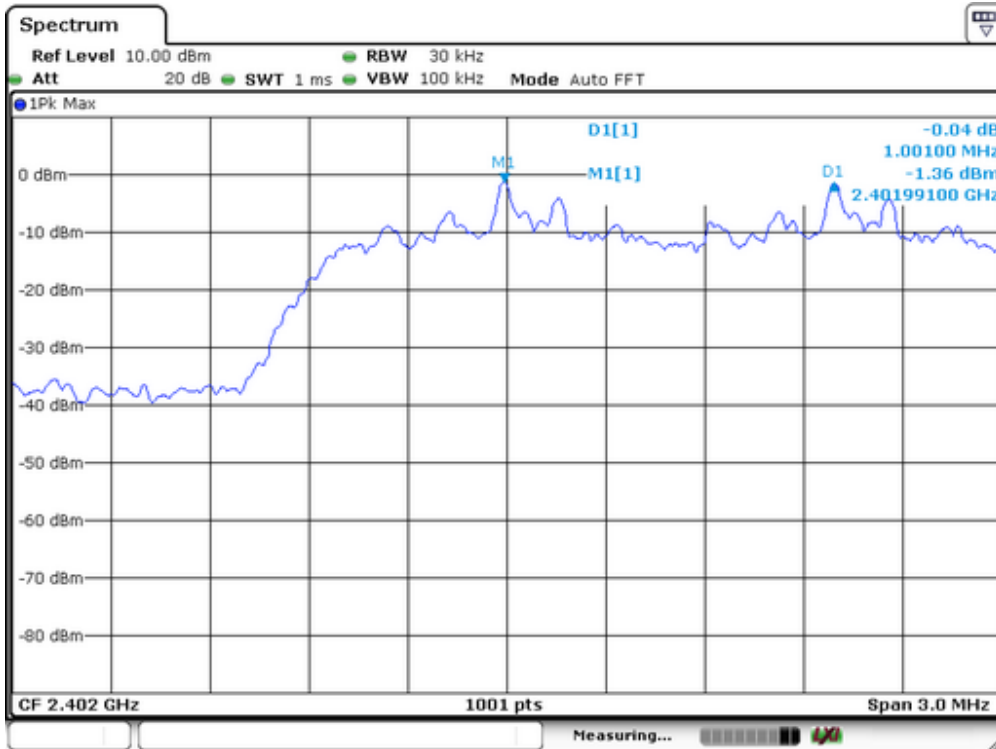

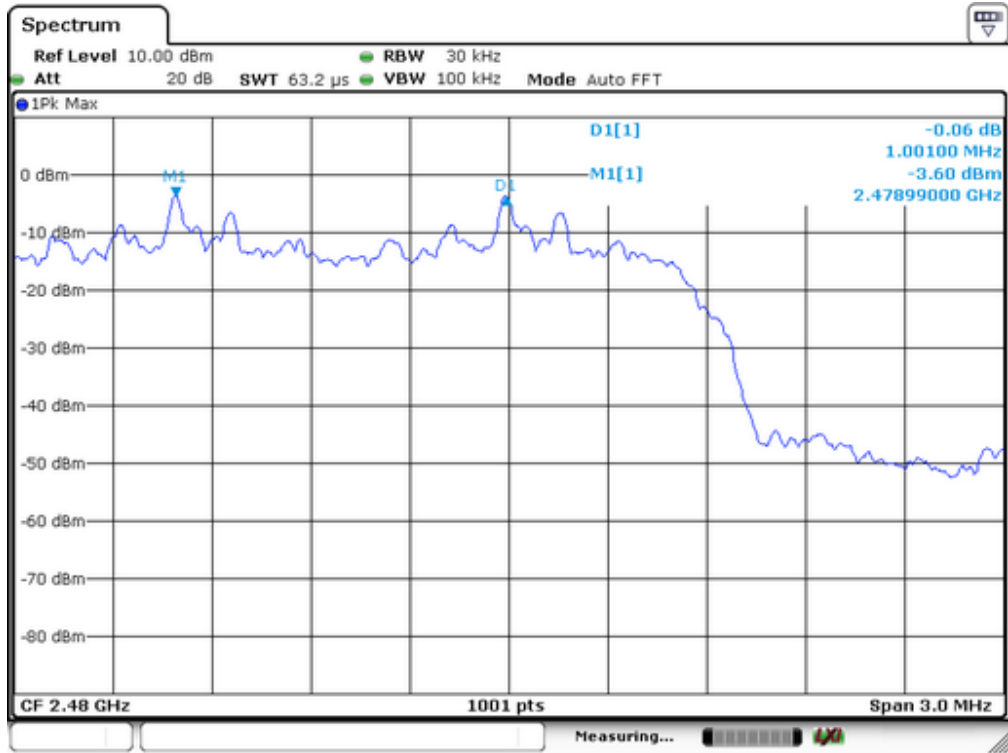

Spectrum Detector: PK Test Date : November 20, 2014
 Test By: Andy Temperature : 24°C
 Test Result: PASS Humidity : 53 %
 Modulation: 8DPSK

Channel number	Channel frequency (MHz)	Separation Read Value (kHz)	Separation Limit 2/3 20dB Down BW(kHz)
1	2402	1001	>808
40	2441	1001	>810
79	2480	1001	>834

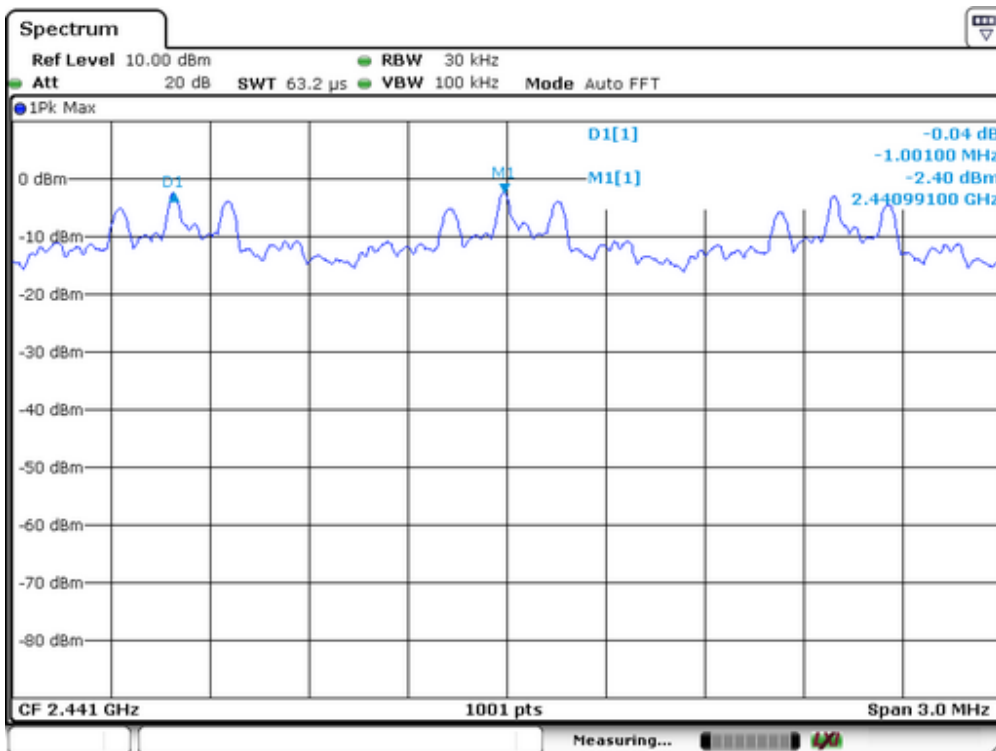
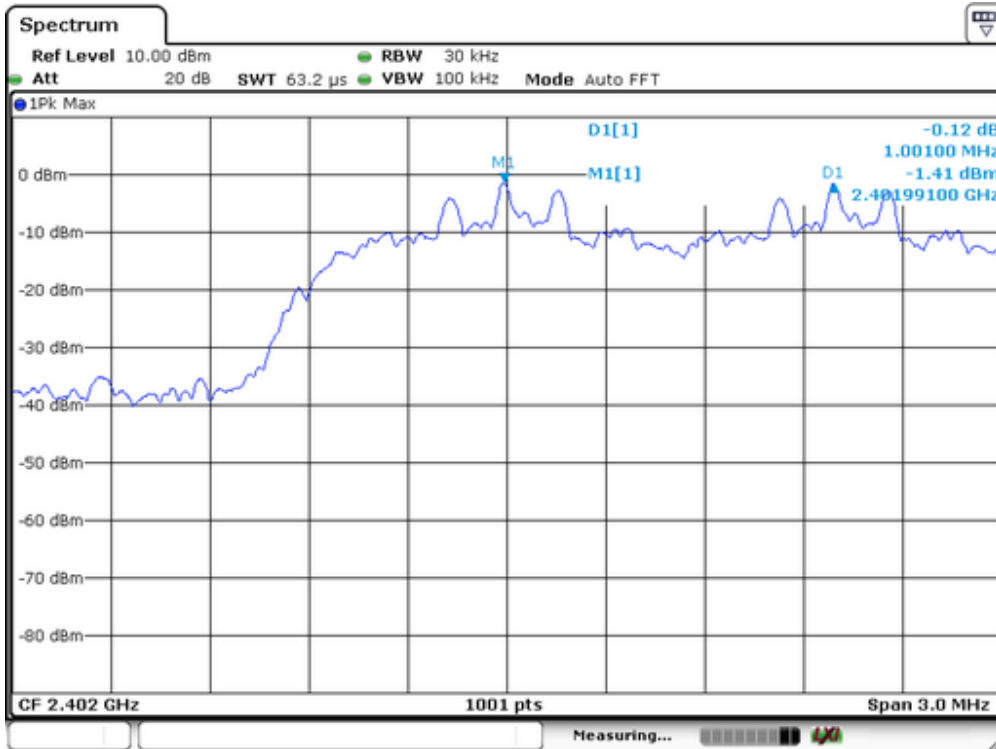

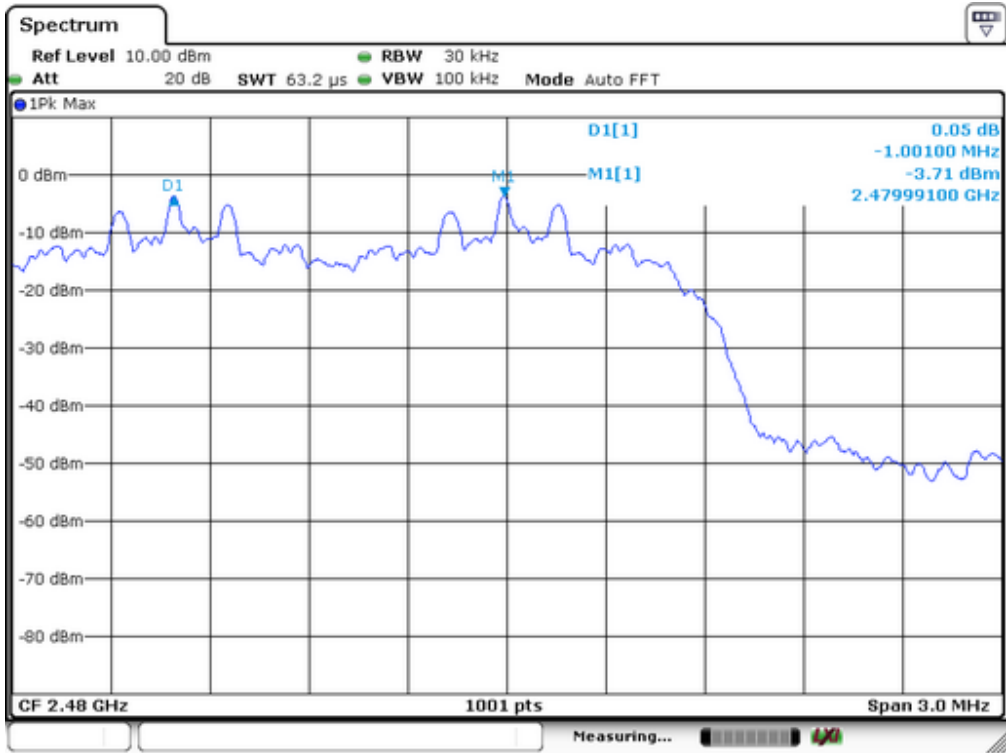

7. 20dB Bandwidth test

7.1 Measurement Procedure

The EUT was operating in hopping mode or could be controlled its channel. Printed out the test result from the spectrum by hard copy function.

7.2 Test SET-UP (Block Diagram of Configuration)

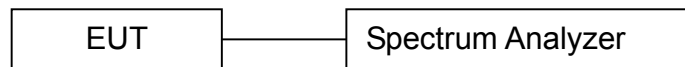

7.3 Measurement Equipment Used:

EQUIPMENT TYPE	MFR	MODEL NUMBER	SERIAL NUMBER	LAST CAL.	CAL DUE.
Spectrum Analyzer	Rohde & Schwarz	FSV30	1321.3008K	05/16/2014	05/15/2015
Coaxial Cable	CDS	79254	46107086	05/16/2014	05/15/2015
Antenna Connector	ARTHUR-YANG	2244-N1TG1	N/A	05/16/2014	05/15/2015

7.4 Measurement Results:

Refer to attached data chart.

Spectrum Detector:	PK	Test Date :	November 20, 2014
Test By:	Andy	Temperature :	25 °C
Test Result:	PASS	Humidity :	50 %
Modulation:	GFSK		

Channel number	Channel frequency (MHz)	20dB Down BW(KHz)
1	2402	818
40	2441	818
79	2480	821

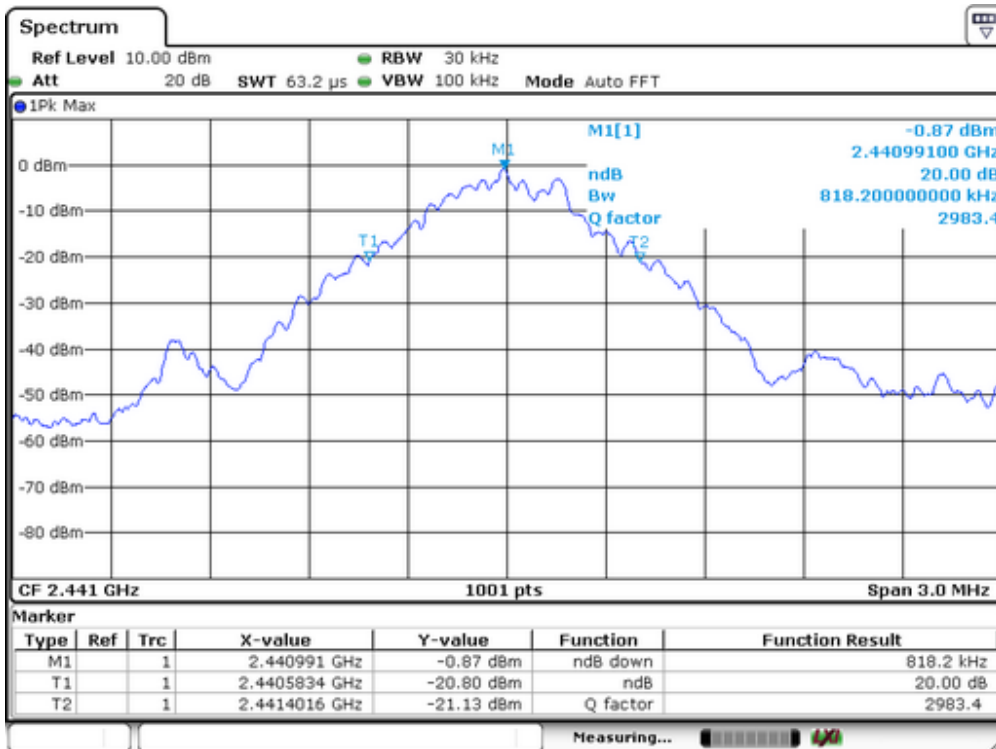
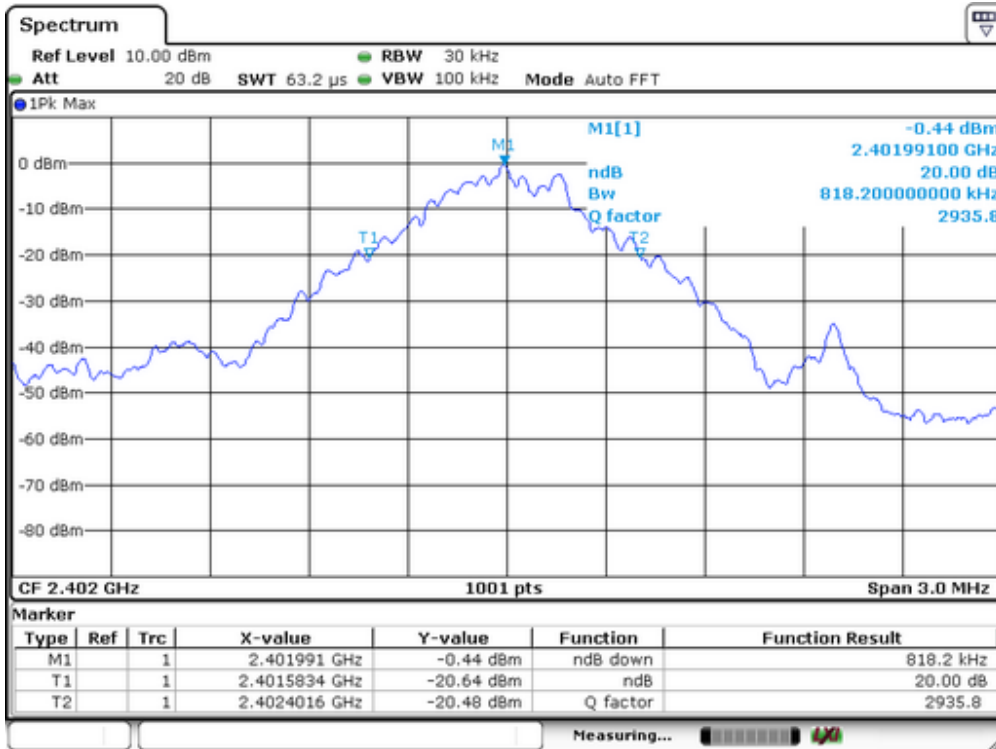

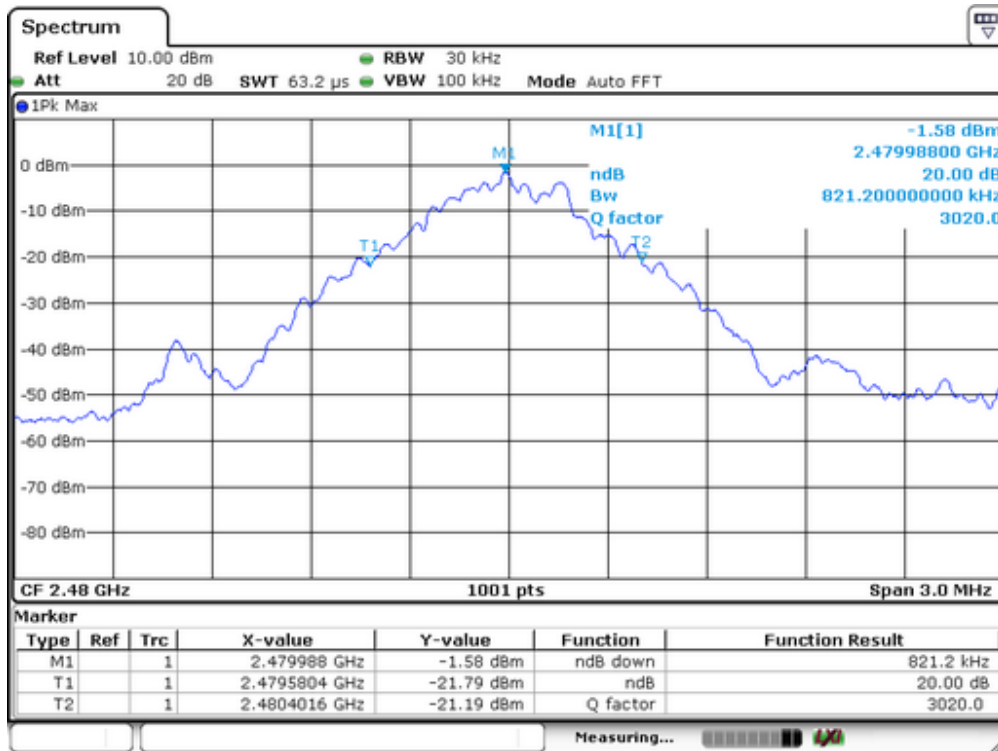

Spectrum Detector: PK Test Date : November 20, 2014
 Test By: Andy Temperature : 24°C
 Test Result: PASS Humidity : 53 %
 Modulation: $\Pi/4$ -DQPSK

Channel number	Channel frequency (MHz)	20dB Down BW(kHz)
1	2402	1234
40	2441	1258
79	2480	1237

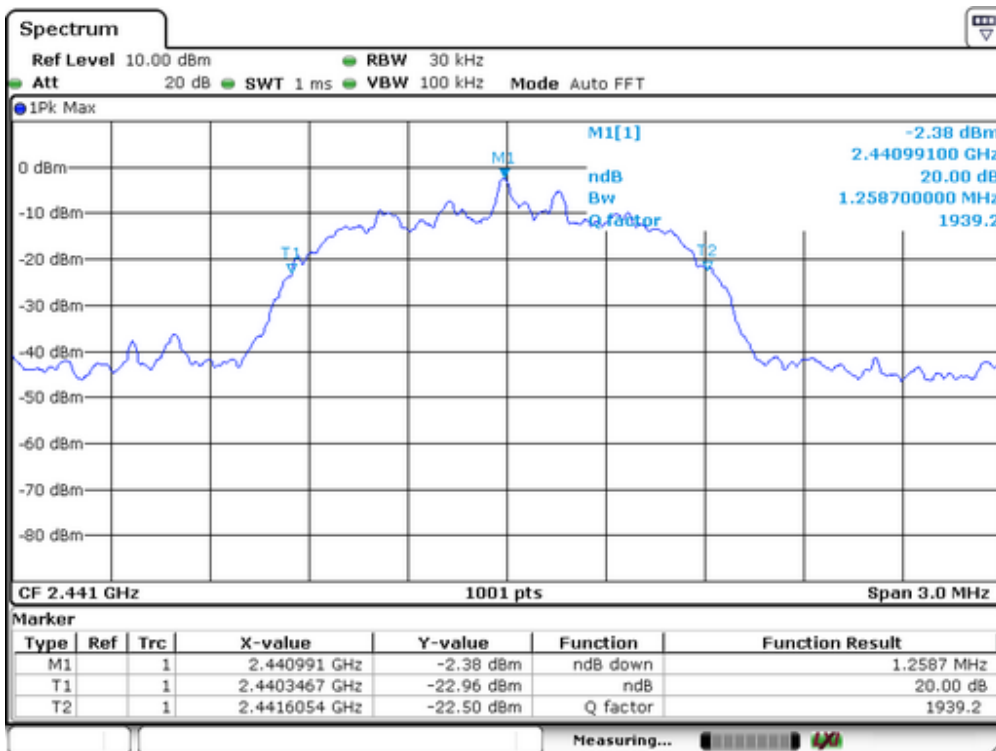
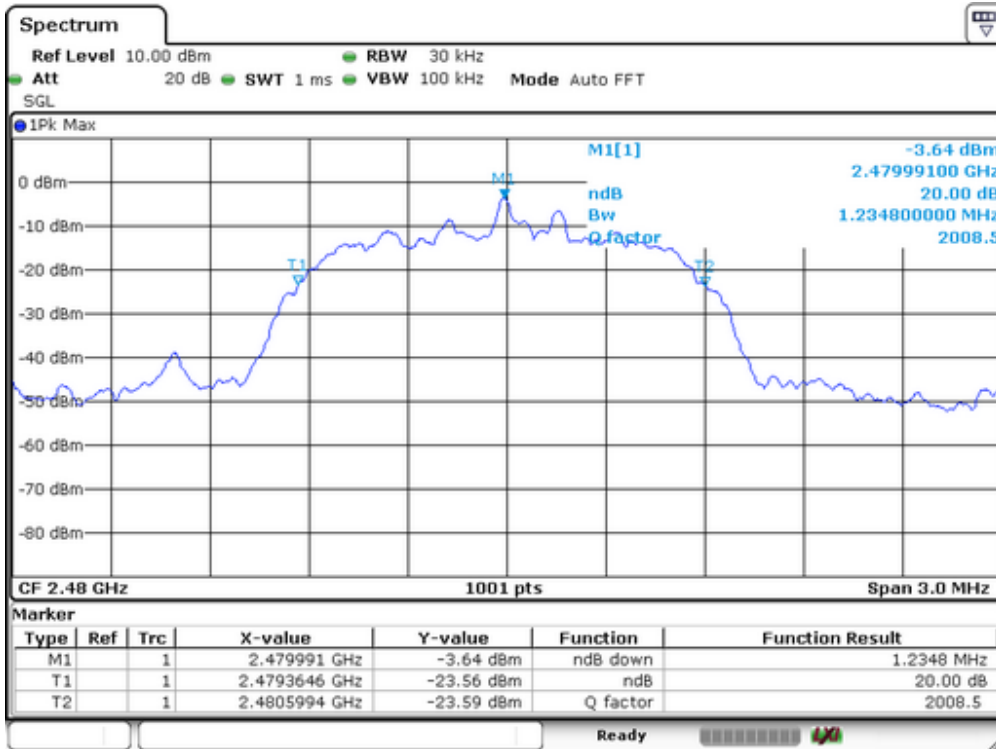

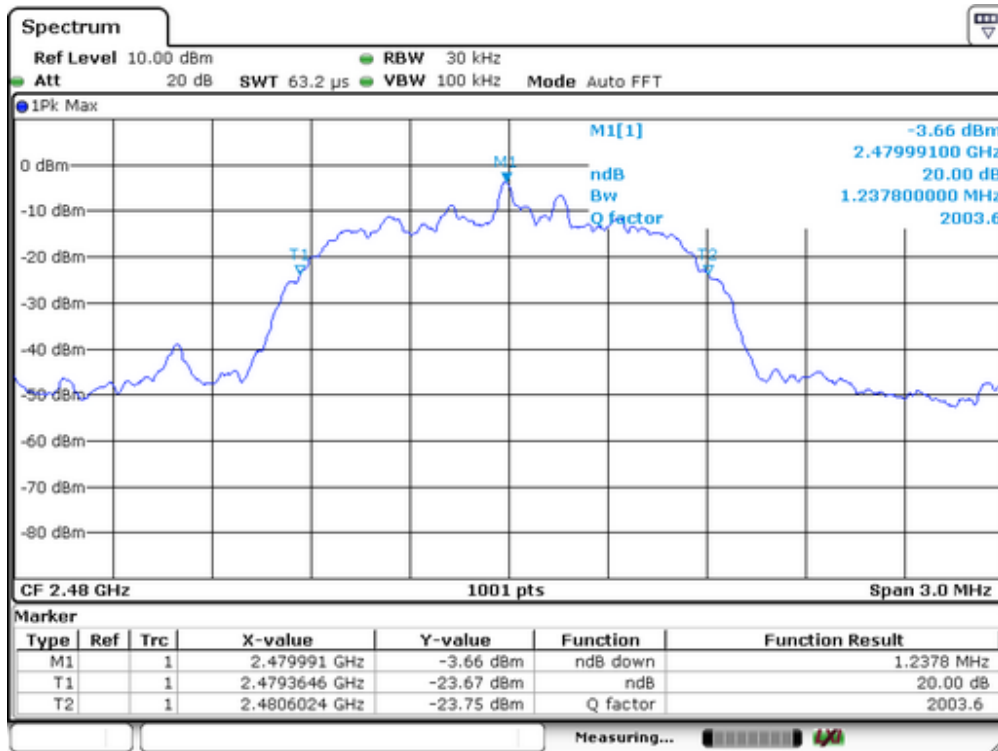

Spectrum Detector: PK Test Date : November 20, 2014
 Test By: Andy Temperature : 24°C
 Test Result: PASS Humidity : 53 %
 Modulation: 8DPSK

Channel number	Channel frequency (MHz)	20dB Down BW(kHz)
1	2402	1213
40	2441	1216
79	2480	1252

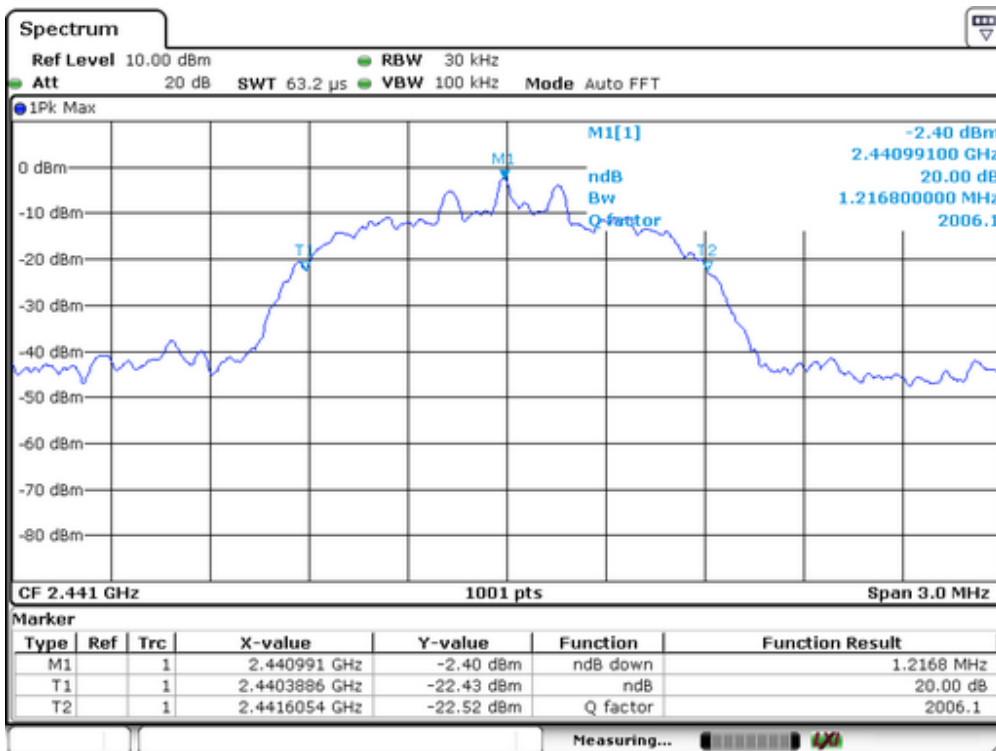
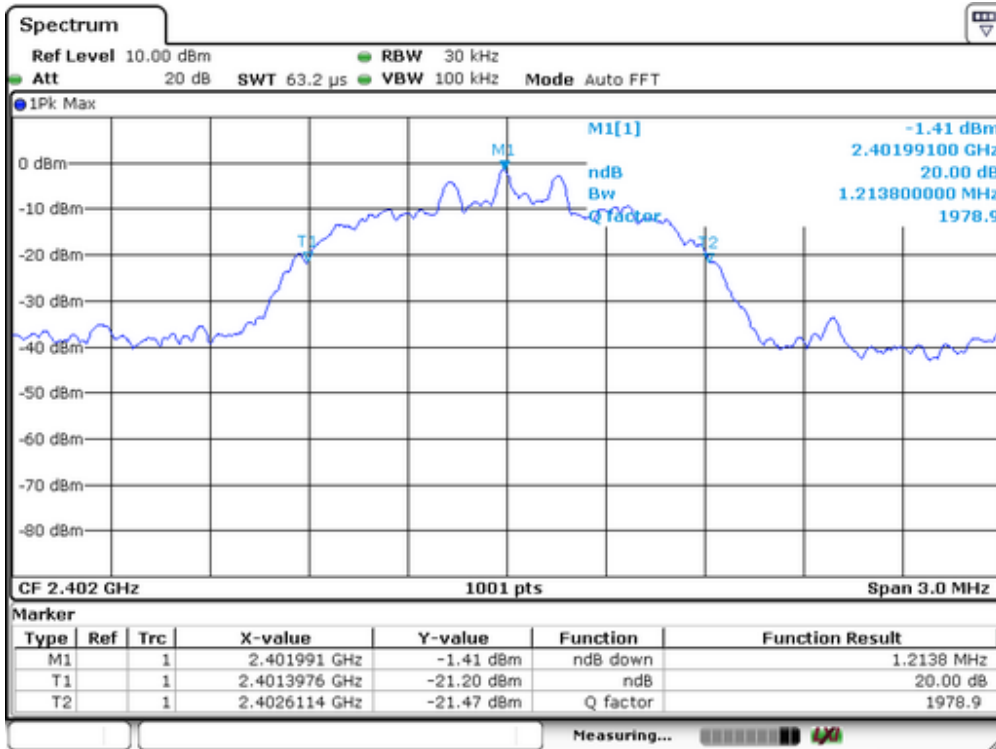

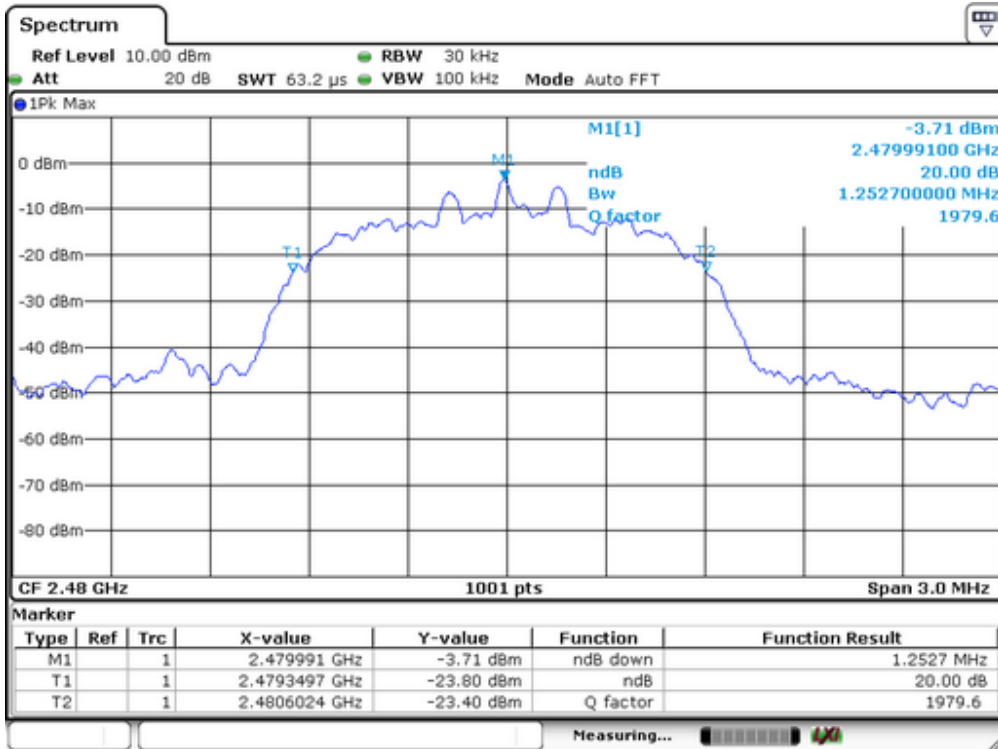

8. Quantity of Hopping Channel Test

8.1 Measurement Procedure

The EUT was operating in hopping mode or could be controlled its channel. Printed out the test result from the spectrum by hard copy function.

8.2 Test SET-UP (Block Diagram of Configuration)

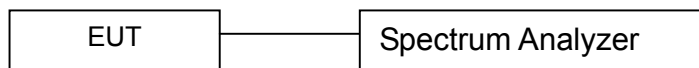

8.3 Measurement Equipment Used:

EQUIPMENT TYPE	MFR	MODEL NUMBER	SERIAL NUMBER	LAST CAL.	CAL DUE.
Spectrum Analyzer	Rohde & Schwarz	FSV30	1321.3008K	05/16/2014	05/15/2015
Coaxial Cable	CDS	79254	46107086	05/16/2014	05/15/2015
Antenna Connector	ARTHUR-YANG	2244-N1TG1	N/A	05/16/2014	05/15/2015

8.4 Measurement Results:

Refer to attached data chart.

Worst Test Mode	GFSK	Test Date :	November 20, 2014
Test By:	Andy	Temperature :	25 °C
Test Result:	PASS	Humidity :	50 %

Hopping Channel Frequency Range	Quantity of Hopping Channel	Quantity of Hopping Channel
2402-2480	79	> 15

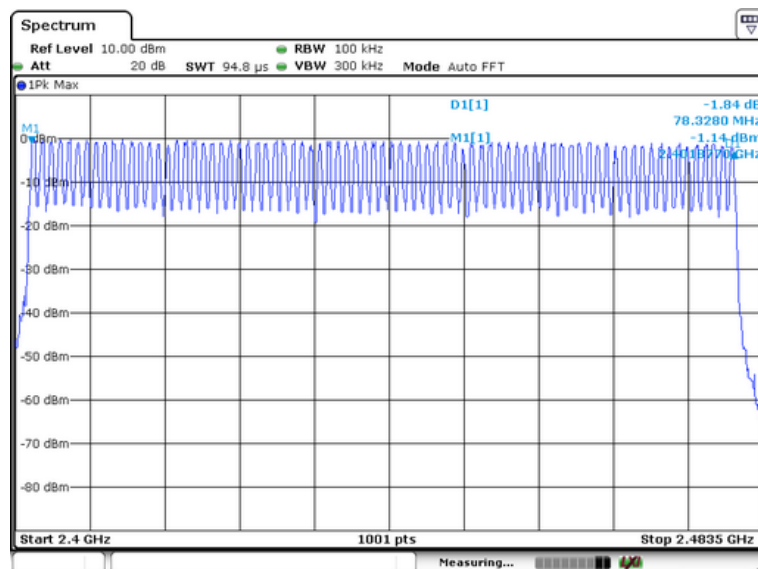

9. Time of Occupancy (Dwell Time) test

9.1 Test Description

The Equipment Under Test (EUT) was set up to perform the dwell time measurements. The EUT was connected to the spectrum analyzer via a short coax cable. The dwell time is calculated by:

$$\text{Dwell time} = \text{time slot length} * \text{hop rate} / \text{number of hopping channels} * 31.6\text{s}$$

with:

- hop rate = $1600/2 * 1/\text{s}$ for DH1 packets = 1600 s^{-1}
- hop rate = $1600/4 * 1/\text{s}$ for DH3 packets = 533.33 s^{-1}
- hop rate = $1600/6 * 1/\text{s}$ for DH5 packets = 320 s^{-1}
- number of hopping channels = 79
- $31.6 \text{ s} = 0.4 \text{ seconds multiplied by the number of hopping channels} = 0.4 \text{ s} * 79$

The highest value of the dwell time is reported.

9.2 Test SET-UP (Block Diagram of Configuration)

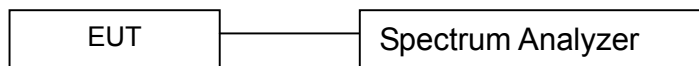

9.3 Measurement Equipment Used:

EQUIPMENT TYPE	MFR	MODEL NUMBER	SERIAL NUMBER	LAST CAL.	CAL DUE.
Spectrum Analyzer	Rohde & Schwarz	FSV30	1321.3008K	05/16/2014	05/15/2015
Coaxial Cable	CDS	79254	46107086	05/16/2014	05/15/2015
Antenna Connector	ARTHUR-YANG	2244-N1TG1	N/A	05/16/2014	05/15/2015

9.4 Test Requirements / Limits

FCC Part 15, Subpart C, §15.247 (a) (1) (iii)

Frequency hopping systems in the 2400-2483.5 MHz band shall use at least 15 channels. The average time of occupancy on any channel shall not be greater than 0.4 seconds within a period of 0.4 seconds multiplied by the number of hopping channels employed. Since the Bluetooth technology uses 79 channels this period is calculated to be 31.6seconds. Refer to attached data chart.

9.5 Measurement Results:

Packet type	Time slot length(ms)	Dwell time	Dwell time(ms)
DH1	0.420	time slot length *1600/2 /79 * 31.6	134.40
DH3	1.677	time slot length *1600/4 /79 * 31.6	268.32
DH5	2.920	time slot length *1600/6 /79 * 31.6	311.47
Remark: The results of worst cased was recorded.			

Test Plot:

DH1:

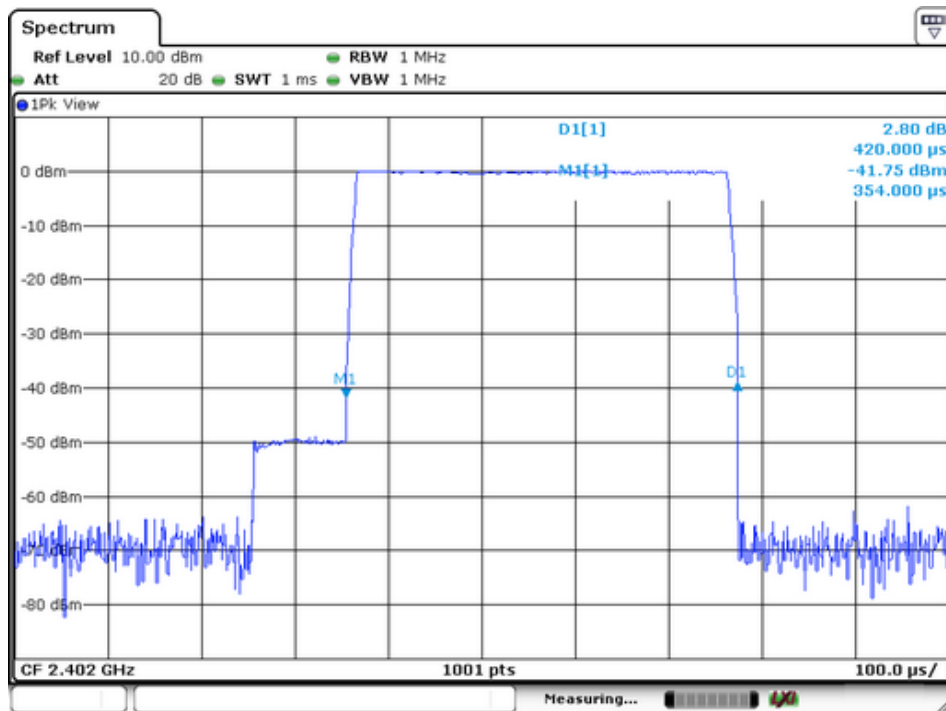

DH3:

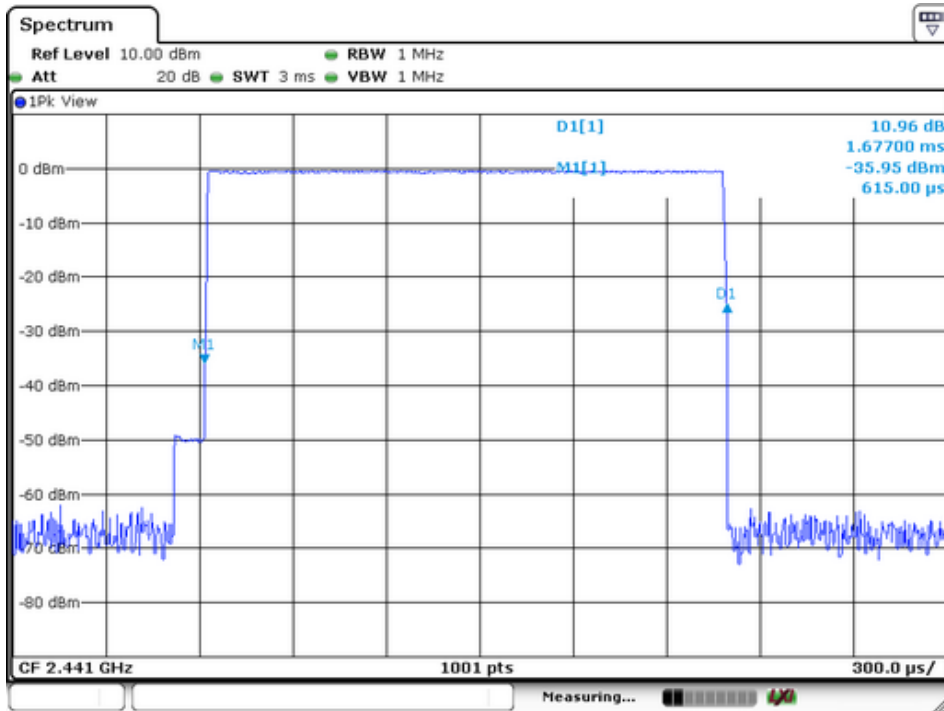

DH5:

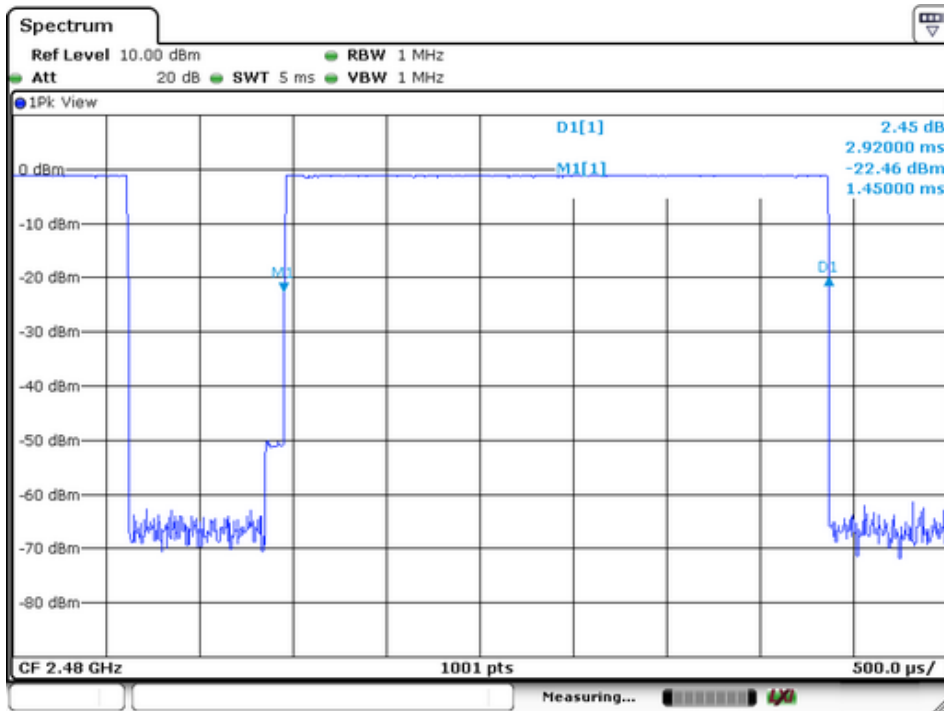

10. MAXIMUM PEAK OUTPUT POWER TEST

10.1 Measurement Procedure

- a. Check the calibration of the measuring instrument(SA) using either an internal calibrator or a known signal from an external generator.
- b. Turn on the EUT and connect it to measurement instrument. Then set it to any one convenient frequency within its operating range. Set a reference level on the measuring instrument equal to the highest peak value.
- c. The center frequency of the spectrum analyzer is set to the fundamental frequency and using proper RBW and VBW setting.
- d. Measure the captured power within the band and recording the plot.
- e. Repeat above procedures until all frequencies required were complete.

10.2 Test SET-UP (Block Diagram of Configuration)

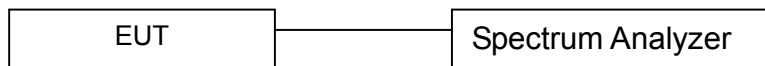

10.3 Measurement Equipment Used:

EQUIPMENT TYPE	MFR	MODEL NUMBER	SERIAL NUMBER	LAST CAL.	CAL DUE.
Spectrum Analyzer	Rohde & Schwarz	FSV30	1321.3008K	05/16/2014	05/15/2015
Coaxial Cable	CDS	79254	46107086	05/16/2014	05/15/2015
Antenna Connector	ARTHUR-YANG	2244-N1TG1	N/A	05/16/2014	05/15/2015

10.4 Measurement Results:

Refer to attached data chart.

Spectrum Detector:	PK	Test Date :	November 20, 2014
Test By:	Andy	Temperature :	25 °C
Test Result:	PASS	Humidity :	50 %
Modulation:	GFSK		

Channel number	Channel Frequency (MHz)	Peak Power output(dBm)	Peak Power output(mW)	Peak Power Limit(mW)	Pass/Fail
01	2402	0.03	1.007	1000	PASS
40	2441	-0.49	0.893	1000	PASS
79	2480	-1.17	0.764	1000	PASS

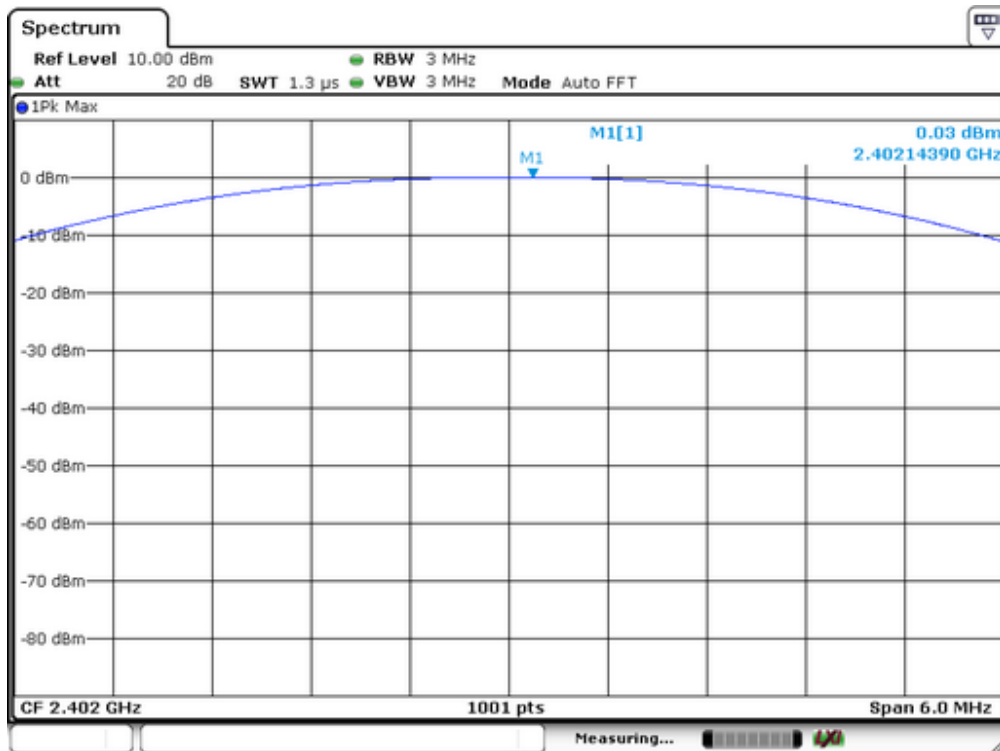

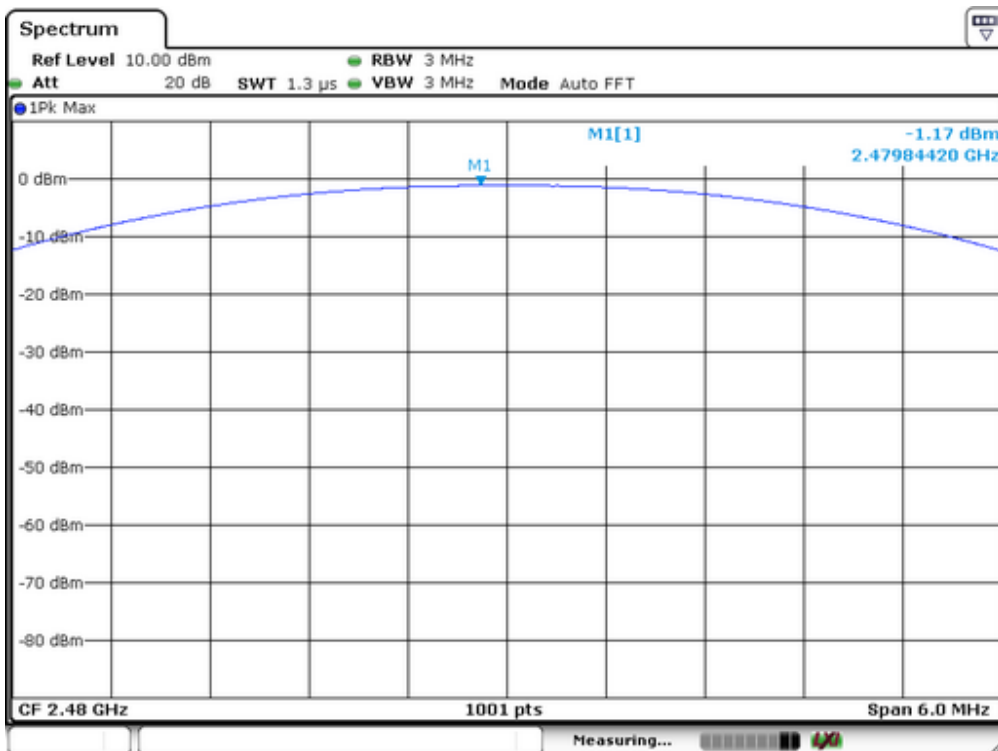
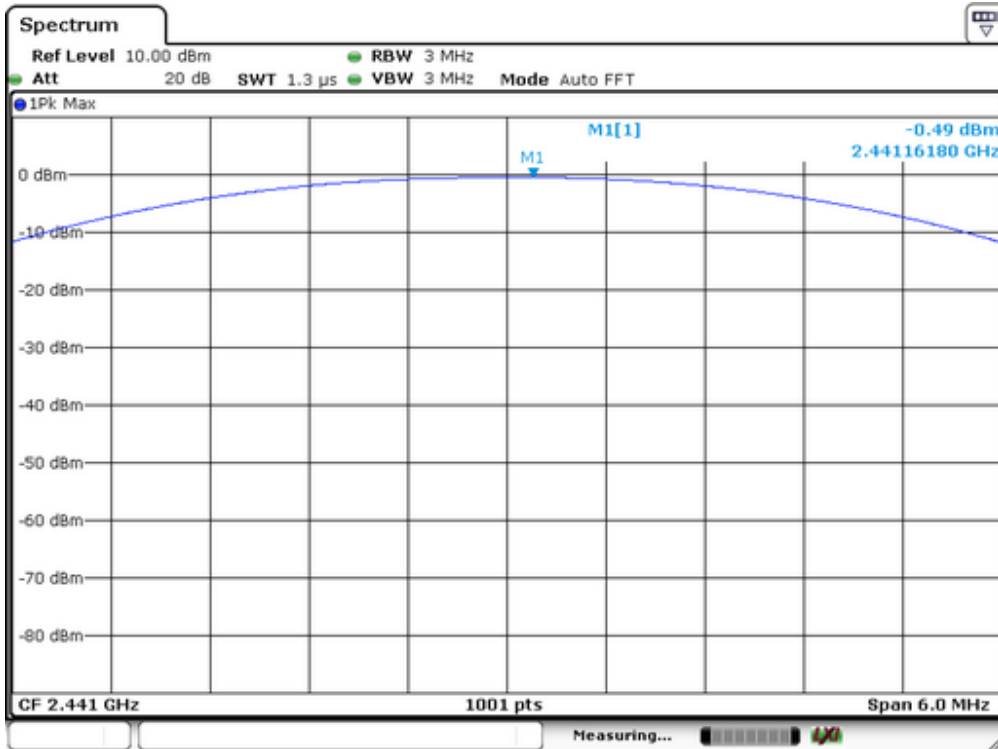

Spectrum Detector: PK Test Date : November 20, 2014
 Test By: Andy Temperature : 25 °C
 Test Result: PASS Humidity : 50 %
 Modulation: Π/4-DQPSK

Channel number	Channel Frequency (MHz)	Peak Power output(dBm)	Peak Power output(mW)	Peak Power Limit(mW)	Pass/Fail
01	2402	-0.63	0.865	125	PASS
40	2441	-1.58	0.695	125	PASS
79	2480	-2.65	0.543	125	PASS

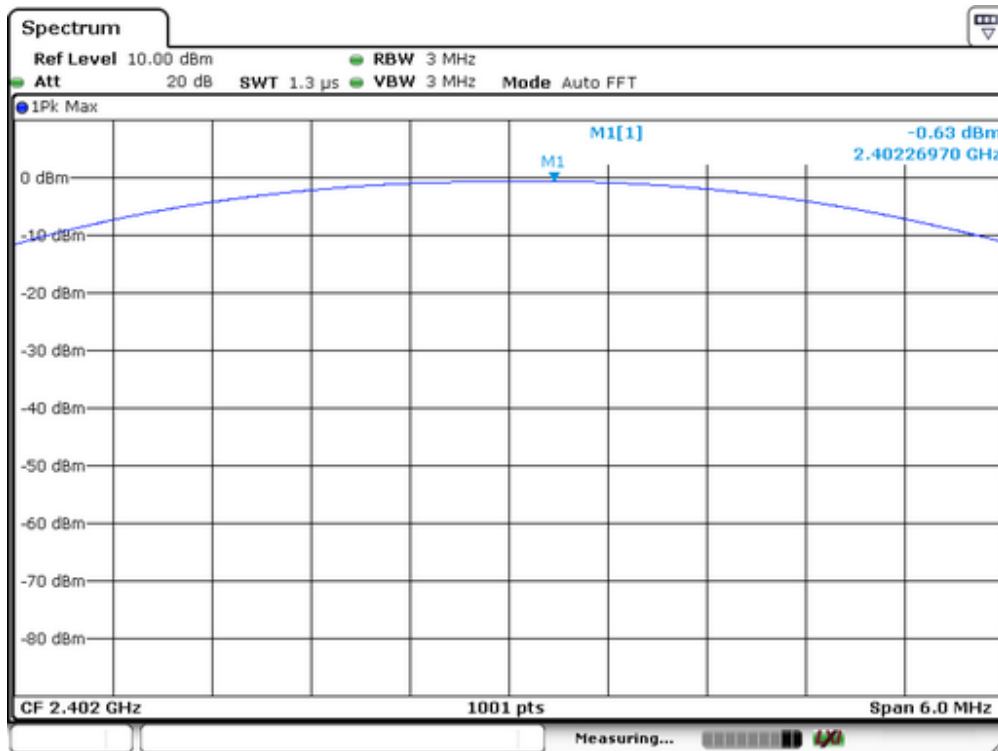

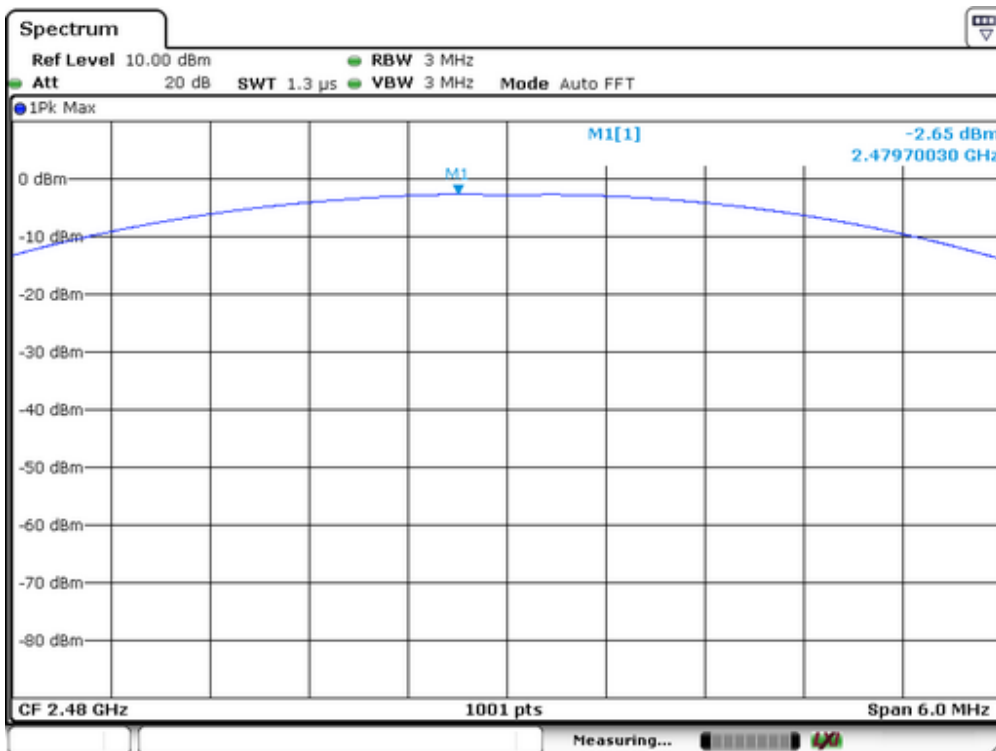
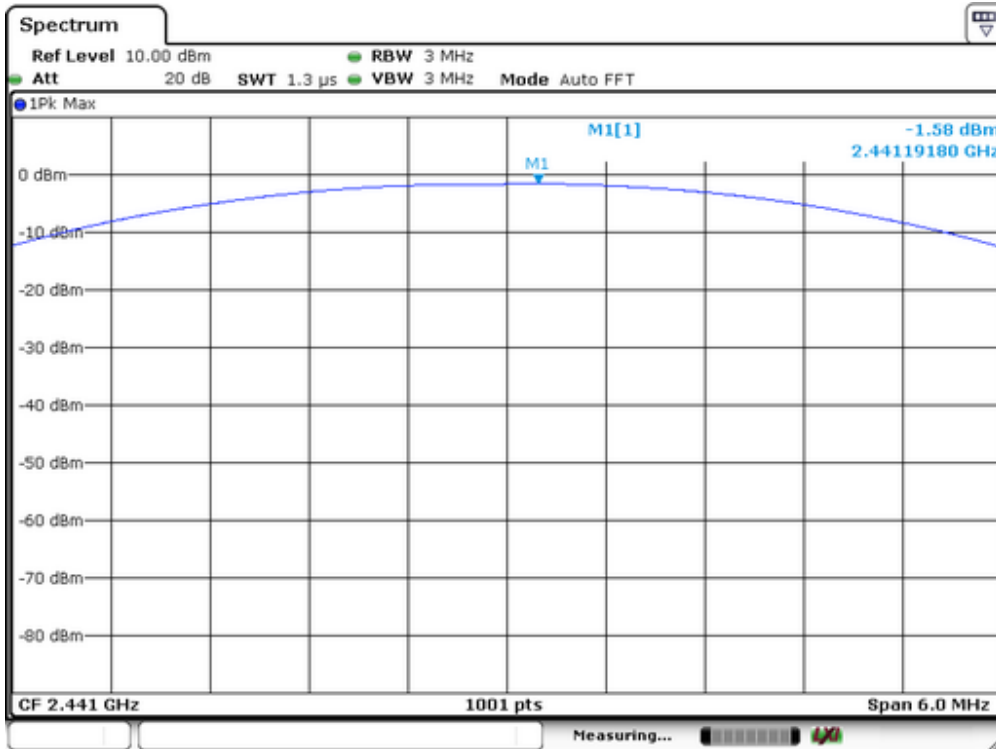

Spectrum Detector: PK
 Test By: Andy
 Test Result: PASS
 Modulation: 8DPSK

Test Date : November 20, 2014
 Temperature : 25 °C
 Humidity : 50 %

Channel number	Channel Frequency (MHz)	Peak Power output(dBm)	Peak Power output(mW)	Peak Power Limit(mW)	Pass/Fail
01	2402	-0.54	0.883	125	PASS
40	2441	-1.41	0.723	125	PASS
79	2480	-2.4	0.575	125	PASS

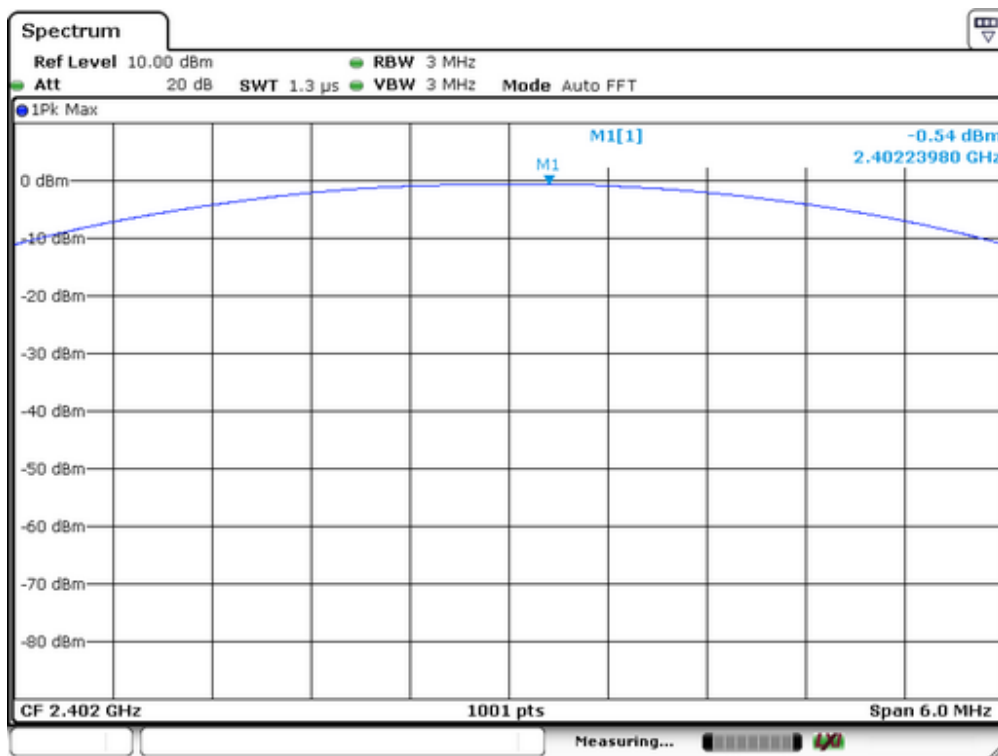

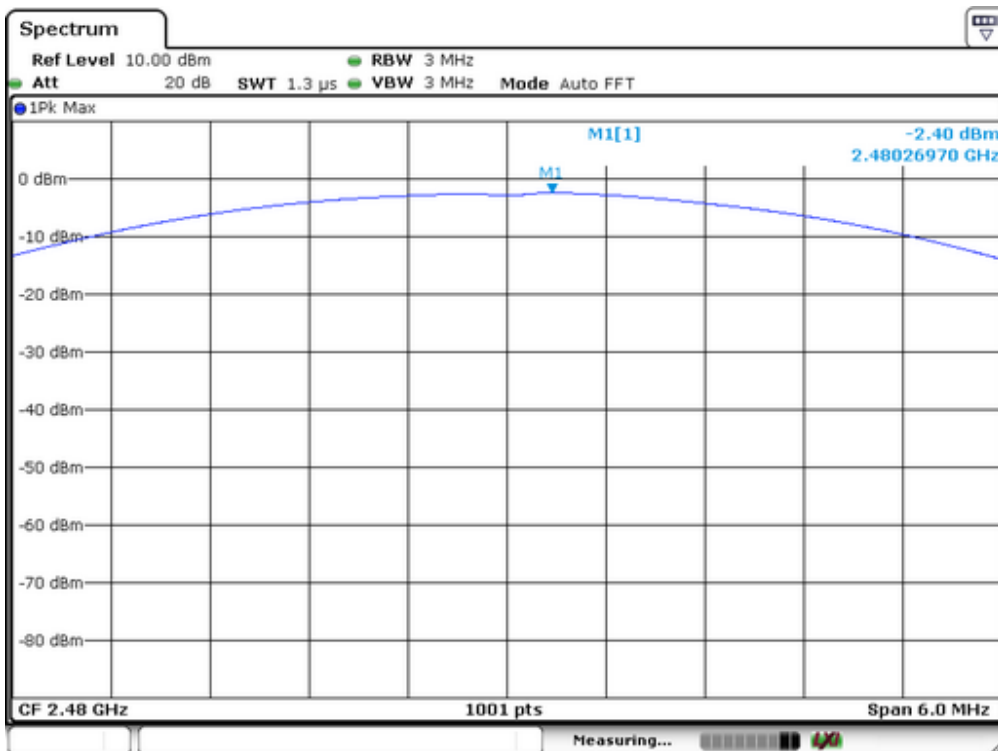
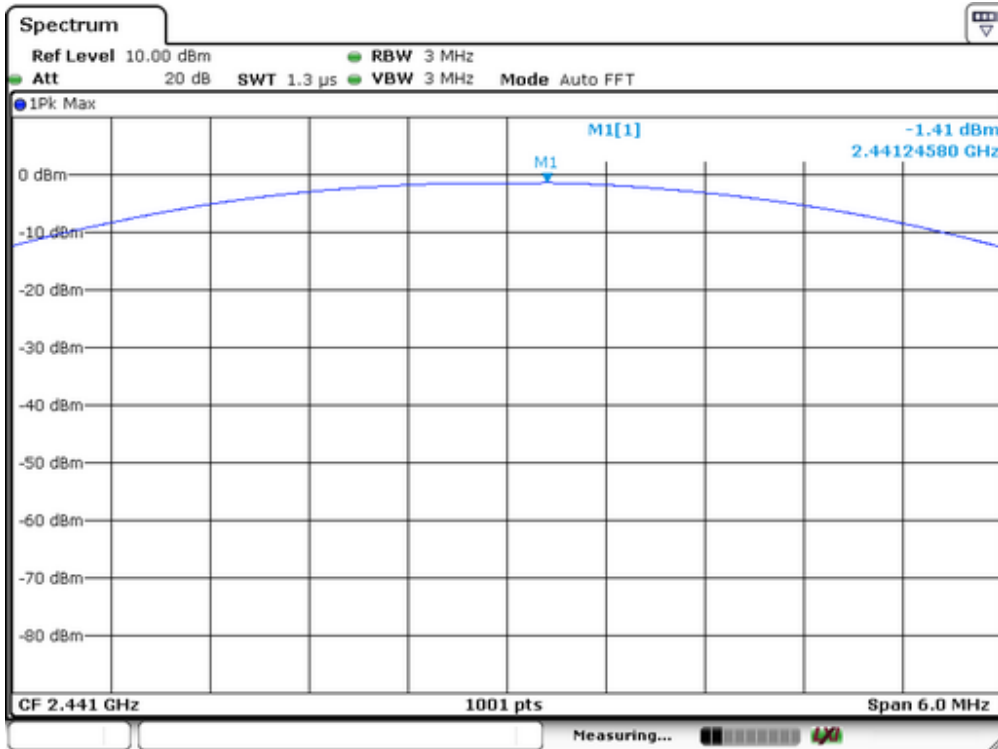

11. Band EDGE test

11.1 Measurement Procedure

1. The EUT was Operating in hopping mode or could be controlled its channel. Printed out test result from the spectrum by hard copy function.
2. The EUT was placed on a turn table which is 0.8m above ground plane.
3. Maximum procedure was performed on the six highest emissions to ensure EUT compliance.
4. And also, each emission was to be maximized by changing the polarization of receiving antenna both horizontal and vertical.
5. Repeat above procedures until all frequency measured were complete.
6. Use the following spectrum analyzer settings:

When spectrum scanned above 1GHz setting resolution bandwidth 1MHz, video bandwidth 3MHz:

EMI Test Receiver	Setting
Attenuation	Auto
RB	1MHz
VB	3MHz
Detector	Peak
Trace	Max hold

When spectrum scanned above 1GHz setting resolution bandwidth 1MHz, video bandwidth 10Hz:

EMI Test Receiver	Setting
Attenuation	Auto
RB	1MHz
VB	10Hz
Detector	Peak
Trace	Max hold

11.2 Test SET-UP (Block Diagram of Configuration)

For Conducted Test

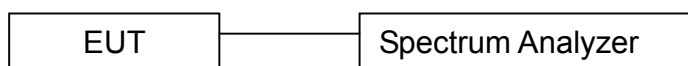

For Radiated emission Test

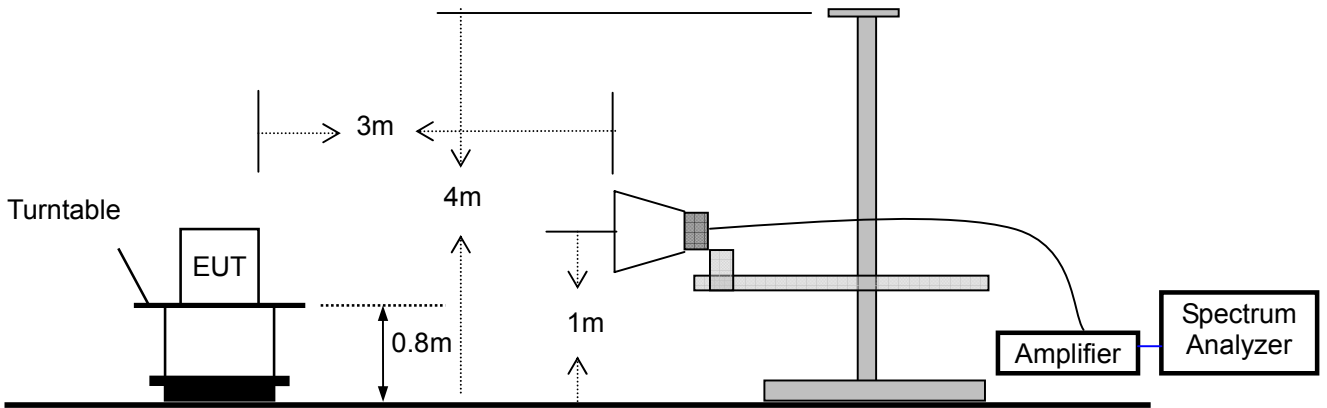

11.3 Measurement Equipment Used:

For Conducted Test

EQUIPMENT TYPE	MFR	MODEL NUMBER	SERIAL NUMBER	LAST CAL.	CAL DUE.
Spectrum Analyzer	Rohde & Schwarz	FSV30	1321.3008K	05/16/2014	05/15/2015
Coaxial Cable	CDS	79254	46107086	05/16/2014	05/15/2015
Antenna Connector	ARTHUR-YANG	2244-N1TG1	N/A	05/16/2014	05/15/2015

For Radiated emission Test

EQUIPMENT TYPE	MFR	MODEL NUMBER	SERIAL NUMBER	LAST CAL.	CAL DUE.
EMI Test Receiver	Rohde & Schwarz	ESU	1302.6005.26	05/16/2014	05/15/2015
Pre-Amplifier	HP	8447D	2944A07999	05/16/2014	05/15/2015
Bilog Antenna	SCHWARZBECK	VULB9163	142	05/16/2014	05/15/2015
Loop Antenna	ARA	PLA-1030/B	1029	05/16/2014	05/15/2015
Horn Antenna	Schwarzbeck	BBHA9170	BBHA9170399	05/16/2014	05/15/2015
Horn Antenna	Schwarzbeck	BBHA9120D	D143	05/16/2014	05/15/2015
Cable	Schwarzbeck	AK9513	ACRX1	05/19/2014	05/18/2015
Cable	Schwarzbeck	N/A	FP2RX2	05/19/2014	05/18/2015
Cable	Schwarzbeck	AK9513	CRPX1	05/19/2014	05/18/2015
Cable	Schwarzbeck	AK9513	CRRX2	05/19/2014	05/18/2015

11.4 Measurement Results:

Refer to attached data chart.

Spectrum Detector: PK Test Date : November 20, 2014
 Test By: Andy Temperature : 25 °C
 Test Result: PASS Humidity : 50 %

1. Conducted Test

For Non-Hopping Mode:

Frequency (MHz)	Modulation	Peak Power Output(dBm)	Emission read Value(dBm)	Result of Band edge(dBc)	Band edge Limit(dBc)
2399.99	GFSK	-0.06	-40.6	40.54	>20dBc
2399.98	pi/4-DQPSK	-1.08	-41.09	40.01	>20dBc
2399.98	8DPSK	-1.1	-41.83	40.73	>20dBc
2483.98	GFSK	-1.19	-57.72	56.53	>20dBc
2484.00	pi/4-DQPSK	-3.38	-57.19	53.81	>20dBc
2484.01	8DPSK	-3.36	-56.90	53.54	>20dBc

For Hopping Mode:

Frequency (MHz)	Modulation	Peak Power Output(dBm)	Emission read Value(dBm)	Result of Band edge(dBc)	Band edge Limit(dBc)
2399.98	GFSK	-0.09	-41.69	41.6	>20dBc
2399.98	pi/4-DQPSK	-1.10	-41.73	40.63	>20dBc
2399.99	8DPSK	-1.13	-42.51	41.38	>20dBc
2486.96	GFSK	-1.23	-60.83	59.6	>20dBc
2483.51	pi/4-DQPSK	-3.40	-57.82	54.42	>20dBc
2484.31	8DPSK	-3.46	-59.29	55.83	>20dBc

2. Radiated emission Test

Worst test modulation GFSK

For Non-Hopping Mode:

Frequency (MHz)	Antenna polarization (H/V)	Emission (dBuV/m)		Band edge Limit (dBuV/m)		Margin (dB)	
		PK	AV	PK	AV	PK	AV
2398.456	H	64.02	43.29	74	54	-9.98	-10.71
2399.157	V	59.42	39.15	74	54	-14.58	-14.85
2484.013	H	65.23	44.05	74	54	-8.77	-9.95
2483.895	V	60.59	38.59	74	54	-13.41	-15.41

For Hopping Mode:

Frequency (MHz)	Antenna polarization (H/V)	Emission (dBuV/m)		Band edge Limit (dBuV/m)		Margin (dB)	
		PK	AV	PK	AV	PK	AV
2399.001	H	66.08	44.05	74	54	-7.92	-9.95
2398.413	V	60.23	39.56	74	54	-13.77	-14.44
2483.753	H	65.18	45.11	74	54	-8.82	-8.89
2484.015	V	59.72	38.07	74	54	-14.28	-15.93

12. Antenna Application

12.1 Antenna requirement

The EUT'S antenna is met the requirement of FCC part 15C section 15.203 and 15.247.

FCC part 15C section 15.247 requirements:

Systems operating in the 2402-2480MHz band that are used exclusively for fixed, point-to-point operations may employ transmitting antennas with directional gain greater than 6dBi provided the maximum peak output power of the intentional radiator is reduced by 1dB for every 3dB that the directional gain of the antenna exceeds 6dBi.

12.2 Result

The EUT used inverted-E antenna. The antenna's gain is 4dBi and meets the requirement.

General Appearance of the EUT

