



TEST REPORT

Report Reference No.: **TRE1709008401** R/C.....: 43719

FCC ID: **2AB7K-Z6000**

Applicant's name: **Anker Technology Co., Limited**

Address: Room 1318-19, Hollywood Plaza, 610 Nathan Road, Mongkok, Kowloon, Hong Kong

Manufacturer.....: Shenzhen 3nod Acousticlink Co., Ltd.

Address.....: 4 /F, And Section A, 1/F, Workshop 15, Zhongfu Road, Tangxiayong Community, Songgang Neighbourhood, Bao'an District, Shenzhen City, Guangdong Rrovince, P.R.C

Test item description: **Zolo Halo**

Trade Mark.....: ZOLO

Model/Type reference: Z6000

Listed Model(s).....: -

Standard.....: **FCC CFR Title 47 Part 15 Subpart C Section 15.247**

Date of receipt of test sample.....: Sept. 13, 2017

Date of testing.....: Sept. 14, 2017 – Sept. 27, 2017

Date of issue.....: Sept. 27, 2017

Result: **PASS**

Compiled by
(position+printed name+signature) ..: File administrators Shayne Zhu

Supervised by
(position+printed name+signature) ..: Project Engineer Jerry Wang

Approved by
(position+printed name+signature) ..: RF Manager Hans Hu

Testing Laboratory Name.....: **Shenzhen Huatongwei International Inspection Co., Ltd.**

Address: 1/F, Bldg 3, Hongfa Hi-tech Industrial Park, Genyu Road, Tianliao, Gongming, Shenzhen, China

Shenzhen Huatongwei International Inspection Co., Ltd. All rights reserved.

This publication may be reproduced in whole or in part for non-commercial purposes as long as the Shenzhen Huatongwei International Inspection Co., Ltd. is acknowledged as copyright owner and source of the material. Shenzhen Huatongwei International Inspection Co., Ltd. takes no responsibility for and will not assume liability for damages resulting from the reader's interpretation of the reproduced material due to its placement and context.

*The test report merely corresponds to the test sample.
It is not permitted to copy extracts of these test result without the written permission of the test laboratory.*

Contents

1.	<u>TEST STANDARDS AND REPORT VERSION</u>	3
1.1.	Test Standards	3
1.2.	Report version	3
2.	<u>TEST DESCRIPTION</u>	4
3.	<u>SUMMARY</u>	5
3.1.	Client Information	5
3.2.	Product Description	5
3.3.	Operation state	6
3.4.	EUT configuration	6
3.5.	Modifications	6
4.	<u>TEST ENVIRONMENT</u>	7
4.1.	Address of the test laboratory	7
4.2.	Test Facility	7
4.3.	Equipments Used during the Test	8
4.4.	Environmental conditions	9
4.5.	Statement of the measurement uncertainty	9
5.	<u>TEST CONDITIONS AND RESULTS</u>	10
5.1.	Antenna requirement	10
5.2.	Conducted Emissions (AC Main)	11
5.3.	Conducted Peak Output Power	14
5.4.	Power Spectral Density	15
5.5.	6dB bandwidth	19
5.6.	Restricted band	23
5.7.	Band edge and Spurious Emission (conducted)	28
5.8.	Spurious Emissions (radiated)	33
6.	<u>TEST SETUP PHOTOS OF THE EUT</u>	40
7.	<u>EXTERNAL AND INTERNAL PHOTOS OF THE EUT</u>	42

1. Test standards and Report version

1.1. Test Standards

The tests were performed according to following standards:

[FCC Rules Part 15.247](#): Frequency Hopping, Direct Spread Spectrum and Hybrid Systems that are in operation within the bands of 902-928 MHz, 2400-2483.5 MHz, and 5725-5850 MHz.

[ANSI C63.10:2013](#): American National Standard for Testing Unlicensed Wireless Devices

[KDB558074 D01 DTS Meas Guidance v04](#): Guidance for Performing Compliance Measurements on Digital Transmission Systems (DTS) Operating under §15.247

1.2. Report version

Version No.	Date of issue	Description
00	Sept. 27, 2017	Original

2. Test Description

Test Item	Section in CFR 47	Result	Test Engineer
Antenna requirement	15.203/15.247 (c)	Pass	Baozhu Hu
Line Conducted Emissions (AC Main)	15.207	Pass	Baozhu Hu
Conducted Peak Output Power	15.247 (b)(3)	Pass	Baozhu Hu
Power Spectral Density	15.247 (e)	Pass	Baozhu Hu
6dB Bandwidth	15.247 (a)(2)	Pass	Baozhu Hu
Restricted band	15.247(d)/15.205	Pass	Baozhu Hu
Spurious Emissions	15.247(d)/15.209	Pass	Baozhu Hu

Note: The measurement uncertainty is not included in the test result.

3. Summary

3.1. Client Information

Applicant:	Anker Technology Co., Limited
Address:	Room 1318-19, Hollywood Plaza, 610 Nathan Road, Mongkok, Kowloon, Hong Kong
Manufacturer:	Shenzhen 3nod Acousticlink Co., Ltd.
Address:	4 /F, And Section A, 1/F, Workshop 15, Zhongfu Road, Tangxiayong Community, Songgang Neighbourhood, Bao'an District, Shenzhen City, Guangdong Rrovince, P.R.C

3.2. Product Description

Name of EUT:	Zolo Halo			
Trade Mark:	ZOLO			
Model No.:	Z6000			
Listed Model(s):	-			
Power supply:	AC 120V/60Hz			
Adapter information:	Model: Z60-A00 Input: 100-240Va.c., 50-60Hz, 0.45A Output: 9.0Vd.c., 1.5A			
Hardware version:	V1.2			
Software version:	V1.0			
WIFI				
Supported type:	<input checked="" type="checkbox"/> 802.11b	<input checked="" type="checkbox"/> 802.11g	<input checked="" type="checkbox"/> 802.11n(HT20)	<input checked="" type="checkbox"/> 802.11n(HT40)
Modulation:	<u>DSSS</u> for 802.11b <u>OFDM</u> for 802.11g/802.11n(HT20)/802.11n(HT40)			
Operation frequency:	<u>2412MHz~2462MHz</u> for 802.11b/802.11g/802.11n(HT20) <u>2422MHz~2452MHz</u> for 802.11n(HT40)			
Channel number:	<u>11</u> for 802.11b/802.11g/802.11n(HT20) <u>7</u> for 802.11n(HT40)			
Channel separation:	5MHz			
Antenna type:	Integral antenna			
Antenna gain:	3 dBi			

3.3. Operation state

➤ **Test frequency list**

According to section 15.31(m), regards to the operating frequency range over 10 MHz, must select three channel which were tested. the Lowest frequency, the middle frequency, and the highest frequency of channel were selected to perform the test, please see the above gray bottom.

802.11b/g/n(HT20)		802.11n(HT40)	
Channel	Frequency (MHz)	Channel	Frequency (MHz)
01	2412	01	-
02	2417	02	-
03	2422	03	2422
04	2427	04	2427
05	2432	05	2432
06	2437	06	2437
07	2442	07	2442
08	2447	08	2447
09	2452	09	2452
10	2457	10	-
11	2462	11	-

➤ **Test mode**

For RF test items
The engineering test program was provided and enabled to make EUT continuous transmit(duty cycle>98%).
For AC power line conducted emissions:
The EUT was set to connect with the WLAN AP under large package sizes transmission.
For RF test axis
EUT in each of three orthogonal axis emissions had been tested ,but only the worst case (X axis) data Recorded in the report.

3.4. EUT configuration

The following peripheral devices and interface cables were connected during the measurement:

- - supplied by the manufacturer
- - supplied by the lab

○		Manufacturer :	
		Model No. :	
○		Manufacturer :	
		Model No. :	

3.5. Modifications

No modifications were implemented to meet testing criteria.

4. Test Environment

4.1. Address of the test laboratory

Laboratory: Shenzhen Huatongwei International Inspection Co., Ltd.

Address: 1/F, Bldg 3, Hongfa Hi-tech Industrial Park, Genyu Road, Tianliao, Gongming, Shenzhen, China

Phone: 86-755-26748019 Fax: 86-755-26748089

4.2. Test Facility

The test facility is recognized, certified, or accredited by the following organizations:

CNAS-Lab Code: L1225

Shenzhen Huatongwei International Inspection Co., Ltd. has been assessed and proved to be in compliance with CNAS-CL01 Accreditation Criteria for Testing and Calibration Laboratories (identical to ISO/IEC17025: 2005 General Requirements) for the Competence of Testing and Calibration Laboratories.

A2LA-Lab Cert. No. 3902.01

Shenzhen Huatongwei International Inspection Co., Ltd. EMC Laboratory has been accredited by A2LA for technical competence in the field of electrical testing, and proved to be in compliance with ISO/IEC 17025: 2005 General Requirements for the Competence of Testing and Calibration Laboratories and any additional program requirements in the identified field of testing.

FCC-Registration No.: 762235

Shenzhen Huatongwei International Inspection Co., Ltd. EMC Laboratory has been registered and fully described in a report filed with the FCC (Federal Communications Commission). The acceptance letter from the FCC is maintained in our files. Registration 762235.

IC-Registration No.: 5377B-1

Two 3m Alternate Test Site of Shenzhen Huatongwei International Inspection Co., Ltd. has been registered by Certification and Engineering Bureau of Industry Canada for the performance of radiated measurements with Registration No. 5377B-1.

ACA

Shenzhen Huatongwei International Inspection Co., Ltd. EMC Laboratory can also perform testing for the Australian C-Tick mark as a result of our A2LA accreditation.

4.3. Equipments Used during the Test

Line Conducted Emission (AC Main)					
Item	Test Equipment	Manufacturer	Model No.	Serial No.	Last Cal.
1	EMI Test Receiver	R&S	ESCI	101247	2016/11/13
2	Artificial Mains	Shwarzbeck	NNLK 8121	573	2016/11/13
3	Pulse Limiter	R&S	ESH3-Z2	101488	2016/11/13
4	Test Software	R&S	ES-K1	N/A	N/A
5	Test cable	ENVIROFLEX	3651	1101902	2016/11/13

Maximum Peak Output Power / Power Spectral Density / 6dB Bandwidth / Band Edge Compliance of RF Emission / Spurious RF Conducted Emission					
Item	Test Equipment	Manufacturer	Model No.	Serial No.	Last Cal
1	Spectrum Analyzer	Rohde&Schwarz	FSP	1164.4391.40	2016/11/13
2	Power Meter	Anritsu	ML2480B	100798	2016/11/13
3	Power Sensor	Anritsu	MA2411B	100258	2016/11/13
4	Test cable	FARPU	MCX-J	N/A	2016/11/13
5	Temporary antenna connector	D-LENP	NJ-SMAK	N/A	2016/11/13

NOTE: The temporary antenna connector is soldered on the PCB board in order to perform conducted tests and this temporary antenna connector is listed in the equipment list.

Radiated Emission					
Item	Test Equipment	Manufacturer	Model No.	Serial No.	Last Cal.
1	EMI Test Receiver	Rohde&Schwarz	ESI 26	100009	2016/11/13
2	RF Test Panel	Rohde&Schwarz	TS / RSP	335015/0017	N/A
3	EMI Test Software	Rohde&Schwarz	ESK1	N/A	N/A
4	Loop Antenna	Rohde&Schwarz	HZ-9	838622\013	2016/11/13
5	Ultra-Broadband Antenna	ShwarzBeck	VULB9163	538	2016/11/13
6	Horn Antenna	ShwarzBeck	9120D	1011	2016/11/13
7	Broadband Horn Antenna	Shwarzbeck	BBHA9170	BBHA9170472	2016/11/13
8	Preamplifier	Shwarzbeck	BBV9742	9742-196	2016/11/13
9	Broadband Preamplifier	Shwarzbeck	BBV 9721	9721-102	2016/11/13
10	Broadband Preamplifier	Shwarzbeck	BBV 9718	9718-247	2016/11/13
11	Turn Table	MATURO	TT2.0	/	N/A
12	Antenna Mast	MATURO	TAM-4.0-P	/	N/A
13	EMI Test Software	Audix	E3	N/A	N/A
14	Test Software	R&S	ES-K1	N/A	N/A
15	Test cable	Siva Cables Italy	RG 58A/U	W14.02	2016/11/13

The Cal. Interval was one year.

4.4. Environmental conditions

During the measurement the environmental conditions were within the listed ranges:

Temperature:	15~35°C
Relative Humidity:	30~60 %
Air Pressure:	950~1050mba

4.5. Statement of the measurement uncertainty

The data and results referenced in this document are true and accurate. The reader is cautioned that there may be errors in calibration limits of the equipment and facilities. The measurement uncertainty was calculated for all measurements listed in this test report according to TR-100028-01 "Electromagnetic compatibility and Radio spectrum Matters (ERM);Uncertainties in the measurement of mobile radio equipment characteristics;Part 1" and TR-100028-02 "Electromagnetic compatibility and Radio spectrum Matters (ERM);Uncertainties in the measurement of mobile radio equipment characteristics;Part 2" and is documented in the Shenzhen Huatongwei International Inspection Co., Ltd quality system according to ISO/IEC 17025. Further more, component and process variability of devices similar to that tested may result in additional deviation. The manufacturer has the sole responsibility of continued compliance of the device.

Here after the best measurement capability for Shenzhen Huatongwei is reported:

Test Items	Measurement Uncertainty	Notes
Transmitter power conducted	0.57 dB	(1)
Transmitter power Radiated	2.20 dB	(1)
Conducted spurious emissions 9KHz-40 GHz	1.60 dB	(1)
Radiated spurious emissions 9KHz-40 GHz	2.20 dB	(1)
Conducted Emissions 9KHz-30MHz	3.39 dB	(1)
Radiated Emissions 30~1000MHz	4.24 dB	(1)
Radiated Emissions 1~18GHz	5.16 dB	(1)
Radiated Emissions 18-40GHz	5.54 dB	(1)
Occupied Bandwidth	-----	(1)

(1) This uncertainty represents an expanded uncertainty expressed at approximately the 95% confidence level using a coverage factor of k=1.96.

5. Test Conditions and Results

5.1. Antenna requirement

REQUIREMENT:

FCC CFR Title 47 Part 15 Subpart C Section 15.203:

An intentional radiator shall be designed to ensure that no antenna other than that furnished by the responsible party shall be used with the device. The use of a permanently attached antenna or of an antenna that uses a unique coupling to the intentional radiator, the manufacturer may design the unit so that a broken antenna can be replaced by the user, but the use of a standard antenna jack or electrical connector is prohibited.

FCC CFR Title 47 Part 15 Subpart C Section 15.247(c) (1)(i):

(i) Systems operating in the 2400-2483.5 MHz band that is used exclusively for fixed. Point-to-point operations may employ transmitting antennas with directional gain greater than 6dBi provided the maximum conducted output power of the intentional radiator is reduced by 1 dB for every 3 dB that the directional gain of the antenna exceeds 6dBi.

TEST RESULTS

Passed Not Applicable

The directional gain of the antenna less than 6 dBi, please refer to the below antenna photo.

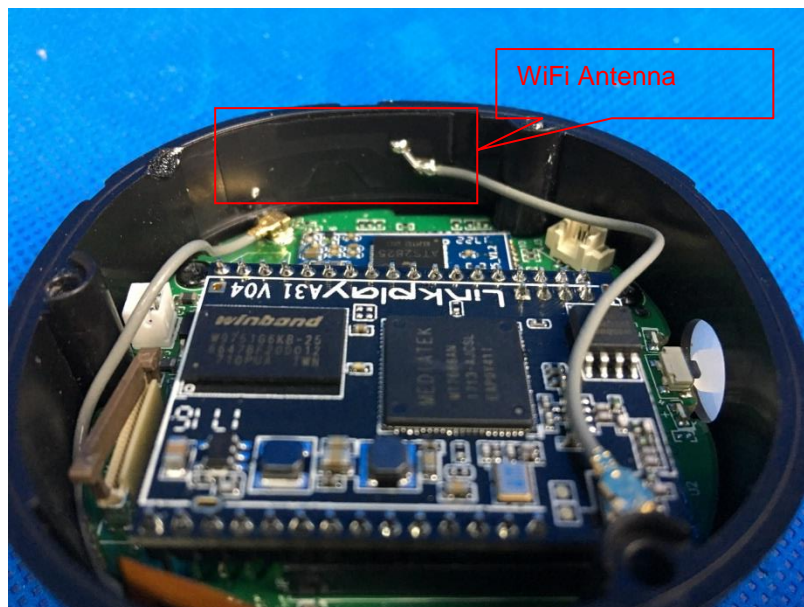

5.2. Conducted Emissions (AC Main)

LIMIT

FCC CFR Title 47 Part 15 Subpart C Section 15.207:

Frequency range (MHz)	Limit (dBuV)	
	Quasi-peak	Average
0.15-0.5	66 to 56*	56 to 46*
0.5-5	56	46
5-30	60	50

* Decreases with the logarithm of the frequency.

TEST CONFIGURATION

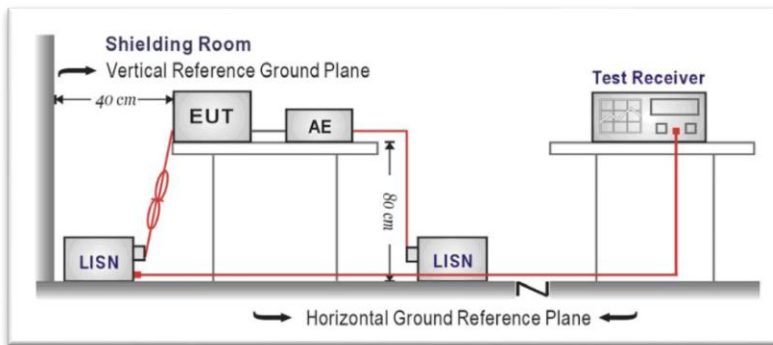

TEST PROCEDURE

1. The EUT was setup according to ANSI C63.10:2013 for compliance to FCC 47CFR 15.247 requirements.
2. The EUT was placed on a plat form of nominal size, 1 m by 1.5 m, raised 10 cm above the conducting ground plane. The vertical conducting plane was located 40 cm to the rear of the EUT. All other surfaces of EUT were at least 10 cm from any other grounded conducting surface.
3. The EUT and simulators are connected to the main power through a line impedance stabilization network (LISN). The LISN provides a 50ohm / 50uH coupling impedance for the measuring equipment.
4. The peripheral devices are also connected to the main power through a LISN. (Please refer to the block diagram of the test setup and photographs)
5. Each current-carrying conductor of the EUT power cord, except the ground (safety) conductor, was individually connected through a LISN to the input power source.
6. The excess length of the power cord between the EUT and the LISN receptacle were folded back and forth at the center of the lead to form a bundle not exceeding 40 cm in length.
7. Conducted emissions were investigated over the frequency range from 0.15MHz to 30MHz using a receiver bandwidth of 9 kHz.
8. During the above scans, the emissions were maximized by cable manipulation.

TEST MODE:

Please refer to the clause 3.3

TEST RESULTS

Passed Not Applicable

Test Line:

L

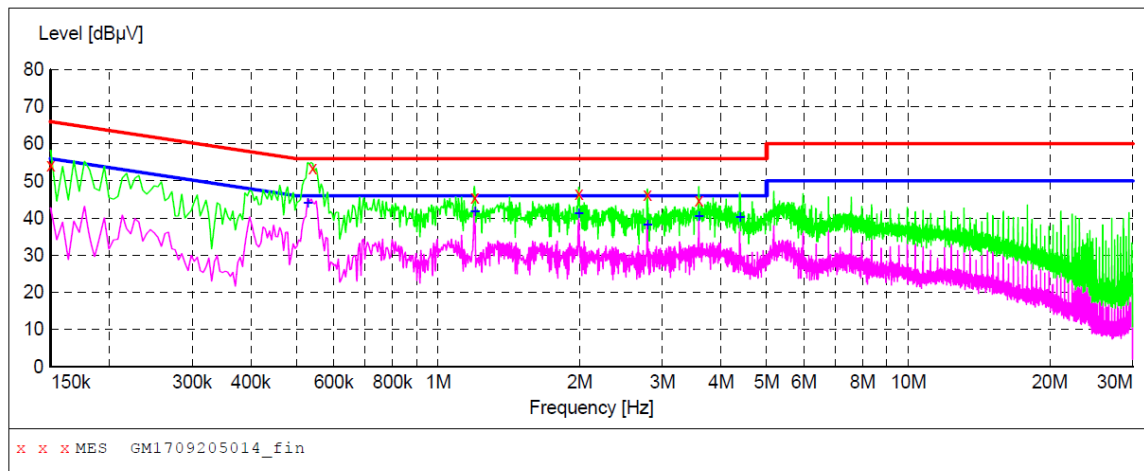

Frequency MHz	Level dBµV	Transd dB	Limit dBµV	Margin dB	Detector	Line	PE
0.150000	54.20	10.4	66	11.8	QP	L1	GND
0.541500	53.40	10.2	56	2.6	QP	L1	GND
1.198500	45.60	10.2	56	10.4	QP	L1	GND
1.995000	46.50	10.2	56	9.5	QP	L1	GND
2.791500	46.40	10.2	56	9.6	QP	L1	GND
3.588000	44.80	10.3	56	11.2	QP	L1	GND
Frequency MHz	Level dBµV	Transd dB	Limit dBµV	Margin dB	Detector	Line	PE
0.528000	44.10	10.2	46	1.9	AV	L1	GND
1.198500	41.70	10.2	46	4.3	AV	L1	GND
1.995000	41.30	10.2	46	4.7	AV	L1	GND
2.791500	38.10	10.2	46	7.9	AV	L1	GND
3.592500	40.50	10.3	46	5.5	AV	L1	GND
4.389000	40.20	10.3	46	5.8	AV	L1	GND

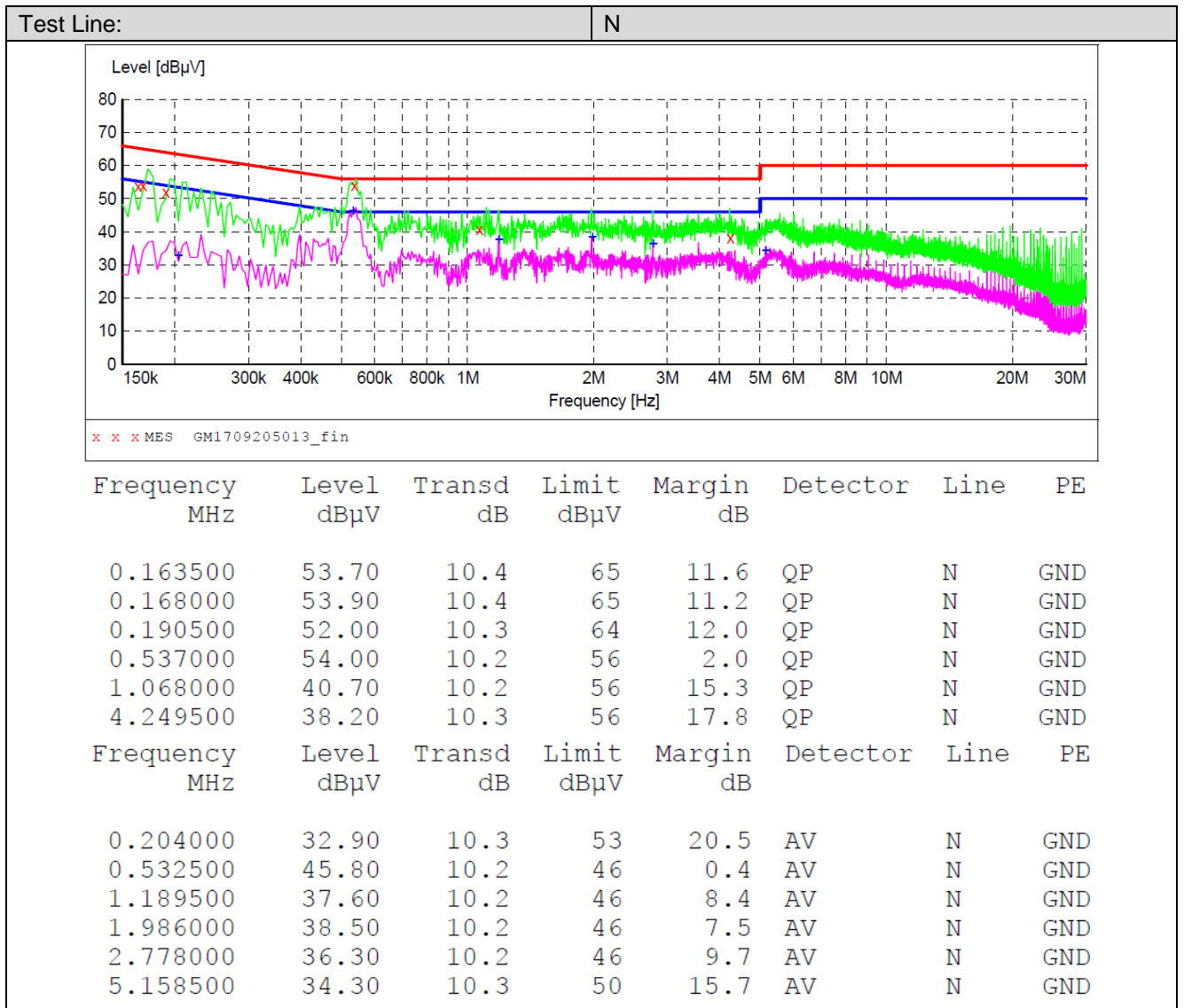

5.3. Conducted Peak Output Power

LIMIT

FCC CFR Title 47 Part 15 Subpart C Section 15.247 (b)(3): **30dBm**:

TEST CONFIGURATION

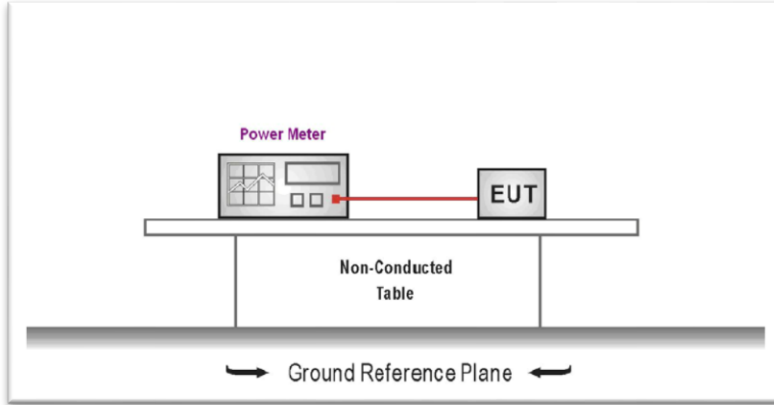

TEST PROCEDURE

1. The EUT was tested according to ANSI C63.10: 2013 and KDB 558074 D01 for compliance to FCC 47CFR 15.247 requirements.
2. The maximum peak conducted output power may be measured using a broadband peak RF power meter.
3. The power meter shall have a video bandwidth that is greater than or equal to the DTS bandwidth and shall utilize a fast-responding diode detector
4. Record the measurement data.

TEST MODE:

Please refer to the clause 3.3

TEST RESULTS

Passed **Not Applicable**

Type	Channel	Output power (dBm)	Limit (dBm)	Result
802.11b	01	15.16	30.00	Pass
	06	15.15		
	11	14.33		
802.11g	01	14.79	30.00	Pass
	06	14.69		
	11	13.93		
802.11n(HT20)	01	14.58	30.00	Pass
	06	14.46		
	11	14.15		
802.11n(HT40)	03	15.02	30.00	Pass
	06	14.91		
	09	14.91		

5.4. Power Spectral Density

LIMIT

FCC CFR Title 47 Part 15 Subpart C Section 15.247 (e):

For digitally modulated systems, the power spectral density conducted from the intentional radiator to the antenna shall not be greater than 8 dBm in any 3 kHz band during any time interval of continuous transmission.

TEST CONFIGURATION

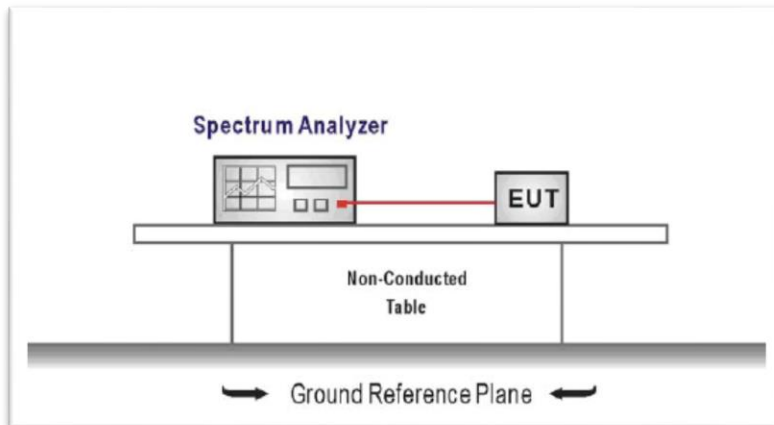

TEST PROCEDURE

1. Connect the antenna port(s) to the spectrum analyzer input,
2. Configure the spectrum analyzer as shown below:
Center frequency=DTS channel center frequency
Span =1.5 times the DTS bandwidth
RBW = 3 kHz ≤ RBW ≤ 100 kHz, VBW ≥ 3 × RBW
Sweep time = auto couple
Detector = peak
Trace mode = max hold
3. Place the radio in continuous transmit mode, allow the trace to stabilize, view the transmitter waveform on the spectrum analyzer.
4. Use the peak marker function to determine the maximum amplitude level within the RBW.
5. If measured value exceeds limit, reduce RBW (no less than 3 kHz) and repeat.

TEST MODE:

Please refer to the clause 3.3

TEST RESULTS

Passed Not Applicable

Type	Channel	Power Spectral Density (dBm/3KHz)	Limit (dBm/3KHz)	Result
802.11b	01	1.41	8.00	Pass
	06	1.38		
	11	0.25		
802.11g	01	-18.93	8.00	Pass
	06	-18.91		
	11	-19.67		
802.11n(HT20)	01	-18.29	8.00	Pass
	06	-17.92		
	11	-19.42		
802.11n(HT40)	03	-20.91	8.00	Pass
	06	-21.68		
	09	-20.61		

Test plot as follows:

802.11b

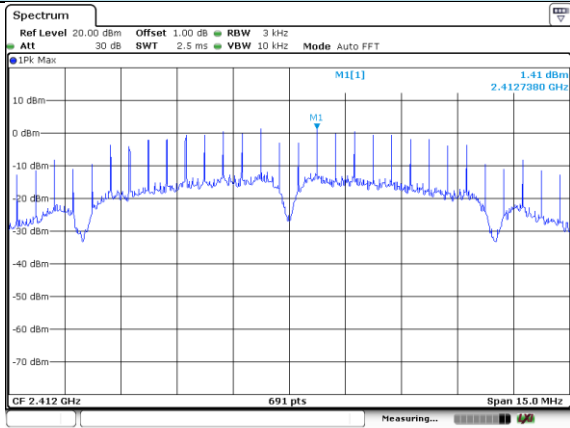

CH01

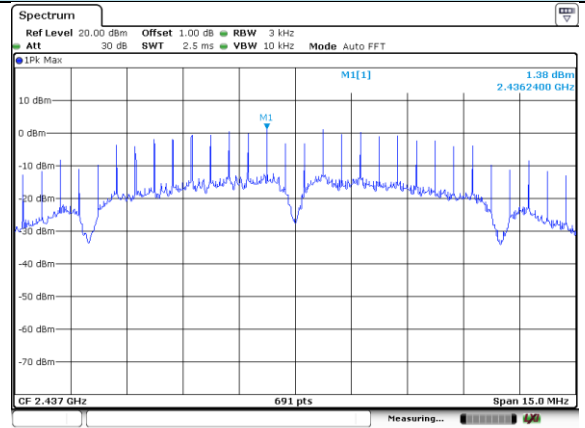

CH06

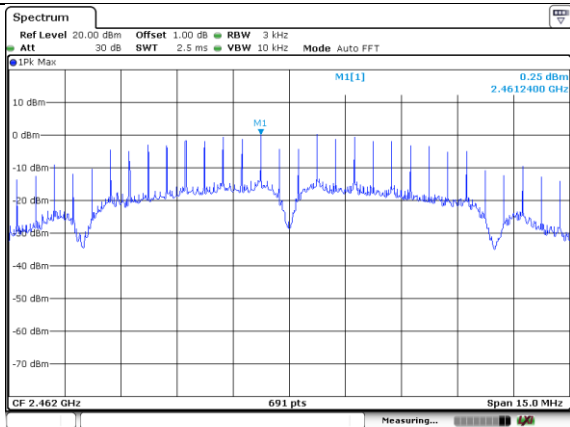

CH11

No Plot

802.11g

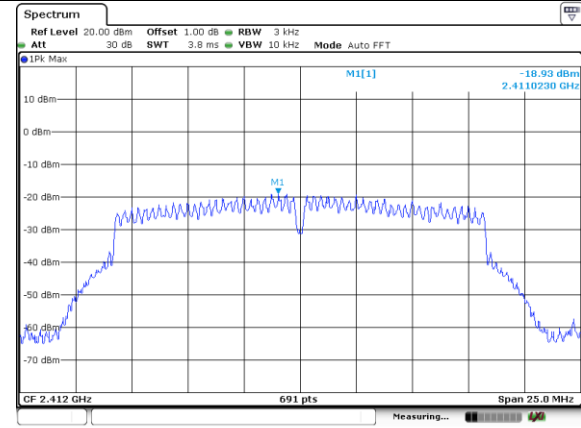

CH01

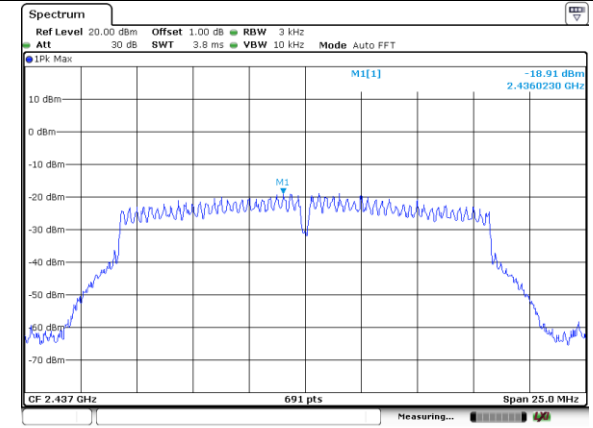

CH06

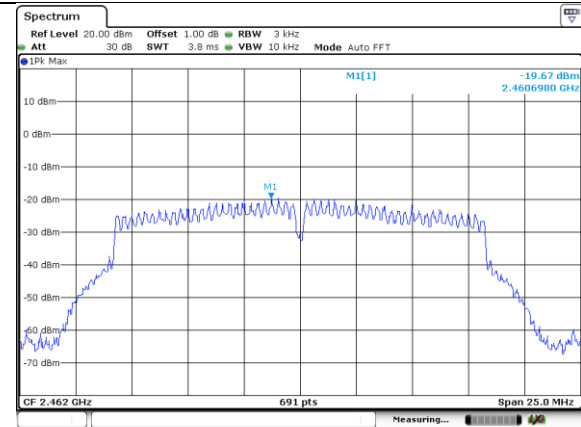

CH11

No Plot

802.11n(HT20)

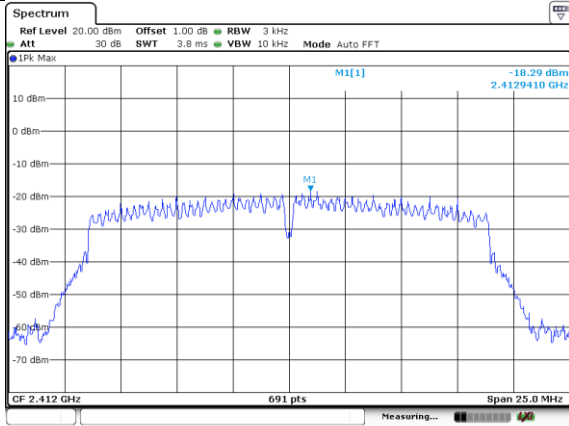

CH01

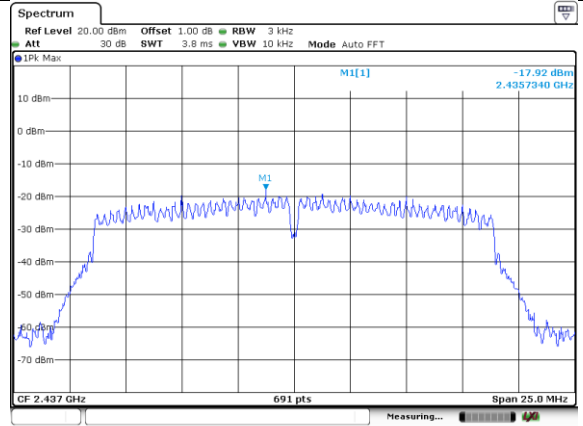

CH06

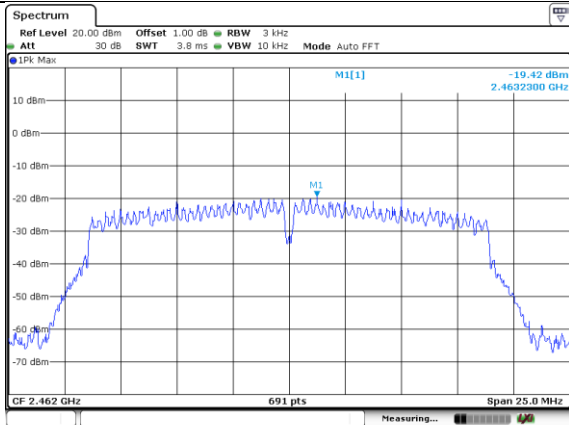

CH11

No Plot

802.11n(HT40)

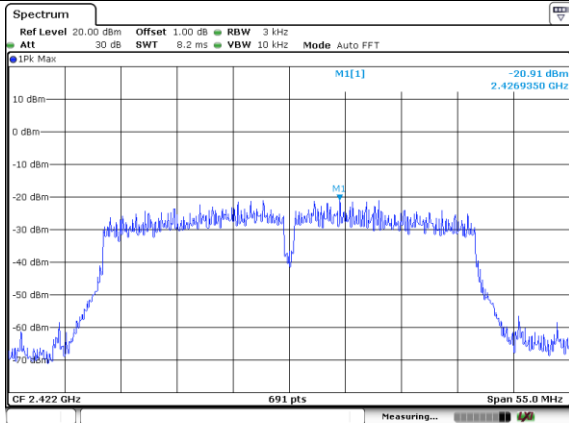

CH03

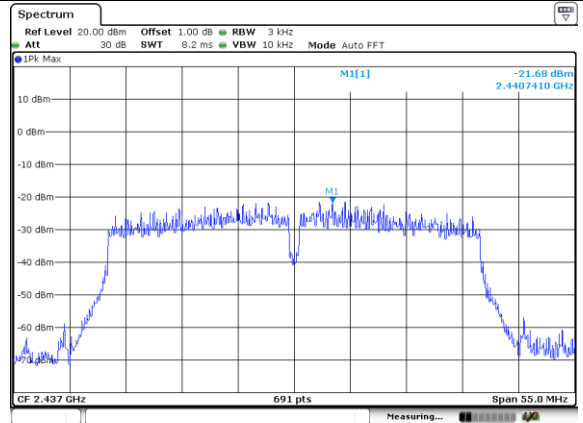

CH06

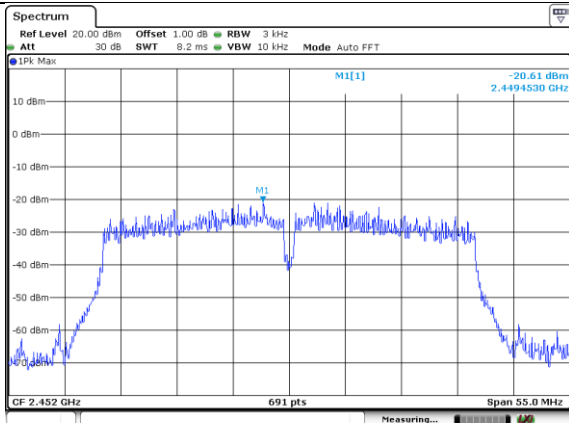

CH09

No Plot

5.5. 6dB bandwidth

LIMIT

FCC CFR Title 47 Part 15 Subpart C Section 15.247 (a)(2):

For digital modulation systems, the minimum 6 dB bandwidth shall be at least 500 kHz.

TEST CONFIGURATION

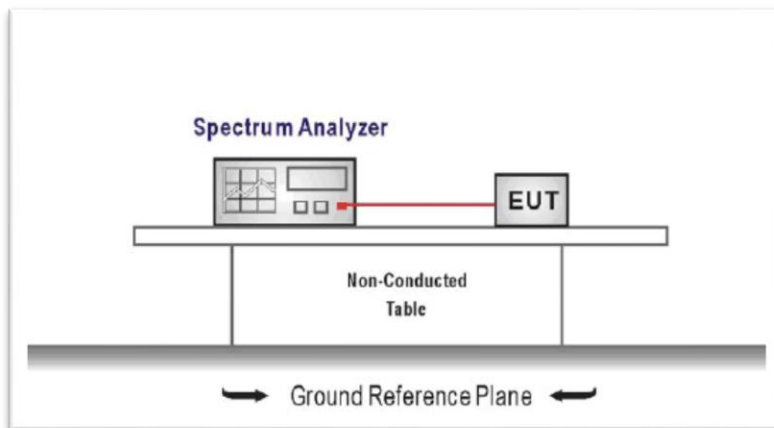

TEST PROCEDURE

1. Connect the antenna port(s) to the spectrum analyzer input.
2. Configure the spectrum analyzer as shown below (enter all losses between the transmitter output and the spectrum analyzer).
Center Frequency = DTS channel center frequency
Span = 2 x DTS bandwidth
RBW = 100 kHz, VBW ≥ 3 x RBW
Sweep time = auto couple
Detector = Peak
Trace mode = max hold
3. Place the radio in continuous transmit mode, allow the trace to stabilize, view the transmitter waveform on the spectrum analyzer.
4. Measure the maximum width of the emission that is constrained by the frequencies associated with the two outermost amplitude points (upper and lower frequencies) that are attenuated by 6 dB relative to the maximum level measured in the fundamental emission, and record the pertinent measurements.

TEST MODE:

Please refer to the clause 3.3

TEST RESULTS

Passed Not Applicable

Type	Channel	6dB Bandwidth (MHz)	Limit (kHz)	Result
802.11b	01	10.02	≥500	Pass
	06	10.02		
	11	10.02		
802.11g	01	15.20	≥500	Pass
	06	15.22		
	11	15.17		
802.11n(HT20)	01	15.17	≥500	Pass
	06	15.22		
	11	15.22		
802.11n(HT40)	03	35.43	≥500	Pass
	06	35.08		
	09	35.54		

Test plot as follows:

802.11b

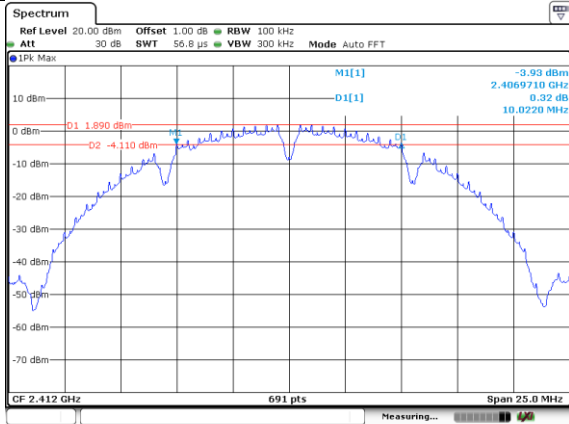

CH01

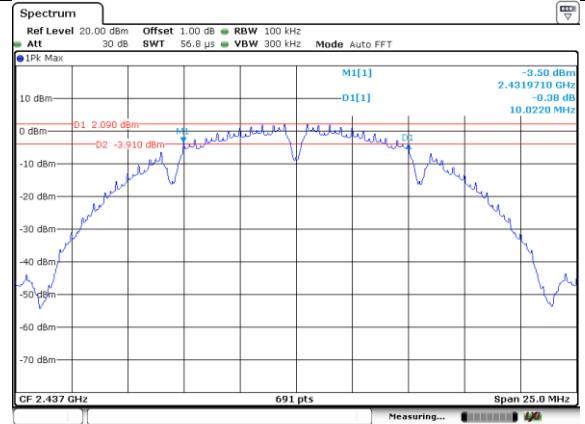

CH06

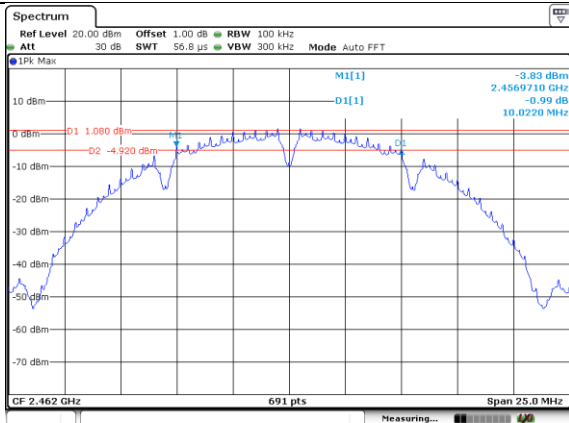

CH11

No Plot

802.11g

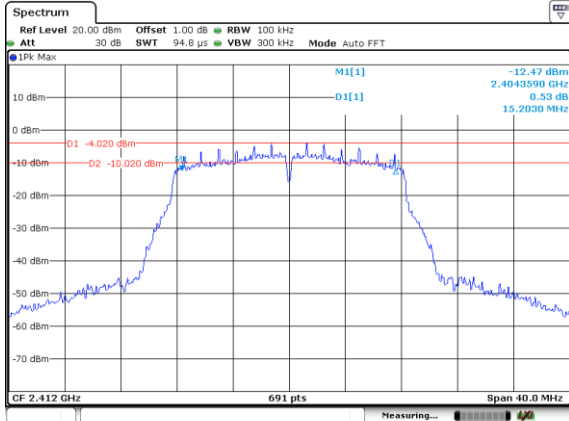

CH01

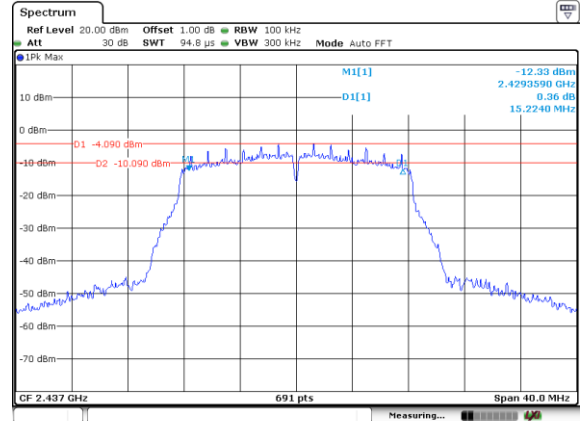

CH06

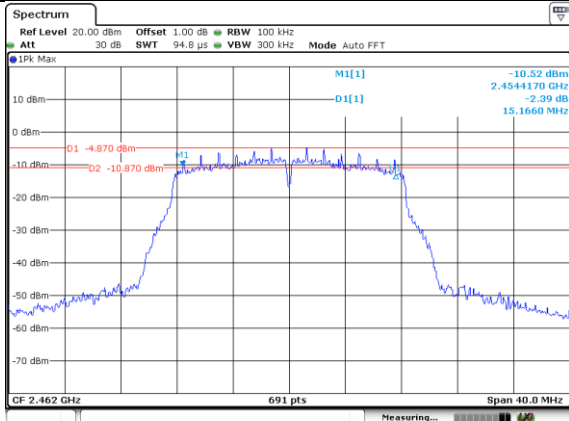

CH11

No Plot

802.11n(HT20)

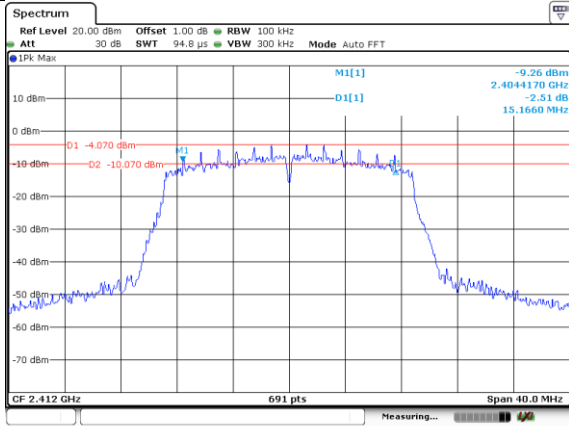

CH01

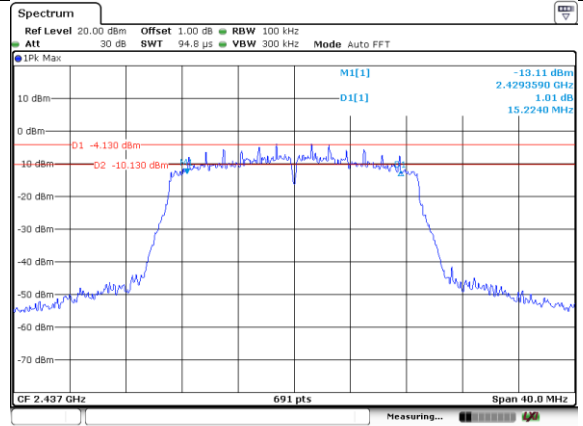

CH06

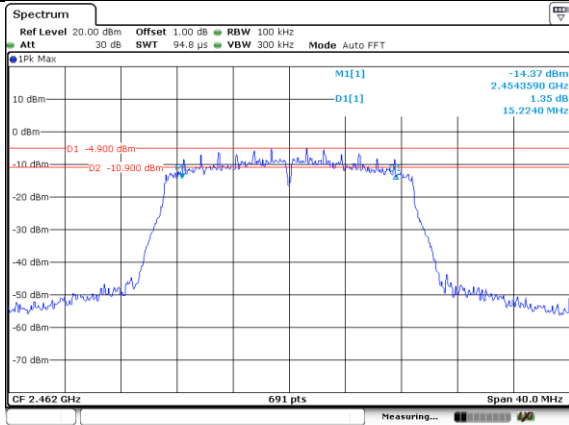

CH11

No Plot

802.11n(HT40)

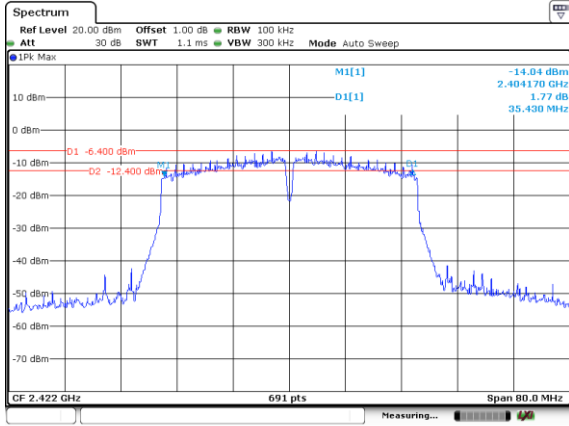

CH03

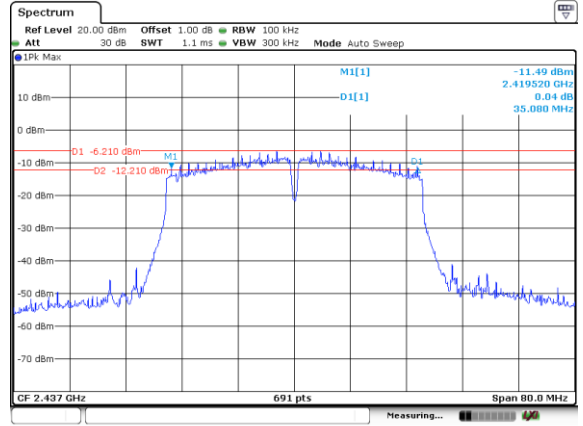

CH06

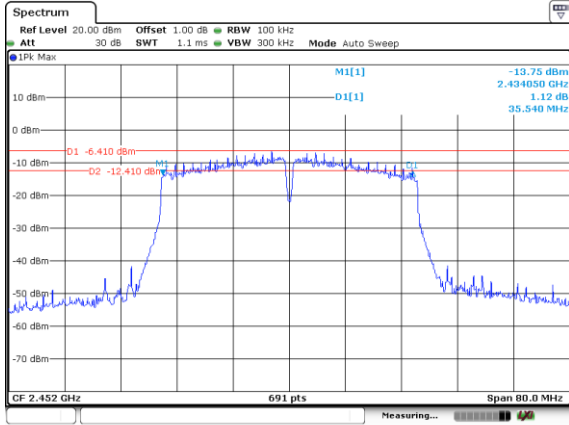

CH09

No Plot

5.6. Restricted band

LIMIT

FCC CFR Title 47 Part 15 Subpart C Section 15.247 (d):

In any 100 kHz bandwidth outside the frequency band in which the spread spectrum or digitally modulated intentional radiator is operating, radiated emissions which fall in the restricted bands, as defined in §15.205(a), must also comply with the radiated emission limits specified in §15.209(a) (see §15.205(c)).

TEST CONFIGURATION

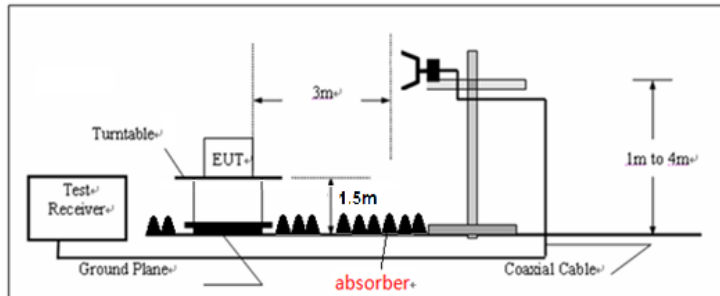

TEST PROCEDURE

- 1) The EUT was setup and tested according to ANSI C63.10:2013 for compliance to FCC 47CFR 15.247 requirements.
- 2) The EUT is placed on a turn table which is 1.5 meter above ground. The turn table is rotated 360 degrees to determine the position of the maximum emission level.
- 3) The EUT was positioned such that the distance from antenna to the EUT was 3 meters.
- 4) The antenna is scanned from 1 meter to 4 meters to find out the maximum emission level. This is repeated for both horizontal and vertical polarization of the antenna. In order to find the maximum emission, all of the interface cables were manipulated according to ANSI C63.10:2013 on radiated measurement.
- 5) The receiver set as follow:
 RBW=1MHz, VBW=3MHz Peak detector for Peak value
 RBW=1MHz, VBW=3MHz RMS detector for Average value.

TEST MODE:

Please refer to the clause 3.3

TEST RESULTS

Passed **Not Applicable**

Note:

- 1) Final level= Read level + Antenna Factor+ Cable Loss- Preamp Factor

802.11b						CH01			
Frequency (MHz)	Read Level (dBuV)	Antenna Factor (dB/m)	Cable Loss (dB)	Preamp Factor (dB)	Level (dBuV/m)	Limit Line (dBuV/m)	Margin Limit (dB)	Polarization	Test value
2310.00	17.29	28.05	6.62	0.00	51.96	74.00	-22.04	Horizontal	Peak
2390.01	17.37	27.65	6.75	0.00	51.77	74.00	-22.23	Horizontal	Peak
2310.00	16.82	28.05	6.62	0.00	51.49	74.00	-22.51	Vertical	Peak
2390.01	15.99	27.65	6.75	0.00	50.39	74.00	-23.61	Vertical	Peak
2310.00	11.66	28.05	6.62	0.00	46.33	54.00	-7.67	Horizontal	Average
2390.01	11.20	27.65	6.75	0.00	45.60	54.00	-8.40	Horizontal	Average
2310.00	11.68	28.05	6.62	0.00	46.35	54.00	-7.65	Vertical	Average
2390.01	11.22	27.65	6.75	0.00	45.62	54.00	-8.38	Vertical	Average

802.11b						CH11			
Frequency (MHz)	Read Level (dBuV)	Antenna Factor (dB/m)	Cable Loss (dB)	Preamp Factor (dB)	Level (dBuV/m)	Limit Line (dBuV/m)	Margin Limit (dB)	Polarization	Test value
2310.00	16.50	28.05	6.62	0.00	51.17	74.00	-22.83	Horizontal	Peak
2390.01	16.32	27.65	6.75	0.00	50.72	74.00	-23.28	Horizontal	Peak
2310.00	16.26	28.05	6.62	0.00	50.93	74.00	-23.07	Vertical	Peak
2390.01	17.37	27.65	6.75	0.00	51.77	74.00	-22.23	Vertical	Peak
2310.00	11.67	28.05	6.62	0.00	46.34	54.00	-7.66	Horizontal	Average
2390.01	11.22	27.65	6.75	0.00	45.62	54.00	-8.38	Horizontal	Average
2310.00	11.66	28.05	6.62	0.00	46.33	54.00	-7.67	Vertical	Average
2390.01	11.23	27.65	6.75	0.00	45.63	54.00	-8.37	Vertical	Average

802.11g						CH01			
Frequency (MHz)	Read Level (dBuV)	Antenna Factor (dB/m)	Cable Loss (dB)	Preamp Factor (dB)	Level (dBuV/m)	Limit Line (dBuV/m)	Margin Limit (dB)	Polarization	Test value
2310.00	12.57	28.05	6.62	0.00	47.24	74.00	-26.76	Horizontal	Peak
2390.01	13.31	27.65	6.75	0.00	47.71	74.00	-26.29	Horizontal	Peak
2310.00	14.41	28.05	6.62	0.00	49.08	74.00	-24.92	Vertical	Peak
2390.01	16.13	27.65	6.75	0.00	50.53	74.00	-23.47	Vertical	Peak
2310.00	11.37	28.05	6.62	0.00	46.04	54.00	-7.96	Horizontal	Average
2390.01	11.17	27.65	6.75	0.00	45.57	54.00	-8.43	Horizontal	Average
2310.00	11.37	28.05	6.62	0.00	46.04	54.00	-7.96	Vertical	Average
2390.01	11.60	27.65	6.75	0.00	46.00	54.00	-8.00	Vertical	Average

802.11g						CH11			
Frequency (MHz)	Read Level (dBuV)	Antenna Factor (dB/m)	Cable Loss (dB)	Preamp Factor (dB)	Level (dBuV/m)	Limit Line (dBuV/m)	Margin Limit (dB)	Polarization	Test value
2483.49	19.61	27.26	6.83	0.00	53.70	74.00	-20.30	Horizontal	Peak
2500.00	18.17	27.20	6.84	0.00	52.21	74.00	-21.79	Horizontal	Peak
2483.49	18.84	27.26	6.83	0.00	52.93	74.00	-21.07	Vertical	Peak
2500.00	16.14	27.20	6.84	0.00	50.18	74.00	-23.82	Vertical	Peak
2483.49	12.42	27.26	6.83	0.00	46.51	54.00	-7.49	Horizontal	Average
2500.00	11.28	27.20	6.84	0.00	45.32	54.00	-8.68	Horizontal	Average
2483.49	11.87	27.26	6.83	0.00	45.96	54.00	-8.04	Vertical	Average
2500.00	11.17	27.20	6.84	0.00	45.21	54.00	-8.79	Vertical	Average

802.11n(HT20)						CH01			
Frequency (MHz)	Read Level (dBuV)	Antenna Factor (dB/m)	Cable Loss (dB)	Preamp Factor (dB)	Level (dBuV/m)	Limit Line (dBuV/m)	Margin Limit (dB)	Polarization	Test value
2310.00	16.50	28.05	6.62	0.00	51.17	74.00	-22.83	Horizontal	Peak
2390.01	16.32	27.65	6.75	0.00	50.72	74.00	-23.28	Horizontal	Peak
2310.00	16.26	28.05	6.62	0.00	50.93	74.00	-23.07	Vertical	Peak
2390.01	17.37	27.65	6.75	0.00	51.77	74.00	-22.23	Vertical	Peak
2310.00	11.67	28.05	6.62	0.00	46.34	54.00	-7.66	Horizontal	Average
2390.01	11.22	27.65	6.75	0.00	45.62	54.00	-8.38	Horizontal	Average
2310.00	11.66	28.05	6.62	0.00	46.33	54.00	-7.67	Vertical	Average
2390.01	11.23	27.65	6.75	0.00	45.63	54.00	-8.37	Vertical	Average

802.11n(HT20)						CH11			
Frequency (MHz)	Read Level (dBuV)	Antenna Factor (dB/m)	Cable Loss (dB)	Preamp Factor (dB)	Level (dBuV/m)	Limit Line (dBuV/m)	Margin Limit (dB)	Polarization	Test value
2483.49	19.61	27.26	6.83	0.00	53.70	74.00	-20.30	Horizontal	Peak
2500.00	18.17	27.20	6.84	0.00	52.21	74.00	-21.79	Horizontal	Peak
2483.49	18.84	27.26	6.83	0.00	52.93	74.00	-21.07	Vertical	Peak
2500.00	16.14	27.20	6.84	0.00	50.18	74.00	-23.82	Vertical	Peak
2483.49	12.42	27.26	6.83	0.00	46.51	54.00	-7.49	Horizontal	Average
2500.00	11.28	27.20	6.84	0.00	45.32	54.00	-8.68	Horizontal	Average
2483.49	11.87	27.26	6.83	0.00	45.96	54.00	-8.04	Vertical	Average
2500.00	11.17	27.20	6.84	0.00	45.21	54.00	-8.79	Vertical	Average

802.11n(HT40)						CH03			
Frequency (MHz)	Read Level (dBuV)	Antenna Factor (dB/m)	Cable Loss (dB)	Preamp Factor (dB)	Level (dBuV/m)	Limit Line (dBuV/m)	Margin Limit (dB)	Polarization	Test value
2310.00	17.47	28.05	6.62	0.00	52.14	74.00	-21.86	Horizontal	Peak
2389.99	17.55	27.65	6.75	0.00	51.95	74.00	-22.05	Horizontal	Peak
2310.00	17.60	28.05	6.62	0.00	52.27	74.00	-21.73	Vertical	Peak
2389.99	16.87	27.65	6.75	0.00	51.27	74.00	-22.73	Vertical	Peak
2310.00	11.67	28.05	6.62	0.00	46.34	54.00	-7.66	Horizontal	Average
2389.99	11.33	27.65	6.75	0.00	45.73	54.00	-8.27	Horizontal	Average
2310.00	11.65	28.05	6.62	0.00	46.32	54.00	-7.68	Vertical	Average
2389.99	11.30	27.65	6.75	0.00	45.70	54.00	-8.30	Vertical	Average

802.11n(HT40)						CH09			
Frequency (MHz)	Read Level (dBuV)	Antenna Factor (dB/m)	Cable Loss (dB)	Preamp Factor (dB)	Level (dBuV/m)	Limit Line (dBuV/m)	Margin Limit (dB)	Polarization	Test value
2483.50	19.99	27.26	6.83	0.00	54.08	74.00	-19.92	Horizontal	Peak
2500.00	17.16	27.20	6.84	0.00	51.20	74.00	-22.80	Horizontal	Peak
2483.50	18.04	27.26	6.83	0.00	52.13	74.00	-21.87	Vertical	Peak
2500.00	16.77	27.20	6.84	0.00	50.81	74.00	-23.19	Vertical	Peak
2483.50	12.89	27.26	6.83	0.00	46.98	54.00	-7.02	Horizontal	Average
2500.00	11.71	27.20	6.84	0.00	45.75	54.00	-8.25	Horizontal	Average
2483.50	13.01	27.26	6.83	0.00	47.10	54.00	-6.90	Vertical	Average
2500.00	11.77	27.20	6.84	0.00	45.81	54.00	-8.19	Vertical	Average

5.7. Band edge and Spurious Emission (conducted)

LIMIT

FCC CFR Title 47 Part 15 Subpart C Section 15.247 (d):

In any 100 kHz bandwidth outside the frequency band in which the spread spectrum intentional radiator is operating, the radio frequency power that is produced by the intentional radiator shall be at least 20 dB below that in the 100 kHz bandwidth within the band that contains the highest level of the desired power, based on either an RF conducted or a radiated measurement.

TEST CONFIGURATION

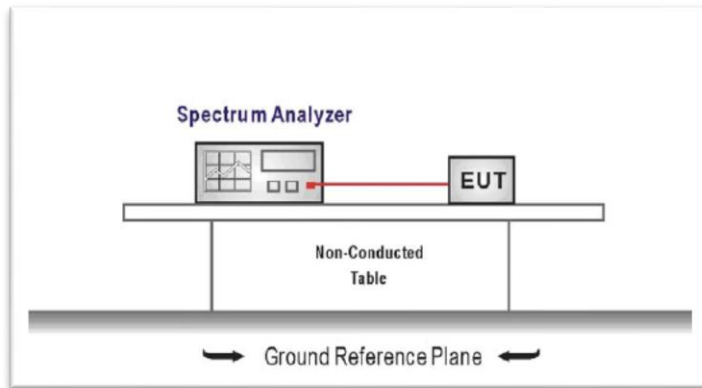

TEST PROCEDURE

1. Connect the antenna port(s) to the spectrum analyzer input.
2. Establish a reference level by using the following procedure
Center frequency=DTS channel center frequency
The span = 1.5 times the DTS bandwidth.
RBW = 100 kHz, VBW $\geq 3 \times$ RBW
Detector = peak, Sweep time = auto couple, Trace mode = max hold
Allow trace to fully stabilize
Use the peak marker function to determine the maximum PSD level

Note: the channel found to contain the maximum PSD level can be used to establish the reference level.
3. Emission level measurement
Set the center frequency and span to encompass frequency range to be measured
RBW = 100 kHz, VBW $\geq 3 \times$ RBW
Detector = peak, Sweep time = auto couple, Trace mode = max hold
Allow trace to fully stabilize
Use the peak marker function to determine the maximum amplitude level.
4. Place the radio in continuous transmit mode, allow the trace to stabilize, view the transmitter waveform on the spectrum analyzer.
5. Ensure that the amplitude of all unwanted emissions outside of the authorized frequency band excluding restricted frequency bands) are attenuated by at least the minimum requirements specified (at least 20 dB relative to the maximum in-band peak PSD level in 100 kHz). Report the three highest emissions relative to the limit.

TEST MODE:

Please refer to the clause 3.3

TEST RESULTS

Passed Not Applicable

802.11b

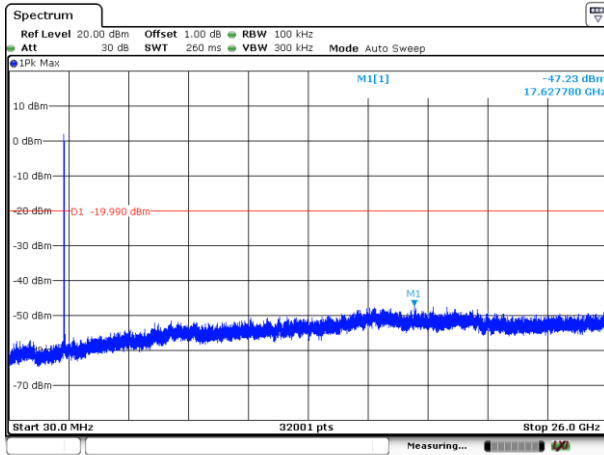

CH01-SE

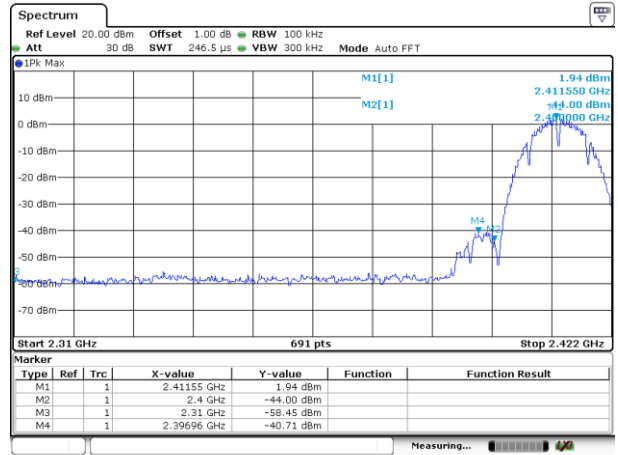

CH01-Bandedge

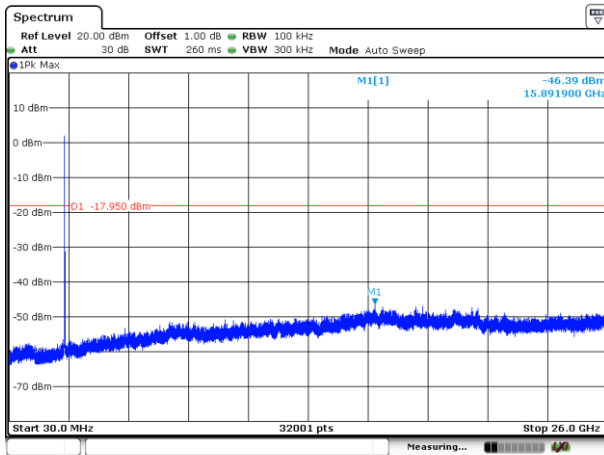

CH06-SE

No Plot

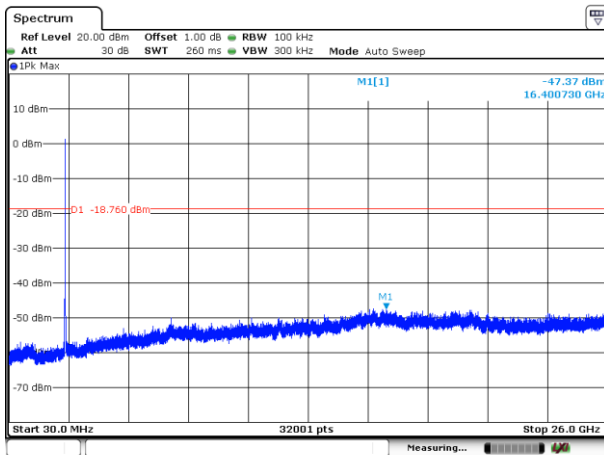

CH11-SE

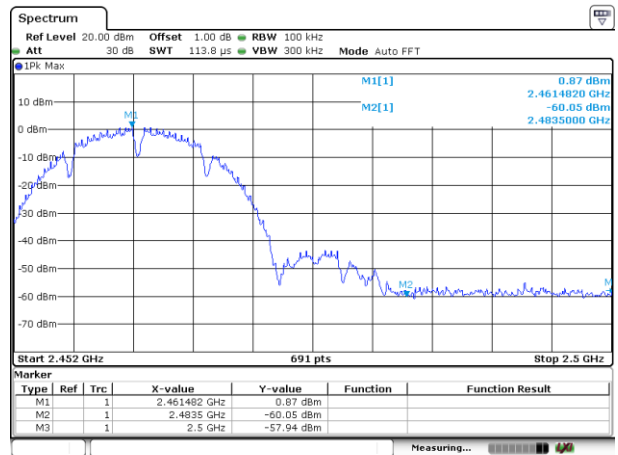

CH11-Bandedge

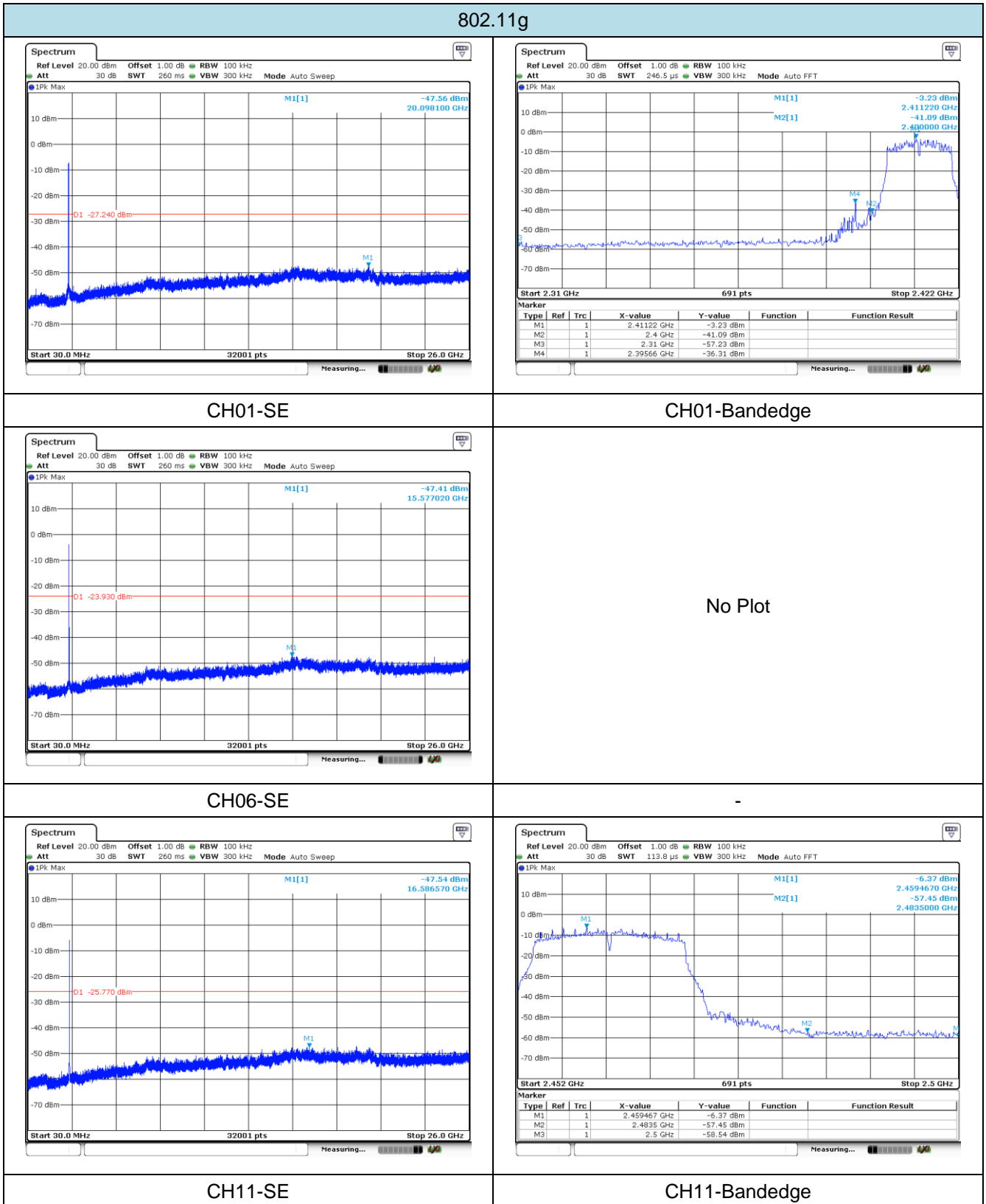

802.11n (HT20)

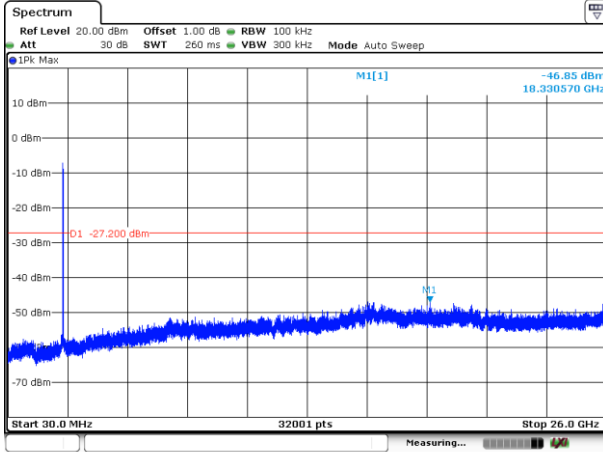

CH01-SE

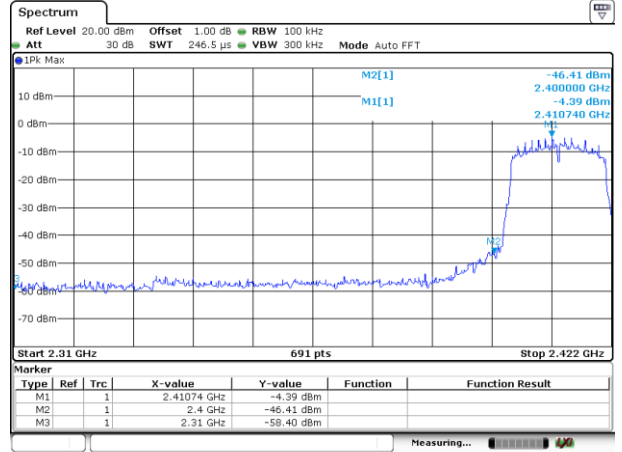

CH01-Bandedge

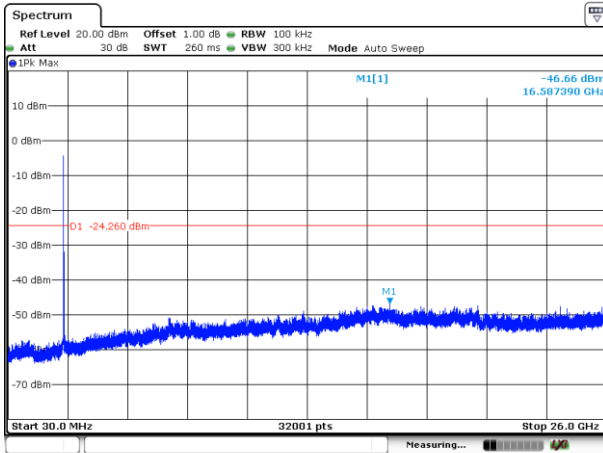

CH06-SE

No Plot

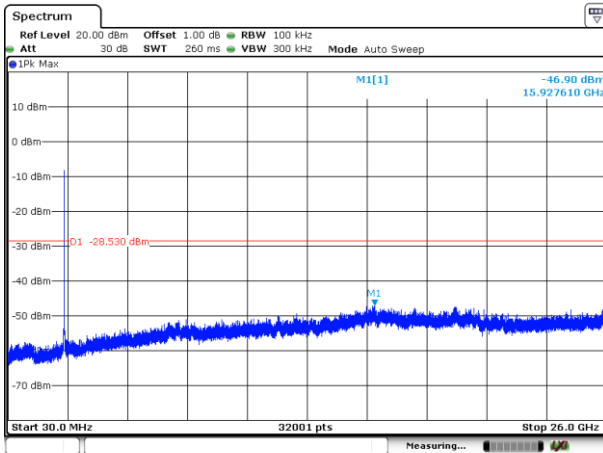

CH11-SE

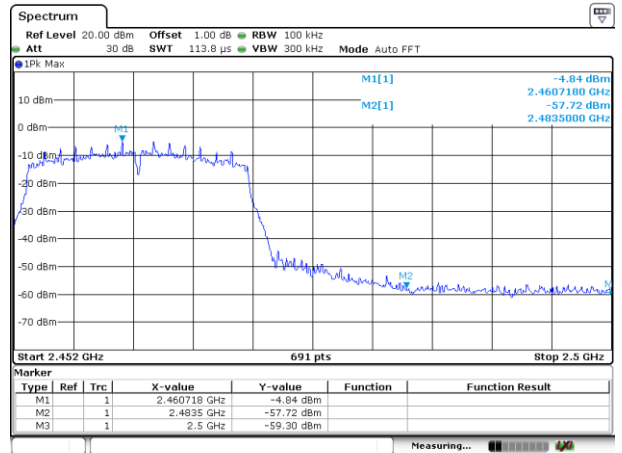

CH11-Bandedge

802.11n (HT40)

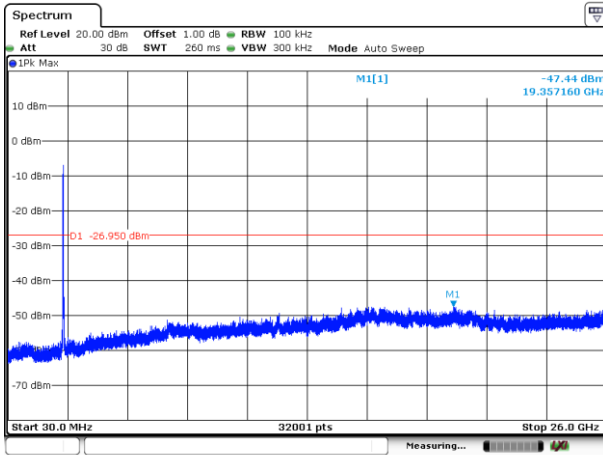

CH03-SE

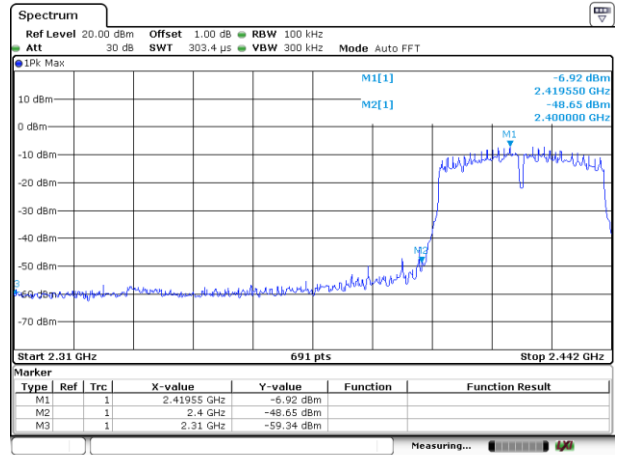

CH03-Bandedge

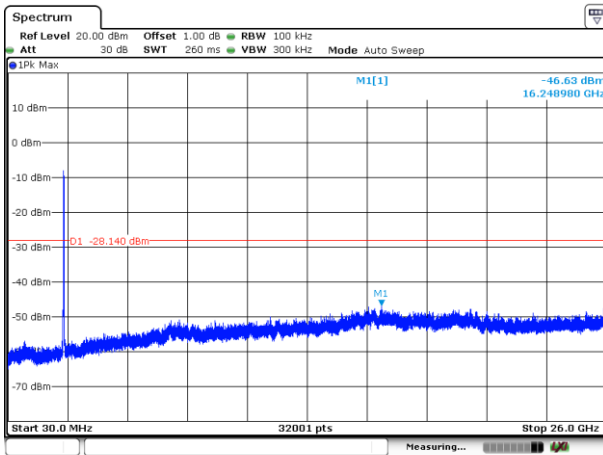

CH06-SE

No Plot

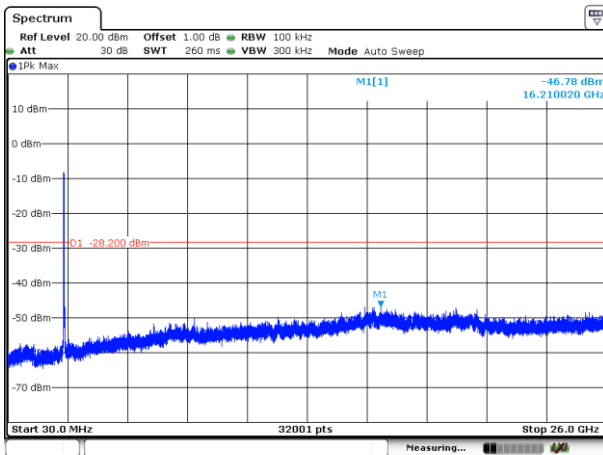

CH09-SE

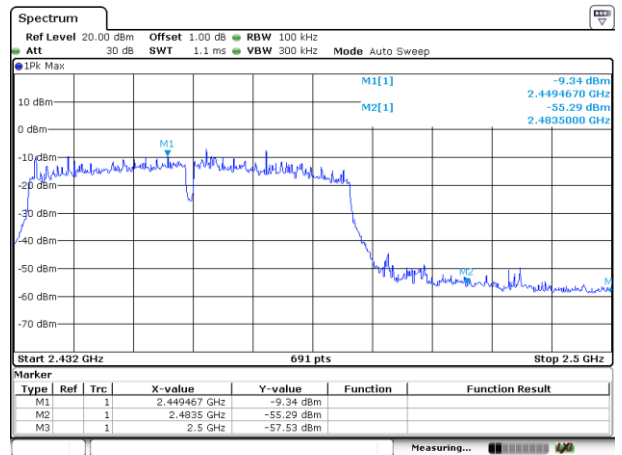

CH09-Bandedge

5.8. Spurious Emissions (radiated)

LIMIT

FCC CFR Title 47 Part 15 Subpart C Section 15.209

Frequency	Limit (dBuV/m @3m)	Value
30MHz-88MHz	40.00	Quasi-peak
88MHz-216MHz	43.50	Quasi-peak
216MHz-960MHz	46.00	Quasi-peak
960MHz-1GHz	54.00	Quasi-peak
Above 1GHz	54.00	Average
	74.00	Peak

TEST CONFIGURATION

➤ 9KHz ~30MHz

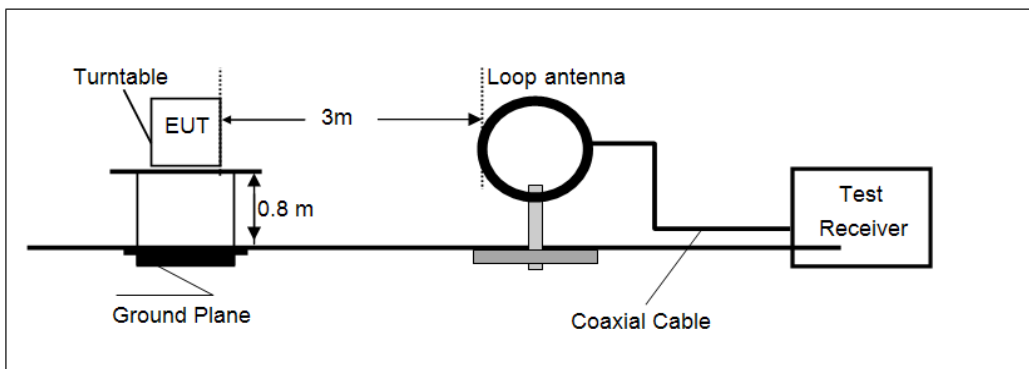

➤ 30MHz ~ 1GHz

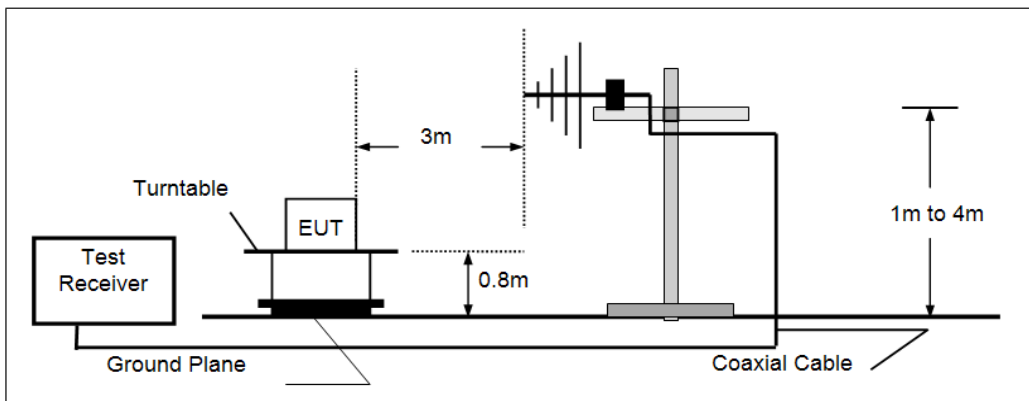

➤ Above 1GHz

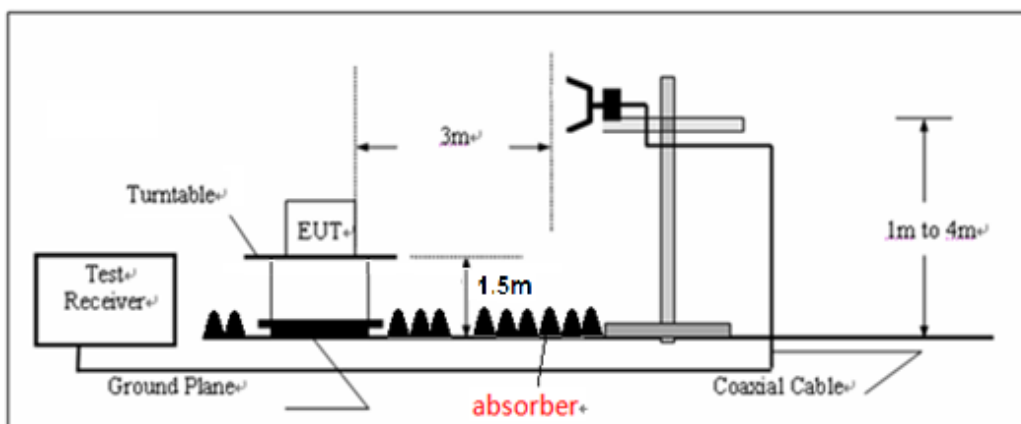

TEST PROCEDURE

1. The EUT was tested according to ANSI C63.10:2013 for compliance to FCC 47CFR 15.247 requirements.
2. The EUT is placed on a turn table which is 0.8/1.5 meter above ground plane. The turn table is rotated 360 degrees to determine the position of the maximum emission level.
3. The EUT was positioned such that the distance from antenna to the EUT was 3 meters.
4. The antenna is scanned from 1 meter to 4 meters to find out the maximum emission level. This is repeated for both horizontal and vertical polarization of the antenna.
5. Use the following spectrum analyzer settings
 - (1) Span shall wide enough to fully capture the emission being measured;
 - (2) Below 1GHz, RBW=120KHz, VBW=300KHz, Sweep=auto, Detector function=peak, Trace=max hold; If the emission level of the EUT measured by the peak detector is 3 dB lower than the applicable limit, the peak emission level will be reported. Otherwise, the emission measurement will be repeated using the quasi-peak detector and reported.
 - (3) Above 1GHz, RBW=1MHz, VBW=3MHz Peak detector for Peak value
RBW=1MHz, VBW=3MHz RMS detector for Average value.

Remark: "floor-standing equipment" Where possible, the antenna(s) of the EUT shall be located at a height of 1.5 m above the floor, and the intentional radiator circuitry shall be located within the system at a height of at least 0.8 m above the floor.

TEST MODE:

Please refer to the clause 3.3

TEST RESULTS

Passed **Not Applicable**

Note:

- 1) Final Level = Receiver Read level + Antenna Factor + Cable Loss – Preamplifier Factor
- 2) "*", means this data is too weak instrument of signal is unable to test.
- 3) The emission levels of other frequencies are very lower than the limit and not show in test report.

➤ **9kHz ~ 30MHz**

The EUT was pre-scanned the frequency band (9KHz~30MHz), found the radiated level lower than the limit, so don't show on the report.

➤ 30MHz ~ 1GHz

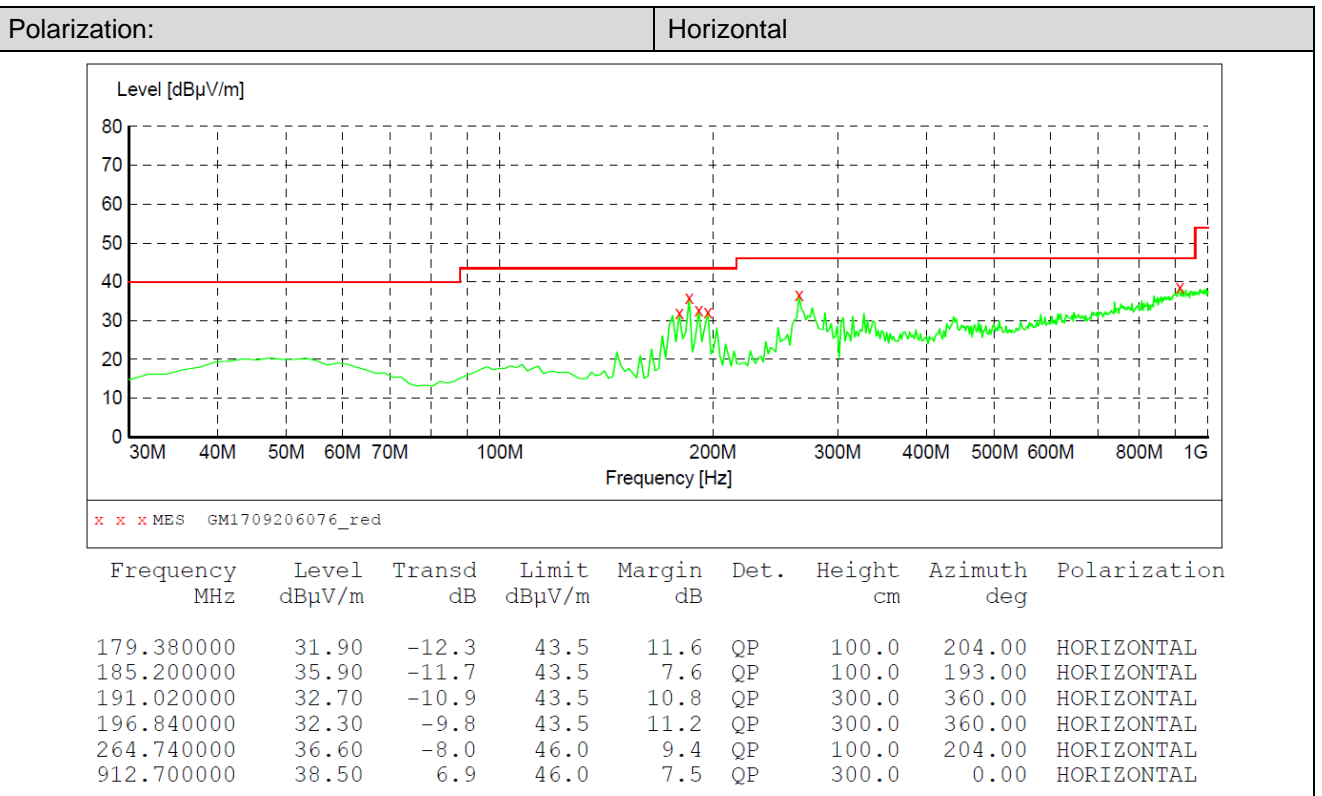
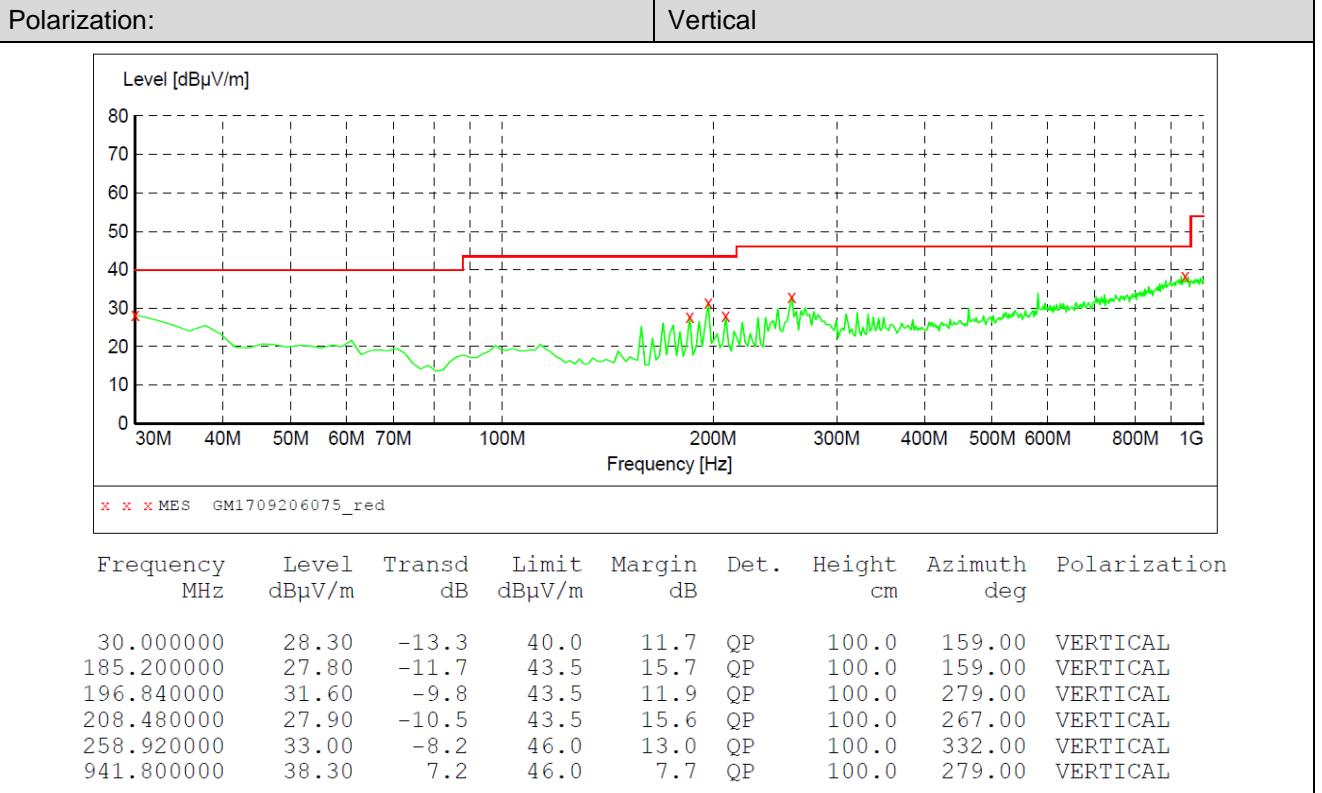

➤ Above 1GHz

802.11b					CH01				
Frequency (MHz)	Read Level (dBuV)	Antenna Factor (dB/m)	Cable Loss (dB)	Preamp Factor (dB)	Level (dBuV/m)	Limit Line (dBuV/m)	Margin Limit (dB)	Polarization	Test value
1589.29	36.81	24.99	5.54	36.71	30.63	74.00	-43.37	Vertical	Peak
3018.50	37.64	28.64	7.50	38.23	35.55	74.00	-38.45	Vertical	
4908.44	40.76	31.41	9.61	36.66	45.12	74.00	-28.88	Vertical	
6886.15	33.36	34.60	11.71	34.90	44.77	74.00	-29.23	Vertical	
1257.47	37.42	26.24	4.76	36.54	31.88	74.00	-42.12	Horizontal	
3525.56	36.89	29.08	8.15	38.37	35.75	74.00	-38.25	Horizontal	
4908.44	41.76	31.41	9.61	36.66	46.12	74.00	-27.88	Horizontal	
8770.01	33.91	37.76	13.07	34.32	50.42	74.00	-23.58	Horizontal	

802.11b					CH06				
Frequency (MHz)	Read Level (dBuV)	Antenna Factor (dB/m)	Cable Loss (dB)	Preamp Factor (dB)	Level (dBuV/m)	Limit Line (dBuV/m)	Margin Limit (dB)	Polarization	Test value
1715.41	37.25	25.23	5.80	36.96	31.32	74.00	-42.68	Vertical	Peak
3018.50	37.64	28.64	7.50	38.23	35.55	74.00	-38.45	Vertical	
4871.10	41.97	31.46	9.59	36.76	46.26	74.00	-27.74	Vertical	
6886.15	33.36	34.60	11.71	34.90	44.77	74.00	-29.23	Vertical	
1257.47	37.42	26.24	4.76	36.54	31.88	74.00	-42.12	Horizontal	
3018.50	37.64	28.64	7.50	38.23	35.55	74.00	-38.45	Horizontal	
4871.10	41.97	31.46	9.59	36.76	46.26	74.00	-27.74	Horizontal	
8527.85	32.41	37.01	12.88	34.43	47.87	74.00	-26.13	Horizontal	

802.11b					CH11				
Frequency (MHz)	Read Level (dBuV)	Antenna Factor (dB/m)	Cable Loss (dB)	Preamp Factor (dB)	Level (dBuV/m)	Limit Line (dBuV/m)	Margin Limit (dB)	Polarization	Test value
1353.80	36.87	26.04	4.92	36.49	31.34	74.00	-42.66	Vertical	Peak
2310.54	36.22	28.05	6.62	37.65	33.24	74.00	-40.76	Vertical	
3120.06	36.60	28.80	7.62	38.21	34.81	74.00	-39.19	Vertical	
4821.76	43.43	31.56	9.55	36.90	47.64	74.00	-26.36	Vertical	
1257.47	37.42	26.24	4.76	36.54	31.88	74.00	-42.12	Horizontal	
3018.50	37.64	28.64	7.50	38.23	35.55	74.00	-38.45	Horizontal	
4821.76	43.53	31.56	9.55	36.90	47.74	74.00	-26.26	Horizontal	
7245.81	33.54	36.25	11.91	35.02	46.68	74.00	-27.32	Horizontal	

Remark:

1. Final Level = Receiver Read level + Antenna Factor + Cable Loss – Pre-amplifier Factor
2. The peak level is lower than average limit (54 dBuV/m), this data is the too weak instrument of signal is unable to test.
3. The emission levels of other frequencies are very lower than the limit and not show in test report.

802.11g					CH01				
Frequency (MHz)	Read Level (dBuV)	Antenna Factor (dB/m)	Cable Loss (dB)	Preamp Factor (dB)	Level (dBuV/m)	Limit Line (dBuV/m)	Margin Limit (dB)	Polarization	Test value
2292.96	36.15	28.06	6.59	37.60	33.20	74.00	-40.80	Vertical	Peak
3662.78	36.84	29.30	8.34	38.26	36.22	74.00	-37.78	Vertical	
4821.76	44.20	31.56	9.55	36.90	48.41	74.00	-25.59	Vertical	
6577.75	32.64	34.16	11.32	35.35	42.77	74.00	-31.23	Vertical	
2223.98	36.04	27.65	6.48	37.41	32.76	74.00	-41.24	Horizontal	
3588.94	35.77	29.27	8.25	38.29	35.00	74.00	-39.00	Horizontal	
4821.76	43.20	31.56	9.55	36.90	47.41	74.00	-26.59	Horizontal	
6594.52	31.41	34.19	11.35	35.36	41.59	74.00	-32.41	Horizontal	

802.11g					CH06				
Frequency (MHz)	Read Level (dBuV)	Antenna Factor (dB/m)	Cable Loss (dB)	Preamp Factor (dB)	Level (dBuV/m)	Limit Line (dBuV/m)	Margin Limit (dB)	Polarization	Test value
2281.32	35.49	27.99	6.57	37.57	32.48	74.00	-41.52	Vertical	Peak
3208.66	36.38	28.75	7.73	38.22	34.64	74.00	-39.36	Vertical	
4883.52	43.83	31.43	9.59	36.73	48.12	74.00	-25.88	Vertical	
6267.19	32.14	33.03	11.00	35.30	40.87	74.00	-33.13	Vertical	
1402.92	35.34	25.90	5.01	36.46	29.79	74.00	-44.21	Horizontal	
3498.74	36.55	28.99	8.11	38.41	35.24	74.00	-38.76	Horizontal	
4883.52	42.83	31.43	9.59	36.73	47.12	74.00	-26.88	Horizontal	
8571.38	32.25	37.19	12.88	34.48	47.84	74.00	-26.16	Horizontal	

802.11g					CH11				
Frequency (MHz)	Read Level (dBuV)	Antenna Factor (dB/m)	Cable Loss (dB)	Preamp Factor (dB)	Level (dBuV/m)	Limit Line (dBuV/m)	Margin Limit (dB)	Polarization	Test value
1685.12	35.48	25.16	5.74	36.90	29.48	74.00	-44.52	Vertical	Peak
3561.64	35.76	29.19	8.21	38.32	34.84	74.00	-39.16	Vertical	
4920.96	41.46	31.42	9.62	36.62	45.88	74.00	-28.12	Vertical	
7394.88	31.14	36.30	12.06	34.83	44.67	74.00	-29.33	Vertical	
1280.07	36.39	26.22	4.80	36.53	30.88	74.00	-43.12	Horizontal	
3104.22	35.70	28.80	7.61	38.21	33.90	74.00	-40.10	Horizontal	
4045.06	35.83	29.79	8.82	38.01	36.43	74.00	-37.57	Horizontal	
4920.96	42.46	31.42	9.62	36.62	46.88	74.00	-27.12	Horizontal	

Remark:

1. Final Level = Receiver Read level + Antenna Factor + Cable Loss – Preamplifier Factor
2. The peak level is lower than average limit(54 dBuV/m), this data is the too weak instrument of signal is unable to test.
3. The emission levels of other frequencies are very lower than the limit and not show in test report.

802.11n(HT20)					CH01				
Frequency (MHz)	Read Level (dBuV)	Antenna Factor (dB/m)	Cable Loss (dB)	Preamp Factor (dB)	Level (dBuV/m)	Limit Line (dBuV/m)	Margin Limit (dB)	Polarization	Test value
2292.96	36.15	28.06	6.59	37.60	33.20	74.00	-40.80	Vertical	Peak
3662.78	36.84	29.30	8.34	38.26	36.22	74.00	-37.78	Vertical	
4821.76	44.20	31.56	9.55	36.90	48.41	74.00	-25.59	Vertical	
6577.75	32.64	34.16	11.32	35.35	42.77	74.00	-31.23	Vertical	
2223.98	36.04	27.65	6.48	37.41	32.76	74.00	-41.24	Horizontal	
3588.94	35.77	29.27	8.25	38.29	35.00	74.00	-39.00	Horizontal	
4821.76	43.20	31.56	9.55	36.90	47.41	74.00	-26.59	Horizontal	
6594.52	31.41	34.19	11.35	35.36	41.59	74.00	-32.41	Horizontal	

802.11n(HT20)					CH06				
Frequency (MHz)	Read Level (dBuV)	Antenna Factor (dB/m)	Cable Loss (dB)	Preamp Factor (dB)	Level (dBuV/m)	Limit Line (dBuV/m)	Margin Limit (dB)	Polarization	Test value
2281.32	35.49	27.99	6.57	37.57	32.48	74.00	-41.52	Vertical	Peak
3208.66	36.38	28.75	7.73	38.22	34.64	74.00	-39.36	Vertical	
4883.52	43.83	31.43	9.59	36.73	48.12	74.00	-25.88	Vertical	
6267.19	32.14	33.03	11.00	35.30	40.87	74.00	-33.13	Vertical	
2162.57	35.12	27.20	6.41	37.33	31.40	74.00	-42.60	Horizontal	
3498.74	36.55	28.99	8.11	38.41	35.24	74.00	-38.76	Horizontal	
4883.52	42.83	31.43	9.59	36.73	47.12	74.00	-26.88	Horizontal	
7820.82	31.83	36.23	13.16	35.01	46.21	74.00	-27.79	Horizontal	

802.11n(HT20)					CH11				
Frequency (MHz)	Read Level (dBuV)	Antenna Factor (dB/m)	Cable Loss (dB)	Preamp Factor (dB)	Level (dBuV/m)	Limit Line (dBuV/m)	Margin Limit (dB)	Polarization	Test value
1685.12	35.48	25.16	5.74	36.90	29.48	74.00	-44.52	Vertical	Peak
3561.64	35.76	29.19	8.21	38.32	34.84	74.00	-39.16	Vertical	
4920.96	41.46	31.42	9.62	36.62	45.88	74.00	-28.12	Vertical	
7394.88	31.14	36.30	12.06	34.83	44.67	74.00	-29.33	Vertical	
1360.71	34.84	26.02	4.93	36.48	29.31	74.00	-44.69	Horizontal	
4045.06	35.83	29.79	8.82	38.01	36.43	74.00	-37.57	Horizontal	
4920.96	42.46	31.42	9.62	36.62	46.88	74.00	-27.12	Horizontal	
8083.96	32.31	37.02	12.50	34.54	47.29	74.00	-26.71	Horizontal	

Remark:

1. Final Level = Receiver Read level + Antenna Factor + Cable Loss – Preamplifier Factor
2. The peak level is lower than average limit(54 dBuV/m), this data is the too weak instrument of signal is unable to test.
3. The emission levels of other frequencies are very lower than the limit and not show in test report.

802.11n(HT40)					CH03				
Frequency (MHz)	Read Level (dBuV)	Antenna Factor (dB/m)	Cable Loss (dB)	Preamp Factor (dB)	Level (dBuV/m)	Limit Line (dBuV/m)	Margin Limit (dB)	Polarization	Test value
2140.66	35.61	27.03	6.39	37.33	31.70	74.00	-42.30	Vertical	Peak
3579.82	35.42	29.24	8.24	38.30	34.60	74.00	-39.40	Vertical	
4846.37	44.11	31.51	9.57	36.83	48.36	74.00	-25.64	Vertical	
7027.82	32.69	35.38	11.85	34.83	45.09	74.00	-28.91	Vertical	
2229.65	36.51	27.68	6.49	37.42	33.26	74.00	-40.74	Horizontal	
3903.44	35.97	29.70	8.64	38.17	36.14	74.00	-37.86	Horizontal	
4846.37	44.11	31.51	9.57	36.83	48.36	74.00	-25.64	Horizontal	
7027.82	32.69	35.38	11.85	34.83	45.09	74.00	-28.91	Horizontal	

802.11n(HT40)					CH06				
Frequency (MHz)	Read Level (dBuV)	Antenna Factor (dB/m)	Cable Loss (dB)	Preamp Factor (dB)	Level (dBuV/m)	Limit Line (dBuV/m)	Margin Limit (dB)	Polarization	Test value
1764.12	37.52	25.33	5.89	37.06	31.68	74.00	-42.32	Vertical	Peak
3579.82	35.66	29.24	8.24	38.30	34.84	74.00	-39.16	Vertical	
4871.10	45.73	31.46	9.59	36.76	50.02	74.00	-23.98	Vertical	
7027.82	32.00	35.38	11.85	34.83	44.40	74.00	-29.60	Vertical	
1759.64	37.08	25.32	5.88	37.06	31.22	74.00	-42.78	Horizontal	
3135.99	35.92	28.80	7.64	38.21	34.15	74.00	-39.85	Horizontal	
4883.52	43.78	31.43	9.59	36.73	48.07	74.00	-25.93	Horizontal	
6851.19	32.88	34.36	11.66	34.94	43.96	74.00	-30.04	Horizontal	

802.11n(HT40)					CH09				
Frequency (MHz)	Read Level (dBuV)	Antenna Factor (dB/m)	Cable Loss (dB)	Preamp Factor (dB)	Level (dBuV/m)	Limit Line (dBuV/m)	Margin Limit (dB)	Polarization	Test value
1711.05	36.21	25.22	5.79	36.95	30.27	74.00	-43.73	Vertical	Peak
2212.68	36.21	27.58	6.46	37.38	32.87	74.00	-41.13	Vertical	
3135.99	36.19	28.80	7.64	38.21	34.42	74.00	-39.58	Vertical	
4895.97	42.94	31.41	9.60	36.69	47.26	74.00	-26.74	Vertical	
2162.57	36.86	27.20	6.41	37.33	33.14	74.00	-40.86	Horizontal	
3588.94	35.75	29.27	8.25	38.29	34.98	74.00	-39.02	Horizontal	
4895.97	44.30	31.41	9.60	36.69	48.62	74.00	-25.38	Horizontal	
6594.52	32.18	34.19	11.35	35.36	42.36	74.00	-31.64	Horizontal	

Remark:

1. Final Level = Receiver Read level + Antenna Factor + Cable Loss – Pre-amplifier Factor
2. The peak level is lower than average limit(54 dBuV/m), this data is the too weak instrument of signal is unable to test.
3. The emission levels of other frequencies are very lower than the limit and not show in test report.

6. Test Setup Photos of the EUT

Conducted Emissions (AC Mains)

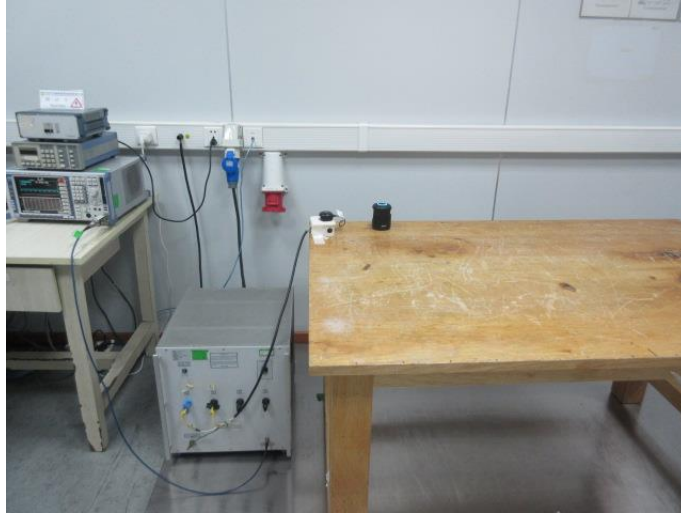

Radiated Emissions



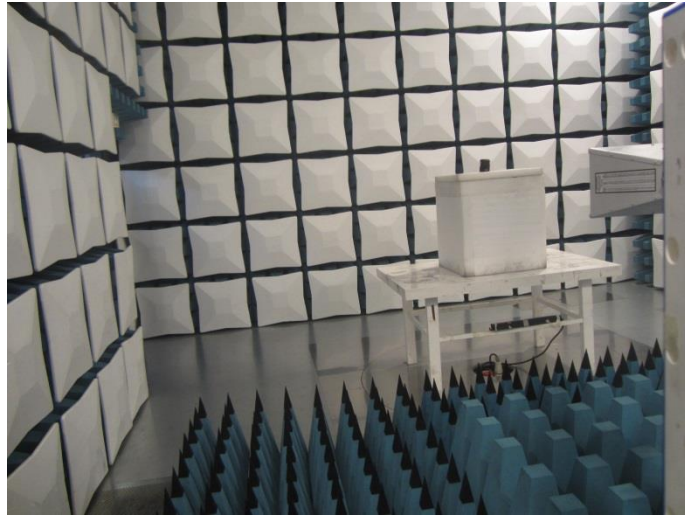

7. External and Internal Photos of the EUT

External Photos of the EUT







Internal Photos of the EUT

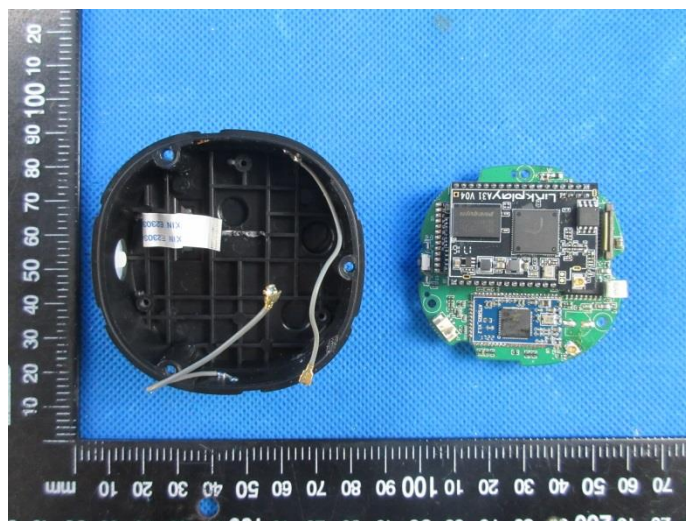
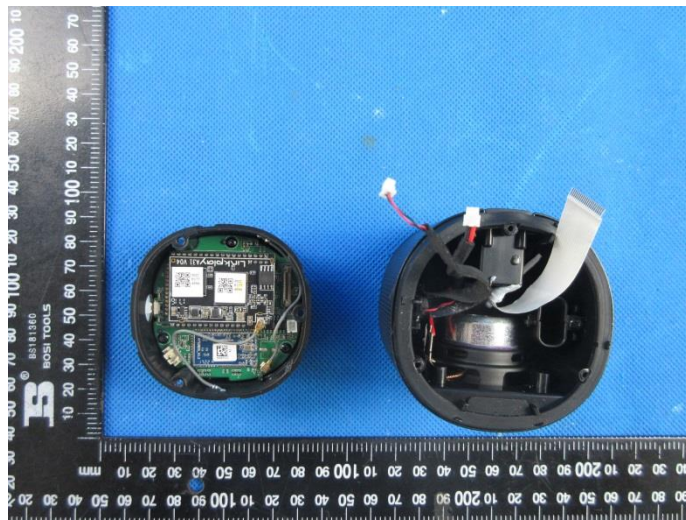

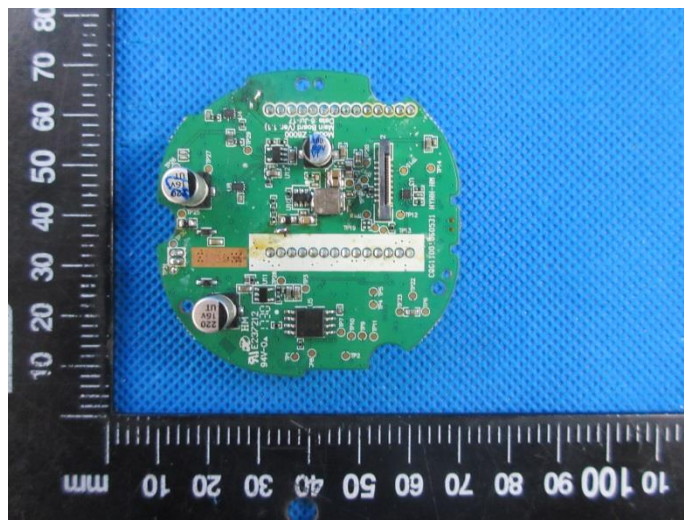
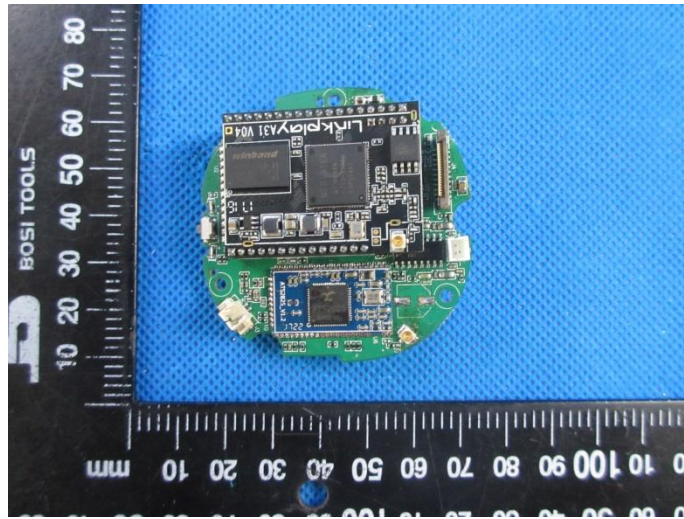

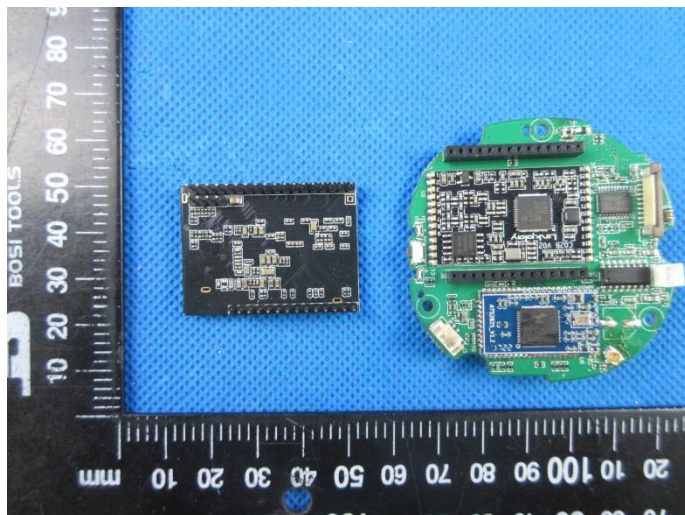
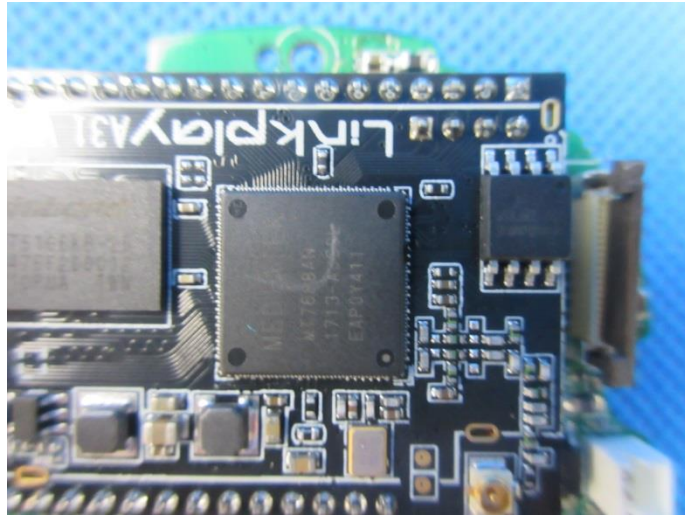

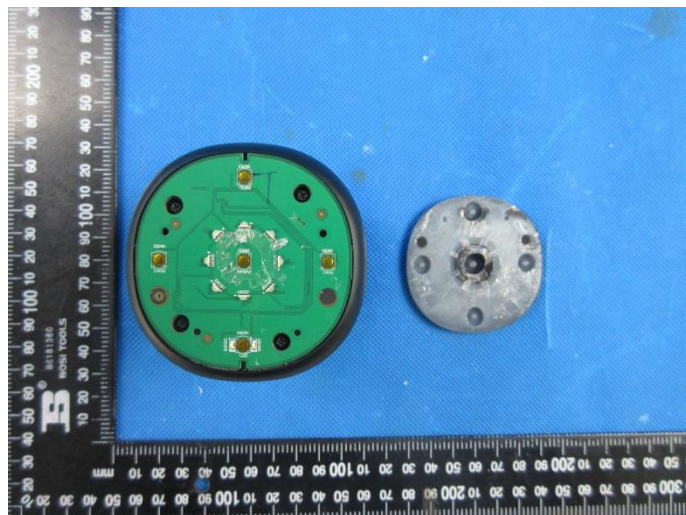
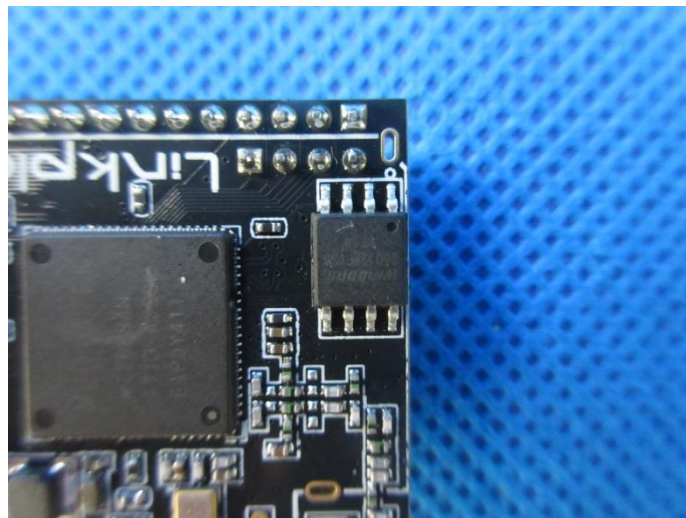
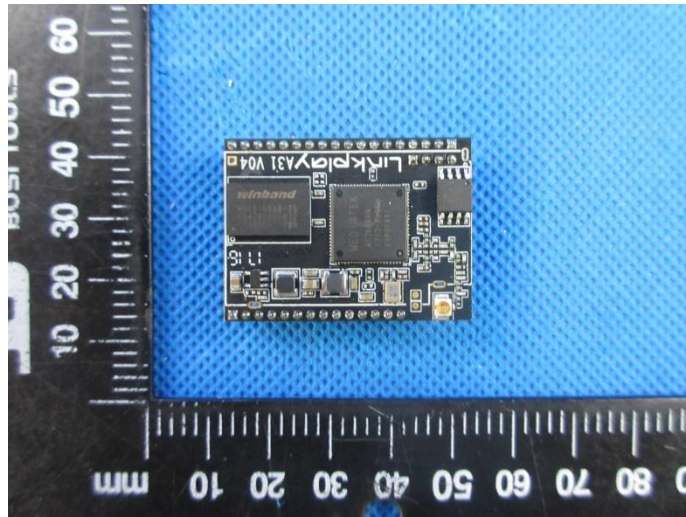

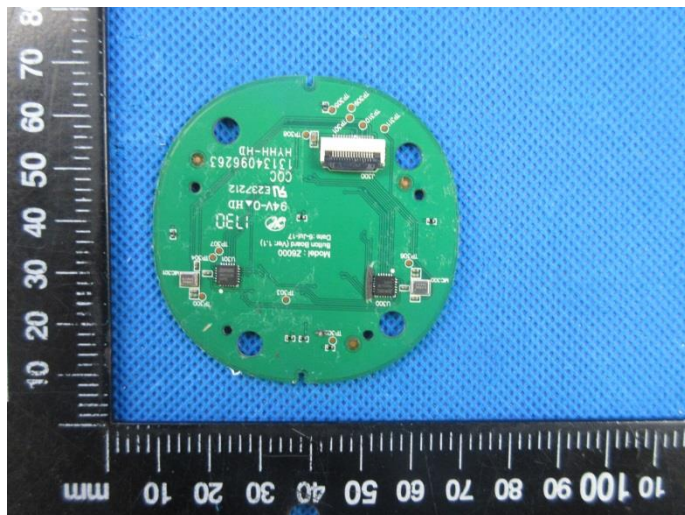
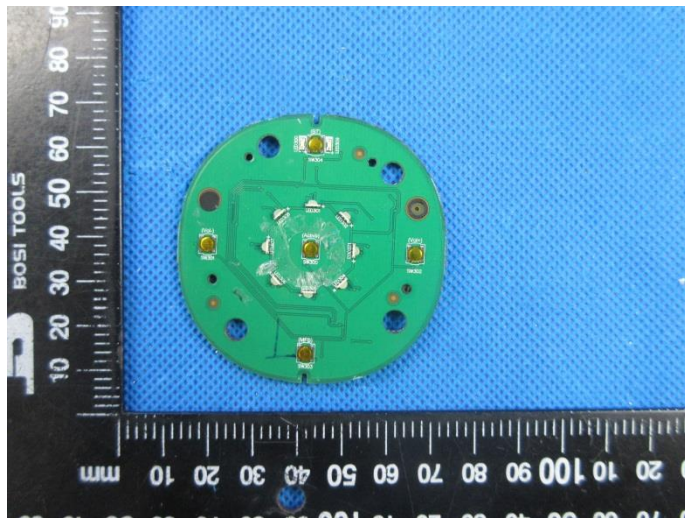

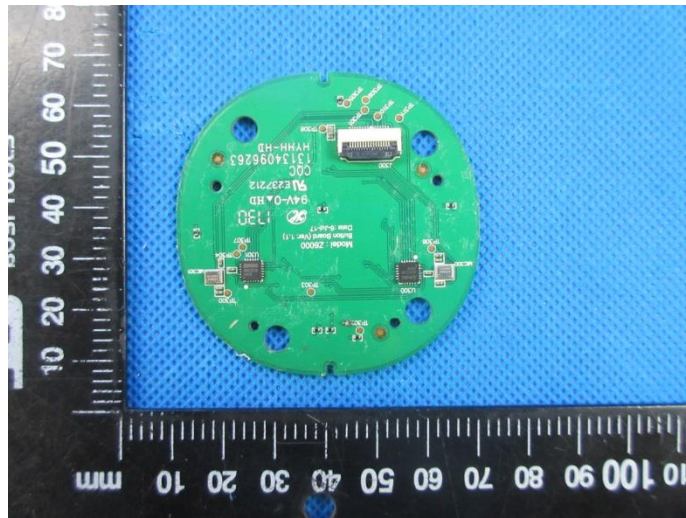

-----End of Report-----