



FCC RADIO TEST REPORT

FCC ID: 2AB7K-R5141

Product : Roav VIVA X

Trade Name : Roav

Model Name : R5141

Serial Model : N/A

Report No. : NTEK-2017NT08316130F3

Prepared for

Anker Technology Co., Limited
Room 1318-19, Hollywood Plaza, 610 Nathan Road, Mongkok,
Kowloon, Hong Kong

Prepared by

NTEK Testing Technology Co., Ltd.
1/F, Building E, Fenda Science Park, Sanwei Community, Xixiang Street
Bao'an District, Shenzhen P.R. China
Tel.: +86-0755-61156588 Fax.: +86-0755-61156599
Website: www.ntek.org.cn

TEST RESULT CERTIFICATION

Applicant's name : Anker Technology Co., Limited
Address : Room 1318-19, Hollywood Plaza, 610 Nathan Road, Mongkok, Kowloon, Hong Kong

Manufacture's Name : Anker Technology Co., Limited
Address : Room 1318-19, Hollywood Plaza, 610 Nathan Road, Mongkok, Kowloon, Hong Kong

Product description

Product name..... : Roav VIVA X

Model and/or type reference : R5141

Serial Model : N/A

Rating(s)..... : DC 12-24V

Standards : FCC 47 CFR Part 15, Subpart C §15.239:2017

Test procedure ANSI C63.10-2013

This device described above has been tested by NTEK, and the test results show that the equipment under test (EUT) is in compliance with the FCC requirements. And it is applicable only to the tested sample identified in the report.

This report shall not be reproduced except in full, without the written approval of NTEK, this document may be altered or revised by NTEK, personal only, and shall be noted in the revision of the document.

Date of Test :

Date (s) of performance of tests..... : 31 Aug. 2017 ~ 19 Oct. 2017

Date of Issue..... : 20 Oct. 2017

Test Result..... : **Pass**

Testing Engineer : Lake Xie
(Lake Xie)

Technical Manager : Jason Chen
(Jason Chen)

Authorized Signatory : Sam. Chen
(Sam Chen)

Table of Contents	Page
1 . SUMMARY OF TEST RESULTS	4
1.1 TEST FACILITY	5
1.2 MEASUREMENT UNCERTAINTY	5
2 . GENERAL INFORMATION	6
2.1 GENERAL DESCRIPTION OF EUT	6
2.2 DESCRIPTION OF TEST MODES	7
2.3 BLOCK DIGRAM SHOWING THE CONFIGURATION OF SYSTEM TESTED	8
2.4 DESCRIPTION OF SUPPORT UNITS(CONDUCTED MODE)	9
2.5 EQUIPMENTS LIST FOR ALL TEST ITEMS	10
3 . ANTENNA REQUIREMENT	11
3.1 STANDARD REQUIREMENT	11
3.2 EUT ANTENNA	11
3.3 CONDUCTED EMISSION MEASUREMENT	12
3.3.1 POWER LINE CONDUCTED EMISSION LIMITS	12
3.3.2 TEST PROCEDURE	13
3.3.3 DEVIATION FROM TEST STANDARD	13
3.3.4 TEST SETUP	13
3.2.5 TEST RESULT	14
3.4 RADIATED EMISSION MEASUREMENT	15
3.4.1 RADIATED EMISSION LIMITS	15
3.4.2 TEST PROCEDURE	16
3.4.3 DEVIATION FROM TEST STANDARD	16
3.4.4 TEST SETUP	17
3.4.5 TEST RESULTS (BLOW 30MHZ)	18
3.4.6 TEST RESULTS (BETWEEN 30 – 1000 MHZ)	19
3.4.7 TEST RESULTS (BAND EDGE EMISSION)	25
4 . BANDWIDTH TEST	29
4.1 TEST PROCEDURE	29
4.2 DEVIATION FROM STANDARD	29
4.3 TEST SETUP	29
4.4 TEST RESULTS	30
APPENDIX-PHOTOGRAPHS OF EUT CONSTRUCTIONAL DETAILS	

1. SUMMARY OF TEST RESULTS

Test procedures according to the technical standards:

FCC Part15, Subpart C (15.239)			
Standard Section	Test Item	Judgment	Remark
15.207	Conducted Emission	N/A	
15.203	Antenna Requirement	Pass	
15.239	Radiated Spurious Emission	Pass	
15.239	Occupied Bandwidth	Pass	
15.205	Band Edge Emission	Pass	

1.1 TEST FACILITY

NTEK Testing Technology Co., Ltd

Add. : 1/F, Building E, Fenda Science Park, Sanwei Community, Xixiang Street, Bao'an District, Shenzhen P.R. China.

FCC FRN Registration No.:238937; IC Registration No.:9270A-1

CNAS Registration No.:L5516

1.2 MEASUREMENT UNCERTAINTY

The reported uncertainty of measurement $y \pm U$, where expanded uncertainty U is based on a standard uncertainty multiplied by a coverage factor of $k=2$, providing a level of confidence of approximately 95 %.

No.	Item	Uncertainty
1	Conducted Emission Test	$\pm 1.38\text{dB}$
2	RF power,conducted	$\pm 0.16\text{dB}$
3	Spurious emissions,conducted	$\pm 0.21\text{dB}$
4	All emissions,radiated(<1G)	$\pm 4.68\text{dB}$
5	All emissions,radiated(>1G)	$\pm 4.89\text{dB}$
6	Temperature	$\pm 0.5^{\circ}\text{C}$
7	Humidity	$\pm 2\%$

2. GENERAL INFORMATION

2.1 GENERAL DESCRIPTION OF EUT

Equipment	Roav VIVA X	
Trade Name	Roav	
Model Name	R5141	
Serial Model	N/A	
Model Difference	N/A	
Product Description	The EUT is a Roav VIVA X	
	Product Type	Low Power Communication Device Transmitter
	Operation Frequency:	88.1-107.9MHz
	Modulation Type:	FM
	Number Of Channel	199CH.
	Antenna Designation:	spring antenna
	Antenna Gain(Peak)	1 dBi
	Field Strength:	45.7 dBuV/m
Power supply	<input checked="" type="checkbox"/> DC supply: DC 12V-24V	
	<input type="checkbox"/> Adapter supply:	
Battery	N/A	
Hard Ware Version	V0.6	
Soft Ware Version	V2.1.3	

Note:

1. For a more detailed features description, please refer to the manufacturer's specifications or the User's Manual.

2.2 DESCRIPTION OF TEST MODES

To investigate the maximum EMI emission characteristics generated from EUT, the test system was pre-scanning tested based on the consideration of following EUT operation mode or test configuration mode which possibly have effect on EMI emission level. Each of these EUT operation mode(s) or test configuration mode(s) mentioned above was evaluated respectively.

Pretest Mode	Description
Mode 1	88.1MHz
Mode 100	98.1MHz
Mode 199	107.9MHz

For Conducted Emission	
Final Test Mode	Description
N/A	N/A

For Radiated Emission	
Final Test Mode	Description
Mode 1	88.1MHz
Mode 100	98.1MHz
Mode 199	107.9MHz

Note:

- (1) The measurements are performed at the highest, middle, lowest available channels.
- (2) The EUT use new battery.
- (3) During testing, the EUT was actively playing music set to its maximum audio volume in order to generate the worst case emissions (e.g. to generate the maximum bandwidth during bandwidth test). No test tones were used for testing. The tuning range of the EUT was manually verified and the conclusion is that it only works at selected channels within 88.1-107.9MHz, not below and not above this range.

2.3 BLOCK DIGRAM SHOWING THE CONFIGURATION OF SYSTEM TESTED

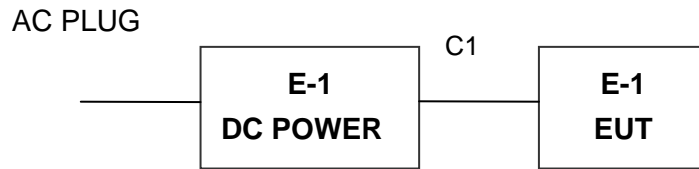

2.4 DESCRIPTION OF SUPPORT UNITS(CONDUCTED MODE)

The EUT has been tested as an independent unit together with other necessary accessories or support units. The following support units or accessories were used to form a representative test configuration during the tests.

Item	Equipment	Mfr/Brand	Model/Type No.	Series No.	Note
E-1	Roav VIVA X	Roav	R5141	N/A	EUT
E-2	DC POWER	N/A	N/A	N/A	Peripherals

Item	Shielded Type	Ferrite Core	Length	Note
C-1	DC Cable	NO	NO	1.2m

Note:

- (1) The support equipment was authorized by Declaration of Confirmation.
- (2) For detachable type I/O cable should be specified the length in cm in 『Length』 column.

2.5 EQUIPMENTS LIST FOR ALL TEST ITEMS

Radiation Test equipment

Item	Kind of Equipment	Manufacturer	Type No.	Serial No.	Calibrated until
1	Spectrum Analyzer	Agilent	E4407B	160400005	Jul. 06. 2018
2	Test Receiver	R&S	ESPI	101318	Jul. 06. 2018
3	Bilog Antenna	TESEQ	CBL6111D	31216	Jul. 06. 2018
4	50Ω Coaxial Switch	Anritsu	MP59B	6200264416	Jul. 06. 2018
5	Spectrum Analyzer	ADVANTEST	R3132	150900201	Jul. 06. 2018
6	Horn Antenna	EM	EM-AH-10180	2011071402	Jul. 06. 2018
7	Horn Ant	Schwarzbeck	BBHA 9170	9170-181	Jul. 06. 2018
8	Amplifier	EM	EM-30180	060538	Jul. 06. 2018
9	Loop Antenna	ARA	PLA-1030/B	1029	Jul. 06. 2018
10	Power Meter	R&S	NRVS	100696	Jul. 06. 2018

Conduction Test equipment

Item	Kind of Equipment	Manufacturer	Type No.	Serial No.	Calibrated until
1	Test Receiver	R&S	ESCI	101160	Jul. 06. 2018
2	LISN	R&S	ENV216	101313	Jul. 06. 2018
3	LISN	EMCO	3816/2	00042990	Jul. 06. 2018
4	50Ω Coaxial Switch	Anritsu	MP59B	6200264417	Jul. 06. 2018
5	Passive Voltage Probe	R&S	ESH2-Z3	100196	Jul. 06. 2018
6	Absorbing clamp	R&S	MOS-21	100423	Jul. 06. 2018

3. ANTENNA REQUIREMENT

3.1 STANDARD REQUIREMENT

15.203 requirement: For intentional device, according to 15.203: an intentional radiator shall be designed to ensure that no antenna other than that furnished by the responsible party shall be used with the device.

3.2 EUT ANTENNA

The EUT antenna is permanent attached Antenna. It comply with the standard requirement.

3.3 CONDUCTED EMISSION MEASUREMENT

3.3.1 POWER LINE CONDUCTED EMISSION Limits (Frequency Range 150KHz-30MHz)

FREQUENCY (MHz)	Class A (dBuV)		Class B (dBuV)		Standard
	Quasi-peak	Average	Quasi-peak	Average	
0.15 -0.5			66 - 56 *	56 - 46 *	CISPR
0.50 -5.0			56.00	46.00	CISPR
5.0 -30.0			60.00	50.00	CISPR

0.15 -0.5			66 - 56 *	56 - 46 *	LP002.
0.50 -5.0			56.00	46.00	LP002.
5.0 -30.0			60.00	50.00	LP002.

Note:

- (1) The tighter limit applies at the band edges.
- (2) The limit of " * " marked band means the limitation decreases linearly with the logarithm of the frequency in the range.

The following table is the setting of the receiver

Receiver Parameters	Setting
Attenuation	10 dB
Start Frequency	0.15 MHz
Stop Frequency	30 MHz
IF Bandwidth	9 kHz

3.3.2 TEST PROCEDURE

- a. The EUT was placed 0.4 meters from the horizontal ground plane with EUT being connected to the power mains through a line impedance stabilization network (LISN). All other support equipments powered from additional LISN(s). The LISN provide 50 Ohm/ 50uH of coupling impedance for the measuring instrument.
- b. Interconnecting cables that hang closer than 40 cm to the ground plane shall be folded back and forth in the center forming a bundle 30 to 40 cm long.
- c. I/O cables that are not connected to a peripheral shall be bundled in the center. The end of the cable may be terminated, if required, using the correct terminating impedance. The overall length shall not exceed 1 m.
- d. LISN at least 80 cm from nearest part of EUT chassis.
- e. For the actual test configuration, please refer to the related Item –EUT Test Photos.

3.3.3 DEVIATION FROM TEST STANDARD

No deviation

3.3.4 TEST SETUP

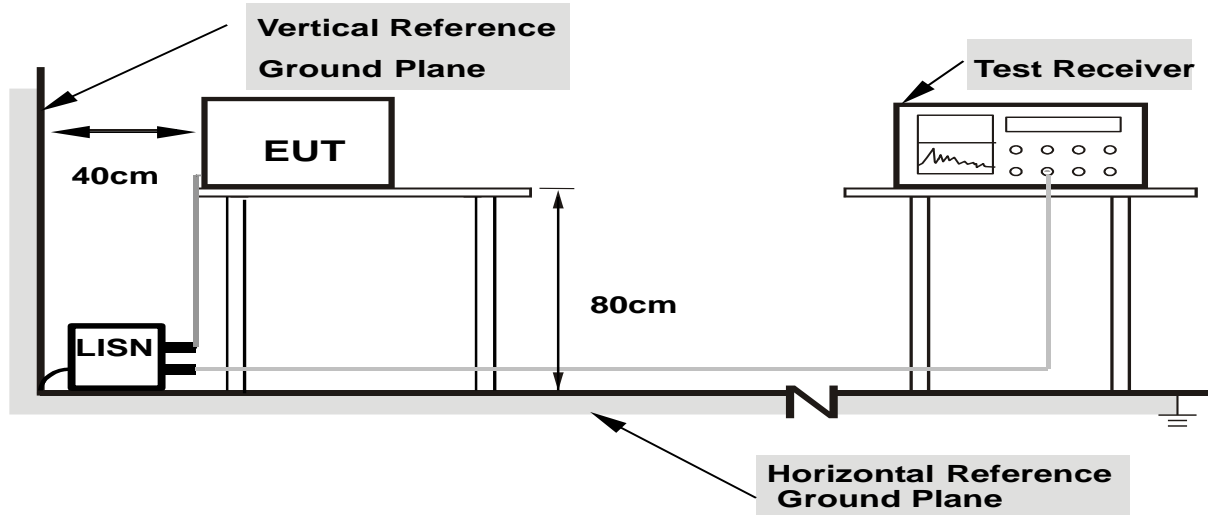

- Note: 1.Support units were connected to second LISN.
 2.Both of LISNs (AMN) are 80 cm from EUT and at least 80 from other units and other metal planes**

3.2.5 TEST RESULT

EUT :	Roav VIVA X	Model Name. :	R5141
Temperature :	26 °C	Relative Humidity :	54%
Pressure :	1010hPa	Phase :	N/A
Test Voltage :	N/A	Test Mode :	N/A

3.4 RADIATED EMISSION MEASUREMENT

3.4.1 Radiated Emission Limits (FCC 15.209)

Frequencies (MHz)	Field Strength (micorvolts/meter)	Measurement Distance (meters)
0.009~0.490	2400/F(KHz)	300
0.490~1.705	24000/F(KHz)	30
1.705~30.0	30	30
30~88	100	3
88~216	150	3
216~960	200	3
Above 960	500	3

Note:

- (1) The tighter limit applies at the band edges.
- (2) Emission level (dBuV/m)=20log Emission level (uV/m).

LIMITS OF RADIATED EMISSION MEASUREMENT (FCC 15.239)

Frequency of Emission (MHz)	Field Strength of fundamental (dBuV/m)	
	Peak	Average
88-108	68	48

Notes:

- (1) Fcc part15.239 (b) The field strength of any emissions within the permitted 200 kHz band shall not exceed 250 microvolts/meter at 3 meters. The emission limit in this paragraph is based on measurement instrumentation employing an average detector. The provisions in Section 15.35 for limiting peak emissions apply.

Spectrum Parameter	Setting
Attenuation	Auto
Start Frequency	1000 MHz
Stop Frequency	10th carrier harmonic
RB / VB (emission in restricted band)	1MHz / 1MHz for Peak

Receiver Parameter	Setting
Attenuation	Auto
Start ~ Stop Frequency	9kHz~150kHz / RB 200Hz for QP
Start ~ Stop Frequency	150kHz~30MHz / RB 9kHz for QP
Start ~ Stop Frequency	30MHz~1000MHz / RB 120kHz for QP

3.4.2 TEST PROCEDURE

- a. The measuring distance of at 3 m shall be used for measurements at frequency up to 1GHz. For frequencies above 1GHz, any suitable measuring distance may be used.
- b. The EUT was placed on the top of a rotating table 0.8 meters above the ground at a 3m meter open area test site. The table was rotated 360 degrees to determine the position of the highest radiation.
- c. The height of the equipment or of the substitution antenna shall be 0.8 m; the height of the test antenna shall vary between 1 m to 4 m.
- d. The initial step in collecting conducted emission data is a spectrum analyzer peak detector mode pre-scanning the measurement frequency range. Significant peaks are then marked and then Quasi Peak detector mode re-measured.
- e. If the Peak Mode measured value compliance with and lower than Quasi Peak Mode Limit, the EUT shall be deemed to meet QP Limits and then no additional QP Mode measurement performed.
- f. For the actual test configuration, please refer to the related Item –EUT Test Photos.

Note:

Both horizontal and vertical antenna polarities were tested and performed pretest to three orthogonal axis. The worst case emissions were reported

3.4.3 DEVIATION FROM TEST STANDARD

No deviation

3.4.4 TEST SETUP

(a) For radiated emissions below 30MHz

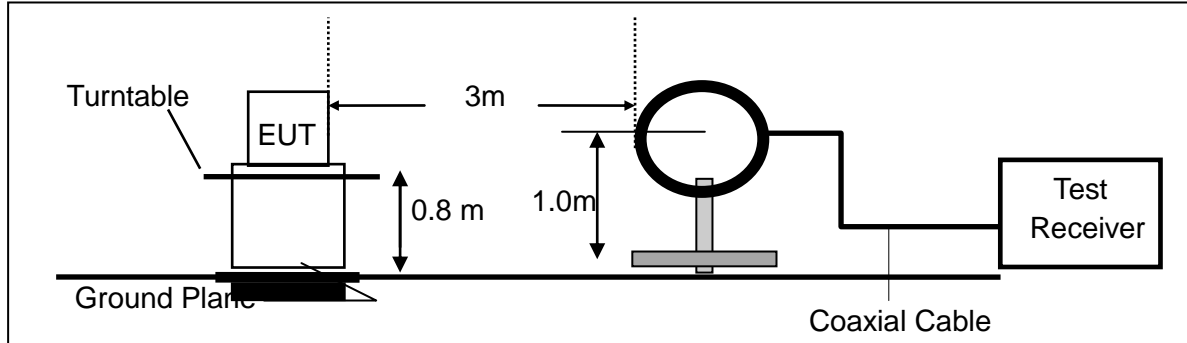

(b) For radiated emissions from 30MHz to 1000MHz

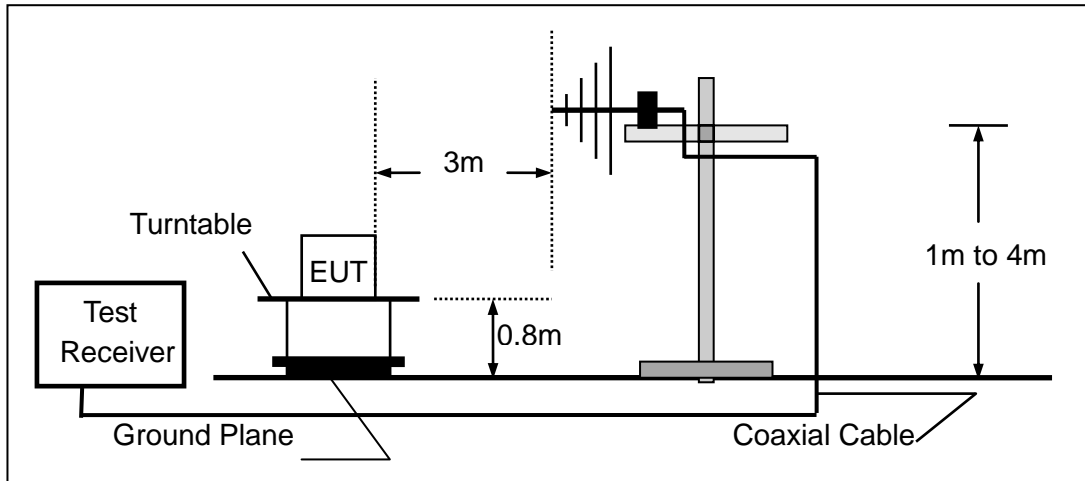

(c) For radiated emissions above 1000MHz

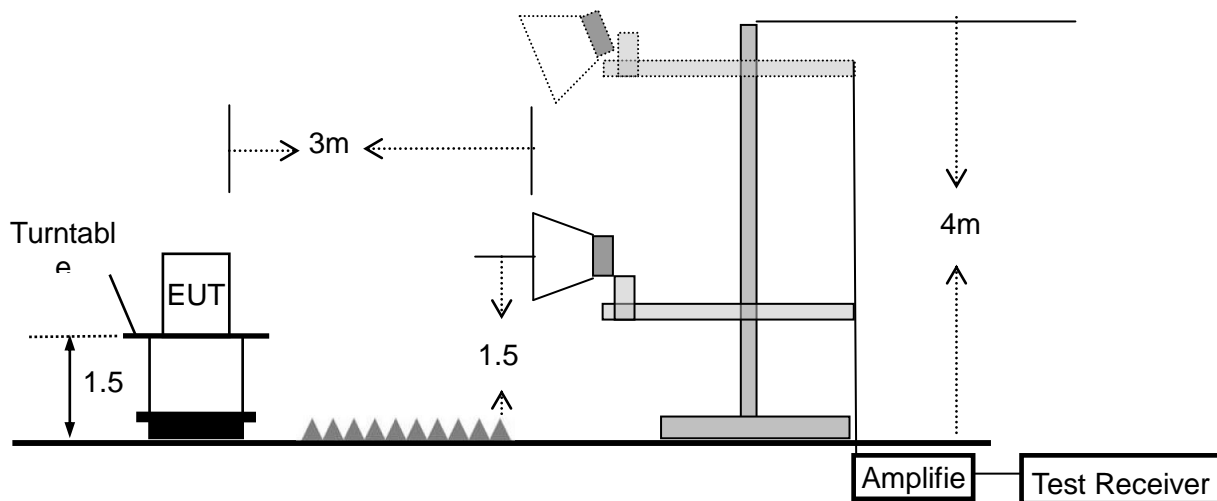

3.4.5 TEST RESULTS (BLOW 30MHz)

EUT :	Roav VIVA X	Model Name. :	R5141
Temperature :	20 °C	Relative Humidity :	48%
Pressure :	1010 hPa	Test Voltage :	DC 12.0V
Test Mode :	TX	Polarization :	--

Freq.	Reading	Limit	Margin	State
(MHz)	(dBuV/m)	(dBuV/m)	(dB)	P/F
--	--	--	--	PASS
--	--	--	--	PASS

NOTE:

The amplitude of spurious emissions which are attenuated by more than 20dB below the permissible value has no need to be reported.

Distance extrapolation factor = $20 \log (\text{specific distance}/\text{test distance})$ (dB);

Limit line = specific limits(dBuv) + distance extrapolation factor.

3.4.6 TEST RESULTS (BETWEEN 30 – 1000 MHZ)

EUT :	Roav VIVA X	Model Name :	R5141
Temperature :	20 °C	Relative Humidity :	48%
Pressure :	1010 hPa	Test Voltage :	DC 12.0V
Test Mode :	88.1MHz	Polarization :	Vertical

Frequency (MHz)	Meter Reading (dBμV)	Factor (dB)	Emission Level (dBμV/m)	Limits (dBμV/m)	Margin (dB)	Remark
88.0325	33.04	11.76	44.80	68.00	-23.20	peak
88.0325	23.39	11.76	35.15	68.00	-32.85	QP
236.6447	17.07	12.03	29.10	46.00	-16.90	QP
330.1949	12.20	13.90	26.10	46.00	-19.90	QP
423.5403	12.89	16.71	29.60	46.00	-16.40	QP
651.9416	6.78	20.83	27.61	46.00	-18.39	QP
875.2469	6.25	25.93	32.18	46.00	-13.82	QP

Remark:

1. Factor = Antenna Factor + Cable Loss – Pre-amplifier.

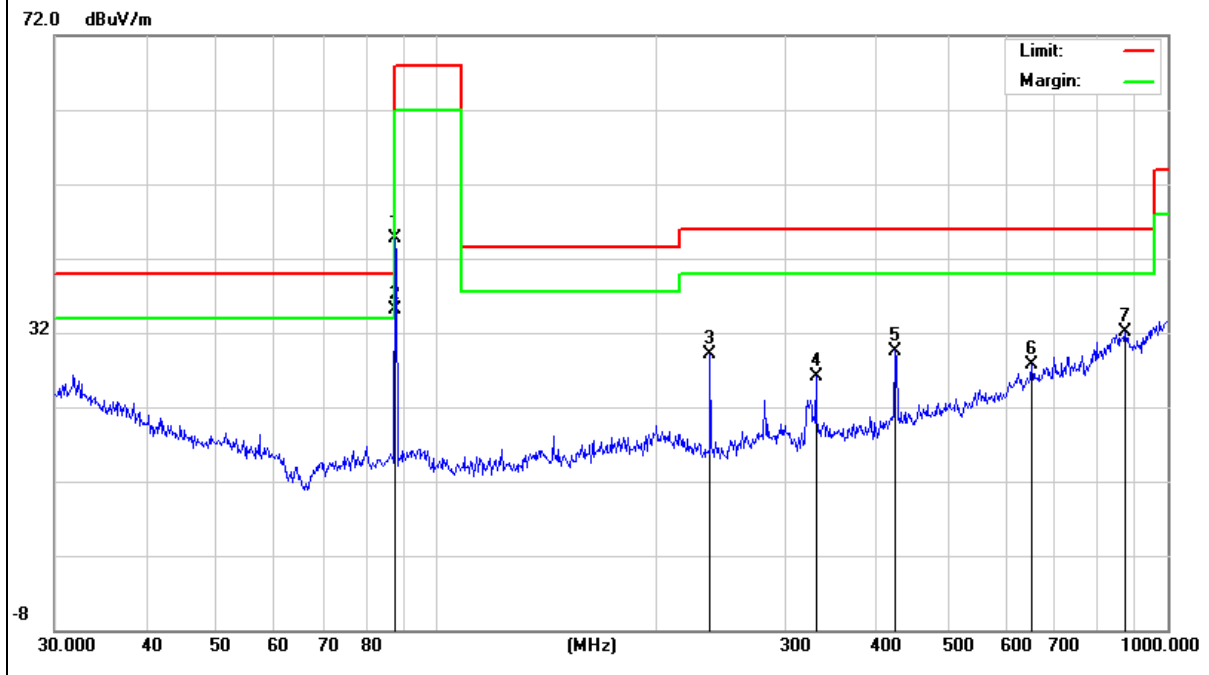

EUT :	Roav VIVA X	Model Name :	R5141
Temperature :	20 °C	Relative Humidity :	48%
Pressure :	1010 hPa	Test Voltage :	DC 12.0V
Test Mode :	88.1MHz	Polarization :	Horizontal

Frequency (MHz)	Meter Reading (dBµV)	Factor (dB)	Emission Level (dBµV/m)	Limits (dBµV/m)	Margin (dB)	Remark
73.8756	12.27	10.73	23.00	40.00	-17.00	QP
88.0328	31.74	11.76	43.50	68.00	-24.50	peak
88.0328	24.79	11.76	36.55	68.00	-31.45	QP
135.0319	10.00	11.70	21.70	43.50	-21.80	QP
357.9286	12.16	14.44	26.60	46.00	-19.40	QP
400.4318	14.28	15.12	29.40	46.00	-16.60	QP
582.7424	11.66	18.94	30.60	46.00	-15.40	QP

Remark:

1. Factor = Antenna Factor + Cable Loss – Pre-amplifier.

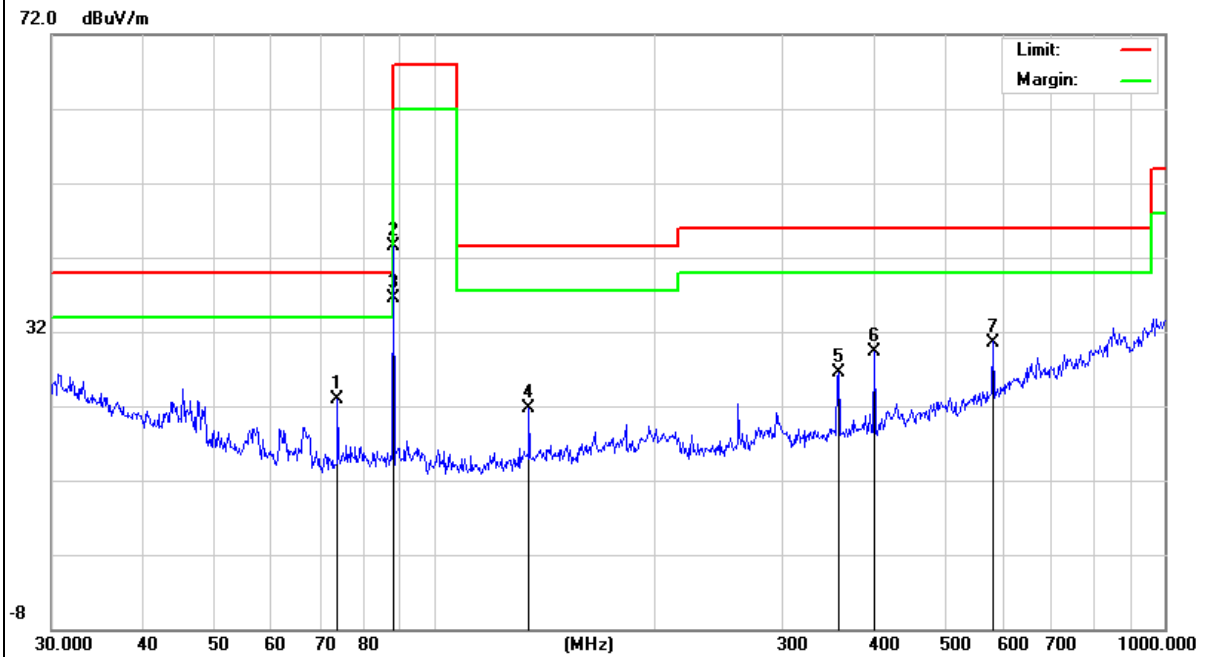

EUT :	Roav VIVA X	Model Name :	R5141
Temperature :	20 °C	Relative Humidity :	48%
Pressure :	1010 hPa	Test Voltage :	DC 12.0V
Test Mode :	98.1MHz	Polarization :	Vertical

Frequency (MHz)	Meter Reading (dBμV)	Factor (dB)	Emission Level (dBμV/m)	Limits (dBμV/m)	Margin (dB)	Remark
50.7637	9.49	13.31	22.80	40.00	-17.20	QP
98.1120	33.27	10.23	43.50	68.00	-24.50	peak
98.1120	26.54	10.23	36.77	68.00	-31.23	QP
164.9074	12.13	12.47	24.60	43.50	-18.90	QP
281.0074	8.91	14.09	23.00	46.00	-23.00	QP
330.1949	12.20	13.90	26.10	46.00	-19.90	QP
423.5403	12.89	16.71	29.60	46.00	-16.40	QP

Remark:

1. Factor = Antenna Factor + Cable Loss – Pre-amplifier.

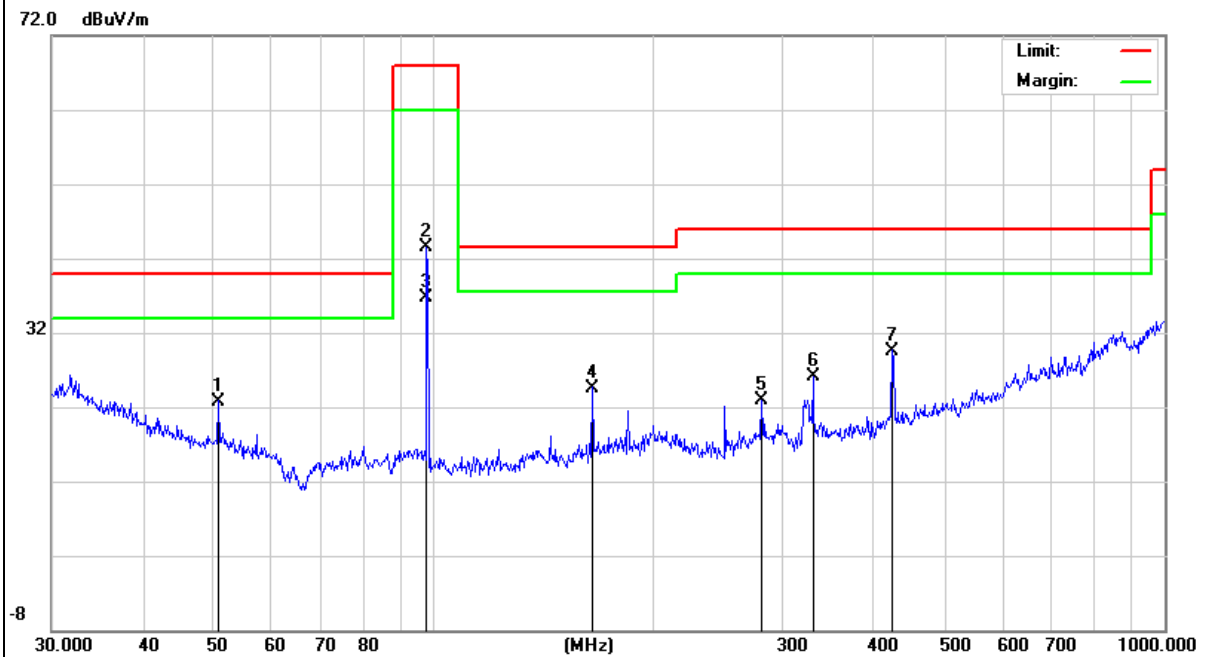

EUT :	Roav VIVA X	Model Name :	R5141
Temperature :	20 °C	Relative Humidity :	48%
Pressure :	1010 hPa	Test Voltage :	DC 12.0V
Test Mode :	98.1MHz	Polarization :	Horizontal

Frequency (MHz)	Meter Reading (dBμV)	Factor (dB)	Emission Level (dBμV/m)	Limits (dBμV/m)	Margin (dB)	Remark
73.8756	12.27	10.73	23.00	40.00	-17.00	QP
98.1312	32.37	10.23	42.60	68.00	-25.40	peak
98.1312	23.88	10.23	34.11	68.00	-33.89	QP
135.0319	10.00	11.70	21.70	43.50	-21.80	QP
164.3301	10.55	12.45	23.00	43.50	-20.50	QP
400.4318	14.28	15.12	29.40	46.00	-16.60	QP
582.7424	11.66	18.94	30.60	46.00	-15.40	QP

Remark:

1. Factor = Antenna Factor + Cable Loss – Pre-amplifier.

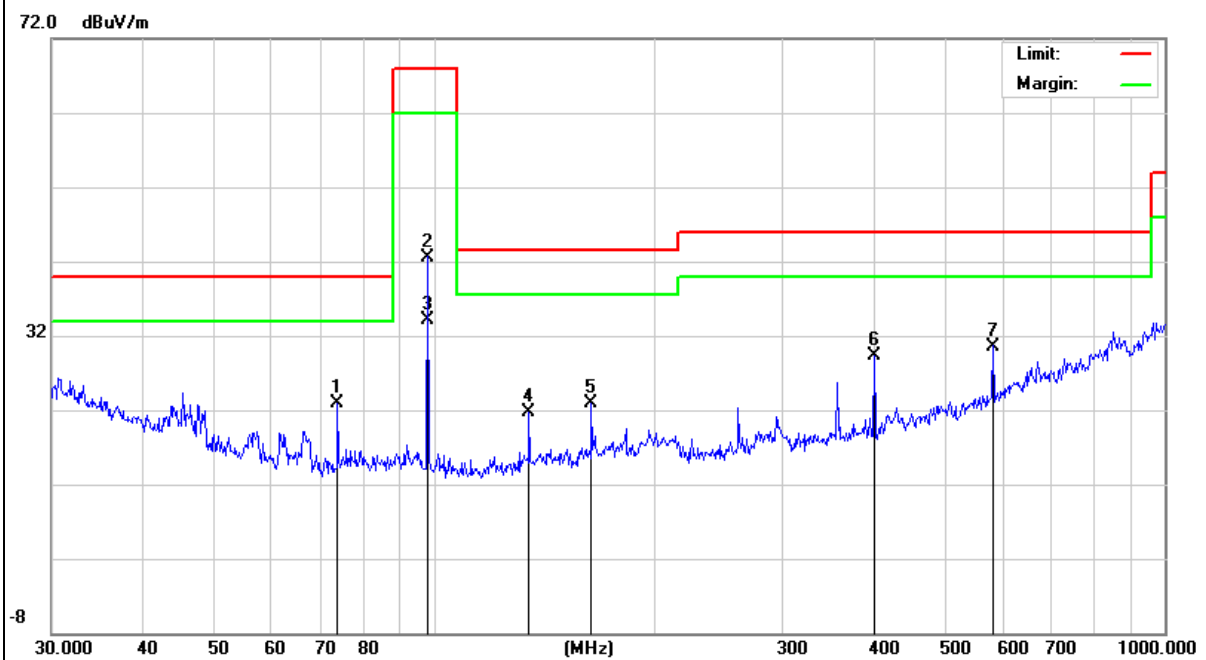

EUT :	Roav VIVA X	Model Name :	R5141
Temperature :	20 °C	Relative Humidity :	48%
Pressure :	1010 hPa	Test Voltage :	DC 12.0V
Test Mode :	107.9MHz	Polarization :	Vertical

Frequency (MHz)	Meter Reading (dBµV)	Factor (dB)	Emission Level (dBµV/m)	Limits (dBµV/m)	Margin (dB)	Remark
50.7637	9.49	13.31	22.80	40.00	-17.20	QP
107.8876	32.22	10.28	42.50	68.00	-25.50	peak
107.8876	26.84	10.28	37.12	68.00	-30.88	QP
164.9073	12.13	12.47	24.60	43.50	-18.90	QP
250.3010	10.06	12.14	22.20	46.00	-23.80	QP
321.0606	9.54	13.46	23.00	46.00	-23.00	QP
508.2581	13.52	17.48	31.00	46.00	-15.00	QP

Remark:

1. Factor = Antenna Factor + Cable Loss – Pre-amplifier.

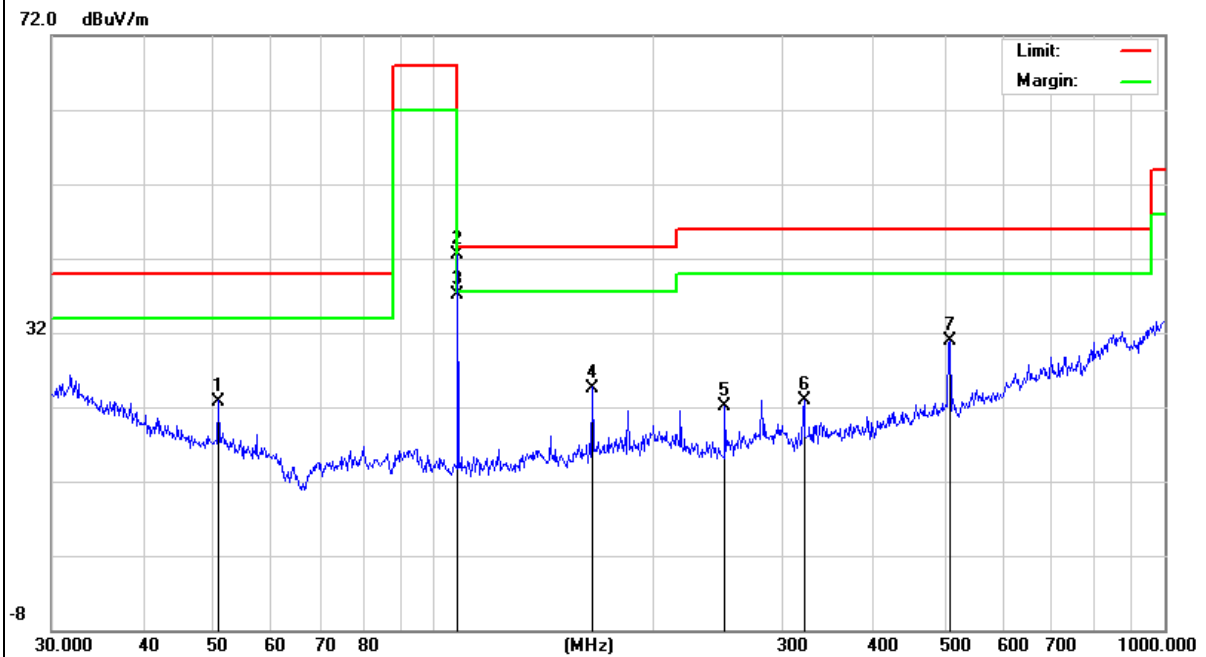

EUT :	Roav VIVA X	Model Name :	R5141
Temperature :	20 °C	Relative Humidity :	48%
Pressure :	1010 hPa	Test Voltage :	DC 12.0V
Test Mode :	107.9MHz	Polarization :	Horizontal

Frequency (MHz)	Meter Reading (dB μ V)	Factor (dB)	Emission Level (dB μ V/m)	Limits (dB μ V/m)	Margin (dB)	Remark
73.8756	12.27	10.73	23.00	40.00	-17.00	QP
107.1337	35.39	10.31	45.70	68.00	-22.30	peak
107.1337	27.15	10.31	37.46	68.00	-30.54	QP
135.0319	10.00	11.70	21.70	43.50	-21.80	QP
356.6757	11.27	14.43	25.70	46.00	-20.30	QP
400.4318	14.28	15.12	29.40	46.00	-16.60	QP
499.4246	10.41	17.69	28.10	46.00	-17.90	QP
582.7424	11.66	18.94	30.60	46.00	-15.40	QP

Remark:

1. Factor = Antenna Factor + Cable Loss – Pre-amplifier.

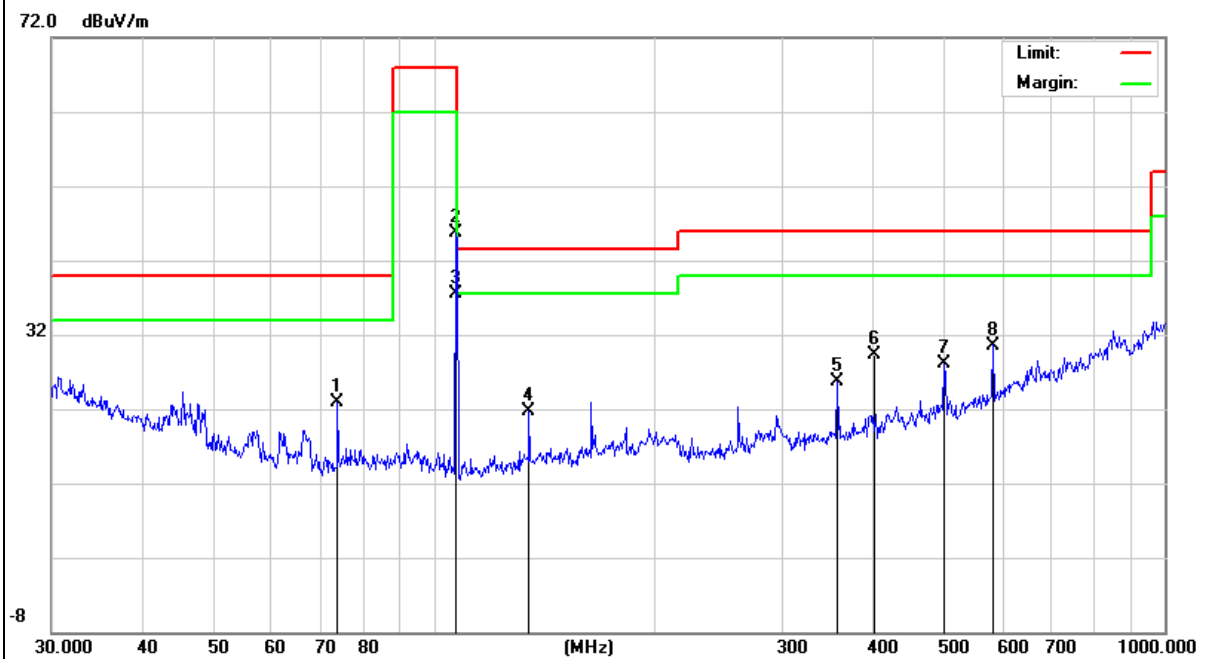

3.4.7 TEST RESULTS (BAND EDGE EMISSION)

EUT :	Roav VIVA X	Model Name :	R5141
Temperature :	20 °C	Relative Humidity :	48%
Pressure :	1010 hPa	Test Voltage :	DC 12.0V
Test Mode :	88.1MHz	Polarization :	Vertical

Frequency (MHz)	Meter Reading (dB μ V)	Factor (dB)	Emission Level (dB μ V/m)	Limits (dB μ V/m)	Margin (dB)	Remark
88.0000	24.44	11.76	36.20	40.00	-3.80	QP
88.2000	17.86	11.76	29.62	68.00	-38.38	PK

Remark:

Factor = Antenna Factor + Cable Loss – Pre-amplifier.

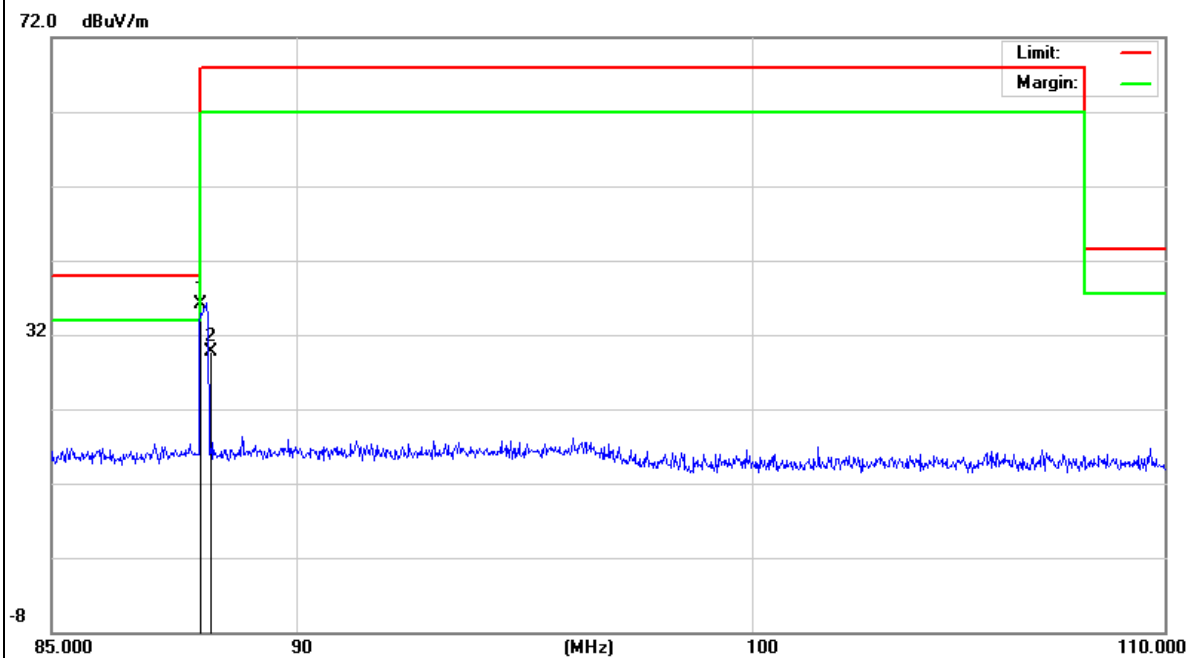

EUT :	Roav VIVA X	Model Name :	R5141
Temperature :	20 °C	Relative Humidity :	48%
Pressure :	1010 hPa	Test Voltage :	DC 12.0V
Test Mode :	88.1MHz	Polarization :	Horizontal

Frequency (MHz)	Meter Reading (dB μ V)	Factor (dB)	Emission Level (dB μ V/m)	Limits (dB μ V/m)	Margin (dB)	Remark
88.0000	23.43	11.76	35.19	40.00	-4.81	QP
88.2000	14.66	11.76	26.42	68.00	-41.58	PK

Remark:

Factor = Antenna Factor + Cable Loss – Pre-amplifier.

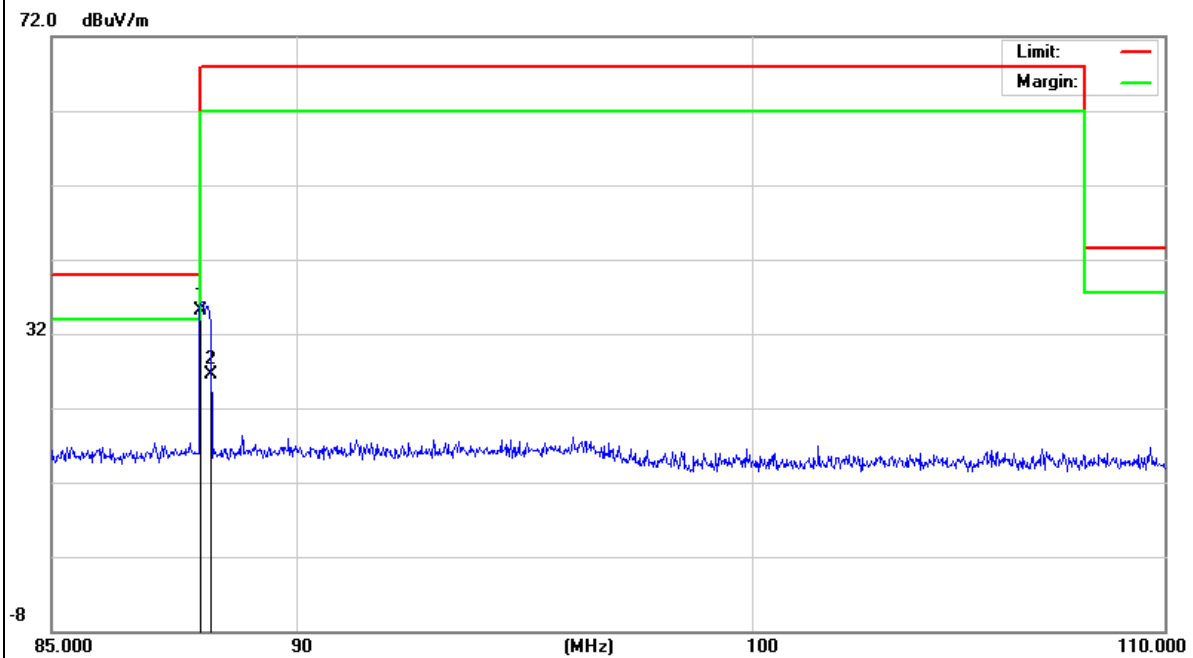

EUT :	Roav VIVA X	Model Name :	R5141
Temperature :	20 °C	Relative Humidity :	48%
Pressure :	1010 hPa	Test Voltage :	DC 12.0V
Test Mode :	107.9MHz	Polarization :	Vertical

Frequency (MHz)	Meter Reading (dB μ V)	Factor (dB)	Emission Level (dB μ V/m)	Limits (dB μ V/m)	Margin (dB)	Detector Type
107.8000	31.51	10.29	41.80	68.00	-26.20	PK
108.0000	27.41	10.28	37.69	43.50	-5.81	QP

Remark:
Factor = Antenna Factor + Cable Loss – Pre-amplifier.

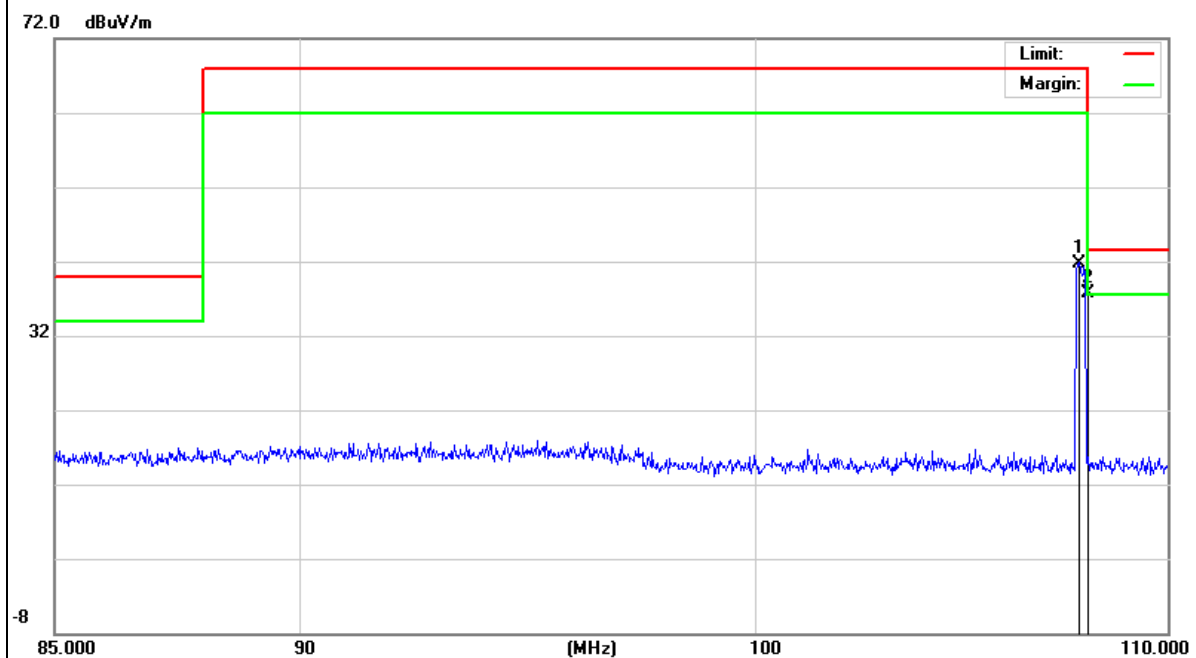

EUT :	Roav VIVA X	Model Name :	R5141
Temperature :	20 °C	Relative Humidity :	48%
Pressure :	1010 hPa	Test Voltage :	DC 12.0V
Test Mode :	107.9MHz	Polarization :	Horizontal

Frequency (MHz)	Meter Reading (dB μ V)	Factor (dB)	Emission Level (dB μ V/m)	Limits (dB μ V/m)	Margin (dB)	Detector Type
107.8000	20.96	10.29	31.25	68.00	-36.75	PK
108.0000	28.22	10.28	38.50	43.50	-5.00	QP

Remark:

Factor = Antenna Factor + Cable Loss – Pre-amplifier.

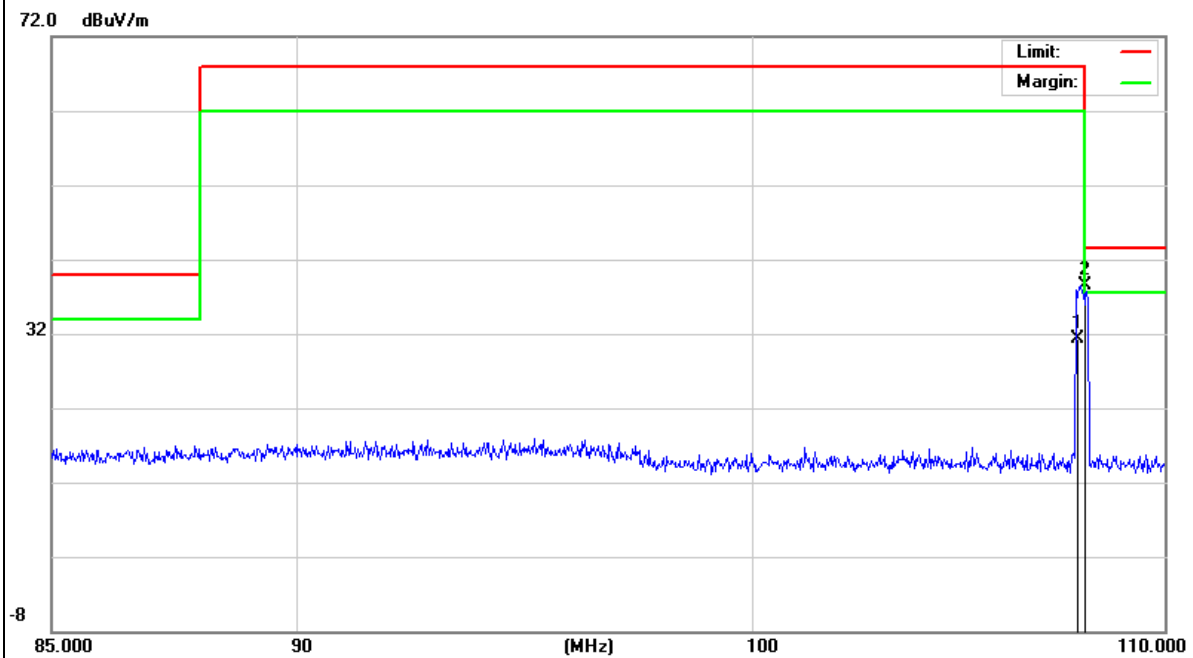

4. BANDWIDTH TEST

4.1 TEST PROCEDURE

- a. The EUT was directly connected to the spectrum analyzer and antenna output port as show in the block diagram below,
- b. Spectrum Setting : RBW= 10KHz, VBW \geq RBW, Sweep time = Auto.

4.2 DEVIATION FROM STANDARD

No deviation.

4.3 TEST SETUP

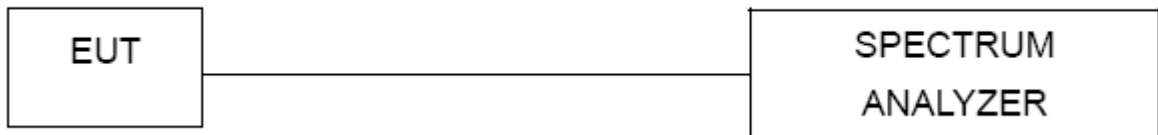

4.4 TEST RESULTS

EUT :	Roav VIVA X	Model Name :	R5141
Temperature :	26 °C	Relative Humidity :	53%
Pressure :	1020 hPa	Test Power :	DC 12.0V
Test Mode :	TX		

Test Channel	Frequency (MHz)	20 dBc Bandwidth (KHz)	Limit (KHz)
Low	88.1	138.300	200
Mid	98.1	137.434	200
High	107.9	96.246	200

The Lowest Channel: 88.1MHz

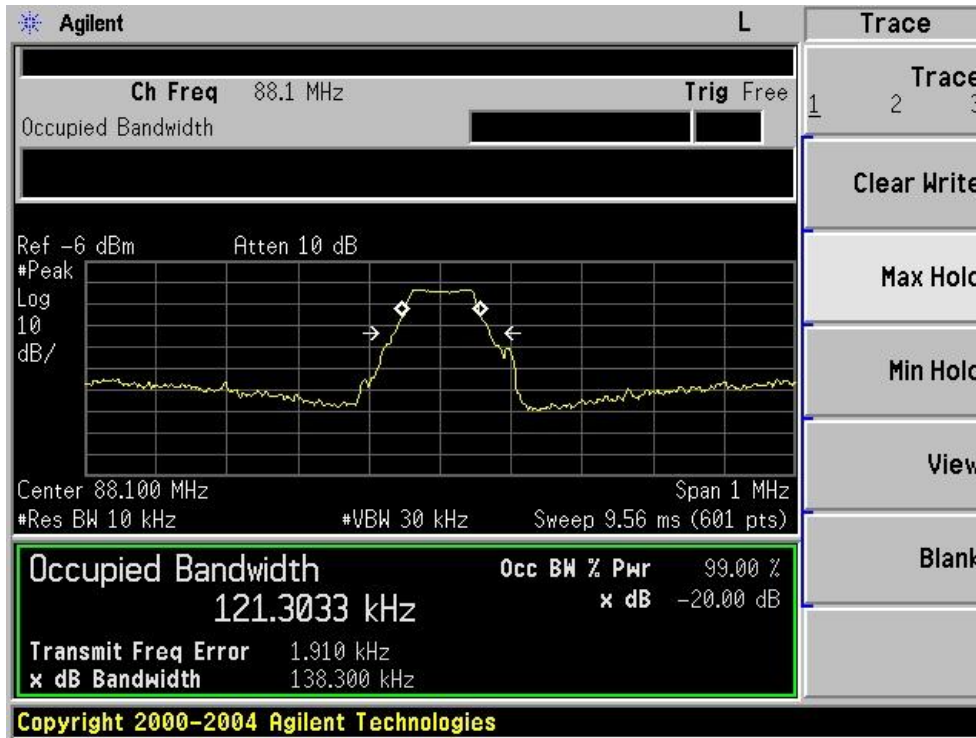

The Middle Channel: 98.1MHz

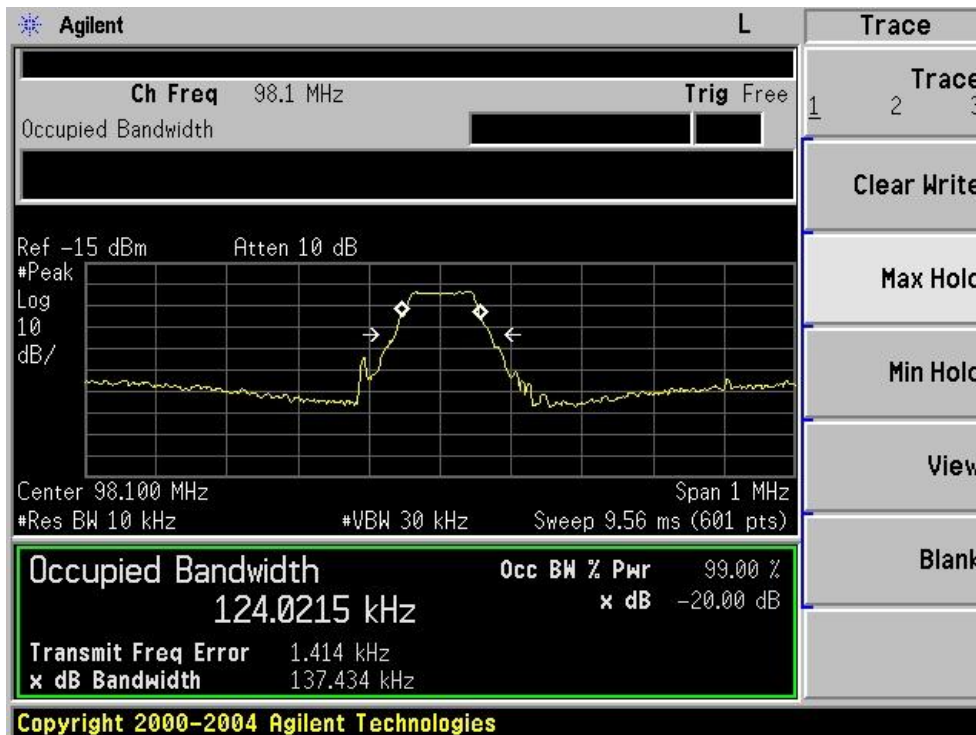

The High Channel:107.9MHz

