



REPORT No.: SZ17080187W04

FCC RF TEST REPORT

APPLICANT : Anker Technology Co., Limited

PRODUCT NAME : Nebula Mars Lite

MODEL NAME : D2321

TRADE NAME : Nebula

BRAND NAME : N/A

FCC ID : 2AB7K-D2321

STANDARD(S) : 47 CFR Part 15 Subpart E

ISSUE DATE : 2017-09-12

SHENZHEN MORLAB COMMUNICATIONS TECHNOLOGY Co., Ltd.

NOTE: This document is issued by MORLAB, the test report shall not be reproduced except in full without prior written permission of the company. The test results apply only to the particular sample(s) tested and to the specific tests carried out which is available on request for validation and information confirmed at our website.



DIRECTORY

TEST REPORT DECLARATION.....4

1. GENERAL INFORMATION.....5

1.1 EUT DESCRIPTION.....5

1.2 TEST STANDARDS AND RESULTS7

1.3 TEST ENVIRONMENT CONDITIONS.....7

2. 47 CFR PART 15E REQUIREMENTS.....8

2.1 ANTENNA REQUIREMENT8

2.1.1 APPLICABLE STANDARD8

2.1.2 RESULT: COMPLIANT.....8

2.2 EMISSION BANDWIDTH.....8

2.2.1 REQUIREMENT.....8

2.2.2 TEST DESCRIPTION8

2.2.3 TEST RESULT.....9

2.3 MAXIMUM CONDUCTED OUTPUT POWER19

2.3.1 REQUIREMENT..... 19

2.3.2 TEST DESCRIPTION 19

2.3.3 TEST RESULT..... 20

2.4 PEAK POWER SPECTRAL DENSITY.....21

2.4.1 REQUIREMENT..... 21

2.4.2 TEST DESCRIPTION 21

2.4.3 TEST RESULT..... 22

2.5 RESTRICTED FREQUENCY BANDS32

2.5.1 REQUIREMENT..... 32

2.5.2 TEST DESCRIPTION 32

2.5.3 TEST RESULT..... 33

2.6 FREQUENCY STABILITY41

2.6.1 REQUIREMENT..... 41

2.6.2 TEST PROCEDURE 41

2.6.3 TEST RESULT..... 41

2.7 TRANSMIT POWER CONTROL (TPC) AND DYNAMIC FREQUENCY SELECTION (DFS)43

2.7.1 REQUIREMENT..... 43



2.7.1.1 MASTER DEVICES 44

2.7.1.2 CLIENT DEVICES 45

2.7.1.3 DFS DETECTION THRESHOLDS 45

2.7.1.4 RESPONSE REQUIREMENTS 46

2.7.2 TEST DESCRIPTION 46

2.7.3 TEST RESULT..... 47

2.8 CONDUCTED EMISSION.....48

2.8.1 REQUIREMENT..... 48

2.8.2 TEST DESCRIPTION 48

2.8.3 TEST RESULT..... 49

2.9 RADIATED EMISSION51

2.9.1 REQUIREMENT..... 51

2.9.2 TEST DESCRIPTION 52

2.9.3 TEST RESULT..... 55

2.10 RF EXPOSURE EVALUATION74

2.10.1 REQUIREMENT..... 74

2.10.2 RESULT..... 74

2.11 AUTOMATICALLY DISCONTINUE TRANSMISSION REQUIREMENT.....74

2.11.1 REQUIREMENT..... 74

2.11.2 RESULT..... 74

ANNEX A GENERAL INFORMATION.....75

Change History		
Issue	Date	Reason for change
1.0	2017-09-12	First edition

**TEST REPORT DECLARATION**

Applicant	Anker Technology Co., Limited
Applicant Address	Room 1318-19,Hollywood Plaza,610 Nathan Road, Mongkok, Kowloon, Hong Kong
Manufacturer	Anker Technology Co., Limited
Manufacturer Address	Room 1318-19,Hollywood Plaza,610 Nathan Road, Mongkok, Kowloon, Hong Kong
Product Name	Nebula Mars Lite
Model Name	D2321
Brand Name	N/A
HW Version	9893C
SW Version	N/A
Test Standards	47 CFR Part 15 Subpart E
Test Date	2017-08-30 to 2017-09-12
Test Result	PASS

Tested by : Tu Ya'nan
Tu Ya'nan (Test Engineer)

Approved by : Qiu Xiaojun
Qiu Xiaojun (Supervisor)



1. GENERAL INFORMATION

1.1 EUT Description

Product Name.....:	Nebula Mars Lite
Serial No.:	(n.a, marked #1 by test site)
Hardware Version.....:	9893C
Software Version.....:	N/A
Applicant.....:	Anker Technology Co., Limited Room 1318-19,Hollywood Plaza,610 Nathan Road, Mongkok, Kowloon, Hong Kong
Manufacturer	Anker Technology Co., Limited Room 1318-19,Hollywood Plaza,610 Nathan Road, Mongkok, Kowloon, Hong Kong
Frequency Range.....:	802.11a /n: 5.150GHz- 5.250GHz 5.725GHz- 5.850GHz
Channel Number	Refer Note(2)
Modulation Type.....:	DSSS, OFDM
Antenna Type.....:	FPCB Antenna
Antenna Gain.....:	4.1 dBi

Note 1: The U-NII band is applicable to this report, another bands of operation (2.4GHz) is documented in a separate report.

Note 2 : The following tables are the channel number and frequency of the EUT, the black bold channels were selected for test.

20MHz Bandwidth:

Frequency Range	5150~5250MHz			
Channel Number	36	40	44	48
Frequency (MHz)	5180	5200	5220	5240

Frequency Range	5725~5850MHz				
Channel Number	149	153	157	161	165
Frequency (MHz)	5745	5765	5785	5805	5825

**40MHz Bandwidth:**

Frequency Range	5150~5250 MHz	
Channel Number	38	46
Frequency (MHz)	5190	5230

Frequency Range	5725~5850 MHz	
Channel Number	151	159
Frequency (MHz)	5755	5795

Note 3: During test, the duty cycle of the EUT was setting to 100%.

Note 4: For a more detailed description, please refer to Specification or User's Manual supplied by the applicant and/or manufacturer.

Note 5: The antenna connector of EUT is designed with permanent attachment and no consideration of replacement.



1.2 Test Standards and Results

The objective of the report is to perform testing according to 47 CFR Part 15 Subpart E (UNII band) for the EUT FCC ID Certification:

No.	Identity	Document Title
1	47 CFR Part 15 (5-1-14 Edition)	Radio Frequency Devices

Test detailed items/section required by FCC rules and results are as below:

No.	Section	Description	Result
1	15.203	Antenna Requirement	<u>PASS</u>
2	15.407(a) (e)	Emission Bandwidth	<u>PASS</u>
3	15.407(a)	Maximum conducted output Power	<u>PASS</u>
4	15.407(a)	Peak Power spectral density	<u>PASS</u>
5	15.407(b)	Restricted Frequency Bands	<u>PASS</u>
6	15.407(g)	Frequency Stability	<u>PASS</u>
7	15.407(h)	TPC and DFS	<u>N/A</u> _(Note)
8	15.207	Conducted Emission	<u>PASS</u>
9	15.407(b)	Radiated Emission	<u>PASS</u>
10	15.407(f)	RF exposure evaluation	<u>PASS</u>
11	15.407(c)	Automatically discontinue transmission requirement	<u>PASS</u>

Note: EUT is a Client Device Without Radar Detection, WIFI hotspot does not support U-NII band; A TPC mechanism is not required for systems with an e.i.r.p. of less than 500 mW.

The tests of Conducted Emission and Radiated Emission were performed according to the method of measurements prescribed in ANSI C63.10 2013.

These RF tests were performed according to the method of measurements prescribed in KDB789033 D02 v01r04 (05/02/2017), KDB905462 D03 v01r02 (08/22/2016) and KDB644545 D03 v01 (08/14/2014).

1.3 Test Environment Conditions

During the measurement, the environmental conditions were within the listed ranges:

Temperature (°C):	15 - 35
Relative Humidity (%):	30 -60
Atmospheric Pressure (kPa):	86-106

2. 47 CFR PART 15E REQUIREMENTS

2.1 Antenna requirement

2.1.1 Applicable Standard

According to FCC 15.203, an intentional radiator shall be designed to ensure that no antenna other than that furnished by the responsible party shall be used with the device. The use of a permanently attached antenna or of an antenna that uses a unique coupling to the intentional radiator shall be considered sufficient to comply with the provisions of this section.

2.1.2 Result: Compliant

The EUT has a permanently and irreplaceable attached antenna. Please refer to the EUT internal photos.

2.2 Emission Bandwidth

2.2.1 Requirement

For purposes of this subpart the emission bandwidth shall be determined by measuring the width of the signal between two points, one below the carrier center frequency and one above the carrier center frequency, that are 26 dB down relative to the maximum level of the modulated carrier. Determination of the emissions bandwidth is based on the use of measurement instrumentation employing a peak detector function with an instrument resolution bandwidth approximately equal to 1.0 percent of the emission bandwidth of the device under measurement. Within the 5.725-5.85 GHz band, the minimum 6 dB bandwidth of U-NII devices shall be at least 500 kHz.

2.2.2 Test Description

A. Test Set:

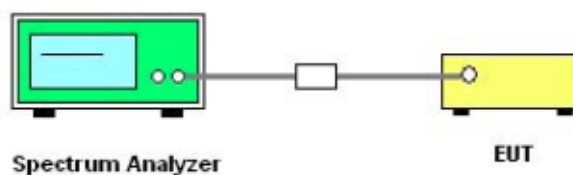

The EUT which is powered by the battery, is coupled to the Spectrum Analyzer; the RF load attached to the EUT antenna terminal is 50Ohm; the path loss as the factor is calibrated to correct the reading.

B. Test Procedure

1. KDB 789033 Section C) 1) Emission Bandwidth was used in order to prove compliance
- 1) Set RBW = approximately 1% of the emission bandwidth.
- 2) Set the VBW > RBW.
- 3) Detector = Peak.
- 4) Trace mode = max hold.



- 5) Measure the maximum width of the emission that is 26 dB down from the peak of the emission. Compare this with the RBW setting of the analyzer. Readjust RBW and repeat measurement as needed until the RBW/EBW ratio is approximately 1%.
- 2. KDB 789033 Section C) 2) minimum emission bandwidth for the band 5.725-5.85GHz was used in order to prove compliance.
Section 15.407(e) specifies the minimum 6 dB emission bandwidth of at least 500 KHz for the band 5.715-5.85 GHz. The following procedure shall be used for measuring this bandwidth:
 - a) Set RBW = 100 kHz.
 - b) Set the video bandwidth (VBW) $\geq 3 \times$ RBW.
 - c) Detector = Peak.
 - d) Trace mode = max hold.
 - e) Sweep = auto couple.
 - f) Allow the trace to stabilize.
 - g) Measure the maximum width of the emission that is constrained by the frequencies associated with the two outermost amplitude points (upper and lower frequencies) that are attenuated by 6 dB relative to the maximum level measured in the fundamental emission.

2.2.3 Test Result

The lowest, middle and highest channels are selected to perform testing to record the 26 dB bandwidth of the Module.

2.2.3.1 802.11a-20MHz Test mode

A. Test Verdict:

Channel	Frequency (MHz)	26 dB Bandwidth (MHz)
36	5180	21.00
44	5220	20.94
48	5240	21.08
Channel	Frequency (MHz)	6dB Bandwidth (MHz)
149	5745	20.94
157	5785	21.17
165	5825	21.23



B. Test Plots

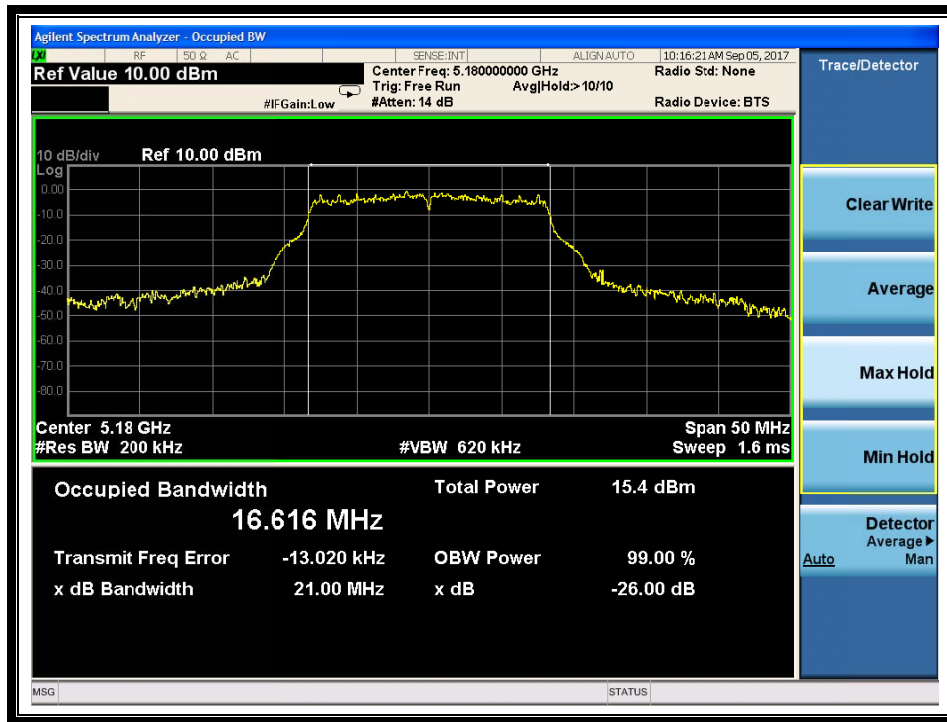

(Channel 36: 5180MHz @ 802.11a)

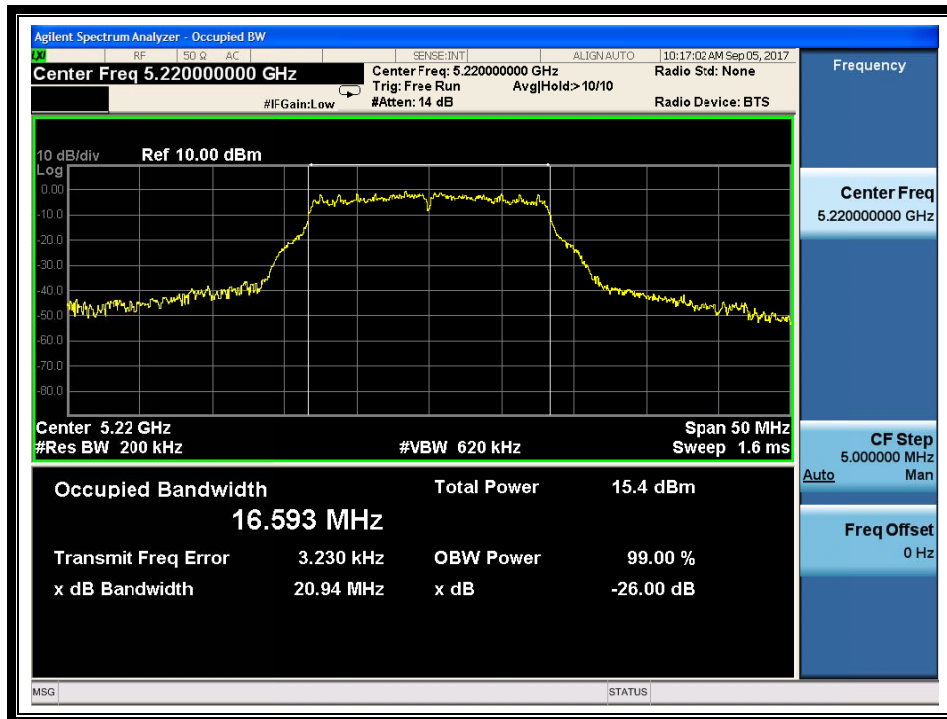

(Channel 44: 5220 MHz @ 802.11a)



(Channel 48: 5240MHz @ 802.11a)

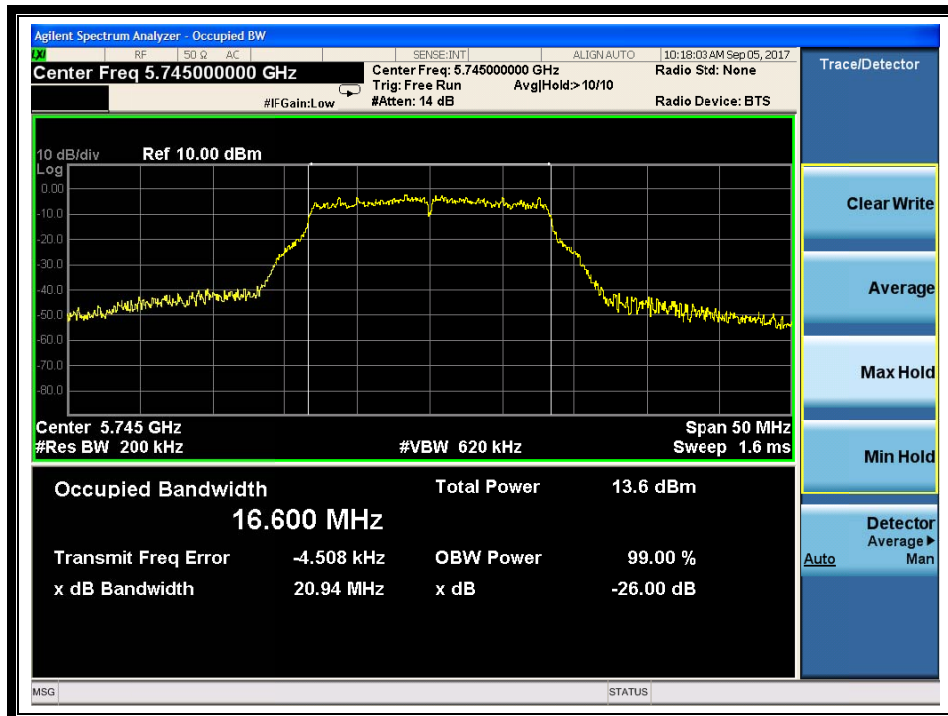

(Channel 149: 5745MHz @ 802.11a)

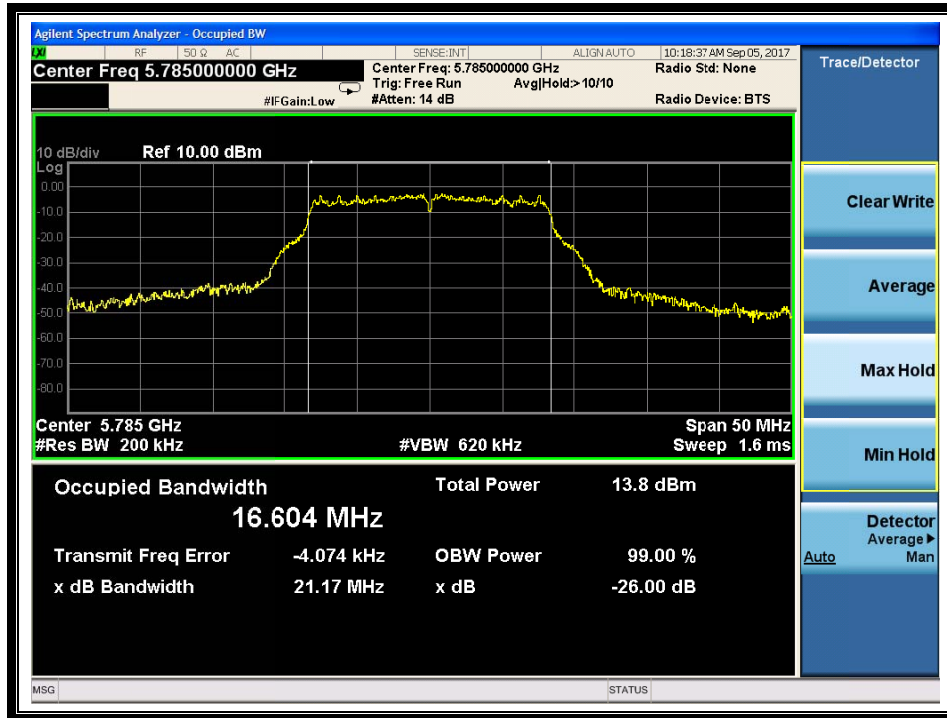

(Channel 157: 5785MHz @ 802.11a)

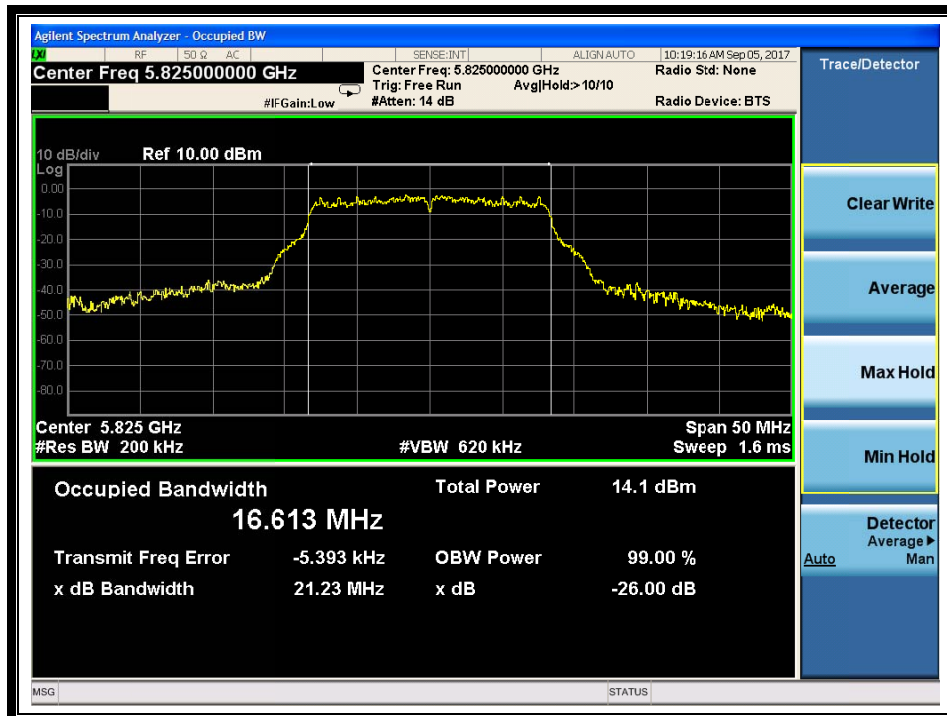

(Channel 165: 5825MHz @ 802.11a)



2.2.3.2 802.11n-20MHz Test mode

A. Test Verdict:

Channel	Frequency (MHz)	26 dB Bandwidth (MHz)
36	5180	21.32
44	5220	21.44
48	5240	21.31
Channel	Frequency (MHz)	6dB Bandwidth (MHz)
149	5745	21.45
157	5785	21.36
165	5825	21.26

B. Test Plots

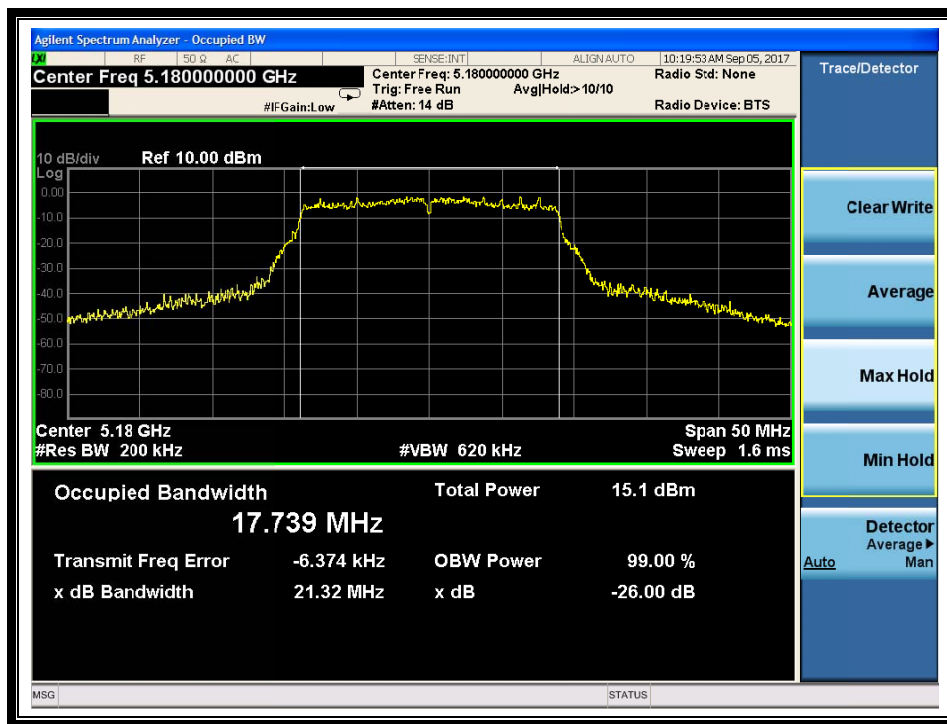

(Channel 36: 5180MHz @ 802.11n-20MHz)

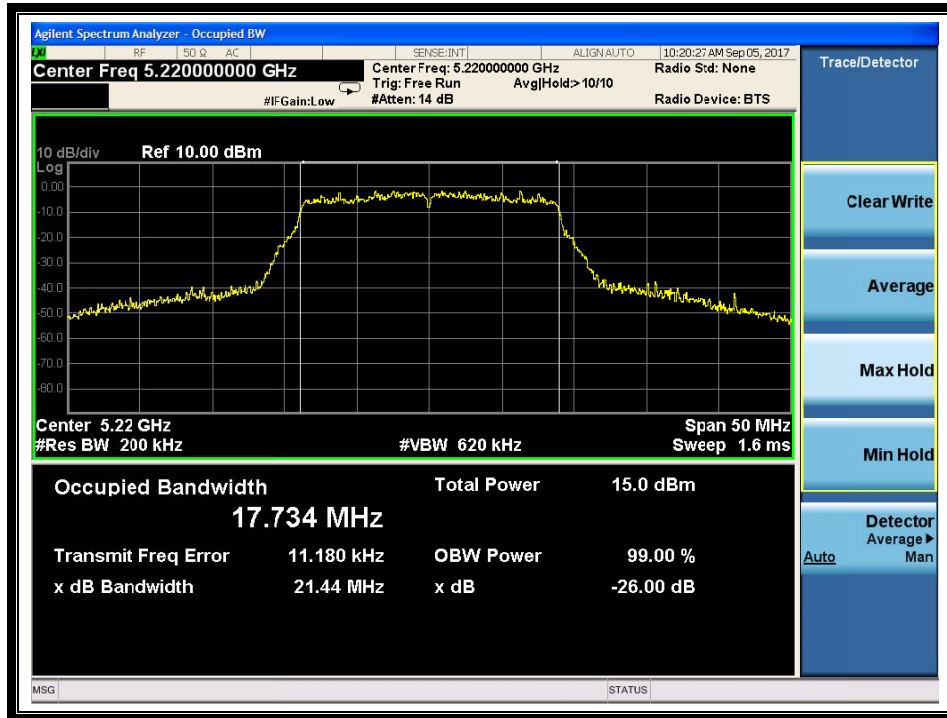

(Channel 44: 5220 MHz @ 802.11n-20MHz)

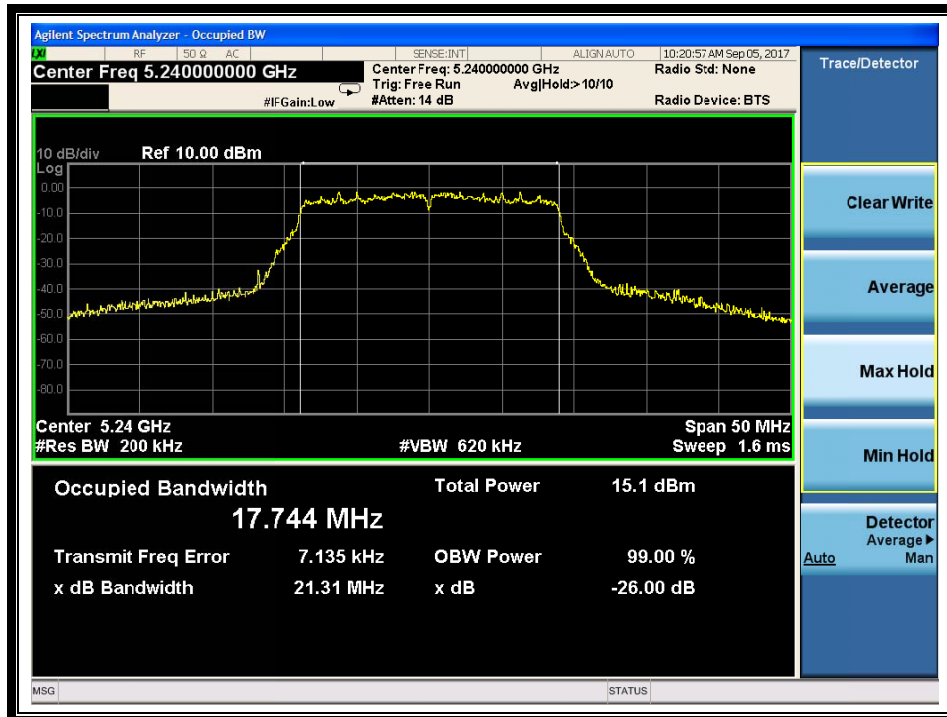

(Channel 48: 5240MHz @ 802.11n-20MHz)

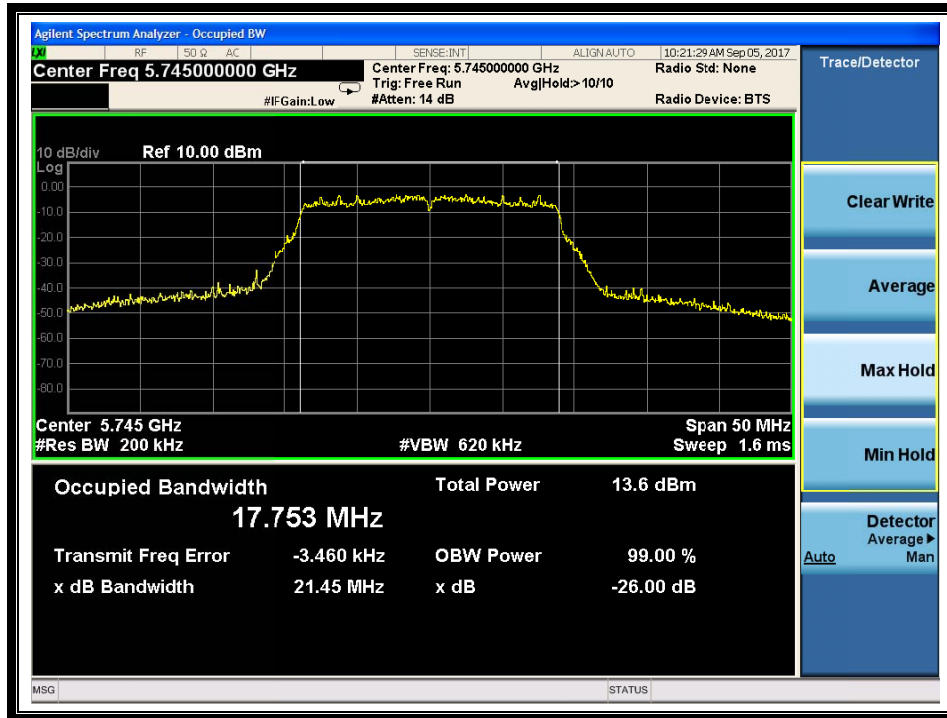

(Channel 149: 5745MHz @ 802.11n-20MHz)

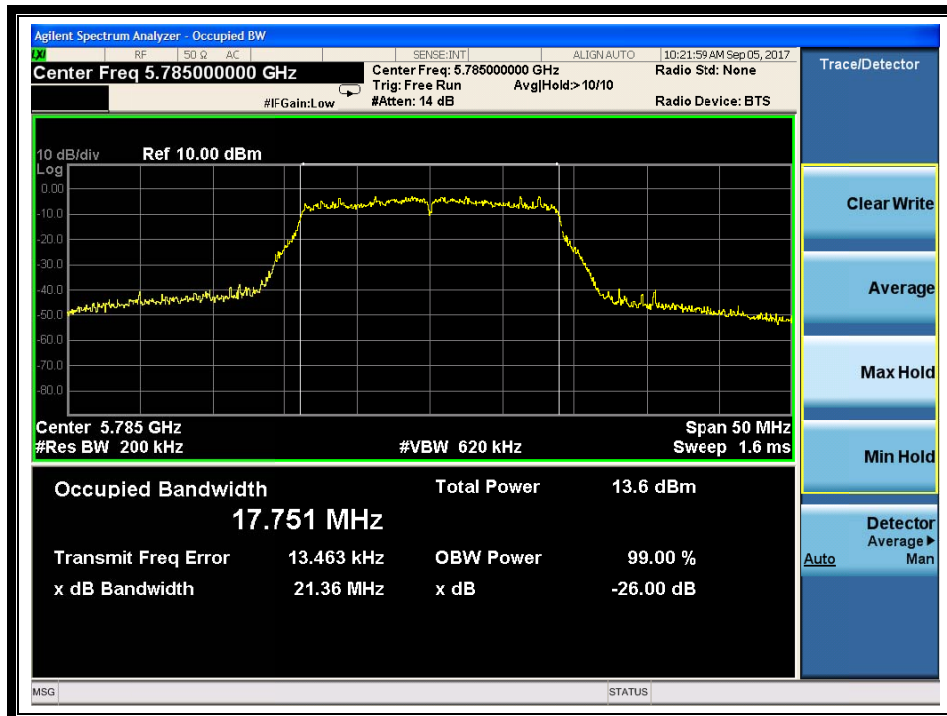

(Channel 157: 5785MHz @802.11n-20MHz)

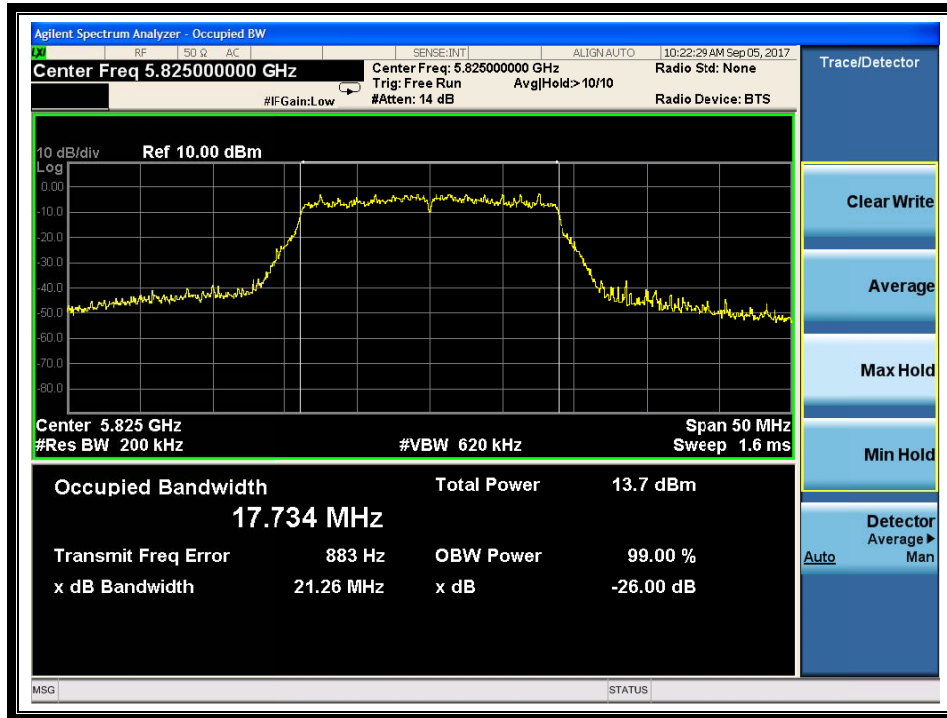

(Channel 165: 5825MHz @ 802.11n-20MHz)

2.2.3.3 802.11n-40MHz Test mode

A. Test Verdict:

Channel	Frequency (MHz)	26 dB Bandwidth (MHz)
38	5190	39.62
46	5230	39.53
Channel	Frequency (MHz)	6dB Bandwidth (MHz)
151	5755	39.50
159	5795	39.43



B. Test Plots

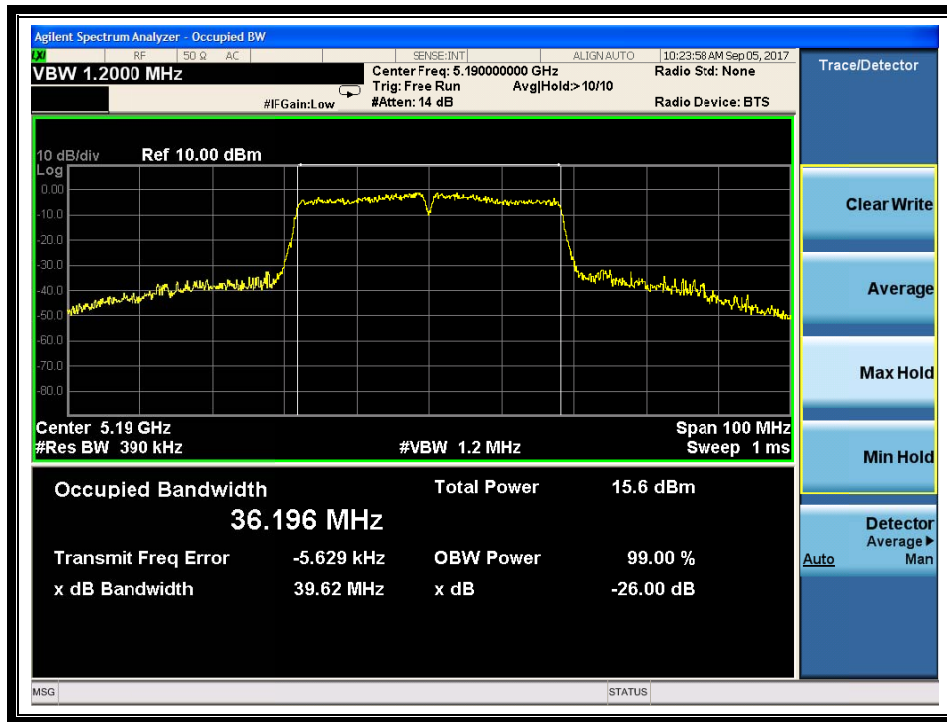

(Channel 38: 5190MHz @ 802.11n-40)

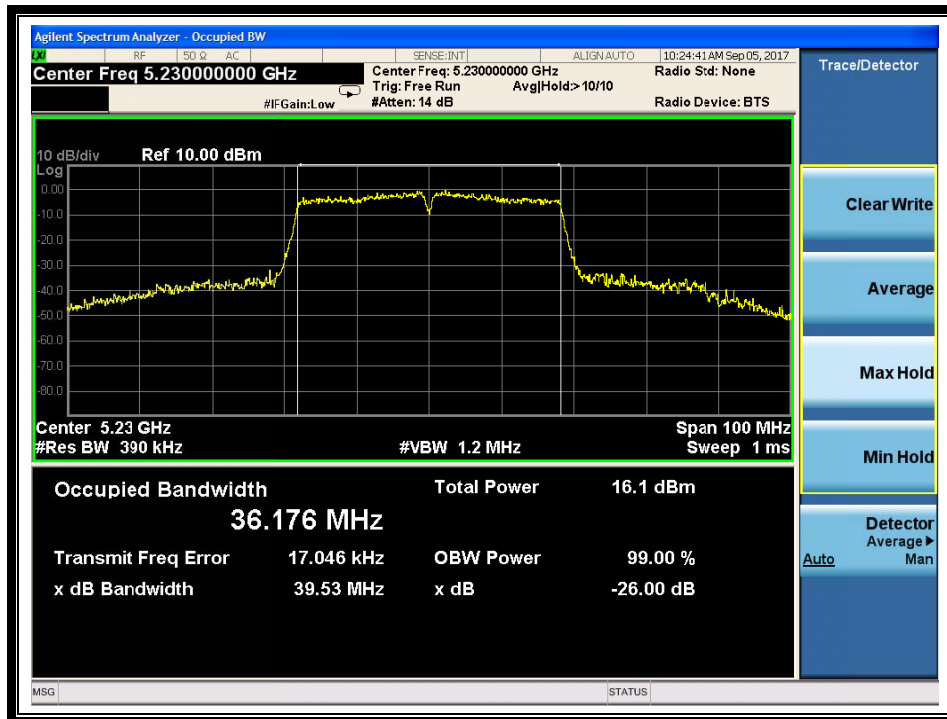

(Channel 46: 5230 MHz @ 802.11 n-40)

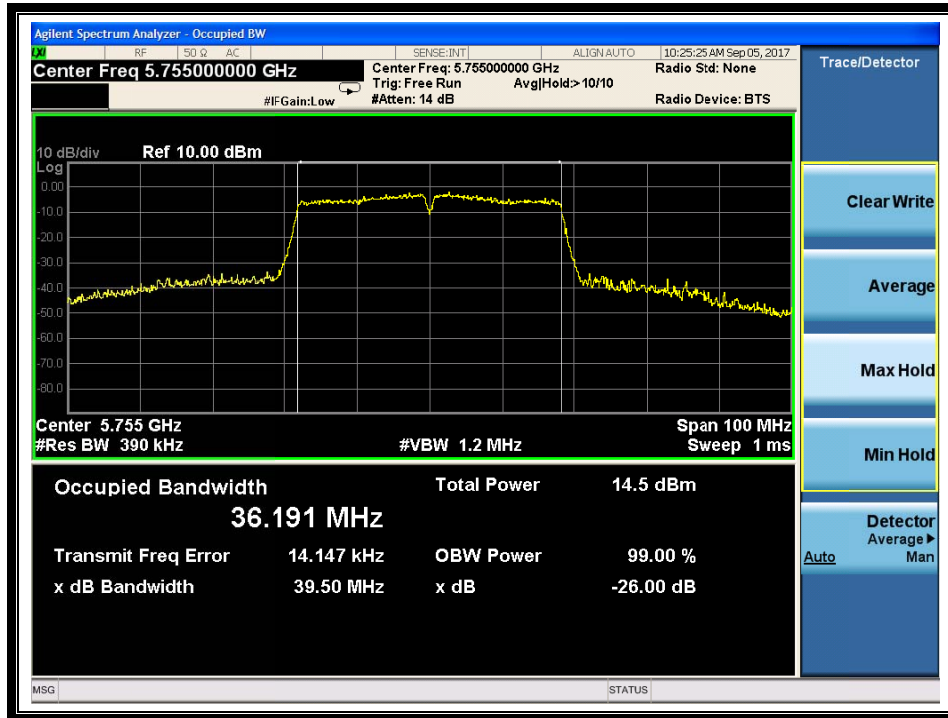

(Channel 151: 5755MHz @ 802.11 n-40)

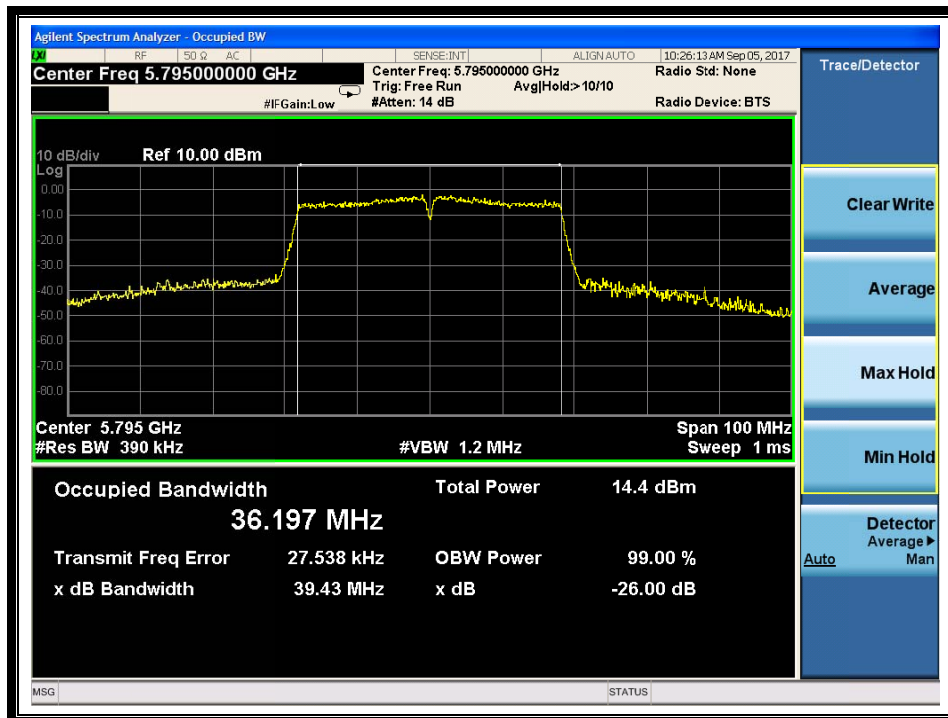

(Channel 159: 5795MHz @ 802.11 n-40)

2.3 Maximum conducted output power

2.3.1 Requirement

(1) For mobile and portable client devices in the 5.15-5.25 GHz band, the maximum conducted output power over the frequency band of operation shall not exceed 250 mW provided the maximum antenna gain does not exceed 6 dBi.

(2) For the 5.25–5.35 GHz and 5.47–5.725 GHz bands, the maximum conducted output power over the frequency bands of operation shall not exceed the lesser of 250mW or $11\text{dBm} + 10\log B$, where B is the 26 dB emission bandwidth in megahertz.

(3) For the band 5.725-5.85 GHz, the maximum conducted output power over the frequency band of operation shall not exceed 1 W.

According FCC KDB644545 D03 D)1)b)3) requirement:

a) The maximum conducted output power within each band of operation shall comply with the limits for that band.

b) The limit on maximum conducted output power in each U-NII band is computed based on the portion of the emission bandwidth contained within that band

If transmitting antennas of directional gain greater than 6dBi are used, both the maximum conducted output power and the peak power spectral density shall be reduced by the amount in dB that the directional gain of the antenna exceeds 6dBi.

2.3.2 Test Description

Section E) 3) of KDB 789033 defines a methodology using an RF average power meter.

A. Test Setup:

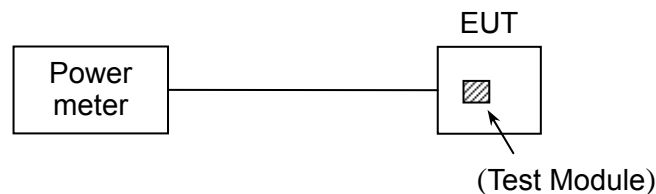

The EUT (Equipment under the test) which is powered by the Battery is coupled to the Power Meter; the RF load attached to the EUT antenna terminal is 50Ohm; the path loss as the factor is calibrated to correct the reading, all test result in power meter.



2.3.3 Test Result

2.3.3.1 802.11a-20MHz Test mode

Channel	Frequency (MHz)	Measured Output Power(dBm)	Limit (dBm)	Verdict
36	5180	11.38	24	PASS
44	5220	11.98		
48	5240	12.13		
149	5745	9.98	30	
157	5785	10.10		
165	5825	10.12		

2.3.3.2 802.11n-20MHz Test mode

Channel	Frequency (MHz)	Measured Output Power(dBm)	Limit (dBm)	Verdict
36	5180	11.20	24	PASS
44	5220	11.56		
48	5240	11.78		
149	5745	9.86	30	
157	5785	9.77		
165	5825	9.91		

2.3.3.3 802.11n-40MHz Test mode

Channel	Frequency (MHz)	Measured Output Power(dBm)	Limit (dBm)	Verdict
38	5190	11.25	24	PASS
46	5230	11.70		
151	5755	10.11	30	
159	5795	10.31		

2.4 Peak Power spectral density

2.4.1 Requirement

(1) For mobile and portable client devices in the 5.15-5.25 GHz band, the maximum power spectral density shall not exceed 11 dBm in any 1 megahertz band.

(2) For the 5.25–5.35 GHz and 5.47–5.725GHz bands, the maximum power spectral density shall not exceed 11 dBm in any 1 megahertz band.

(3) For the band 5.725-5.85 GHz, the maximum power spectral density shall not exceed 30 dBm in any 500KHz band.

According FCC KDB644545 D03 D)1)b)2) requirement:

Emissions in each band shall comply with the PSD limits applicable to that band under the appropriate rule section.

If transmitting antennas of directional gain greater than 6 dBi are used, both the maximum conducted output power and the maximum power spectral density shall be reduced by the amount in dB that the directional gain of the antenna exceeds 6 dBi.

2.4.2 Test Description

A. Test Set:

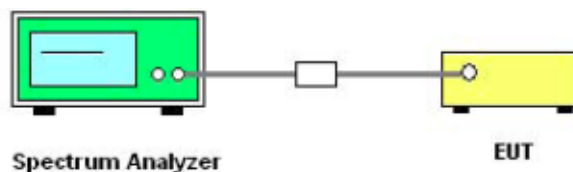

The EUT which is powered by the Battery, is coupled to the Spectrum Analyzer; the RF load attached to the EUT antenna terminal is 50Ohm; the path loss as the factor is calibrated to correct the reading.

B. Test Procedure

KDB 789033 Section F) Maximum Power Spectral Density (PSD) Method SA-1 was used in order to prove compliance

- 1) Set span to encompass the entire 26-dB emission bandwidth
- 2) Set RBW = 1 MHz. Set VBW \geq 3 MHz.
- 3) Number of points in sweep \geq 2 Span / RBW. Sweep time = auto.
- 4) Detector = RMS (i.e., power averaging)
- 5) Trace average at least 100 traces in power averaging (i.e., RMS) mode
- 6) Record the max value



2.4.3 Test Result

2.4.3.1 802.11a Test mode

A. Test Verdict:

Channel	Frequency (MHz)	Measured PPSD (dBm/MHz)	Limit (dBm/MHz)	Verdict
36	5180	7.16	11	PASS
44	5220	7.44		
48	5240	7.70		
Channel	Frequency (MHz)	Measured PPSD (dBm/500KHz)	Limit (dBm/500KHz)	Verdict
149	5745	5.96	30	PASS
157	5785	5.84		
165	5825	6.06		

B. Test Plots

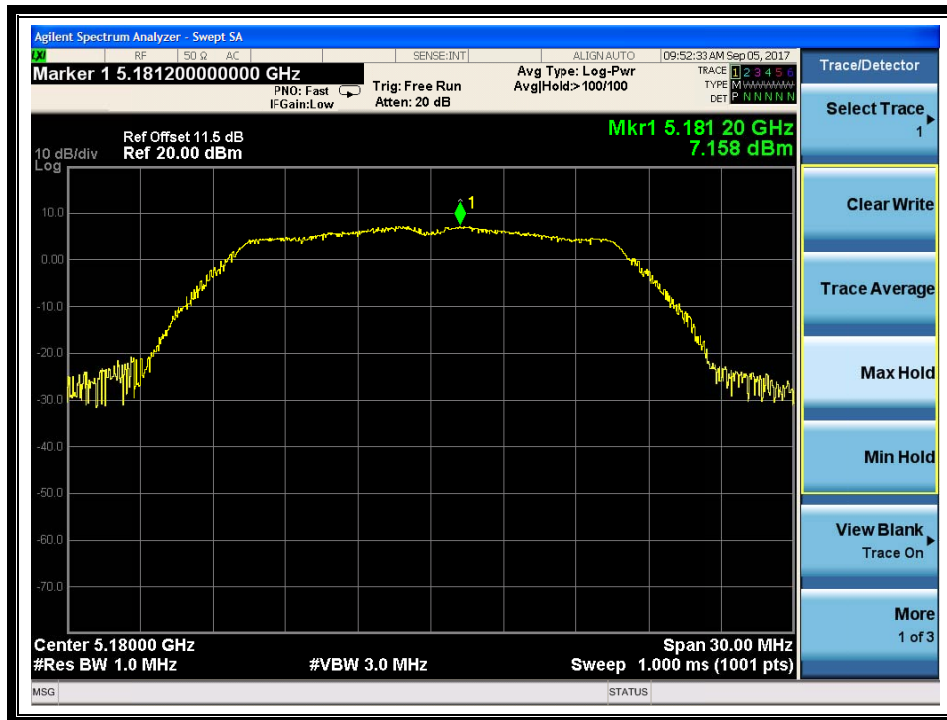

(Channel 36: 5180MHz @ 802.11a)



(Channel 44: 5220 MHz @802.11a)

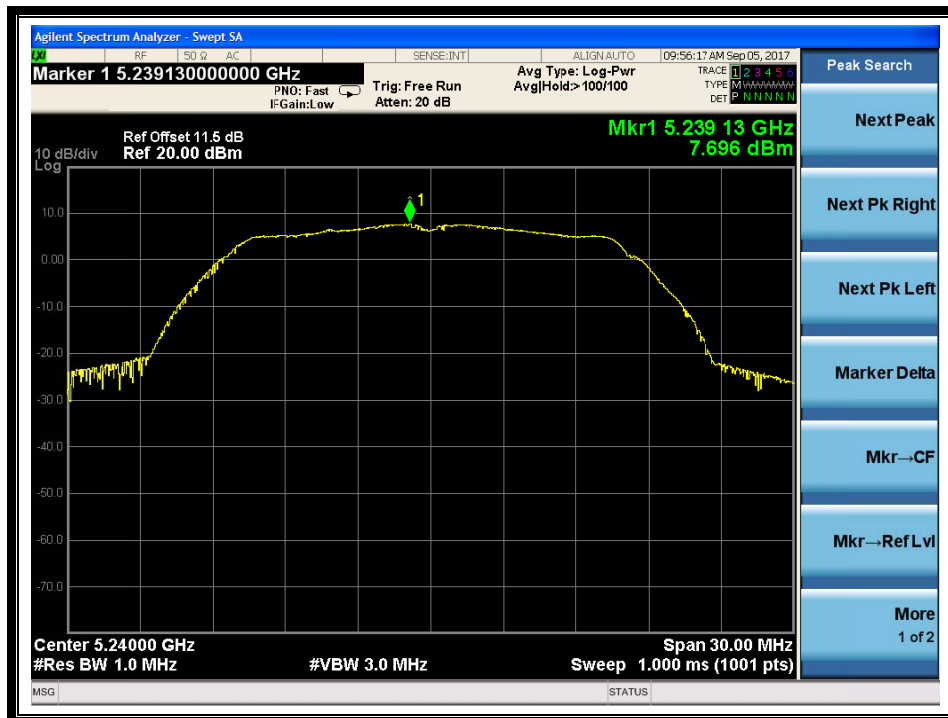

(Channel 48: 5240MHz @802.11a)

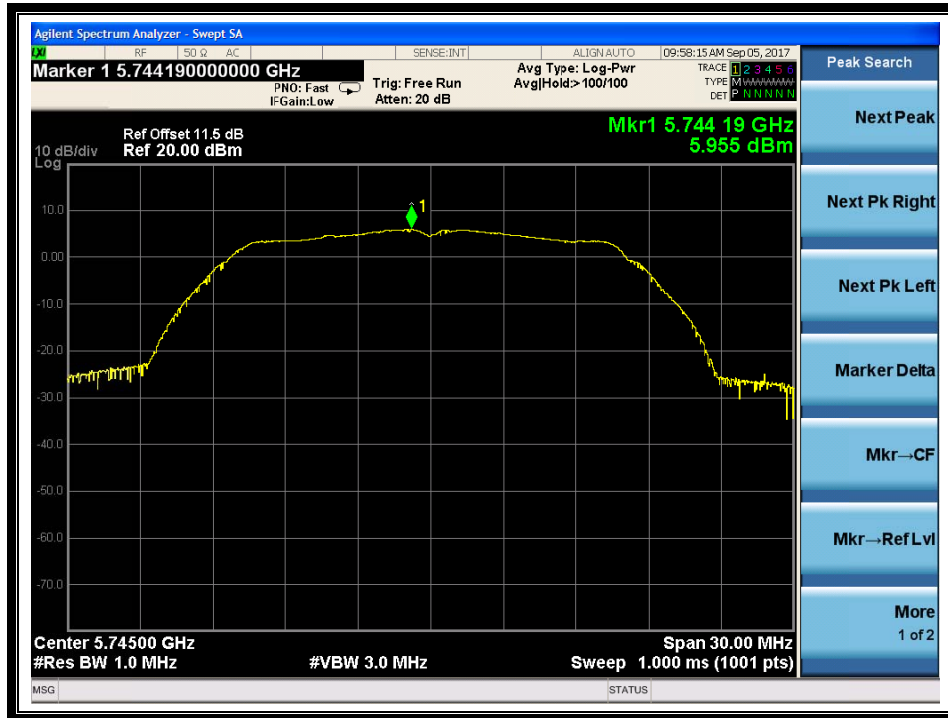

(Channel 149: 5745MHz @ 802.11a)

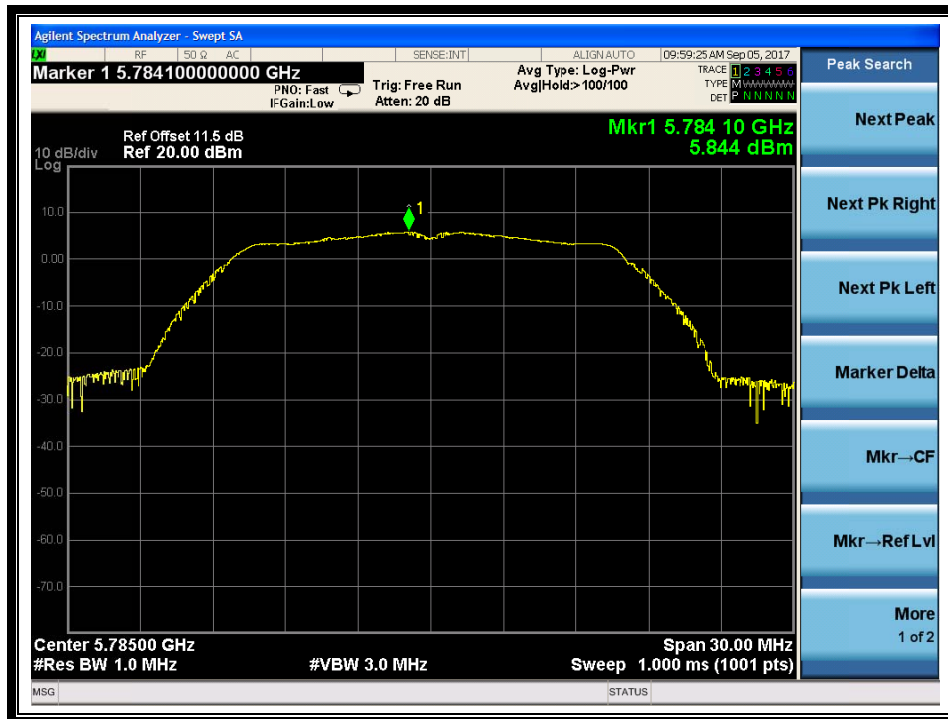

(Channel 157: 5785MHz @ 802.11a)

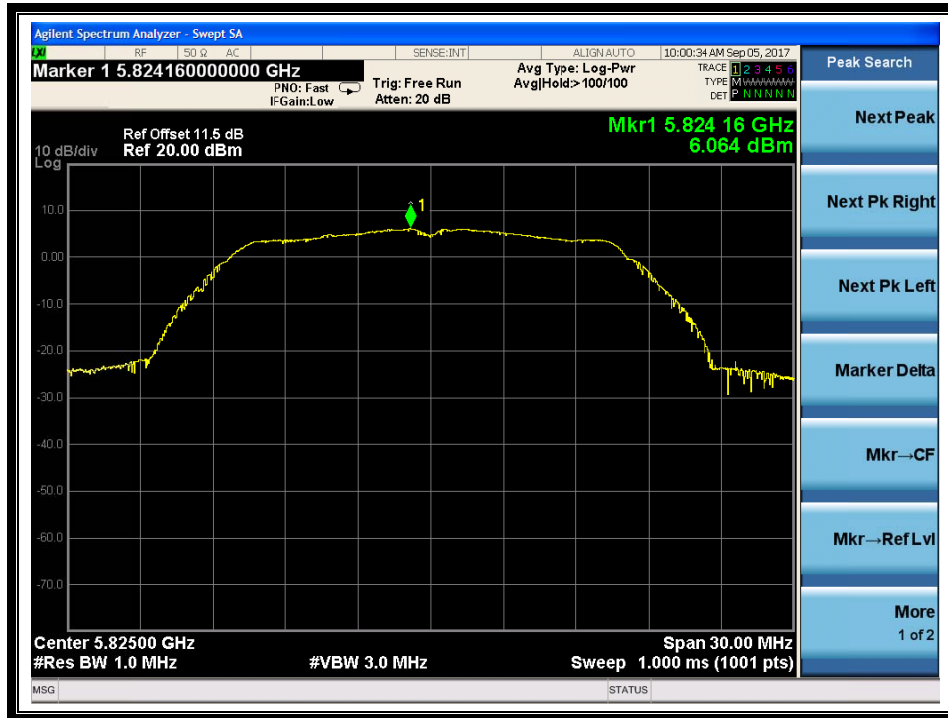

(Channel 165: 5825MHz @ 802.11a)

2.4.3.2 802.11n-20MHz Test mode

A. Test Verdict:

Channel	Frequency (MHz)	Measured PPSD (dBm/MHz)	Limit (dBm/MHz)	Verdict
36	5180	8.34	11	PASS
44	5220	7.31		
48	5240	7.84		
Channel	Frequency (MHz)	Measured PPSD (dBm/500KHz)	Limit (dBm/500KHz)	Verdict
149	5745	5.69	30	PASS
157	5785	6.49		
165	5825	5.78		



B. Test Plots

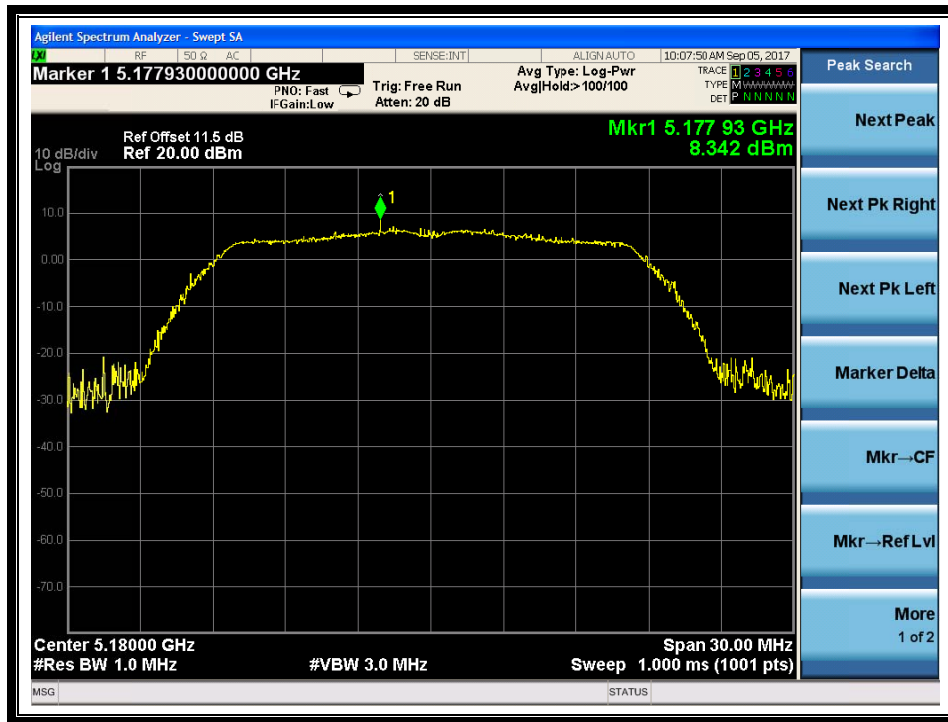

(Channel 36: 5180MHz @ 802.11n-20MHz)

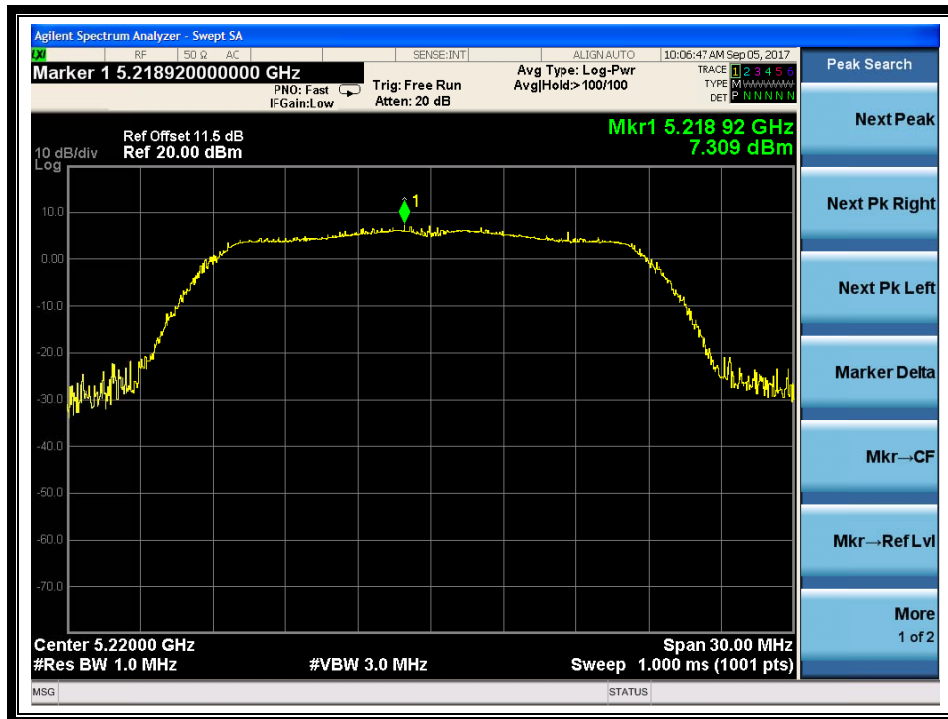

(Channel 44: 5220 MHz @ 802.11n-20MHz)

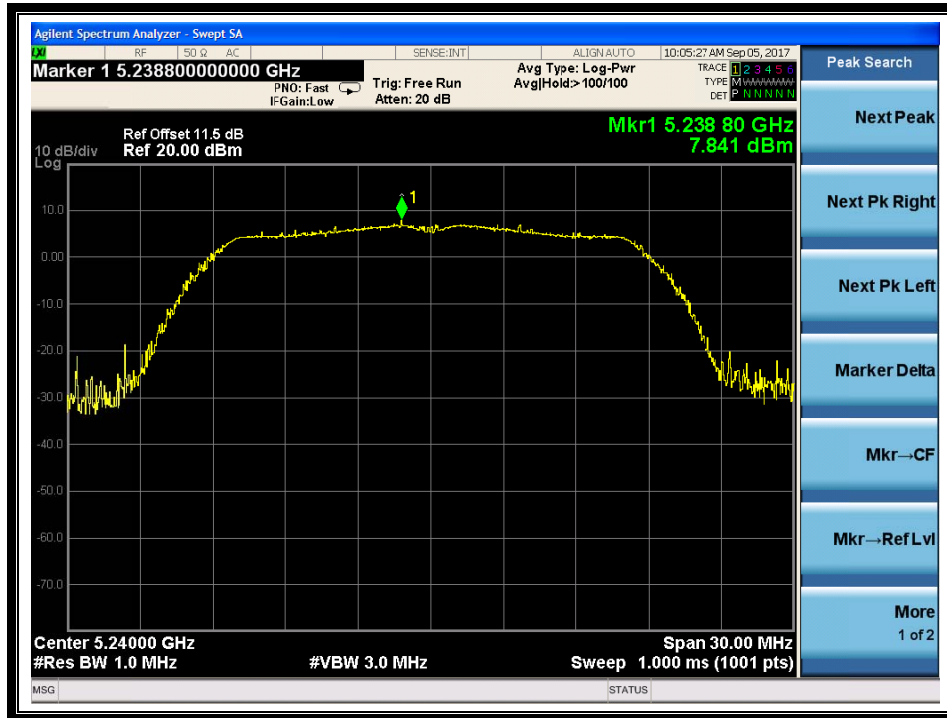

(Channel 48: 5240MHz @ 802.11n-20MHz)

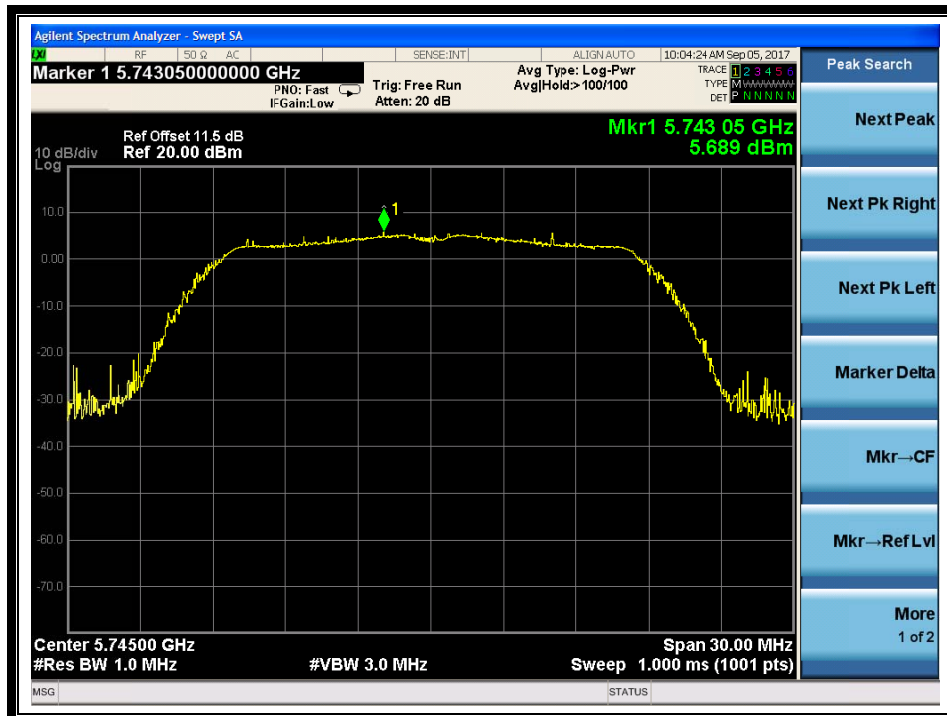

(Channel 149: 5745MHz @ 802.11n-20MHz)

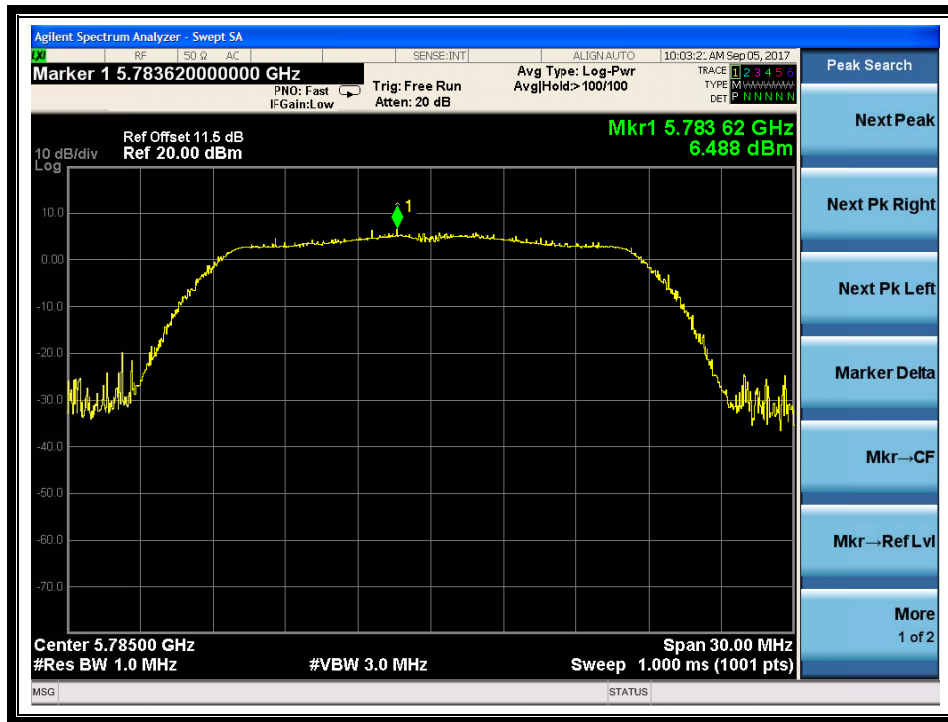

(Channel 157: 5785MHz @802.11n-20MHz)

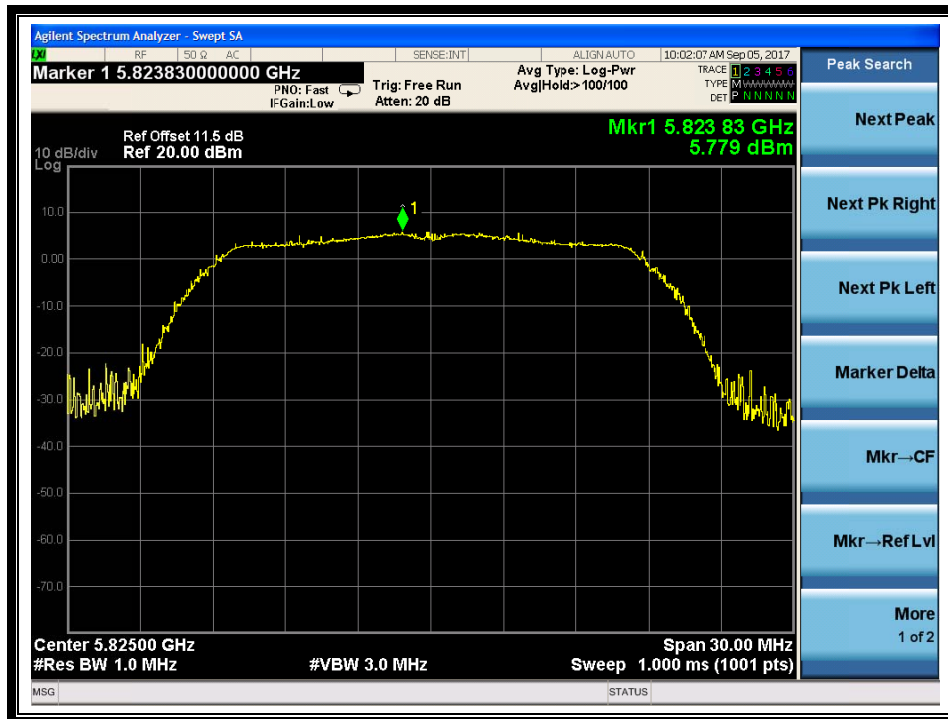

(Channel 165: 5825MHz @ 802.11n-20MHz)



2.4.3.3 802.11n-40MHz Test mode

A. Test Verdict:

Channel	Frequency (MHz)	Measured PSD (dBm/MHz)	Limit (dBm/MHz)	Verdict
38	5190	5.50	11	PASS
46	5230	4.73		
Channel	Frequency (MHz)	Measured PSD (dBm/500KHz)	Limit (dBm/500KHz)	Verdict
151	5755	2.95	30	PASS
159	5795	2.91		

B. Test Plots

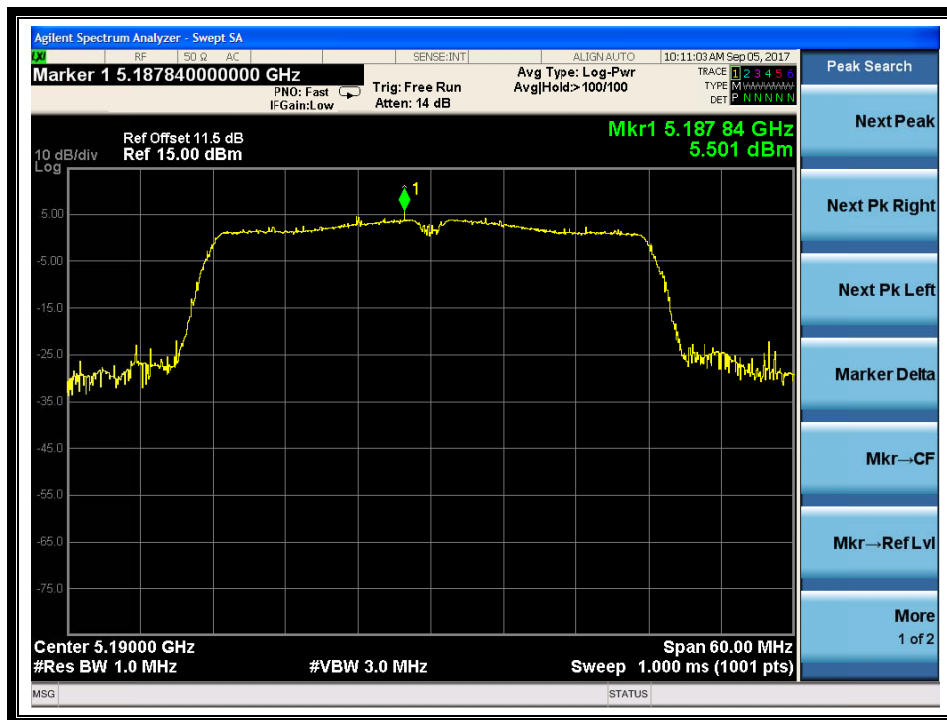

(Channel 38: 5190MHz @ 802.11n-40)

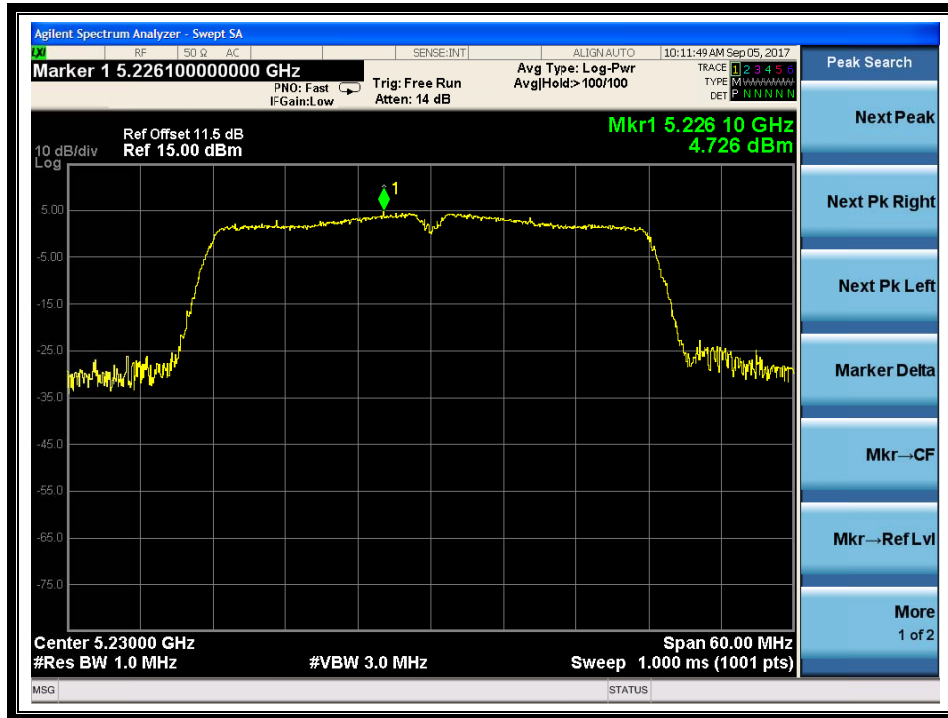

(Channel 46: 5230 MHz @ 802.11 n-40)

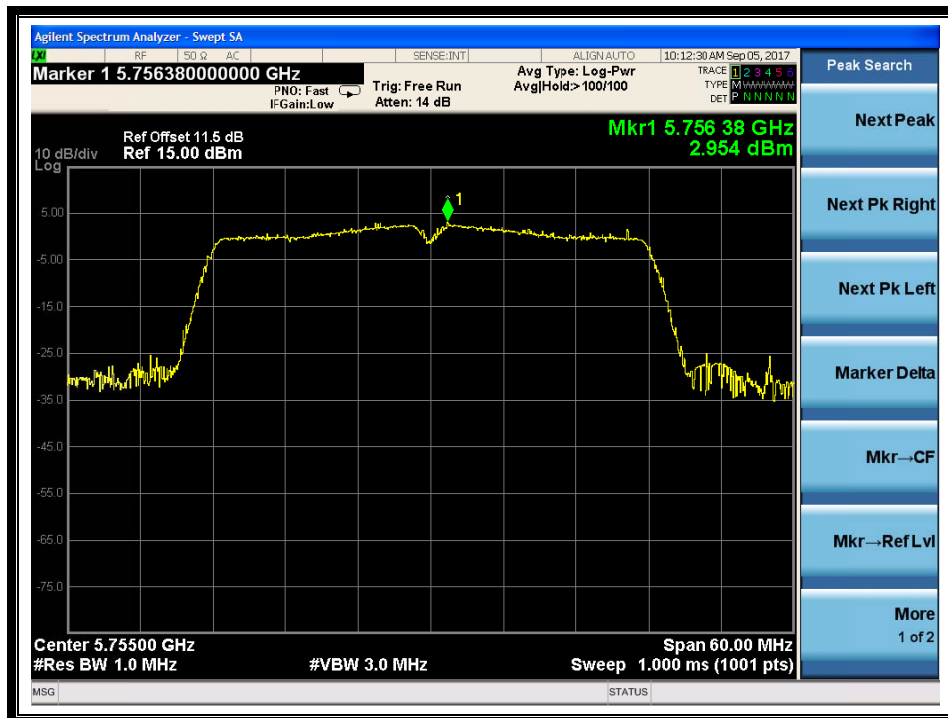

(Channel 151: 5755MHz @ 802.11 n-40)

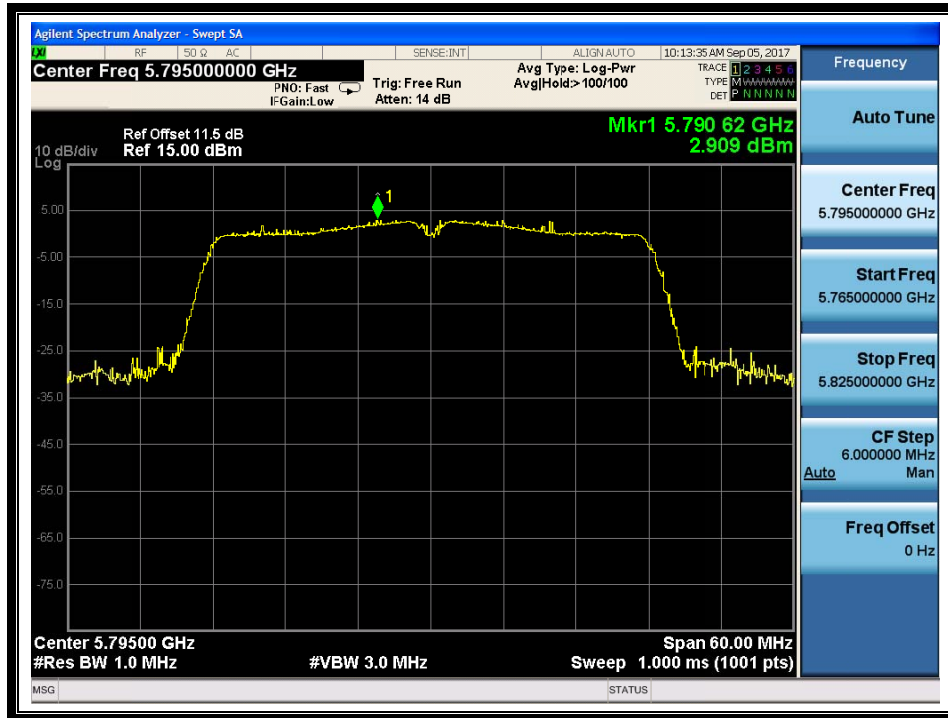

(Channel 159: 5795MHz @ 802.11 n-40)

2.5 Restricted Frequency Bands

2.5.1 Requirement

According to FCC section 15.407(b)(7), in any 100kHz bandwidth outside the frequency band in which the spread spectrum or digitally modulated intentional radiator is operating, the radio frequency power that is produced by the intentional radiator shall be at least 20dB below that in the 100kHz bandwidth within the band that contains the highest level of the desired power, In addition, radiated emissions which fall in the restricted bands, as defined in 15.205(a), must also comply with the radiated emission limits specified in 15.209(a).

2.5.2 Test Description

A. Test Setup

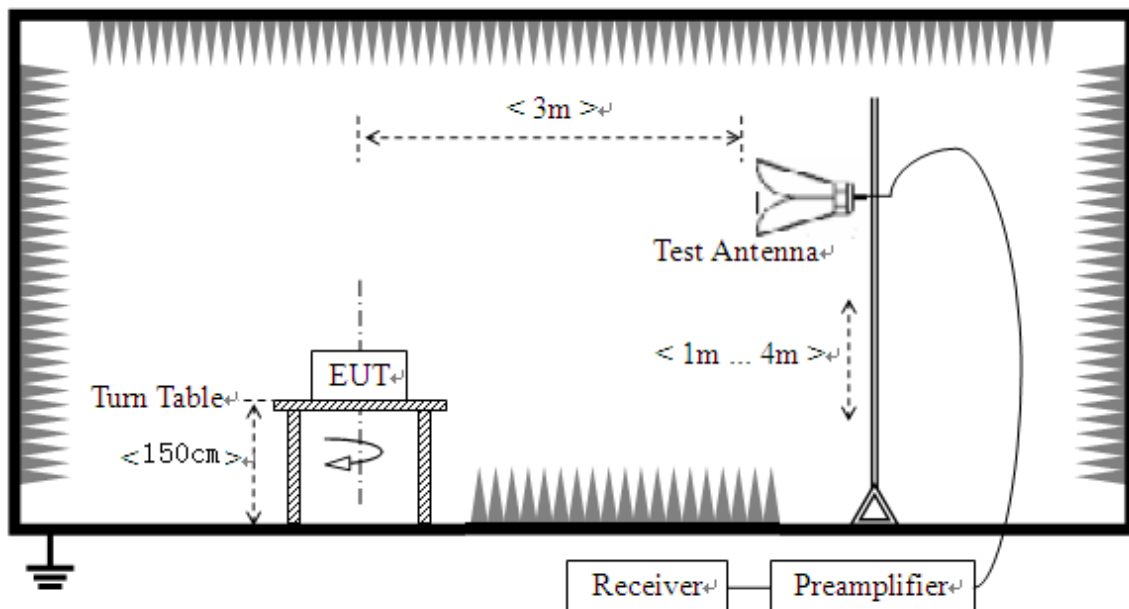

The Module is located in a 3m Semi-Anechoic Chamber; the antenna factors, cable loss and so on of the site as factors are calculated to correct the reading.

KDB 789033 Section H) 3)5)6(d)) was used in order to prove compliance

For the Test Antenna:

Test Antenna is 3m away from the EUT. Test Antenna height is varied from 1m to 4m above the ground to determine the maximum value of the field strength.



2.5.3 Test Result

The lowest and highest channels are tested to verify Restricted Frequency Bands.

The measurement results are obtained as below:

$$E \text{ [dB}\mu\text{V/m]} = U_R + A_T + A_{\text{Factor}} \text{ [dB]}; A_T = L_{\text{Cable loss}} \text{ [dB]} - G_{\text{preamp}} \text{ [dB]}$$

A_T : Total correction Factor except Antenna

U_R : Receiver Reading

G_{preamp} : Preamplifier Gain

A_{Factor} : Antenna Factor at 3m

Note: Restricted Frequency Bands were performed when antenna was at vertical and horizontal polarity, and only the worse test condition (vertical) was recorded in this test report.

2.5.3.1 802.11a Test mode

The lowest and highest channels are tested to verify the band edge emissions.

A. Test Verdict:

Channel	Frequency (MHz)	Detector	Receiver Reading	A_T (dB)	A_{Factor} (dB@3m)	Max. Emission E (dB μ V/m)	Limit (dB μ V/m)	Verdict
		PK/ AV	U_R (dB μ V)					
36	5133.75	PK	49.61	-50.65	32.11	31.07	74	Pass
36	5135.24	AV	35.63	-50.65	32.11	17.09	54	Pass
48	5358.98	PK	42.81	-50.65	32.11	24.27	74	Pass
48	5356.50	AV	33.22	-50.65	32.11	14.68	54	Pass



B. Test Plots:

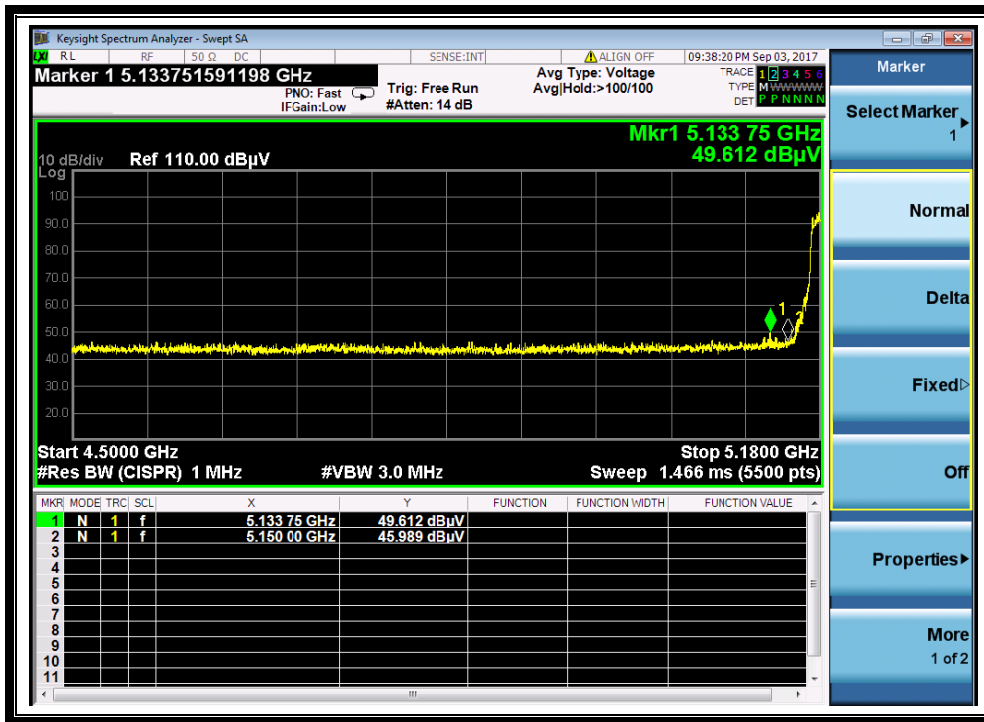

(Channel = 36 PEAK @ 802.11a)

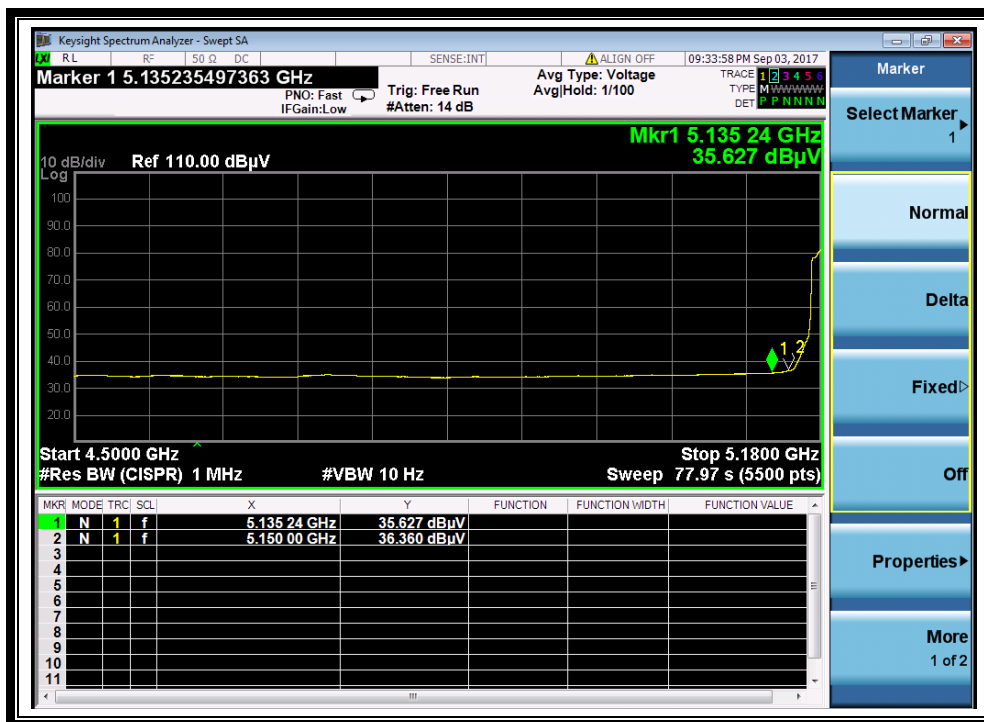

(Channel = 36 AVG @ 802.11a)

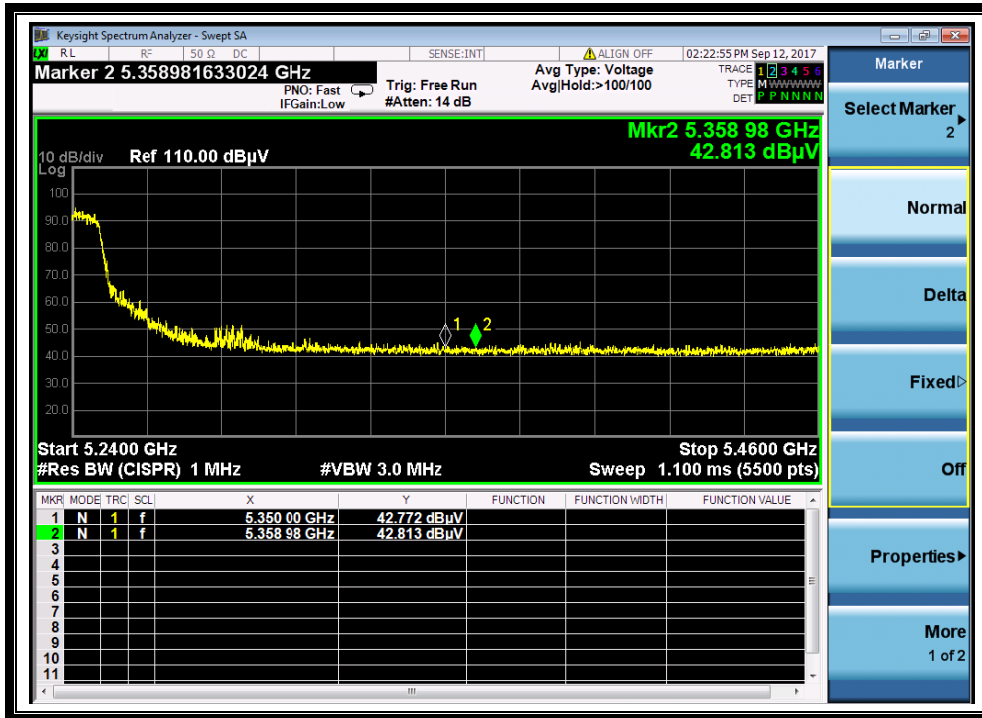

(Channel = 48 PEAK @ 802.11a)



(Channel = 48 AVG @ 802.11a)



2.5.3.2 802.11n-20MHz Test mode

The lowest and highest channels are tested to verify the band edge emissions.

A. Test Verdict:

Channel	Frequency (MHz)	Detector	Receiver Reading	A _T (dB)	A _{Factor} (dB@3m)	Max. Emission E (dBμV/m)	Limit (dBμV/m)	Verdict
		PK/ AV	U _R (dBuV)					
36	5132.89	PK	49.20	-50.65	32.11	30.66	74	Pass
36	5143.27	AV	35.83	-50.65	32.11	17.29	54	Pass
48	5360.98	PK	46.80	-50.65	32.11	28.26	74	Pass
48	5357.06	AV	33.22	-50.65	32.11	14.68	54	Pass

B. Test Plots:

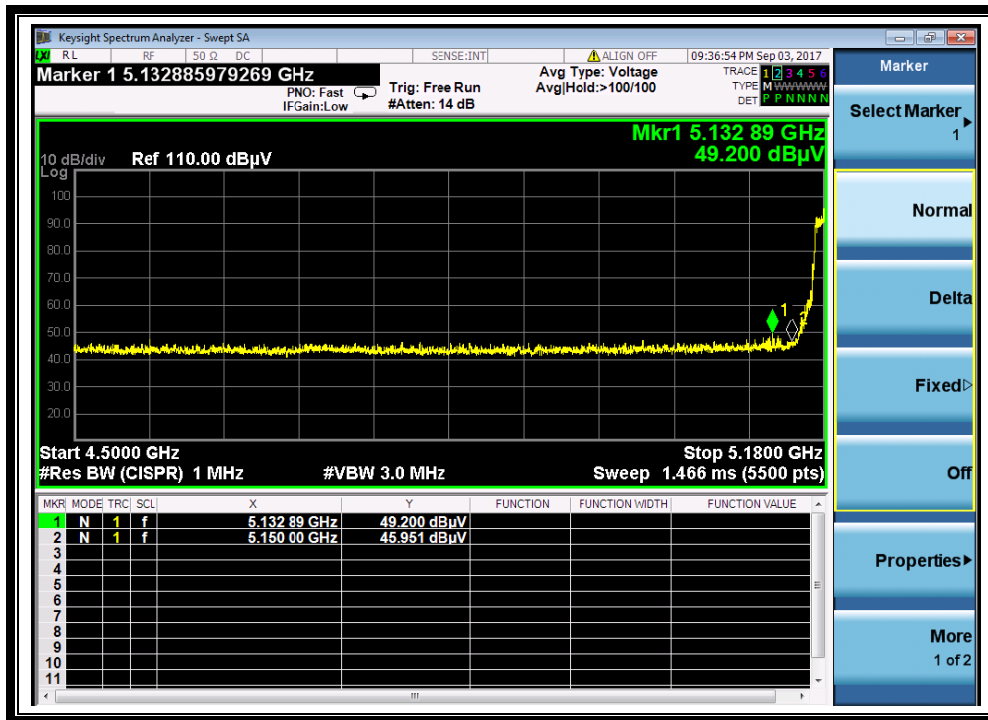

(Channel = 36 PEAK @ 802.11n 20MHz)

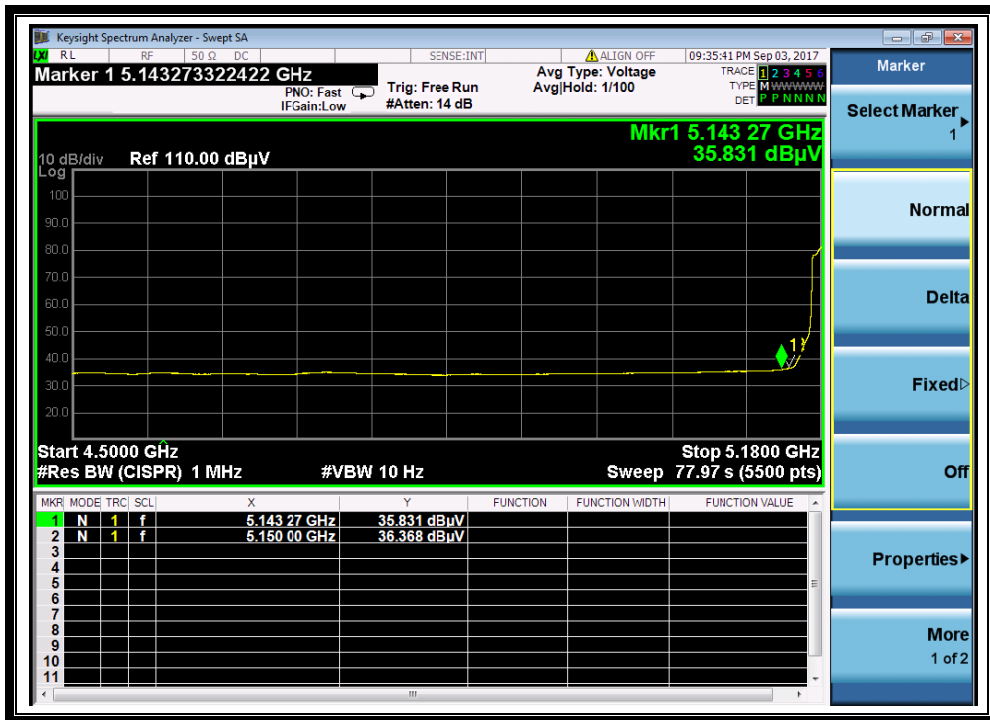

(Channel = 36 AVG @ 802.11n 20MHz)

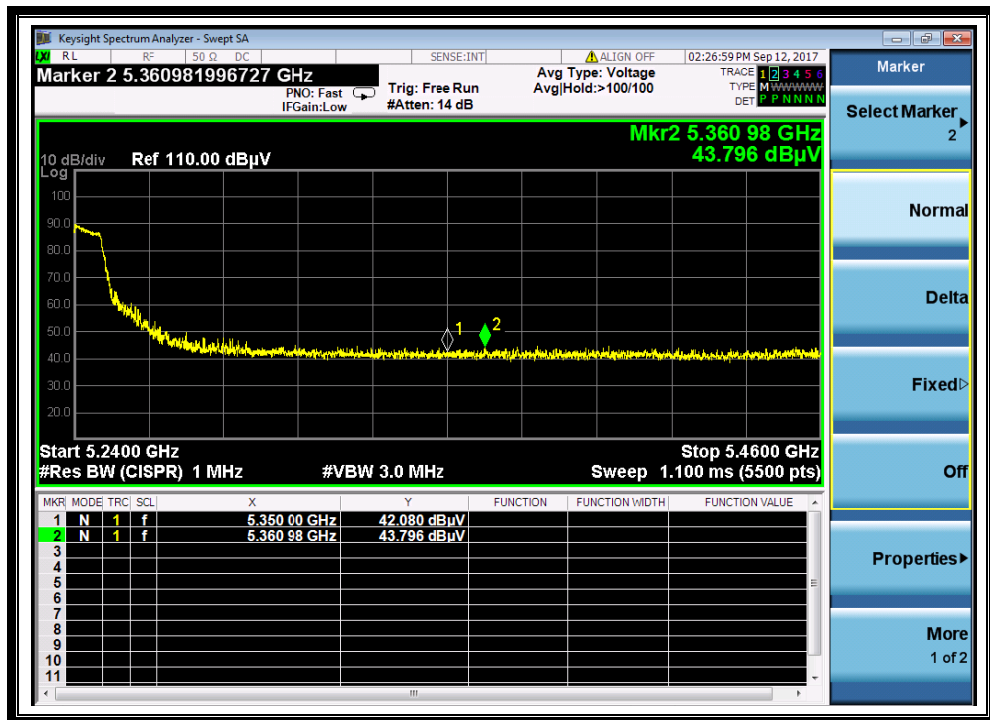

(Channel = 48 PEAK @ 802.11n 20MHz)

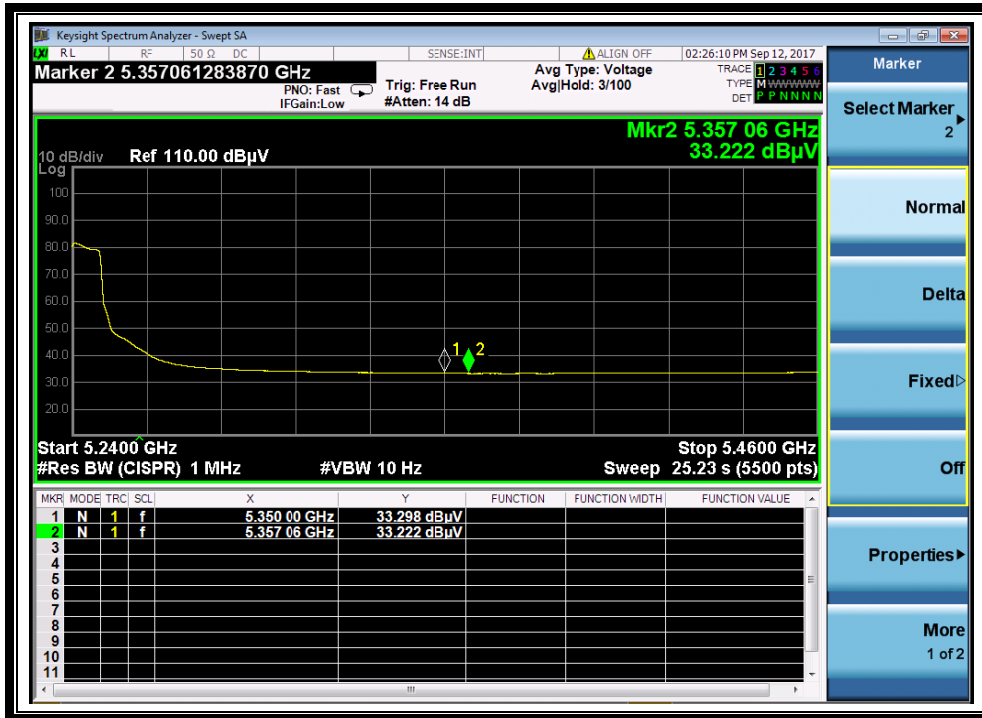

(Channel = 48 AVG @ 802.11n 20MHz)

2.5.3.3 802.11n-40MHz Test mode

The lowest and highest channels are tested to verify the band edge emissions.

A. Test Verdict:

Channel	Frequency (MHz)	Detector	Receiver Reading U _R (dBuV)	A _T (dB)	A _{Factor} (dB@3m)	Max. Emission E (dBμV/m)	Limit (dBμV/m)	Verdict
		PK/ AV						
38	5133.28	PK	48.26	-50.65	32.11	29.72	74	Pass
38	5134.66	AV	35.29	-50.65	32.11	16.75	54	Pass
46	5364.22	PK	44.03	-50.65	32.11	25.49	74	Pass
46	5359.34	AV	33.25	-50.65	32.11	14.71	54	Pass



B. Test Plots:

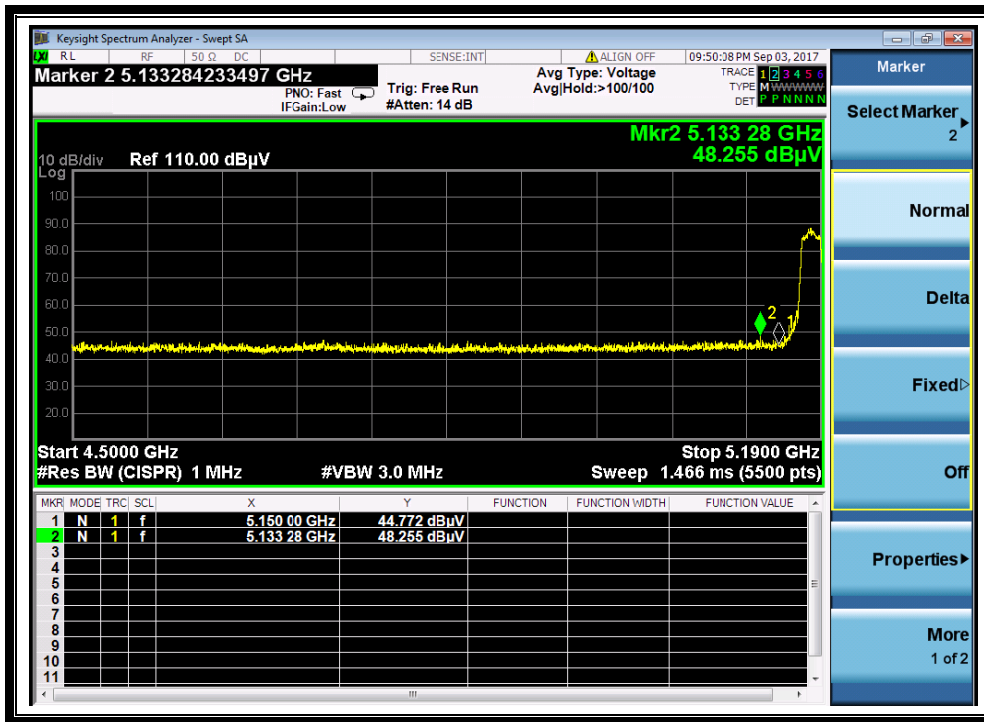

(Channel = 38 PEAK @ 802.11 n-40)

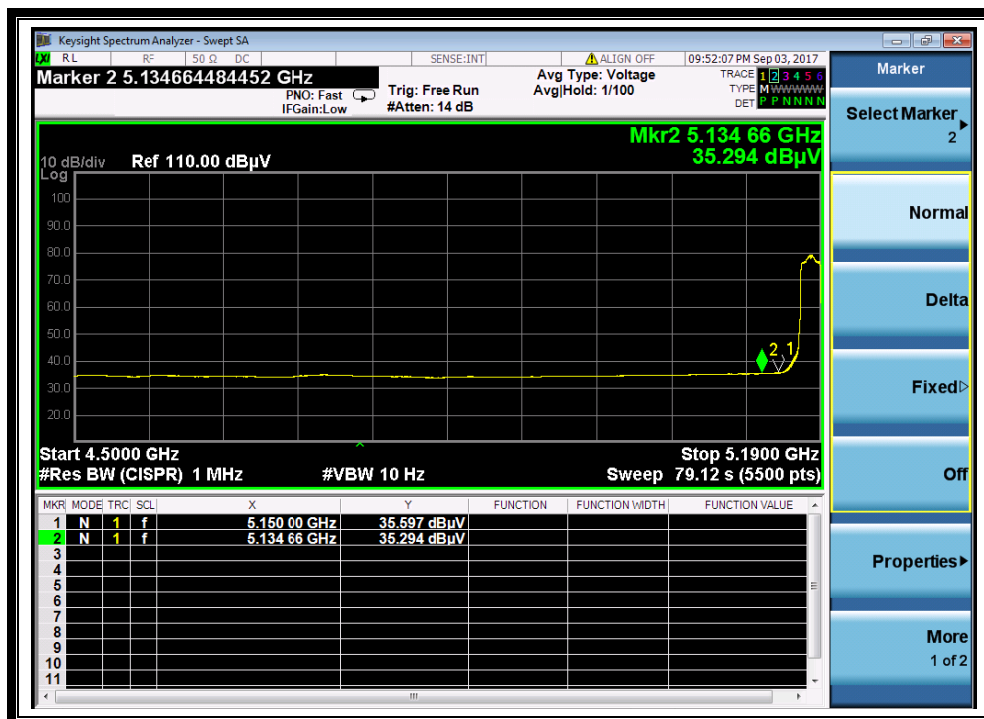

(Channel = 38 AVG @ 802.11 n-40)

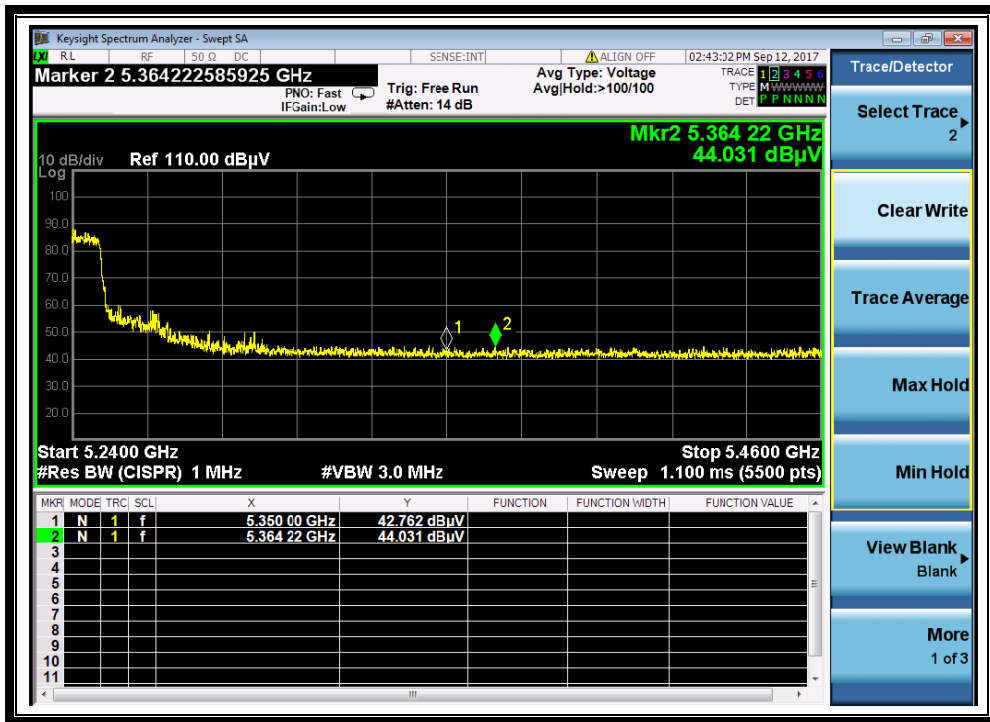

(Channel = 46 PEAK @ 802.11 n-40)

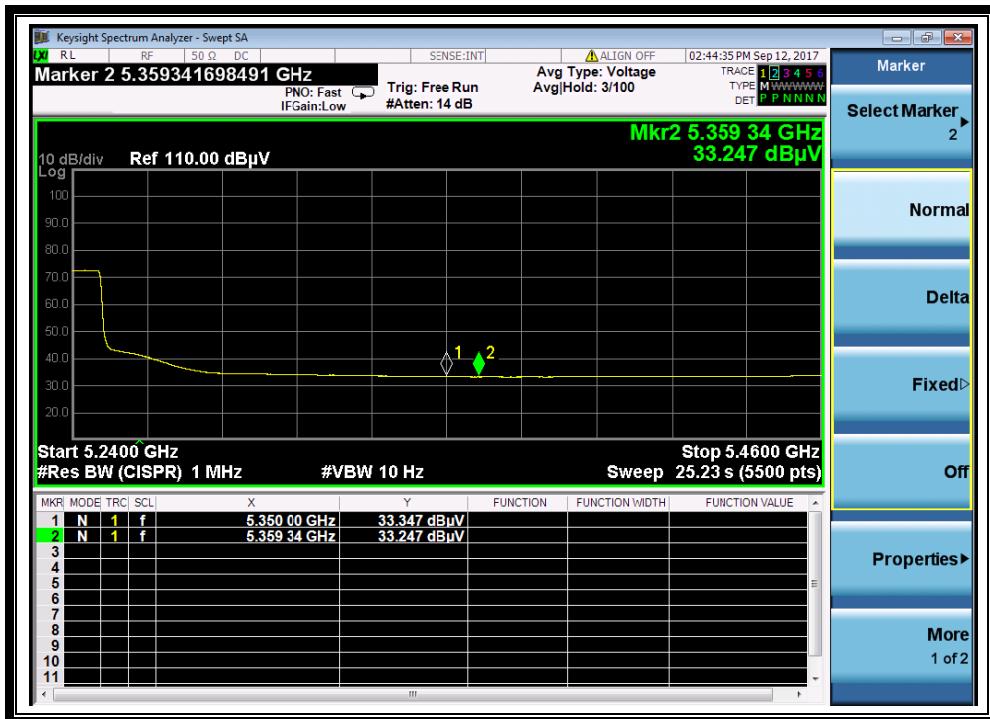

(Channel = 46 AVG @ 802.11n-40)



2.6 Frequency Stability

2.6.1 Requirement

Manufacturers of U-NII devices are responsible for ensuring frequency stability such that an emission is maintained within the band of operation under all conditions of normal operation as specified in the user's manual.

2.6.2 Test Procedure

The EUT was placed inside of an environmental chamber as the temperature in the chamber was varied between -30°C and +50°C. The temperature was incremented by 10° intervals and the unit was allowed to stabilize at each temperature before each measurement. The center frequency of the transmitting channel was evaluated at each temperature and the frequency deviation from the channel's center frequency was recorded. Data for the worst case channel is shown below.

2.6.3 Test Result

Frequency Stability Measurements for UNII Band 1 (Ch. 36)

VOLTAGE (%)	POWER (VDC)	TEMP (°C)	FREQUENCY (Hz)	Freq Dev. (Hz)	Deviation (%)
100%	14.52	+20(Ref)	5,179,999,964	15	0.0000007
100%		-30	5,180,000,025	11	0.0000005
100%		-20	5,179,999,985	2	0.0000003
100%		-10	5,179,999,997	23	0.0000001
100%		0	5,180,000,014	21	0.0000003
100%		+10	5,180,000,024	14	0.0000005
100%		+20	5,179,999,995	15	0.0000001
100%		+30	5,179,999,989	27	0.0000002
100%		+40	5,180,000,027	2	0.0000005
100%		+50	5,180,000,019	1	0.0000004
85%		12.00	+20	5,179,999,987	19
115%	16.80	+20	5,179,999,997	23	0.0000001



Frequency Stability Measurements for UNII Band 3 (Ch. 149)

VOLTAGE (%)	POWER (VDC)	TEMP (°C)	FREQUENCY (Hz)	Freq Dev. (Hz)	Deviation (%)
100%	14.52	+20(Ref)	5,745,000,036	12	0.0000006
100%		-30	5,744,999,987	1	0.0000002
100%		-20	5,745,000,025	11	0.0000004
100%		-10	5,744,999,995	5	0.0000001
100%		0	5,745,000,014	1	0.0000002
100%		+10	5,744,999,997	4	0.0000001
100%		+20	5,745,000,025	4	0.0000004
100%		+30	5,745,000,009	12	0.0000002
100%		+40	5,744,999,989	3	0.0000002
100%		+50	5,745,000,014	16	0.0000002
85%		12.00	+20	5,744,999,986	11
115%	16.80	+20	5,745,000,029	16	0.0000005

Note: Based on the results of the frequency stability test shown above the frequency deviation results measured are very small. As such it is determined that the channels at the band edge would remain in-band when the maximum measured frequency deviation noted during the frequency stability tests is applied. Therefore the device is determined to remain operating in band over the temperature and voltage range as tested.



2.7 Transmit Power Control (TPC) and Dynamic Frequency Selection (DFS)

2.7.1 Requirement

According to FCC section 15.407(h), (1) Transmit power control (TPC). U-NII devices operating in the 5.25-5.35 GHz band and the 5.47-5.725 GHz band shall employ a TPC mechanism. The U-NII device is required to have the capability to operate at least 6 dB below the mean EIRP value of 30 dBm. A TPC mechanism is not required for systems with an e.i.r.p. of less than 500 mW.

(2) Radar Detection Function of Dynamic Frequency Selection (DFS). U-NII devices operating with any part of its 26 dB emission bandwidth in the 5.25-5.35 GHz and 5.47-5.725 GHz bands shall employ a DFS radar detection mechanism to detect the presence of radar systems and to avoid co-channel operation with radar systems. Operators shall only use equipment with a DFS mechanism that is turned on when operating in these bands. The device must sense for radar signals at 100 percent of its emission bandwidth. The minimum DFS detection threshold for devices with a maximum e.i.r.p. of 200 mW to 1 W is -64 dBm. For devices that operate with less than 200 mW e.i.r.p. and a power spectral density of less than 10 dBm in a 1 MHz band, the minimum detection threshold is -62 dBm. The detection threshold is the received power averaged over 1 microsecond referenced to a 0 dBi antenna. For the initial channel setting, the manufacturers shall be permitted to provide for either random channel selection or manual channel selection.

A U-NII network will employ a DFS function to detect signals from radar systems and to avoid co-channel operation with these systems. This applies to the 5250-5350 MHz and/or 5470-5725 MHz bands.¹

Within the context of the operation of the DFS function, a U-NII device will operate in either Master Mode or Client Mode. U-NII devices operating in Client Mode can only operate in a network controlled by a U-NII device operating in Master Mode.²

Tables 1 and 2 shown below summarize the information contained in sections 5.1.1 and 5.1.2.

Table 1: Applicability of DFS Requirements Prior to Use of a Channel

Requirement	Operational Mode		
	Master	Client Without Radar Detection	Client With Radar Detection
Non-Occupancy Period	Yes	Not required	Yes
DFS Detection Threshold	Yes	Not required	Yes
Channel Availability Check Time	Yes	Not required	Not required
U-NII Detection Bandwidth	Yes	Not required	Yes



Table 2: Applicability of DFS requirements during normal operation

Requirement	Operational Mode	
	Master	Client Without Radar Detection
DFS Detection Threshold	Yes	Not required
Channel Closing Transmission Time	Yes	Yes
Channel Move Time	Yes	Yes
U-NII Detection Bandwidth	Yes	Not required

Additional requirements for devices with multiple bandwidth modes	Master Device or Client with Radar Detection	Client Without Radar Detection
U-NII Detection Bandwidth and Statistical Performance Check	All BW modes must be tested	Not required
Channel Move Time and Channel Closing Transmission Time	Test using widest BW mode available	Test using the widest BW mode available for the link
All other tests	Any single BW mode	Not required

Note: Frequencies selected for statistical performance check (Section 7.8.4) should include several frequencies within the radar detection bandwidth and frequencies near the edge of the radar detection bandwidth. For 802.11 devices it is suggested to select frequencies in each of the bonded 20 MHz channels and the channel center frequency.

The operational behavior and individual DFS requirements that are associated with these modes are as follows:

2.7.1.1 Master Devices

- a) The Master Device will use DFS in order to detect Radar Waveforms with received signal strength above the DFS Detection Threshold in the 5250 – 5350 MHz and 5470 – 5725 MHz bands. DFS is not required in the 5150 – 5250 MHz or 5725 – 5825 MHz bands.
- b) Before initiating a network on a Channel, the Master Device will perform a Channel Availability Check for a specified time duration (Channel Availability Check Time) to ensure that there is no radar system operating on the Channel, using DFS described under subsection a) above.
- c) The Master Device initiates a U-NII network by transmitting control signals that will enable other U-NII devices to Associate with the Master Device.
- d) During normal operation, the Master Device will monitor the Channel (In-Service Monitoring) to ensure that there is no radar system operating on the Channel, using DFS described under a).
- e) If the Master Device has detected a Radar Waveform during In-Service Monitoring as described under d), the Operating Channel of the U-NII network is no longer an Available Channel. The Master Device will instruct all associated Client Device(s) to stop transmitting on this Channel within the Channel Move Time. The transmissions during the Channel Move Time will be limited to



the Channel Closing Transmission Time.

f) Once the Master Device has detected a Radar Waveform it will not utilize the Channel for the duration of the Non-Occupancy Period. 3

g) If the Master Device delegates the In-Service Monitoring to a Client Device, then the combination will be tested to the requirements described under d) through f) above.

2.7.1.2 Client Devices

a) A Client Device will not transmit before having received appropriate control signals from a Master Device.

b) A Client Device will stop all its transmissions whenever instructed by a Master Device to which it is associated and will meet the Channel Move Time and Channel Closing Transmission Time requirements. The Client Device will not resume any transmissions until it has again received control signals from a Master Device.

c) If a Client Device is performing In-Service Monitoring and detects a Radar Waveform above the DFS Detection Threshold, it will inform the Master Device. This is equivalent to the Master Device detecting the Radar Waveform and d) through f) of section 5.1.1 apply.

d) Irrespective of Client Device or Master Device detection the Channel Move Time and Channel Closing Transmission Time requirements remain the same.

e) The client test frequency must be monitored to ensure no transmission of any type has occurred for 30 minutes. Note: If the client moves with the master, the device is considered compliant if nothing appears in the client non-occupancy period test. For devices that shut down (rather than moving channels), no beacons should appear.

2.7.1.3 DFS Detection Thresholds

Table 3 below provides the DFS Detection Thresholds for Master Devices as well as Client Devices incorporating In-Service Monitoring.

Table 3: DFS Detection Thresholds for Master Devices and Client Devices With Radar Detection

Maximum Transmit Power	Value (See Notes 1, 2, and 3)
EIRP \geq 200 milliwatt	-64 dBm
EIRP < 200 milliwatt and power spectral density < 10 dBm/MHz	-62 dBm
EIRP < 200 milliwatt that do not meet the power spectral density requirement	-64 dBm

Note 1: This is the level at the input of the receiver assuming a 0 dBi receive antenna.

Note 2: Throughout these test procedures an additional 1 dB has been added to the amplitude of the test transmission waveforms to account for variations in measurement equipment. This will ensure that the test signal is at or above the detection threshold level to trigger a DFS response.

Note3: EIRP is based on the highest antenna gain. For MIMO devices refer to KDB Publication 662911 D01.

2.7.1.4 Response Requirements

Table 4 provides the response requirements for Master and Client Devices incorporating DFS.

Table 4: DFS Response Requirement Values

Parameter	Value
Non-occupancy period	Minimum 30 minutes
Channel Availability Check Time	60 seconds
Channel Move Time	10 seconds See Note 1.
Channel Closing Transmission Time	200 milliseconds + an aggregate of 60 milliseconds over remaining 10 second period. See Notes 1 and 2.
U-NII Detection Bandwidth	Minimum 100% of the U-NII 99% transmission power bandwidth. See Note 3.

Note 1: Channel Move Time and the Channel Closing Transmission Time should be performed with Radar Type 0. The measurement timing begins at the end of the Radar Type 0 burst.

Note 2: The Channel Closing Transmission Time is comprised of 200 milliseconds starting at the beginning of the Channel Move Time plus any additional intermittent control signals required to facilitate a Channel move (an aggregate of 60 milliseconds) during the remainder of the 10 second period. The aggregate duration of control signals will not count quiet periods in between transmissions.

Note 3: During the U-NII Detection Bandwidth detection test, radar type 0 should be used. For each frequency step the minimum percentage of detection is 90 percent. Measurements are performed with no data traffic.

2.7.2 Test Description

Section 7.2 of KDB 905462 D02 V01R01

B. Test Setup:

B.1 Setup for Master with injection at the Master

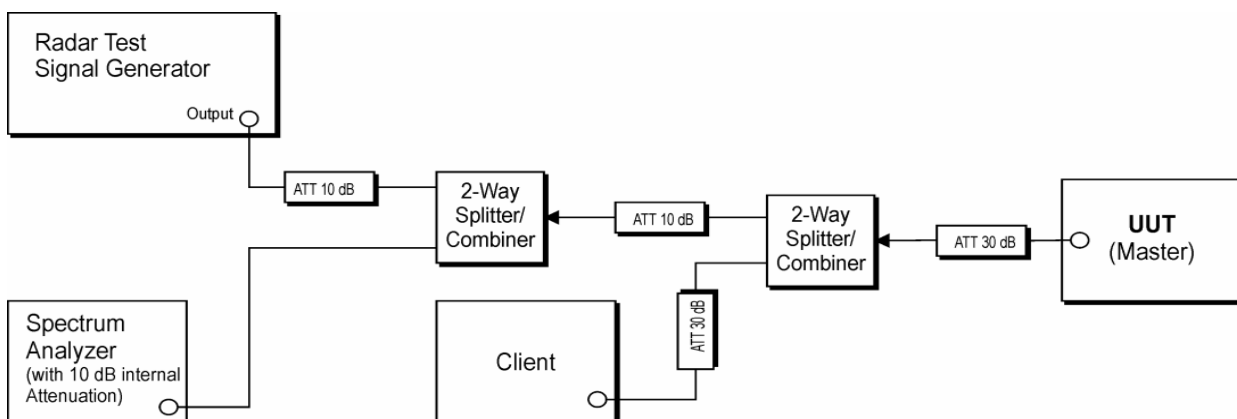

Figure 2: Example Conducted Setup where UUT is a Master and Radar Test Waveforms are injected into the Master

B.2 Setup for Client with injection at the Master

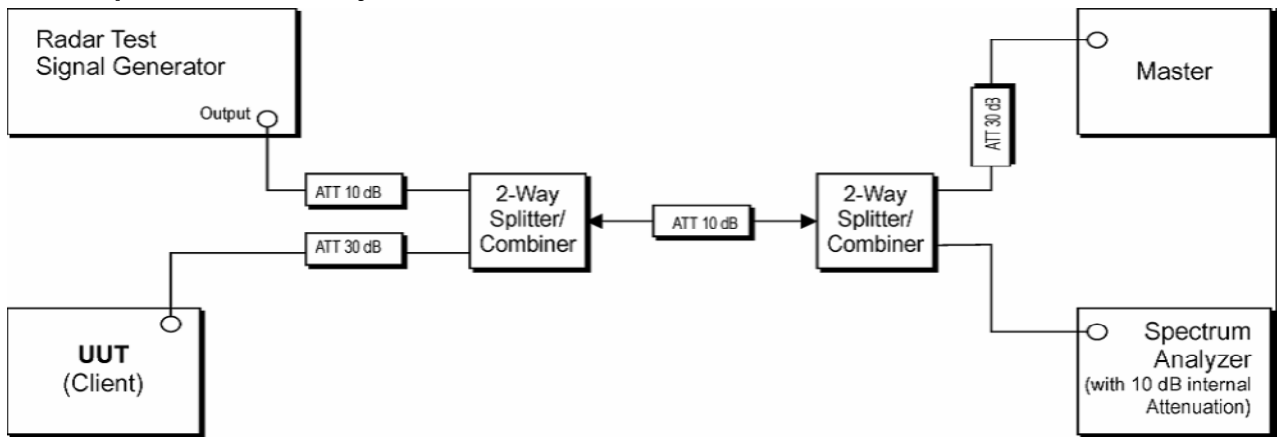

Figure 3: Example Conducted Setup where UUT is a Client and Radar Test Waveforms are injected into the Master

B.3 Setup for Client with injection at the Client

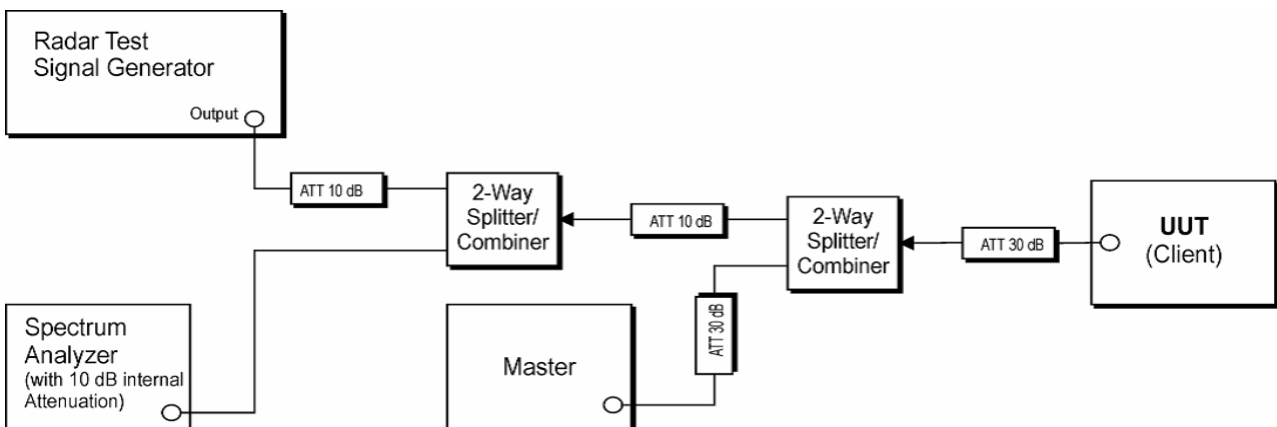

Figure 4: Example Conducted Setup where UUT is a Client and Radar Test Waveforms are injected into the Client

2.7.3 Test Result

This test case not applies this kind of EUT.

2.8 Conducted Emission

2.8.1 Requirement

According to FCC section 15.207, for an intentional radiator that is designed to be connected to the public utility (AC) power line, the radio frequency voltage that is conducted back onto the AC power line on any frequency within the band 150kHz to 30MHz shall not exceed the limits in the following table, as measured using a 50 μ H/50 Ω line impedance stabilization network (LISN).

Frequency range (MHz)	Conducted Limit (dB μ V)	
	Quai-peak	Average
0.15 - 0.50	66 to 56	56 to 46
0.50 - 5	56	46
5 - 30	60	50

NOTE:

- (a) The lower limit shall apply at the band edges.
- (b) The limit decreases linearly with the logarithm of the frequency in the range 0.15 - 0.50MHz.

2.8.2 Test Description

A. Test Setup:

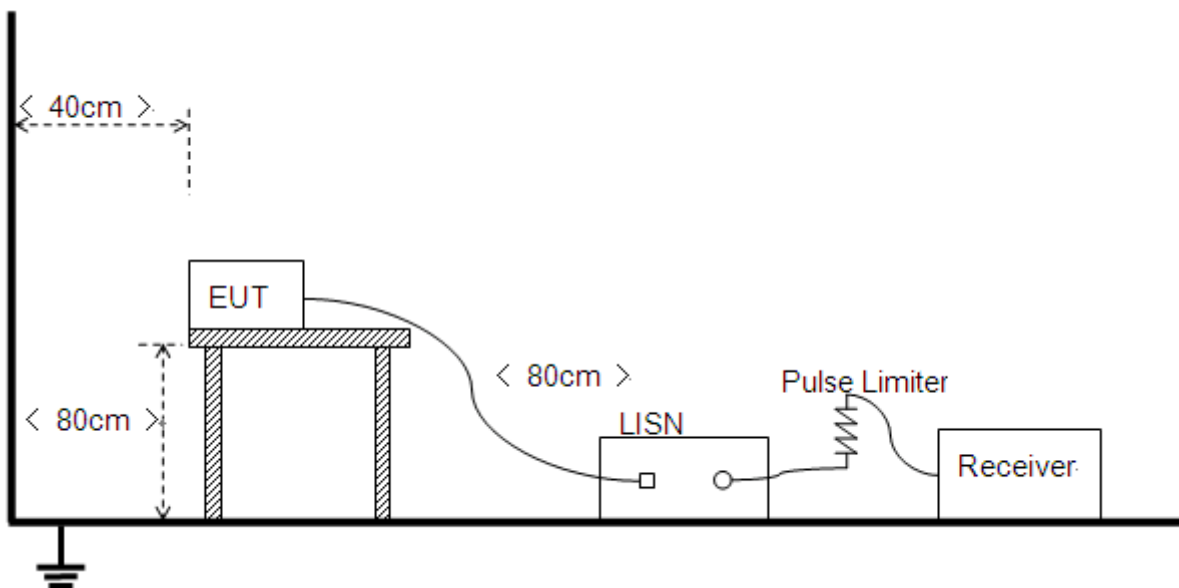

The Table-top EUT was placed upon a non-metallic table 0.8m above the horizontal metal reference ground plane. EUT was connected to LISN and LISN was connected to reference Ground Plane. EUT was 80cm from LISN. The set-up and test methods were according to ANSI C63.10: 2013.

The EUT is powered by the Battery charged with the AC Adapter which is powered by 120V, 60Hz AC mains supply. The factors of the site are calibrated to correct the reading. During the



measurement, the EUT is activated and controlled by the Wi-Fi Service Supplier (SS) via a Common Antenna.

2.8.3 Test Result

The maximum conducted interference is searched using Peak (PK), if the emission levels more than the AV and QP limits, and that have narrow margins from the AV and QP limits will be re-measured with AV and QP detectors. Tests for both L phase and N phase lines of the power mains connected to the EUT are performed. Refer to recorded points and plots below.

Note: All test modes are performed, only the worst case is recorded in this report.

A. Test setup:

The EUT configuration of the emission tests is EUT + Link.

Note: The test voltage is AC 120V/60Hz.

A. Test Plots:

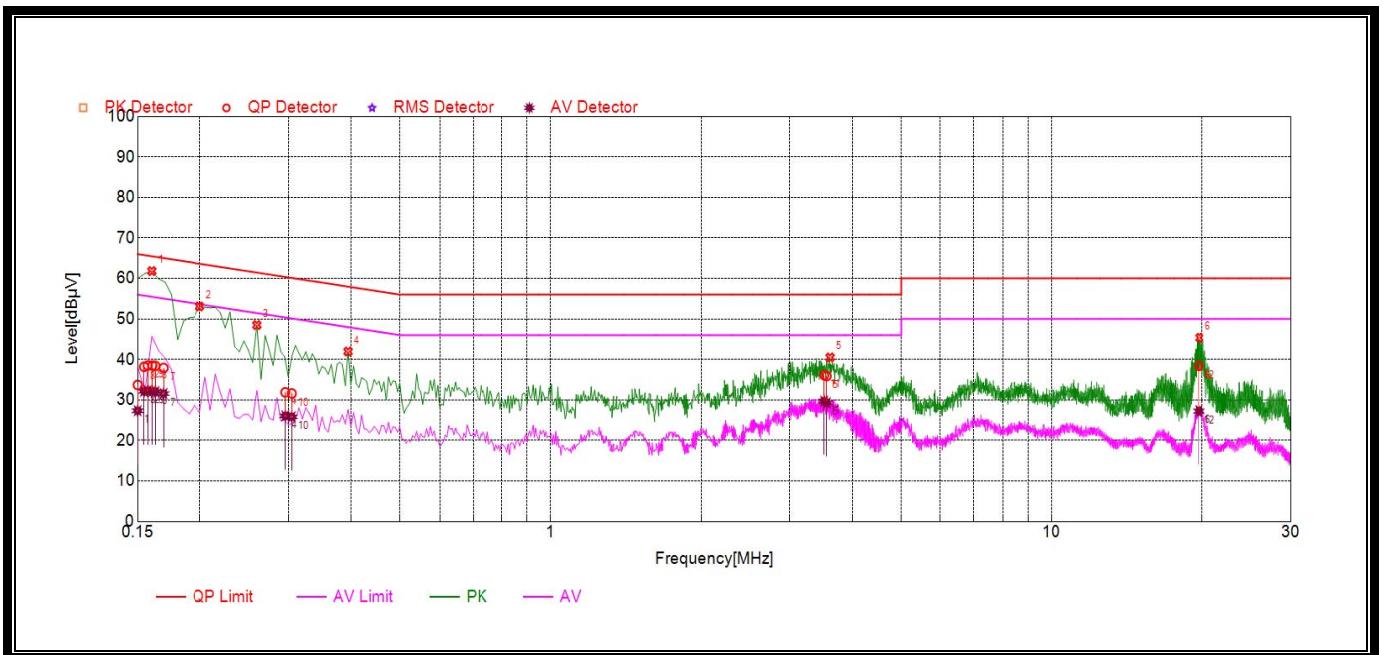

(Plot A: L Phase)

NO.	Fre. (MHz)	Emission Level (dBµV)		Limit (dBµV)		Power-line	Verdict
		Quai-peak	Average	Quai-peak	Average		
1	0.15	33.71	27.33	66.00	56.00	Line	PASS
2	0.157	38.50	32.21	65.80	55.80		PASS
3	0.1626	38.41	32.06	65.64	55.64		PASS
4	0.296	31.88	26.07	61.83	51.83		PASS
5	3.56	35.90	29.28	60	50		PASS
6	19.697	38.39	27.29	60	50		PASS

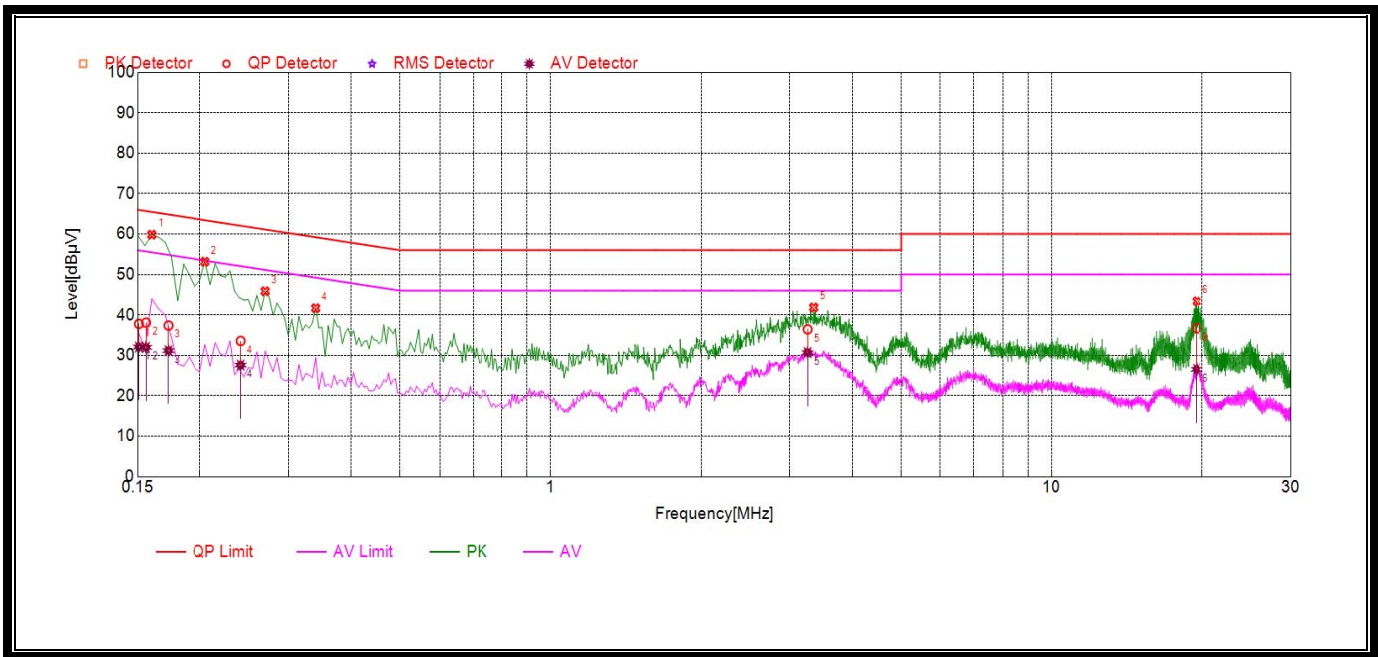

(Plot B: N Phase)

NO.	Fre. (MHz)	Emission Level (dBµV)		Limit (dBµV)		Power-line	Verdict
		Quai-peak	Average	Quai-peak	Average		
1	0.1508	37.78	32.06	65.98	55.98	Line	PASS
2	0.1558	38.10	31.96	65.83	55.83		PASS
3	0.1726	37.37	31.17	65.35	55.35		PASS
4	0.2414	33.56	27.58	63.39	53.39		PASS
5	3.2624	36.43	30.69	60	50		PASS
6	19.4388	36.69	26.52	60	50		PASS



2.9 Radiated Emission

2.9.1 Requirement

The peak emissions outside of the frequency bands of operation shall be attenuated in accordance with the following limits:

- (1) For transmitters operating in the 5.15–5.25 GHz band: all emissions outside of the 5.15–5.35 GHz band shall not exceed an EIRP of -27dBm/MHz.
- (2) For transmitters operating in the 5.25–5.35 GHz band: all emissions outside of the 5.15–5.35 GHz band shall not exceed an EIRP of -27dBm/MHz.
- (3) For transmitters operating in the 5.47–5.725 GHz band: all emissions outside of the 5.47–5.725 GHz band shall not exceed an EIRP of -27dBm/MHz.
- (4) For transmitters operating in the 5.725-5.85 GHz band: All emissions within the frequency range from the band edge to 10 MHz above or below the band edge shall not exceed an e.i.r.p. of -17 dBm/MHz; for frequencies 10 MHz or greater above or below the band edge, emissions shall not exceed an e.i.r.p. of -27 dBm/MHz.

The following formula is used to convert the equipment isotropic radiated power(eirp) to field strength (dBμV/m);

$$E = 1000000 \times \sqrt{30P} / 3 \mu\text{V/m}$$

where P is the EIRP in Watts

Therefore: -27 dBm/MHz = 68.23 dBuV/m

Unwanted emissions below 1 GHz must comply with the general field strength limits set forth in § 15.209. According to FCC section 15.209 (a), except as provided elsewhere in this subpart, the emissions from an intentional radiator shall not exceed the field strength levels specified in the following table:

Frequency (MHz)	Field Strength (μV/m)	Measurement Distance (m)
0.009 - 0.490	2400/F(kHz)	300
0.490 - 1.705	24000/F(kHz)	30
1.705 - 30.0	30	30
30 - 88	100	3
88 - 216	150	3
216 - 960	200	3
Above 960	500	3

Note:

For Above 1000MHz, the emission limit in this paragraph is based on measurement instrumentation employing an average detector, measurement using instrumentation with a peak detector function, corresponding to 20dB above the maximum permitted average limit.

In addition, radiated emissions which fall in the restricted bands, as defined in Section 15.205(a), also should comply with the radiated emission limits specified in Section 15.209(a)(above table)

2.9.2 Test Description

A. Test Setup:

- 1) For radiated emissions from 9kHz to 30MHz

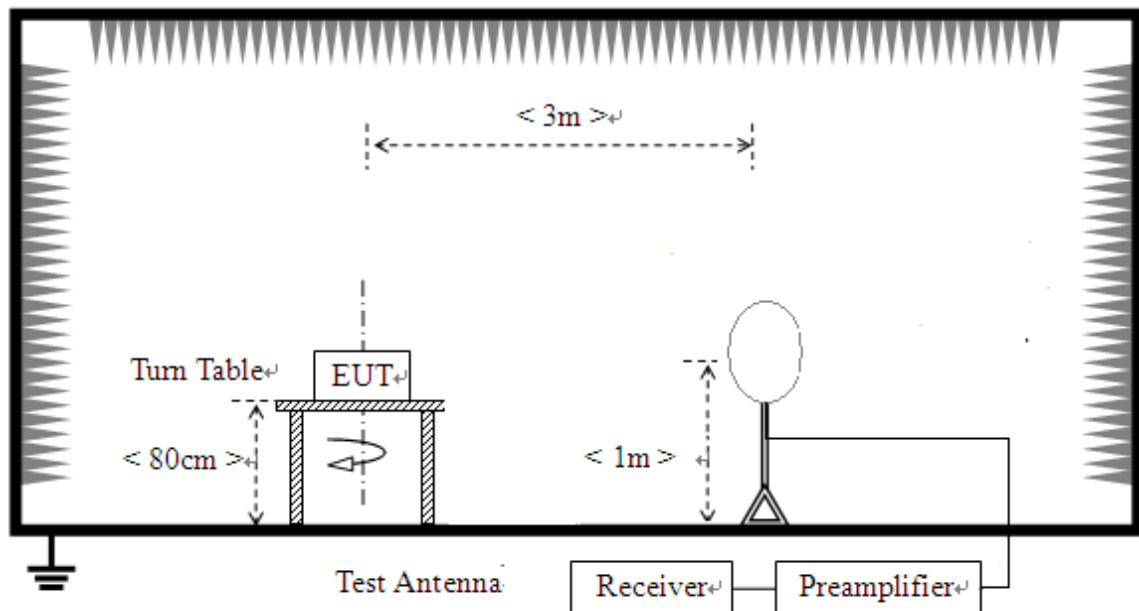

2) For radiated emissions from 30MHz to1GHz

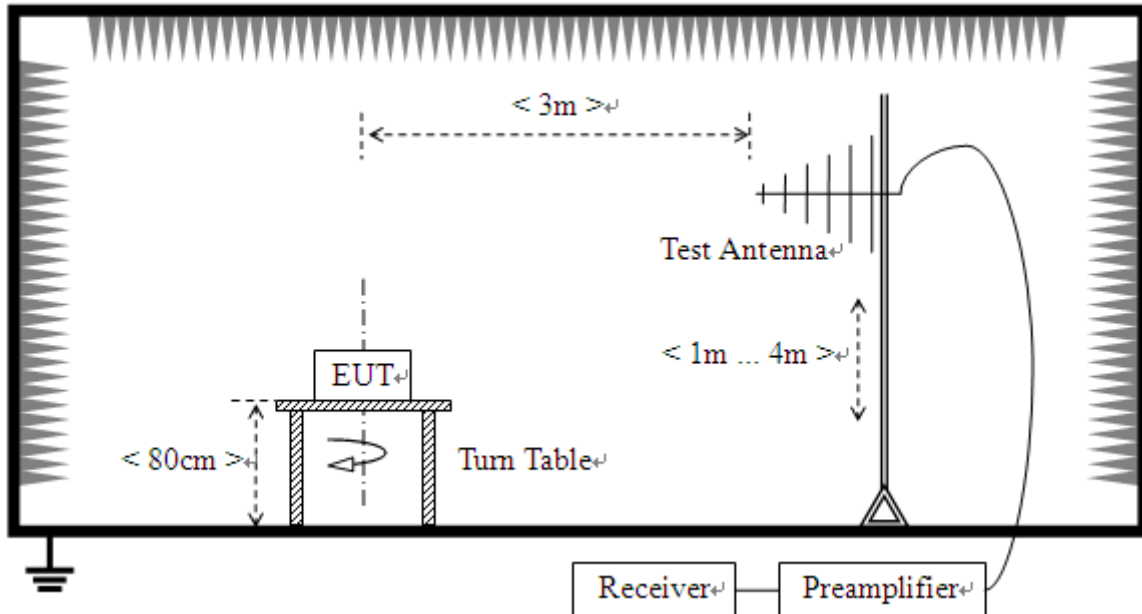

3) For radiated emissions above 1GHz

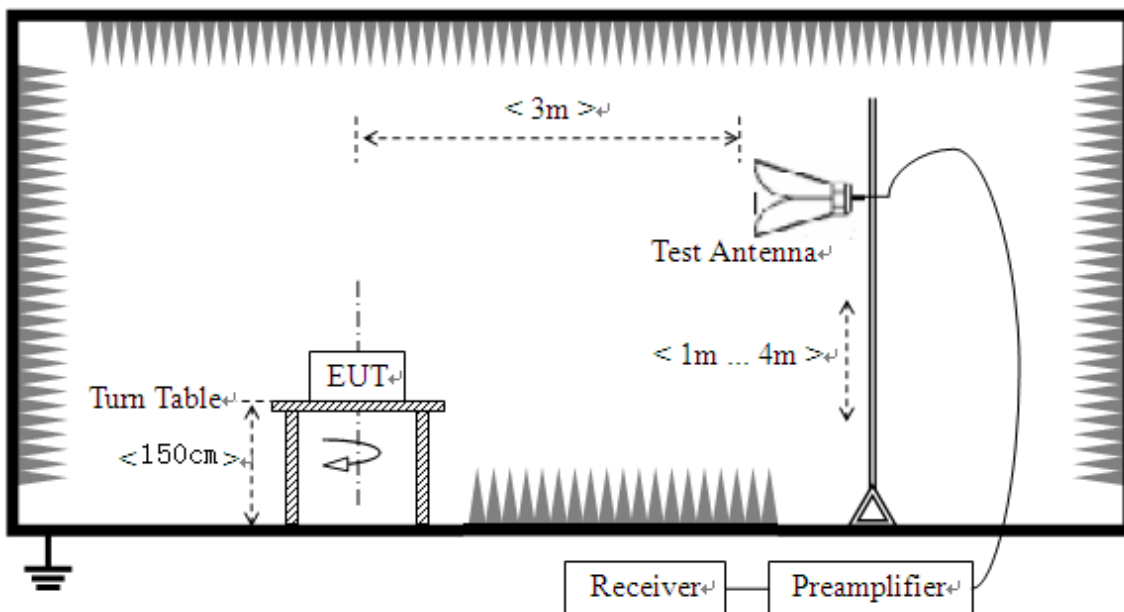

The RF absorbing material used on the reference ground plane and on the turntable have a maximum height (thickness) of 30 cm (12 in) and have a minimum-rated attenuation of 20 dB at all frequencies from 1 GHz to 18 GHz. Test site have a minimum area of the ground plane covered with RF absorbing material as specified in Figure 6 of ANSI C63.4: 2014.

The test site semi-anechoic chamber has met the requirement of NSA tolerance 4dB according to



the standards: ANSI C63.10 (2013). For radiated emissions below or equal to 1GHz, The EUT was set-up on insulator 80cm above the Ground Plane, For radiated emissions above 1GHz, The EUT was set-up on insulator 150cm above the Ground Plane. The set-up and test methods were according to ANSI C63.10

For the radiated emission test above 1GHz:

Place the measurement antenna away from each area of the EUT determined to be a source of emissions at the specified measurement distance, while keeping the measurement antenna aimed at the source of emissions at each frequency of significant emissions, with polarization oriented for maximum response. The measurement antenna may have to be higher or lower than the EUT, depending on the radiation pattern of the emission and staying aimed at the emission source for receiving the maximum signal. The final measurement antenna elevation shall be that which maximizes the emissions. The measurement antenna elevation for maximum emissions shall be restricted to a range of heights of from 1 m to 4 m above the ground or reference ground plane.

The EUT is located in a 3m Semi-Anechoic Chamber; the antenna factors, cable loss and so on of the site as factors are calculated to correct the reading

For the Test Antenna:

(a) In the frequency range of 9kHz to 30MHz, magnetic field is measured with Loop Test Antenna. The Test Antenna is positioned with its plane vertical at 1m distance from the EUT. The center of the Loop Test Antenna is 1m above the ground. During the measurement the Loop Test Antenna rotates about its vertical axis for maximum response at each azimuth about the EUT.

(b) In the frequency range above 30MHz, Bi-Log Test Antenna (30MHz to 1GHz) and Horn Test Antenna (above 1GHz) are used. Place the test antenna at 3m away from area of the EUT, while keeping the test antenna aimed at the source of emissions at each frequency of significant emissions, with polarization oriented for maximum response. The test antenna may have to be higher or lower than the EUT, depending on the radiation pattern of the emission and staying aimed at the emission source for receiving the maximum signal. The final test antenna elevation shall be that which maximizes the emissions. The test antenna elevation for maximum emissions shall be restricted to a range of heights of from 1 m to 4 m above the ground or reference ground plane. The emission levels at both horizontal and vertical polarizations should be tested.



2.9.3 Test Result

According to ANSI C63.4 selection 4.2.2, because of peak detection will yield amplitudes equal to or greater than amplitudes measured with the quasi-peak (or average) detector, the measurement data from a spectrum analyzer peak detector will represent the worst-case results, if the peak measured value complies with the quasi-peak limit, it is unnecessary to perform an quasi-peak measurement.

The measurement results are obtained as below:

$$E [\text{dB}\mu\text{V}/\text{m}] = U_R + A_T + A_{\text{Factor}} [\text{dB}]; A_T = L_{\text{Cable loss}} [\text{dB}] - G_{\text{preamp}} [\text{dB}]$$

A_T : Total correction Factor except Antenna

U_R : Receiver Reading

G_{preamp} : Preamplifier Gain

A_{Factor} : Antenna Factor at 3m

During the test, the total correction Factor A_T and A_{Factor} were built in test software.

Note1: All radiated emission tests were performed in X, Y, Z axis direction. And only the worst axis test condition was recorded in this test report.

Note2: The low frequency, which started from 9KHz to 30MHz, was pre-scanned and the result which was 20dB lower than the limit line per 15.31(o) was not reported.

For the frequency, which started from 25G to 40G, was pre-scanned and the result which was 10dB lower than the limit.



2.9.3.1 802.11a-20MHz Test mode

A. Test Plots for the Whole Measurement Frequency Range:

Plots for Channel = 36

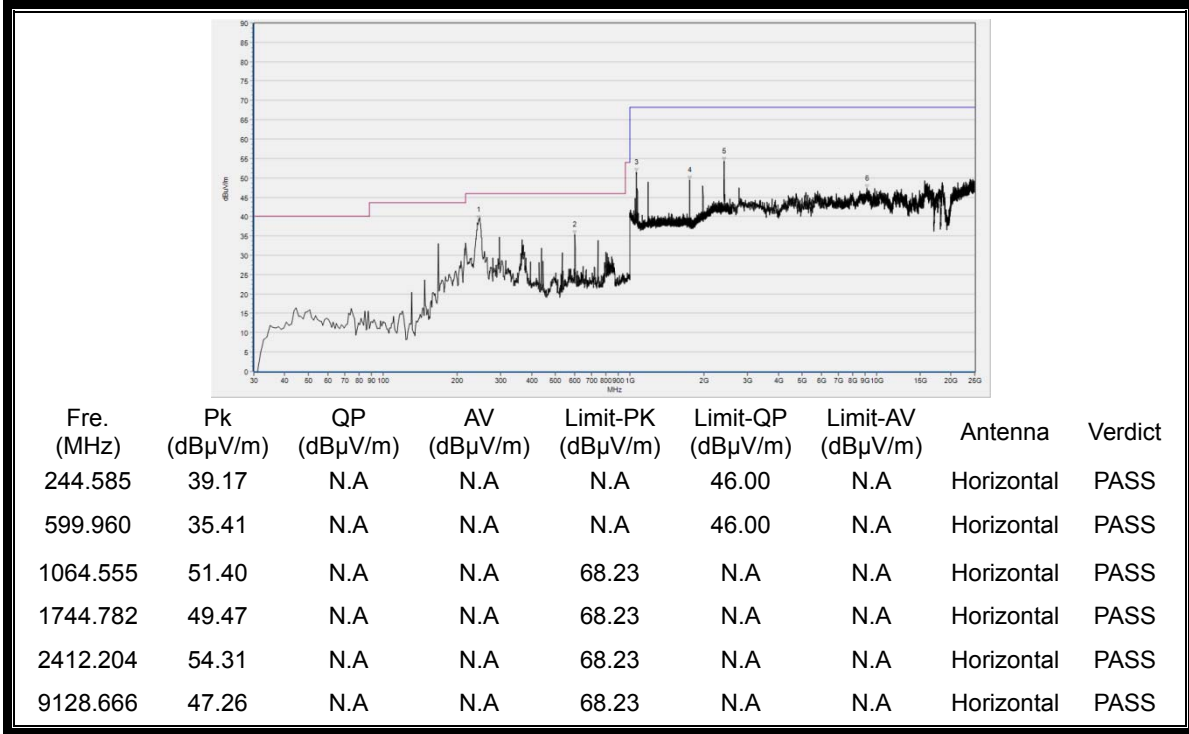

(Antenna Horizontal, 30MHz to 25GHz)

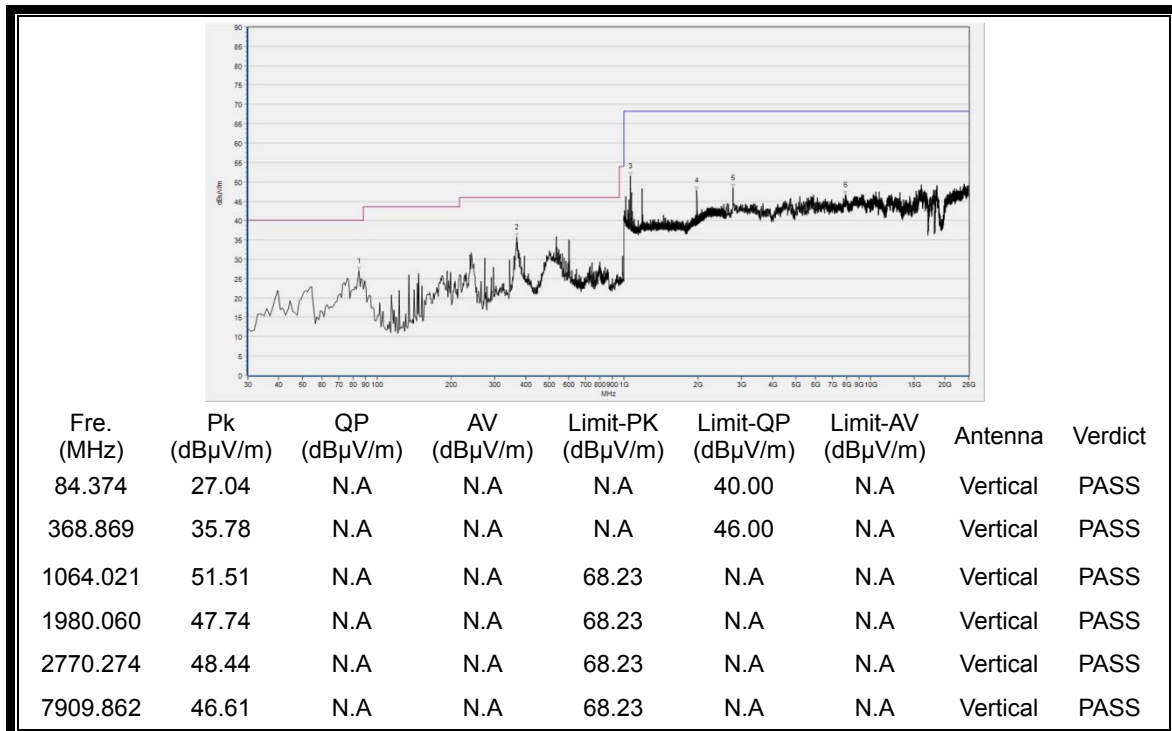

(Antenna Vertical, 30MHz to 25GHz)



Plot for Channel = 48

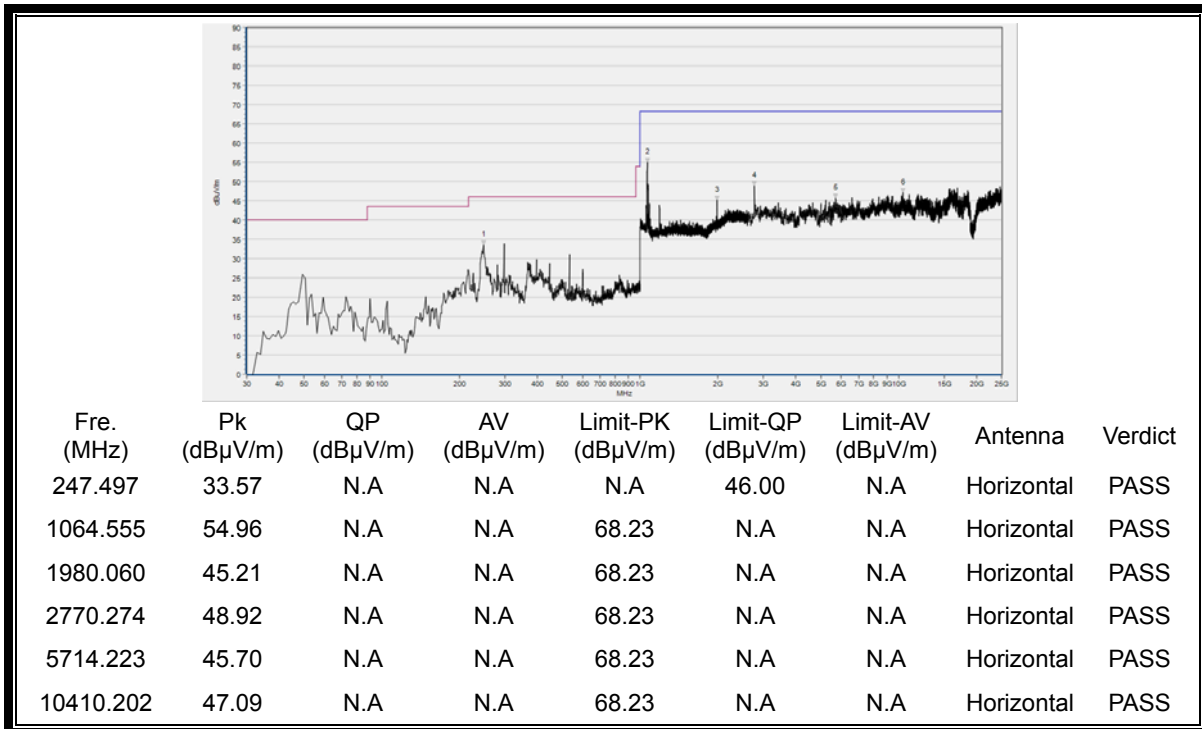

(Antenna Horizontal, 30MHz to 25GHz)

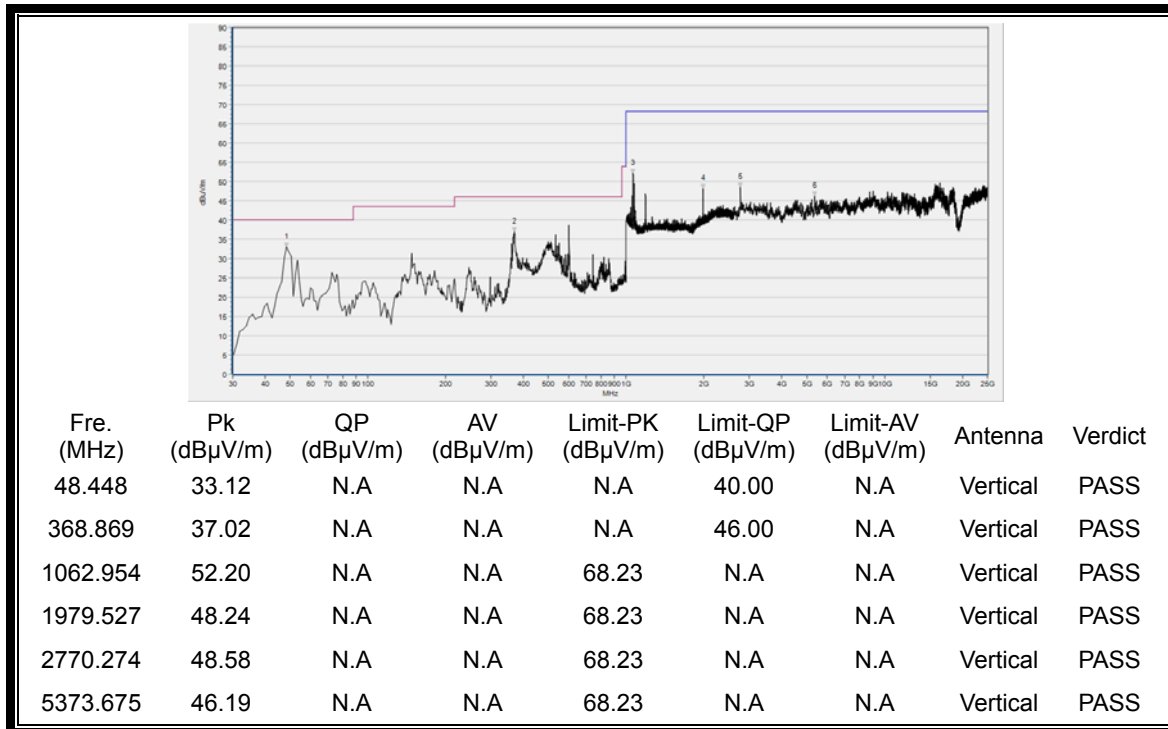

(Antenna Vertical, 30MHz to 25GHz)



Plots for Channel = 149

Channel	Frequency (MHz)	Antenna	Receiver	A _T (dB)	A _{Factor} (dB@3m)	Max. Emission E (dBμV/m)	Limit (dBμV/m)	Verdict
		Horiz./ Vert.	Reading U _R (dBuV)					
149	5722.89	Horizontal	58.57	-50.65	32.11	40.03	78.2	Pass
149	5724.35	Vertical	38.58	-50.65	32.11	20.04	78.2	Pass

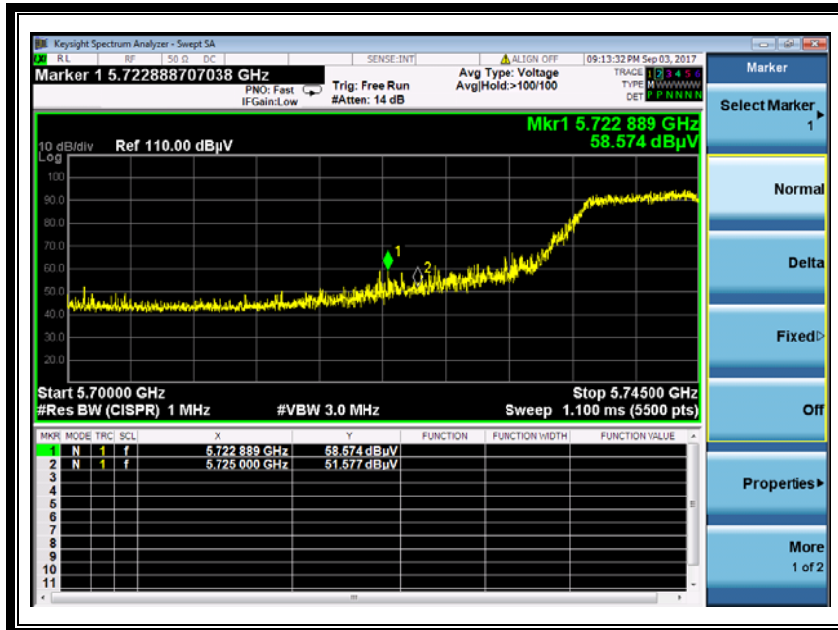

(Channel = 149 Horizontal @ 802.11a)

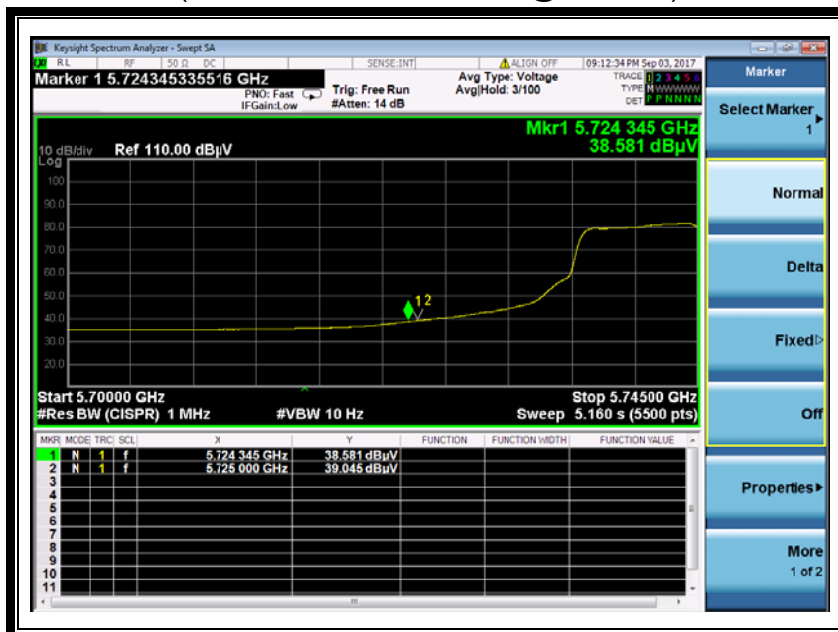

(Channel = 149 Vertical @ 802.11a)

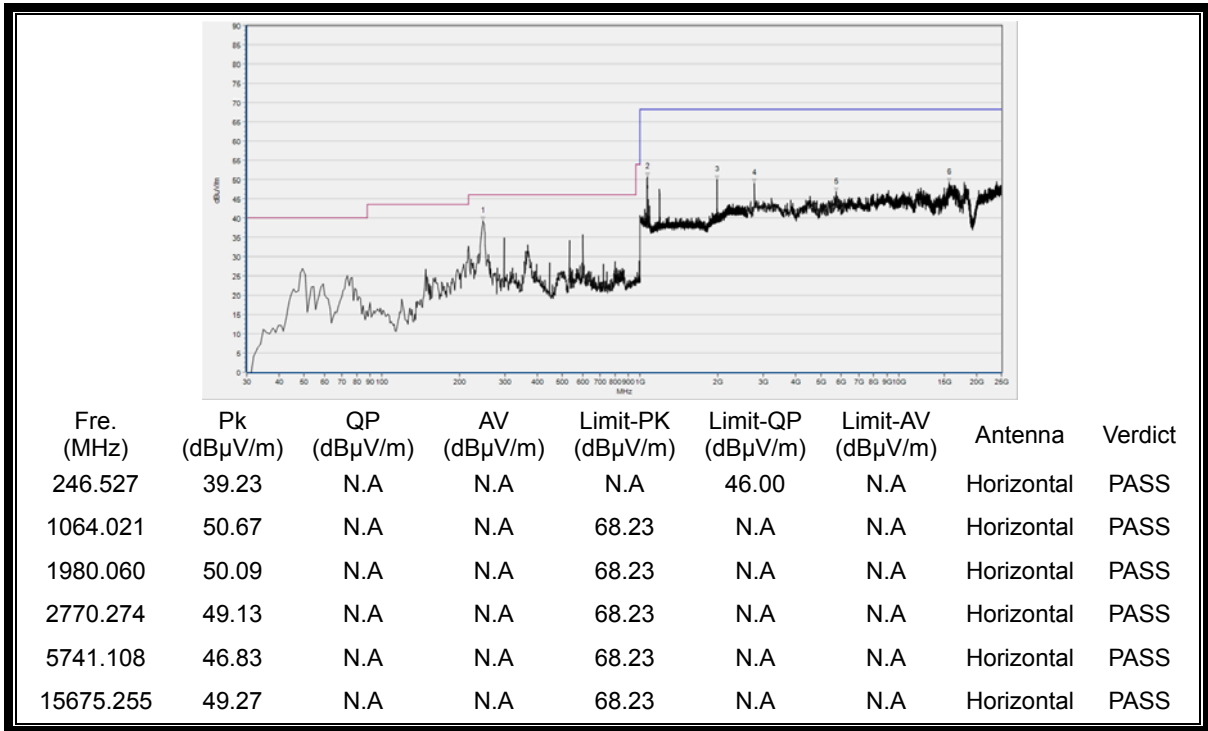

(Antenna Horizontal, 30MHz to 25GHz)

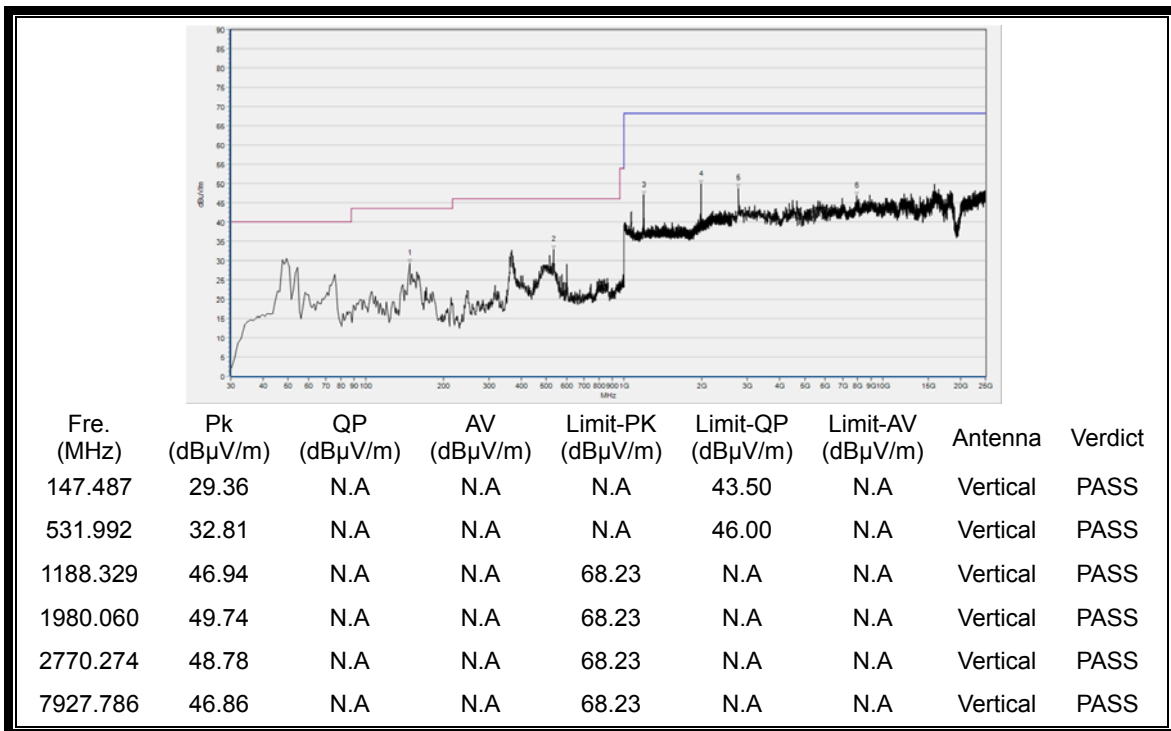

(Antenna Vertical, 30MHz to 25GHz)



Plot for Channel = 165

Channel	Frequency (MHz)	Antenna	Receiver Reading	A _T (dB)	A _{Factor} (dB@3m)	Max. Emission E (dBμV/m)	Limit (dBμV/m)	Verdict
		Horiz./ Vert.	U _R (dBuV)					
165	5869.71	Horizontal	54.73	-50.65	32.11	36.19	78.2	Pass
165	5861.73	Vertical	34.92	-50.65	32.11	16.38	78.2	Pass

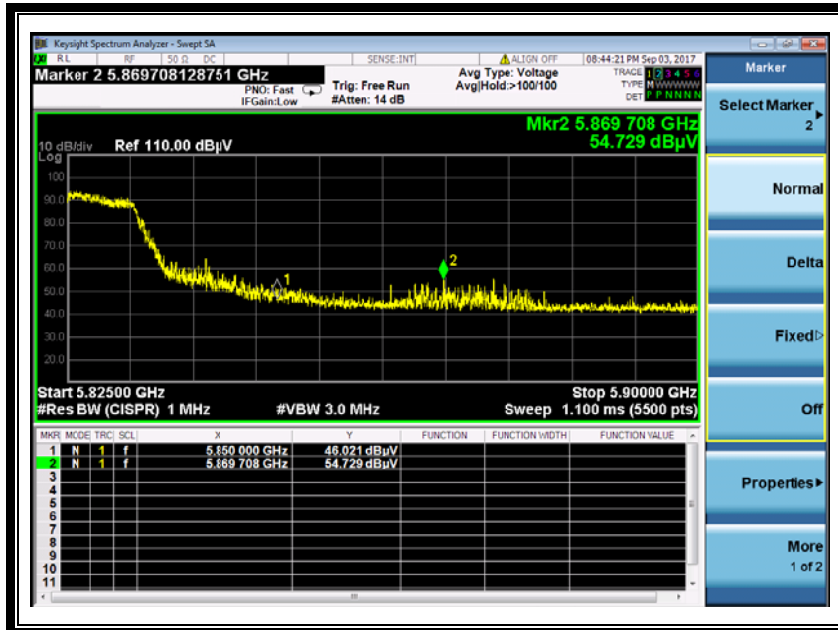

(Channel = 165 Horizontal @ 802.11a)

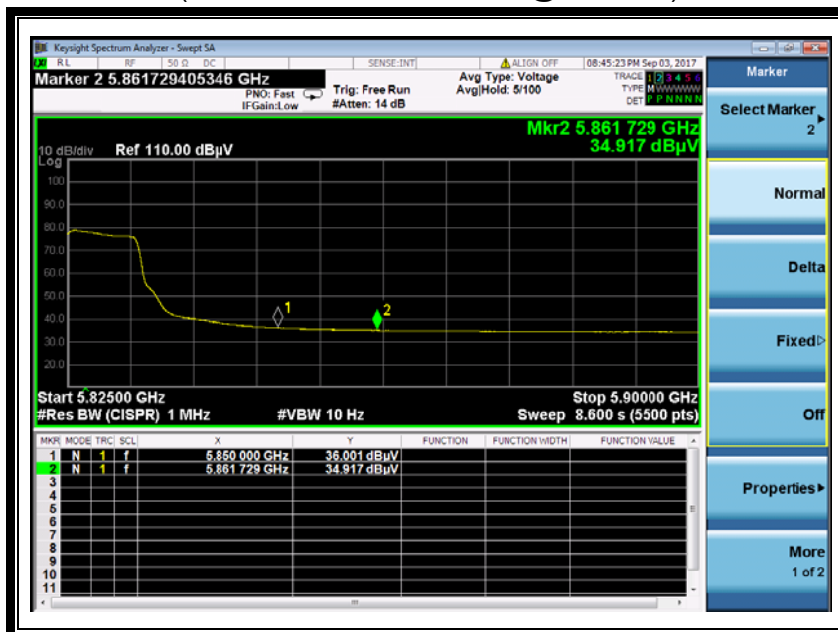

(Channel = 165 Vertical @ 802.11a)

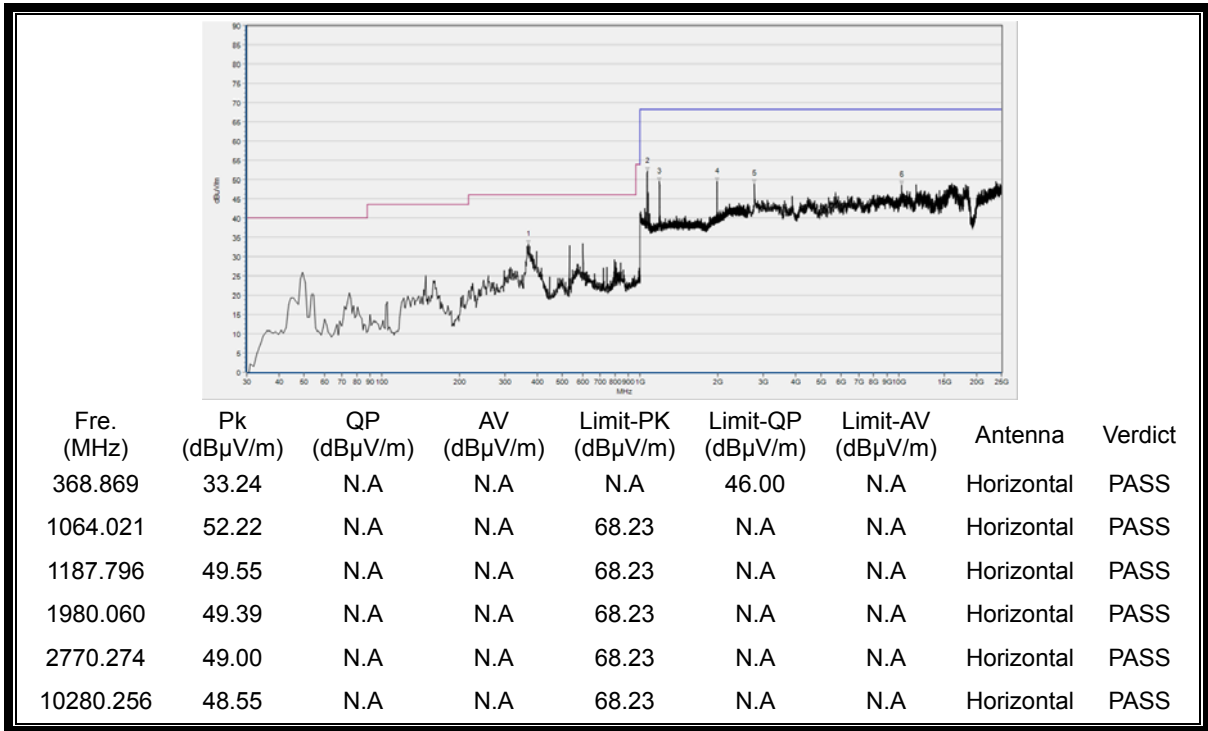

(Antenna Horizontal, 30MHz to 25GHz)

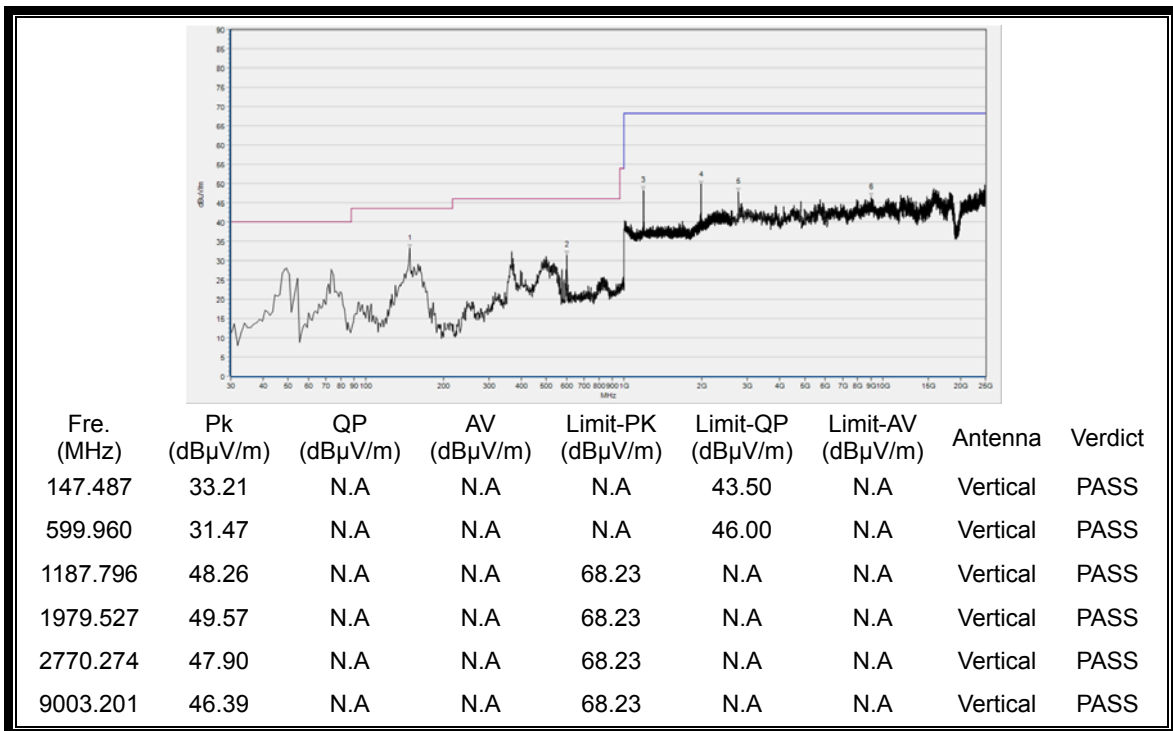

(Antenna Vertical, 30MHz to 25GHz)



2.9.3.2 802.11n-20MHz Test mode

A. Test Plots for the Whole Measurement Frequency Range:

Plots for Channel = 36

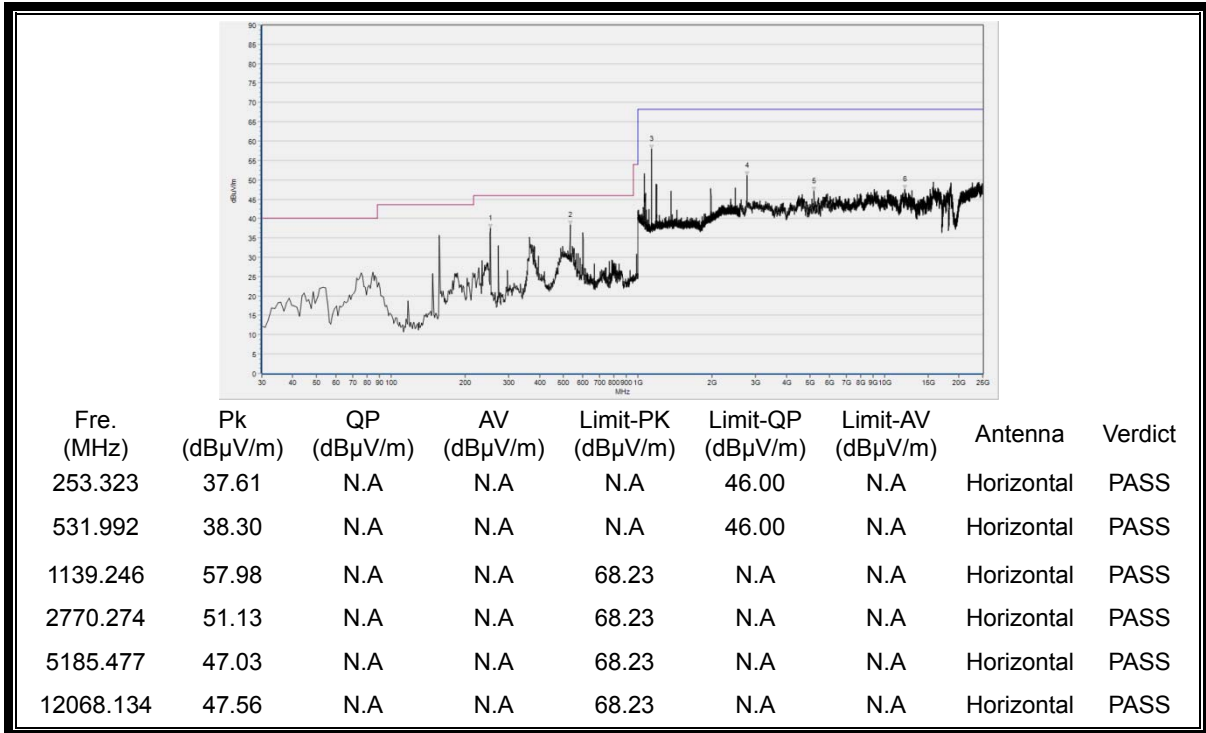

(Antenna Horizontal, 30MHz to 25GHz)

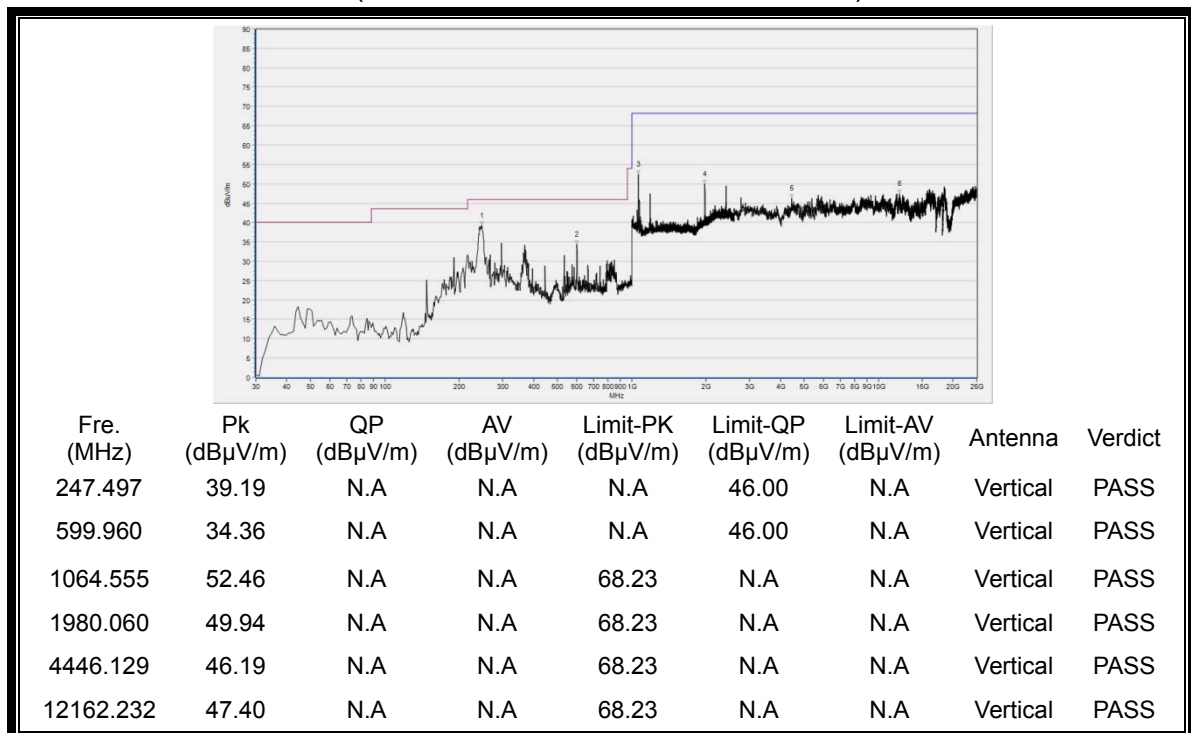

(Antenna Vertical, 30MHz to 25GHz)



Plot for Channel = 48

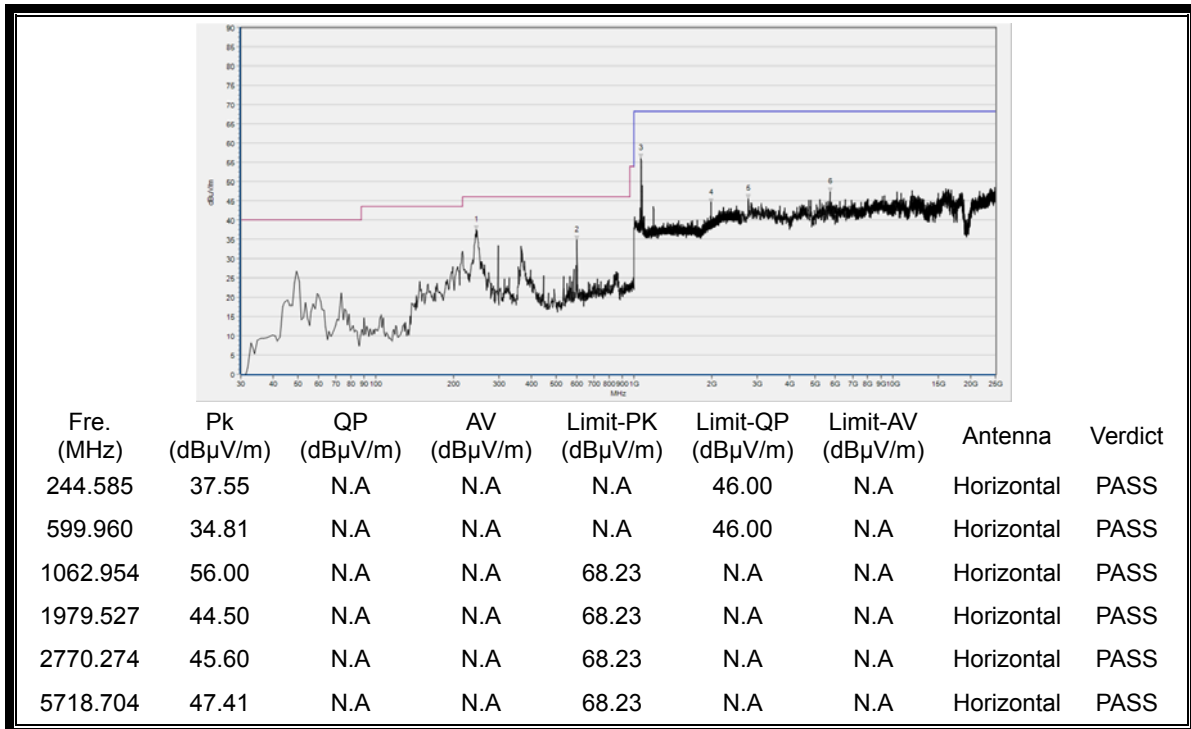

(Antenna Horizontal, 30MHz to 25GHz)

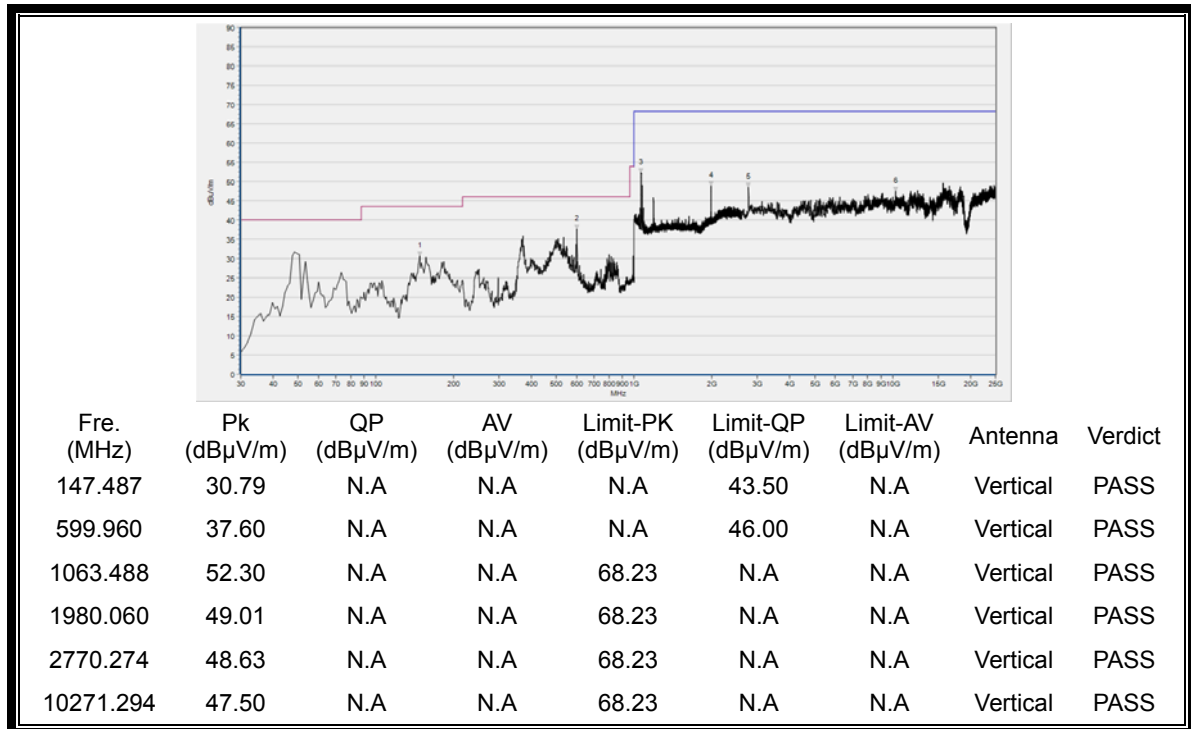

(Antenna Vertical, 30MHz to 25GHz)



Plots for Channel = 149

Channel	Frequency (MHz)	Antenna	Receiver Reading U _R (dBuV)	A _T (dB)	A _{Factor} (dB@3m)	Max. Emission E (dBμV/m)	Limit (dBμV/m)	Verdict
		Horiz./ Vert.						
149	5720.04	Horizontal	57.24	-50.65	32.11	38.70	78.2	Pass
149	5724.36	Vertical	38.61	-50.65	32.11	20.07	78.2	Pass

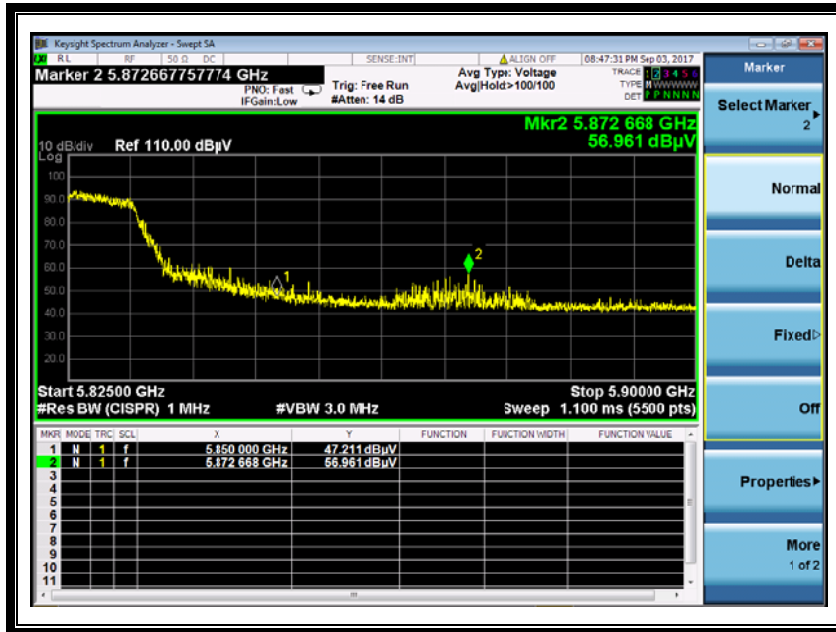

(Channel = 149 Horizontal @ 802.11n)

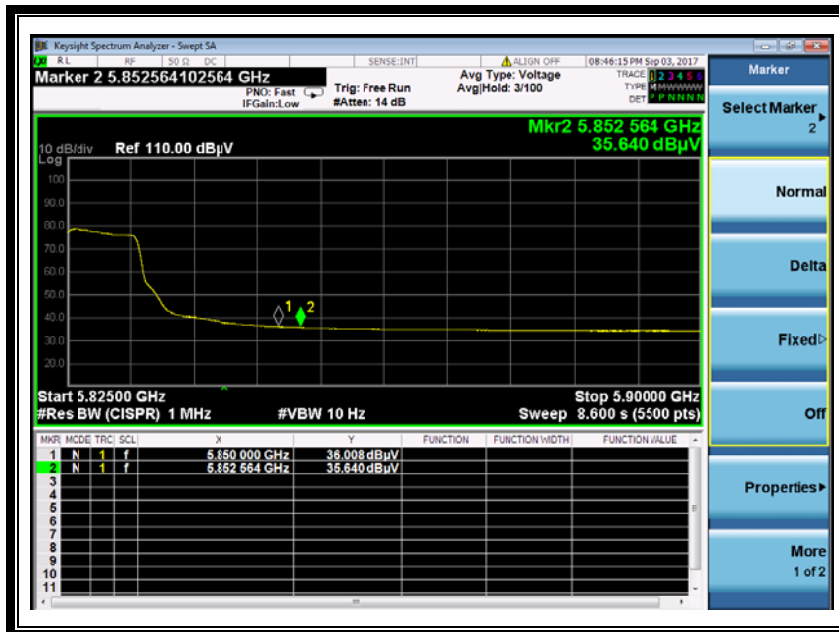

(Channel = 149 Vertical @ 802.11n)

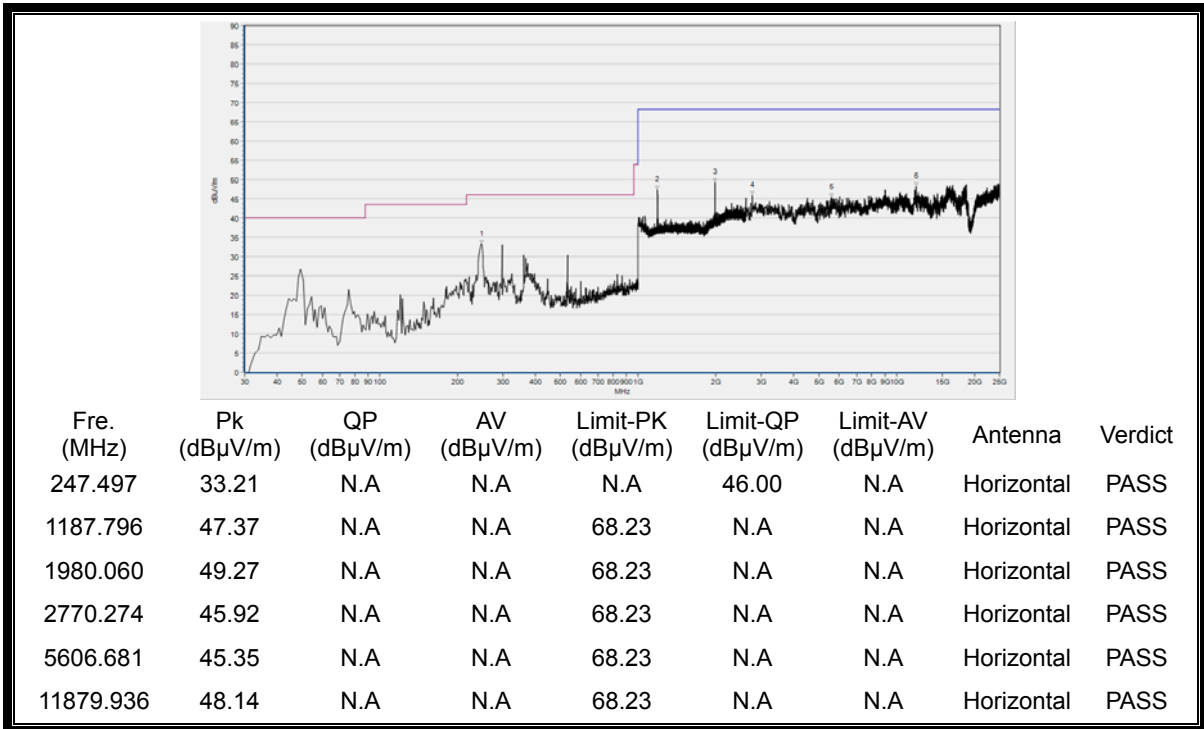

(Antenna Horizontal, 30MHz to 25GHz)

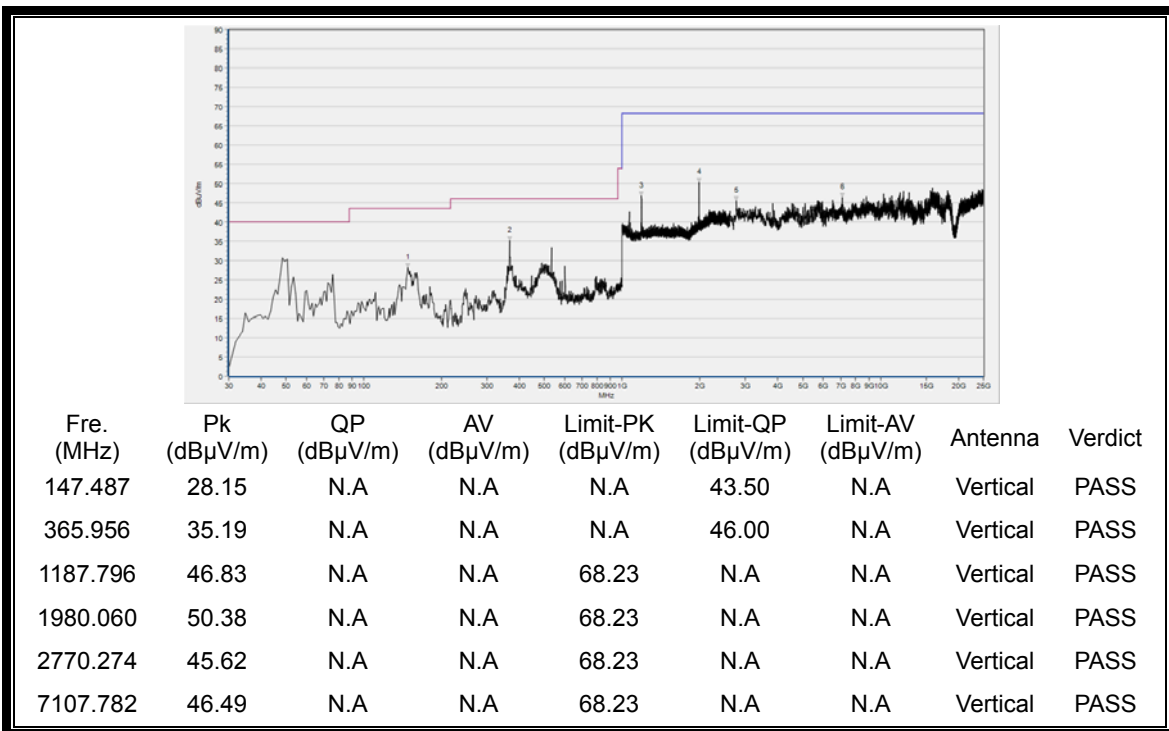

(Antenna Vertical, 30MHz to 25GHz)



Plot for Channel = 165

Channel	Frequency (MHz)	Antenna	Receiver	A _T (dB)	A _{Factor} (dB@3m)	Max. Emission E (dBμV/m)	Limit (dBμV/m)	Verdict
		Horiz./ Vert.	Reading U _R (dBuV)					
165	5872.67	Horizontal	56.96	-50.65	32.11	38.42	78.2	Pass
165	5852.56	Vertical	35.64	-50.65	32.11	17.10	78.2	Pass

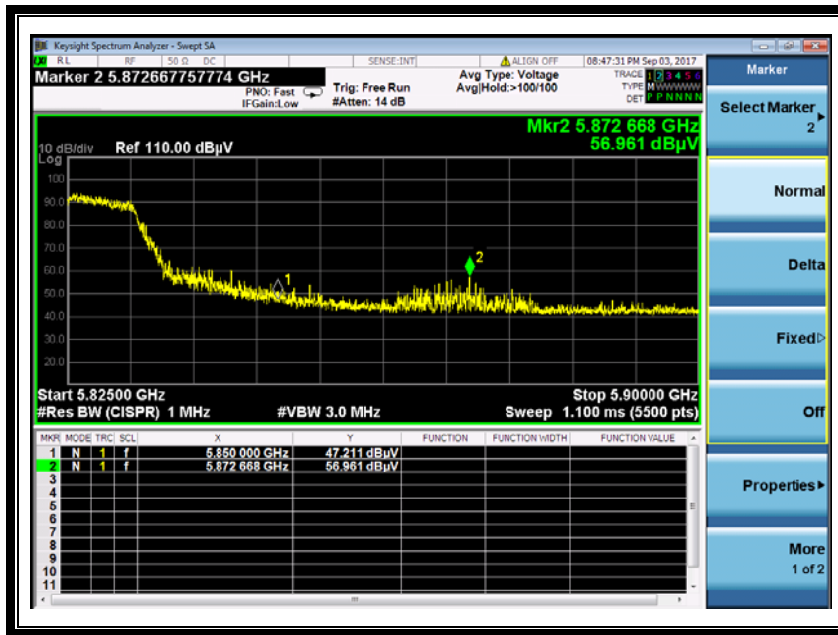

(Channel = 165 Horizontal @ 802.11n)

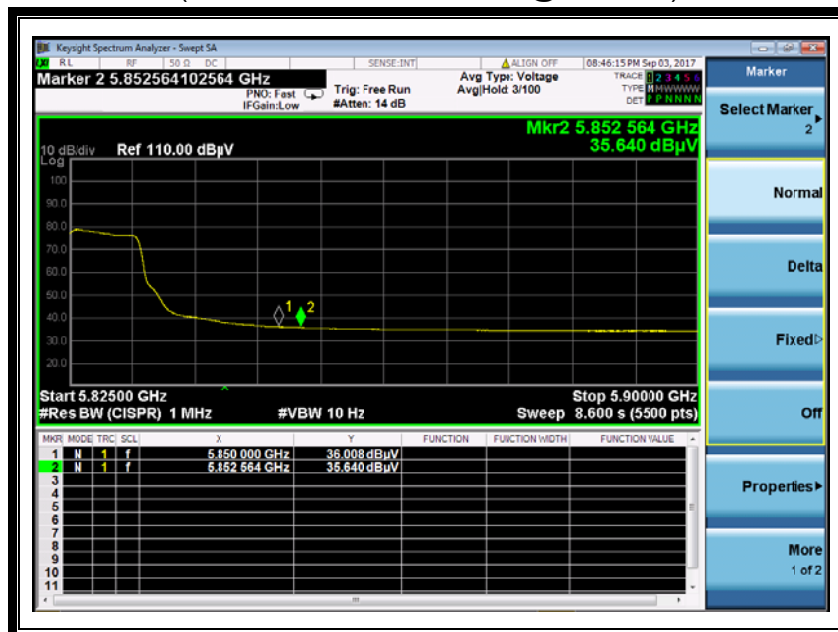

(Channel = 165 Vertical @ 802.11n)

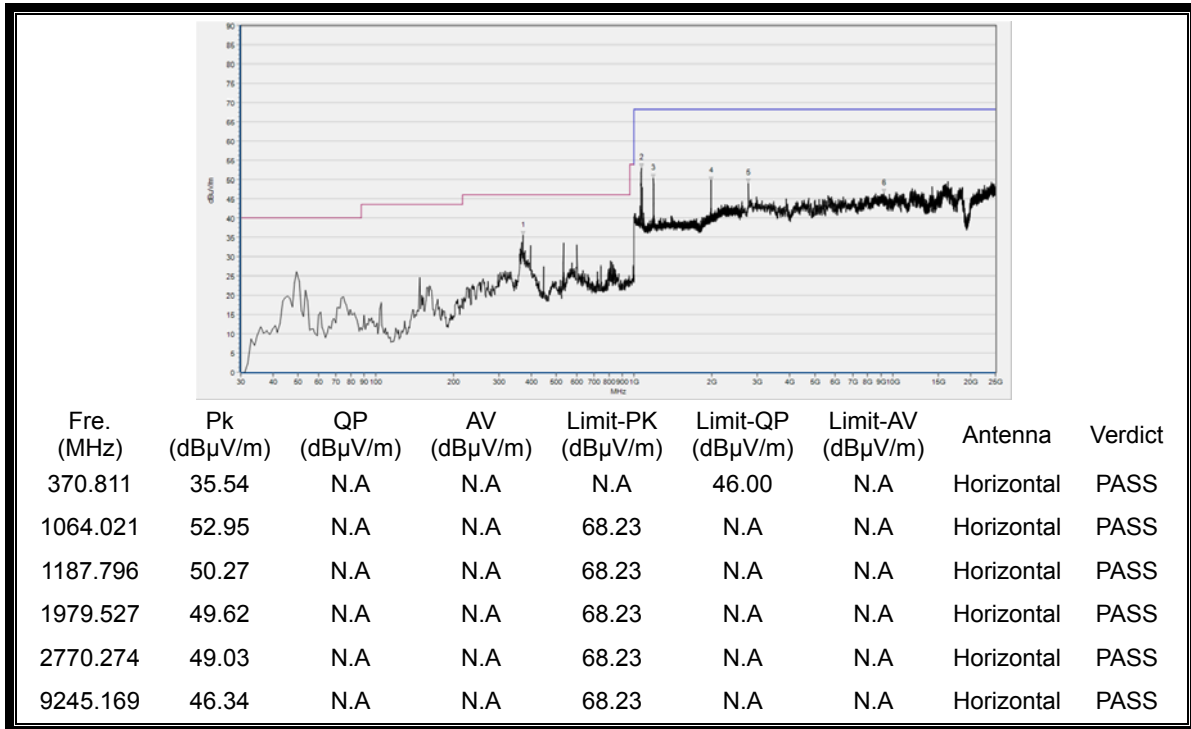

(Antenna Horizontal, 30MHz to 25GHz)

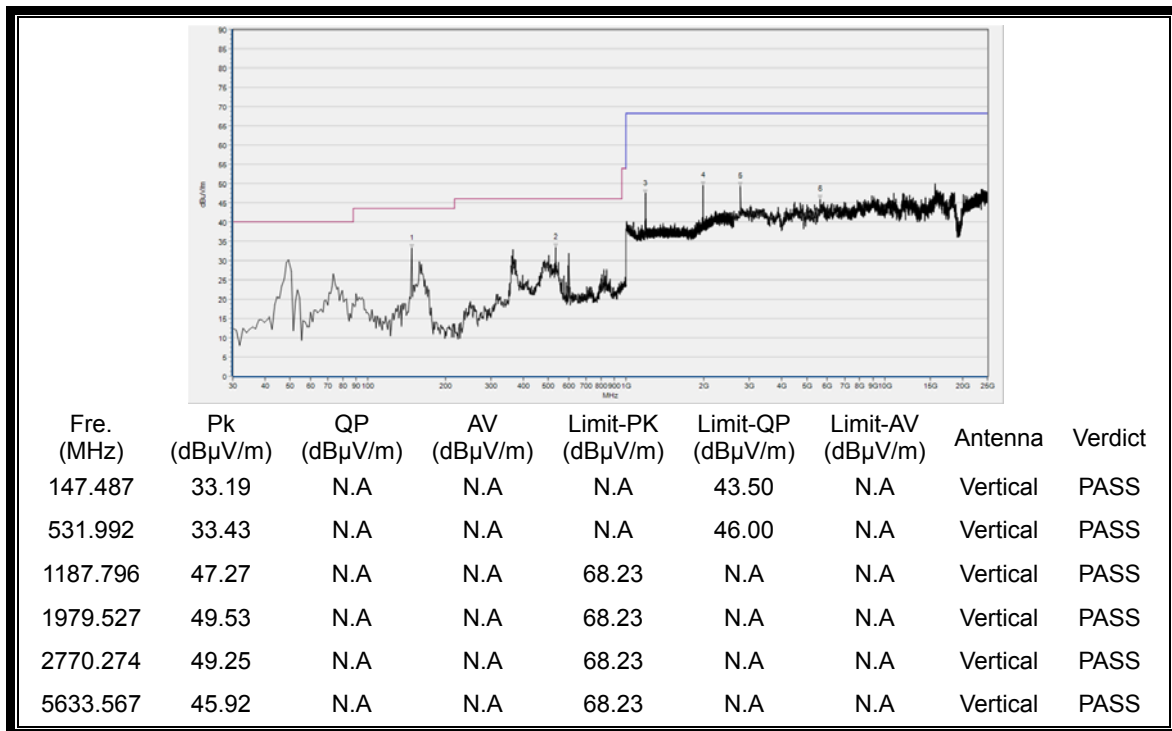

(Antenna Vertical, 30MHz to 25GHz)



2.9.3.3 802.11n-40MHz Test mode

A. Test Plots for the Whole Measurement Frequency Range:

Plots for Channel = 38

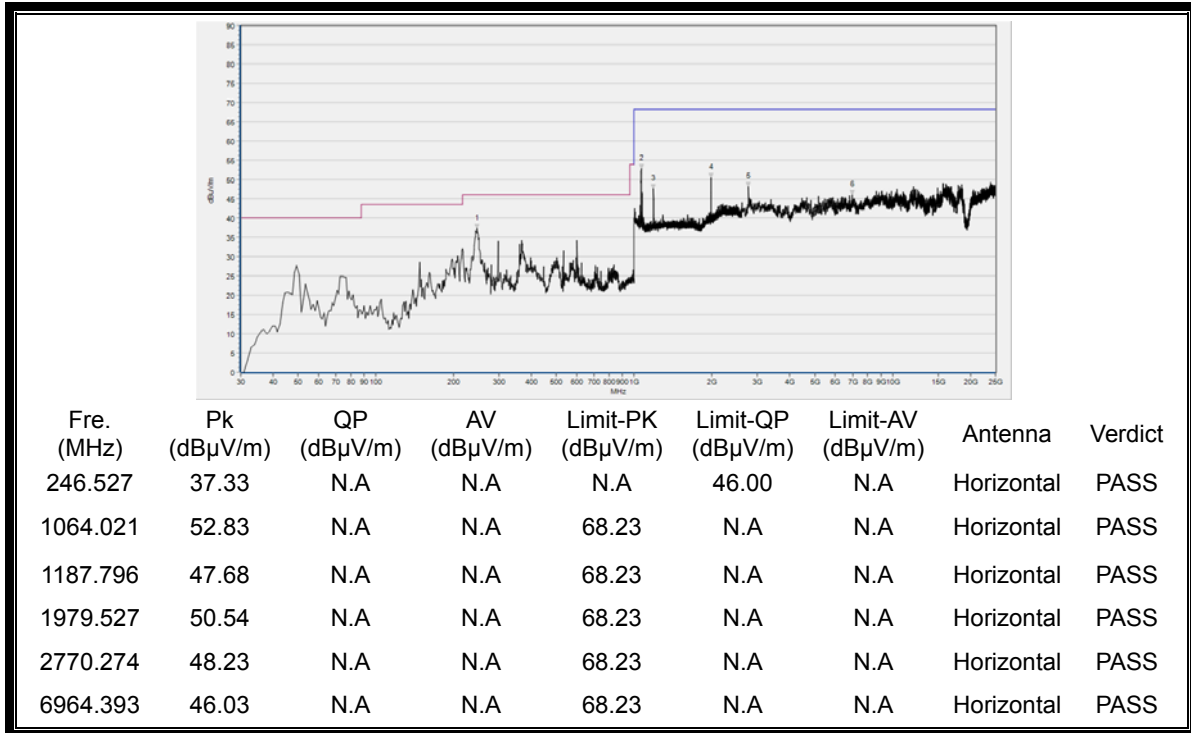

(Antenna Horizontal, 30MHz to 40GHz)

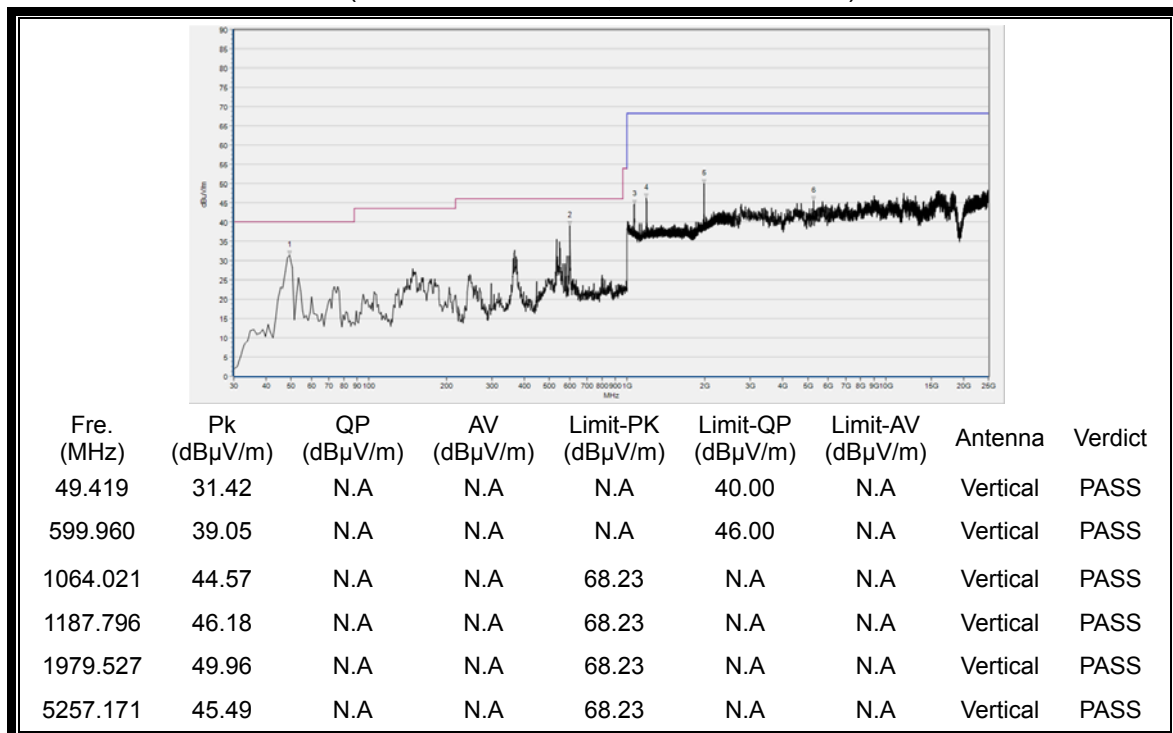

(Antenna Vertical, 30MHz to 40GHz)



Plot for Channel = 46

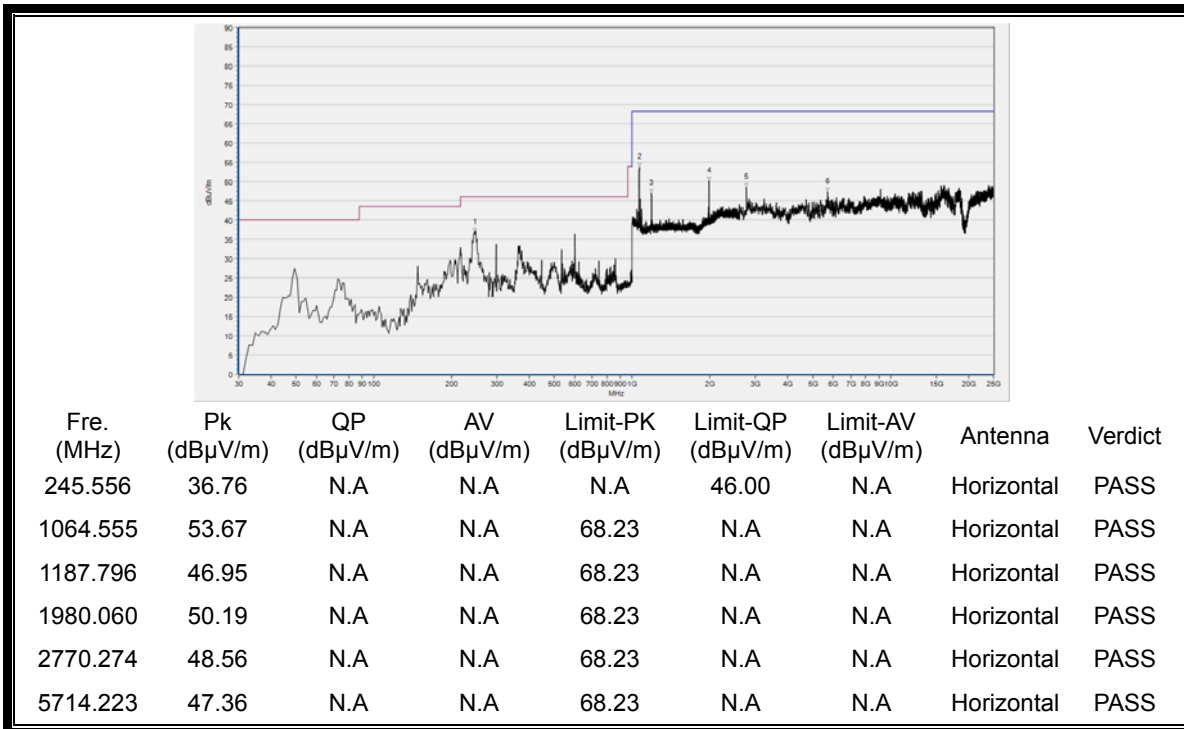

(Antenna Horizontal, 30MHz to 25GHz)

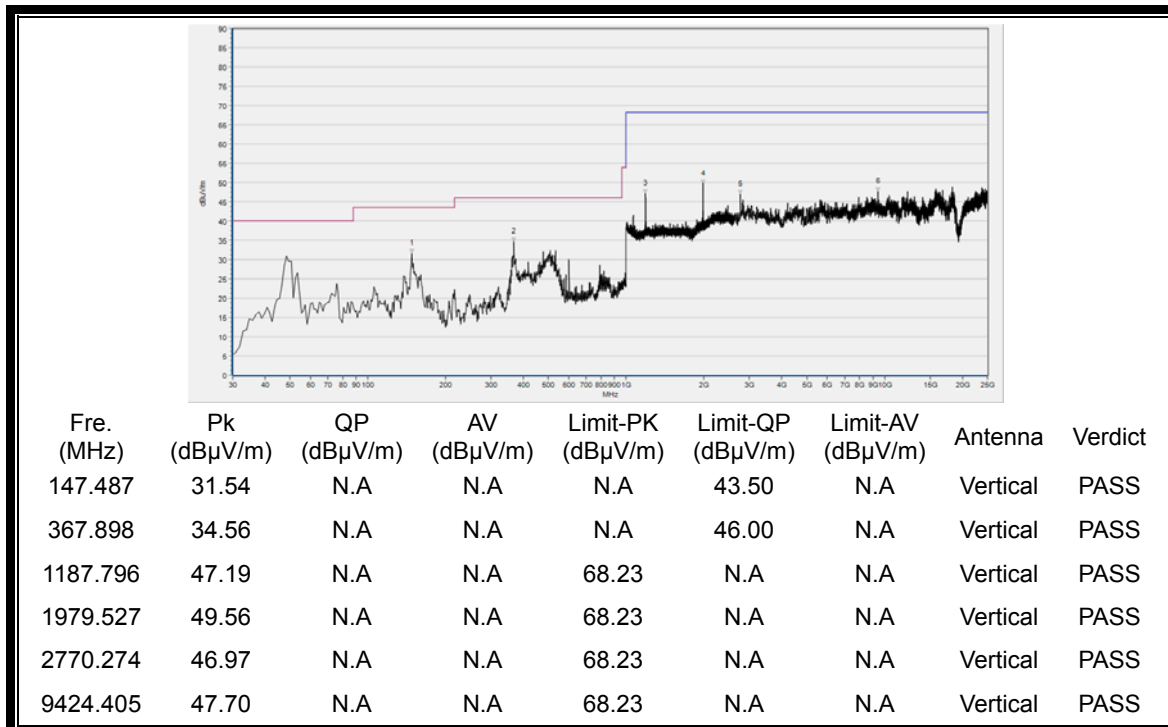

(Antenna Vertical, 30MHz to 40GHz)



Plot for Channel = 151

Channel	Frequency (MHz)	Antenna	Receiver Reading	A _T (dB)	A _{Factor} (dB@3m)	Max. Emission E (dBμV/m)	Limit (dBμV/m)	Verdict
		Horiz./ Vert.	U _R (dBuV)					
151	5723.74	Horizontal	68.08	-50.65	32.11	49.54	78.2	Pass
151	5723.97	Vertical	52.76	-50.65	32.11	34.22	78.2	Pass

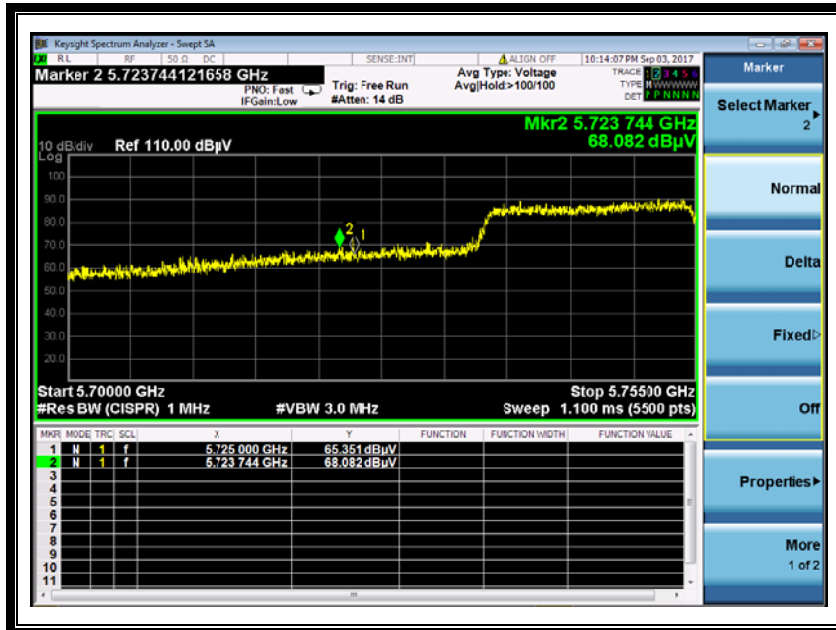

(Channel = 151 Horizontal @ 802.11n-40)

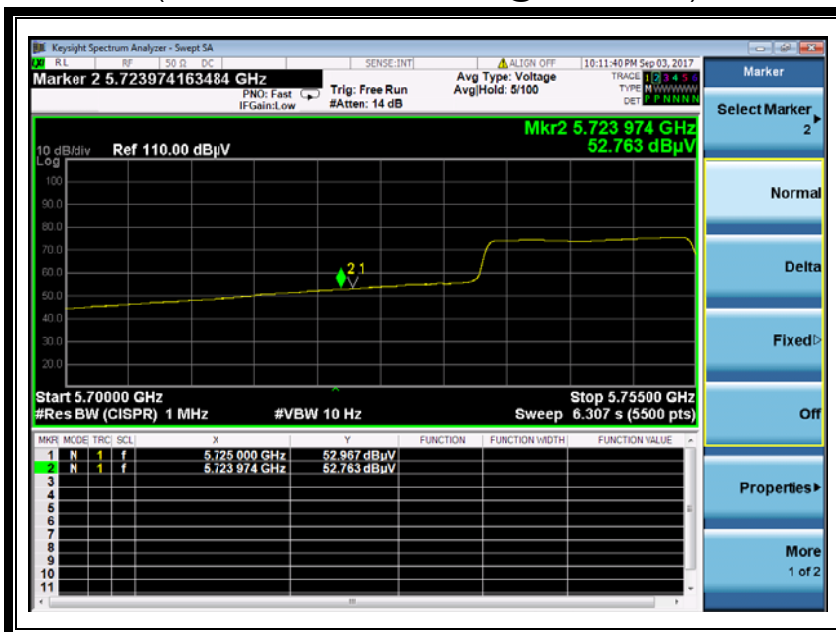

(Channel = 151 Vertical @ 802.11 n-40)

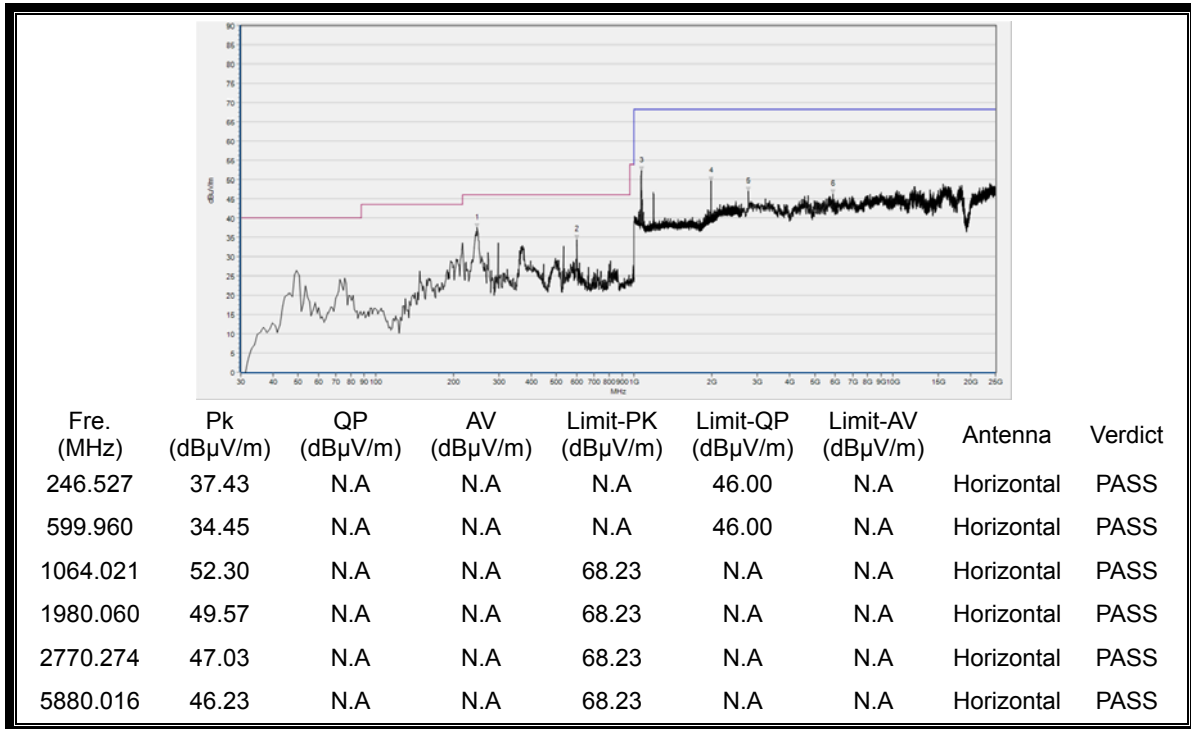

(Antenna Horizontal, 30MHz to 40GHz)

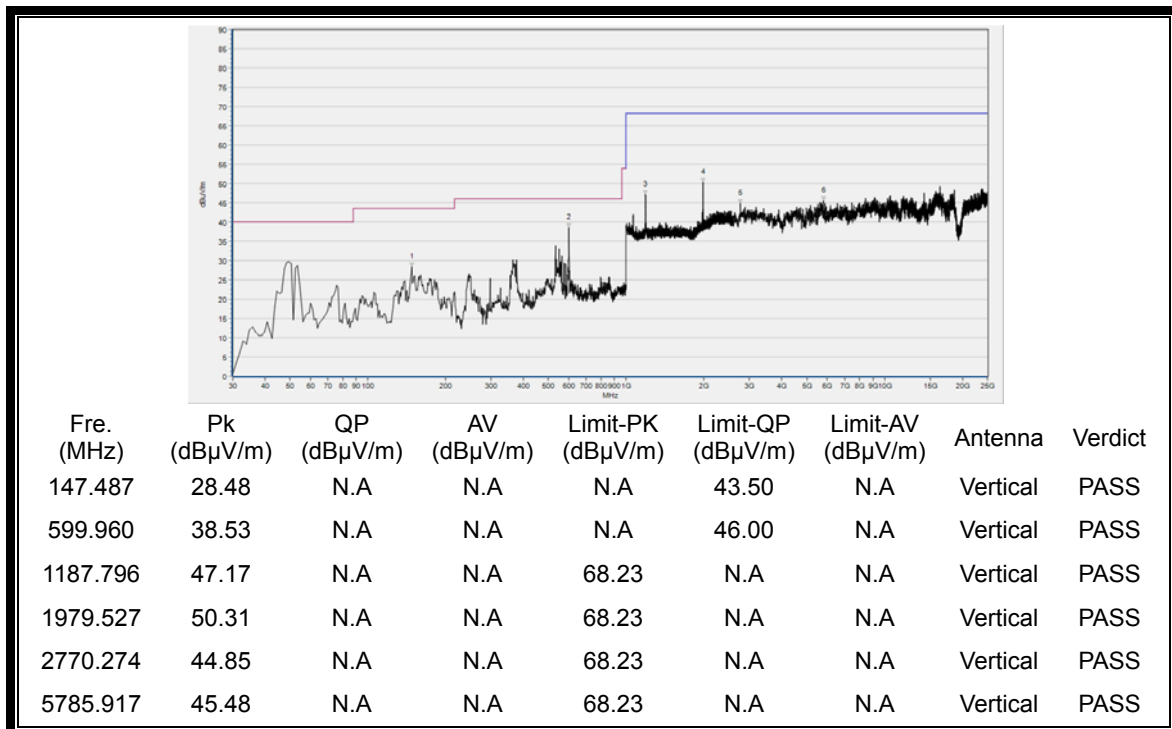

(Antenna Vertical, 30MHz to 40GHz)



Plots for Channel = 159

Channel	Frequency (MHz)	Antenna	Receiver Reading	A _T (dB)	A _{Factor} (dB@3m)	Max. Emission E (dBμV/m)	Limit (dBμV/m)	Verdict
		Horiz./ Vert.	U _R (dBuV)					
159	5853.94	Horizontal	53.77	-50.65	32.11	35.23	78.2	Pass
159	5851.25	Vertical	41.39	-50.65	32.11	22.85	78.2	Pass



(Channel = 151 Horizontal @ 802.11 n-40)

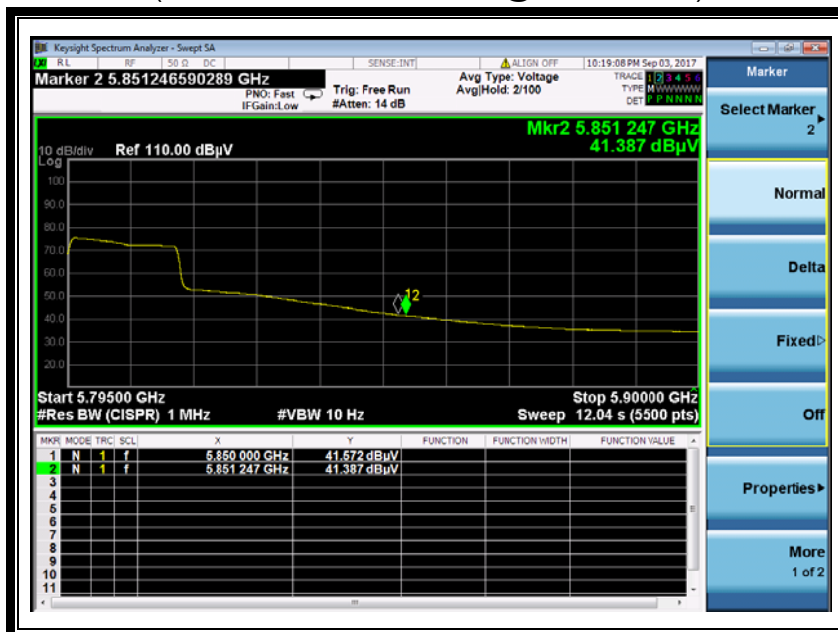

(Channel = 151 Vertical @ 802.11 n-40)

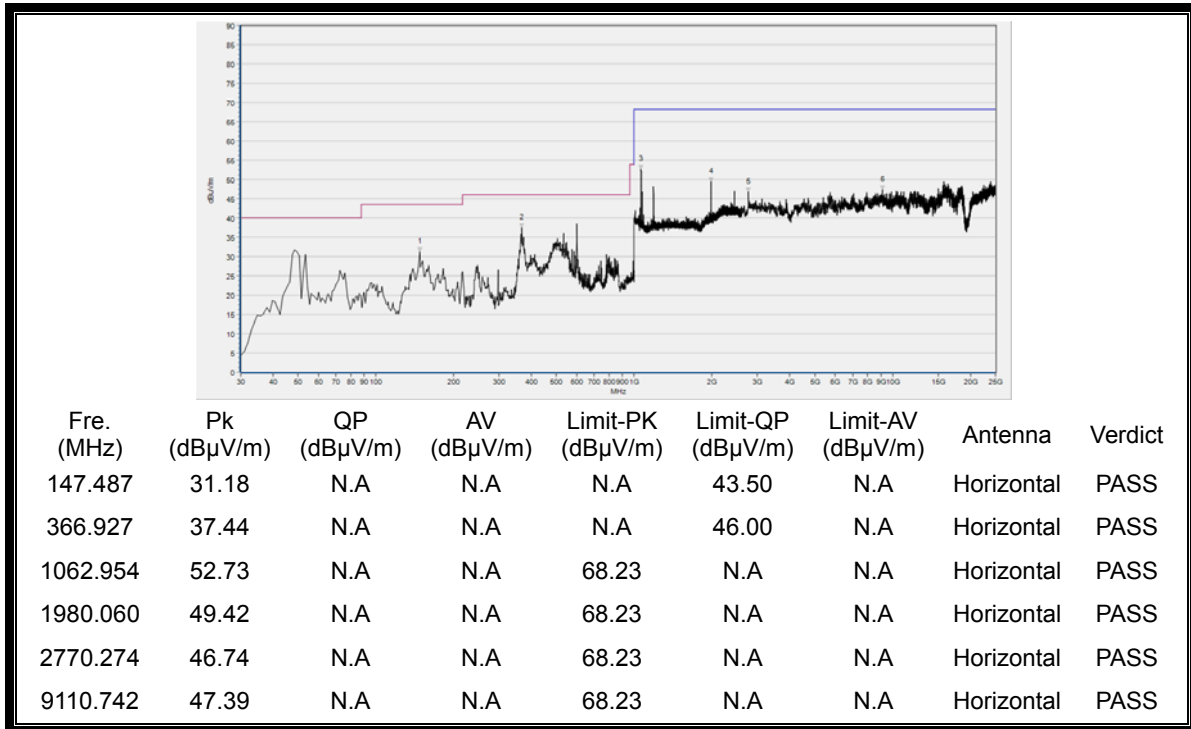

(Antenna Horizontal, 30MHz to 40GHz)

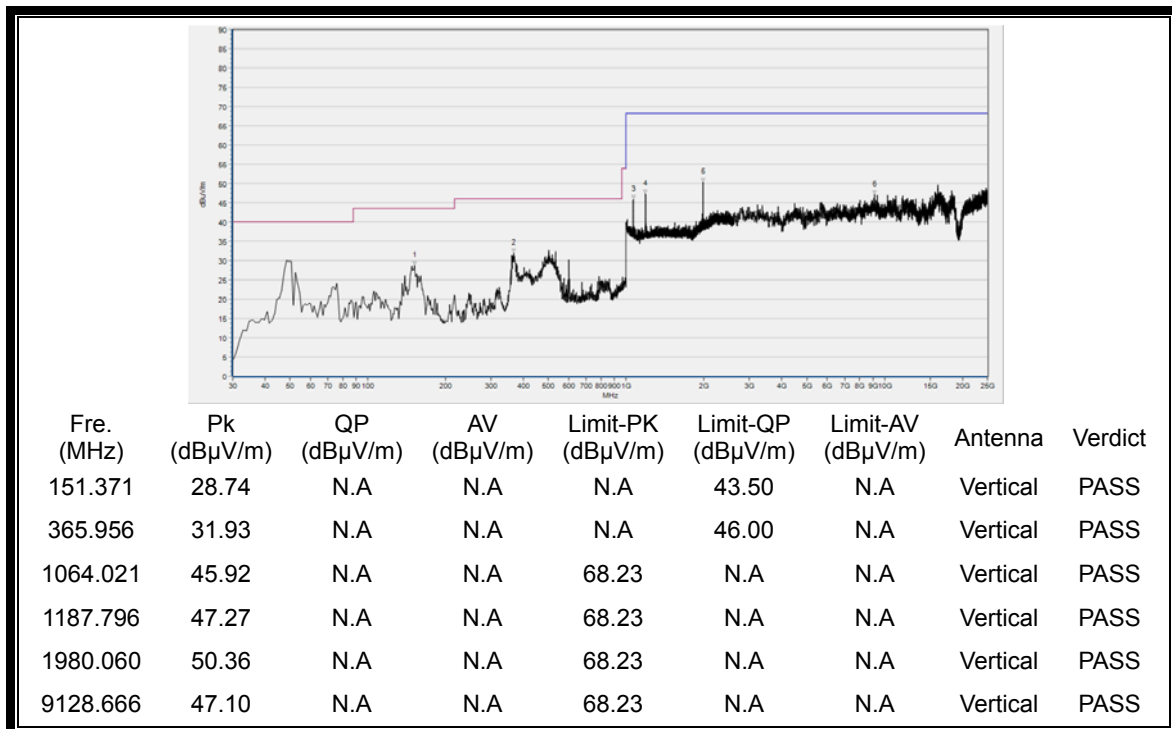

(Antenna Vertical, 30MHz to 40GHz)



2.10 RF exposure evaluation

2.10.1 Requirement

According to § 1.1307(b)(1), systems operating under the provisions of this section shall be operated in a manner that ensure that the public is not exposed to radio frequency energy level in excess of Commission's guideline.

2.10.2 Result

Please refer to RF exposure evaluation report.

2.11 Automatically discontinue transmission requirement

2.11.1 Requirement

According to 15.407(c), the device shall automatically discontinue transmission in case of either absence of information to transmit or operational failure. These provisions are not intended to preclude the transmission of control or signalling information or the use of repetitive codes used by certain digital technologies to complete frame or burst intervals. Applicants shall include in their application for equipment authorization a description of how this requirement is met

2.11.2 Result

The EUT will automatically discontinue transmission in case of either absence of information to transmit or operational failure.



ANNEX A GENERAL INFORMATION

1.1 Identification of the Responsible Testing Laboratory

Company Name:	Shenzhen Morlab Communications Technology Co., Ltd.
Department:	Morlab Laboratory
Address:	FL.3, Building A, FeiYang Science Park, No.8 LongChang Road, Block 67, BaoAn District, ShenZhen, GuangDong Province, P. R. China
Responsible Test Lab Manager:	Mr. Su Feng
Telephone:	+86 755 36698555
Facsimile:	+86 755 36698525

1.2 Identification of the Responsible Testing Location

Name:	Shenzhen Morlab Communications Technology Co., Ltd. Morlab Laboratory
Address:	FL.3, Building A, FeiYang Science Park, No.8 LongChang Road, Block 67, BaoAn District, ShenZhen, GuangDong Province, P. R. China

1.3 Facilities and Accreditations

Shenzhen Morlab Communications Technology Co., Ltd. Morlab Laboratory is a testing organization accredited by China National Accreditation Service for Conformity Assessment (CNAS) according to ISO/IEC 17025. The accreditation certificate number is L3572.

All measurement facilities used to collect the measurement data are located at FL.3, Building A, FeiYang Science Park, Block 67, BaoAn District, Shenzhen, 518101 P. R. China. The test site is constructed in conformance with the requirements of ANSI C63.10-2013 and CISPR Publication 22; the FCC designation number is CN1192.

1.4 Maximum measurement uncertainty

Where relevant, the following measurement uncertainty levels have been estimated for test performed on the EUT as specified in CISPR 16-1-2:

Test items	Uncertainty
Peak Output Power	±2.22dB
Power spectral density (PSD)	±2.22dB
Bandwidth	±5%
Restricted Frequency Bands	±5%
Radiated Emission	±2.95dB
Conducted Emission	±2.44dB

This uncertainty represent an expanded uncertainty expressed at approximately the 95% confidence level using a coverage factor of k=2



1.5 Test Equipments Utilized

1.5.1 Conducted Test Equipments

Conducted Test Equipment

No.	Equipment Name	Serial No.	Type	Manufacturer	Cal. Date	Cal. Due
1	Spectrum Analyzer	MY45101810	E4407B	Agilent	2017.05.24	2018.05.23
2	Power Splitter	NW521	1506A	Weinschel	2017.05.24	2018.05.23
3	Attenuator 1	(N/A.)	10dB	Resnet	2017.05.24	2018.05.23
4	Attenuator 2	(N/A.)	3dB	Resnet	2017.05.24	2018.05.23
5	EXA Signal Analyzer	MY53470836	N9010A	Agilent	2016.12.07	2017.12.06
6	RF cable (30MHz-26GHz)	CB01	RF01	Morlab	N/A	N/A
7	Coaxial cable	CB02	RF02	Morlab	N/A	N/A
8	SMA connector	CN01	RF03	HUBER-SUHNER	N/A	N/A

1.5.2 Conducted Emission Test Equipments

Conducted Emission Test Equipments

No.	Equipment Name	Serial No.	Type	Manufacturer	Cal. Date	Cal. Due
1	Receiver	US44210471	E7405A	Agilent	2017.05.24	2018.05.23
2	LISN	812744	NSLK 8127	Schwarzbeck	2017.05.24	2018.05.23
3	Service Supplier	100448	CMU200	R&S	2017.05.24	2018.05.23
4	Pulse Limiter (20dB)	9391	VTSD 9561-D	Schwarzbeck	2017.05.24	2018.05.23
5	Coaxial cable(BNC) (30MHz-26GHz)	CB01	EMC01	Morlab	N/A	N/A

1.5.3 Auxiliary Test Equipment

Auxiliary Test Equipment

No.	Equipment Name	Model No.	Brand Name	Manufacturer	Cal.Date	Cal.Due Date
1	Computer	T430i	Think Pad	Lenovo	N/A	N/A

**1.5.4 Radiated Test Equipments**

Radiated Test Equipments						
No.	Equipment Name	Serial No.	Type	Manufacturer	Cal. Date	Cal.Due Date
1	System Simulator	GB45360846	8960-E5515C	Agilent	2017.05.17	2018.05.16
2	Receiver	MY54130016	N9038A	Agilent	2017.05.17	2018.05.16
3	Test Antenna - Bi-Log	N/A	VULB9163	Schwarzbeck	2016.12.09	2017.12.08
4	Test Antenna - Horn	9170C-531	BBHA9170	Schwarzbeck	2017.03.30	2018.03.29
5	Test Antenna - Loop	1519-022	FMZB1519	Schwarzbeck	2017.03.30	2018.03.29
6	Test Antenna - Horn	71688	BBHA 9120D	Schwarzbeck	2017.03.30	2018.03.29
7	Coaxial cable (N male) (9KHz-30MHz)	CB04	EMC04	Morlab	N/A	N/A
8	Coaxial cable (N male) (30MHz-26GHz)	CB02	EMC02	Morlab	N/A	N/A
9	Coaxial cable(N male) (30MHz-26GHz)	CB03	EMC03	Morlab	N/A	N/A
10	1-18GHz pre-Amplifier	MA02	TS-PR18	Rohde& Schwarz	2017.05.17	2018.05.16
11	18-26.5GHz pre-Amplifier	MA03	TS-PR18	Rohde& Schwarz	2017.05.17	2018.05.16

1.5.5 Climate Chamber

Climate Chamber						
No.	Equipment Name	Serial No.	Type	Manufacturer	Cal.Date	Cal.Due Date
1	Climate Chamber	2004012	HL4003T	Yinhe	2017.01.11	2018.01.10

1.5.6 Vibration Table

Vibration Table						
No.	Equipment Name	Serial No.	Type	Manufacturer	Cal.Date	Cal.Due Date
1	Vibration Table	N/A	ACT2000-S015L	CMI-COM	2017.01.11	2018.01.10

1.5.7 Anechoic Chamber

Anechoic Chamber						
No.	Equipment Name	Serial No.	Type	Manufacturer	Cal.Date	Cal.Due Date
1	Anechoic Chamber	N/A	9m*6m*6m	Changning	2017.01.11	2018.01.10

***** END OF REPORT *****