



REPORT No.: SZ17080187W02

# FCC RF TEST REPORT

**APPLICANT** : Anker Technology Co., Limited  
**PRODUCT NAME** : Nebula Mars Lite  
**MODEL NAME** : D2321  
**TRADE NAME** : Nebula  
**BRAND NAME** : N/A  
**FCC ID** : 2AB7K-D2321  
**STANDARD(S)** : 47 CFR Part 15 Subpart C  
**ISSUE DATE** : 2017-09-11

**SHENZHEN MORLAB COMMUNICATIONS TECHNOLOGY Co., Ltd.**

NOTE: This document is issued by MORLAB, the test report shall not be reproduced except in full without prior written permission of the company. The test results apply only to the particular sample(s) tested and to the specific tests carried out which is available on request for validation and information confirmed at our website.

**MORLAB GROUP**

FL1-3, Building A, FeiYang Science Park, No.8 LongChang Road,  
Block67, BaoAn District, ShenZhen , Guangdong Province, P. R. China

Tel: 86-755-36698555

[Http://www.morlab.com](http://www.morlab.com)

Fax: 86-755-36698525

E-mail: [service@morlab.cn](mailto:service@morlab.cn)



# DIRECTORY

**TEST REPORT DECLARATION .....4**

**1. TECHNICAL INFORMATION.....5**

**1.1 APPLICANT INFORMATION .....5**

**1.2 EQUIPMENT UNDER TEST (EUT) DESCRIPTION .....5**

1.2.1 IDENTIFICATION OF ALL USED EUTS .....6

**1.3 TEST STANDARDS AND RESULTS.....6**

1.3.1 TEST ENVIRONMENT CONDITIONS.....6

**2. 47 CFR PART 15C REQUIREMENTS .....7**

**2.1 ANTENNA REQUIREMENT .....7**

2.1.1 APPLICABLE STANDARD .....7

2.1.2 RESULT: COMPLIANT.....7

**2.2 NUMBER OF HOPPING FREQUENCY.....7**

2.2.1 REQUIREMENT.....7

2.2.2 TEST DESCRIPTION .....7

2.2.3 TEST PROCEDURE.....8

2.2.4 TEST RESULT.....8

**2.3 PEAK OUTPUT POWER.....10**

2.3.1 REQUIREMENT.....10

2.3.2 TEST DESCRIPTION .....10

2.3.3 TEST RESULT.....10

**2.4 20dB BANDWIDTH .....12**

2.4.1 DEFINITION .....12

2.4.2 TEST DESCRIPTION .....12

2.4.3 TEST PROCEDURE.....12

2.4.4 TEST RESULT.....12

**2.5 CARRIED FREQUENCY SEPARATION.....22**

2.5.1 DEFINITION .....22

2.5.2 TEST DESCRIPTION .....22

2.5.3 TEST PROCEDURE.....22

2.5.4 TEST RESULT.....23

**2.6 TIME OF OCCUPANCY (DWEIL TIME) .....26**



2.6.1 REQUIREMENT..... 26

2.6.2 TEST DESCRIPTION ..... 26

2.6.3 TEST PROCEDURE..... 26

2.6.4 TEST RESULT..... 27

**2.7 CONDUCTED SPURIOUS EMISSIONS..... 39**

2.7.1 REQUIREMENT..... 39

2.7.2 TEST DESCRIPTION ..... 39

2.7.3 TEST PROCEDURE..... 39

2.7.4 TEST RESULT..... 40

**2.8 RESTRICTED FREQUENCY BANDS..... 52**

2.8.1 REQUIREMENT..... 52

2.8.2 TEST DESCRIPTION ..... 52

2.8.3 TEST PROCEDURE..... 53

2.8.4 TEST RESULT..... 53

**2.9 CONDUCTED EMISSION ..... 61**

2.9.1 REQUIREMENT..... 61

2.9.2 TEST DESCRIPTION ..... 61

2.9.3 TEST RESULT..... 62

**2.10 RADIATED EMISSION ..... 64**

2.10.1 REQUIREMENT..... 64

2.10.2 TEST DESCRIPTION ..... 65

2.10.3 TEST PROCEDURE..... 67

2.10.4 TEST RESULT..... 67

**ANNEX A GENERAL INFORMATION ..... 77**

| Change History |            |                   |
|----------------|------------|-------------------|
| Issue          | Date       | Reason for change |
| 1.0            | 2017-09-11 | First edition     |
|                |            |                   |

**TEST REPORT DECLARATION**

|                      |  |
|----------------------|--|
| Applicant            | Anker Technology Co., Limited  |
| Applicant Address    | Room 1318-19,Hollywood Plaza,610 Nathan Road,<br>Mongkok, Kowloon, Hong Kong |
| Manufacturer         | Anker Technology Co., Limited  |
| Manufacturer Address | Room 1318-19,Hollywood Plaza,610 Nathan Road,<br>Mongkok, Kowloon, Hong Kong |
| Product Name         | Nebula Mars Lite   |
| Model Name           | D2321  |
| Brand Name           | N/A  |
| HW Version           | 9893C  |
| SW Version           | N/A  |
| Test Standards       | 47 CFR Part 15 Subpart C   |
| Test Date            | 2017-08-30 to 2017-09-07   |
| Test Result          | PASS   |

Tested by :                     Tu Ya'nan                      
Tu Ya'nan (Test Engineer)

Approved by :                     Qiu Xiaojun                      
Qiu Xiaojun (Supervisor)



## 1. TECHNICAL INFORMATION

Note: Provide by applicant.

### 1.1 Applicant Information

|          |   |
|----------|---|
| Company: | Anker Technology Co., Limited   |
| Address: | Room 1318-19, Hollywood Plaza, 610 Nathan Road, Mongkok, Kowloon, Hong Kong |

### 1.2 Equipment under Test (EUT) Description

|                    |  |
|--------------------|--|
| Brand Name:        | N/A  |
| Trade Name:        | Nebula   |
| Model Name:        | D2321  |
| Frequency Range:   | The frequency range used is 2402MHz – 2480MHz (79 channels, at intervals of 1MHz);<br>The frequency block is 2400MHz to 2483.5MHz. |
| Modulation Type:   | Bluetooth: FHSS (GFSK(1Mbps), $\pi/4$ -DQPSK(EDR 2Mbps), 8-DPSK(EDR 3Mbps))  |
| Bluetooth Version: | Bluetooth 4.1 + EDR  |
| Antenna Type:      | FPCB Antenna   |
| Antenna Gain:      | 3.6 dBi  |

**NOTE 1:** The EUT is a Nebula Mars Lite. It contains Bluetooth Module operating at 2.4GHz ISM band; the frequencies allocated for the Bluetooth Module is  $F(\text{MHz})=2402+1*n$  ( $0 \leq n \leq 78$ ). The lowest, middle, highest channel numbers of the Bluetooth Module used and tested in this report are separately 0 (2402MHz), 39 (2441MHz) and 78 (2480MHz).

**NOTE 2:** The EUT connected to the serial port of the computer with a serial communication cable, we use the dedicated software to control the EUT into the test mode, and then use MT8852B base station to control the EUT continuous transmission.

For a more detailed description, please refer to Specification or User's Manual supplied by the applicant and/or manufacturer.



### 1.2.1 Identification of all used EUTs

The EUT identity consists of numerical and letter characters, the letter character indicates the test sample, and the following two numerical characters indicate the software version of the test sample.

| EUT Identity | Hardware Version | Software Version |
|--------------|------------------|------------------|
| 01           | 9893C            | N/A              |

### 1.3 Test Standards and Results

The objective of the report is to perform testing according to 47 CFR Part 15 Subpart C (Bluetooth, 2.4GHz ISM band radiators) for the EUT FCC ID Certification:

| No. | Identity                            | Document Title          |
|-----|-------------------------------------|-------------------------|
| 1   | 47 CFR Part 15<br>(10-1-15 Edition) | Radio Frequency Devices |

Test detailed items/section required by FCC rules and results are as below:

| No. | Section in CFR 47 | Description                    | Test Date    | Result             |
|-----|-------------------|--------------------------------|--------------|--------------------|
| 1   | 15.203            | Antenna Requirement            | N/A          | <b><u>PASS</u></b> |
| 2   | 15.247(a)         | Number of Hopping Frequency    | Sep 07, 2017 | <b><u>PASS</u></b> |
| 3   | 15.247(b)         | Peak Output Power              | Sep 07, 2017 | <b><u>PASS</u></b> |
| 4   | 15.247(a)         | 20dB Bandwidth                 | Sep 07, 2017 | <b><u>PASS</u></b> |
| 5   | 15.247(a)         | Carrier Frequency Separation   | Sep 07, 2017 | <b><u>PASS</u></b> |
| 6   | 15.247(a)         | Time of Occupancy (Dwell time) | Sep 07, 2017 | <b><u>PASS</u></b> |
| 7   | 15.247(d)         | Conducted Spurious Emission    | Sep 07, 2017 | <b><u>PASS</u></b> |
| 8   | 15.247(d)         | Restricted Frequency Bands     | Sep 05, 2017 | <b><u>PASS</u></b> |
| 9   | 15.209 15.247(d)  | Radiated Emission              | Sep 03, 2017 | <b><u>PASS</u></b> |
| 10  | 15.207            | Conducted Emission             | Aug 31, 2017 | <b><u>PASS</u></b> |

**NOTE:** The tests were performed according to the method of measurements prescribed in ANSI C63.10-2013.

#### 1.3.1 Test Environment Conditions

During the measurement, the environmental conditions were within the listed ranges:

|                             |         |
|-----------------------------|---------|
| Temperature (°C):           | 15 - 35 |
| Relative Humidity (%):      | 30 -60  |
| Atmospheric Pressure (kPa): | 86-106  |

## 2. 47 CFR PART 15C REQUIREMENTS

### 2.1 Antenna requirement

#### 2.1.1 Applicable Standard

According to FCC 15.203, an intentional radiator shall be designed to ensure that no antenna other than that furnished by the responsible party shall be used with the device. The use of a permanently attached antenna or of an antenna that uses a unique coupling to the intentional radiator shall be considered sufficient to comply with the provisions of this section.

#### 2.1.2 Result: Compliant

The EUT has a permanently and irreplaceable attached antenna. Please refer to the EUT internal photos.

### 2.2 Number of Hopping Frequency

#### 2.2.1 Requirement

According to FCC §15.247(a)(1)(iii), frequency hopping systems operating in the 2400MHz to 2483.5MHz bands shall use at least 15 hopping frequencies.

#### 2.2.2 Test Description

##### A. Test Setup:

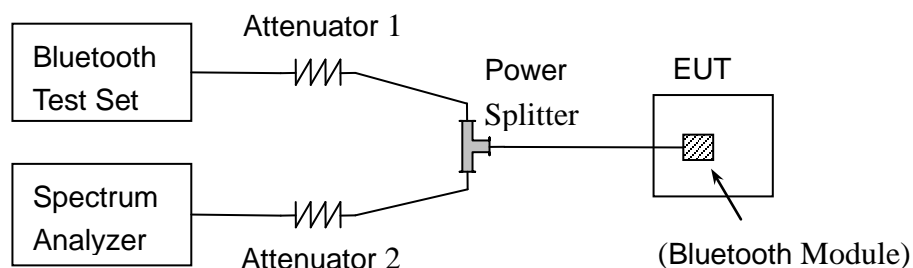

The Bluetooth Module of the EUT is coupled to the Spectrum Analyzer (SA) and the Bluetooth Test Set with Attenuators through the Power Splitter; the RF load attached to the EUT antenna terminal is 50Ohm; the path loss as the factor is calibrated to correct the reading. During the measurement, the Bluetooth Module of the EUT is activated and controlled by the SS, and is set to operate under test mode transmitting 339 bytes DH5 packages at maximum power.

##### B. Equipments List:

Please reference ANNEX A(1.5).



**2.2.3 Test Procedure**

The EUT must have its hopping function enabled. Use the following spectrum analyzer settings:

Span = the frequency band of operation

RBW ≥ 1% of the span

VBW ≥ RBW

Sweep = auto

Detector function = peak

Trace = max hold

Allow the trace to stabilize

**2.2.4 Test Result**

The Bluetooth Module operates at hopping-on test mode; the frequencies number employed is counted to verify the Module's using the number of hopping frequency.

**A. Test Verdict:**

| Test Mode      | Frequency Block (MHz) | Measured Channel Numbers | Min. Limit | Refer to Plot | Verdict |
|----------------|-----------------------|--------------------------|------------|---------------|---------|
| GFSK           | 2400 - 2483.5         | 79                       | 15         | Plot A        | PASS    |
| $\pi/4$ -DQPSK | 2400 - 2483.5         | 79                       | 15         | Plot B        | PASS    |
| 8-DPSK         | 2400 - 2483.5         | 79                       | 15         | Plot C        | PASS    |

**B. Test Plots:**

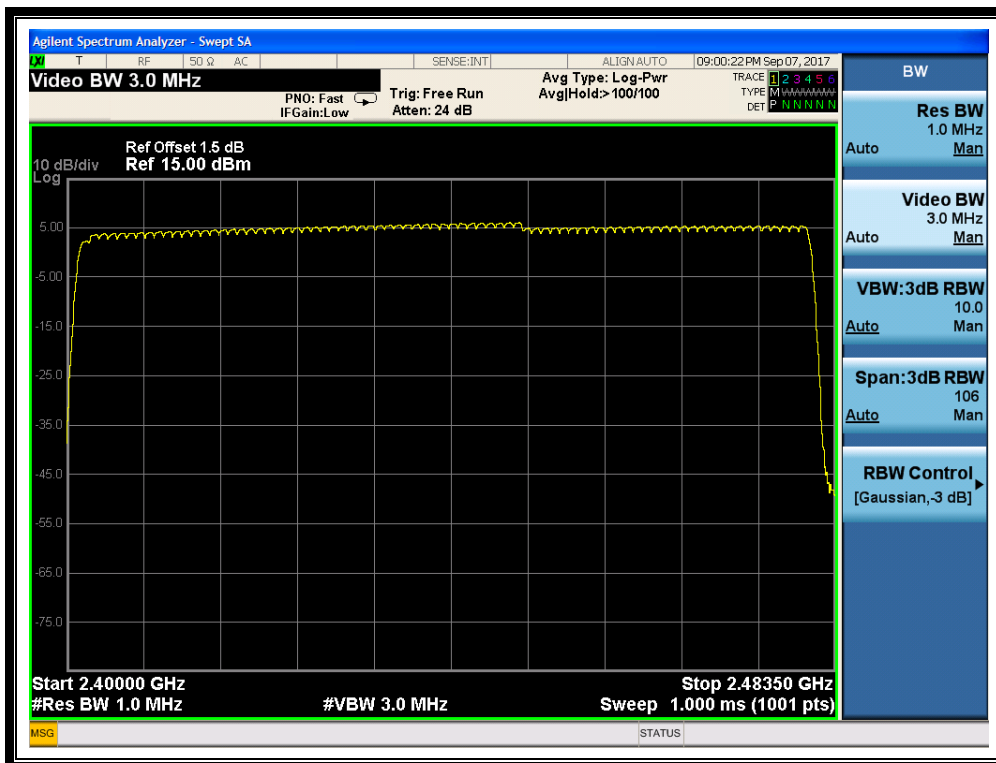

(Plot A: GFSK)



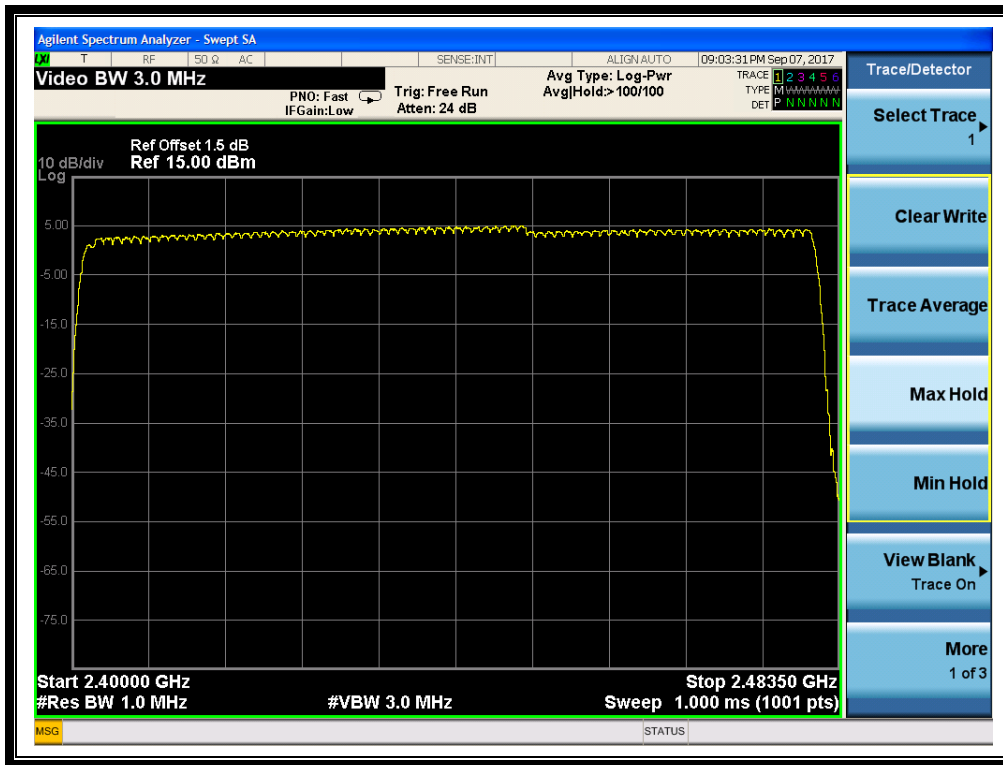

(Plot B:  $\pi/4$ -DQPSK)

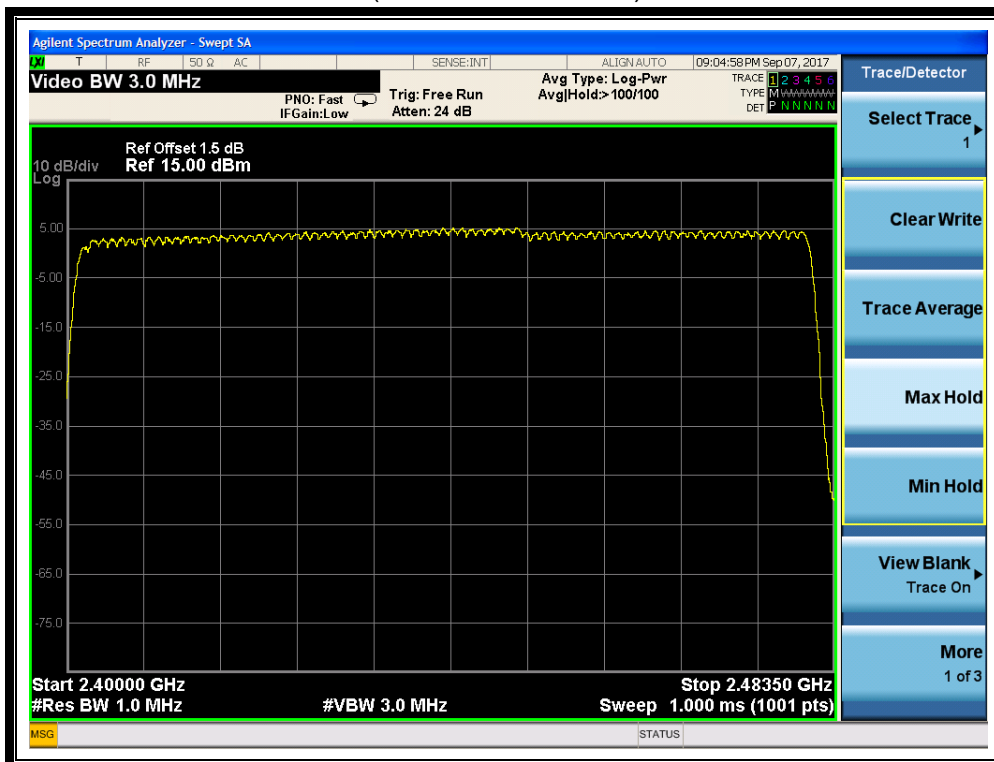

(Plot C: 8- DPSK)

## 2.3 Peak Output Power

### 2.3.1 Requirement

According to FCC §15.247(b)(1), for frequency hopping systems that operates in the 2400MHz to 2483.5MHz band employing at least 75 hopping channels, the maximum peak output power of the intentional radiator shall not exceed 1Watt. For all other frequency hopping systems in the 2400MHz to 2483.5MHz band, it is 0.125Watts.

### 2.3.2 Test Description

#### A. Test Setup:

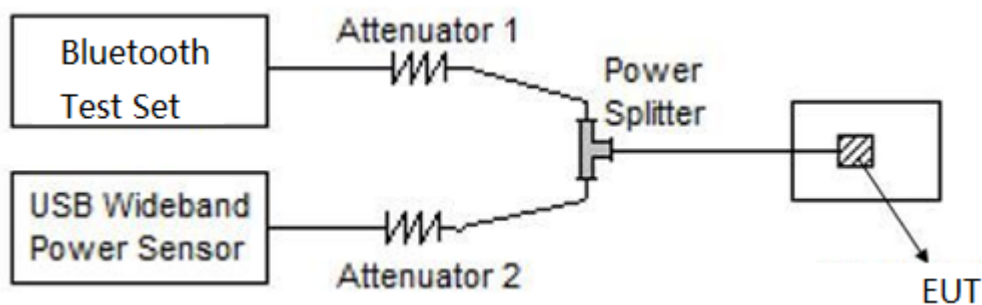

The Bluetooth Module of the EUT is coupled to the USB Wideband Power Sensor and the Bluetooth Test Set with Attenuators through the Power Splitter; the RF load attached to the EUT antenna terminal is 50Ohm; the path loss as the factor is calibrated to correct the reading. During the measurement, the Bluetooth Module of the EUT is activated and controlled by the SS, and is set to operate under test mode transmitting 339 bytes DH5 packages at maximum power.

#### B. Equipments List:

Please reference ANNEX A(1.5).

### 2.3.3 Test Result

The Bluetooth Module operates at hopping-off test mode. The lowest, middle and highest channels are selected to perform testing to verify the conducted RF output peak power of the module. The lowest, middle and highest channel were tested by USB Wideband Power Sensor.

**2.3.3.1 GFSK Mode****A. Test Verdict:**

| Channel | Frequency (MHz) | Measured Output Peak Power |         | Limit |   | Verdict |
|---------|-----------------|----------------------------|---------|-------|---|---------|
|         |                 | dBm                        | W       | dBm   | W |         |
| 0       | 2402            | 6.83                       | 0.00482 | 30    | 1 | PASS    |
| 39      | 2441            | 8.51                       | 0.00710 |       |   | PASS    |
| 78      | 2480            | 8.87                       | 0.00771 |       |   | PASS    |

**2.3.3.2  $\pi/4$ -DQPSK Mode****B. Test Verdict:**

| Channel | Frequency (MHz) | Measured Output Peak Power |         | Limit |       | Verdict |
|---------|-----------------|----------------------------|---------|-------|-------|---------|
|         |                 | dBm                        | W       | dBm   | W     |         |
| 0       | 2402            | 5.07                       | 0.00321 | 20.97 | 0.125 | PASS    |
| 39      | 2441            | 7.43                       | 0.00553 |       |       | PASS    |
| 78      | 2480            | 7.54                       | 0.00568 |       |       | PASS    |

**2.3.3.3 8-DPSK Mode****C. Test Verdict:**

| Channel | Frequency (MHz) | Measured Output Peak Power |         | Limit |       | Verdict |
|---------|-----------------|----------------------------|---------|-------|-------|---------|
|         |                 | dBm                        | W       | dBm   | W     |         |
| 0       | 2402            | 5.05                       | 0.00320 | 20.97 | 0.125 | PASS    |
| 39      | 2441            | 7.47                       | 0.00558 |       |       | PASS    |
| 78      | 2480            | 7.44                       | 0.00555 |       |       | PASS    |

## 2.4 20dB Bandwidth

### 2.4.1 Definition

According to FCC §15.247(a)(1), the 20dB bandwidth is known as the 99% emission bandwidth, or 20dB bandwidth ( $10 \cdot \log 1\% = 20\text{dB}$ ) taking the total RF output power.

### 2.4.2 Test Description

#### A. Test Setup:

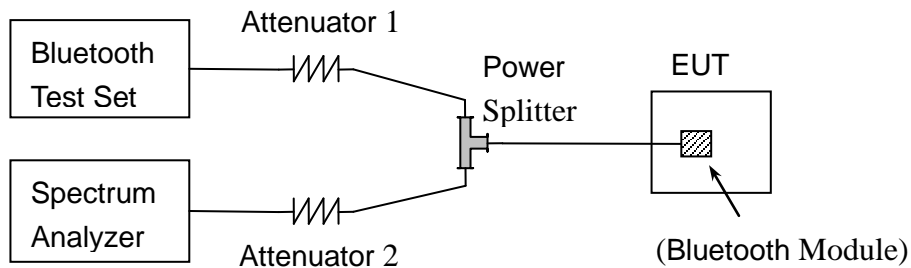

The Bluetooth Module of the EUT is coupled to the Spectrum Analyzer (SA) and the Bluetooth Test Set with Attenuators through the Power Splitter; the RF load attached to the EUT antenna terminal is 50Ohm; the path loss as the factor is calibrated to correct the reading. During the measurement, the Bluetooth Module of the EUT is activated and controlled by the SS, and is set to operate under test mode transmitting 339 bytes DH5 packages at maximum power.

#### B. Equipments List:

Please reference ANNEX A(1.5).

### 2.4.3 Test Procedure

Use the following spectrum analyzer settings:

Span = approximately 2 to 3 times the 20 dB bandwidth, centered on a hopping channel

RBW  $\geq$  1% of the 20 dB bandwidth

VBW  $\geq$  RBW

Sweep = auto

Detector function = peak

Trace = max hold

### 2.4.4 Test Result

The Bluetooth Module operates at hopping-off test mode. The lowest, middle and highest channels are selected to perform testing to record the 20dB bandwidth of the Module.



2.4.4.1 GFSK Mode

A. Test Verdict:

The maximum 20dB bandwidth measured is 0.9452 MHz according to the table below.

| Channel | Frequency (MHz) | 20dB Bandwidth (MHz) | Refer to Plot |
|---------|-----------------|----------------------|---------------|
| 0       | 2402            | 0.9385               | Plot A        |
| 39      | 2441            | 0.9384               | Plot B        |
| 78      | 2480            | 0.9452               | Plot C        |

B. Test Plots:

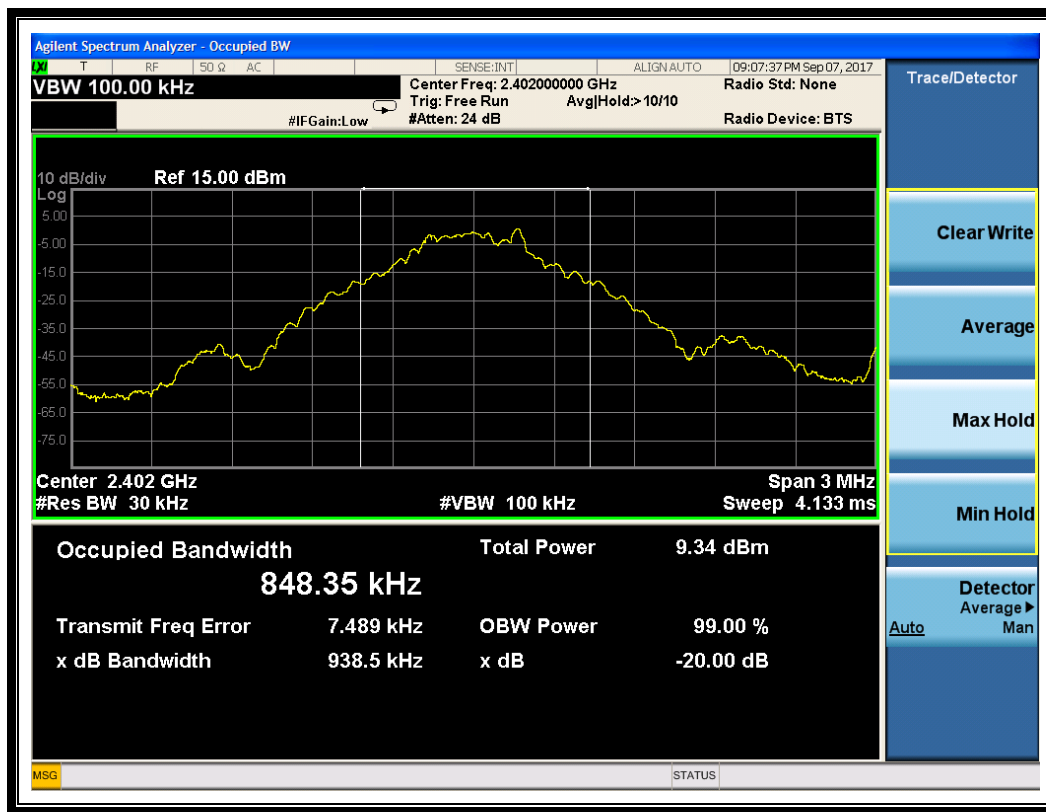

(Plot A: Channel = 2402 @ GFSK)

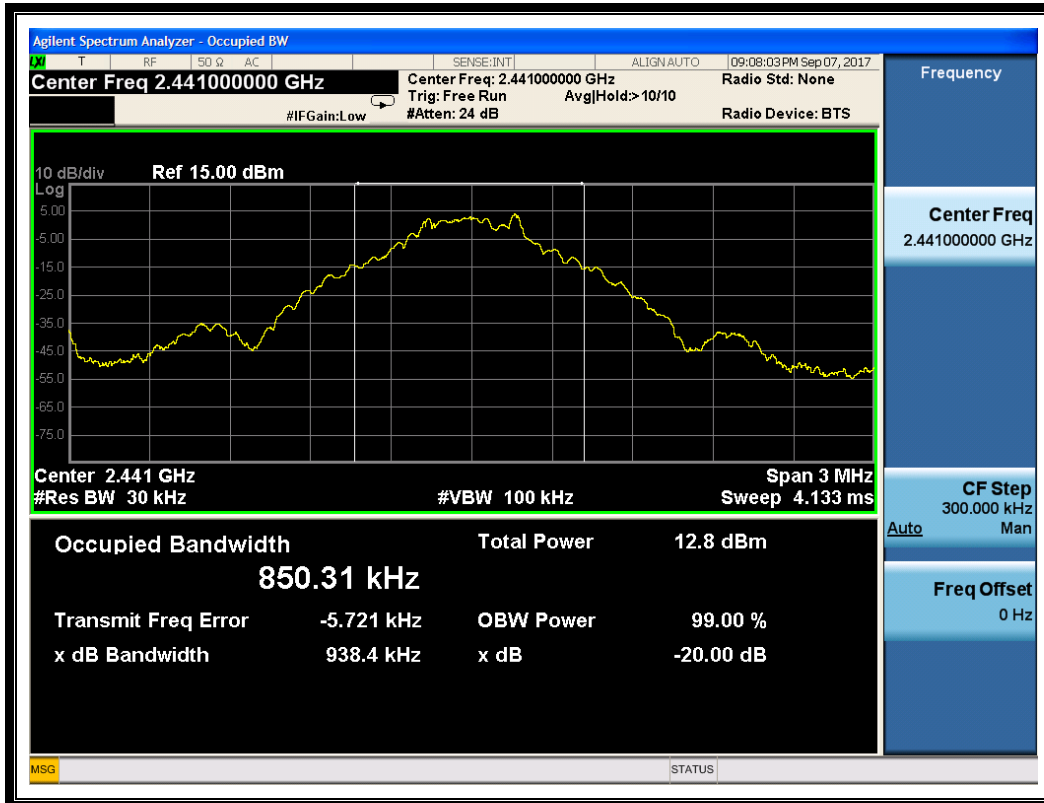

(Plot B: Channel = 2441 @ GFSK)

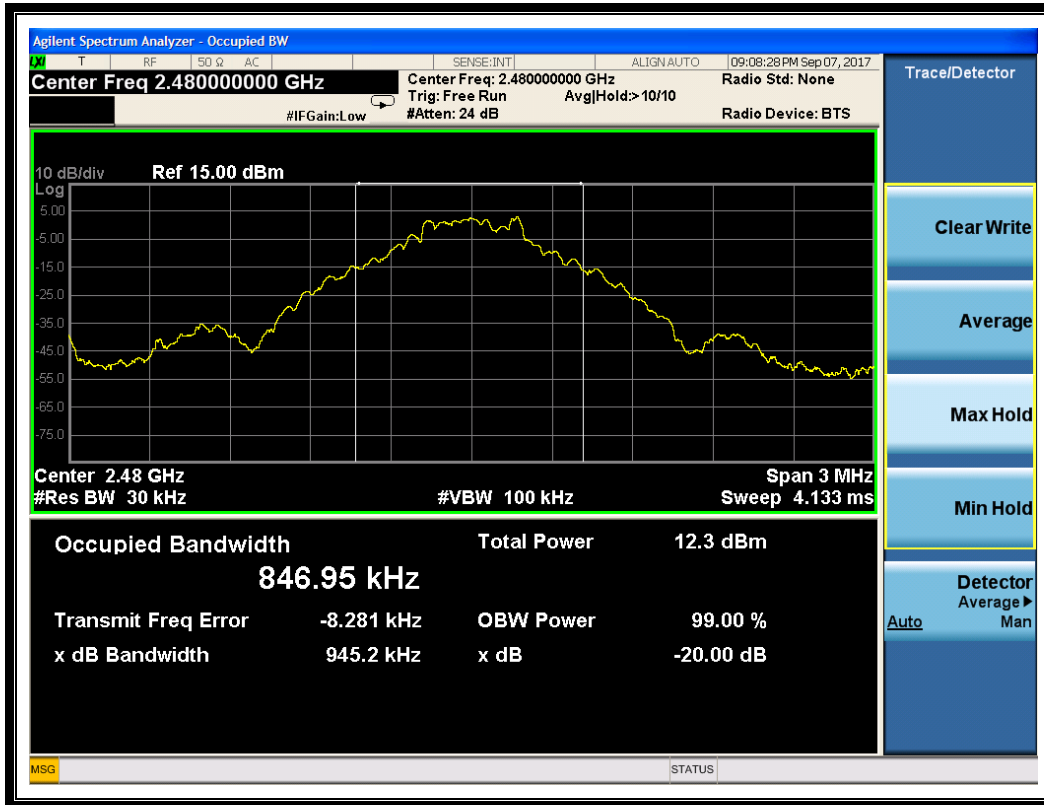

(Plot C: Channel = 2480 @ GFSK)

2.4.4.2  $\pi/4$ -DQPSK Mode

A. Test Verdict:

The maximum 20dB bandwidth measured is 1.265 MHz according to the table below.

| Channel | Frequency (MHz) | 20dB Bandwidth (MHz) | Refer to Plot |
|---------|-----------------|----------------------|---------------|
| 0       | 2402            | 1.237                | Plot D        |
| 39      | 2441            | 1.265                | Plot E        |
| 78      | 2480            | 1.258                | Plot F        |

B. Test Plots:

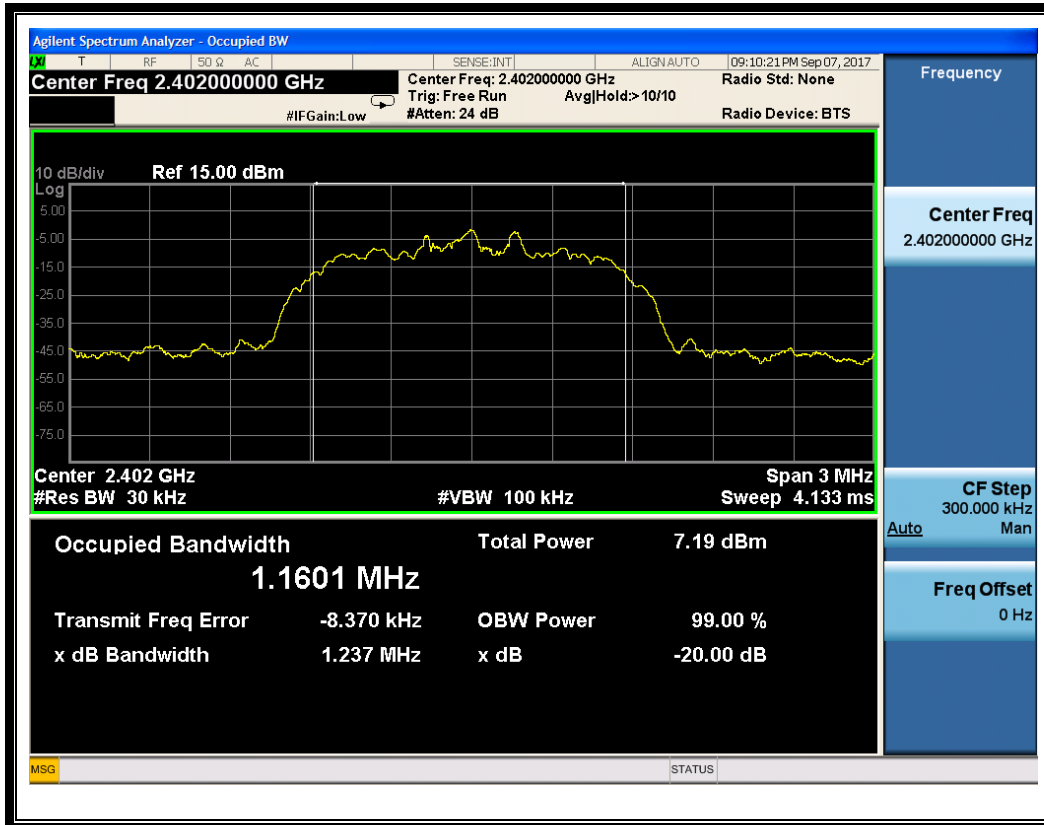

(Plot D: Channel = 2402 @  $\pi/4$ -DQPSK)



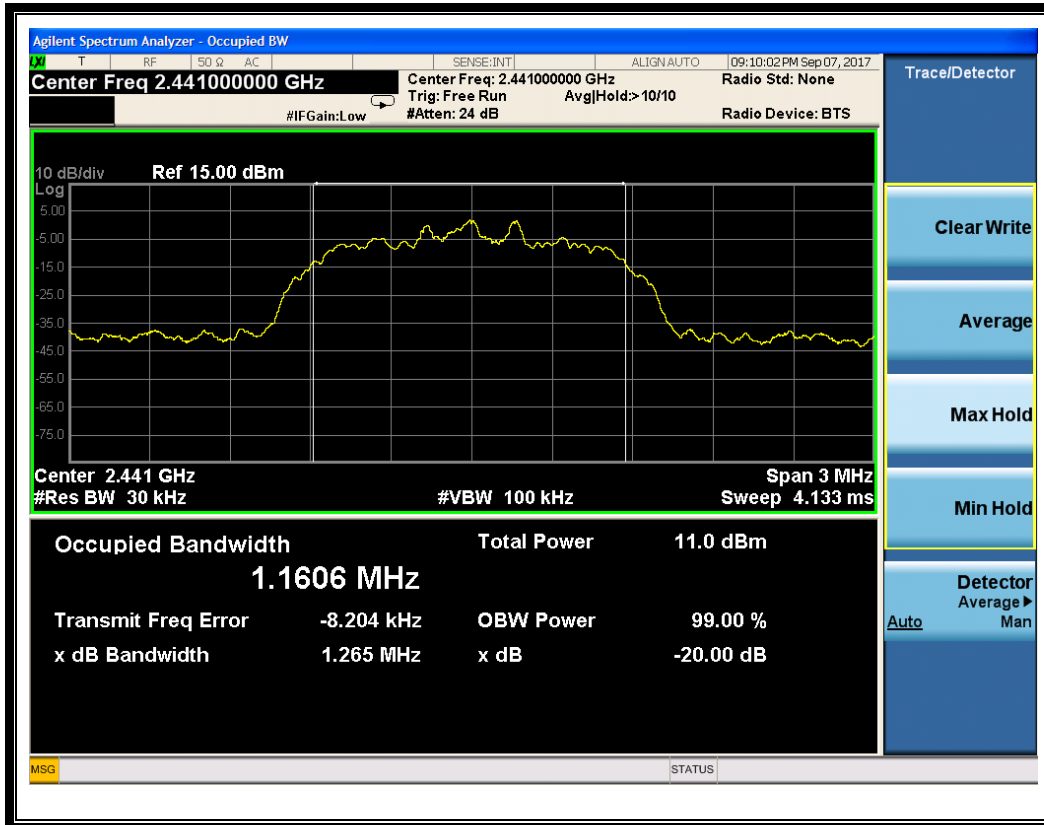

(Plot E: Channel = 2441 @  $\pi/4$ -DQPSK)

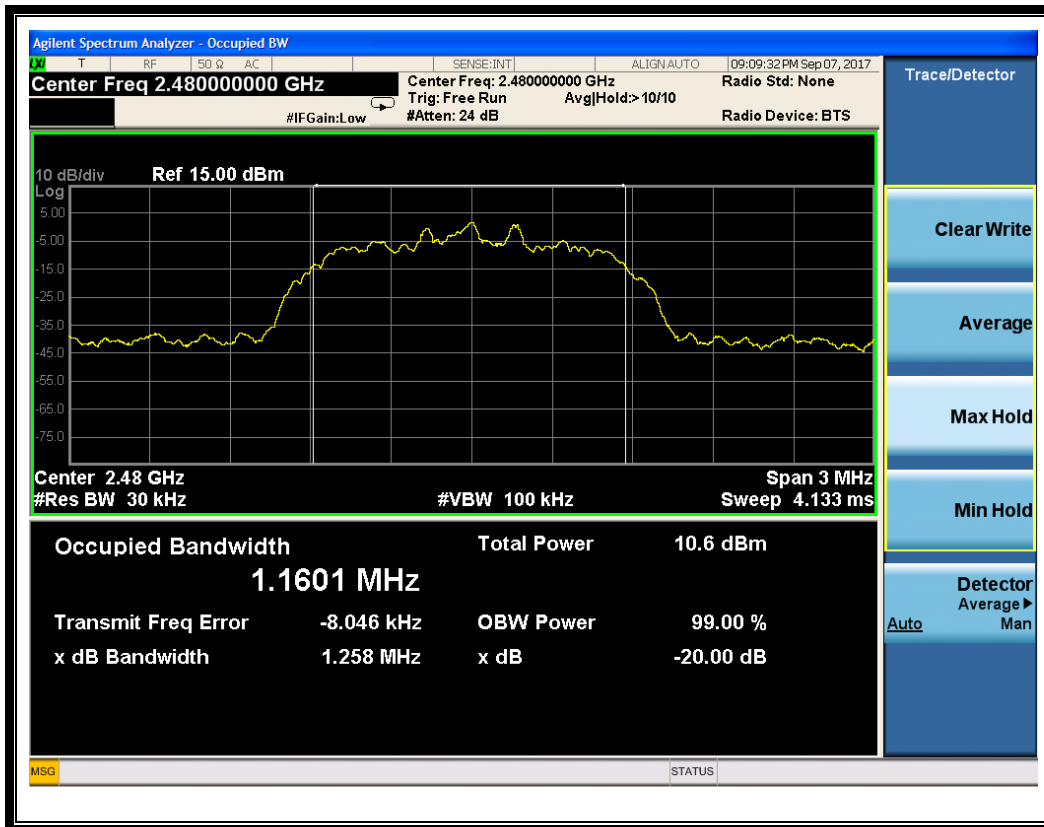

(Plot F: Channel = 2480 @  $\pi/4$ -DQPSK)

### 2.4.4.3 8-DPSK Mode

#### A. Test Verdict:

The maximum 20dB bandwidth measured is 1.266 MHz according to the table below.

| Channel | Frequency (MHz) | 20dB Bandwidth (MHz) | Refer to Plot |
|---------|-----------------|----------------------|---------------|
| 0       | 2402            | 1.265                | Plot G        |
| 39      | 2441            | 1.265                | Plot H        |
| 78      | 2480            | 1.266                | Plot I        |

#### B. Test Plots:

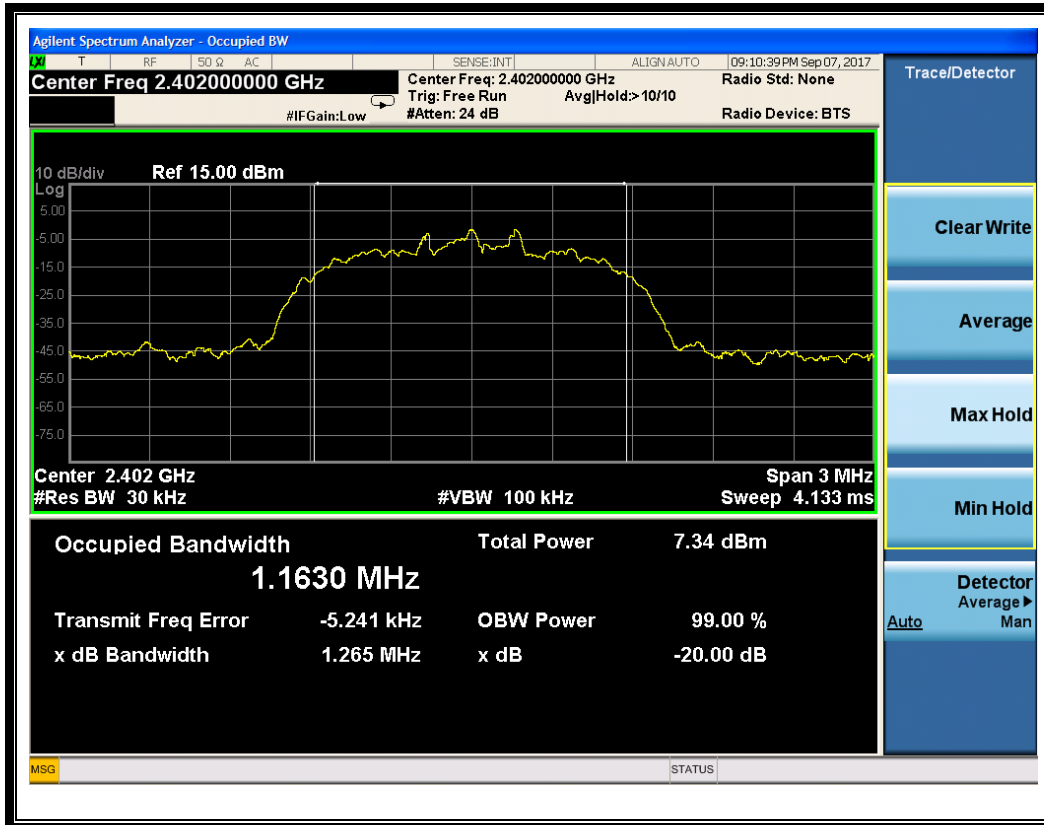

(Plot G: Channel = 2402 @ 8-DPSK)

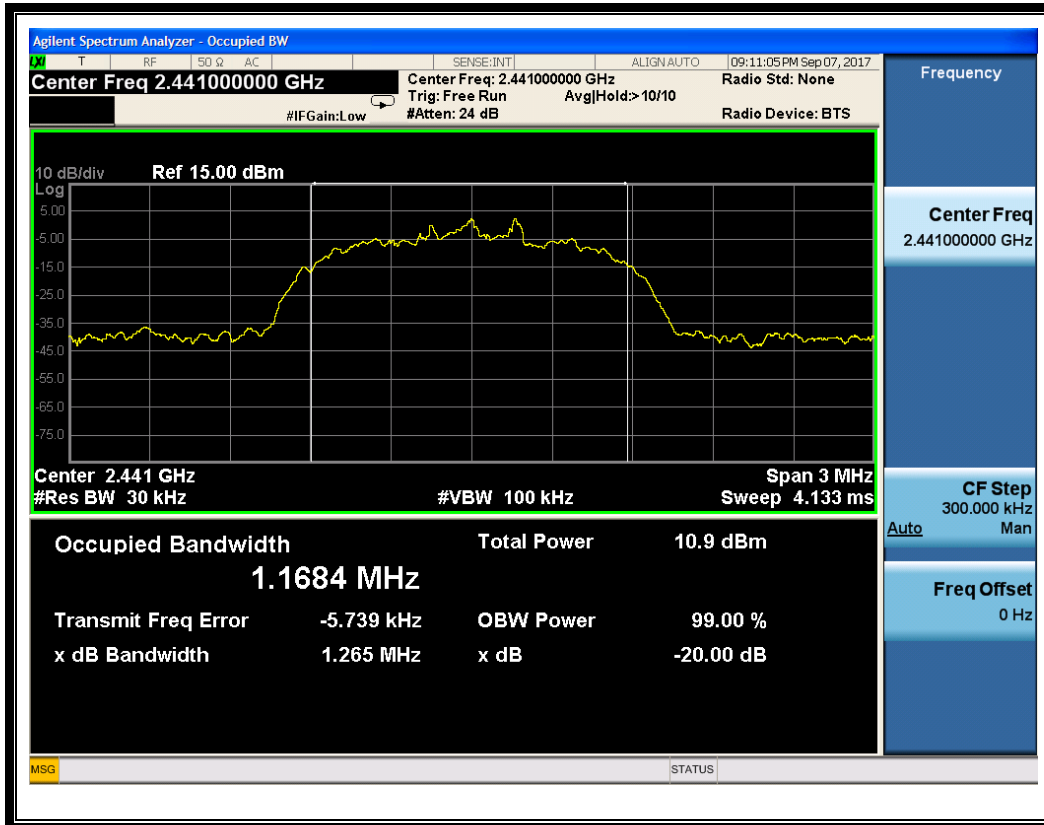

(Plot H: Channel = 2441 @ 8-DPSK)

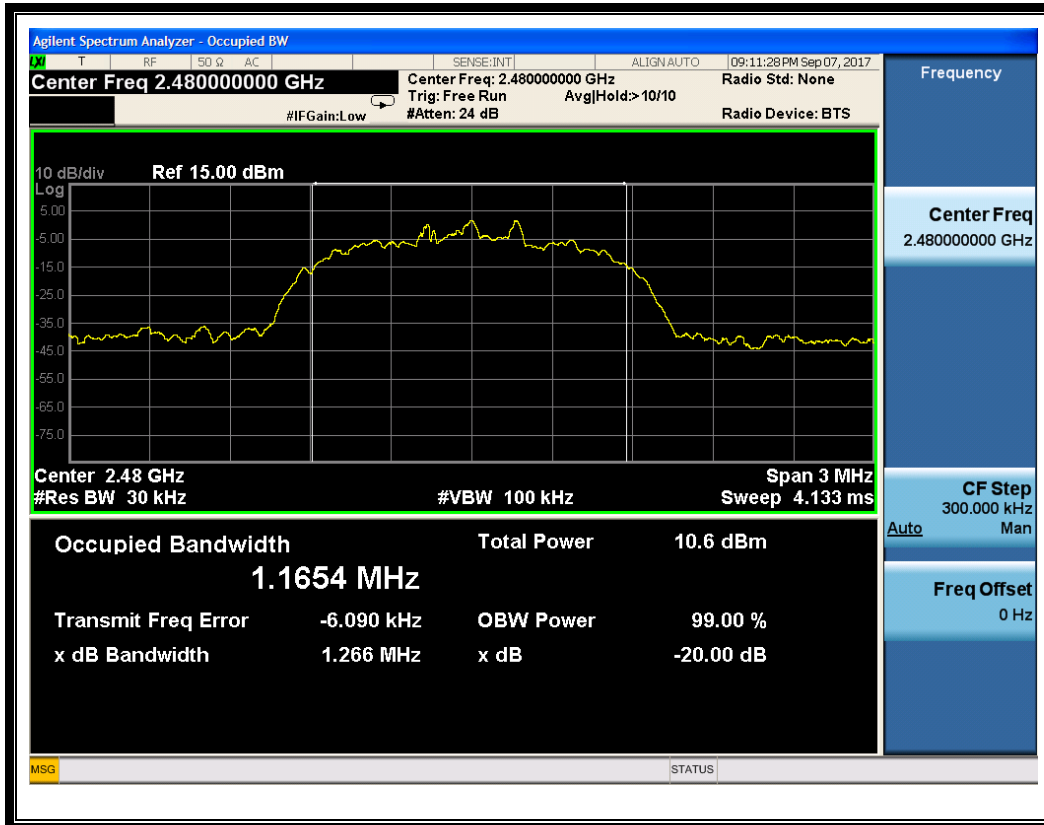

(Plot I: Channel = 2480 @ 8-DPSK)

## 2.5 Carried Frequency Separation

### 2.5.1 Definition

According to FCC §15.247(a)(1), frequency hopping systems shall have hopping channel carrier frequencies separated by a minimum of 25kHz or two-thirds of the 20dB bandwidth of the hopping channel, whichever is greater.

### 2.5.2 Test Description

#### A. Test Setup:

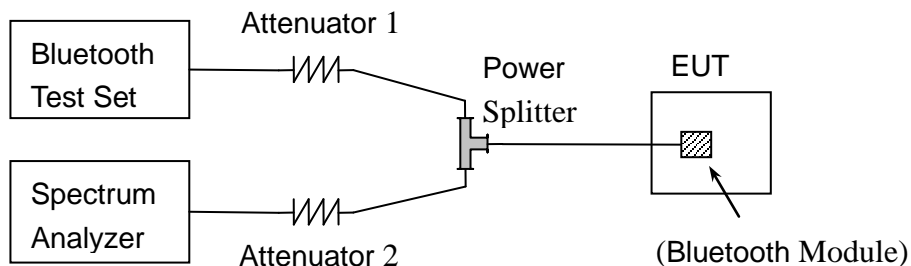

The Bluetooth Module of the EUT is coupled to the Spectrum Analyzer (SA) and the Bluetooth Test Set with Attenuators through the Power Splitter; the RF load attached to the EUT antenna terminal is 50Ohm; the path loss as the factor is calibrated to correct the reading. During the measurement, the Bluetooth Module of the EUT is activated and controlled by the SS, and is set to operate under test mode transmitting 339 bytes DH5 packages at maximum power.

#### B. Equipments List:

Please reference ANNEX A(1.5).

### 2.5.3 Test Procedure

The EUT must have its hopping function enabled. Use the following spectrum analyzer settings:

Span = wide enough to capture the peaks of two adjacent channels

Resolution (or IF) Bandwidth (RBW)  $\geq$  1% of the span

Video (or Average) Bandwidth (VBW)  $\geq$  RBW

Sweep = auto

Detector function = peak

Trace = max hold

Allow the trace to stabilize. Use the marker-delta function to determine the separation between the peaks of the adjacent channels.

### 2.5.4 Test Result

The Bluetooth Module operates at hopping-on test mode. For any adjacent channels (e.g. the channel 39 and 40 as showed in the Plot A), the Module does have hopping channel carrier frequencies separated by a minimum of 25kHz or two-thirds of the 20dB bandwidth of the hopping channel (refer to section 2.4.4), whichever is greater. So, the verdict is PASSING

| Test Mode      | Measured Channel Numbers | Carried Frequency Separation | Refer to Plot | 20dB bandwidth (MHz) | Min. Limit        | Verdict |
|----------------|--------------------------|------------------------------|---------------|----------------------|-------------------|---------|
| GFSK           | 39 and 40                | 1.002                        | Plot A        | 0.9452               | 20dB bandwidth    | PASS    |
| $\pi/4$ -DQPSK | 39 and 40                | 1.002                        | Plot B        | 1.265                | two-thirds of the | PASS    |
| 8-DPSK         | 39 and 40                | 1.002                        | Plot C        | 1.266                | 20dB bandwidth    | PASS    |

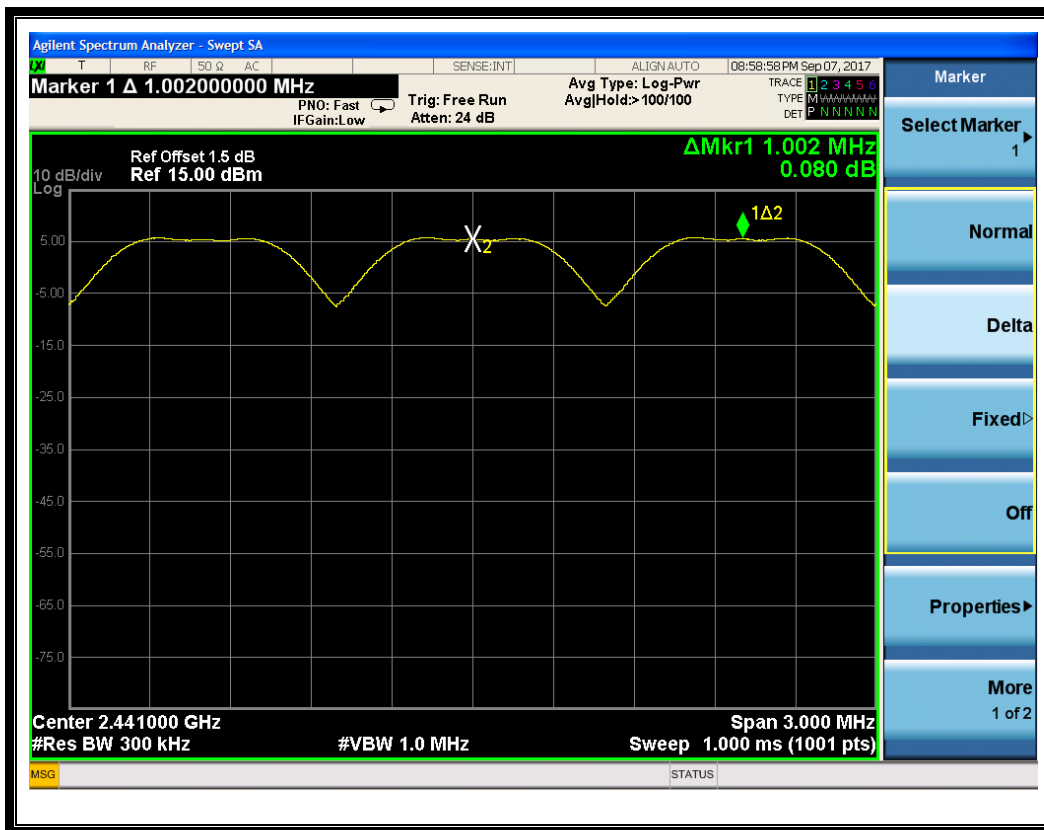

(Plot A: GFSK)

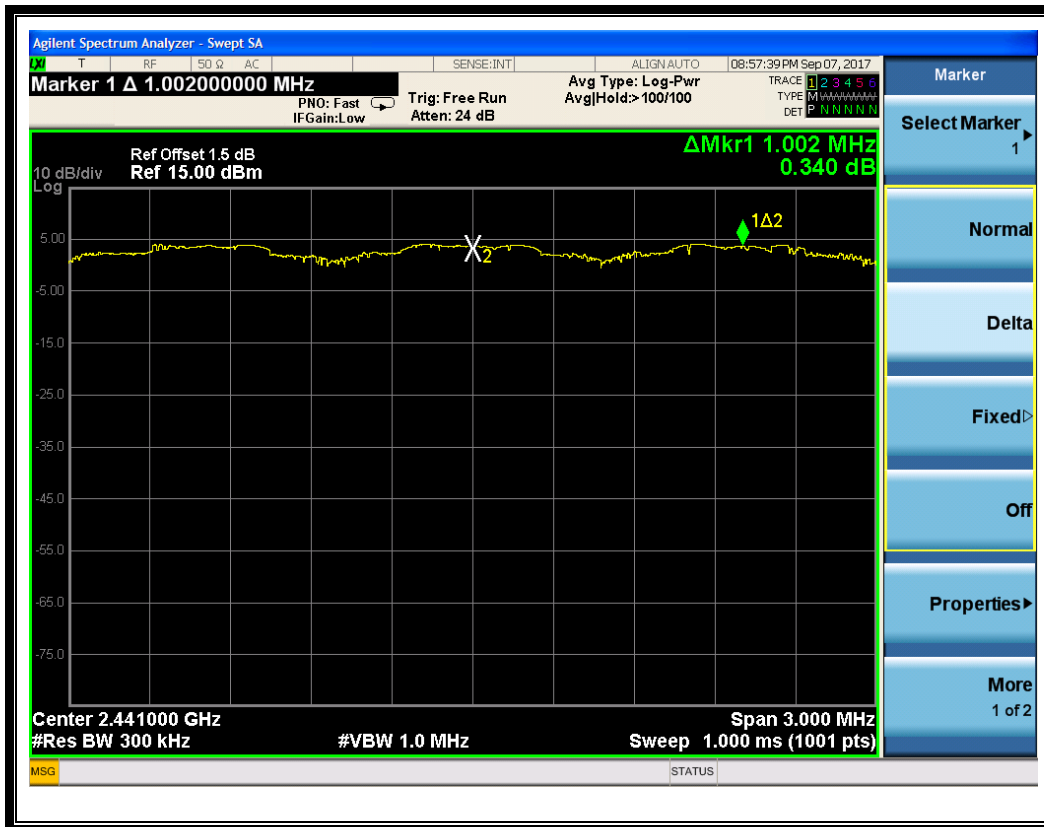

(Plot B:  $\pi/4$ -DQPSK)



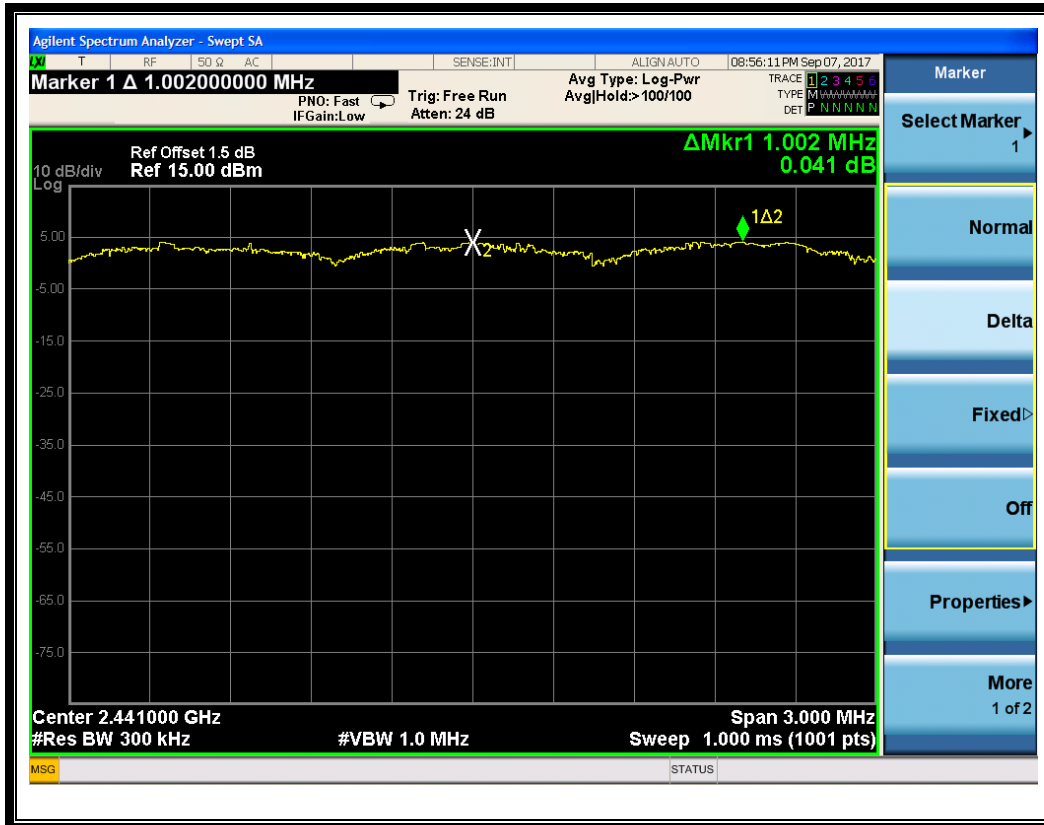

(Plot C: 8-DPSK)

## 2.6 Time of Occupancy (Dwell time)

### 2.6.1 Requirement

According to FCC §15.247(a) (1) (iii), frequency hopping systems in the 2400 - 2483.5MHz band shall use at least 15 non-overlapping channels. The average time of occupancy on any channel shall not be greater than 0.4 seconds within a period of 0.4 seconds multiplied by the number of hopping channels employed. Frequency hopping systems may avoid or suppress transmissions on a particular hopping frequency provided that a minimum of 15 channels are used.

### 2.6.2 Test Description

#### A. Test Setup:

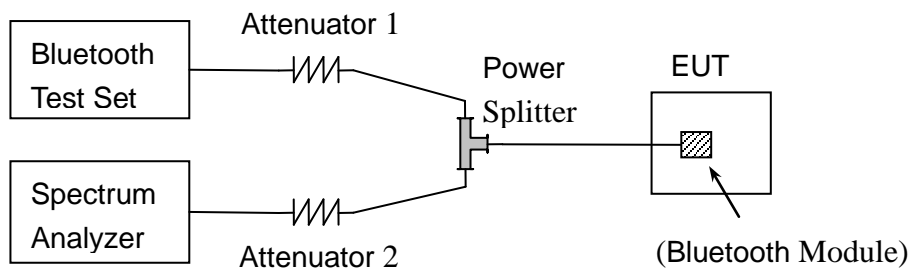

The Bluetooth Module of the EUT is coupled to the Spectrum Analyzer (SA) and the Bluetooth Test Set with Attenuators through the Power Splitter; the RF load attached to the EUT antenna terminal is 50Ohm; the path loss as the factor is calibrated to correct the reading. During the measurement, the Bluetooth Module of the EUT is activated and controlled by the SS, and is set to operate under test mode transmitting 339 bytes DH5 packages at maximum power.

#### B. Equipments List:

Please reference ANNEX A(1.5).

### 2.6.3 Test Procedure

The transmitter output is connected to a spectrum analyzer. The span is set to 0 Hz, centered on a single, selected hopping channel. The width of a single pulse is measured in a fast scan. The number of pulses is measured in a 3.16 second scan, to enable resolution of each occurrence.

The average time of occupancy in the specified 31.6 second period (79 channel \* 0.4 s) is equal to  $10 * (\# \text{ of pulses in } 3.16 \text{ s}) * \text{ pulse width}$ .



2.6.4 Test Result

2.6.4.1 GFSK Mode

A. Test Verdict:

| DH Packet | Pulse Width (msec) | Number of pulse in 3.16 seconds | Average Time of Occupancy in 3.16 seconds (sec) | Average Time of Occupancy in 31.6 seconds (sec) | Limit (sec) | Verdict |
|-----------|--------------------|---------------------------------|---|---|-------------|---------|
| DH1       | 0.4                | 30                              | 0.0120  | 0.120   | 0.4         | PASS    |
| DH3       | 1.65               | 14                              | 0.0231  | 0.231   |             | PASS    |
| DH5       | 2.9                | 13                              | 0.0377  | 0.377   |             | PASS    |

B. Test Plots:

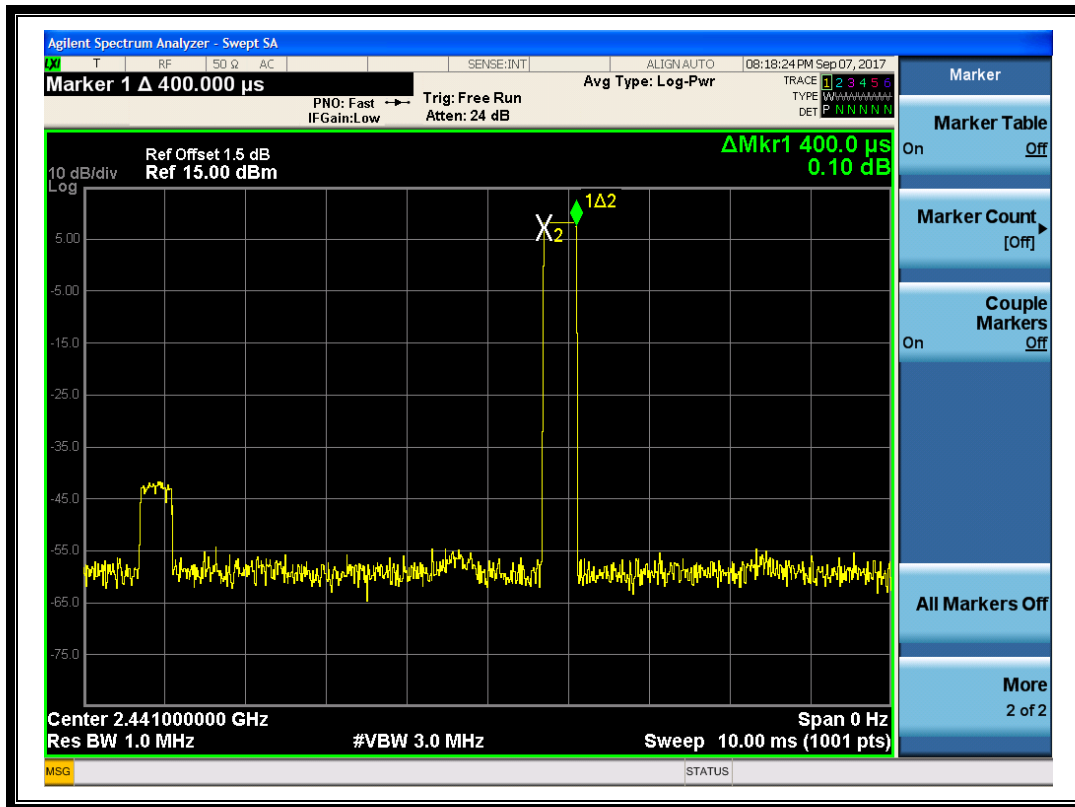

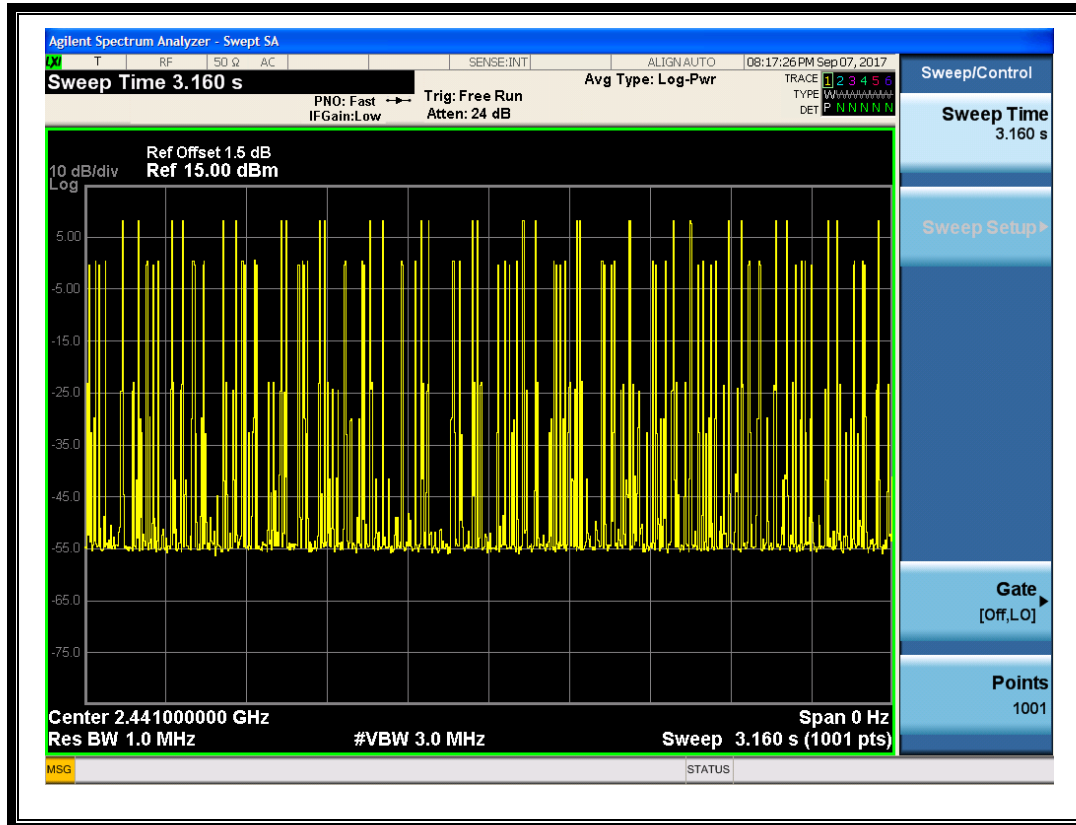

(Plot A: DH1 @ GFSK)

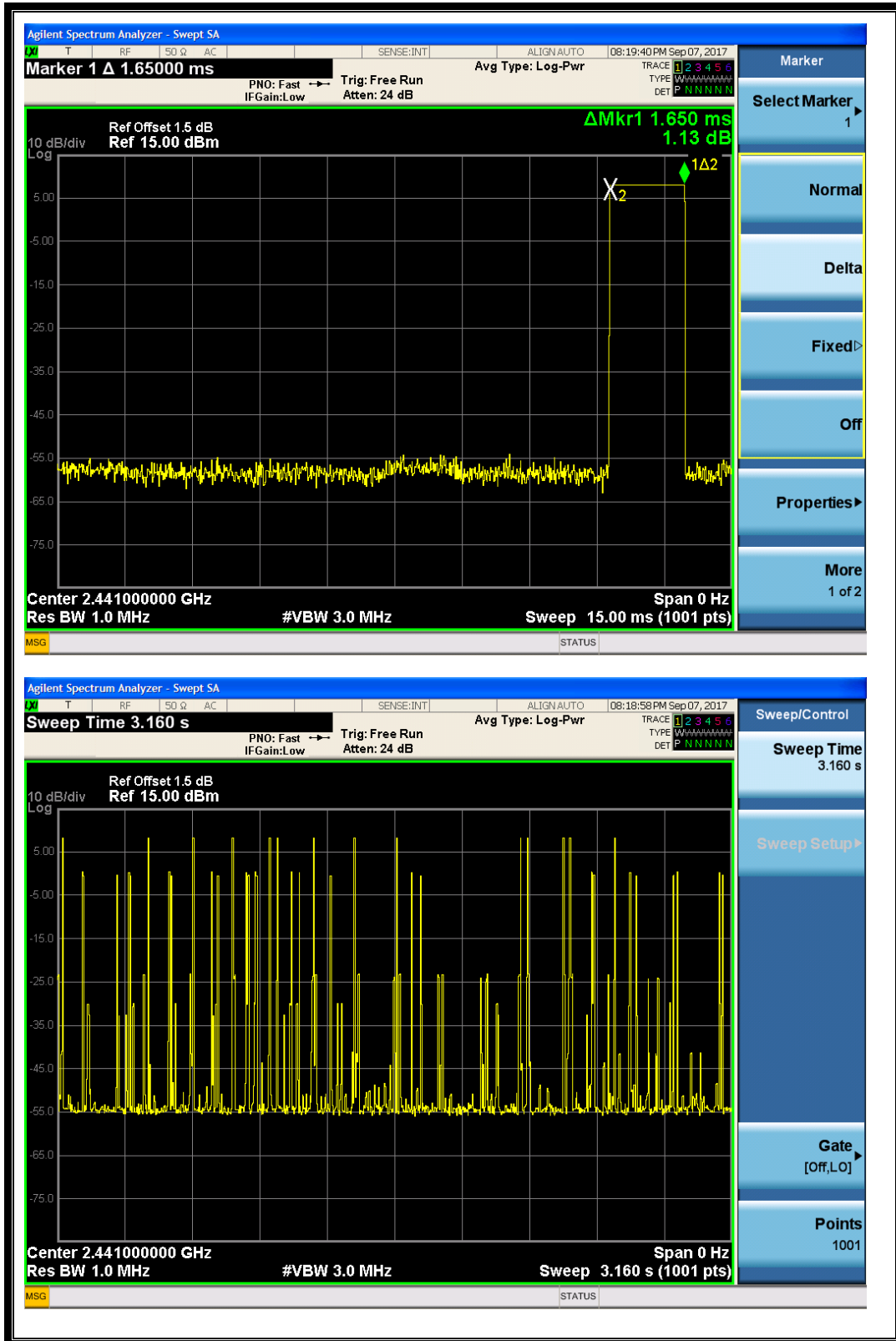

(Plot B: DH3 @ GFSK)

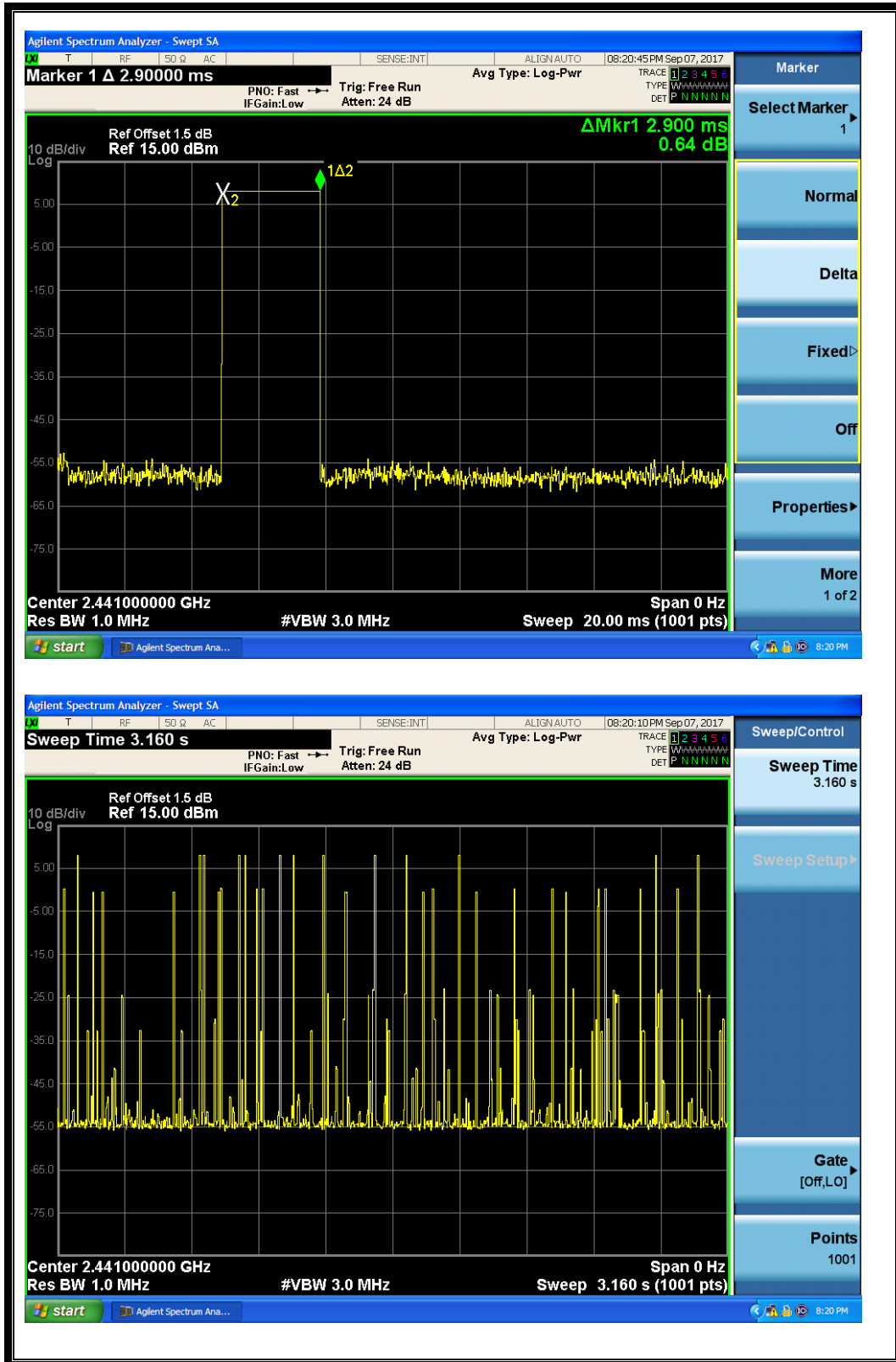

(Plot C: DH5 @ GFSK)



2.6.4.2  $\pi/4$ -DQPSK Mode

A. Test Verdict:

| DH Packet | Pulse Width (msec) | Number of pulse in 3.16 seconds | Average Time of Occupancy in 3.16 seconds (sec) | Average Time of Occupancy in 31.6 seconds (sec) | Limit (sec) | Verdict |
|-----------|--------------------|---------------------------------|---|---|-------------|---------|
| DH1       | 0.4                | 31                              | 0.01240   | 0.1240  | 0.4         | PASS    |
| DH3       | 1.64               | 14                              | 0.02296   | 0.2296  |             | PASS    |
| DH5       | 2.91               | 9                               | 0.02619   | 0.2619  |             | PASS    |

B. Test Plots:

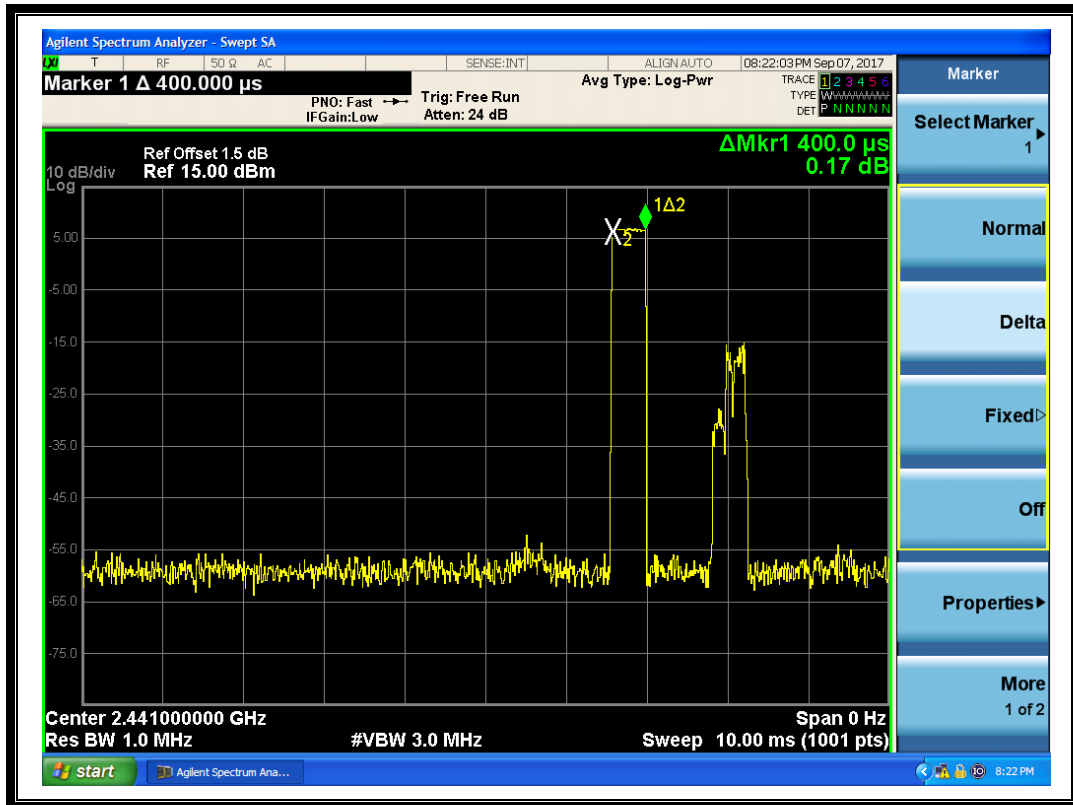

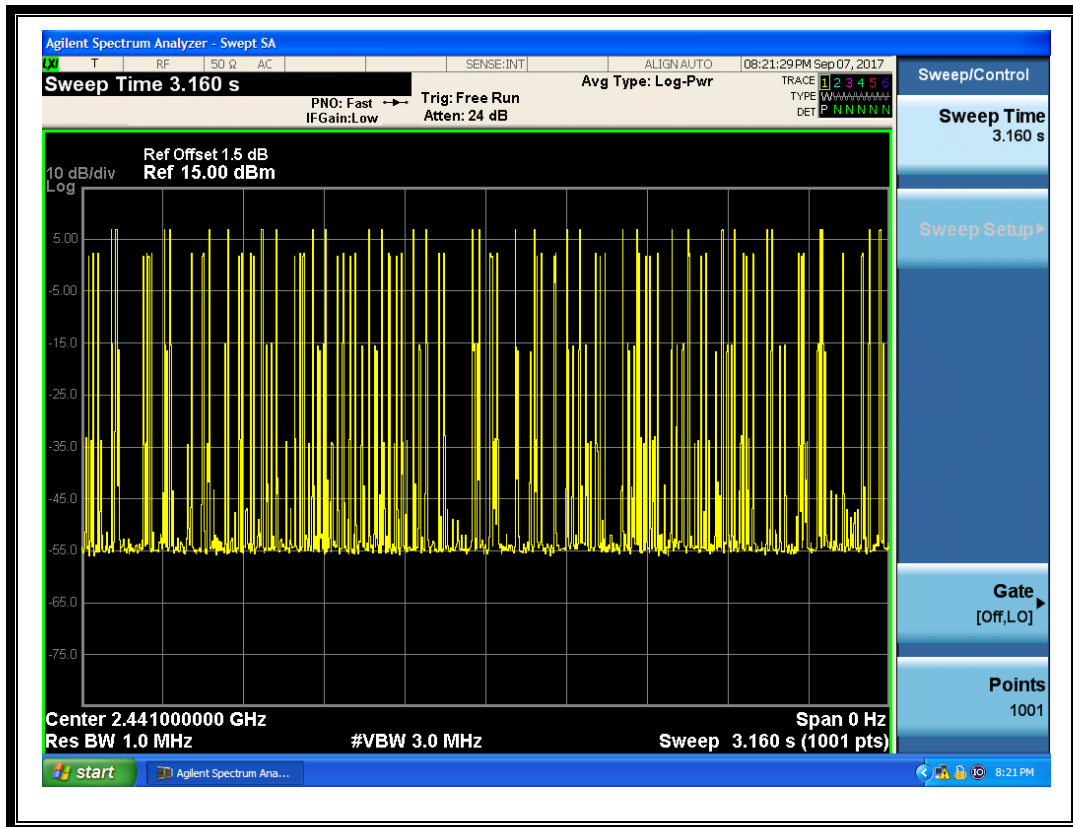

(Plot D: DH1 @  $\pi/4$ -DQPSK)



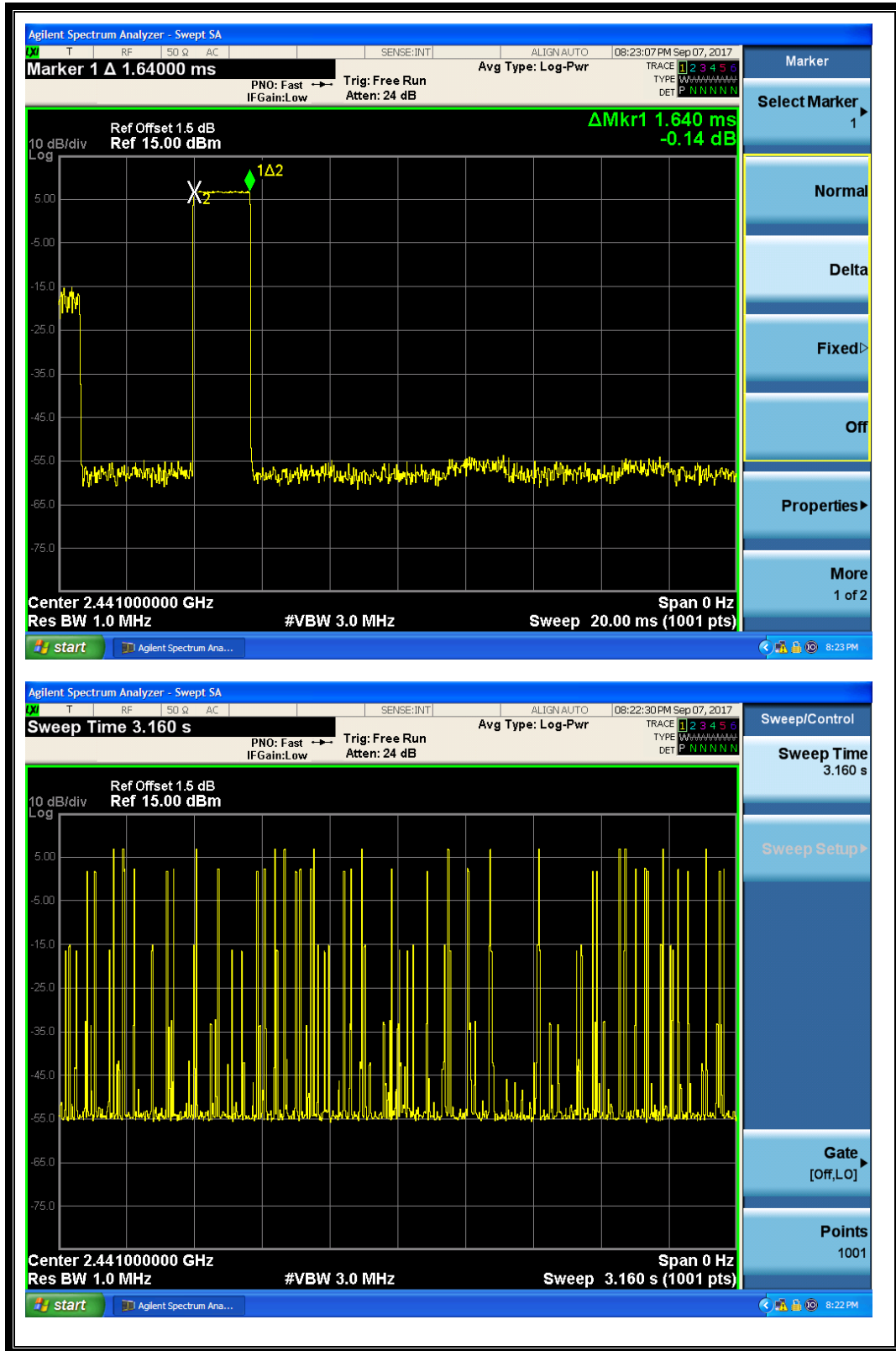

(Plot E: DH3 @  $\pi/4$ -DQPSK)

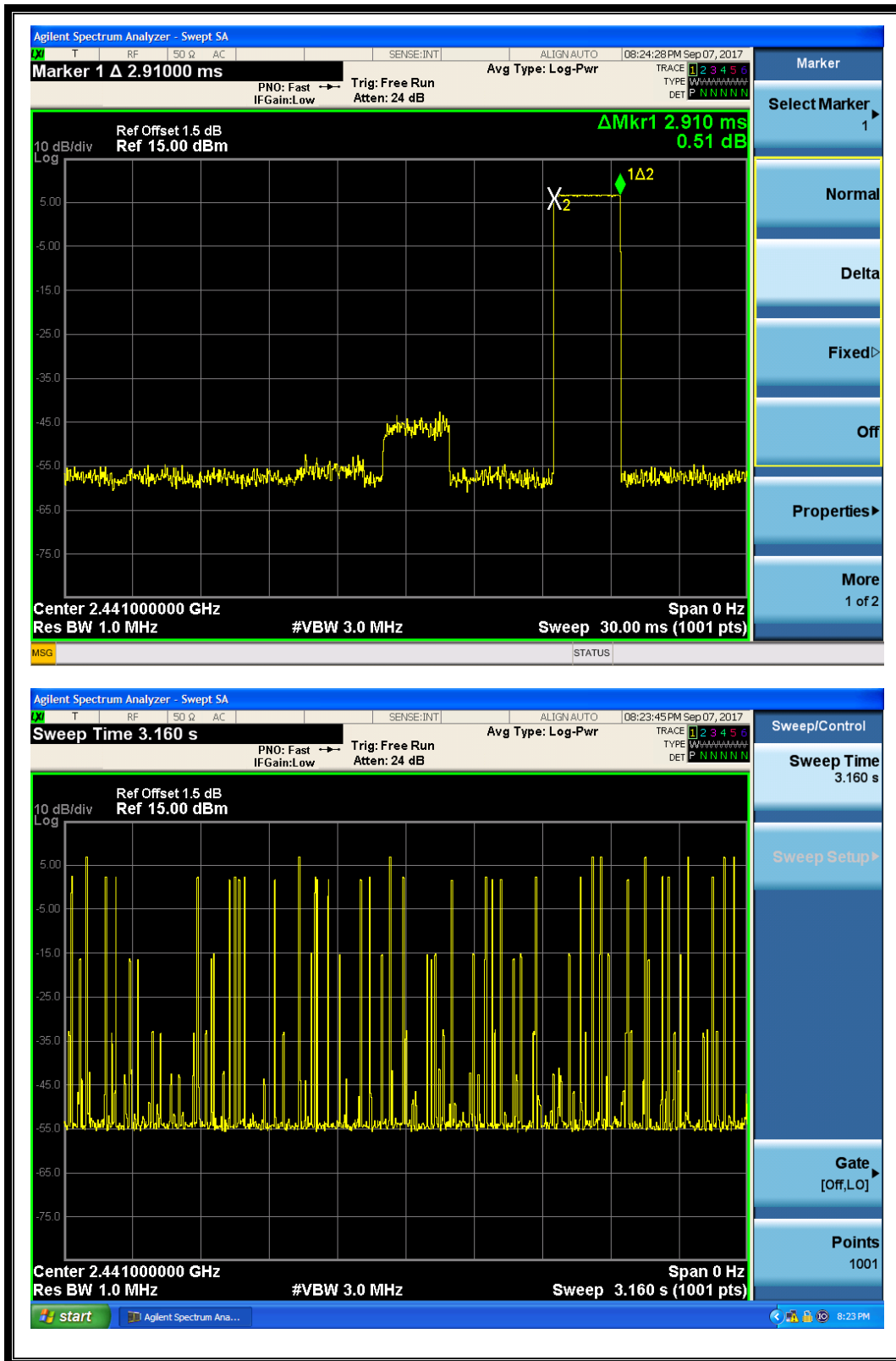

(Plot F: DH5 @  $\pi/4$ -DQPSK)



2.6.4.3 8-DPSK mode

A. Test Verdict:

| DH Packet | Pulse Width (msec) | Number of pulse in 3.16 seconds | Average Time of Occupancy in 3.16 seconds (sec) | Average Time of Occupancy in 31.6 seconds (sec) | Limit (sec) | Verdict |
|-----------|--------------------|---------------------------------|---|---|-------------|---------|
| DH1       | 0.39               | 31                              | 0.01209   | 0.1209  | 0.4         | PASS    |
| DH3       | 1.64               | 9                               | 0.01476   | 0.1476  |             | PASS    |
| DH5       | 2.91               | 7                               | 0.02037   | 0.2037  |             | PASS    |

B. Test Plots:

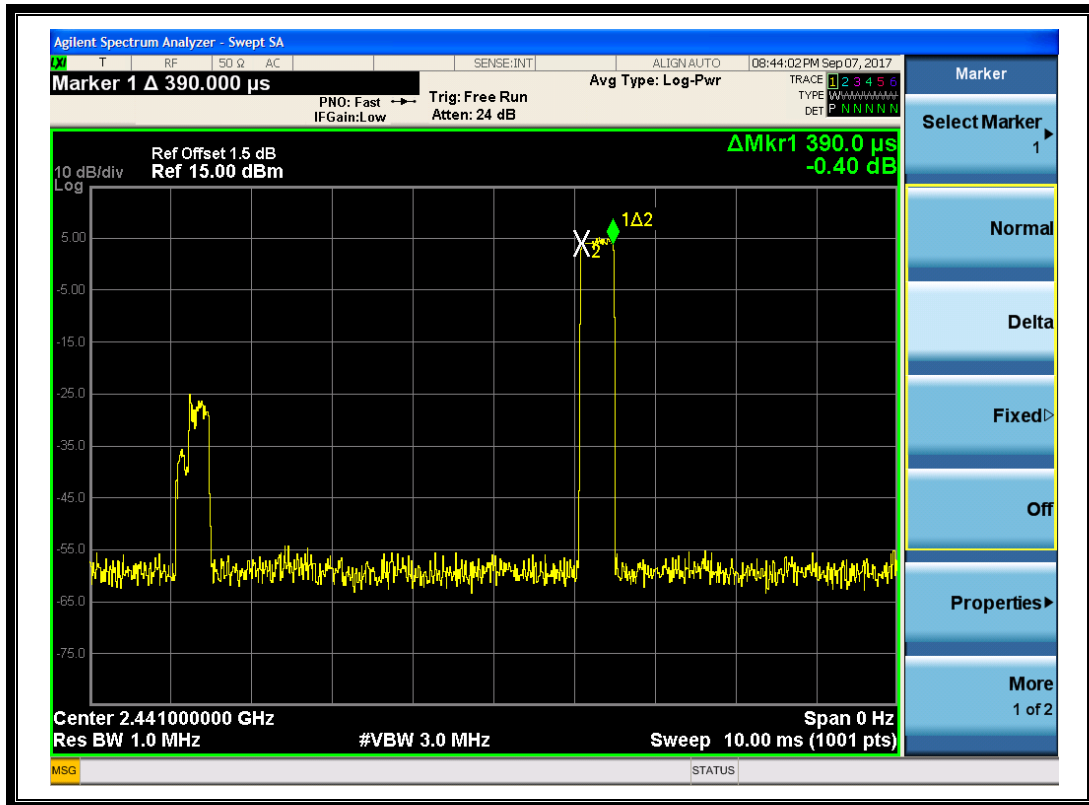



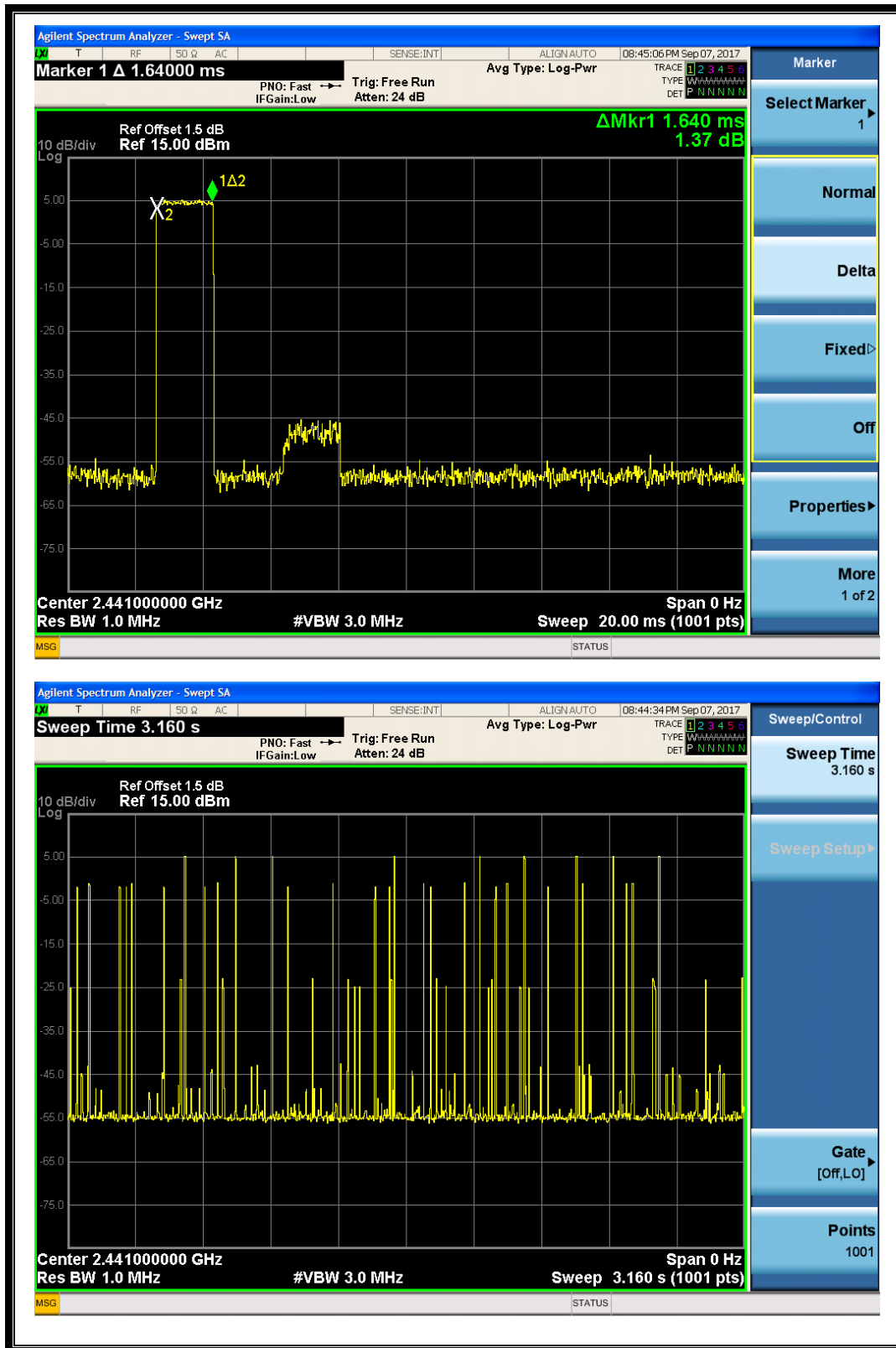

(Plot H: DH3 @ 8-DPSK)

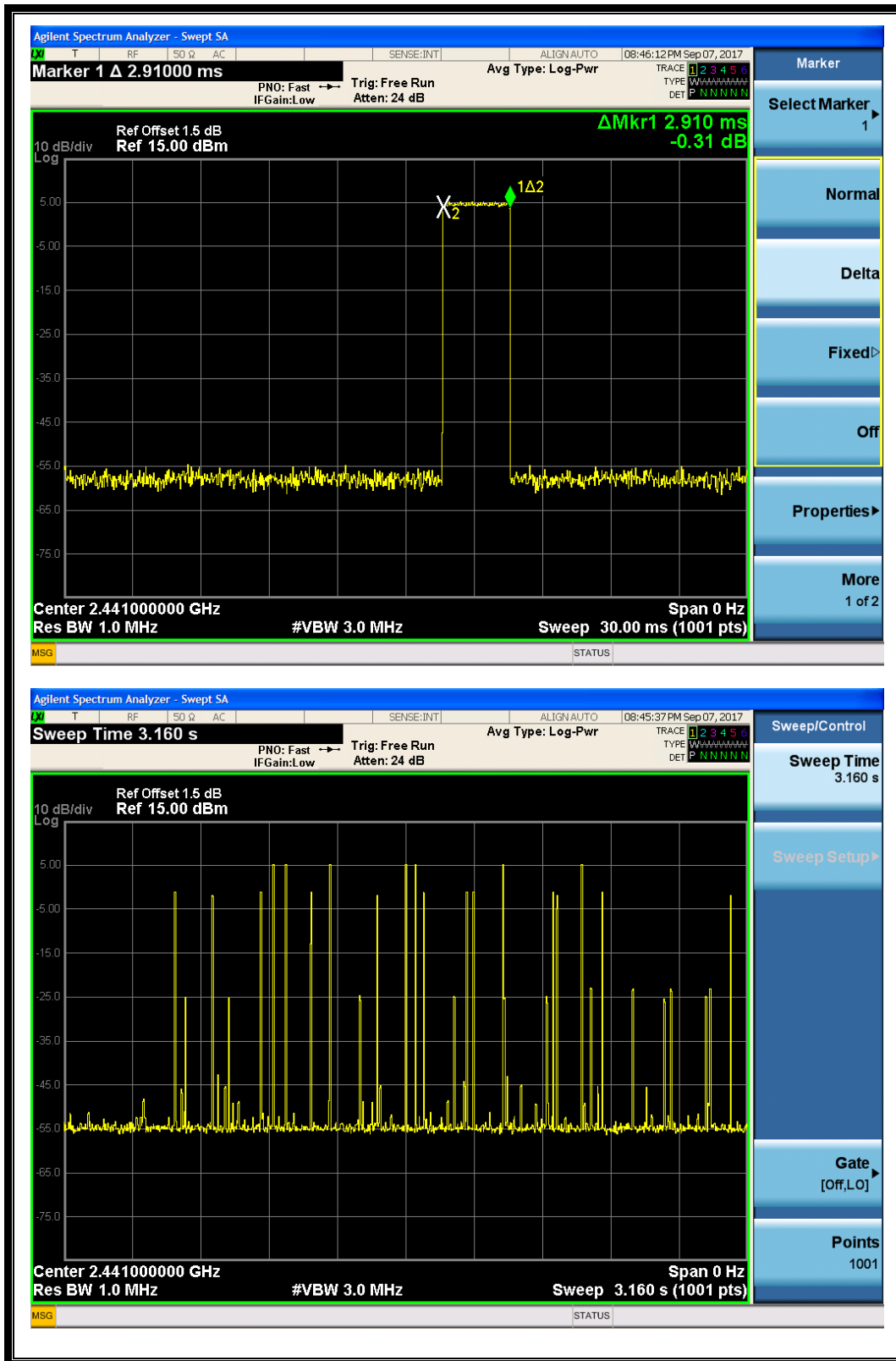

(Plot I: DH5 @ 8-DPSK)

## 2.7 Conducted Spurious Emissions

### 2.7.1 Requirement

According to FCC §15.247(d), in any 100kHz bandwidth outside the frequency band in which the spread spectrum or digitally modulated intentional radiator is operating, the radio frequency power that is produced by the intentional radiator shall be at least 20dB below that in the 100kHz bandwidth within the band that contains the highest level of the desired power, based on either an RF conducted or a radiated measurement.

### 2.7.2 Test Description

#### A. Test Setup:

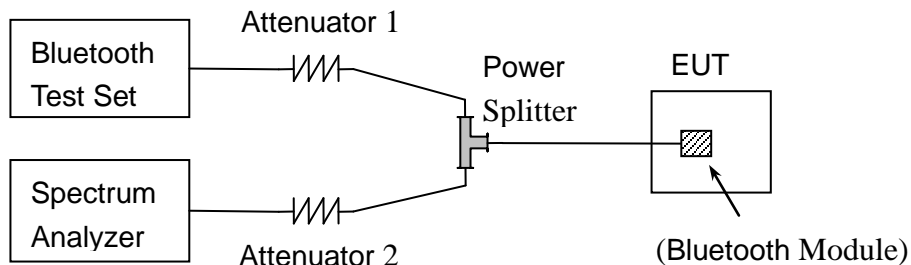

The Bluetooth Module of the EUT is coupled to the Spectrum Analyzer (SA) and the Bluetooth Test Set with Attenuators through the Power Splitter; the RF load attached to the EUT antenna terminal is 50Ohm;the path loss as the factor is calibrated to correct the reading. During the measurement, the Bluetooth Module of the EUT is activated and controlled by the SS, and is set to operate under test mode transmitting 339 bytes DH5 packages at maximum power.

#### B. Equipments List:

Please reference ANNEX A(1.5).

### 2.7.3 Test Procedure

Use the following spectrum analyzer settings:

Span = wide enough to capture the peak level of the in-band emission and all spurious emissions (e.g., harmonics) from the lowest frequency generated in the EUT up through the 10th harmonic.

Typically, several plots are required to cover this entire span.

RBW = 100 kHz

VBW ≥ RBW

Sweep = auto

Detector function = peak

Trace = max hold

Allow the trace to stabilize.



**2.7.4 Test Result**

The Bluetooth Module operates at hopping-off test mode. The measurement frequency range is from 30MHz to the 10th harmonic of the fundamental frequency. The lowest, middle and highest channels are tested to verify the spurious emissions.

**2.7.4.1 GFSK Mode**

**A. Test Verdict:**

| Channel | Frequency (MHz) | Measured Max. Out of Band Emission (dBm) | Refer to Plot | Limit (dBm)   |                         | Verdict |
|---------|-----------------|--|---------------|---------------|-------------------------|---------|
|         |                 |  |               | Carrier Level | Calculated -20dBc Limit |         |
| 0       | 2402            | -43.27                                   | Plot A        | 6.48          | -13.52                  | PASS    |
| 39      | 2441            | -45.13                                   | Plot B        | 7.76          | -12.24                  | PASS    |
| 78      | 2480            | -45.63                                   | Plot C        | 8.28          | -11.72                  | PASS    |

**B. Test Plots:**

**Note:** the power of the Module transmitting frequency should be ignored.

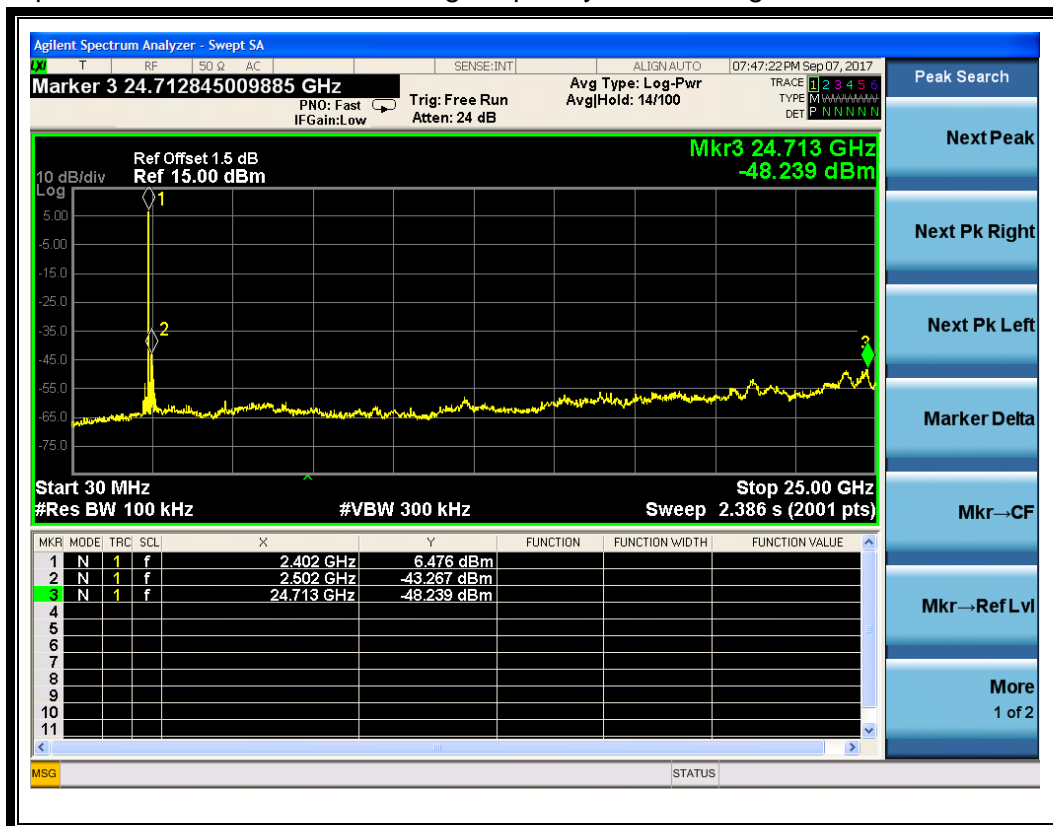

(Plot A: Channel = 0, 30MHz to 25GHz @ GFSK Mode)





(Channel = 0, Band edge @ GFSK Mode)



(Channel = 0, Band edge with hopping on @ GFSK Mode)

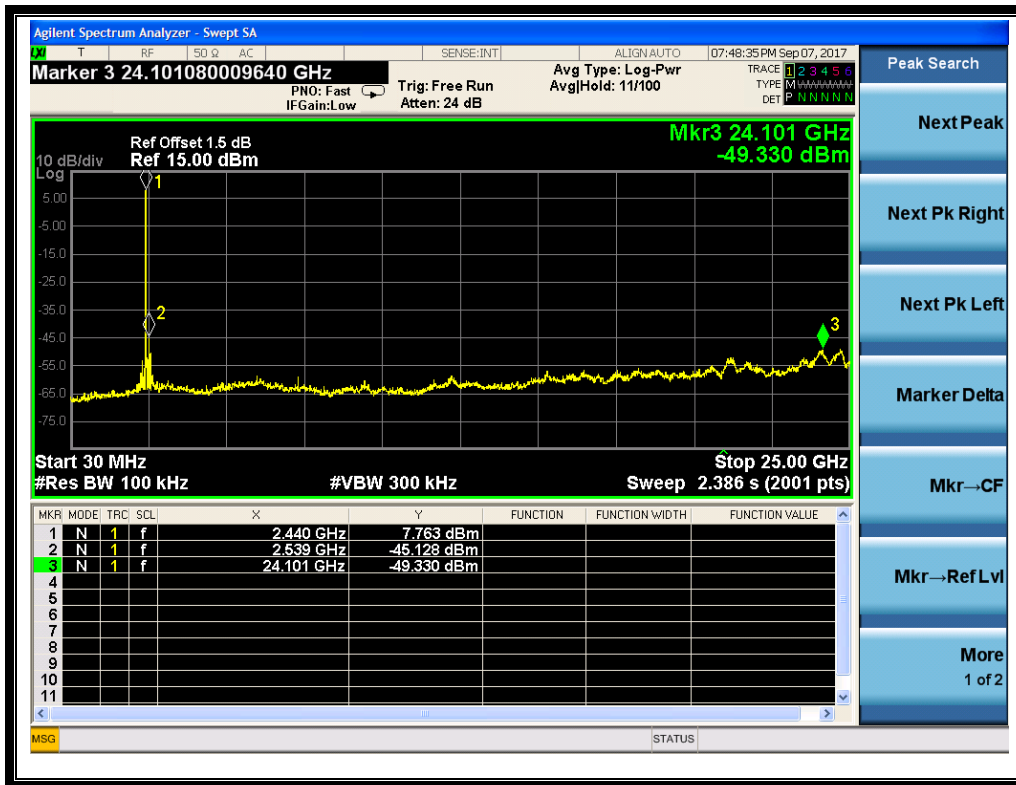

(Plot B: Channel = 39, 30MHz to 25GHz @ GFSK Mode)

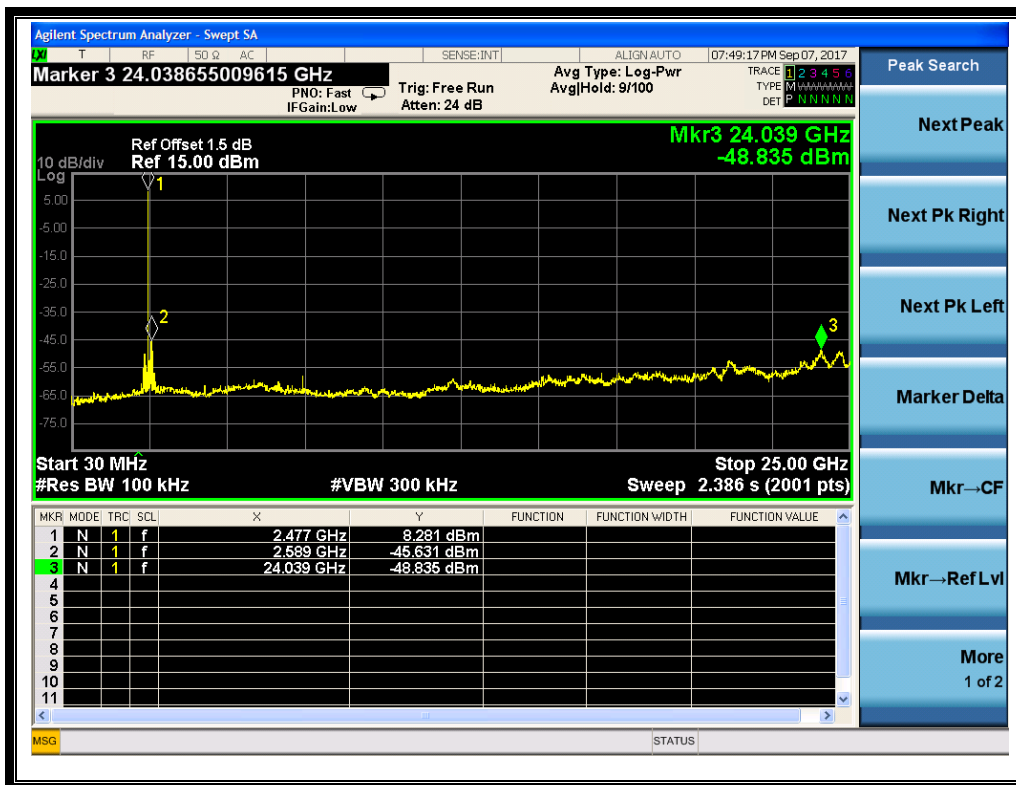

(Plot C: Channel = 78, 30MHz to 25GHz @ GFSK Mode)



(Channel = 78, Band edge @ GFSK Mode)



(Channel = 78, Band edge with hopping on @ GFSK Mode)



2.7.4.2  $\pi/4$ -DQPSK Mode

A. Test Verdict:

| Channel | Frequency (MHz) | Measured Max. Out of Band Emission (dBm) | Refer to Plot | Limit (dBm)   |                         | Verdict |
|---------|-----------------|--|---------------|---------------|-------------------------|---------|
|         |                 |  |               | Carrier Level | Calculated -20dBc Limit |         |
| 0       | 2402            | -46.62                                   | Plot D        | 1.71          | -18.29                  | PASS    |
| 39      | 2441            | -46.31                                   | Plot E        | 3.75          | -16.25                  | PASS    |
| 78      | 2480            | -49.14                                   | Plot F        | 4.38          | -15.62                  | PASS    |

B. Test Plots:

Note: the power of the Module transmitting frequency should be ignored.

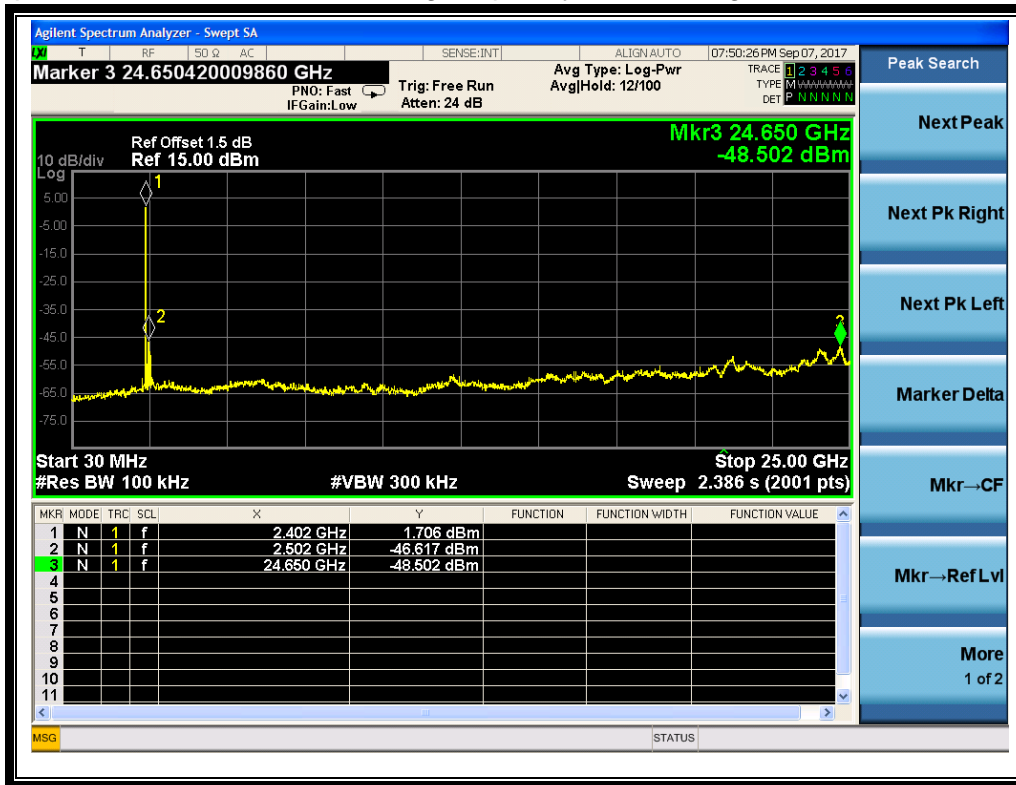

(Plot D: Channel = 0, 30MHz to 25GHz @ $\pi/4$ -DQPSK)

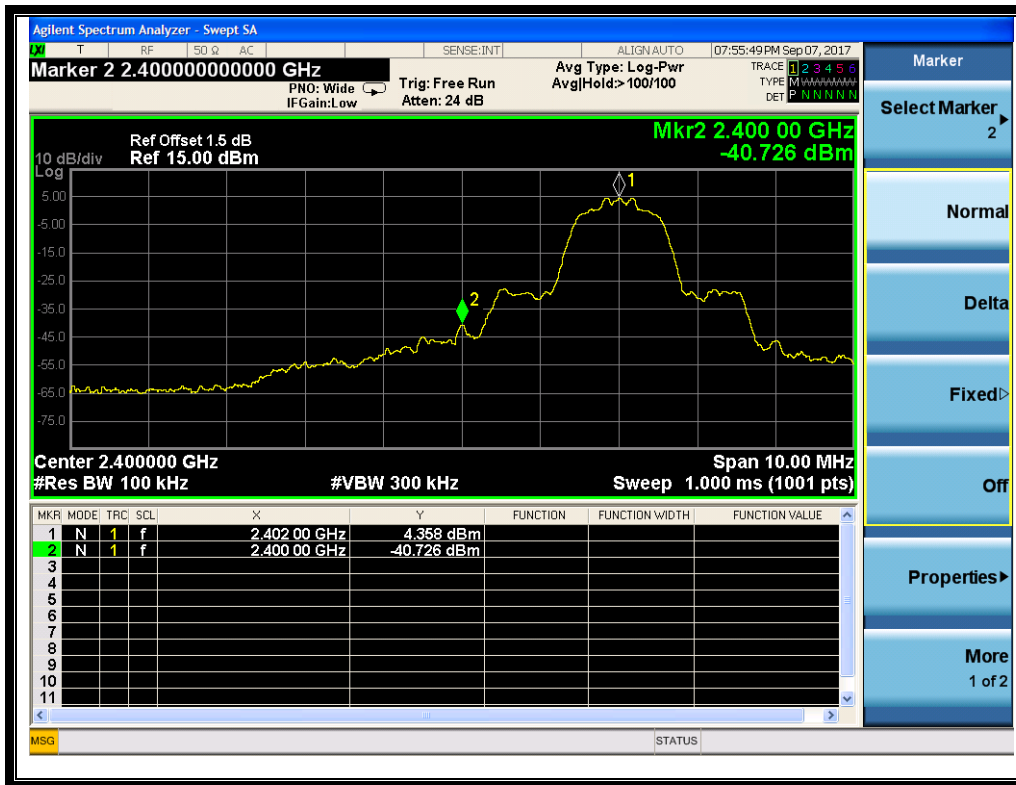

(Channel = 0, Band edge @ $\pi/4$ -DQPSK)



(Channel = 0, Band edge with hopping on @ $\pi/4$ -DQPSK)

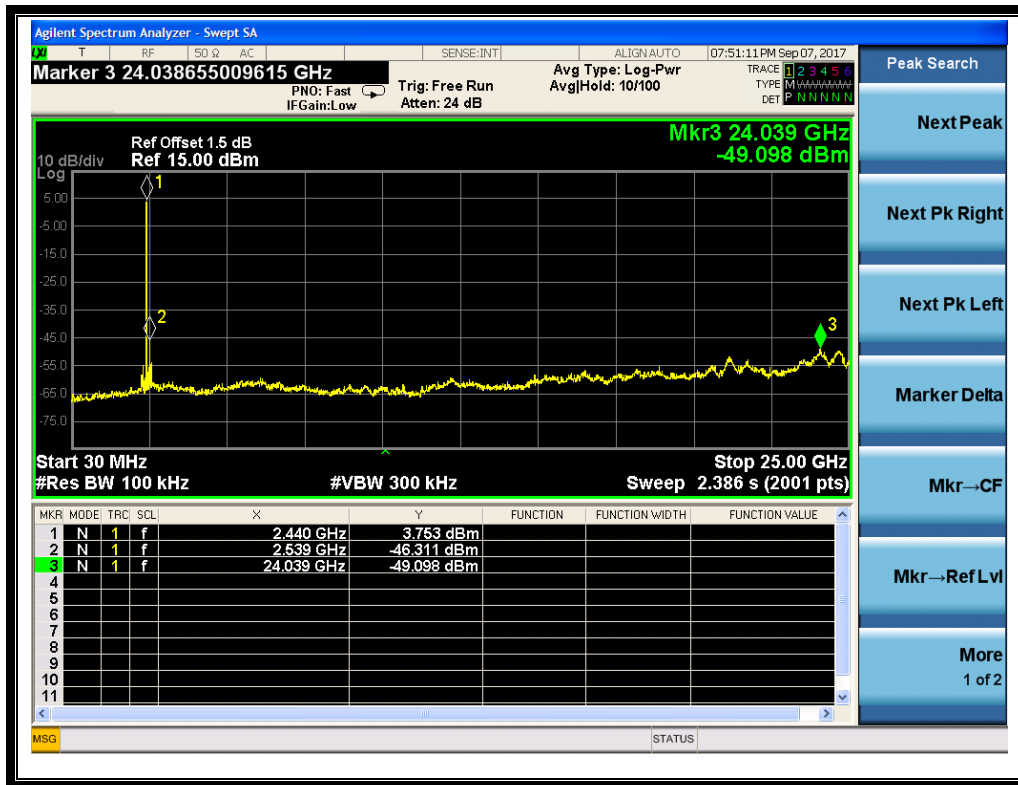

(Plot E: Channel = 39, 30MHz to 25GHz @  $\pi/4$ -DQPSK)

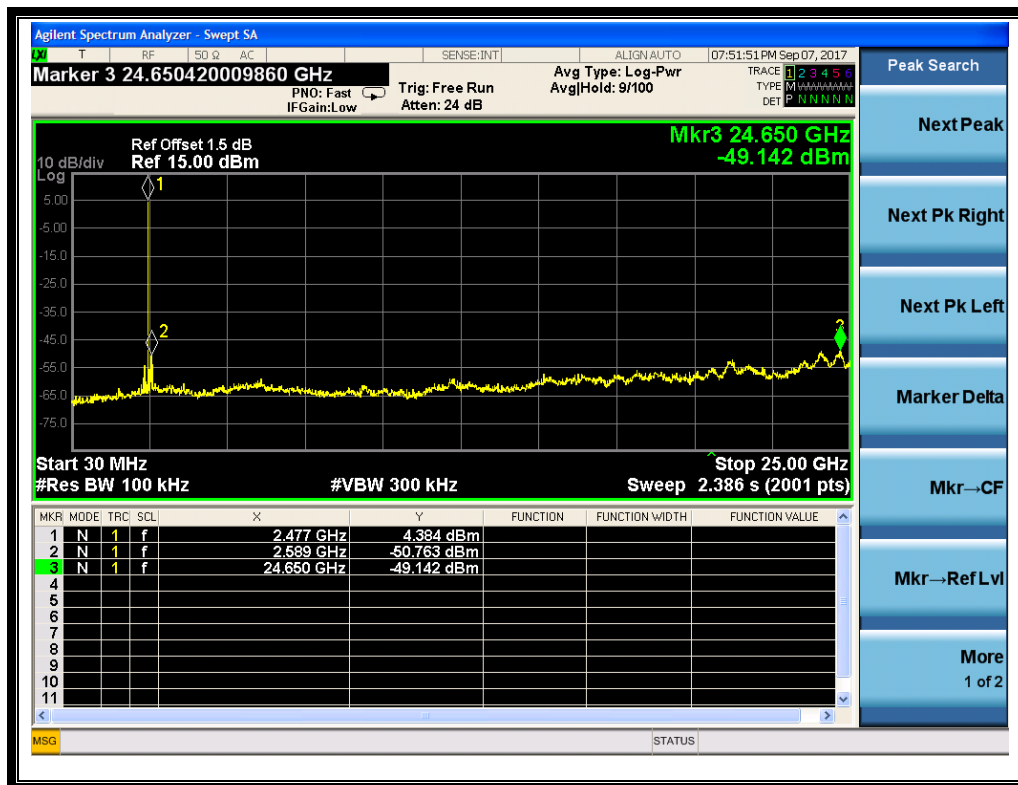

(Plot F: Channel = 78, 30MHz to 25GHz @  $\pi/4$ -DQPSK)



(Channel = 78, Band edge @  $\pi/4$ -DQPSK)



(Channel = 78, Band edge with hopping on @  $\pi/4$ -DQPSK)





2.7.4.3 8-DPSK Mode

A. Test Verdict:

| Channel | Frequency (MHz) | Measured Max. Out of Band Emission (dBm) | Refer to Plot | Limit (dBm)   |                         | Verdict |
|---------|-----------------|--|---------------|---------------|-------------------------|---------|
|         |                 |  |               | Carrier Level | Calculated -20dBc Limit |         |
| 0       | 2402            | -47.69                                   | Plot G        | 3.76          | -16.24                  | PASS    |
| 39      | 2441            | -47.15                                   | Plot H        | 5.62          | -14.38                  | PASS    |
| 78      | 2480            | -49.09                                   | Plot I        | 4.05          | -15.95                  | PASS    |

B. Test Plots:

Note: the power of the Module transmitting frequency should be ignored.

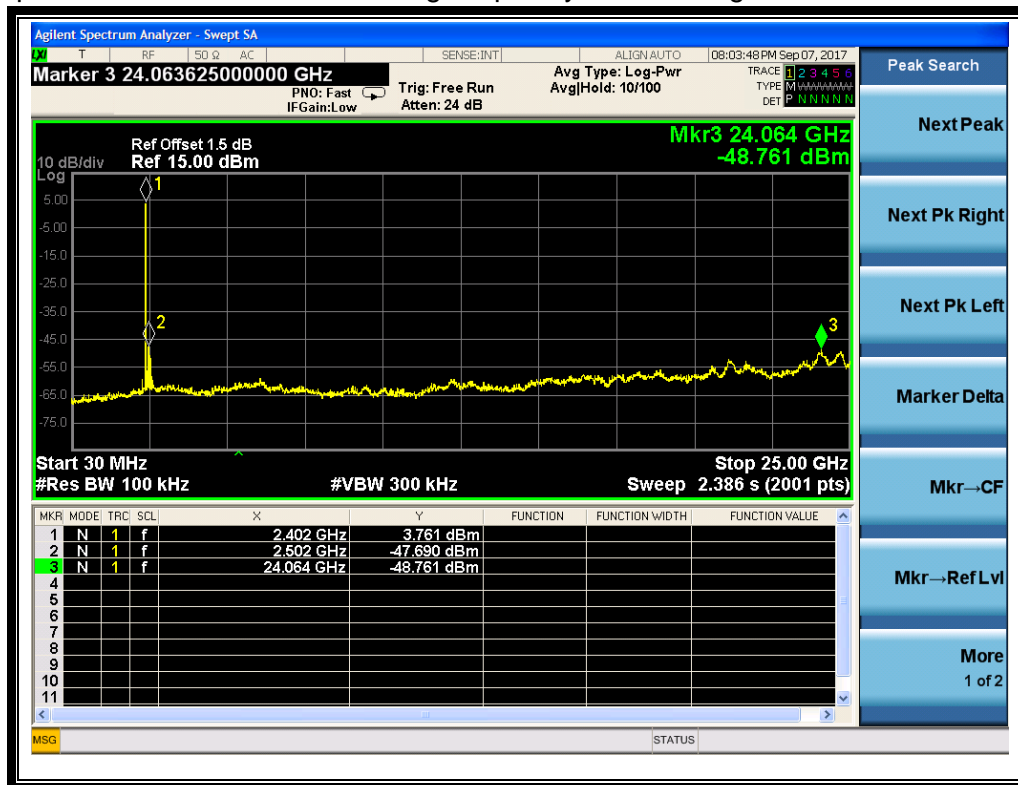

(Plot G: Channel = 0, 30MHz to 25GHz @ 8-DPSK)



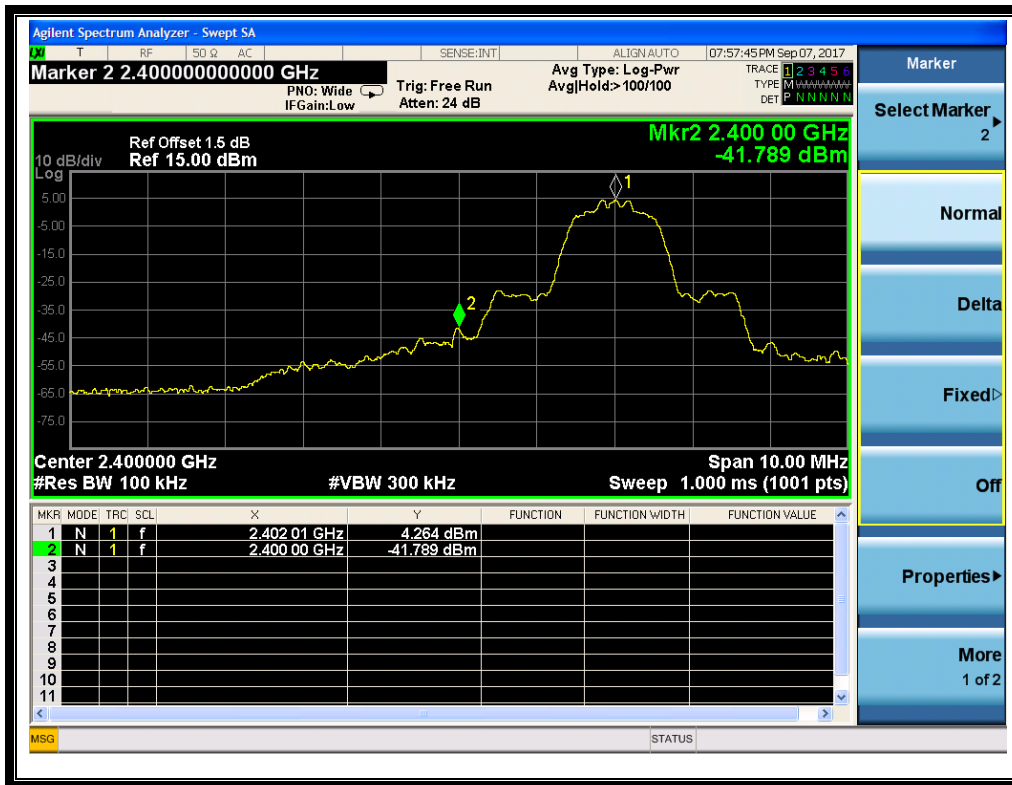

(Channel = 0, Band edge @ 8-DPSK)



(Channel = 0, Band edge with hopping on @ 8-DPSK)

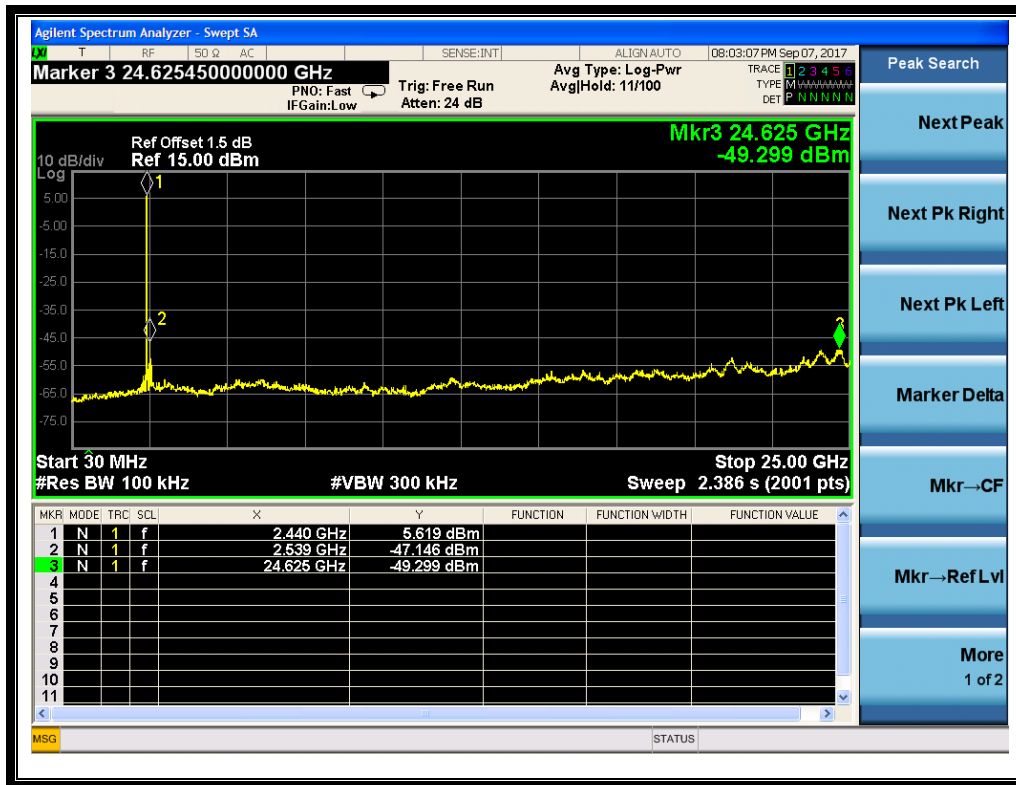

(Plot H: Channel = 39, 30MHz to 25GHz @ 8-DPSK)

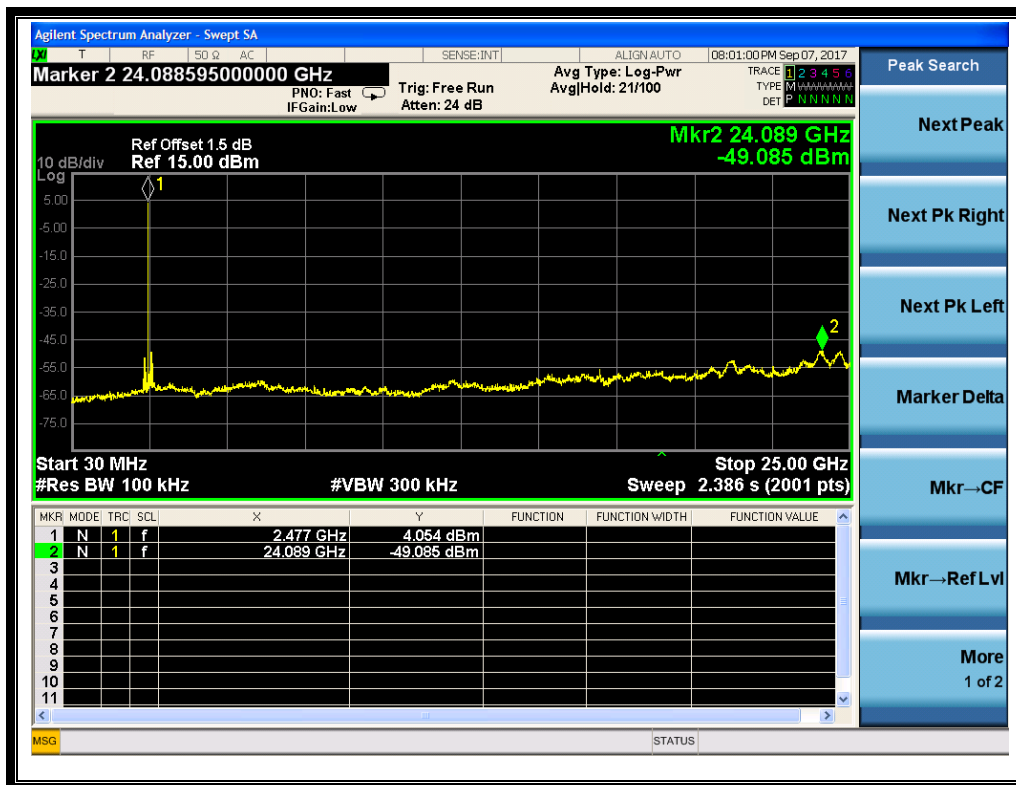

(Plot I: Channel = 78, 30MHz to 25GHz @ 8-DPSK)



(Plot I.1:Channel = 78, Band edge @ 8-DPSK)



(Plot I.1:Channel = 78, Band edge with hopping on @ 8-DPSK)

## 2.8 Restricted Frequency Bands

### 2.8.1 Requirement

According to FCC section 15.247(d), in any 100kHz bandwidth outside the frequency band in which the spread spectrum or digitally modulated intentional radiator is operating, the radio frequency power that is produced by the intentional radiator shall be at least 20dB below that in the 100kHz bandwidth within the band that contains the highest level of the desired power, In addition, radiated emissions which fall in the restricted bands, as defined in 15.205(a), must also comply with the radiated emission limits specified in 15.209(a).

### 2.8.2 Test Description

#### A. Test Setup:

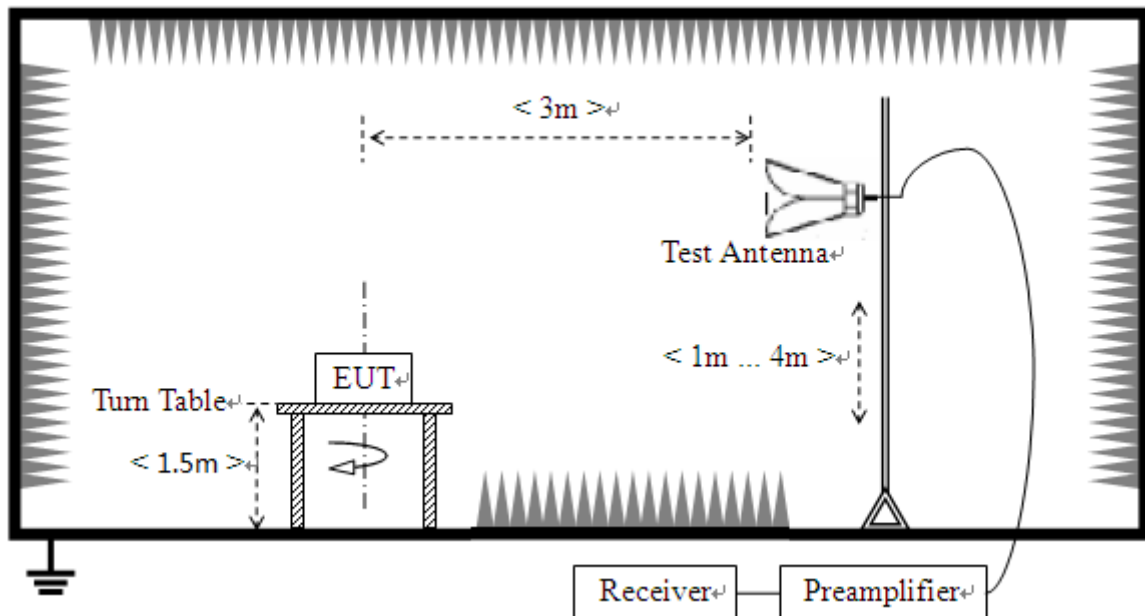

The EUT is located in a 3m Semi-Anechoic Chamber; the antenna factors, cable loss and so on of the site as factors are calculated to correct the reading. During the measurement, the Bluetooth Module of the EUT is activated and controlled by the Bluetooth Service Supplier (SS) via a Common Antenna, and is set to operate under non hopping-on test mode transmitting 339 bytes DH5, 679 bytes 2DH5 and 1021 bytes 3DH5 packages at maximum power.

For the Test Antenna:

Horn Test Antenna is 3m away from the EUT. Test Antenna height is varied from 1m to 4m above the ground to determine the maximum value of the field strength.

**B. Equipments List:**

Please reference ANNEX A(1.5).

**2.8.3 Test Procedure**

Span = wide enough to fully capture the emission being measured

RBW = 1 MHz for  $f \geq 1\text{GHz}$ , 100 KHz for  $f < 1\text{GHz}$

VBW = 3 MHz for peak and 10Hz for average

Sweep = auto

Detector function = peak

Trace = max hold

Allow the trace to stabilize.

**2.8.4 Test Result**

The lowest and highest channels are tested to verify Restricted Frequency Bands.

The measurement results are obtained as below:

$$E \text{ [dB}\mu\text{V/m]} = U_R + A_T + A_{\text{Factor}} \text{ [dB]}; A_T = L_{\text{Cable loss}} \text{ [dB]} - G_{\text{preamp}} \text{ [dB]}$$

AT: Total correction Factor except Antenna

UR: Receiver Reading

Gpreamp: Preamplifier Gain

AFactor: Antenna Factor at 3m

**Note:** Restricted Frequency Bands were performed when antenna was at vertical and horizontal polarity, and only the worse test condition (vertical) was recorded in this test report.

**2.8.4.1 GFSK Mode****A. Test Verdict:**

| Channel | Frequency (MHz) | Detector | Receiver Reading   | $A_T$ (dB) | $A_{\text{Factor}}$ (dB@3m) | Max. Emission E (dB $\mu$ V/m) | Limit (dB $\mu$ V/m) | Verdict |
|---------|-----------------|----------|--------------------|------------|-----------------------------|--------------------------------|----------------------|---------|
|         |                 | PK/ AV   | $U_R$ (dB $\mu$ V) |            |                             |                                |                      |         |
| 0       | 2385.78         | PK       | 45.22              | -33.63     | 32.56                       | 44.15                          | 74                   | Pass    |
| 0       | 2388.79         | AV       | 32.31              | -33.63     | 32.56                       | 31.24                          | 54                   | Pass    |
| 78      | 2484.06         | PK       | 46.89              | -33.18     | 32.50                       | 46.21                          | 74                   | Pass    |
| 78      | 2484.02         | AV       | 35.60              | -33.18     | 32.50                       | 34.92                          | 54                   | Pass    |



B. Test Plots:

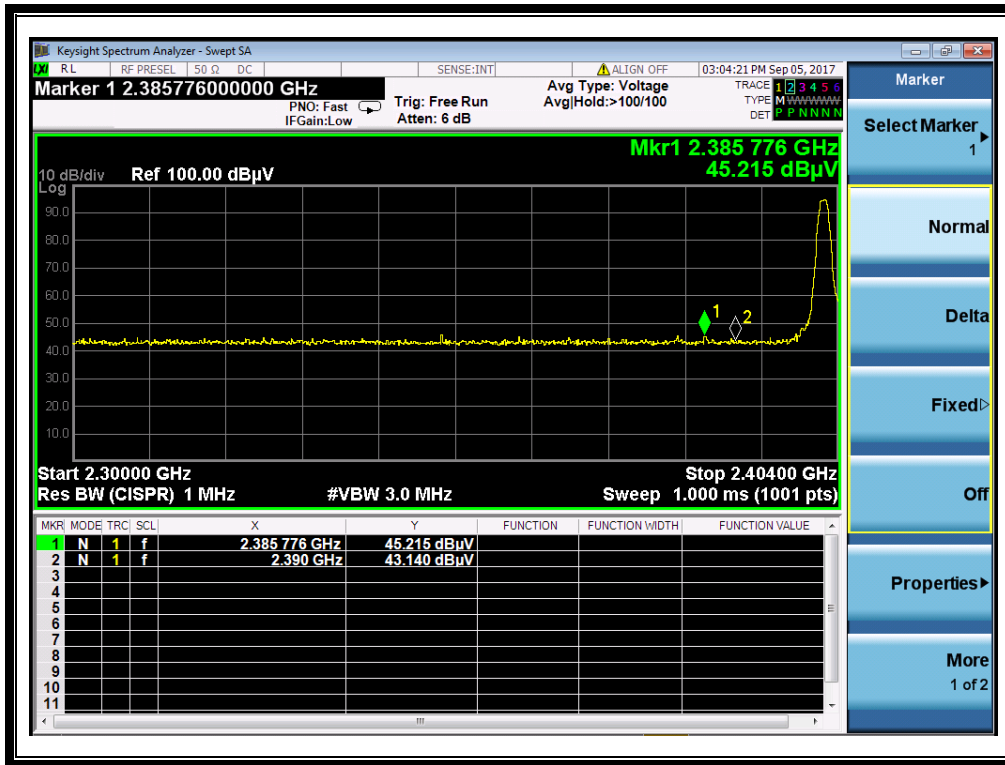

(Plot A1:Channel = 0 PEAK @ GFSK)

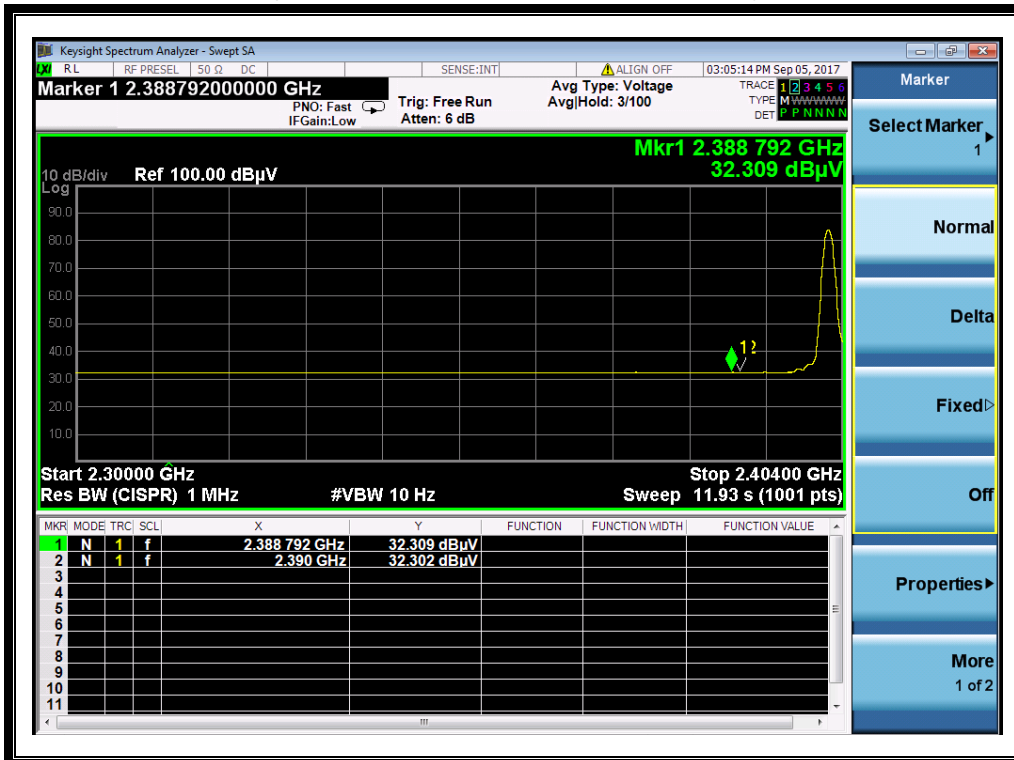

(Plot A2:Channel = 0 AVERAGE @ GFSK)

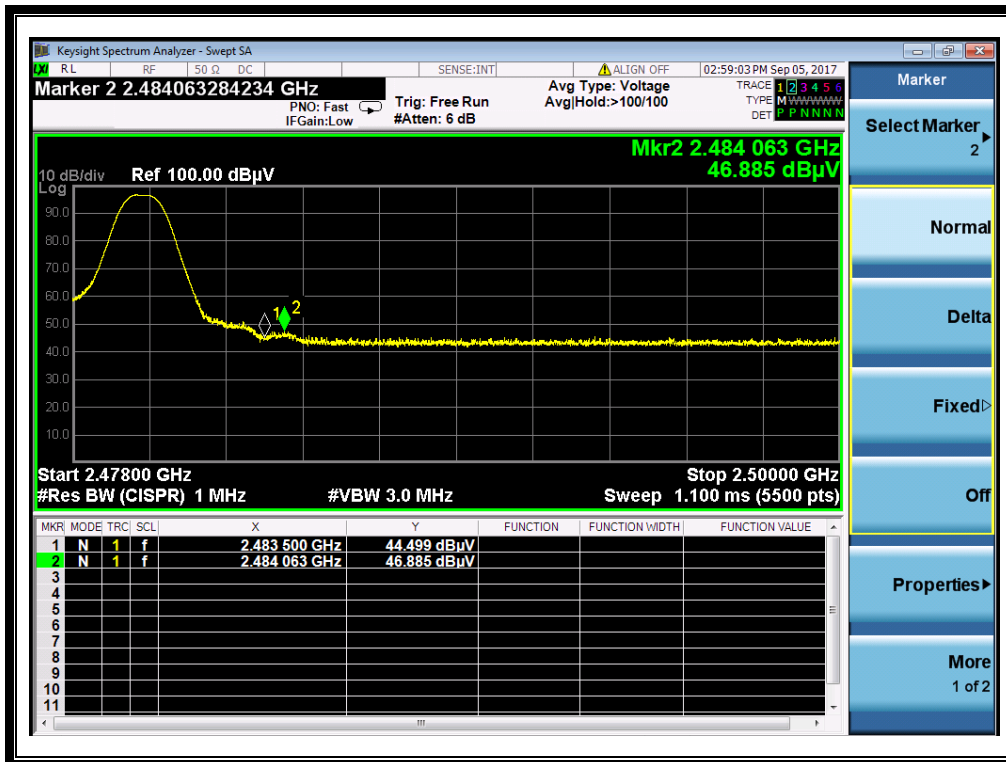

(Plot B1: Channel = 78 PEAK @ GFSK)

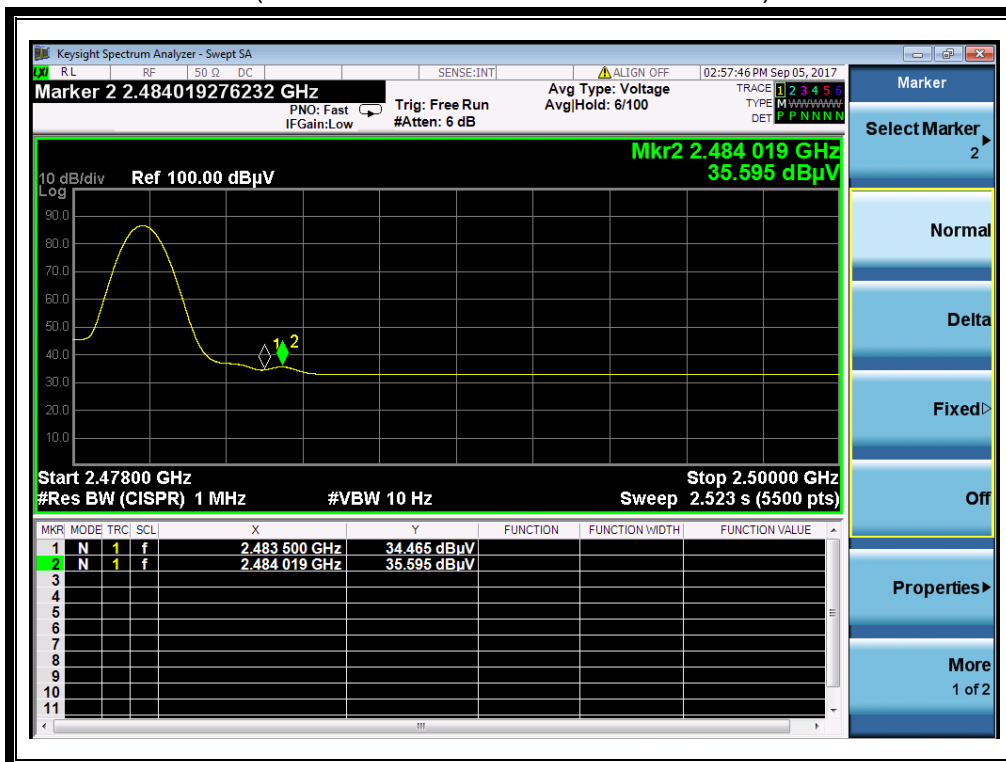

(Plot B2: Channel = 78 AVERAGE @ GFSK)





2.8.4.2  $\pi/4$ -DQPSK Mode

A. Test Verdict:

| Channel | Frequency (MHz) | Detector | Receiver Reading      | A <sub>T</sub> (dB) | A <sub>Factor</sub> (dB@3m) | Max. Emission E (dBμV/m) | Limit (dBμV/m) | Verdict |
|---------|-----------------|----------|-----------------------|---------------------|-----------------------------|--------------------------|----------------|---------|
|         |                 | PK/ AV   | U <sub>R</sub> (dBuV) |                     |                             |                          |                |         |
| 0       | 2382.34         | PK       | 44.35                 | -33.63              | 32.56                       | 43.28                    | 74             | Pass    |
| 0       | 2387.34         | AV       | 32.31                 | -33.63              | 32.56                       | 31.24                    | 54             | Pass    |
| 78      | 2483.75         | PK       | 45.12                 | -33.18              | 32.5                        | 44.44                    | 74             | Pass    |
| 78      | 2484.07         | AV       | 35.25                 | -33.18              | 32.5                        | 34.57                    | 54             | Pass    |

B. Test Plots:

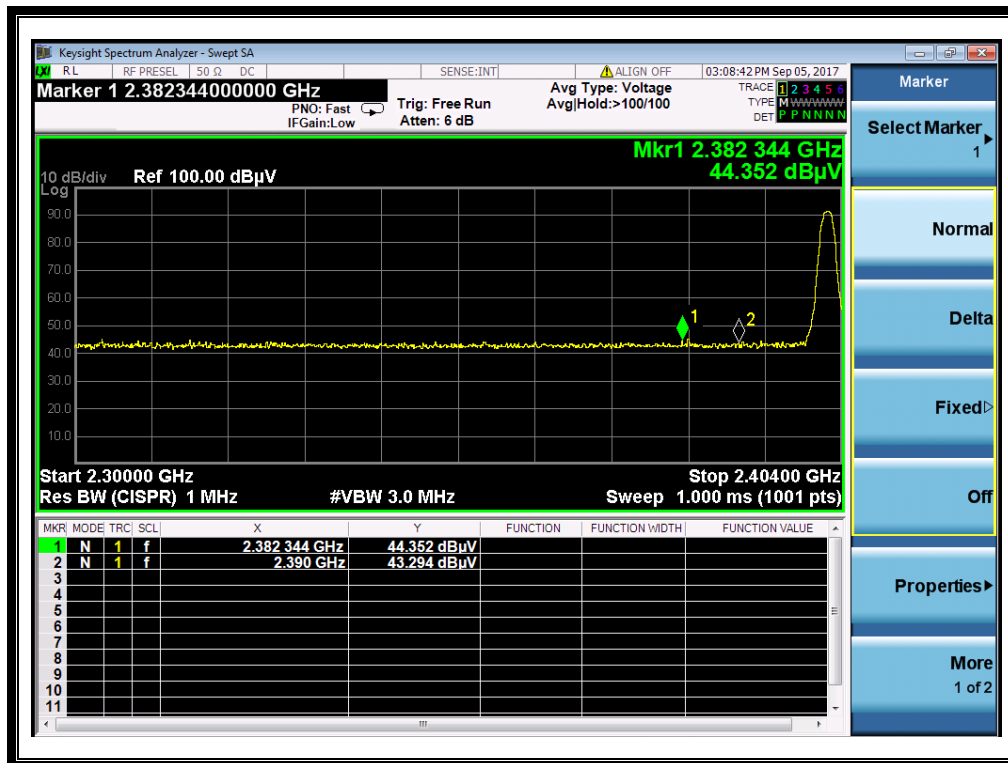

(Plot C1: Channel = 0 PEAK @  $\pi/4$ -DQPSK)



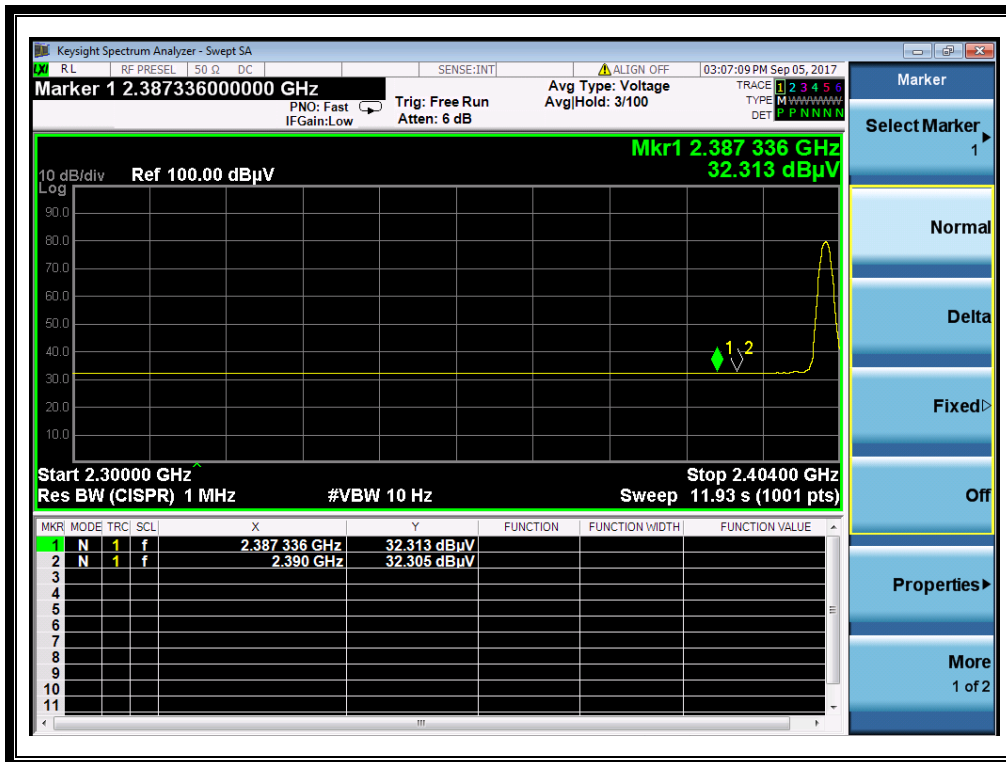

(Plot C2: Channel = 0 AVERAGE @  $\pi/4$ -DQPSK)

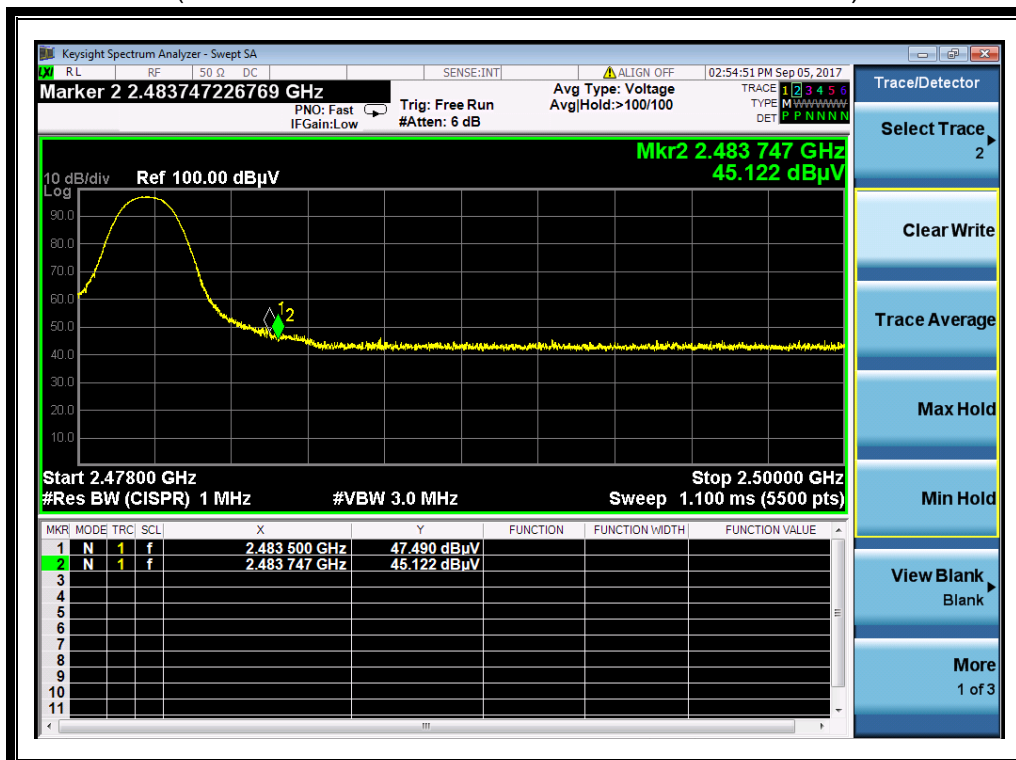

(Plot D1: Channel = 78 PEAK @  $\pi/4$ -DQPSK)

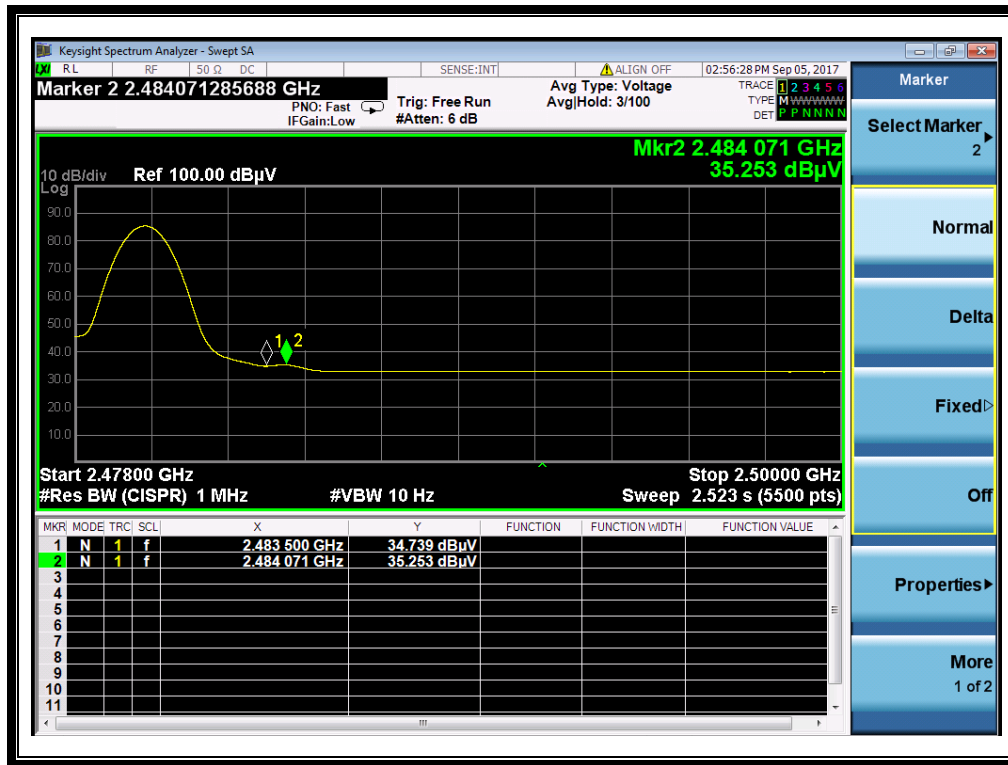

(Plot D2: Channel = 78 AVERAGE @  $\pi/4$ -DQPSK)

### 2.8.4.3 8-DPSK Mode

#### A. Test Verdict:

| Channel | Frequency (MHz) | Detector | Receiver Reading $U_R$ (dBuV) | $A_T$ (dB) | $A_{Factor}$ (dB@3m) | Max. Emission E (dBμV/m) | Limit (dBμV/m) | Verdict |
|---------|-----------------|----------|-------------------------------|------------|----------------------|--------------------------|----------------|---------|
|         |                 | PK/ AV   |                               |            |                      |                          |                |         |
| 0       | 2385.67         | PK       | 44.70                         | -33.63     | 32.56                | 43.63                    | 74             | Pass    |
| 0       | 2387.34         | AV       | 32.33                         | -33.63     | 32.56                | 31.26                    | 54             | Pass    |
| 78      | 2484.19         | PK       | 47.57                         | -33.18     | 32.5                 | 46.89                    | 74             | Pass    |
| 78      | 2484.09         | AV       | 35.24                         | -33.18     | 32.5                 | 34.56                    | 54             | Pass    |



B. Test Plots:

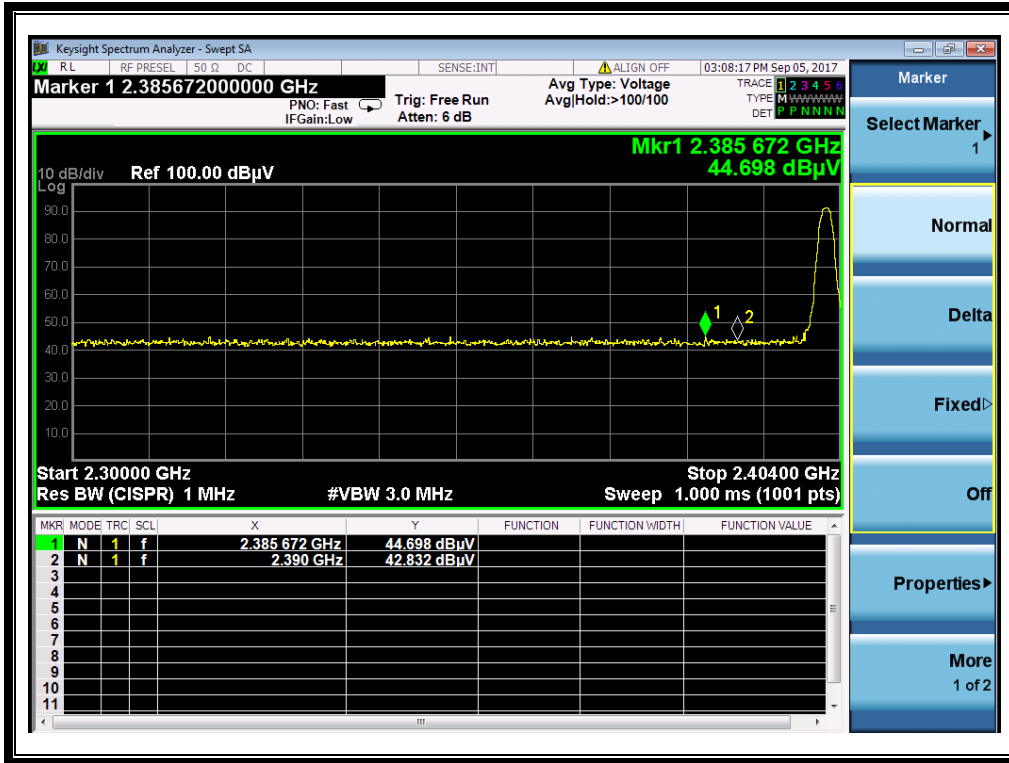

(Plot E1: Channel = 0 PEAK @ 8-DPSK Mode)

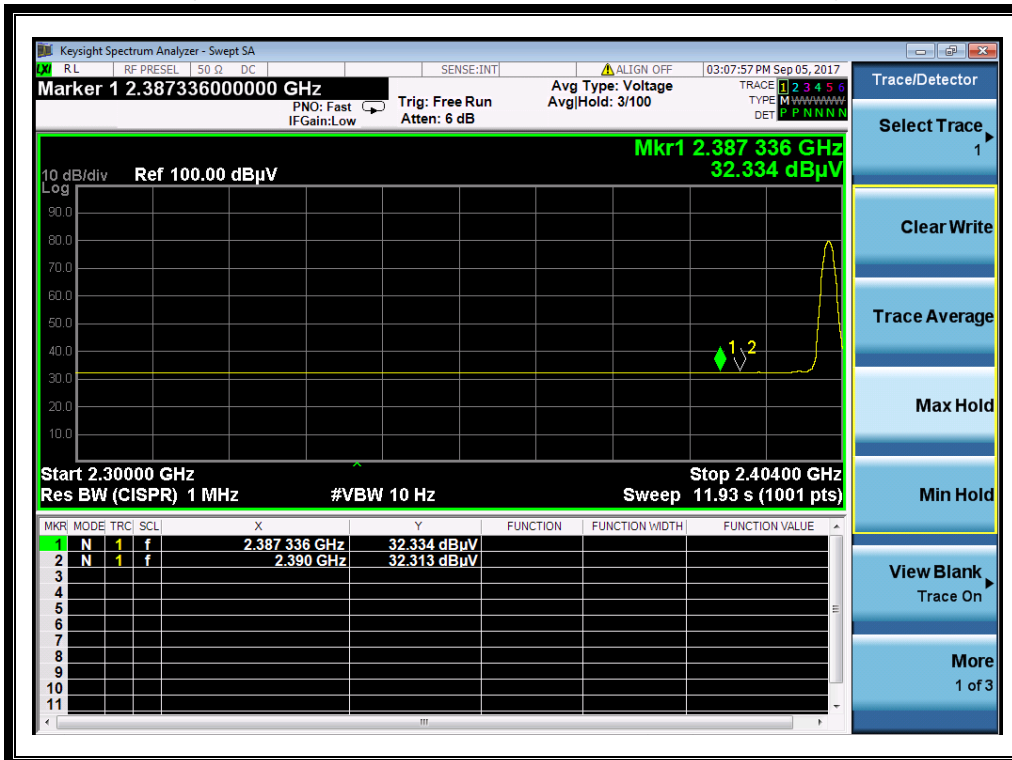

(Plot E2: Channel = 0 AVERAGE @ 8-DPSK Mode)



(Plot F1:Channel = 78 PEAK @ 8-DPSK Mode)

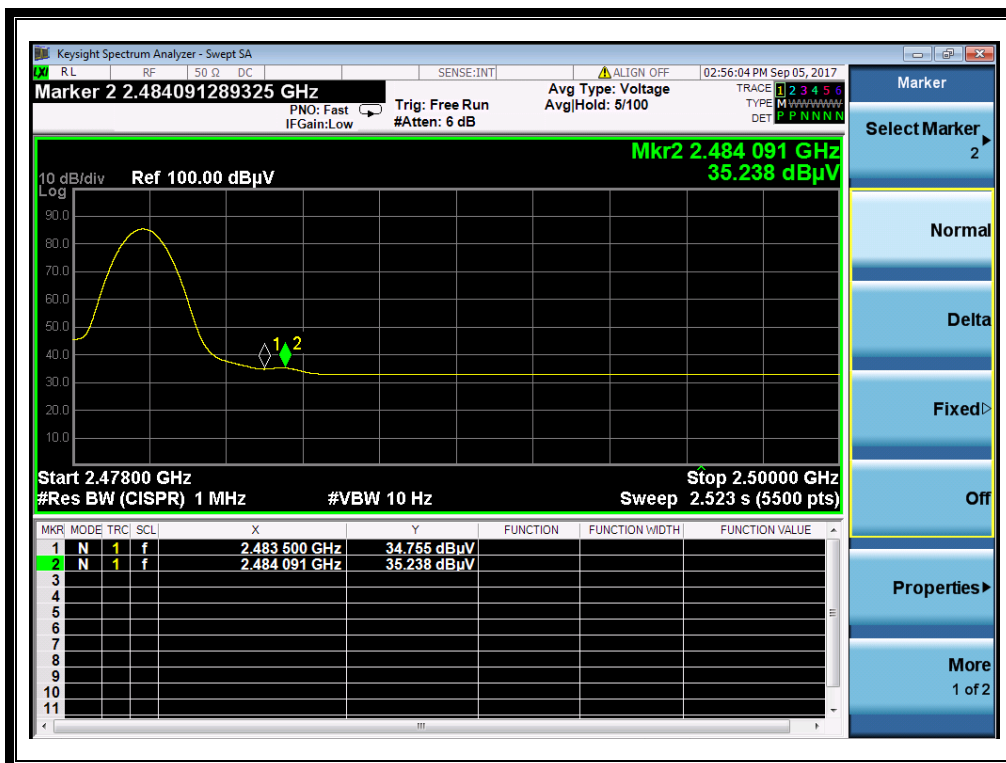

(Plot F2:Channel = 78 AVERAGE @ 8-DPSK Mode)

## 2.9 Conducted Emission

### 2.9.1 Requirement

According to RSS-GEN section 8.8, for an intentional radiator that is designed to be connected to the public utility (AC) power line, the radio frequency voltage that is conducted back onto the AC power line on any frequency within the band 150kHz to 30MHz shall not exceed the limits in the following table, as measured using a 50 $\mu$ H/50 $\Omega$  line impedance stabilization network (LISN).

| Frequency range (MHz) | Conducted Limit (dB $\mu$ V) |          |
|-----------------------|------------------------------|----------|
|                       | Quai-peak                    | Average  |
| 0.15 - 0.50           | 66 to 56                     | 56 to 46 |
| 0.50 - 5              | 56                           | 46       |
| 5- 30                 | 60                           | 50       |

#### NOTE:

- The lower limit shall apply at the band edges.
- The limit decreases linearly with the logarithm of the frequency in the range 0.15 - 0.50MHz.

### 2.9.2 Test Description

#### A. Test Setup:

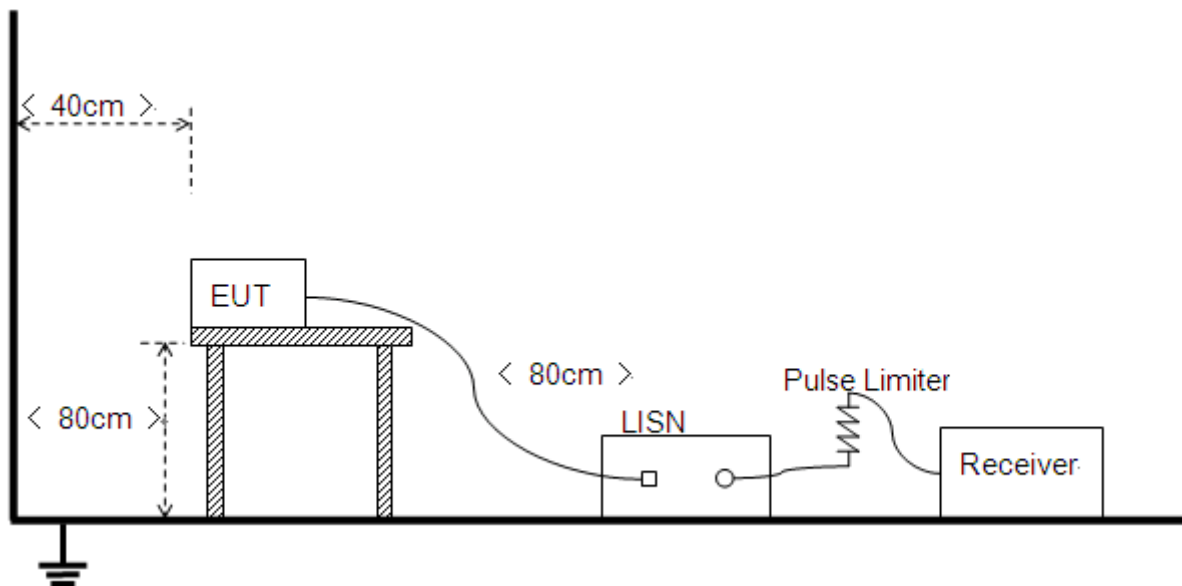

The Table-top EUT was placed upon a non-metallic table 0.8m above the horizontal metal reference ground plane. EUT was connected to LISN and LISN was connected to reference Ground Plane. EUT was 80cm from LISN. The set-up and test methods were according to ANSI C63.10: 2013.

The factors of the site are calibrated to correct the reading. During the measurement, the Bluetooth EUT is activated and controlled by the Bluetooth Service Supplier (SS) via a Common Antenna, and is set to operate under hopping-on test mode transmitting 339 bytes DH5 packages at maximum power.

**B. Equipments List:**

Please reference ANNEX A(1.5).

**2.9.3 Test Result**

The maximum conducted interference is searched using Peak (PK), if the emission levels more than the AV and QP limits, and that have narrow margins from the AV and QP limits will be re-measured with AV and QP detectors. Tests for both L phase and N phase lines of the power mains connected to the EUT are performed. Refer to recorded points and plots below.

**A. Test setup:**

The EUT configuration of the emission tests is EUT + Link.

**Note:** The test voltage is AC 120V/60Hz.

**B. Test Plots:**

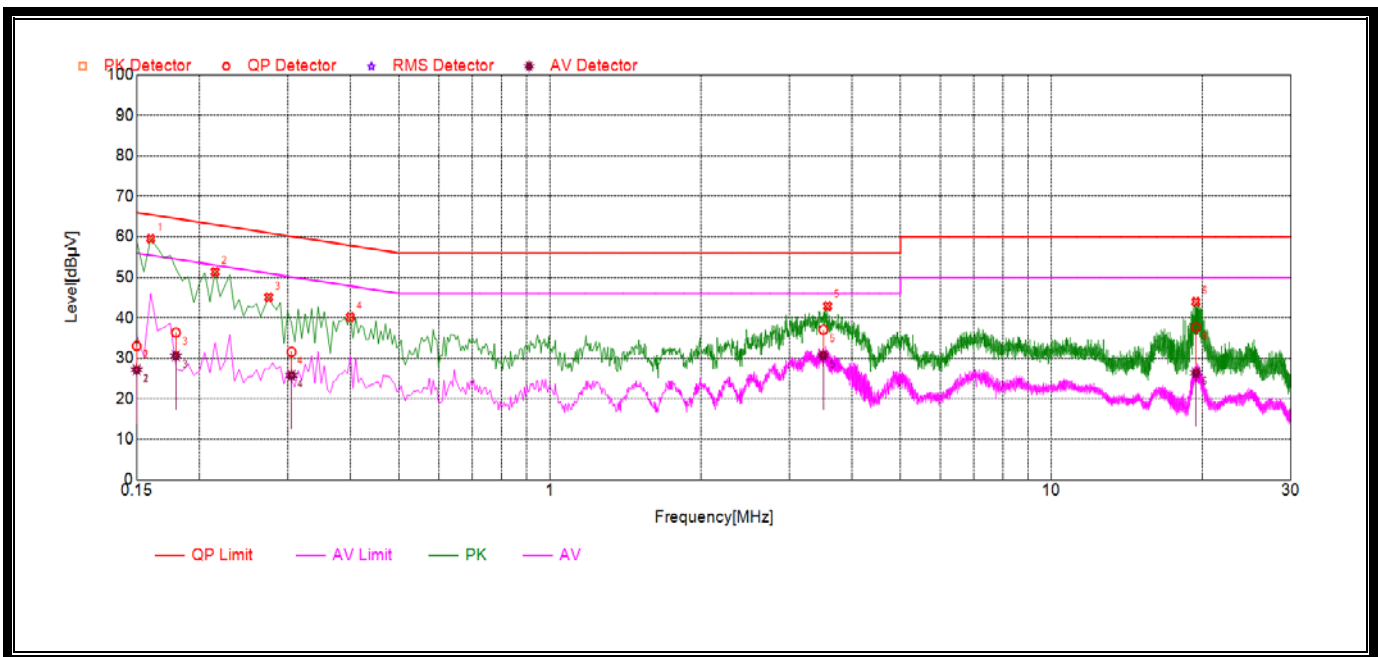

(Plot A: L Phase)

| NO. | Fre. (MHz) | Emission Level (dBµV) |         | Limit (dBµV) |         | Power-line | Verdict |
|-----|------------|-----------------------|---------|--------------|---------|------------|---------|
|     |            | Quai-peak             | Average | Quai-peak    | Average |            |         |
| 1   | 0.15       | 33.05                 | 27.17   | 66           | 56      | Line       | PASS    |
| 2   | 0.15       | 33.10                 | 27.14   | 66           | 56      |            | PASS    |
| 3   | 0.1796     | 36.36                 | 30.61   | 65.15        | 55.15   |            | PASS    |
| 4   | 0.3054     | 31.60                 | 25.80   | 61.56        | 51.56   |            | PASS    |
| 5   | 3.5088     | 37.07                 | 30.69   | 56           | 46      |            | PASS    |
| 6   | 19.4134    | 37.68                 | 26.40   | 60           | 50      |            | PASS    |

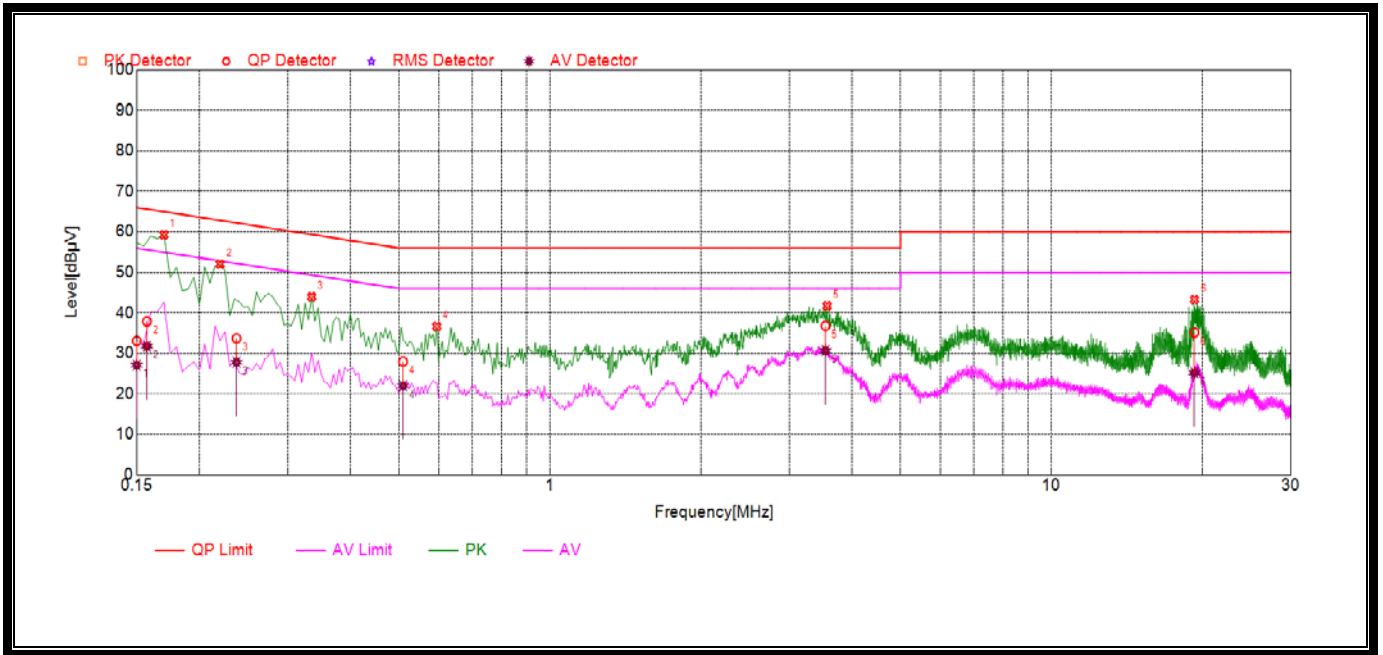

(Plot B: N Phase)

| NO. | Fre. (MHz) | Emission Level (dBµV) |         | Limit (dBµV) |         | Power-line | Verdict |
|-----|------------|-----------------------|---------|--------------|---------|------------|---------|
|     |            | Quai-peak             | Average | Quai-peak    | Average |            |         |
| 1   | 0.15       | 36.52                 | 27.10   | 66           | 56      | Line       | PASS    |
| 2   | 0.1572     | 31.61                 | 31.76   | 65.79        | 55.79   |            | PASS    |
| 3   | 0.2372     | 41.06                 | 27.78   | 63.51        | 53.51   |            | PASS    |
| 4   | 0.5096     | 27.32                 | 22.00   | 56           | 46      |            | PASS    |
| 5   | 3.5438     | 16.40                 | 30.67   | 56           | 46      |            | PASS    |
| 6   | 19.2866    | 16.51                 | 25.19   | 60           | 50      |            | PASS    |



## 2.10 Radiated Emission

### 2.10.1 Requirement

According to FCC section 15.247(d), radiated emission outside the frequency band attenuation below the general limits specified in FCC section 15.209(a) is not required. In addition, radiated emissions which fall in the restricted bands, as defined in FCC section 15.205(a), must also comply with the radiated emission limits specified in FCC section 15.209(a).

According to FCC section 15.209 (a), except as provided elsewhere in this subpart, the emissions from an intentional radiator shall not exceed the field strength levels specified in the following table:

| Frequency (MHz) | Field Strength ( $\mu\text{V}/\text{m}$ ) | Measurement Distance (m) |
|-----------------|---|--------------------------|
| 0.009 - 0.490   | 2400/F(kHz)                               | 300                      |
| 0.490 - 1.705   | 24000/F(kHz)                              | 30                       |
| 1.705 - 30.0    | 30  | 30                       |
| 30 - 88         | 100                                       | 3                        |
| 88 - 216        | 150                                       | 3                        |
| 216 - 960       | 200                                       | 3                        |
| Above 960       | 500                                       | 3                        |

**Note:**

1. For Above 1000MHz, the emission limit in this paragraph is based on measurement instrumentation employing an average detector, measurement using instrumentation with a peak detector function, corresponding to 20dB above the maximum permitted average limit.
2. For above 1000MHz, limit field strength of harmonics: 54dBuV/m@3m (AV) and 74dBuV/m@3m (PK)

In addition, radiated emissions which fall in the restricted bands, as defined in Section 15.205(a), also should comply with the radiated emission limits specified in Section 15.209(a)(above table)



### 2.10.2 Test Description

#### A. Test Setup:

- 1) For radiated emissions from 9kHz to 30MHz

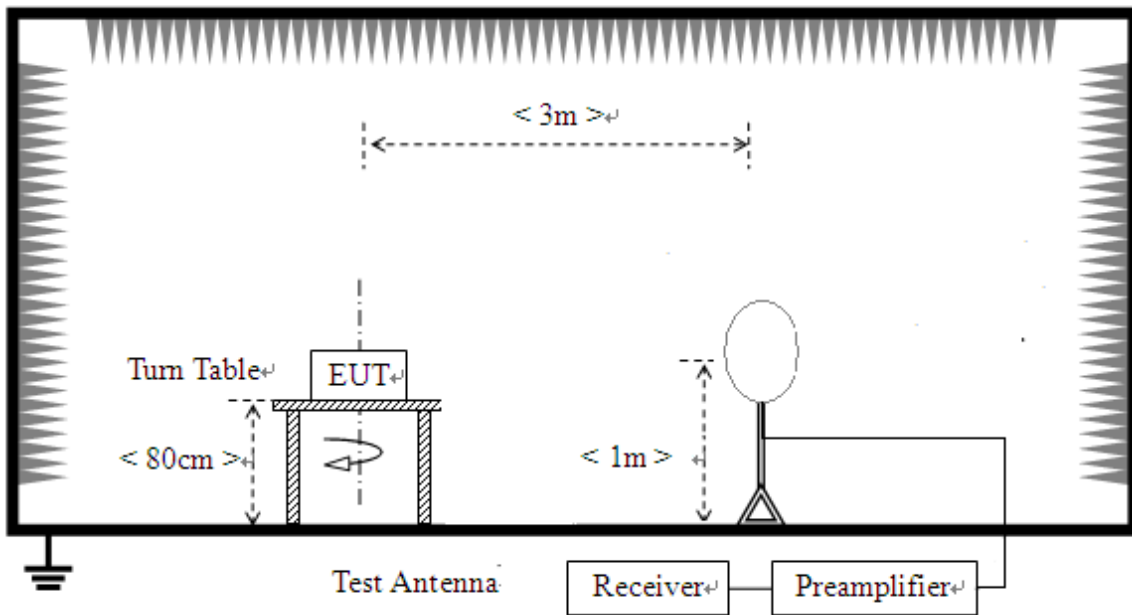

- 2) For radiated emissions from 30MHz to 1GHz

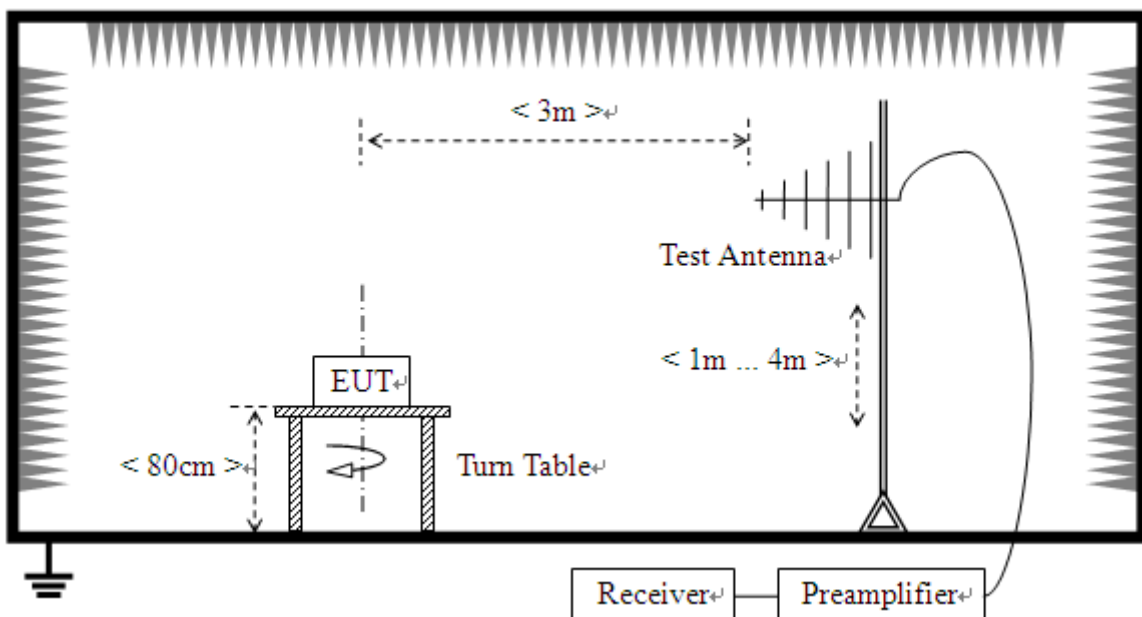

## 3) For radiated emissions above 1GHz

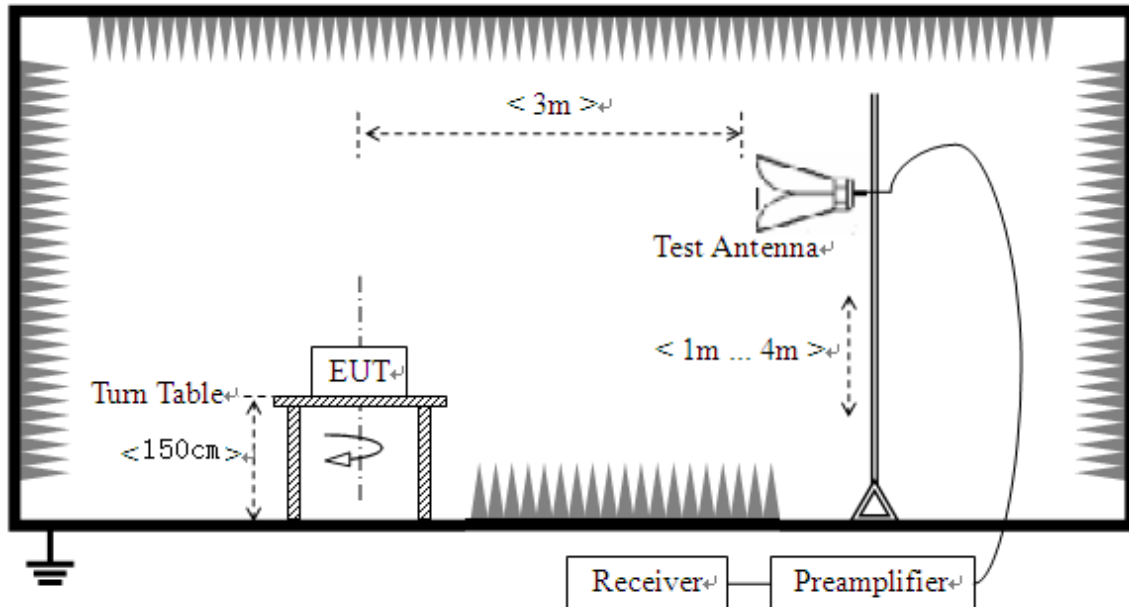

The RF absorbing material used on the reference ground plane and on the turntable have a maximum height (thickness) of 30 cm (12 in) and have a minimum-rated attenuation of 20 dB at all frequencies from 1 GHz to 18 GHz. Test site have a minimum area of the ground plane covered with RF absorbing material as specified in Figure 6 of ANSI C63.4: 2014.

The test site semi-anechoic chamber has met the requirement of NSA tolerance 4dB according to the standards: ANSI C63.10 (2013). For radiated emissions below or equal to 1GHz, the EUT was set-up on insulator 80cm above the Ground Plane, For radiated emissions above 1GHz, The EUT was set-up on insulator 150cm above the Ground Plane. The set-up and test methods were according to ANSI C63.10.

The EUT is located in a 3m Semi-Anechoic Chamber; the antenna factors, cable loss and so on of the site as factors are calculated to correct the reading.

For the Test Antenna:

(a) In the frequency range of 9kHz to 30MHz, magnetic field is measured with Loop Test Antenna. The Test Antenna is positioned with its plane vertical at 1m distance from the EUT. The center of the Loop Test Antenna is 1m above the ground. During the measurement the Loop Test Antenna rotates about its vertical axis for maximum response at each azimuth about the EUT.

(b) In the frequency range above 30MHz, Bi-Log Test Antenna (30MHz to 1GHz) and Horn Test Antenna (above 1GHz) are used. Place the test antenna at 3m away from area of the EUT, while keeping the test antenna aimed at the source of emissions at each frequency of significant



emissions, with polarization oriented for maximum response. The test antenna may have to be higher or lower than the EUT, depending on the radiation pattern of the emission and staying aimed at the emission source for receiving the maximum signal. The final test antenna elevation shall be that which maximizes the emissions. The test antenna elevation for maximum emissions shall be restricted to a range of heights of from 1 m to 4 m above the ground or reference ground plane. The emission levels at both horizontal and vertical polarizations should be tested.

## B. Equipments List:

Please reference ANNEX A(1.5).

### 2.10.3 Test Procedure

Use the following spectrum analyzer settings:

Span = wide enough to fully capture the emission being measured

RBW = 1 MHz for  $f \geq 1$  GHz, 100 kHz for  $f < 1$  GHz

VBW  $\geq$  RBW

Sweep = auto

Detector function = peak

Trace = max hold

### 2.10.4 Test Result

According to ANSI C63.10, because of peak detection will yield amplitudes equal to or greater than amplitudes measured with the quasi-peak (or average) detector, the measurement data from a spectrum analyzer peak detector will represent the worst-case results, if the peak measured value complies with the quasi-peak limit, it is unnecessary to perform an quasi-peak measurement.

The measurement results are obtained as below:

$$E \text{ [dB}\mu\text{V/m]} = U_R + A_T + A_{\text{Factor}} \text{ [dB]}; A_T = L_{\text{Cable loss}} \text{ [dB]} - G_{\text{preamp}} \text{ [dB]}$$

$A_T$ : Total correction Factor except Antenna

$U_R$ : Receiver Reading

$G_{\text{preamp}}$ : Preamplifier Gain

$A_{\text{Factor}}$ : Antenna Factor at 3m

During the test, the total correction Factor  $A_T$  and  $A_{\text{Factor}}$  were built in test software.

**Note:** All radiated emission tests were performed in X, Y, Z axis direction. And only the worst axis test condition was recorded in this test report.

The low frequency, which started from 9KHz to 30MHz, was pre-scanned and the result which was 20dB lower than the limit line per 15.31(o) was not reported.



2.10.4.1 GFSK Mode:

A. Test Plots for the Whole Measurement Frequency Range:

Plots for Channel = 0

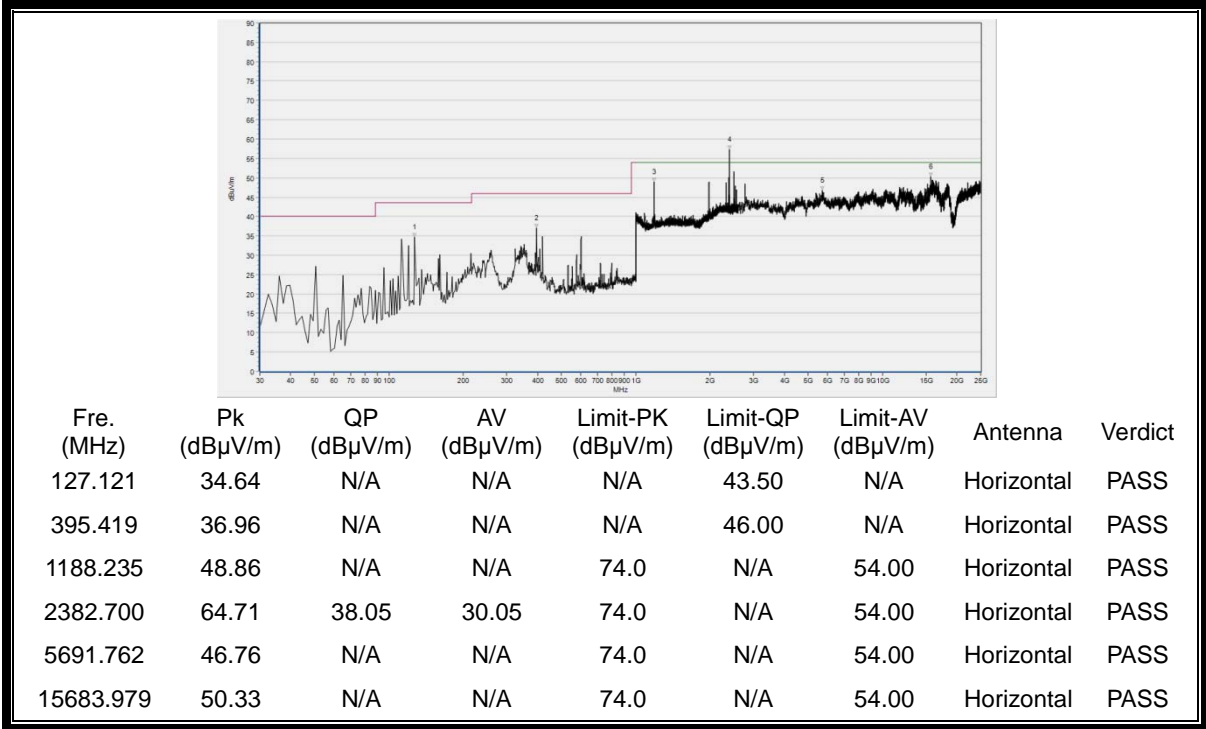

(30MHz to 25GHz, Antenna Horizontal @ GFSK, channel 0)

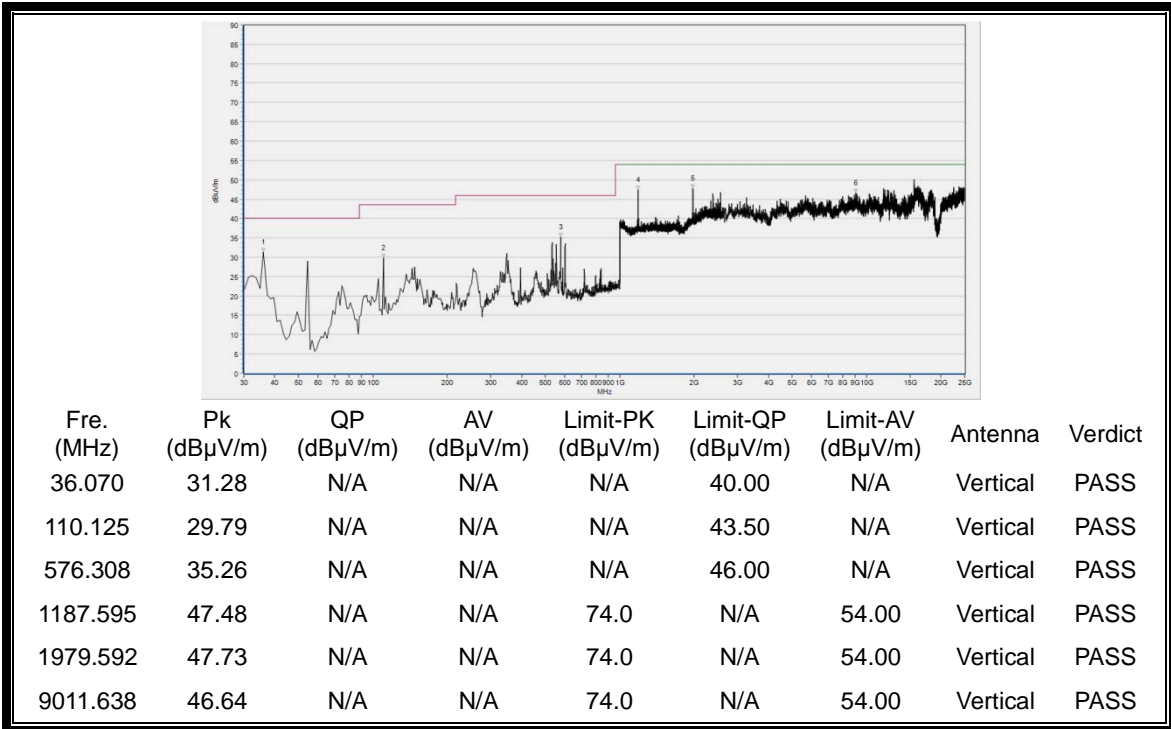

(30MHz to 25GHz, Antenna Vertical @ GFSK, channel 0)

Plot for Channel = 39

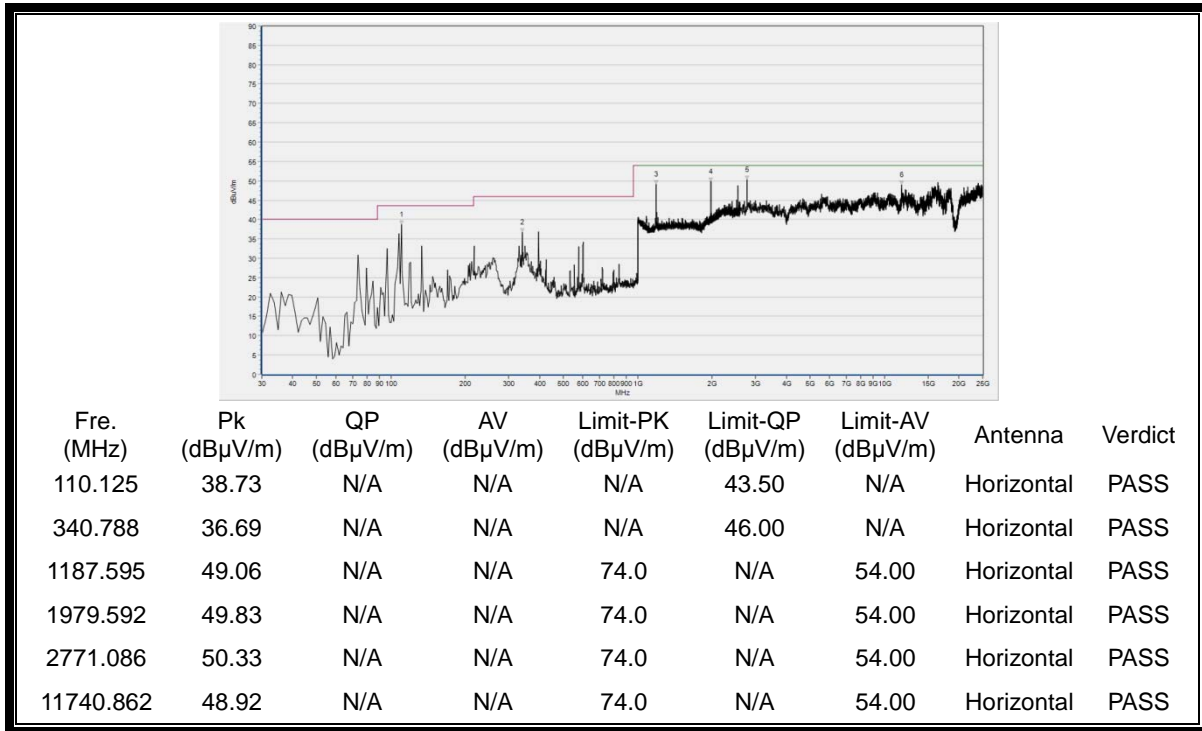

(30MHz to 25GHz, Antenna Horizontal @ GFSK, channel 39)

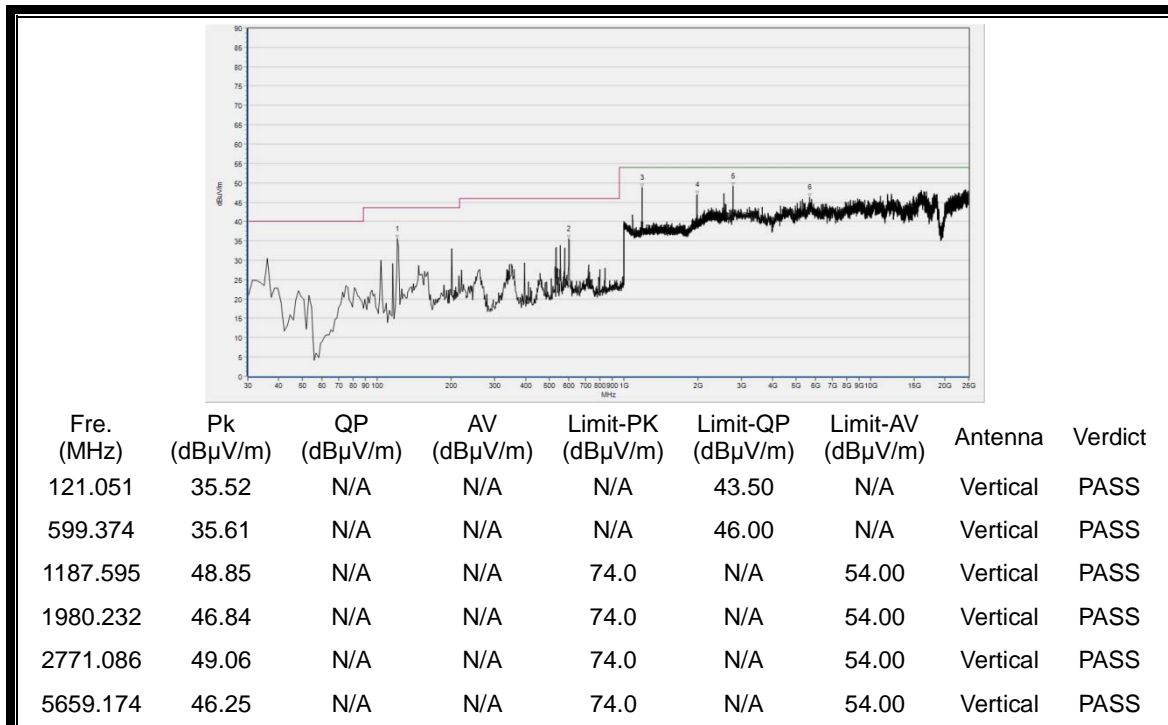

(30MHz to 25GHz, Antenna Vertical @ GFSK, channel 39)

Plot for Channel = 78

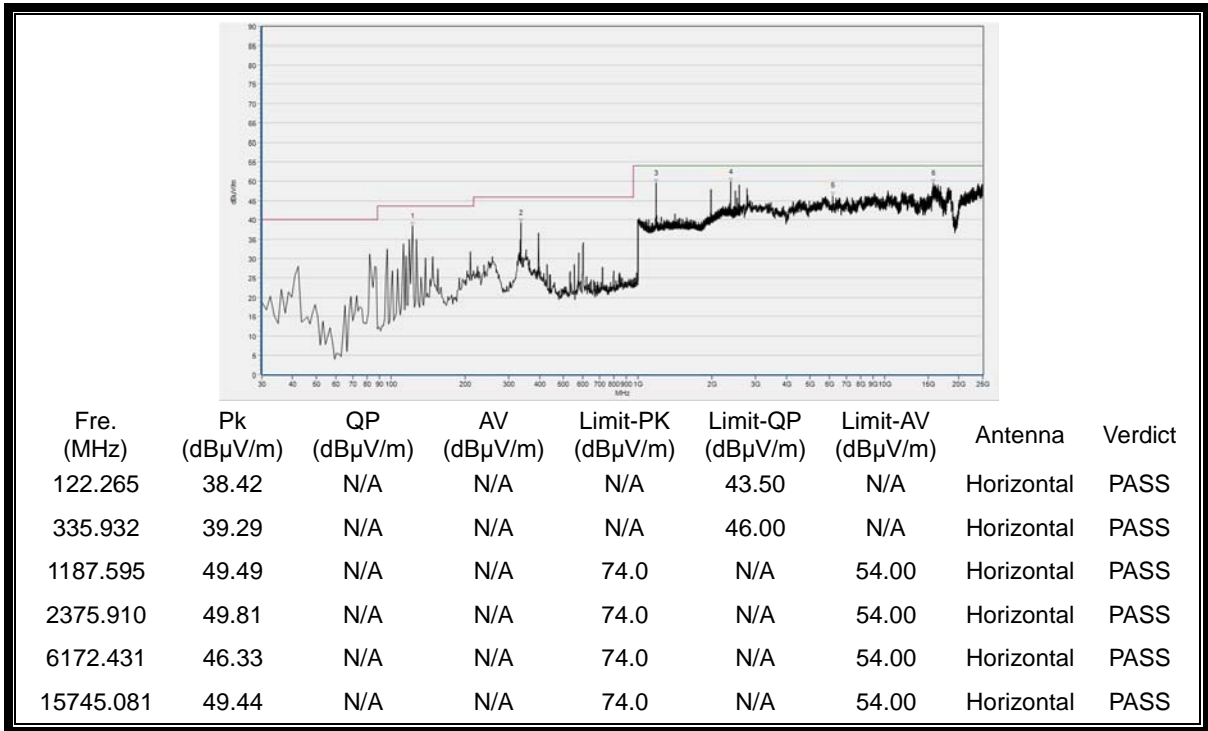

(30MHz to 25GHz, Antenna Horizontal @ GFSK, channel 78)

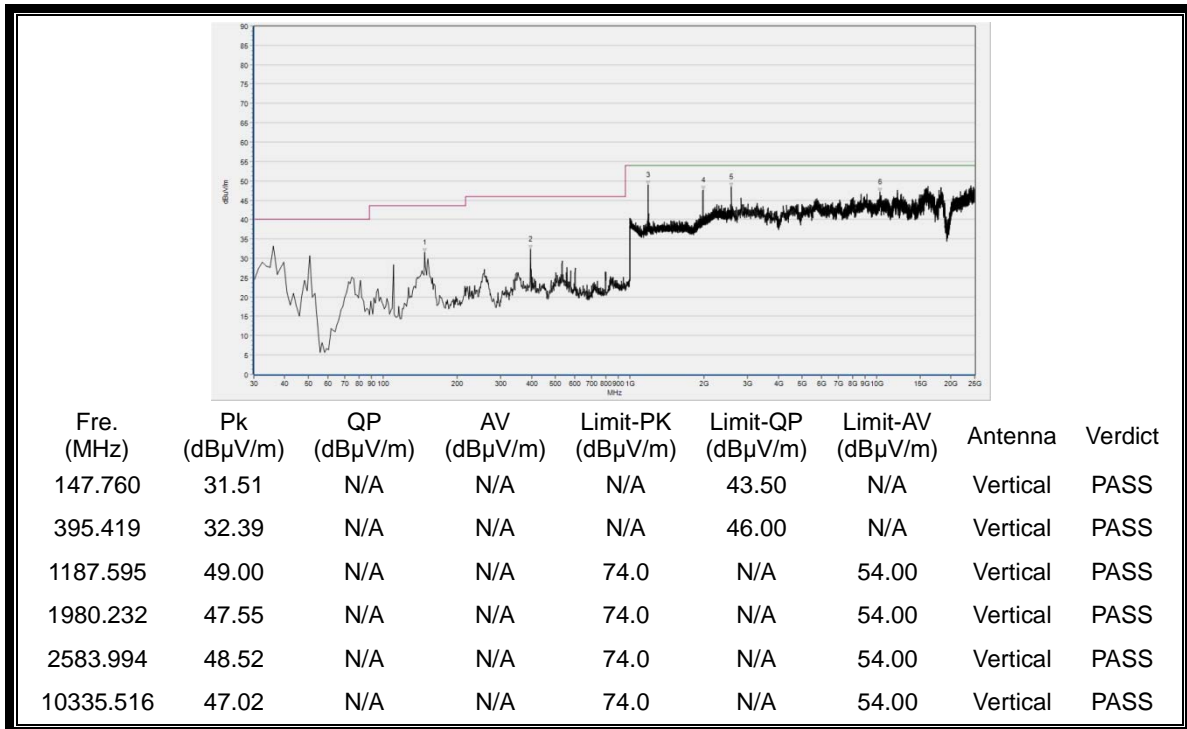

(30MHz to 25GHz, Antenna Vertical @ GFSK, channel 78)

2.10.4.2  $\pi/4$ -DQPSK Mode:

**B. Test Plots for the Whole Measurement Frequency Range:**

Plots for Channel = 0

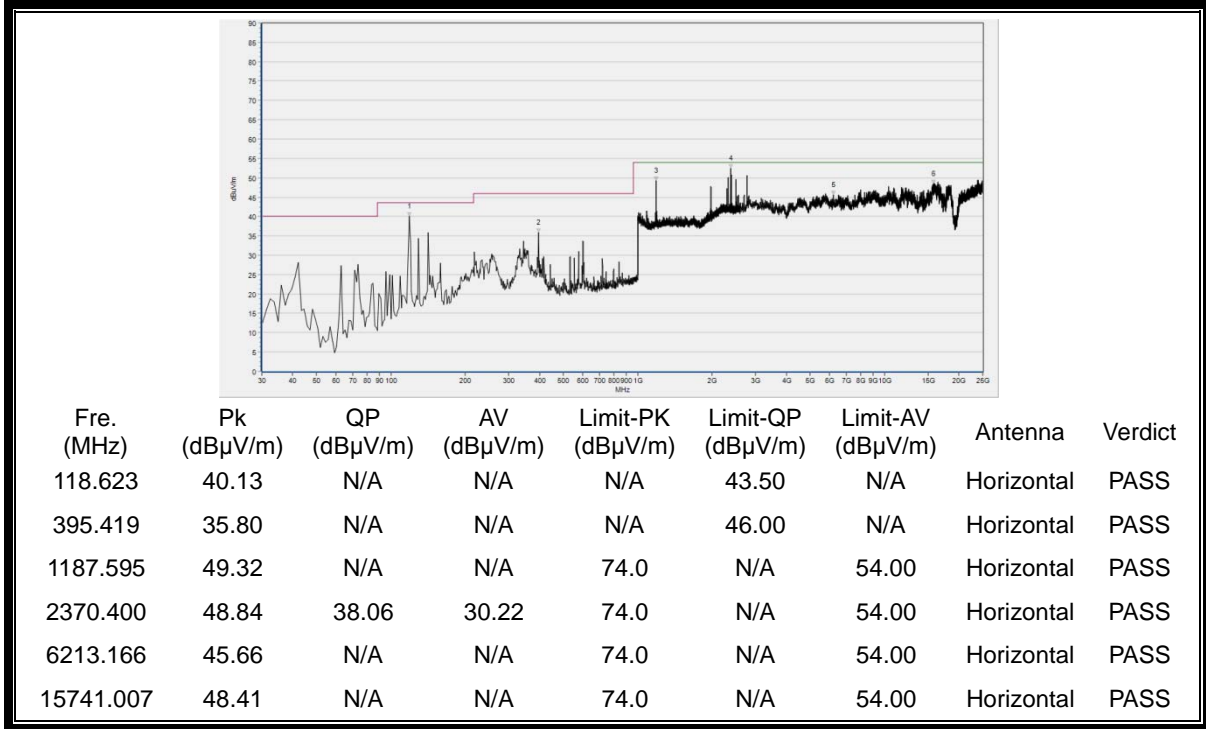

(30MHz to 25GHz, Antenna Horizontal @  $\pi/4$ -DQPSK, channel 0)

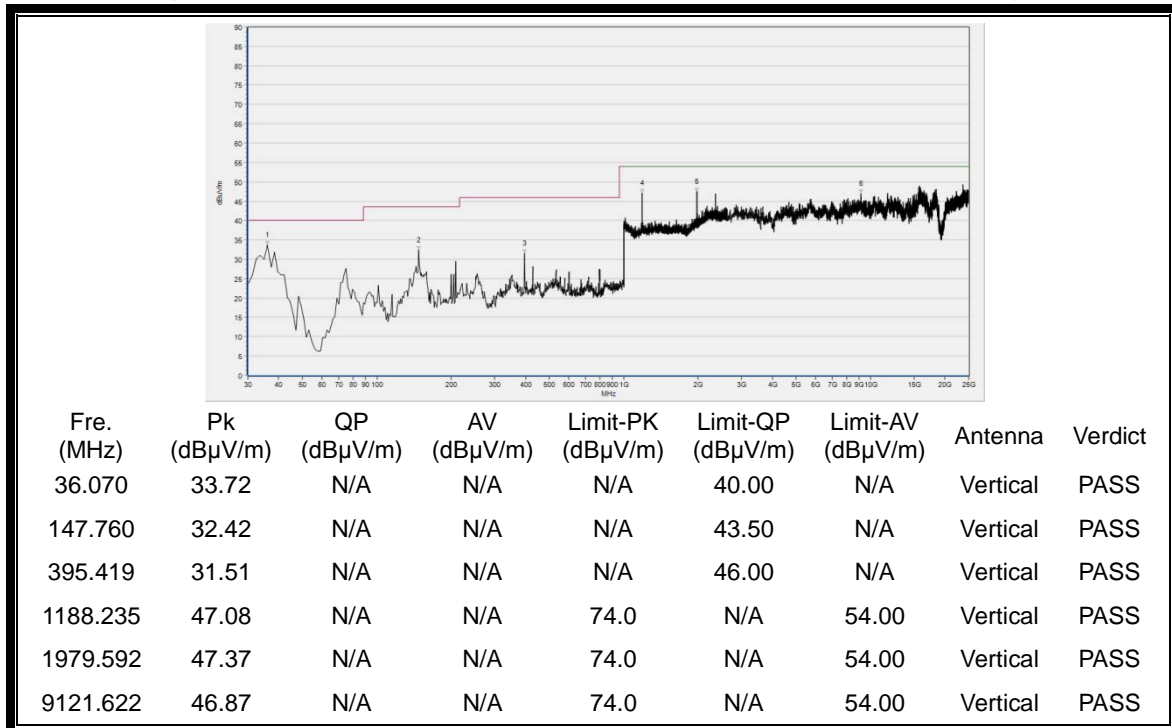

(30MHz to 25GHz, Antenna Vertical @  $\pi/4$ -DQPSK, channel 0)



Plot for Channel = 39

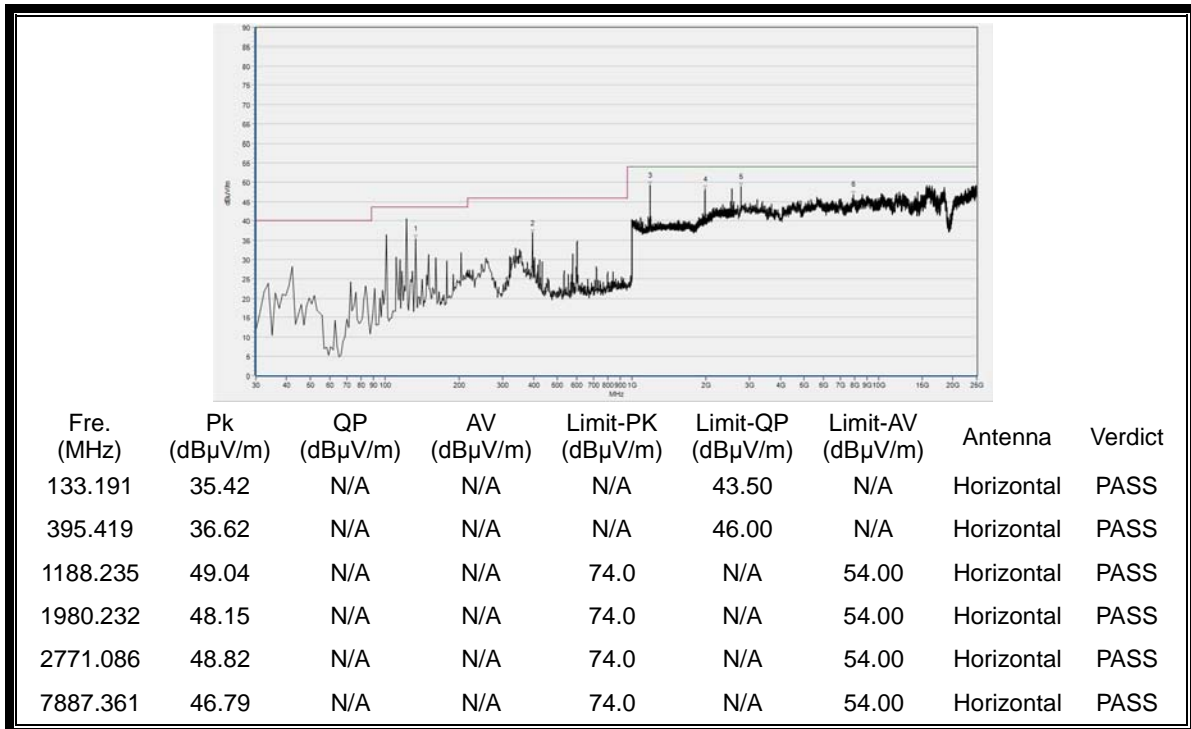

(30MHz to 25GHz, Antenna Horizontal @ π/4-DQPSK, channel 39)

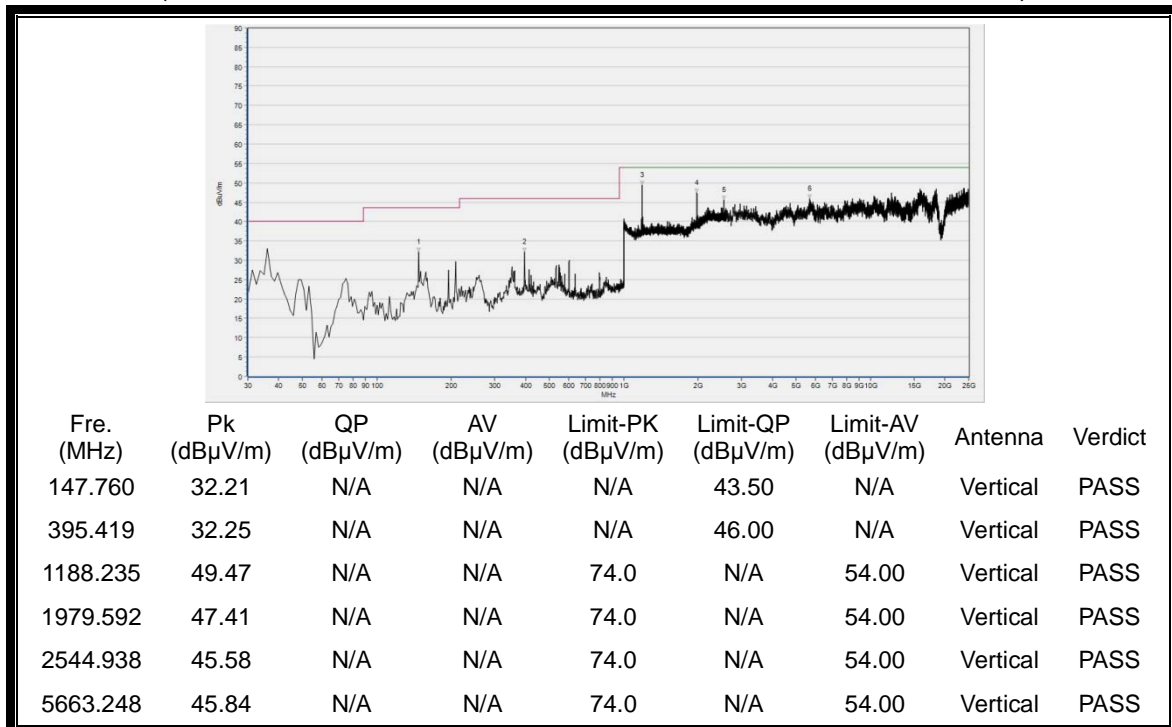

(30MHz to 25GHz, Antenna Vertical @ π/4-DQPSK, channel 39)





Plot for Channel = 78

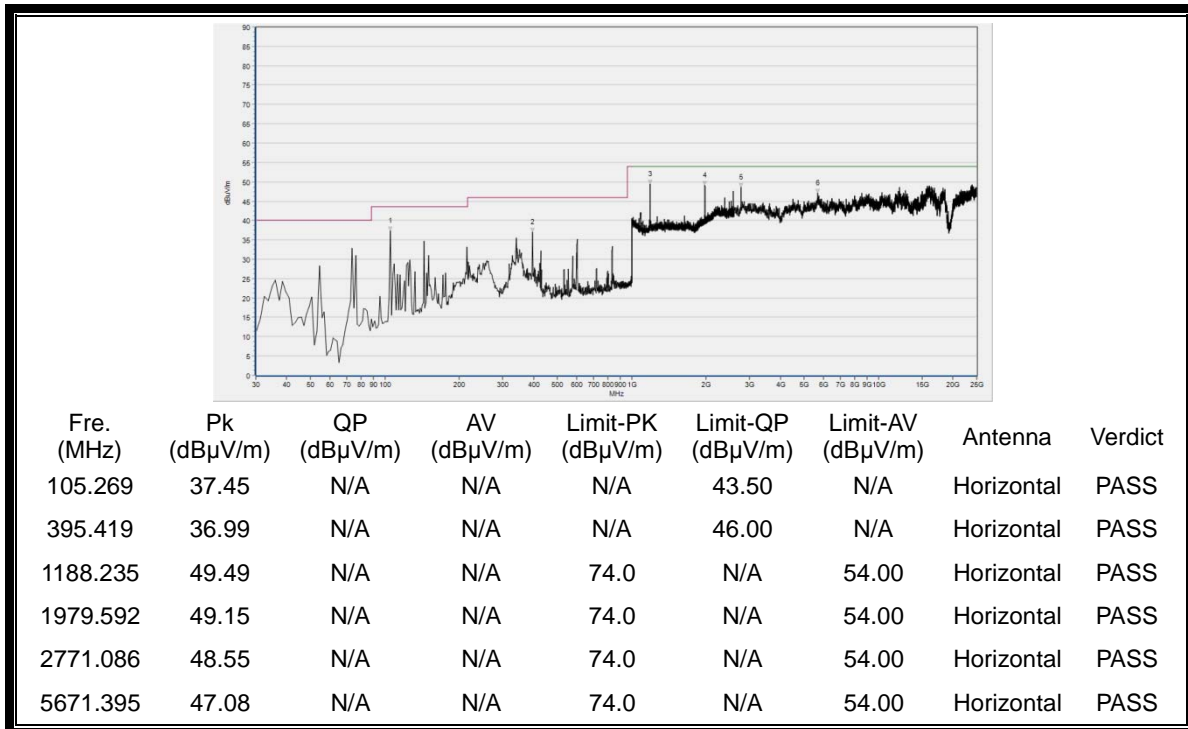

(30MHz to 25GHz, Antenna Horizontal @ π/4-DQPSK, channel 78)

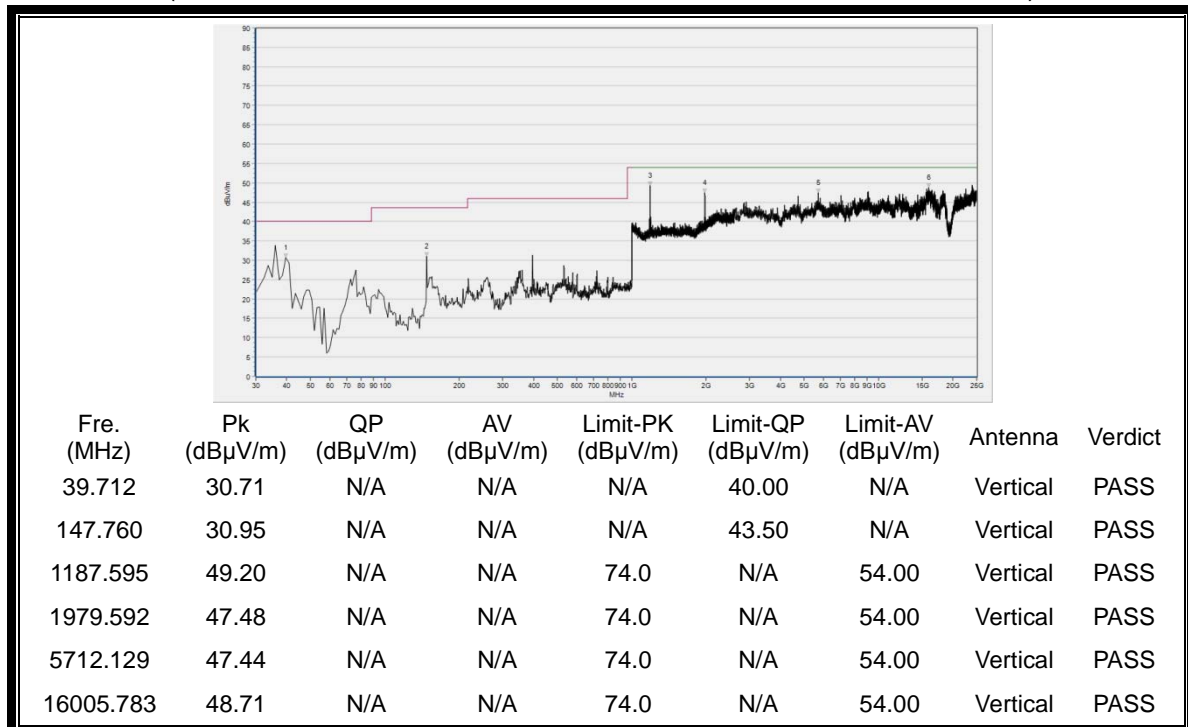

(30MHz to 25GHz, Antenna Vertical @ π/4-DQPSK, channel 78)



2.10.4.3 8-DPSK Mode:

C. Test Plots for the Whole Measurement Frequency Range:

Plots for Channel = 0

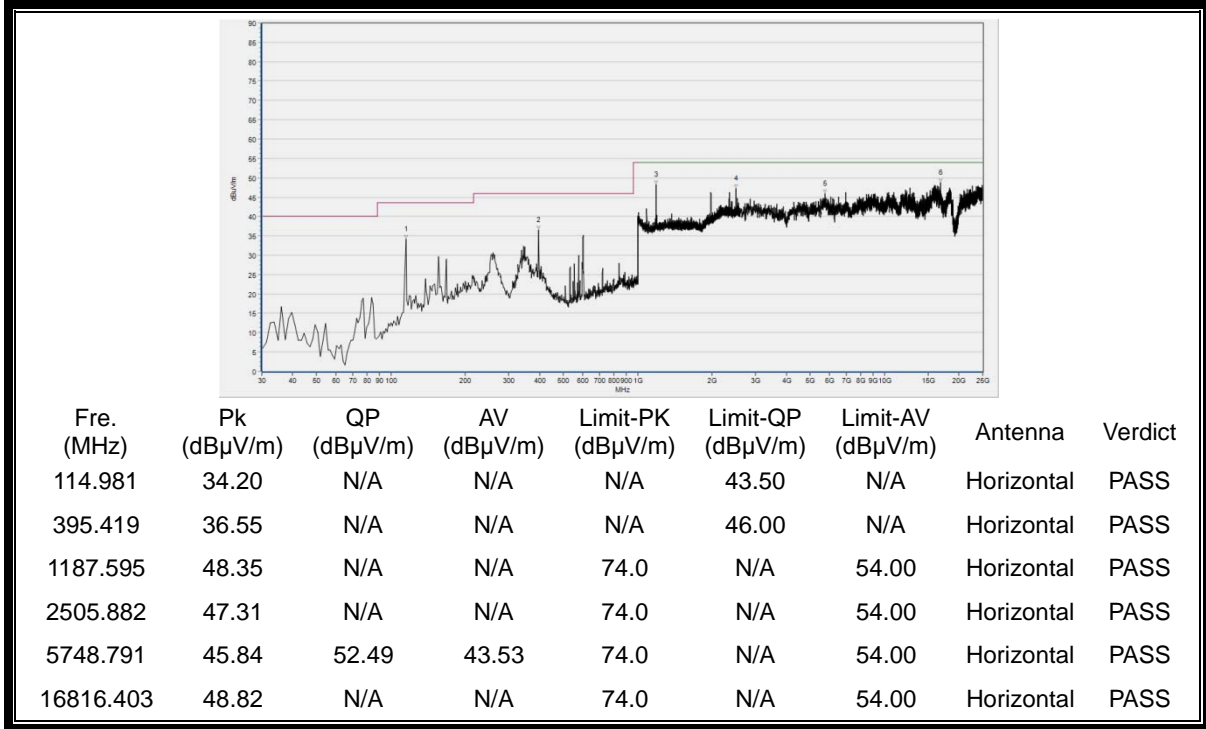

(30MHz to 25GHz, Antenna Horizontal @8-DPSK, channel 0)

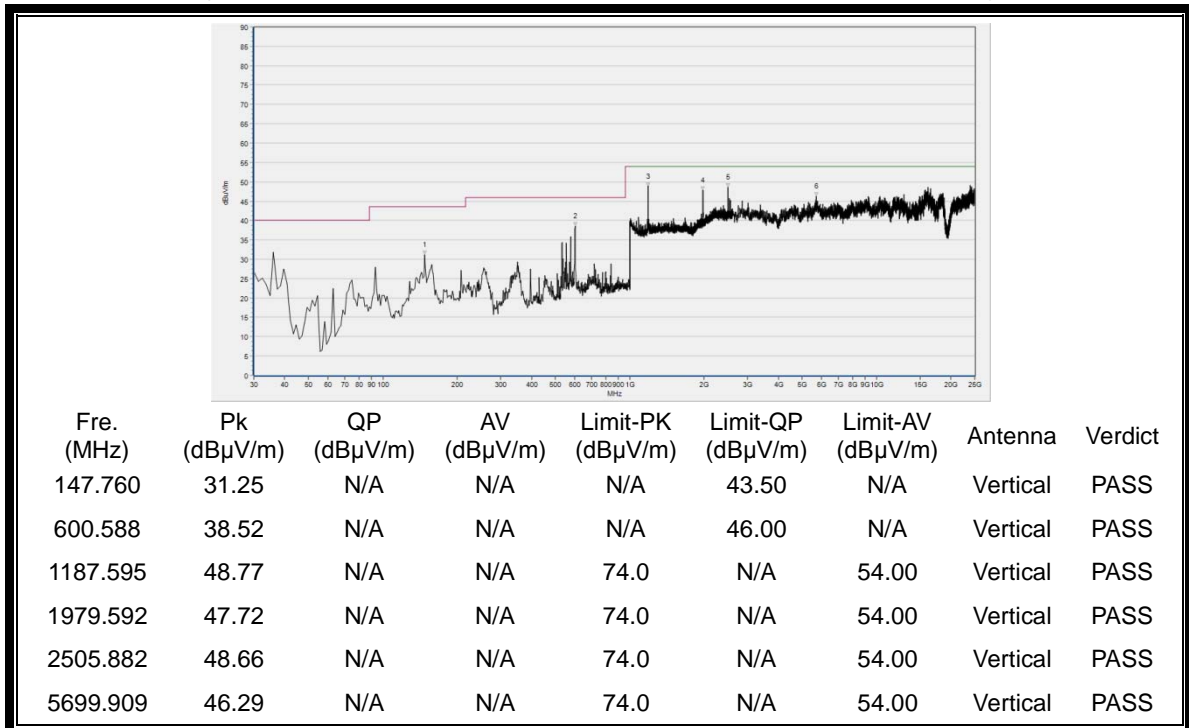

(30MHz to 25GHz, Antenna Vertical @8-DPSK, channel 0)



Plot for Channel = 39

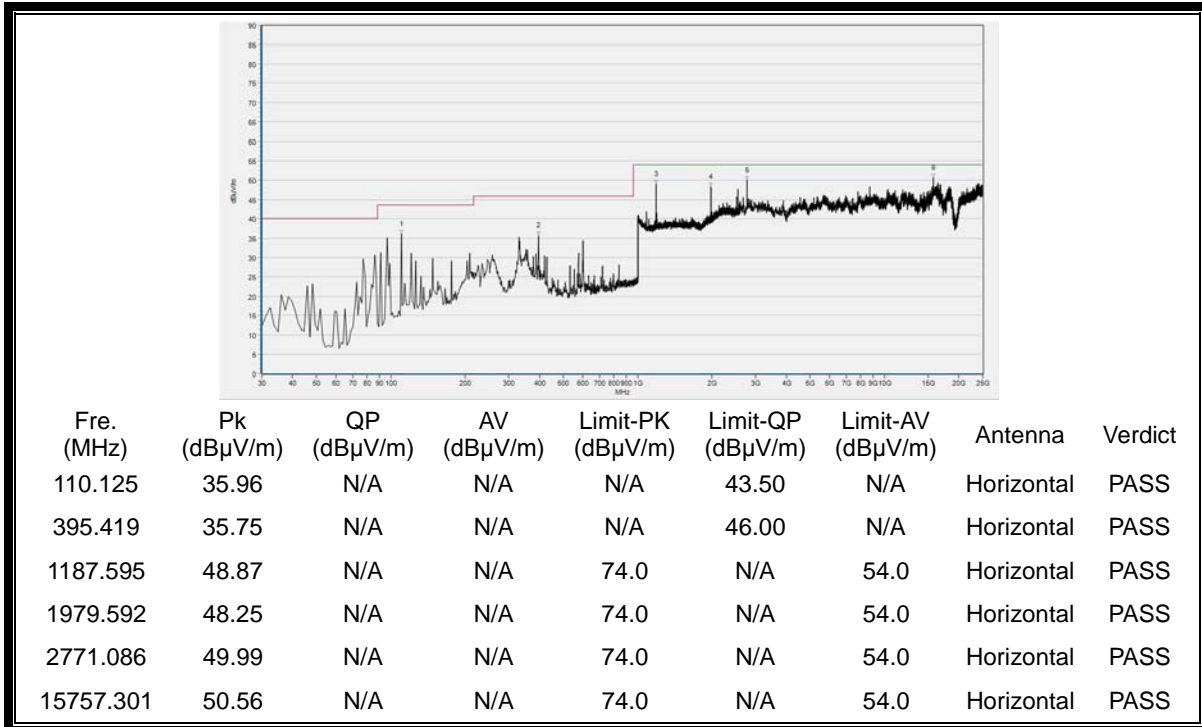

(30MHz to 25GHz, Antenna Horizontal @8-DPSK, channel 39)

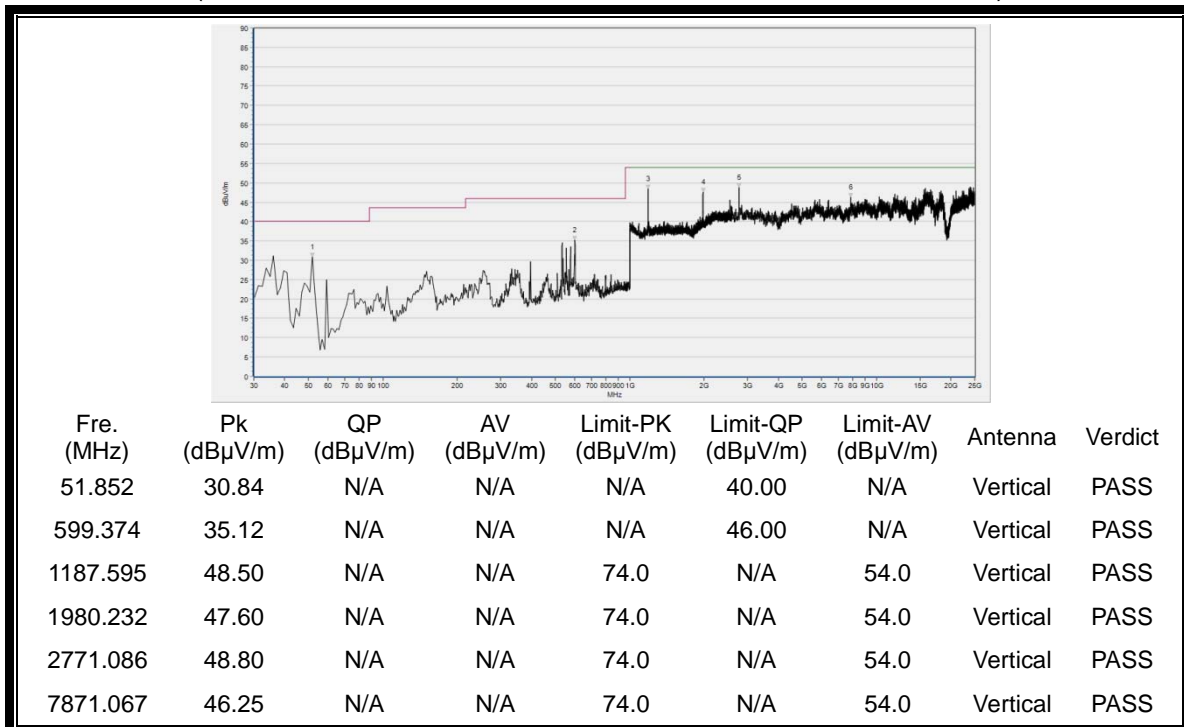

(30MHz to 25GHz, Antenna Vertical @8-DPSK, channel 39)

Plot for Channel = 78

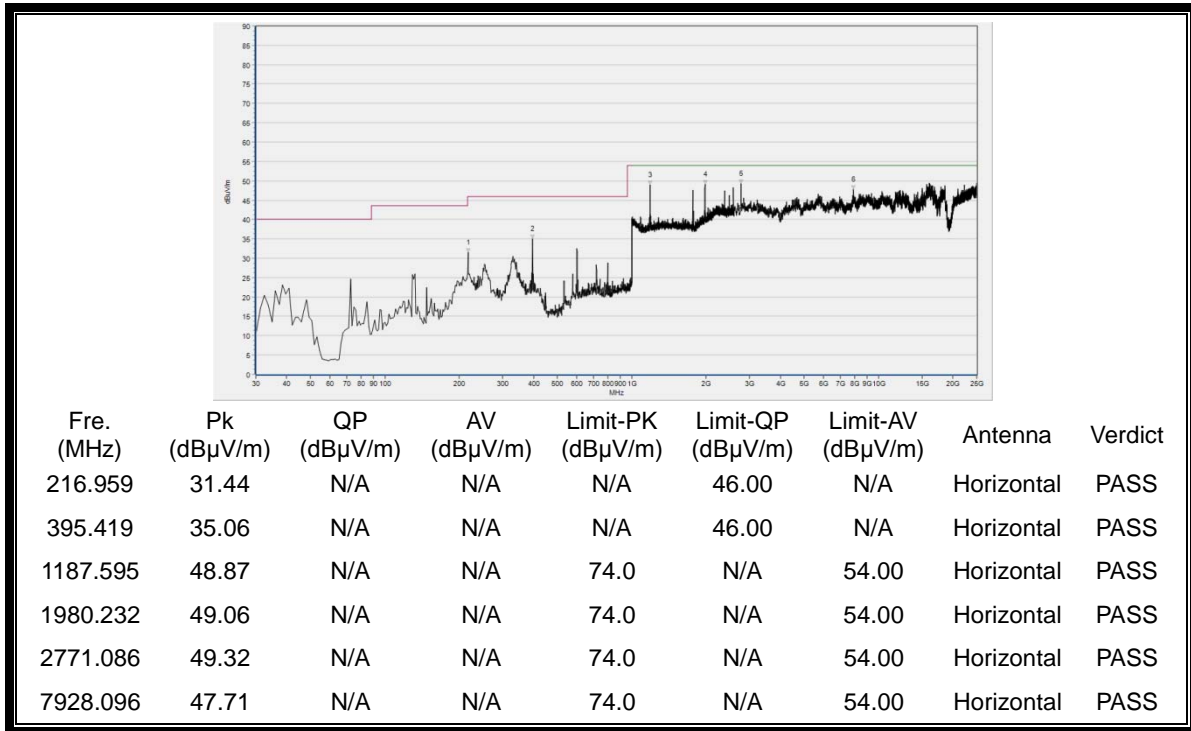

(30MHz to 25GHz, Antenna Horizontal @8-DPSK, channel 78)

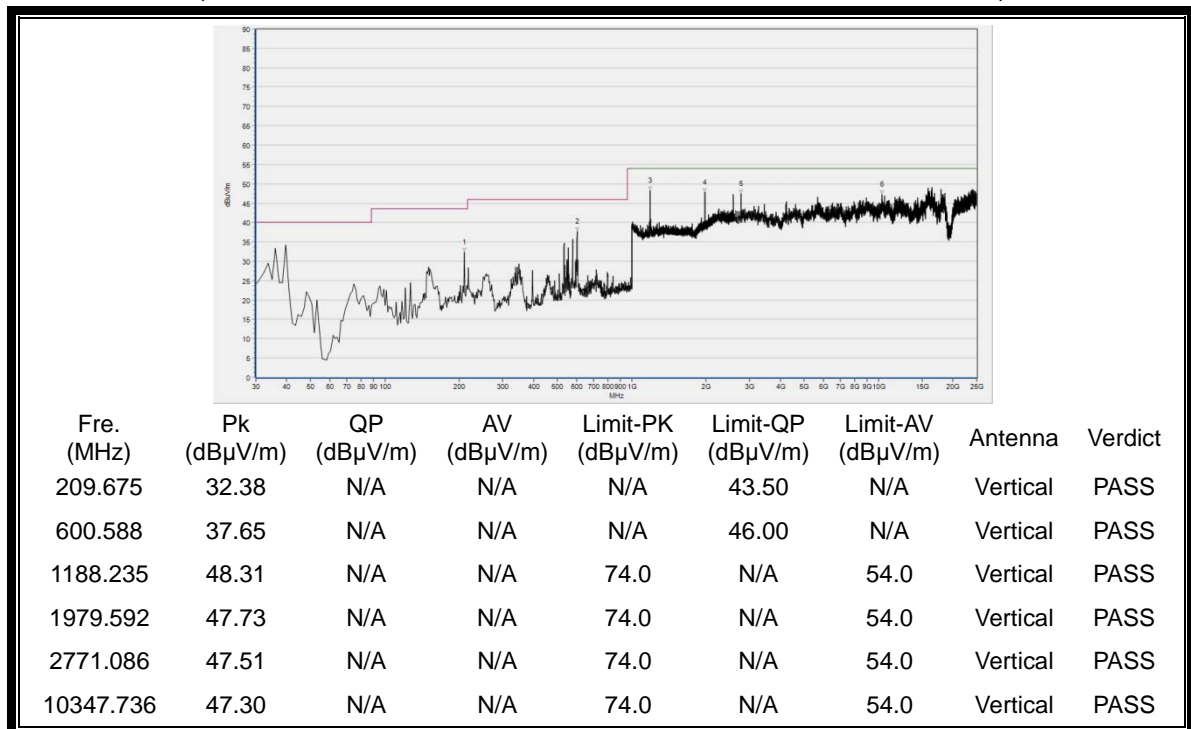

(30MHz to 25GHz, Antenna Vertical @8-DPSK, channel 78)



## ANNEX A GENERAL INFORMATION

### 1.1 Identification of the Responsible Testing Laboratory

|                               |  |
|-------------------------------|--|
| Company Name:                 | Shenzhen Morlab Communications Technology Co., Ltd.  |
| Department:                   | Morlab Laboratory  |
| Address:                      | FL.3, Building A, FeiYang Science Park, No.8 LongChang Road, Block 67, BaoAn District, ShenZhen, GuangDong Province, P. R. China |
| Responsible Test Lab Manager: | Mr. Su Feng  |
| Telephone:                    | +86 755 36698555   |
| Facsimile:                    | +86 755 36698525   |

### 1.2 Identification of the Responsible Testing Location

|          |  |
|----------|--|
| Name:    | Shenzhen Morlab Communications Technology Co., Ltd.<br>Morlab Laboratory   |
| Address: | FL.3, Building A, FeiYang Science Park, No.8 LongChang Road, Block 67, BaoAn District, ShenZhen, GuangDong Province, P. R. China |

### 1.3 Facilities and Accreditations

Shenzhen Morlab Communications Technology Co., Ltd. Morlab Laboratory is a testing organization accredited by China National Accreditation Service for Conformity Assessment (CNAS) according to ISO/IEC 17025. The accreditation certificate number is L3572.

All measurement facilities used to collect the measurement data are located at FL.3, Building A, FeiYang Science Park, Block 67, BaoAn District, Shenzhen, 518101 P. R. China. The test site is constructed in conformance with the requirements of ANSI C63.10-2013 and CISPR Publication 22; the FCC designation number is CN1192.

### 1.4 Maximum measurement uncertainty

Where relevant, the following measurement uncertainty levels have been estimated for test performed on the EUT as specified in CISPR 16-1-2:

| Test items                     | Uncertainty |
|--------------------------------|-------------|
| Number of Hopping Frequency    | ±5%         |
| Peak Output Power              | ±2.22dB     |
| 20dB Bandwidth                 | ±5%         |
| Carrier Frequency Separation   | ±5%         |
| Time of Occupancy (Dwell time) | ±5%         |
| Conducted Spurious Emission    | ±2.77 dB    |
| Restricted Frequency Bands     | ±5%         |



|                    |         |
|--------------------|---------|
| Radiated Emission  | ±2.95dB |
| Conducted Emission | ±2.44dB |

This uncertainty represent an expanded uncertainty expressed at approximately the 95% confidence level using a coverage factor of k=2

**1.5 Test Equipments Utilized**

**1.5.1 Conducted Test Equipments**

| Conducted Test Equipment |                           |            |         |              |            |            |
|--------------------------|---------------------------|------------|---------|--------------|------------|------------|
| No.                      | Equipment Name            | Serial No. | Type    | Manufacturer | Cal. Date  | Cal. Due   |
| 1                        | Spectrum Analyzer         | MY45101810 | E4407B  | Agilent      | 2017.05.24 | 2018.05.23 |
| 2                        | Power Splitter            | NW521      | 1506A   | Weinschel    | 2017.05.24 | 2018.05.23 |
| 3                        | Attenuator 1              | (N/A.)     | 10dB    | Resnet       | 2017.05.24 | 2018.05.23 |
| 4                        | Attenuator 2              | (N/A.)     | 3dB     | Resnet       | 2017.05.24 | 2018.05.23 |
| 5                        | EXA Signal Analyzer       | MY53470836 | N9010A  | Agilent      | 2016.12.07 | 2017.12.06 |
| 6                        | Bluetooth Test Set        | 6K00006210 | MT8852B | Anritsu      | 2017.05.24 | 2018.05.23 |
| 7                        | USB Wideband Power Sensor | MY54210011 | U2021XA | Agilent      | 2017.05.24 | 2018.05.23 |
| 8                        | RF cable (30MHz-26GHz)    | CB01       | RF01    | Morlab       | N/A        | N/A        |
| 9                        | Coaxial cable             | CB02       | RF02    | Morlab       | N/A        | N/A        |
| 10                       | SMA connector             | CN01       | RF03    | HUBER-SUHNER | N/A        | N/A        |

**1.5.2 Conducted Emission Test Equipments**

| Conducted Emission Test Equipments |                                  |            |             |              |            |            |
|------------------------------------|----------------------------------|------------|-------------|--------------|------------|------------|
| No.                                | Equipment Name                   | Serial No. | Type        | Manufacturer | Cal. Date  | Cal. Due   |
| 1                                  | Receiver                         | US44210471 | E7405A      | Agilent      | 2017.05.24 | 2018.05.23 |
| 2                                  | LISN                             | 812744     | NSLK 8127   | Schwarzbeck  | 2017.05.24 | 2018.05.23 |
| 3                                  | Service Supplier                 | 100448     | CMU200      | R&S          | 2017.05.24 | 2018.05.23 |
| 4                                  | Pulse Limiter (20dB)             | 9391       | VTSD 9561-D | Schwarzbeck  | 2017.05.24 | 2018.05.23 |
| 5                                  | Coaxial cable(BNC) (30MHz-26GHz) | CB01       | EMC01       | Morlab       | N/A        | N/A        |

**1.5.3 Auxiliary Test Equipment**

| Auxiliary Test Equipment |                |           |            |              |          |              |
|--------------------------|----------------|-----------|------------|--------------|----------|--------------|
| No.                      | Equipment Name | Model No. | Brand Name | Manufacturer | Cal.Date | Cal.Due Date |
| 1                        | Computer       | T430i     | Think Pad  | Lenovo       | N/A      | N/A          |

**1.5.4 Radiated Test Equipments**

| Radiated Test Equipments |                                      |            |             |                |            |              |
|--------------------------|--------------------------------------|------------|-------------|----------------|------------|--------------|
| No.                      | Equipment Name                       | Serial No. | Type        | Manufacturer   | Cal. Date  | Cal.Due Date |
| 1                        | System Simulator                     | GB45360846 | 8960-E5515C | Agilent        | 2017.05.17 | 2018.05.16   |
| 2                        | Receiver                             | MY54130016 | N9038A      | Agilent        | 2017.05.17 | 2018.05.16   |
| 3                        | Test Antenna - Bi-Log                | N/A        | VULB9163    | Schwarzbeck    | 2016.12.09 | 2017.12.08   |
| 4                        | Test Antenna - Horn                  | 9120C-384  | BBHA 9120C  | Schwarzbeck    | 2017.03.30 | 2018.03.29   |
| 5                        | Test Antenna - Loop                  | 1519-022   | FMZB1519    | Schwarzbeck    | 2017.03.30 | 2018.03.29   |
| 6                        | Coaxial cable (N male) (9KHz-30MHz)  | CB04       | EMC04       | Morlab         | N/A        | N/A          |
| 7                        | Coaxial cable (N male) (30MHz-26GHz) | CB02       | EMC02       | Morlab         | N/A        | N/A          |
| 8                        | Coaxial cable(N male) (30MHz-26GHz)  | CB03       | EMC03       | Morlab         | N/A        | N/A          |
| 9                        | 1-18GHz pre-Amplifier                | MA02       | TS-PR18     | Rohde& Schwarz | 2017.05.17 | 2018.05.16   |
| 10                       | 18-26.5GHz pre-Amplifier             | MA03       | TS-PR18     | Rohde& Schwarz | 2017.05.17 | 2018.05.16   |

**1.5.5 Climate Chamber**

| Climate Chamber |                 |            |         |              |            |              |
|-----------------|-----------------|------------|---------|--------------|------------|--------------|
| No.             | Equipment Name  | Serial No. | Type    | Manufacturer | Cal.Date   | Cal.Due Date |
| 1               | Climate Chamber | 2004012    | HL4003T | Yinhe        | 2017.01.11 | 2018.01.10   |

**1.5.6 Vibration Table**

| Vibration Table |                 |            |               |              |            |              |
|-----------------|-----------------|------------|---------------|--------------|------------|--------------|
| No.             | Equipment Name  | Serial No. | Type          | Manufacturer | Cal.Date   | Cal.Due Date |
| 1               | Vibration Table | N/A        | ACT2000-S015L | CMI-COM      | 2017.01.11 | 2018.01.10   |

**1.5.7 Anechoic Chamber**

| Anechoic Chamber |                  |            |          |              |            |              |
|------------------|------------------|------------|----------|--------------|------------|--------------|
| No.              | Equipment Name   | Serial No. | Type     | Manufacturer | Cal.Date   | Cal.Due Date |
| 1                | Anechoic Chamber | N/A        | 9m*6m*6m | Changning    | 2017.01.11 | 2018.01.10   |

\*\*\*\*\* END OF REPORT \*\*\*\*\*