

FCC TEST REPORT
for
Anker Technology Co., Limited

Bluetooth Speaker
Model No.: A7911

Prepared for : Anker Technology Co., Limited
Address : Room 1318-19, Hollywood Commercial Center, 610 Nathan
Road, Mongkok, Kowloon, Hongkong

Prepared By : Shenzhen Anbotek Compliance Laboratory Limited
Address : 1/F., Building 1, SEC Industrial Park, No.0409 Qianhai Road,
Nanshan District, Shenzhen, Guangdong, China
Tel: (86) 755-26066544
Fax: (86) 755-26014772

Report Number : R011410451E
Date of Test : Oct. 30~ Nov. 28, 2014
Date of Report : Jan. 05, 2014

TABLE OF CONTENTS

Description	Page
Test Report	
1. GENERAL INFORMATION.....	4
1.1. Description of Device (EUT).....	4
1.2. Auxiliary Equipment Used during Test.....	5
1.3. Description of Test Facility.....	5
1.4. Measurement Uncertainty.....	5
2. TEST PROCEDURE.....	6
3. CONDUCTED LIMITS.....	7
3.1. Block Diagram of Test Setup.....	7
3.2. Power Line Conducted Emission Measurement Limits (15.207).....	7
3.3. Configuration of EUT on Measurement.....	7
3.4. Operating Condition of EUT.....	7
3.5. Test Procedure.....	8
3.6. Power Line Conducted Emission Measurement Results.....	8
4. RADIATION INTERFERENCE.....	11
4.1. Requirements (15.249, 15.209):.....	11
4.2. Test Procedure.....	11
4.3. Test Configuration:.....	12
4.4. Test Results.....	13
5. OCCUPIED BANDWIDTH.....	19
5.1. Requirements (15.249):.....	19
5.2. Test Procedure.....	19
5.3. Test Configuration:.....	19
5.4. Test Results.....	19
6. PHOTOGRAPH.....	23
6.1. Photo of Conducted Emission Test.....	23
6.2. Photo of Radiation Emission Test.....	23
APPENDIX I (EXTERNAL PHOTOS).....	25
APPENDIX II (INTERNAL PHOTOS).....	28

Appendix I (3 Pages)

Appendix II (4 Pages)

TEST REPORT

Applicant : Anker Technology Co., Limited
Manufacturer : Anker Technology Co., Limited
EUT : Bluetooth Speaker
Model No. : A7911
Serial No. : N.A.
Trade Mark : Anker
Rating : DC 5V, 500mA

Measurement Procedure Used:

FCC Part15 Subpart C, Paragraph 15.207, 15.249 & 15.209

The device described above is tested by Shenzhen Anbotek Compliance Laboratory Limited to determine the maximum emission levels emanating from the device and the severe levels of the device can endure and its performance criterion. The measurement results are contained in this test report and Shenzhen Anbotek Compliance Laboratory Limited is assumed full of responsibility for the accuracy and completeness of these measurements. Also, this report shows that the EUT (Equipment Under Test) is technically compliant with the FCC Part 15 Subpart C requirements.

This report applies to above tested sample only and shall not be reproduced in part without written approval of Shenzhen Anbotek Compliance Laboratory Limited.

Date of Test : Oct. 30~ Nov. 28, 2014

Prepared by :

Kebo Zhang

(Engineer / Kebo Zhang)

Amy Ding

Reviewer :

(Project Manager/Amy Ding)

Tom Chen

Approved & Authorized Signer :

(Manager/Tom Chen)

1. GENERAL INFORMATION

1.1. Description of Device (EUT)

EUT : Bluetooth Speaker

Model Number : A7911

Test Power Supply : DC 5V via adapter AC 120V, 60Hz/
DC 5V(With DC 3.7V Battery inside)

Frequency : 2402-2480MHz

No. of Channel : 79

Channel Space : 1MHz

Antenna Specification : Printed Antenna: 0 dBi

Applicant : Anker Technology Co., Limited
Address : Room 1318-19, Hollywood Commercial Center, 610 Nathan Road,
Mongkok, Kowloon, Hongkong

Manufacturer : Anker Technology Co., Limited
Address : Room 1318-19, Hollywood Commercial Center, 610 Nathan Road,
Mongkok, Kowloon, Hongkong

Factory : Wonder Technology Co., Ltd.
Address : DOSS Industrial Zone, Guiyue Road, Guanlan Town, Shenzhen,
China

Date of receiver : Oct. 30, 2014

Date of Test : Oct. 30~ Nov. 28, 2014

1.2. Auxiliary Equipment Used during Test

- Adapter : Power Supply
Model:MX12L3-0502000V
Input: AC 100-240V, 50-60Hz, 0.35A
Output: DC 5V, 2A
CE , FCC
- iPod : M/N: A1199
S/N: 7J712G0CVQ5
CE , FCC: DOC

1.3. Description of Test Facility

The test facility is recognized, certified, or accredited by the following organizations:

CNAS - LAB Code: L3503

Shenzhen Anbotek Compliance Laboratory Limited., Laboratory has been assessed and in compliance with CNAS/CL01: 2006 accreditation criteria for testing laboratories (identical to ISO/IEC 17025:2005 General Requirements) for the Competence of Testing Laboratories.

FCC-Registration No.: 752021

Shenzhen Anbotek Compliance Laboratory Limited, EMC Laboratory has been registered and fully described in a report filed with the (FCC) Federal Communications Commission. The acceptance letter from the FCC is maintained in our files. Registration 752021, July 10, 2013.

IC-Registration No.: 8058A-1

Shenzhen Anbotek Compliance Laboratory Limited., EMC Laboratory has been registered and fully described in a report filed with the (IC) Industry Canada. The acceptance letter from the IC is maintained in our files. Registration 8058A-1, February 22, 2013.

Test Location

All Emissions tests were performed at
Shenzhen Anbotek Compliance Laboratory Limited. at 1/F., Building 1, SEC
Industrial Park, No.0409 Qianhai Road, Nanshan District, Shenzhen, Guangdong,
China

1.4. Measurement Uncertainty

- Radiation Uncertainty : Ur = 4.3dB
Conduction Uncertainty : Uc = 3.4dB

2. Test Procedure

GENERAL: This report shall NOT be reproduced except in full without the written approval of Shenzhen Anbotek Compliance Laboratory Limited. The EUT was transmitting a test signal during the testing.

RADIATION INTERFERENCE: The test procedure used was ANSI STANDARD C63.4-2009 using a spectrum analyzer with a pre-selector. The analyzer was calibrated in dB above a microvolt at the output of the antenna. The resolution bandwidth was 100KHz and the video bandwidth was 300KHz up to 1.0GHz and 1.0MHz with a video BW of 3.0MHz above 1.0GHz. The ambient temperature of the EUT was 74.3oF with a humidity of 69%.

FORMULA OF CONVERSION FACTORS: The Field Strength at 3m was established by adding the meter reading of the spectrum analyzer (which is set to read in units of dBuV) to the antenna correction factor supplied by the antenna manufacturer. The antenna correction factors are stated in terms of dB. The gain of the Preselector was accounted for in the Spectrum Analyzer Meter Reading.

Example:

Freq (MHz) METER READING + ACF = FS
20 dBuV + 10.36 dB = 30.36 dBuV/m @ 3m

ANSI STANDARD C63.4-2009 10.1.7 MEASUREMENT PROCEDURES: The EUT was placed on a table 80 cm high and with dimensions of 1m by 1.5m. The EUT was placed in the center of the table (1.5m side). The table used for radiated measurements is capable of continuous rotation.

When an emission was found, the table was rotated to produce the maximum signal strength. At this point, the antenna was raised and lowered from 1m to 4m. The antenna was placed in both the horizontal and vertical planes.

3. Conducted Limits

Test Equipment

Item	Equipment	Manufacturer	Model No.	Serial No.	Last Cal.	Cal. Interval
1.	Two-Line V-network	Rohde & Schwarz	ENV216	100055	Apr. 22, 2014	1 Year
2.	EMI Test Receiver	Rohde & Schwarz	ESCI	100627	Apr. 22, 2014	1 Year
3.	RF Switching Unit	Compliance Direction	RSU-M2	38303	Apr. 22, 2014	1 Year

3.1. Block Diagram of Test Setup

3.1.1. Block diagram of connection between the EUT and simulators

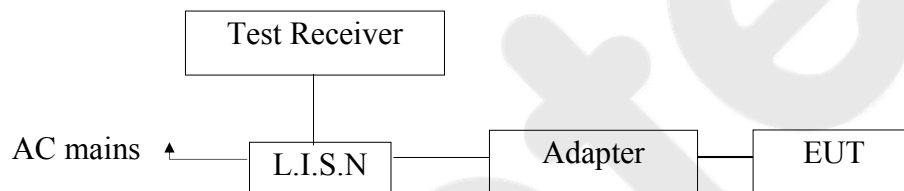

3.2. Power Line Conducted Emission Measurement Limits (15.207)

Frequency MHz	Limits dB(μV)	
	Quasi-peak Level	Average Level
0.15 ~ 0.50	66 ~ 56*	56 ~ 46*
0.50 ~ 5.00	56	46
5.00 ~ 30.00	60	50

- Notes: 1. *Decreasing linearly with logarithm of frequency.
2. The lower limit shall apply at the transition frequencies.

3.3. Configuration of EUT on Measurement

The following equipments are installed on Power Line Conducted Emission Measurement to meet the commission requirement and operating regulations in a manner which tends to maximize its emission characteristics in a normal application.

3.4. Operating Condition of EUT

- 3.4.1. Setup the EUT and simulator as shown as Section 3.1.
- 3.4.2. Turn on the power of all equipment.
- 3.4.3. Let the EUT work in test mode (Charging to adapter) and measure it.

3.5. Test Procedure

The EUT system is connected to the power mains through a line impedance stabilization network (L.I.S.N.). This provides a 50ohm coupling impedance for the EUT system. Please refer the block diagram of the test setup and photographs. Both sides of AC line are checked to find out the maximum conducted emission. In order to find the maximum emission levels, the relative positions of equipment and all of the interface cables shall be changed according to FCC ANSI C63.4-2003 on Conducted Emission Measurement.

The bandwidth of test receiver (ESCI) set at 9KHz.

The frequency range from 150KHz to 30MHz is checked.

The test results are reported on Section 3.6.

3.6. Power Line Conducted Emission Measurement Results

PASS.

The frequency range from 150KHz to 30 MHz is investigated.

Please refer the following pages.

CONDUCTED EMISSION TEST DATA

Test Site: 1# Shielded Room
 Operating Condition: Charging to adapter
 Test Specification: DC 5V via adapter AC 120V, 60Hz
 Comment: Live Line
 Tem:25°C Hum:50%

SCAN TABLE: "Voltage (150K~30M) FIN"

Short Description: 150K-30M Disturbance Voltages

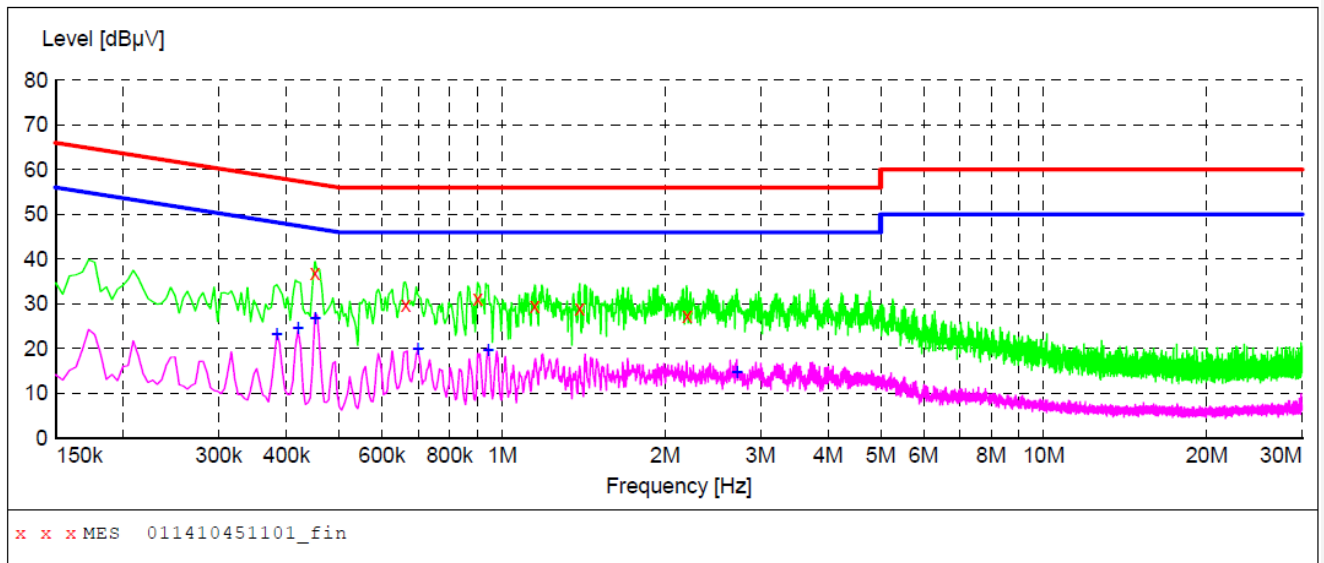

MEASUREMENT RESULT: "011410451101_fin"

10/31/2014 3:26PM

Frequency MHz	Level dBµV	Transd dB	Limit dBµV	Margin dB	Detector	Line	PE
0.451500	36.90	20.1	57	19.9	QP	L1	GND
0.663000	29.90	20.1	56	26.1	QP	L1	GND
0.901500	31.20	20.1	56	24.8	QP	L1	GND
1.148500	29.40	20.2	56	26.6	QP	L1	GND
1.391500	29.00	20.2	56	27.0	QP	L1	GND
2.192500	27.20	20.3	56	28.8	QP	L1	GND

MEASUREMENT RESULT: "011410451101_fin2"

10/31/2014 3:26PM

Frequency MHz	Level dBµV	Transd dB	Limit dBµV	Margin dB	Detector	Line	PE
0.384000	23.20	20.1	48	25.0	AV	L1	GND
0.420000	24.50	20.1	47	22.9	AV	L1	GND
0.451500	26.80	20.1	47	20.0	AV	L1	GND
0.699000	19.80	20.1	46	26.2	AV	L1	GND
0.942000	19.60	20.1	46	26.4	AV	L1	GND
2.714500	14.80	20.4	46	31.2	AV	L1	GND

CONDUCTED EMISSION TEST DATA

Test Site: 1# Shielded Room
 Operating Condition: Charging to adapter
 Test Specification: DC 5V via adapter AC 120V, 60Hz
 Comment: Neutral Line
 Tem:25°C Hum:50%

SCAN TABLE: "Voltage (150K~30M) FIN"

Short Description: 150K-30M Disturbance Voltages

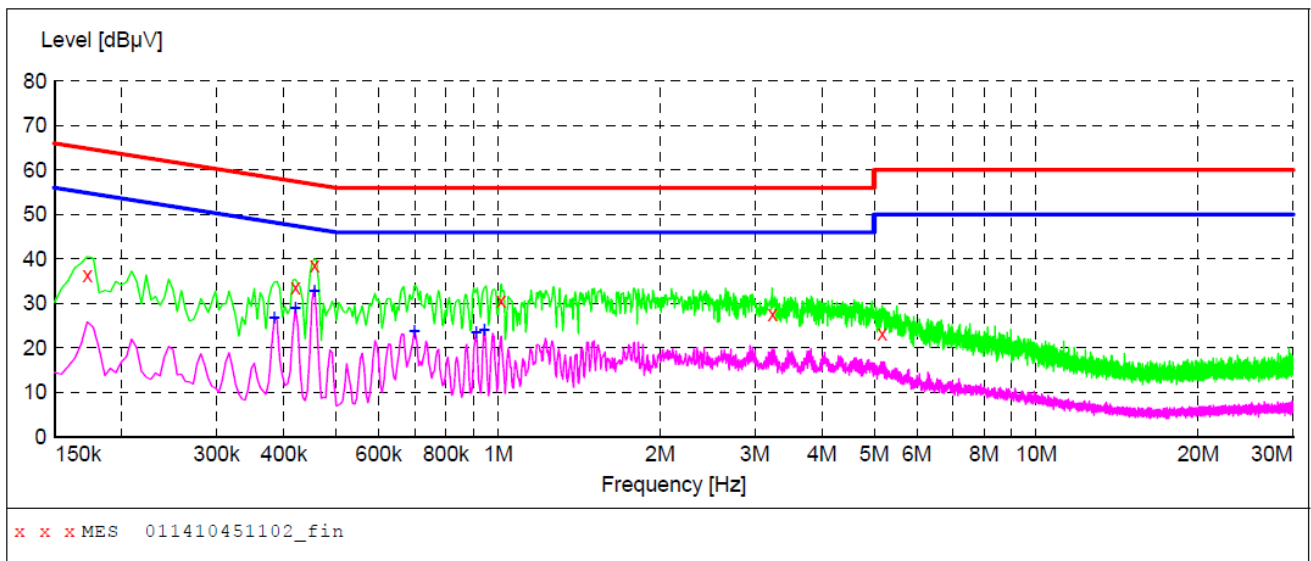

MEASUREMENT RESULT: "011410451102_fin"

10/31/2014 3:29PM

Frequency MHz	Level dBµV	Transd dB	Limit dBµV	Margin dB	Detector	Line	PE
0.172500	36.40	20.1	65	28.4	QP	N	GND
0.420000	33.60	20.1	57	23.8	QP	N	GND
0.456000	38.50	20.1	57	18.3	QP	N	GND
1.013500	30.70	20.2	56	25.3	QP	N	GND
3.232000	27.60	20.4	56	28.4	QP	N	GND
5.176000	23.30	20.5	60	36.7	QP	N	GND

MEASUREMENT RESULT: "011410451102_fin2"

10/31/2014 3:29PM

Frequency MHz	Level dBµV	Transd dB	Limit dBµV	Margin dB	Detector	Line	PE
0.384000	26.80	20.1	48	21.4	AV	N	GND
0.420000	28.90	20.1	47	18.5	AV	N	GND
0.456000	32.80	20.1	47	14.0	AV	N	GND
0.699000	23.80	20.1	46	22.2	AV	N	GND
0.910500	23.60	20.1	46	22.4	AV	N	GND
0.942000	24.10	20.1	46	21.9	AV	N	GND

4. Radiation Interference

4.1. Requirements (15.249, 15.209):

4.1.1. Test Limits (< 30 MHz)

Frequency (MHz)	Field Strength (microvolts/meter)	Measurement Distance (meter)
0.009-0.490	2400/F(kHz)	300
0.490-1.705	24000/F(kHz)	30
1.705-30.0	30	30

4.1.2. Test Limits (\geq 30 MHz)

FIELD STRENGTH of Fundamental: @3M	FIELD STRENGTH of Harmonics	S15.209	
902-928 MHz		30 - 88 MHz	40 dBuV/m
2.4-2.4835 GHz		88 - 216 MHz	43.5
94 dB μ V/m @3m	54 dB μ V/m @3m	216 - 960 MHz	46
		ABOVE 960 MHz	54dBuV/m

For range 9KHz~30MHz, The measured value is really too low to be recorded.

Emissions radiated outside of the specified frequency bands, except for harmonics, shall be attenuated by at least 50 dB below the level of the fundamental or to the general radiated emission limits in 15.209, whichever is the lesser attenuation.

4.2. Test Procedure

The EUT is placed on a turn table which is 0.8 meter high above the ground. The turn table can rotate 360 degrees to determine the position of the maximum emission level. The EUT is set 3 meters away from the receiving antenna which is mounted on a antenna tower. The antenna can be moved up and down from 1 to 4 meters to find out the maximum emission level. Both horizontal and vertical polarization of the antenna are set on test.

All readings from 30MHz to 1GHz are quasi-peak values with a resolution bandwidth of 120kHz. All reading are above 1GHz, peak & average values with a resolution bandwidth of 1MHz. The EUT is tested in 9*6*6 Chamber.

The test results are listed in Section 4.3.

Test Equipment

Item	Equipment	Manufacturer	Model No.	Serial No.	Last Cal.	Cal. Interval
1.	Spectrum Analysis	Agilent	E4407B	US39390582	Aug. 08, 2014	1 Year
2.	Preamplifier	Instruments corporation	EMC011830	980100	Aug. 08, 2014	1 Year
3.	EMI Test Receiver	Rohde & Schwarz	ESPI	101604	Apr. 22, 2014	1 Year
4.	Double Ridged Horn Antenna	Instruments corporation	GTH-0118	351600	Apr. 04, 2014	1 Year
5.	Bilog Broadband Antenna	Schwarzbeck	VULB9163	VULB 9163-289	Apr. 24, 2014	1 Year
6.	Pre-amplifier	SONOMA	310N	186860	Aug. 08, 2014	1 Year
7.	EMI Test Software EZ-EMC	SHURPLE	N/A	N/A	N/A	N/A

4.3. Test Configuration:

4.3.1. 9k to 30MHz emissions:

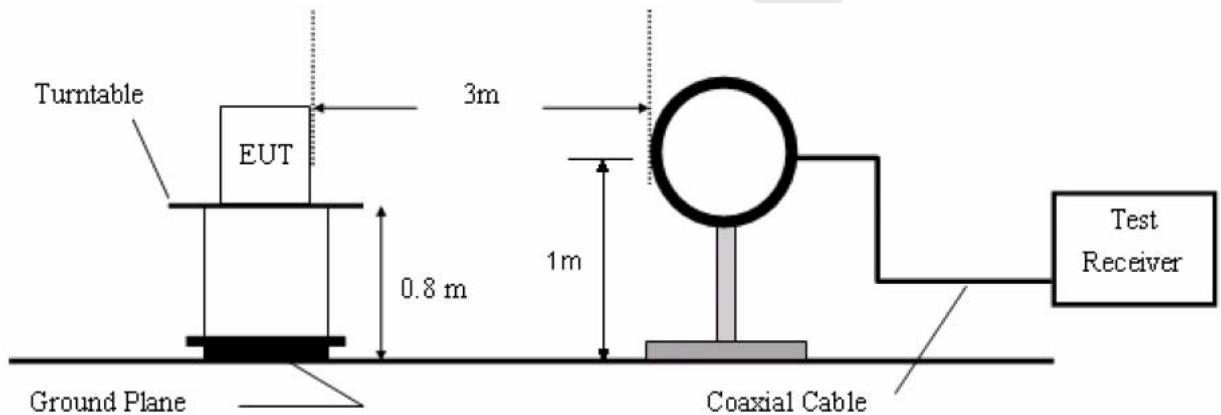

4.3.2. 30M to 1G emissions:

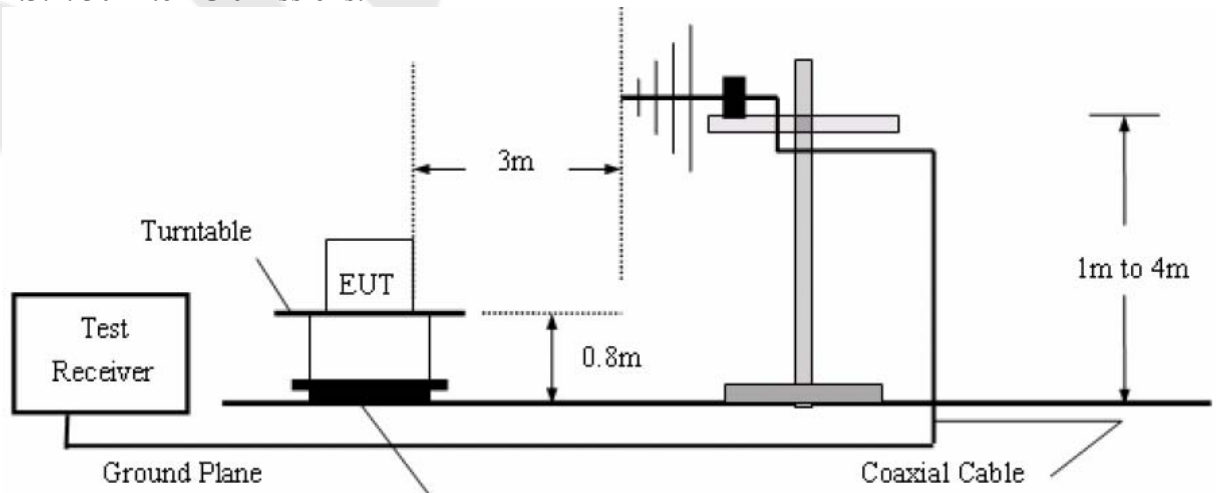

4.3.3. 1G to 40G emissions:

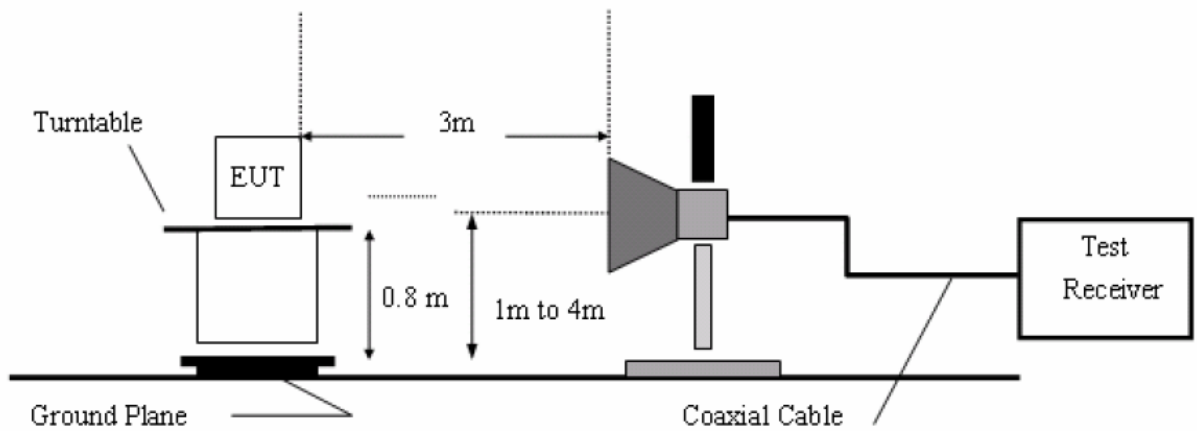

4.4. Test Results

PASS.

The EUT was tested on (Charging to adapter, TF Card Playing, BT Mode, AUX Mode) modes, only the worst data of (BT Mode(BDR)) are attached in the following pages.

Data:

Below 1GHz:

Job No.:	011410451E	Polarziation:	Horizontal
Standard:	(RE)FCC PART15 C_3m	Power Source:	DC 3.7V
Test item:	Radiation Test	Temp.(C)/Hum.(%RH):	24.3(C)/55%RH
Mode:	BT Mode(BDR)	Distance:	3m
Note:	30-1000MHz		

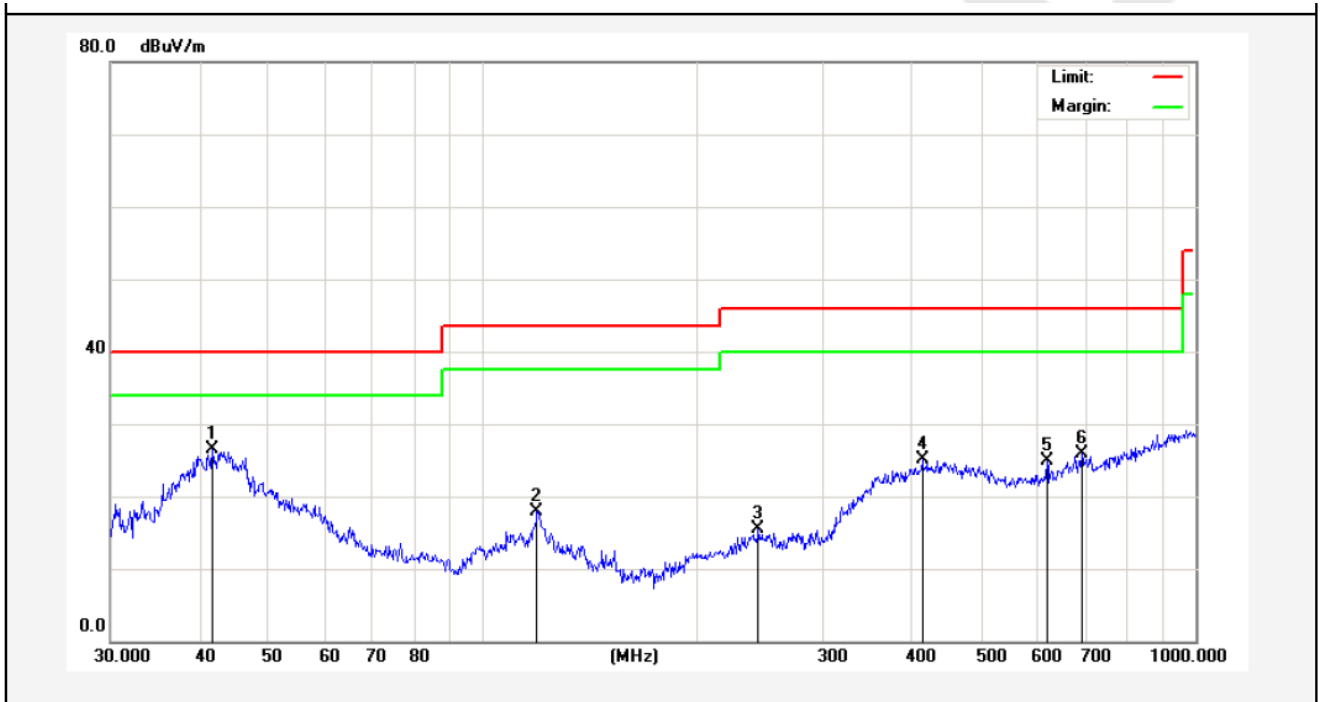

No.	Freq. (MHz)	Reading (dBuV/m)	Factor (dB/m)	Result (dBuV/m)	Limit (dBuV/)	Over Limit (dB)	Detector	Height (cm)	degree (deg)	Remark
1	41.7129	37.50	-11.05	26.45	40.00	-13.55	peak			
2	119.0180	39.17	-21.27	17.90	43.50	-25.60	peak			
3	243.3771	33.74	-18.24	15.50	46.00	-30.50	peak			
4	413.2706	37.56	-12.55	25.01	46.00	-20.99	peak			
5	618.5368	35.58	-10.72	24.86	46.00	-21.14	peak			
6	691.9867	34.57	-8.70	25.87	46.00	-20.13	peak			

Job No.: 011410451E **Polarziation:** Vertical
Standard: (RE)FCC PART15 C_3m **Power Source:** DC 3.7V
Test item: Radiation Test **Temp.(C)/Hum.(%RH):** 24.3(C)/55%RH
Mode: BT Mode(BDR) **Distance:** 3m
Note: 30-1000MHz

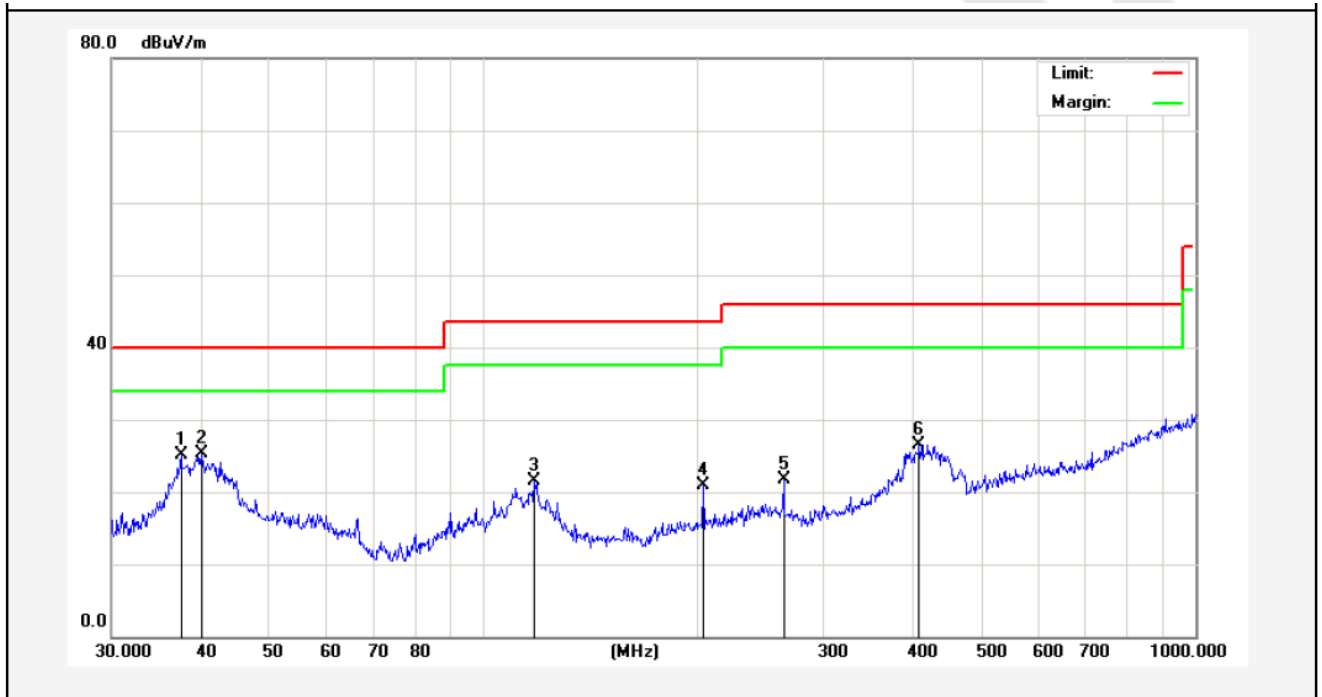

No.	Freq. (MHz)	Reading (dBuV/m)	Factor (dB/m)	Result (dBuV/m)	Limit (dBuV/)	Over Limit (dB)	Detector	Height (cm)	degree (deg)	Remark
1	37.5478	37.41	-12.30	25.11	40.00	-14.89	peak			
2	40.1347	35.71	-10.42	25.29	40.00	-14.71	peak			
3	117.7724	37.63	-16.18	21.45	43.50	-22.05	peak			
4	203.5227	36.64	-15.73	20.91	43.50	-22.59	peak			
5	263.8190	35.91	-14.22	21.69	46.00	-24.31	peak			
6	408.9460	38.09	-11.60	26.49	46.00	-19.51	peak			

Above 1 GHz:

The worst mode: BDR

Horizontal

CH Low (2402MHz)

Frequency MHz	Cable Loss dB	Ant Factor dB/m	Preamp Factor dB	Read Level dBμV	Level dBμV/m	Limit dBμV/m	Over Limit dB	Remark
2402.000	2.17	31.21	35.30	87.93	86.01	114.0	-27.99	Peak
2402.000	2.17	31.21	35.30	77.45	75.53	94.0	-18.47	AV
4804.000	2.56	34.01	34.71	48.69	50.55	74.0	-23.45	Peak
4804.000	2.56	34.01	34.71	34.57	36.43	54.0	-17.57	AV
7206.000	2.98	36.16	35.15	47.03	51.02	74.0	-22.98	Peak
7206.000	2.98	36.16	35.15	35.74	39.73	54.0	-14.27	AV
9608.000	---	---	---	---	---	---	---	---
9608.000	---	---	---	---	---	---	---	---
12010.000	---	---	---	---	---	---	---	---
12010.000	---	---	---	---	---	---	---	---
---	---	---	---	---	---	---	---	---

Vertical
CH Low (2402MHz)

Frequency MHz	Cable Loss dB	Ant Factor dB/m	Preamp Factor dB	Read Level dBμV	Level dBμV/m	Limit dBμV/m	Over Limit dB	Remark
2402.000	2.17	31.21	35.30	90.47	88.55	114.0	-25.45	Peak
2402.000	2.17	31.21	35.30	82.45	80.53	94.0	-13.47	AV
4804.000	2.56	34.01	34.71	47.97	49.83	74.0	-24.17	Peak
4804.000	2.56	34.01	34.71	35.85	37.71	54.0	-16.29	AV
7206.000	2.98	36.16	35.15	45.21	49.20	74.0	-24.80	Peak
7206.000	2.98	36.16	35.15	37.69	41.68	54.0	-12.32	AV
9608.000	---	---	---	---	---	---	---	---
9608.000	---	---	---	---	---	---	---	---
12010.000	---	---	---	---	---	---	---	---
12010.000	---	---	---	---	---	---	---	---
---	---	---	---	---	---	---	---	---

NOTE: “ --- ” in the table above means the reading of emissions are attenuated more than 20dB below the permissible limits or the field strength is too small to be measured. The results of different modulations are the same.

Horizontal
CH Middle (2441MHz)

Frequency MHz	Cable Loss dB	Ant Factor dB/m	Preamp Factor dB	Read Level dB μ V	Level dB μ V/m	Limit dB μ V/m	Over Limit dB	Remark
2441.000	2.19	31.22	34.60	92.14	90.95	114.0	-23.05	Peak
2441.000	2.19	31.22	34.60	80.32	79.13	94.0	-14.87	AV
4882.000	2.57	35.00	34.58	46.94	49.93	74.0	-24.07	Peak
4882.000	2.57	35.00	34.58	35.64	38.63	54.0	-15.37	AV
7323.000	3.00	36.17	35.14	43.67	47.70	74.0	-26.30	Peak
7323.000	3.00	36.17	35.14	33.62	37.65	54.0	-16.35	AV
9764.000	---	---	---	---	---	---	---	---
9764.000	---	---	---	---	---	---	---	---
12205.000	---	---	---	---	---	---	---	---
12205.000	---	---	---	---	---	---	---	---
---	---	---	---	---	---	---	---	---

Vertical
CH Middle (2441MHz)

Frequency MHz	Cable Loss dB	Ant Factor dB/m	Preamp Factor dB	Read Level dB μ V	Level dB μ V/m	Limit dB μ V/m	Over Limit dB	Remark
2441.000	2.19	31.22	34.60	91.47	90.28	114.0	-23.72	Peak
2441.000	2.19	31.22	34.60	78.64	77.45	94.0	-16.55	AV
4882.000	2.57	35.00	34.58	48.57	51.56	74.0	-22.44	Peak
4882.000	2.57	35.00	34.58	39.67	42.66	54.0	-11.34	AV
7323.000	3.00	36.17	35.14	52.13	56.16	74.0	-17.84	Peak
7323.000	3.00	36.17	35.14	32.19	36.22	54.0	-17.78	AV
9764.000	---	---	---	---	---	---	---	---
9764.000	---	---	---	---	---	---	---	---
12205.000	---	---	---	---	---	---	---	---
12205.000	---	---	---	---	---	---	---	---
---	---	---	---	---	---	---	---	---

NOTE: “ --- ” in the table above means the reading of emissions are attenuated more than 20dB below the permissible limits or the field strength is too small to be measured. The results of different modulations are the same.

Horizontal
CH High (2480MHz)

Frequency MHz	Cable Loss dB	Ant Factor dB/m	Preamp Factor dB	Read Level dB μ V	Level dB μ V/m	Limit dB μ V/m	Over Limit dB	Remark
2480.000	2.20	31.65	36.00	93.01	90.86	114.0	-23.14	Peak
2480.000	2.20	31.65	36.00	84.78	82.63	94.0	-11.37	AV
4960.000	2.58	35.06	34.79	52.47	55.32	74.0	-18.68	Peak
4960.000	2.58	35.06	34.79	34.67	37.52	54.0	-16.48	AV
7440.000	3.02	36.19	34.90	48.55	52.86	74.0	-21.14	Peak
7440.000	3.02	36.20	35.20	36.15	40.17	54.0	-13.83	AV
9920.000	---	---	---	---	---	---	---	---
9920.000	---	---	---	---	---	---	---	---
12400.000	---	---	---	---	---	---	---	---
12400.000	---	---	---	---	---	---	---	---
---	---	---	---	---	---	---	---	---

Vertical
CH High (2480MHz)

Frequency MHz	Cable Loss dB	Ant Factor dB/m	Preamp Factor dB	Read Level dB μ V	Level dB μ V/m	Limit dB μ V/m	Over Limit dB	Remark
2480.000	2.20	31.65	36.00	96.54	94.39	114.0	-19.61	Peak
2480.000	2.20	31.65	36.00	81.27	79.12	94.0	-14.88	AV
4960.000	2.58	35.06	34.79	48.74	51.59	74.0	-22.41	Peak
4960.000	2.58	35.06	34.79	37.29	40.14	54.0	-13.86	AV
7440.000	3.02	36.19	34.90	48.01	52.32	74.0	-21.68	Peak
7440.000	3.02	36.20	35.20	39.40	43.42	54.0	-10.58	AV
9920.000	---	---	---	---	---	---	---	---
9920.000	---	---	---	---	---	---	---	---
12400.000	---	---	---	---	---	---	---	---
12400.000	---	---	---	---	---	---	---	---
---	---	---	---	---	---	---	---	---

NOTE: “ --- ” in the table above means the reading of emissions are attenuated more than 20dB below the permissible limits or the field strength is too small to be measured. The results of different modulations are the same.

5. Occupied Bandwidth

5.1. Requirements (15.249):

The field strength of any emissions appearing outside the band edges and up to 10 kHz above and below the band edges shall be attenuated at least 50 dB below the level of the carrier or to the general limits of 15.249.

5.2. Test Procedure

The EUT is placed on a turn table which is 0.8 meter high above the ground. The turn table can rotate 360 degrees to determine the position of the maximum emission level. The EUT is set 3 meters away from the receiving antenna which is mounted on a antenna tower. The antenna can be moved up and down from 1 to 4 meters to find out the maximum emission level. Both horizontal and vertical polarization of the antenna are set on test.

Test Equipment

Item	Equipment	Manufacturer	Model No.	Serial No.	Last Cal.	Cal. Interval
1.	Spectrum Analysis	Agilent	E4407B	US39390582	Aug. 08, 2014	1 Year
2.	Preamplifier	Instruments corporation	EMC011830	980100	Aug. 08, 2014	1 Year
3.	EMI Test Receiver	Rohde & Schwarz	ESPI	101604	Apr. 22, 2014	1 Year
4.	Double Ridged Horn Antenna	Instruments corporation	GTH-0118	351600	Apr. 04, 2014	1 Year
5.	Bilog Broadband Antenna	Schwarzbeck	VULB9163	VULB 9163-289	Apr. 24, 2014	1 Year
6.	Pre-amplifier	SONOMA	310N	186860	Aug. 08, 2014	1 Year
7.	EMI Test Software EZ-EMC	SHURPLE	N/A	N/A	N/A	N/A

5.3. Test Configuration:

Same as the test configuration in 4.3.

5.4. Test Results

Pass.

Please refer the following plot.

(Note: Marker 3 means the highest value in 2.39GHz~2.4GHz or 2.4835~2.5GHz)

The worst mode: BDR

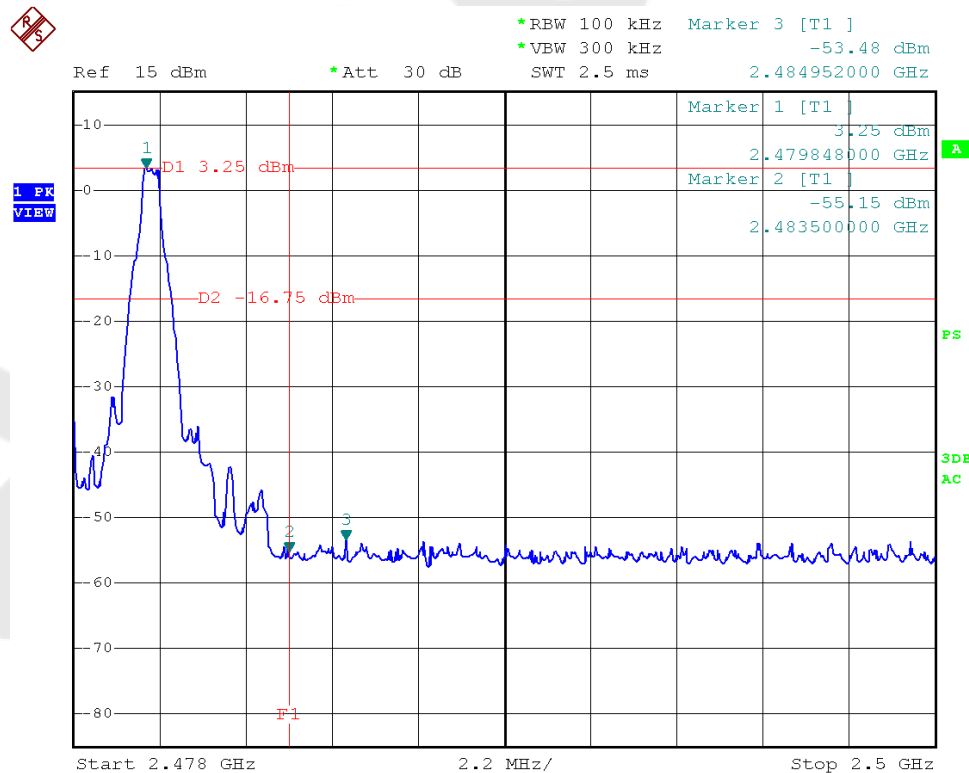
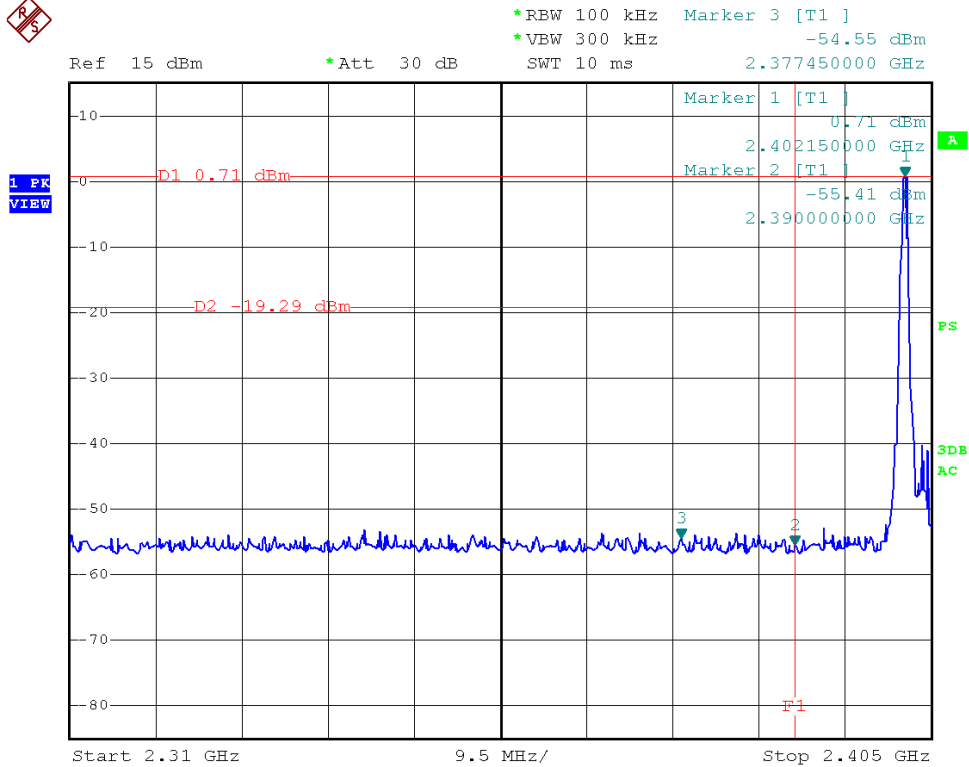

The worst mode: BDR
20dB Down:



1 PK
MAXH

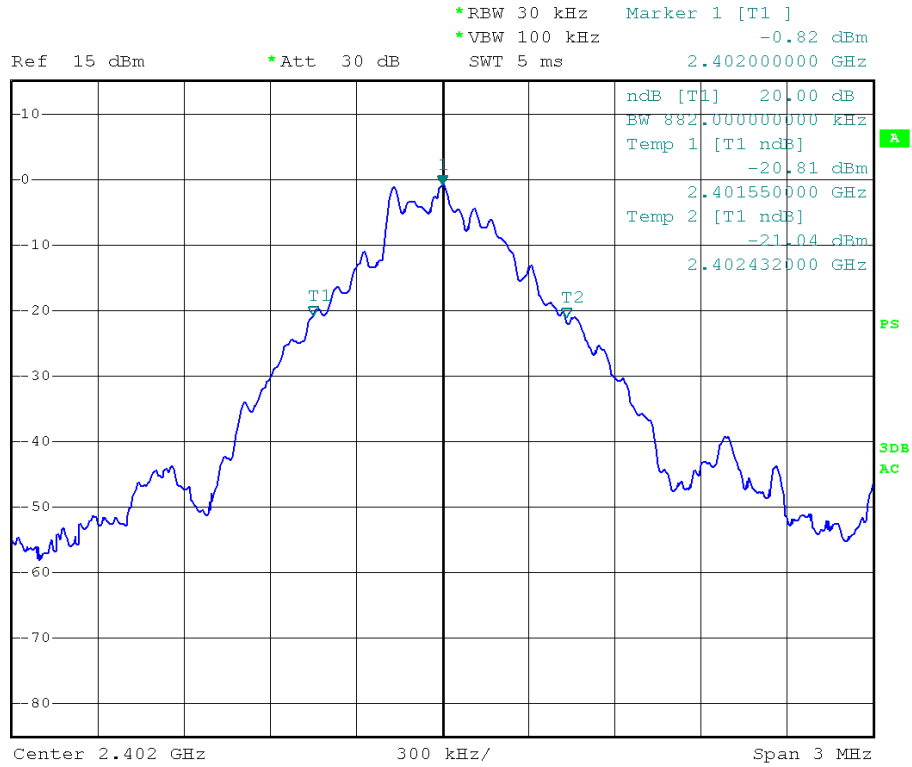

1 PK
MAXH

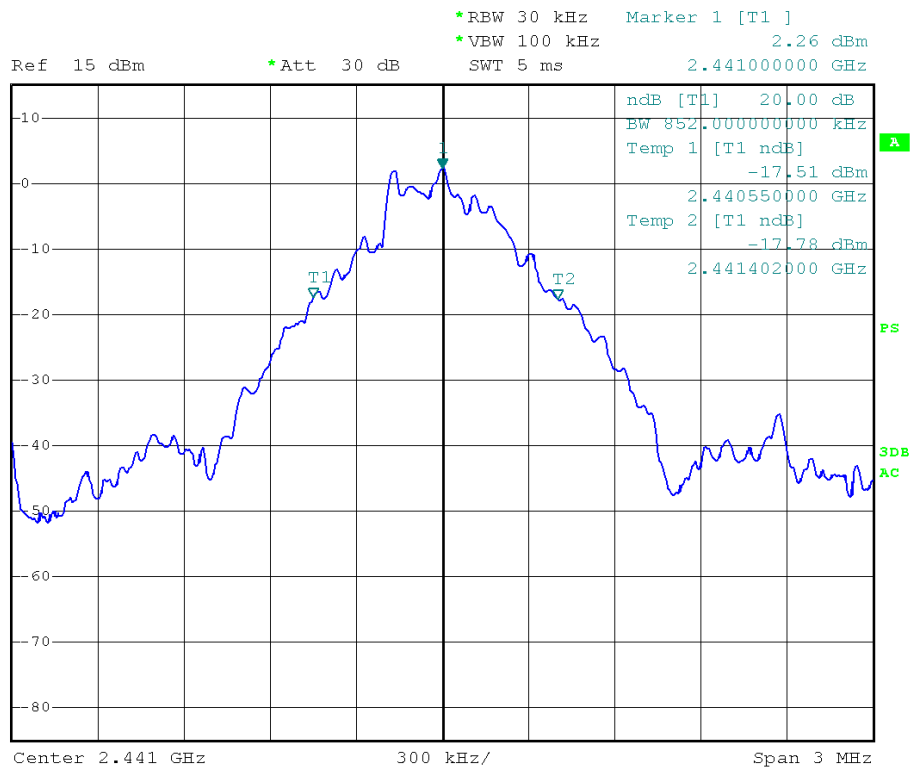

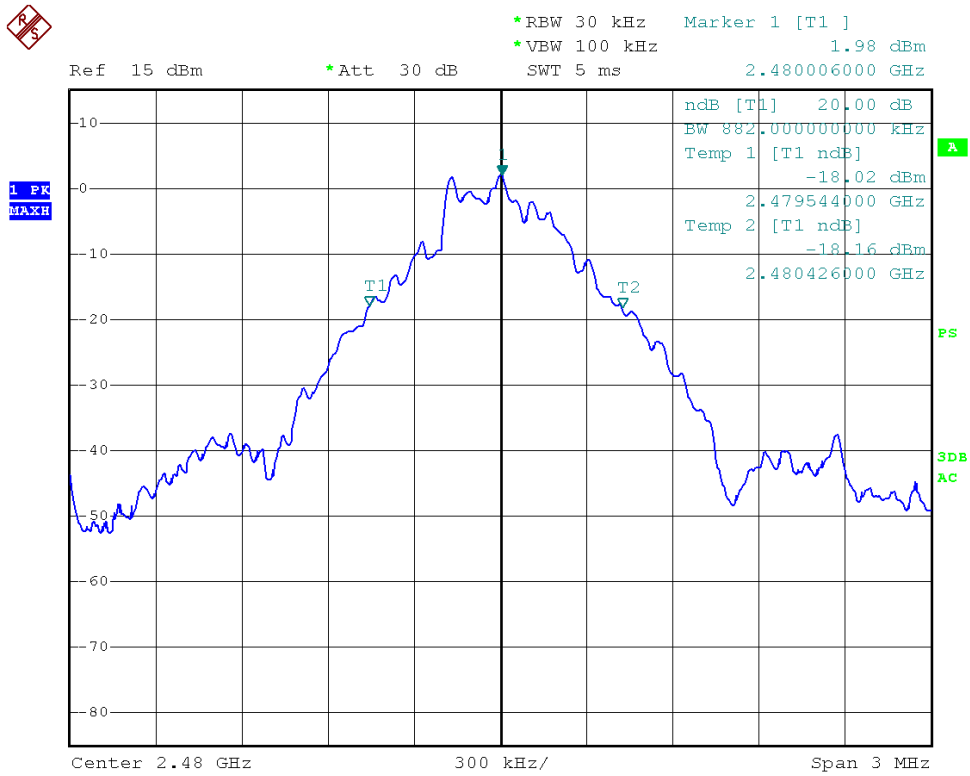

Anbotek

6. PHOTOGRAPH

6.1. Photo of Conducted Emission Test



6.2. Photo of Radiation Emission Test

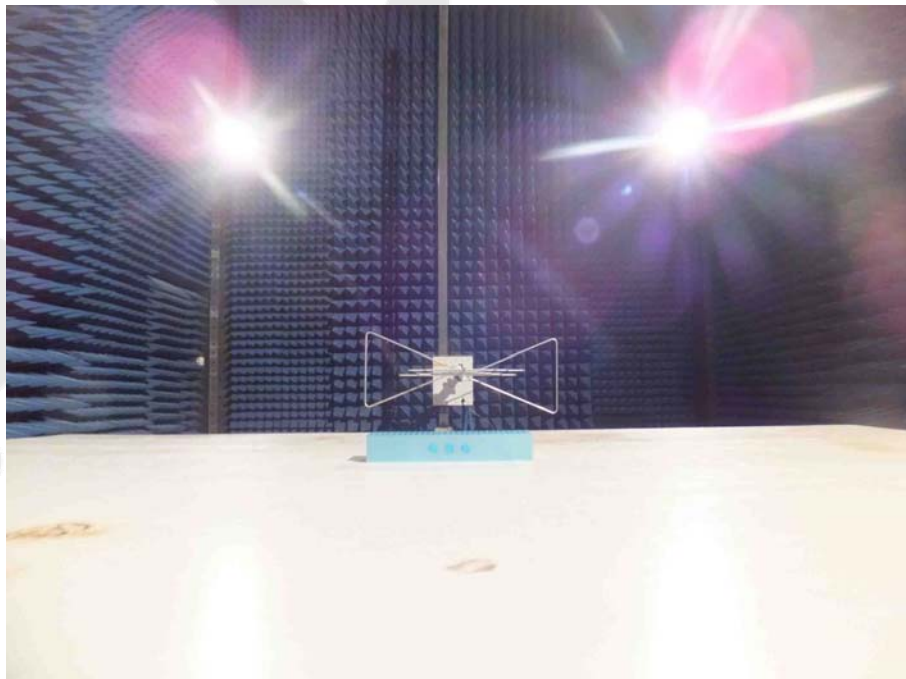

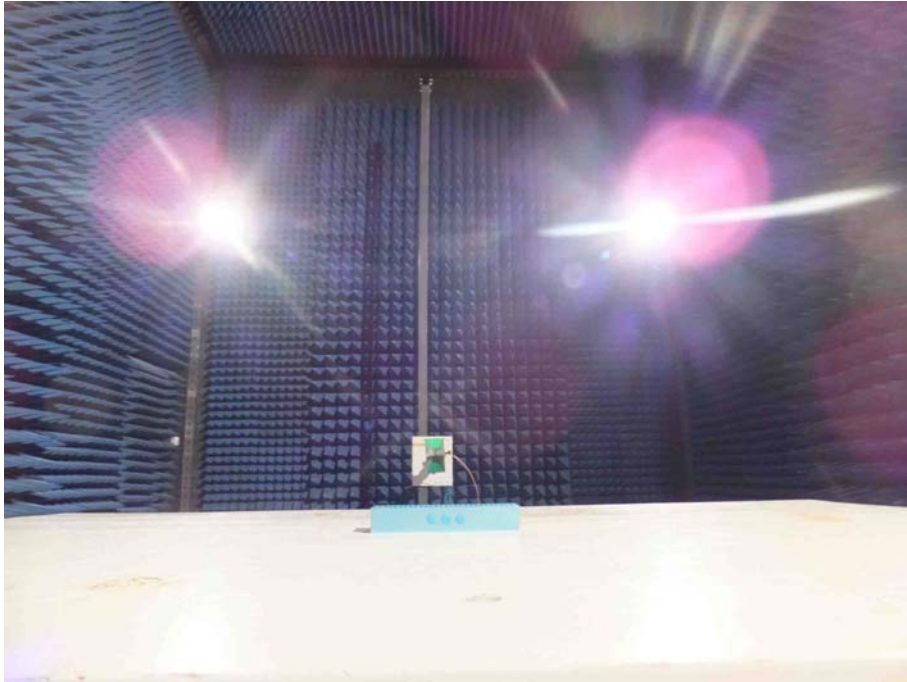

Anbotek

APPENDIX I (EXTERNAL PHOTOS)

Figure 1
The EUT- Front View

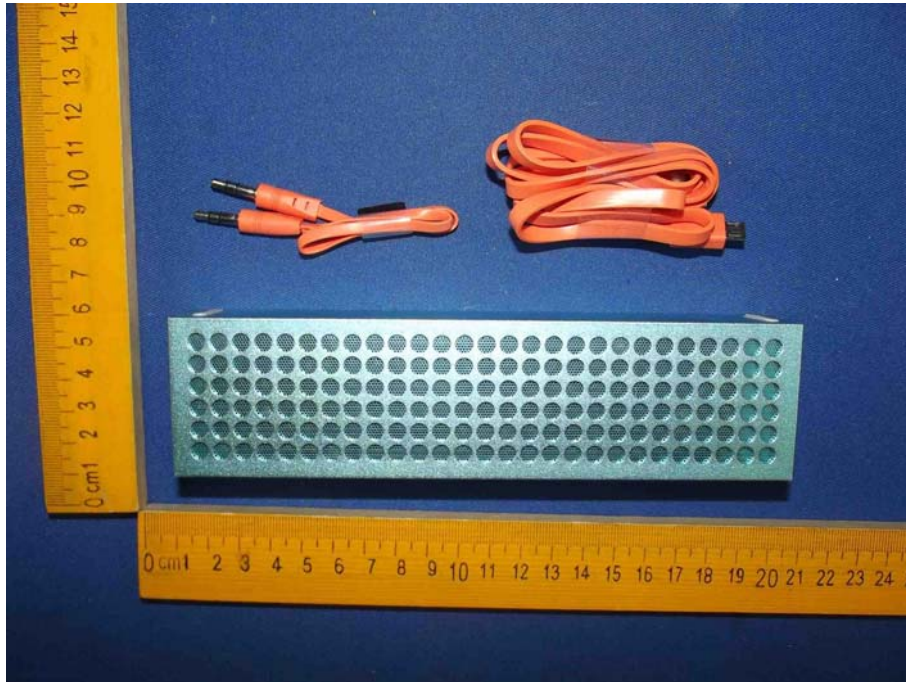

Figure 2
The EUT- Back View



Figure 3
The EUT- Top View

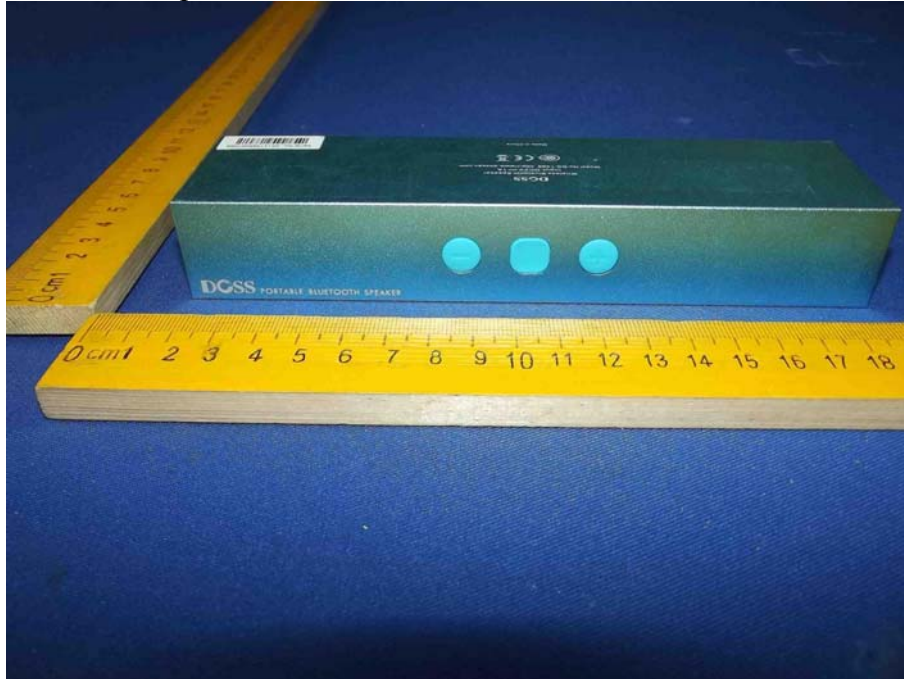

Figure 4
The EUT- Bottom View

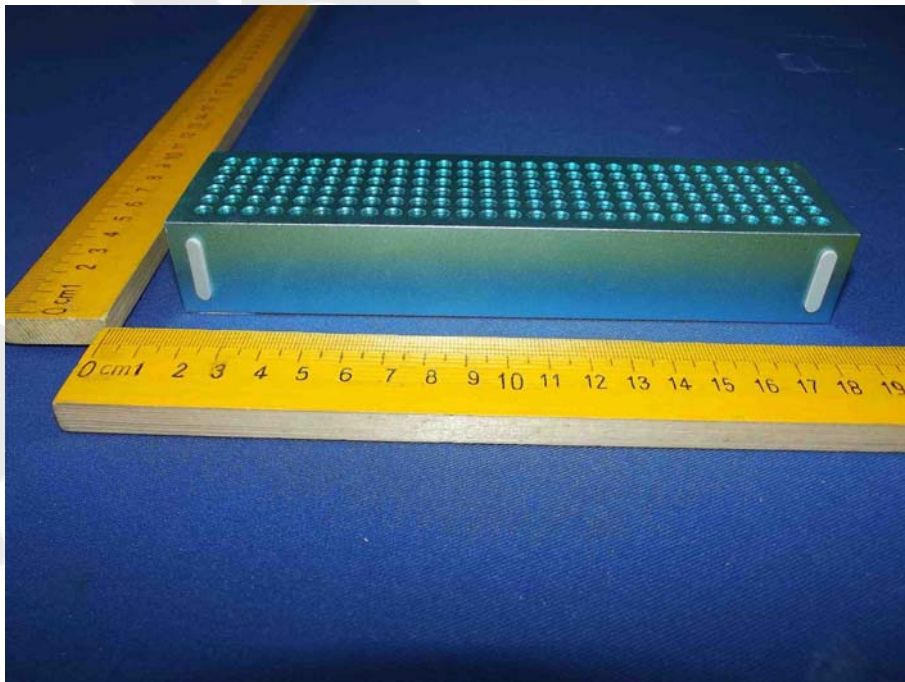

Figure 5
The EUT- Right View

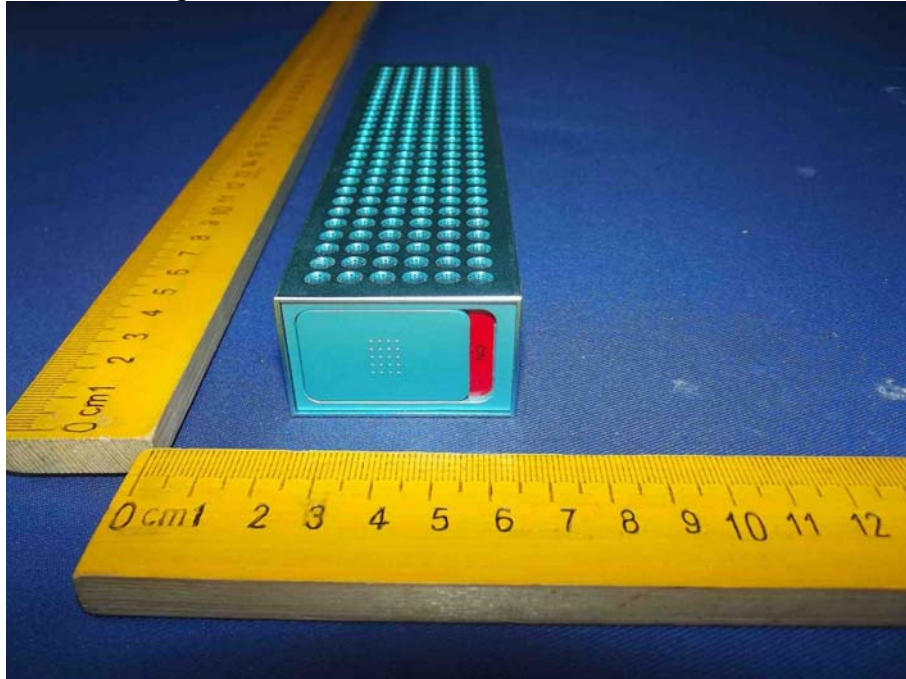
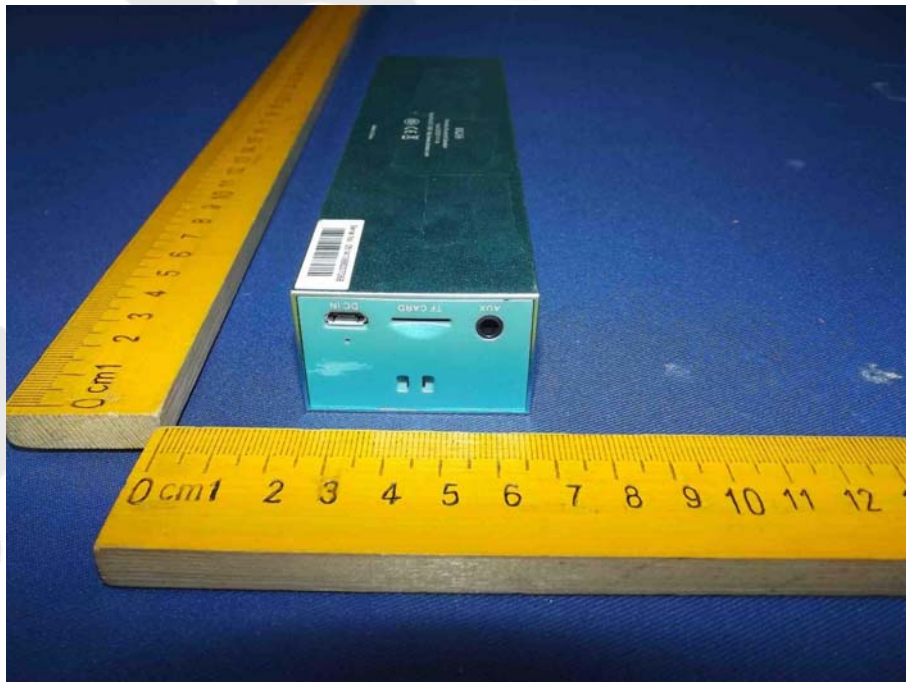

Figure 6
The EUT- Left View



APPENDIX II (INTERNAL PHOTOS)

Figure 7
The EUT-Inside View

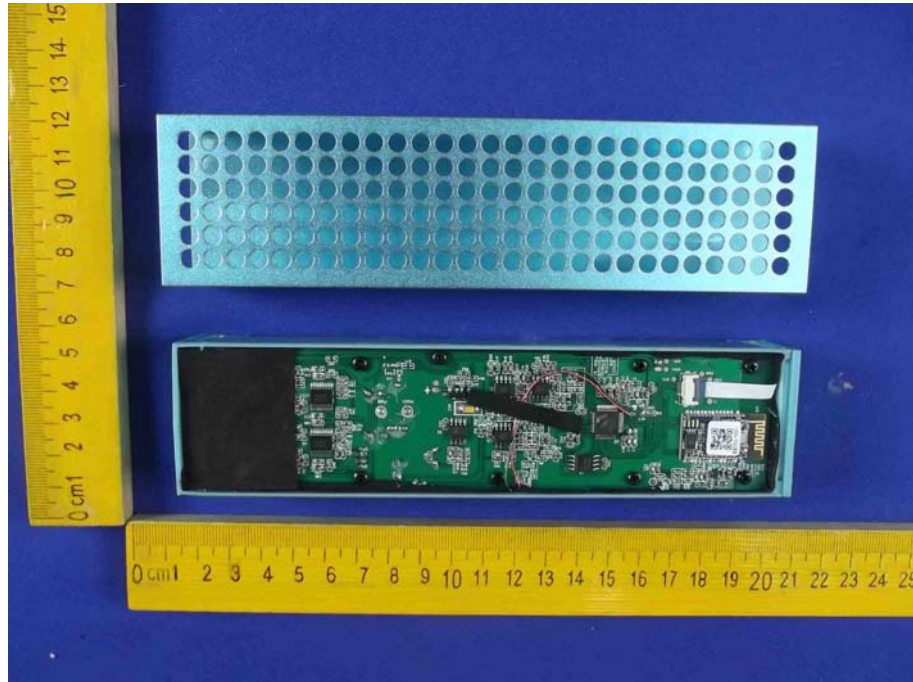

Figure 8
The EUT-Inside View

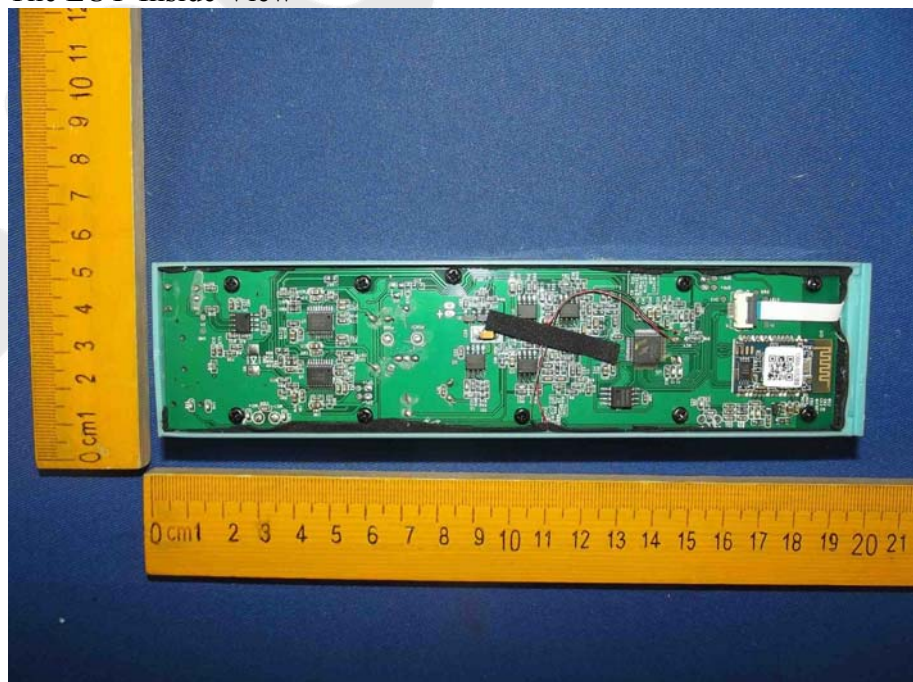

Figure 9
The EUT-Inside View

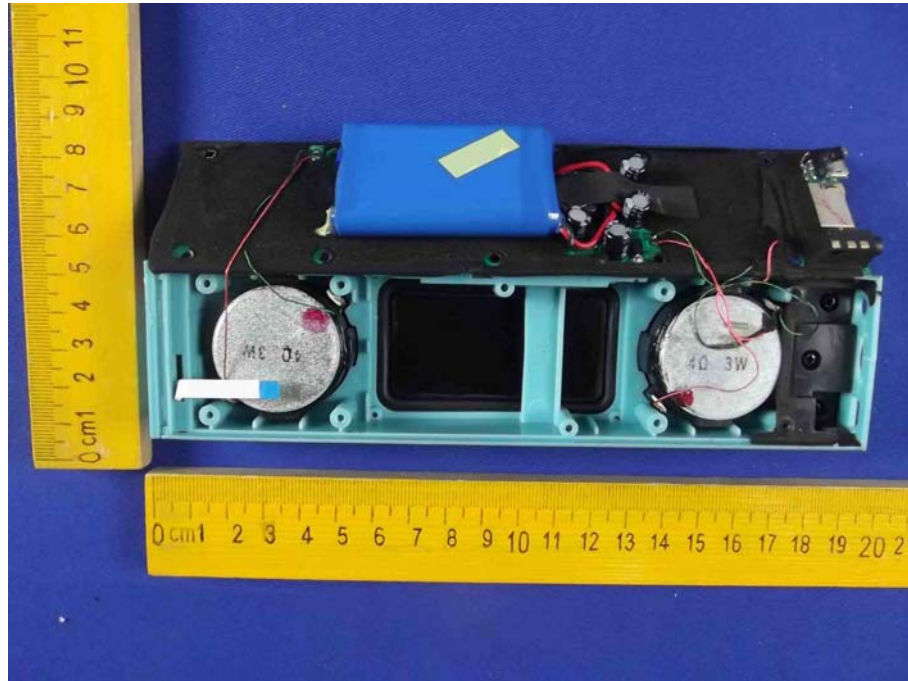

Figure 10
PCB of the EUT-Front View

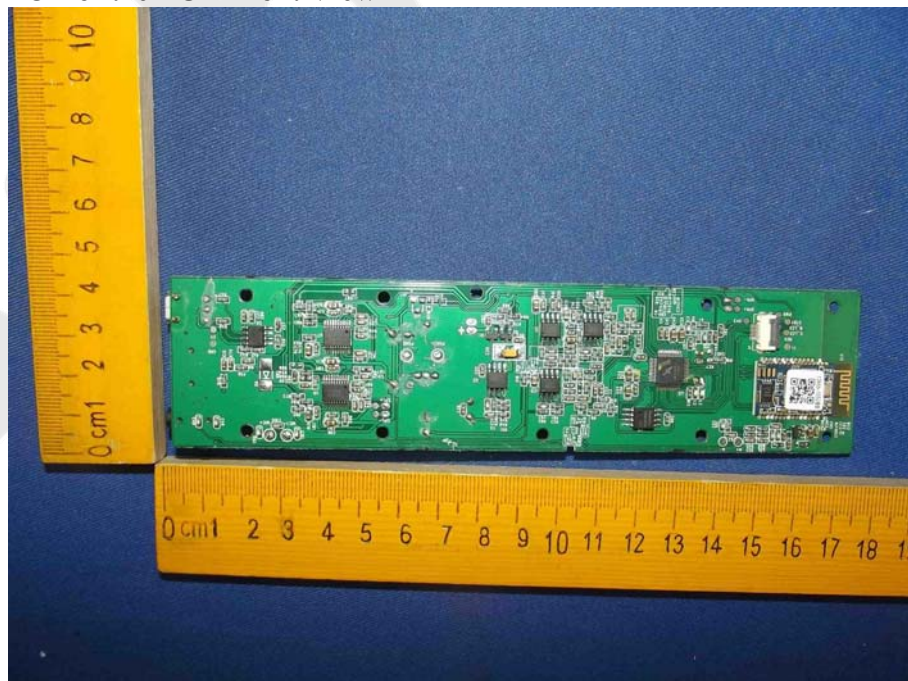

Figure 11
PCB of the EUT-Back View

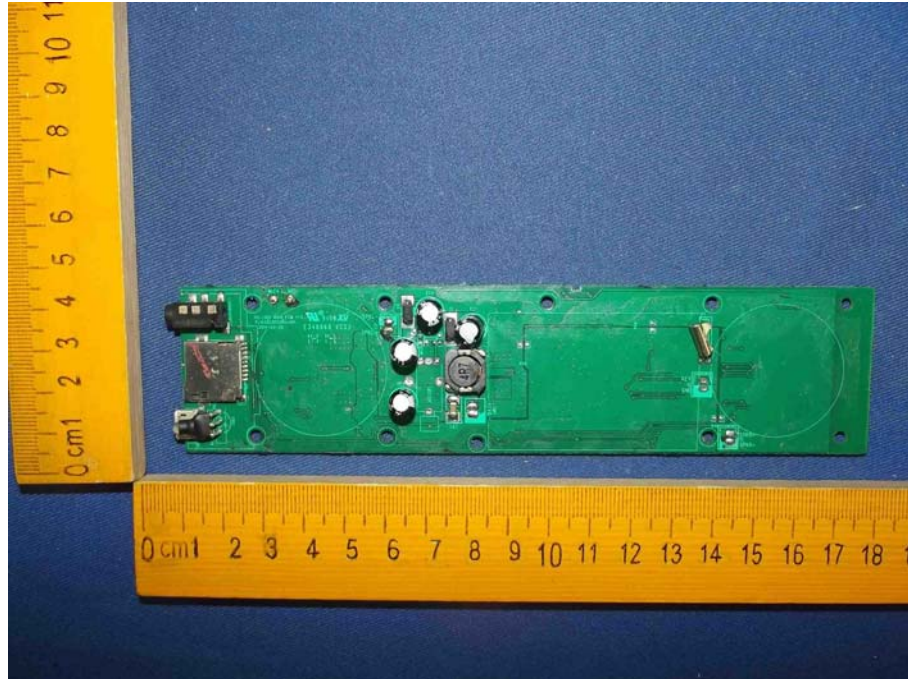
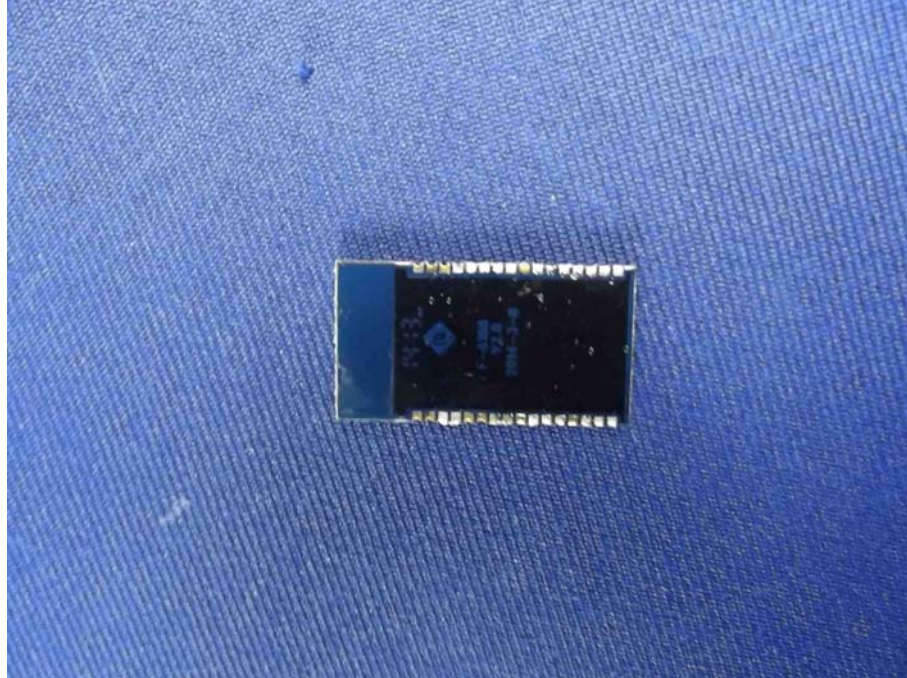

Figure 12
PCB of the EUT-Front View



Figure 13
PCB of the EUT-Back View



Anbotek