

FCC TEST REPORT  
for  
Anker Technology Co., Limited

Bluetooth Speaker  
Model No.: A7909

Prepared for : Anker Technology Co., Limited  
Address : Room 1318-19, Hollywood Commercial Center, 610 Nathan  
Road, Mongkok, Kowloon, Hongkong

Prepared By : Shenzhen Anbotek Compliance Laboratory Limited  
Address : 1/F., Building 1, SEC Industrial Park, No.0409 Qianhai Road,  
Nanshan District, Shenzhen, Guangdong, China  
Tel: (86) 755-26066544  
Fax: (86) 755-26014772

Report Number : R011409054E  
Date of Test : Oct. 13~ Nov. 11, 2014  
Date of Report : Nov. 18, 2014

## TABLE OF CONTENTS

Description	Page
Test Report	
<b>1. GENERAL INFORMATION.....</b>	<b>4</b>
1.1. Description of Device (EUT).....	4
1.2. Auxiliary Equipment Used during Test.....	5
1.3. Description of Test Facility.....	5
1.4. Measurement Uncertainty.....	5
<b>2. TEST PROCEDURE.....</b>	<b>6</b>
<b>3. CONDUCTED LIMITS.....</b>	<b>7</b>
3.1. Block Diagram of Test Setup.....	7
3.2. Power Line Conducted Emission Measurement Limits (15.207).....	7
3.3. Configuration of EUT on Measurement.....	7
3.4. Operating Condition of EUT.....	7
3.5. Test Procedure.....	8
3.6. Power Line Conducted Emission Measurement Results.....	8
<b>4. RADIATION INTERFERENCE.....</b>	<b>11</b>
4.1. Requirements (15.249, 15.209):.....	11
4.2. Test Procedure.....	11
4.3. Test Configuration:.....	12
4.4. Test Results.....	13
<b>5. OCCUPIED BANDWIDTH.....</b>	<b>19</b>
5.1. Requirements (15.249):.....	19
5.2. Test Procedure.....	19
5.3. Test Configuration:.....	19
5.4. Test Results.....	19
<b>6. PHOTOGRAPH.....</b>	<b>23</b>
6.1. Photo of Conducted Emission Test.....	23
6.2. Photo of Radiation Emission Test.....	23
<b>APPENDIX I (EXTERNAL PHOTOS).....</b>	<b>25</b>
<b>APPENDIX II(INTERNAL PHOTOS).....</b>	<b>28</b>

Appendix I (3 Pages)  
 Appendix II (5 Pages)

## TEST REPORT

Applicant : Anker Technology Co., Limited  
Manufacturer : Anker Technology Co., Limited  
EUT : Bluetooth Speaker  
Model No. : A7909  
Serial No. : N.A.  
Trade Mark : Anker  
Rating : DC 5V, 1.7A

Measurement Procedure Used:

FCC Part15 Subpart C, Paragraph 15.207, 15.249 & 15.209

The device described above is tested by Shenzhen Anbotek Compliance Laboratory Limited to determine the maximum emission levels emanating from the device and the severe levels of the device can endure and its performance criterion. The measurement results are contained in this test report and Shenzhen Anbotek Compliance Laboratory Limited is assumed full of responsibility for the accuracy and completeness of these measurements. Also, this report shows that the EUT (Equipment Under Test) is technically compliant with the FCC Part 15 Subpart C requirements.

This report applies to above tested sample only and shall not be reproduced in part without written approval of Shenzhen Anbotek Compliance Laboratory Limited.

Date of Test : Oct. 13~ Nov. 11, 2014

Prepared by :

*Kebo Zhang*

(Engineer / Kebo Zhang)

*Amy Ding*

Reviewer :

(Project Manager/Amy Ding)

*Tom Chen*

Approved & Authorized Signer :

(Manager/Tom Chen)

## 1. GENERAL INFORMATION

### 1.1. Description of Device (EUT)

EUT : Bluetooth Speaker

Model Number : A7909

Test Power Supply : DC 5V via adapter AC 120V, 60Hz/  
DC 5V(With DC 3.7V Battery inside)

Frequency : 2402-2480MHz

No. of Channel : 79

Channel Space : 1MHz

Antenna Specification : Printed Antenna: 2 dBi

Applicant : Anker Technology Co., Limited  
Address : Room 1318-19, Hollywood Commercial Center, 610 Nathan Road,  
Mongkok, Kowloon, Hongkong

Manufacturer : Anker Technology Co., Limited  
Address : Room 1318-19, Hollywood Commercial Center, 610 Nathan Road,  
Mongkok, Kowloon, Hongkong

Factory : Anker Technology Co., Limited  
Address : Room 1318-19, Hollywood Commercial Center, 610 Nathan Road,  
Mongkok, Kowloon, Hongkong

Date of receiver : Oct. 13, 2014

Date of Test : Oct. 13~ Nov. 11, 2014

## 1.2. Auxiliary Equipment Used during Test

Adapter : Power Supply  
Model:MX12L3-0502000V  
Input: AC 100-240V, 50-60Hz, 0.35A  
Output: DC 5V, 2A  
CE , FCC

## 1.3. Description of Test Facility

The test facility is recognized, certified, or accredited by the following organizations:

### **CNAS - LAB Code: L3503**

Shenzhen Anbotek Compliance Laboratory Limited., Laboratory has been assessed and in compliance with CNAS/CL01: 2006 accreditation criteria for testing laboratories (identical to ISO/IEC 17025:2005 General Requirements) for the Competence of Testing Laboratories.

### **FCC-Registration No.: 752021**

Shenzhen Anbotek Compliance Laboratory Limited, EMC Laboratory has been registered and fully described in a report filed with the (FCC) Federal Communications Commission. The acceptance letter from the FCC is maintained in our files. Registration 752021, July 10, 2013.

### **IC-Registration No.: 8058A-1**

Shenzhen Anbotek Compliance Laboratory Limited., EMC Laboratory has been registered and fully described in a report filed with the (IC) Industry Canada. The acceptance letter from the IC is maintained in our files. Registration 8058A-1, February 22, 2013.

### **Test Location**

All Emissions tests were performed at  
Shenzhen Anbotek Compliance Laboratory Limited. at 1/F., Building 1, SEC Industrial Park, No.0409 Qianhai Road, Nanshan District, Shenzhen, Guangdong, China

## 1.4. Measurement Uncertainty

Radiation Uncertainty : Ur = 4.3dB  
Conduction Uncertainty : Uc = 3.4dB

## 2. Test Procedure

**GENERAL:** This report shall NOT be reproduced except in full without the written approval of Shenzhen Anbotek Compliance Laboratory Limited. The EUT was transmitting a test signal during the testing.

**RADIATION INTERFERENCE:** The test procedure used was ANSI STANDARD C63.4-2009 using a spectrum analyzer with a pre-selector. The analyzer was calibrated in dB above a microvolt at the output of the antenna. The resolution bandwidth was 100KHz and the video bandwidth was 300KHz up to 1.0GHz and 1.0MHz with a video BW of 3.0MHz above 1.0GHz. The ambient temperature of the EUT was 74.3oF with a humidity of 69%.

**FORMULA OF CONVERSION FACTORS:** The Field Strength at 3m was established by adding the meter reading of the spectrum analyzer (which is set to read in units of dBuV) to the antenna correction factor supplied by the antenna manufacturer. The antenna correction factors are stated in terms of dB. The gain of the Preselector was accounted for in the Spectrum Analyzer Meter Reading.

**Example:**

Freq (MHz) METER READING + ACF = FS  
20 dBuV + 10.36 dB = 30.36 dBuV/m @ 3m

**ANSI STANDARD C63.4-2009 10.1.7 MEASUREMENT PROCEDURES:** The EUT was placed on a table 80 cm high and with dimensions of 1m by 1.5m. The EUT was placed in the center of the table (1.5m side). The table used for radiated measurements is capable of continuous rotation.

When an emission was found, the table was rotated to produce the maximum signal strength. At this point, the antenna was raised and lowered from 1m to 4m. The antenna was placed in both the horizontal and vertical planes.

### 3. Conducted Limits

#### Test Equipment

Item	Equipment	Manufacturer	Model No.	Serial No.	Last Cal.	Cal. Interval
1.	Two-Line V-network	Rohde & Schwarz	ENV216	100055	Apr. 22, 2014	1 Year
2.	EMI Test Receiver	Rohde & Schwarz	ESCI	100627	Apr. 22, 2014	1 Year
3.	RF Switching Unit	Compliance Direction	RSU-M2	38303	Apr. 22, 2014	1 Year

#### 3.1. Block Diagram of Test Setup

##### 3.1.1. Block diagram of connection between the EUT and simulators

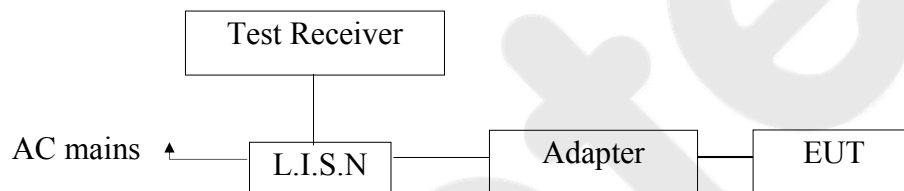

#### 3.2. Power Line Conducted Emission Measurement Limits (15.207)

Frequency MHz	Limits dB(μV)	
	Quasi-peak Level	Average Level
0.15 ~ 0.50	66 ~ 56*	56 ~ 46*
0.50 ~ 5.00	56	46
5.00 ~ 30.00	60	50

- Notes: 1. \*Decreasing linearly with logarithm of frequency.  
2. The lower limit shall apply at the transition frequencies.

#### 3.3. Configuration of EUT on Measurement

The following equipments are installed on Power Line Conducted Emission Measurement to meet the commission requirement and operating regulations in a manner which tends to maximize its emission characteristics in a normal application.

#### 3.4. Operating Condition of EUT

- 3.4.1. Setup the EUT and simulator as shown as Section 3.1.
- 3.4.2. Turn on the power of all equipment.
- 3.4.3. Let the EUT work in test mode (Charging to adapter) and measure it.

### 3.5. Test Procedure

The EUT system is connected to the power mains through a line impedance stabilization network (L.I.S.N.). This provides a 50ohm coupling impedance for the EUT system. Please refer the block diagram of the test setup and photographs. Both sides of AC line are checked to find out the maximum conducted emission. In order to find the maximum emission levels, the relative positions of equipment and all of the interface cables shall be changed according to FCC ANSI C63.4-2003 on Conducted Emission Measurement.

The bandwidth of test receiver (ESCI) set at 9KHz.

The frequency range from 150KHz to 30MHz is checked.

The test results are reported on Section 3.6.

### 3.6. Power Line Conducted Emission Measurement Results

**PASS.**

The frequency range from 150KHz to 30 MHz is investigated.

Please refer the following pages.



**CONDUCTED EMISSION TEST DATA**

Test Site: 1# Shielded Room  
 Operating Condition: Charging to adapter  
 Test Specification: DC 5V via adapter AC 120V, 60Hz  
 Comment: Live Line  
 Tem:25°C Hum:50%

**SCAN TABLE: "Voltage (150K~30M) FIN"**

Short Description: 150K-30M Disturbance Voltages

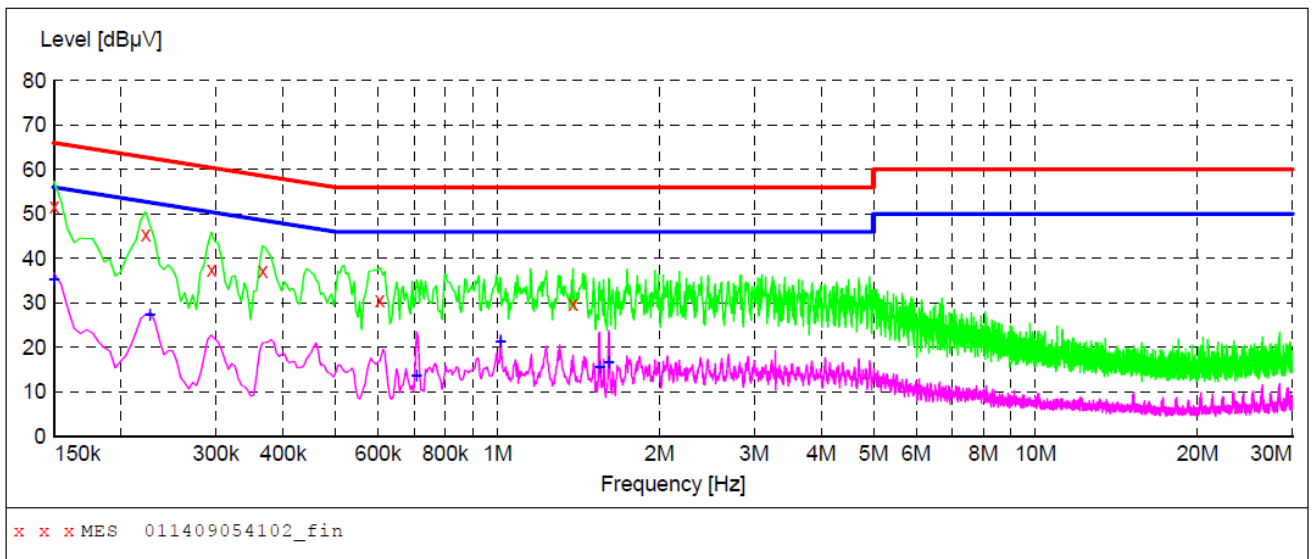

**MEASUREMENT RESULT: "011409054102\_fin"**

10/14/2014 7:34PM

Frequency MHz	Level dBµV	Transd dB	Limit dBµV	Margin dB	Detector	Line	PE
0.150000	51.80	20.1	66	14.2	QP	L1	GND
0.222000	45.40	20.1	63	17.3	QP	L1	GND
0.294000	37.60	20.1	60	22.8	QP	L1	GND
0.366000	37.10	20.1	59	21.5	QP	L1	GND
0.604500	30.60	20.1	56	25.4	QP	L1	GND
1.382500	29.80	20.2	56	26.2	QP	L1	GND

**MEASUREMENT RESULT: "011409054102\_fin2"**

10/14/2014 7:34PM

Frequency MHz	Level dBµV	Transd dB	Limit dBµV	Margin dB	Detector	Line	PE
0.150000	35.30	20.1	56	20.7	AV	L1	GND
0.226500	27.20	20.1	53	25.4	AV	L1	GND
0.708000	13.60	20.1	46	32.4	AV	L1	GND
1.013500	21.40	20.2	46	24.6	AV	L1	GND
1.549000	15.50	20.3	46	30.5	AV	L1	GND
1.612000	16.60	20.3	46	29.4	AV	L1	GND

**CONDUCTED EMISSION TEST DATA**

Test Site: 1# Shielded Room  
 Operating Condition: Charging to adapter  
 Test Specification: DC 5V via adapter AC 120V, 60Hz  
 Comment: Neutral Line  
 Tem:25°C Hum:50%

**SCAN TABLE: "Voltage (150K~30M) FIN"**

Short Description: 150K-30M Disturbance Voltages

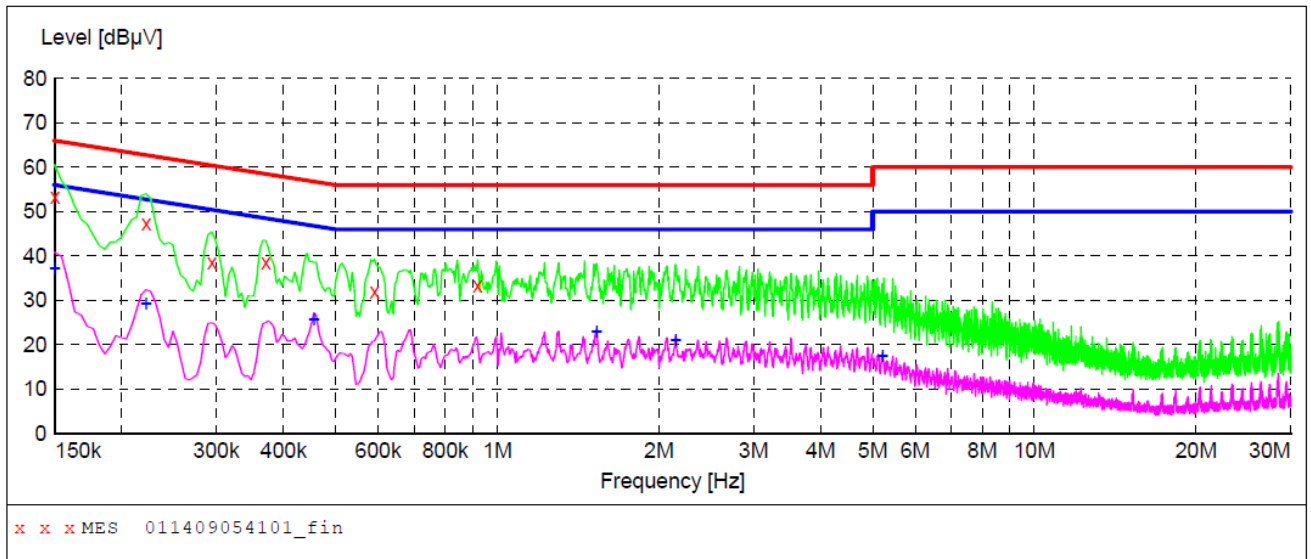

**MEASUREMENT RESULT: "011409054101\_fin"**

10/14/2014 7:31PM

Frequency MHz	Level dBµV	Transd dB	Limit dBµV	Margin dB	Detector	Line	PE
0.150000	53.30	20.1	66	12.7	QP	N	GND
0.222000	47.30	20.1	63	15.4	QP	N	GND
0.294000	38.70	20.1	60	21.7	QP	N	GND
0.370500	38.70	20.1	59	19.8	QP	N	GND
0.591000	32.00	20.1	56	24.0	QP	N	GND
0.919500	33.40	20.1	56	22.6	QP	N	GND

**MEASUREMENT RESULT: "011409054101\_fin2"**

10/14/2014 7:31PM

Frequency MHz	Level dBµV	Transd dB	Limit dBµV	Margin dB	Detector	Line	PE
0.150000	37.30	20.1	56	18.7	AV	N	GND
0.222000	29.20	20.1	53	23.5	AV	N	GND
0.456000	25.70	20.1	47	21.1	AV	N	GND
1.531000	22.90	20.3	46	23.1	AV	N	GND
2.147500	21.10	20.3	46	24.9	AV	N	GND
5.216500	17.50	20.5	50	32.5	AV	N	GND

## 4. Radiation Interference

### 4.1. Requirements (15.249, 15.209):

#### 4.1.1. Test Limits (< 30 MHz)

Frequency (MHz)	Field Strength (microvolts/meter)	Measurement Distance (meter)
0.009-0.490	2400/F(kHz)	300
0.490-1.705	24000/F(kHz)	30
1.705-30.0	30	30

#### 4.1.2. Test Limits ( $\geq$ 30 MHz)

FIELD STRENGTH of Fundamental: @3M	FIELD STRENGTH of Harmonics	S15.209	
902-928 MHz		30 - 88 MHz	40 dBuV/m
2.4-2.4835 GHz		88 - 216 MHz	43.5
94 dB $\mu$ V/m @3m	54 dB $\mu$ V/m @3m	216 - 960 MHz	46
		ABOVE 960 MHz	54dBuV/m

For range 9KHz~30MHz, The measured value is really too low to be recorded.

Emissions radiated outside of the specified frequency bands, except for harmonics, shall be attenuated by at least 50 dB below the level of the fundamental or to the general radiated emission limits in 15.209, whichever is the lesser attenuation.

### 4.2. Test Procedure

The EUT is placed on a turn table which is 0.8 meter high above the ground. The turn table can rotate 360 degrees to determine the position of the maximum emission level. The EUT is set 3 meters away from the receiving antenna which is mounted on a antenna tower. The antenna can be moved up and down from 1 to 4 meters to find out the maximum emission level. Both horizontal and vertical polarization of the antenna are set on test.

All readings from 30MHz to 1GHz are quasi-peak values with a resolution bandwidth of 120kHz. All reading are above 1GHz, peak & average values with a resolution bandwidth of 1MHz. The EUT is tested in 9\*6\*6 Chamber.

The test results are listed in Section 4.3.

Test Equipment

Item	Equipment	Manufacturer	Model No.	Serial No.	Last Cal.	Cal. Interval
1.	Spectrum Analysis	Agilent	E4407B	US39390582	Aug. 08, 2014	1 Year
2.	Preamplifier	Instruments corporation	EMC011830	980100	Aug. 08, 2014	1 Year
3.	EMI Test Receiver	Rohde & Schwarz	ESPI	101604	Apr. 22, 2014	1 Year
4.	Double Ridged Horn Antenna	Instruments corporation	GTH-0118	351600	Apr. 04, 2014	1 Year
5.	Bilog Broadband Antenna	Schwarzbeck	VULB9163	VULB 9163-289	Apr. 24, 2014	1 Year
6.	Pre-amplifier	SONOMA	310N	186860	Aug. 08, 2014	1 Year
7.	EMI Test Software EZ-EMC	SHURPLE	N/A	N/A	N/A	N/A

4.3. Test Configuration:

4.3.1. 9k to 30MHz emissions:

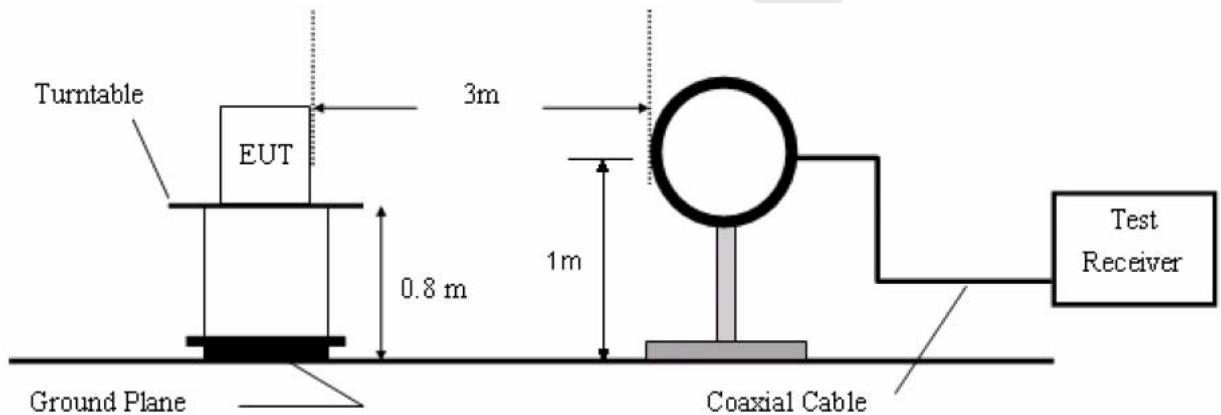

4.3.2. 30M to 1G emissions:

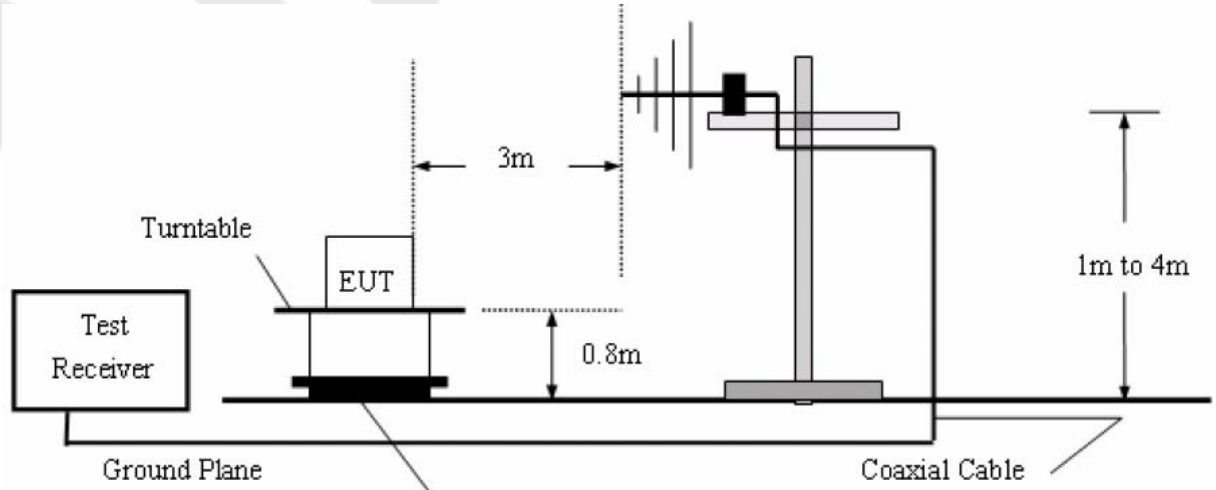

4.3.3. 1G to 40G emissions:

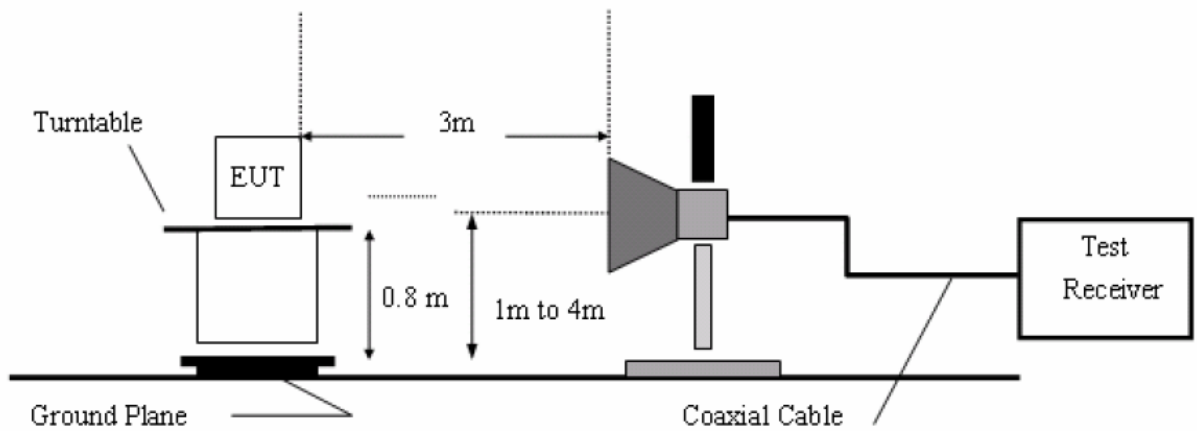

4.4. Test Results

PASS.

The EUT was tested on (Charging to adapter, BT Mode, AUX Mode) modes, only the worst data of (BT Mode(BDR)) are attached in the following pages.

**Data:**

**Below 1GHz:**

<b>Job No.:</b>	<b>011409054E</b>	<b>Polarziation:</b>	<b>Horizontal</b>
<b>Standard:</b>	<b>(RE)FCC PART15 C_3m</b>	<b>Power Source:</b>	<b>DC 3.7V</b>
<b>Test item:</b>	<b>Radiation Test</b>	<b>Temp.(C)/Hum.(%RH):</b>	<b>24.3( C)/55%RH</b>
<b>Mode:</b>	<b>BT Mode(BDR)</b>	<b>Distance:</b>	<b>3m</b>
<b>Note:</b>	<b>30-1000MHz</b>		

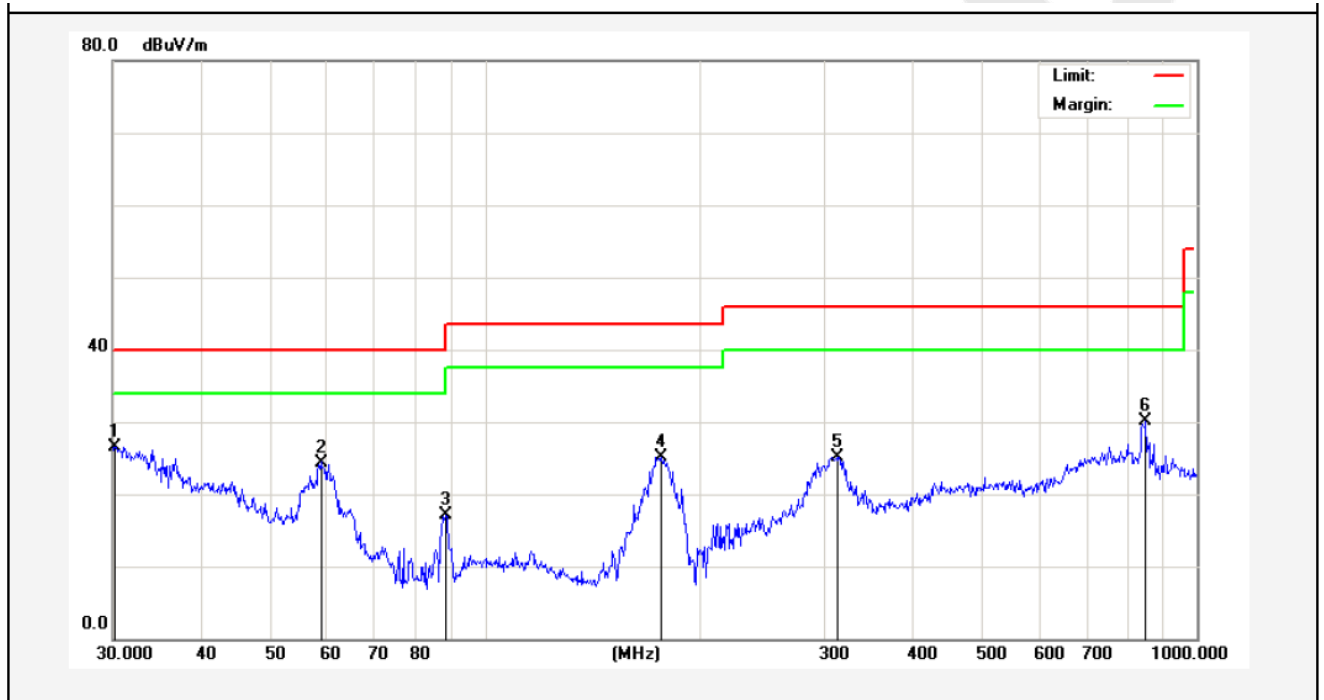

No.	Freq. (MHz)	Reading (dBuV/m)	Factor (dB/m)	Result (dBuV/m)	Limit (dBuV/)	Over Limit (dB)	Detector	Height (cm)	degree (deg)	Remark
1	30.2110	43.39	-16.84	26.55	40.00	-13.45	peak			
2	58.8185	39.68	-15.28	24.40	40.00	-15.60	peak			
3	88.0328	39.01	-21.88	17.13	43.50	-26.37	peak			
4	176.8876	47.21	-22.06	25.15	43.50	-18.35	peak			
5	313.2760	41.17	-16.07	25.10	46.00	-20.90	peak			
6	848.0561	35.74	-5.66	30.08	46.00	-15.92	peak			

**Job No.:** 011409054E      **Polarziation:** Vertical  
**Standard:** (RE)FCC PART15 C\_3m      **Power Source:** DC 3.7V  
**Test item:** Radiation Test      **Temp.(C)/Hum.(%RH):** 24.3( C)/55%RH  
**Mode:** BT Mode(BDR)      **Distance:** 3m  
**Note:** 30-1000MHz

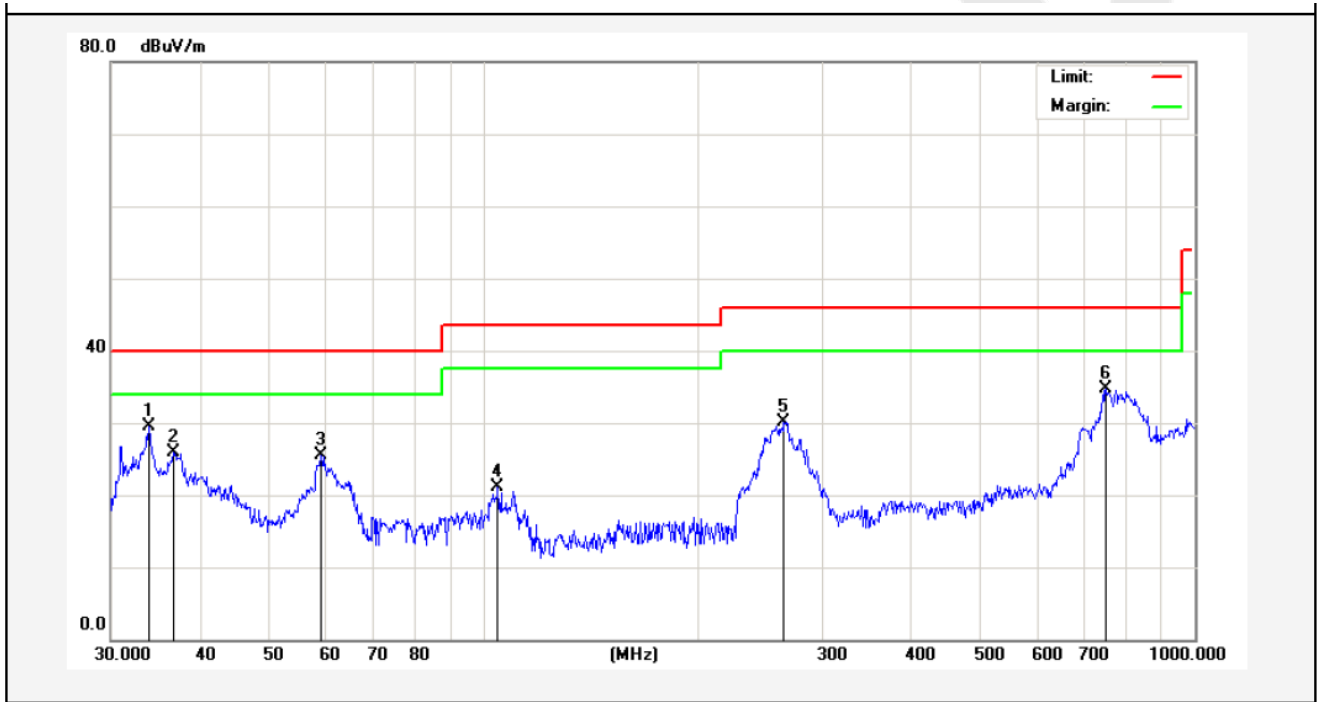

No.	Freq. (MHz)	Reading (dBuV/m)	Factor (dB/m)	Result (dBuV/m)	Limit (dBuV/)	Over Limit (dB)	Detector	Height (cm)	degree (deg)	Remark
1	33.9174	44.40	-14.86	29.54	40.00	-10.46	peak			
2	36.7661	38.82	-12.91	25.91	40.00	-14.09	peak			
3	59.2325	40.78	-15.32	25.46	40.00	-14.54	peak			
4	104.9033	36.86	-15.71	21.15	43.50	-22.35	peak			
5	264.7456	44.48	-14.28	30.20	46.00	-15.80	peak			
6	750.1082	41.71	-6.99	34.72	46.00	-11.28	peak			

**Above 1 GHz:**

The worst mode: BDR

Horizontal

CH Low (2402MHz)

Frequency MHz	Cable Loss dB	Ant Factor dB/m	Preamp Factor dB	Read Level dBμV	Level dBμV/m	Limit dBμV/m	Over Limit dB	Remark
2402.000	2.17	31.21	35.30	90.41	88.49	114.0	-25.51	Peak
2402.000	2.17	31.21	35.30	81.54	79.62	94.0	-14.38	AV
4804.000	2.56	34.01	34.71	48.35	50.21	74.0	-23.79	Peak
4804.000	2.56	34.01	34.71	36.51	38.37	54.0	-15.63	AV
7206.000	2.98	36.16	35.15	47.23	51.22	74.0	-22.78	Peak
7206.000	2.98	36.16	35.15	33.45	37.44	54.0	-16.56	AV
9608.000	---	---	---	---	---	---	---	---
9608.000	---	---	---	---	---	---	---	---
12010.000	---	---	---	---	---	---	---	---
12010.000	---	---	---	---	---	---	---	---
---	---	---	---	---	---	---	---	---

Vertical  
CH Low (2402MHz)

Frequency MHz	Cable Loss dB	Ant Factor dB/m	Preamp Factor dB	Read Level dBμV	Level dBμV/m	Limit dBμV/m	Over Limit dB	Remark
2402.000	2.17	31.21	35.30	92.81	90.89	114.0	-23.11	Peak
2402.000	2.17	31.21	35.30	82.16	80.24	94.0	-13.76	AV
4804.000	2.56	34.01	34.71	47.69	49.55	74.0	-24.45	Peak
4804.000	2.56	34.01	34.71	35.66	37.52	54.0	-16.48	AV
7206.000	2.98	36.16	35.15	44.12	48.11	74.0	-25.89	Peak
7206.000	2.98	36.16	35.15	35.71	39.70	54.0	-14.30	AV
9608.000	---	---	---	---	---	---	---	---
9608.000	---	---	---	---	---	---	---	---
12010.000	---	---	---	---	---	---	---	---
12010.000	---	---	---	---	---	---	---	---
---	---	---	---	---	---	---	---	---

**NOTE: “ --- ” in the table above means the reading of emissions are attenuated more than 20dB below the permissible limits or the field strength is too small to be measured. The results of different modulations are the same.**



Horizontal  
CH Middle (2441MHz)

Frequency MHz	Cable Loss dB	Ant Factor dB/m	Preamp Factor dB	Read Level dB $\mu$ V	Level dB $\mu$ V/m	Limit dB $\mu$ V/m	Over Limit dB	Remark
2441.000	2.19	31.22	34.60	92.45	91.26	114.0	-22.74	Peak
2441.000	2.19	31.22	34.60	80.02	78.83	94.0	-15.17	AV
4882.000	2.57	35.00	34.58	46.59	49.58	74.0	-24.42	Peak
4882.000	2.57	35.00	34.58	39.42	42.41	54.0	-11.59	AV
7323.000	3.00	36.17	35.14	47.46	51.49	74.0	-22.51	Peak
7323.000	3.00	36.17	35.14	34.23	38.26	54.0	-15.74	AV
9764.000	---	---	---	---	---	---	---	---
9764.000	---	---	---	---	---	---	---	---
12205.000	---	---	---	---	---	---	---	---
12205.000	---	---	---	---	---	---	---	---
---	---	---	---	---	---	---	---	---

Vertical  
CH Middle (2441MHz)

Frequency MHz	Cable Loss dB	Ant Factor dB/m	Preamp Factor dB	Read Level dB $\mu$ V	Level dB $\mu$ V/m	Limit dB $\mu$ V/m	Over Limit dB	Remark
2441.000	2.19	31.22	34.60	94.51	93.32	114.0	-20.68	Peak
2441.000	2.19	31.22	34.60	81.69	80.50	94.0	-13.50	AV
4882.000	2.57	35.00	34.58	44.20	47.19	74.0	-26.81	Peak
4882.000	2.57	35.00	34.58	35.14	38.13	54.0	-15.87	AV
7323.000	3.00	36.17	35.14	46.05	50.08	74.0	-23.92	Peak
7323.000	3.00	36.17	35.14	35.49	39.52	54.0	-14.48	AV
9764.000	---	---	---	---	---	---	---	---
9764.000	---	---	---	---	---	---	---	---
12205.000	---	---	---	---	---	---	---	---
12205.000	---	---	---	---	---	---	---	---
---	---	---	---	---	---	---	---	---

**NOTE: “ --- ” in the table above means the reading of emissions are attenuated more than 20dB below the permissible limits or the field strength is too small to be measured. The results of different modulations are the same.**

Horizontal  
CH High (2480MHz)

Frequency MHz	Cable Loss dB	Ant Factor dB/m	Preamp Factor dB	Read Level dB $\mu$ V	Level dB $\mu$ V/m	Limit dB $\mu$ V/m	Over Limit dB	Remark
2480.000	2.20	31.65	36.00	95.14	92.99	114.0	-21.01	Peak
2480.000	2.20	31.65	36.00	81.45	79.30	94.0	-14.70	AV
4960.000	2.58	35.06	34.79	49.07	51.92	74.0	-22.08	Peak
4960.000	2.58	35.06	34.79	38.65	41.50	54.0	-12.50	AV
7440.000	3.02	36.19	34.90	49.54	53.85	74.0	-20.15	Peak
7440.000	3.02	36.20	35.20	38.03	42.05	54.0	-11.95	AV
9920.000	---	---	---	---	---	---	---	---
9920.000	---	---	---	---	---	---	---	---
12400.000	---	---	---	---	---	---	---	---
12400.000	---	---	---	---	---	---	---	---
---	---	---	---	---	---	---	---	---

Vertical  
CH High (2480MHz)

Frequency MHz	Cable Loss dB	Ant Factor dB/m	Preamp Factor dB	Read Level dB $\mu$ V	Level dB $\mu$ V/m	Limit dB $\mu$ V/m	Over Limit dB	Remark
2480.000	2.20	31.65	36.00	93.21	91.06	114.0	-22.94	Peak
2480.000	2.20	31.65	36.00	84.09	81.94	94.0	-12.06	AV
4960.000	2.58	35.06	34.79	46.39	49.24	74.0	-24.76	Peak
4960.000	2.58	35.06	34.79	33.58	36.43	54.0	-17.57	AV
7440.000	3.02	36.19	34.90	46.42	50.73	74.0	-23.27	Peak
7440.000	3.02	36.20	35.20	34.34	38.36	54.0	-15.64	AV
9920.000	---	---	---	---	---	---	---	---
9920.000	---	---	---	---	---	---	---	---
12400.000	---	---	---	---	---	---	---	---
12400.000	---	---	---	---	---	---	---	---
---	---	---	---	---	---	---	---	---

**NOTE: “ --- ” in the table above means the reading of emissions are attenuated more than 20dB below the permissible limits or the field strength is too small to be measured. The results of different modulations are the same.**

## 5. Occupied Bandwidth

### 5.1. Requirements (15.249):

The field strength of any emissions appearing outside the band edges and up to 10 kHz above and below the band edges shall be attenuated at least 50 dB below the level of the carrier or to the general limits of 15.249.

### 5.2. Test Procedure

The EUT is placed on a turn table which is 0.8 meter high above the ground. The turn table can rotate 360 degrees to determine the position of the maximum emission level. The EUT is set 3 meters away from the receiving antenna which is mounted on a antenna tower. The antenna can be moved up and down from 1 to 4 meters to find out the maximum emission level. Both horizontal and vertical polarization of the antenna are set on test.

#### Test Equipment

Item	Equipment	Manufacturer	Model No.	Serial No.	Last Cal.	Cal. Interval
1.	Spectrum Analysis	Agilent	E4407B	US39390582	Aug. 08, 2014	1 Year
2.	Preamplifier	Instruments corporation	EMC011830	980100	Aug. 08, 2014	1 Year
3.	EMI Test Receiver	Rohde & Schwarz	ESPI	101604	Apr. 22, 2014	1 Year
4.	Double Ridged Horn Antenna	Instruments corporation	GTH-0118	351600	Apr. 04, 2014	1 Year
5.	Bilog Broadband Antenna	Schwarzbeck	VULB9163	VULB 9163-289	Apr. 24, 2014	1 Year
6.	Pre-amplifier	SONOMA	310N	186860	Aug. 08, 2014	1 Year
7.	EMI Test Software EZ-EMC	SHURPLE	N/A	N/A	N/A	N/A

### 5.3. Test Configuration:

Same as the test configuration in 4.3.

### 5.4. Test Results

Pass.

Please refer the following plot.

(Note: Marker 3 means the highest value in 2.39GHz~2.4GHz or 2.4835~2.5GHz)

The worst mode: BDR

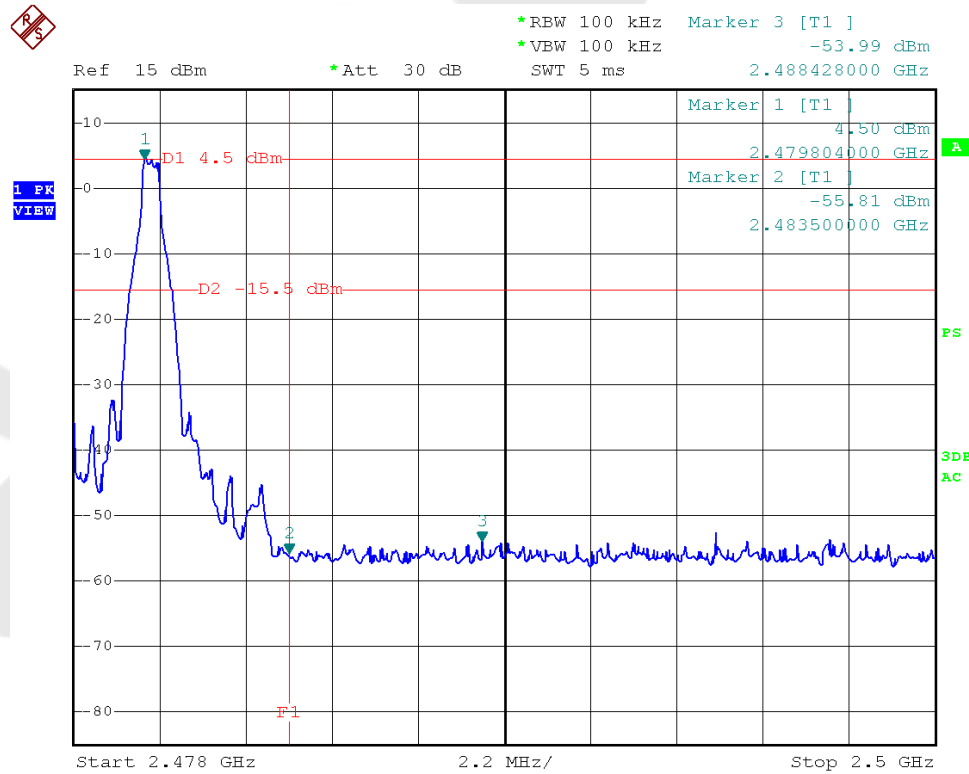
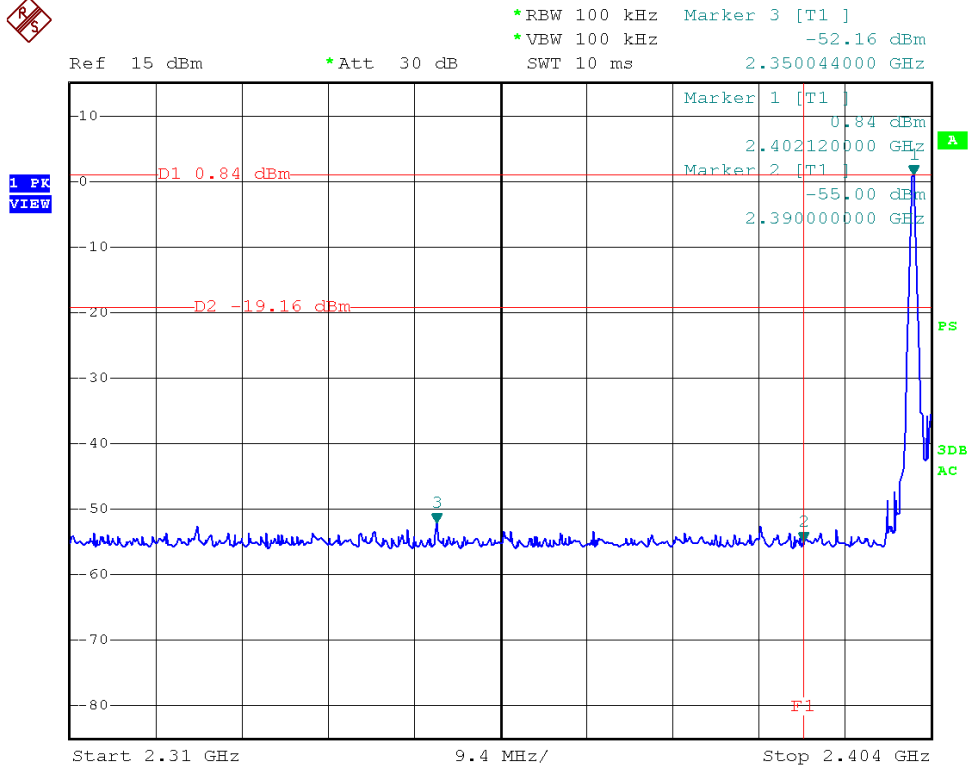

The worst mode: BDR  
20dB Down:

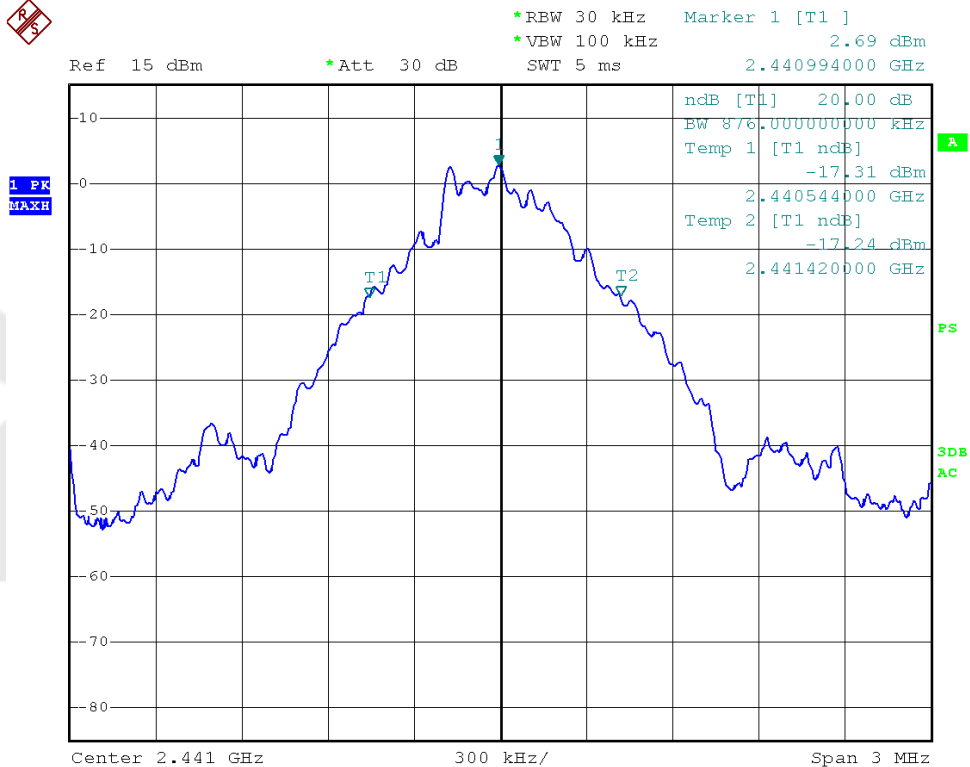

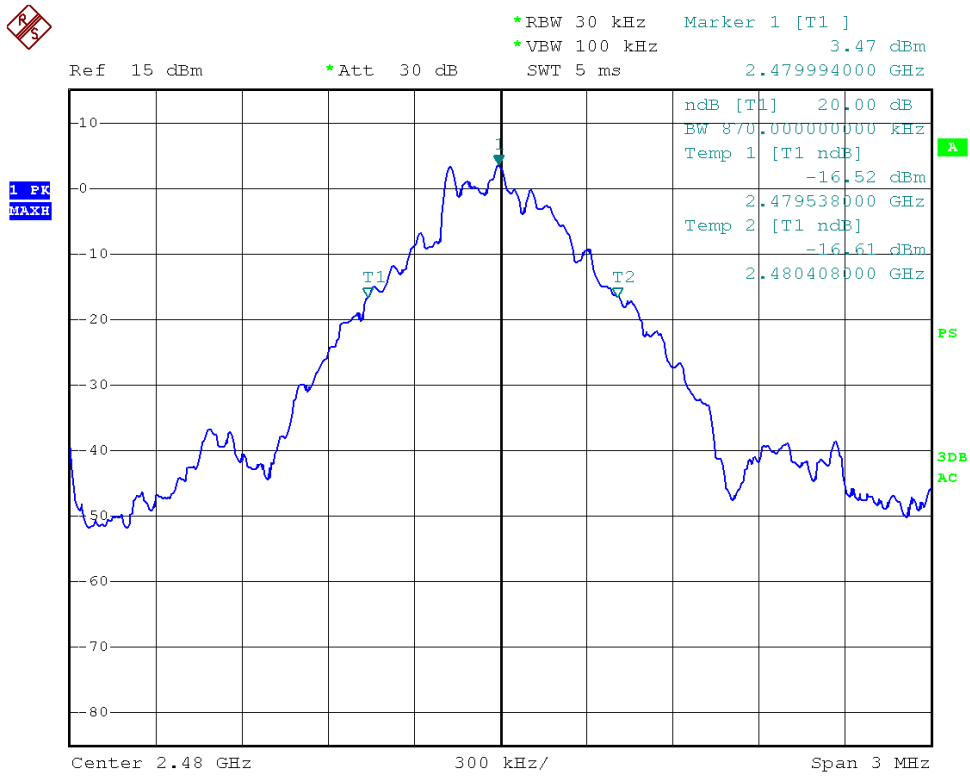

Anbotek

## 6. PHOTOGRAPH

### 6.1. Photo of Conducted Emission Test



### 6.2. Photo of Radiation Emission Test

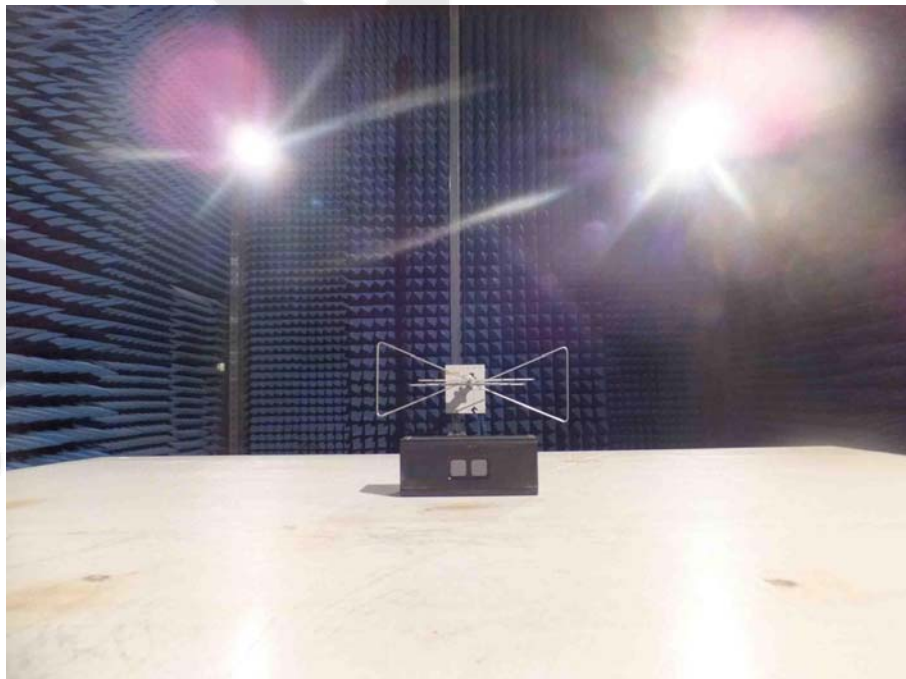

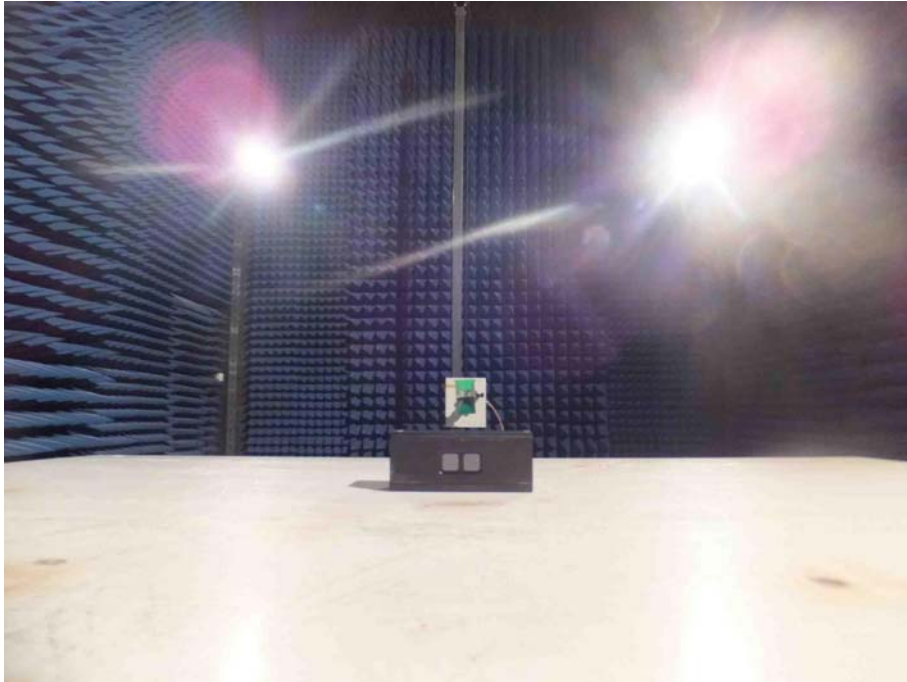

Anbotek



## APPENDIX I (EXTERNAL PHOTOS)

Figure 1  
The EUT- Top View



Figure 2  
The EUT- Bottom View



Figure 3  
The EUT- Front View



Figure 4  
The EUT- Back View





Figure 5  
The EUT- Right View

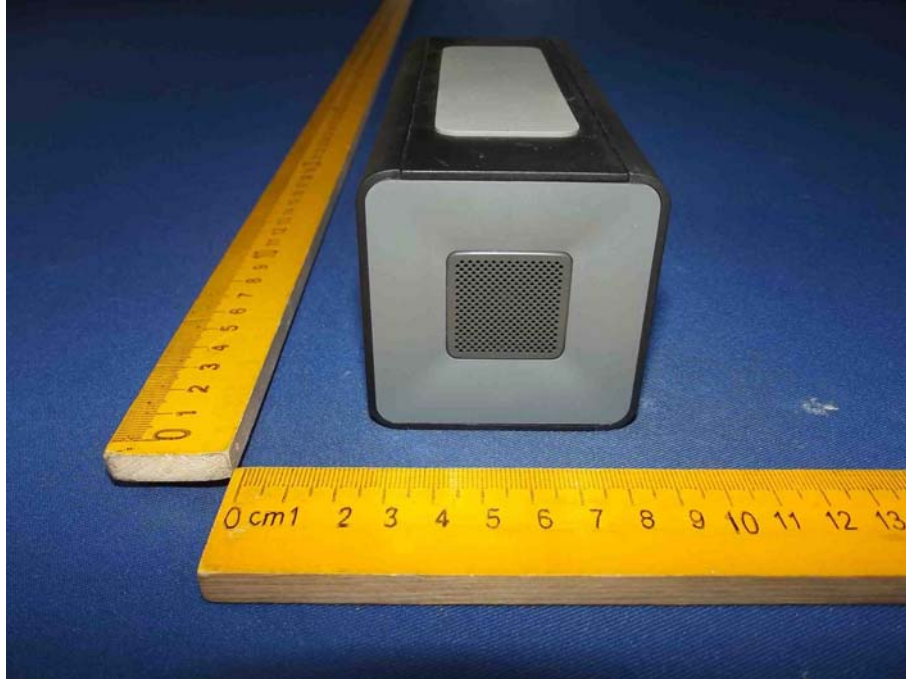
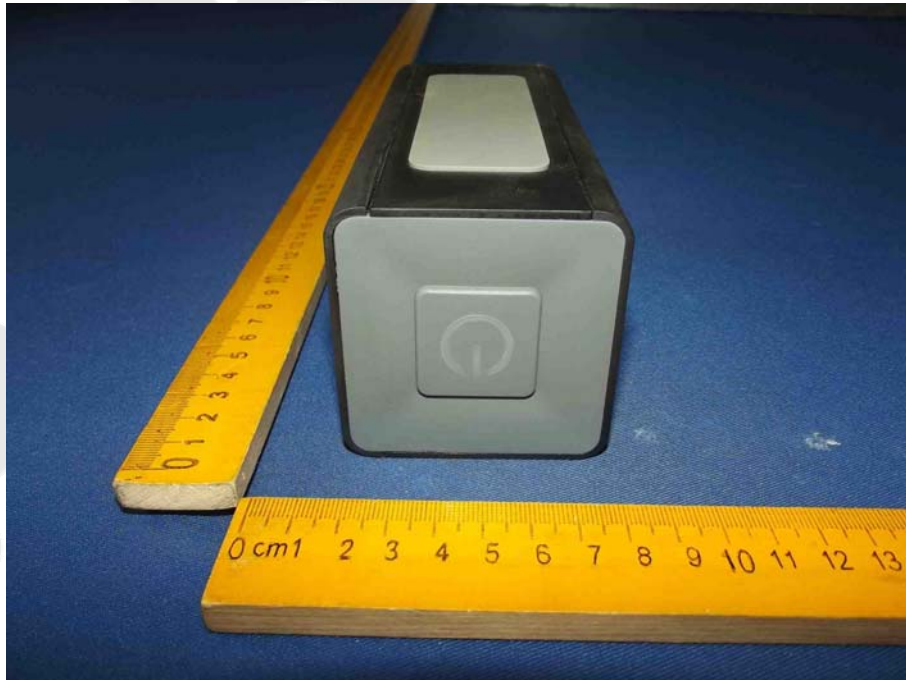

Figure 6  
The EUT- Left View



## APPENDIX II(INTERNAL PHOTOS)

Figure 7  
The EUT-Inside View

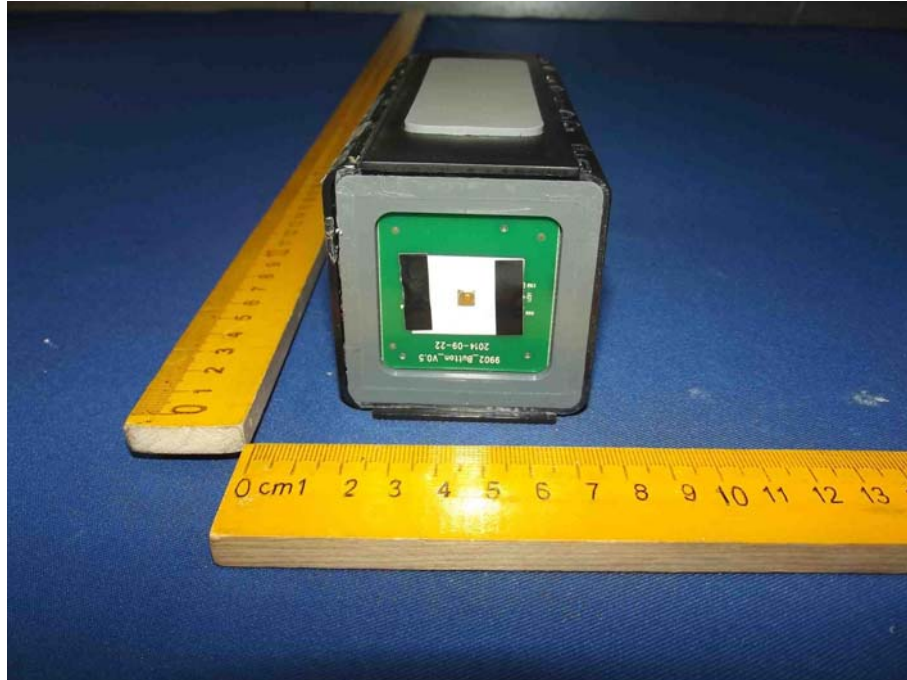

Figure 8  
The EUT-Inside View





Figure 9  
The EUT-Inside View



Figure 10  
The EUT-Inside View

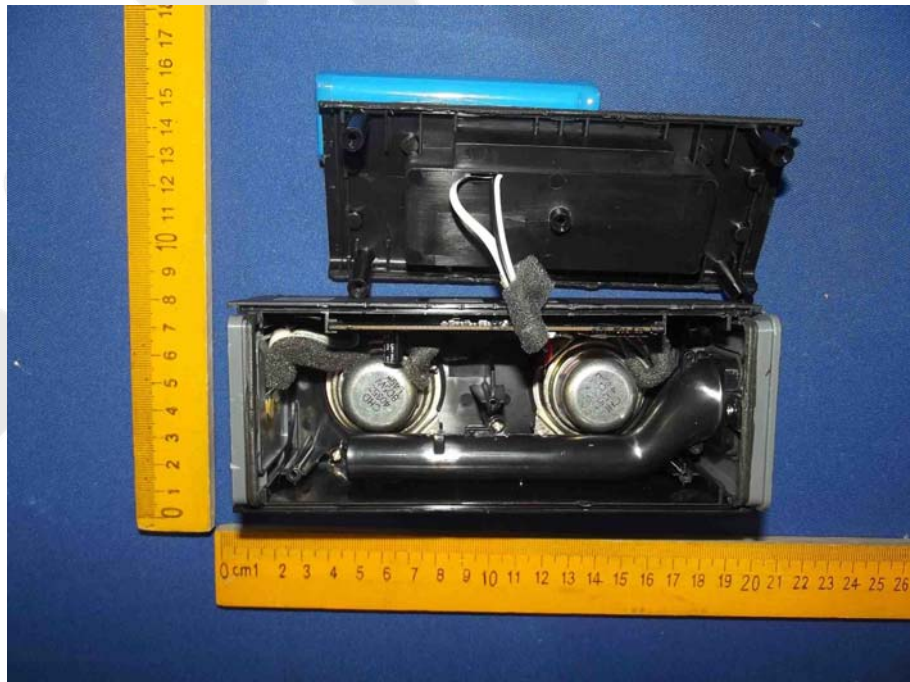

Figure 11  
PCB of the EUT-Front View

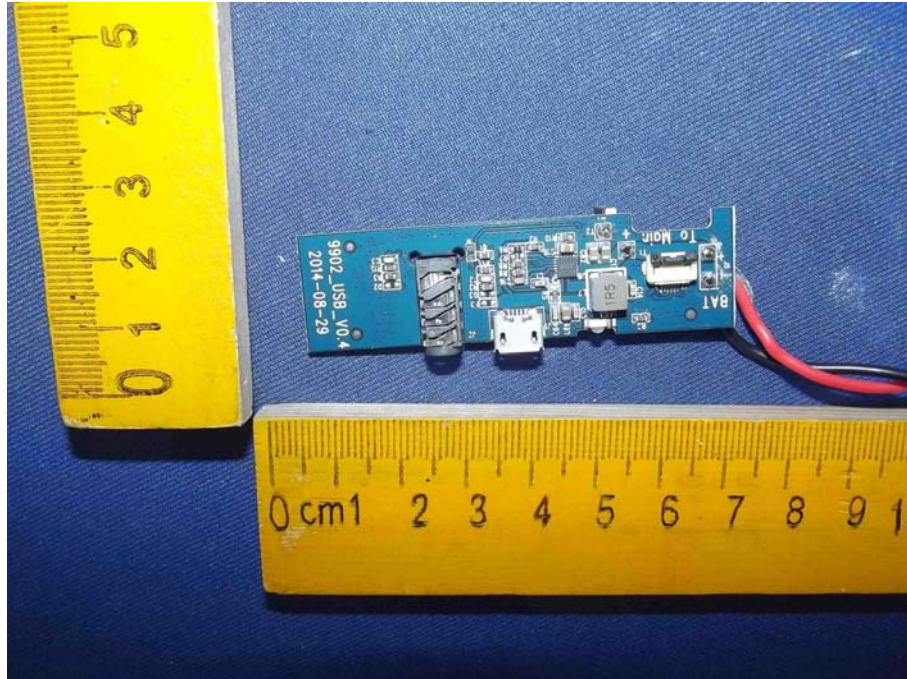

Figure 12  
PCB of the EUT-Back View

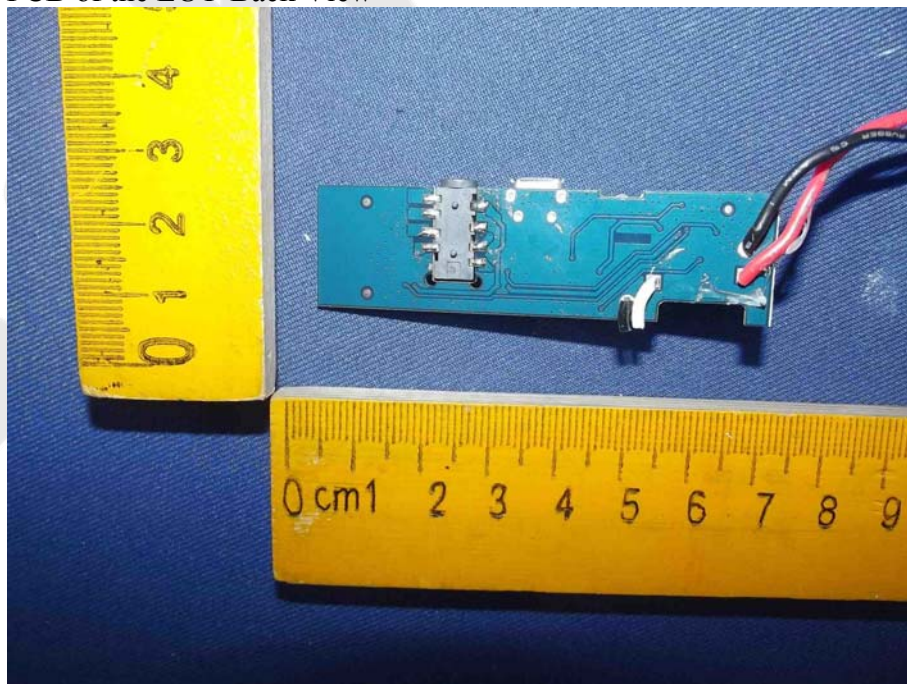



Figure 13  
PCB of the EUT-Front View

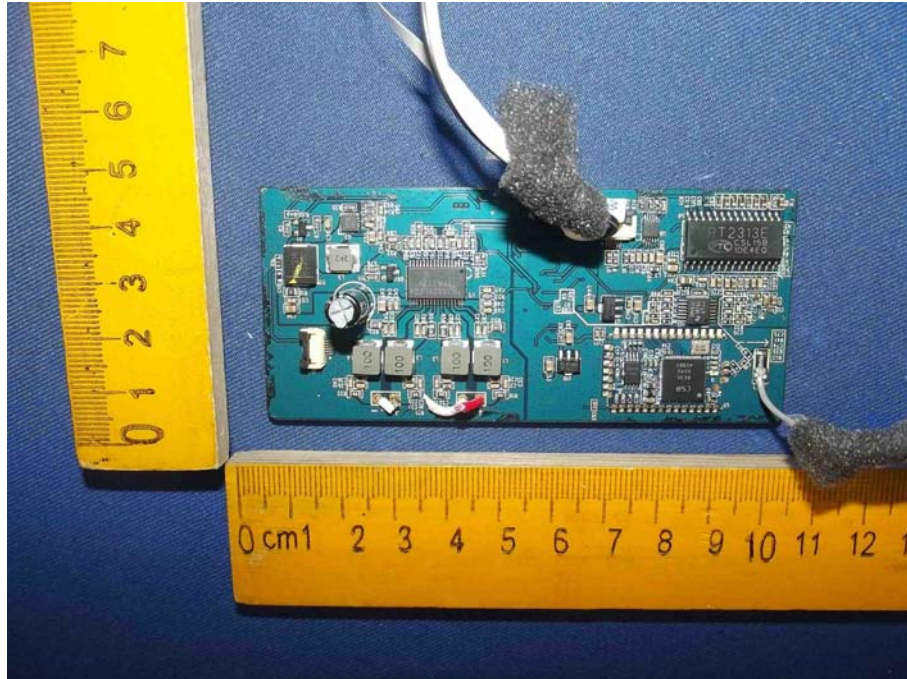

Figure 14  
PCB of the EUT-Back View

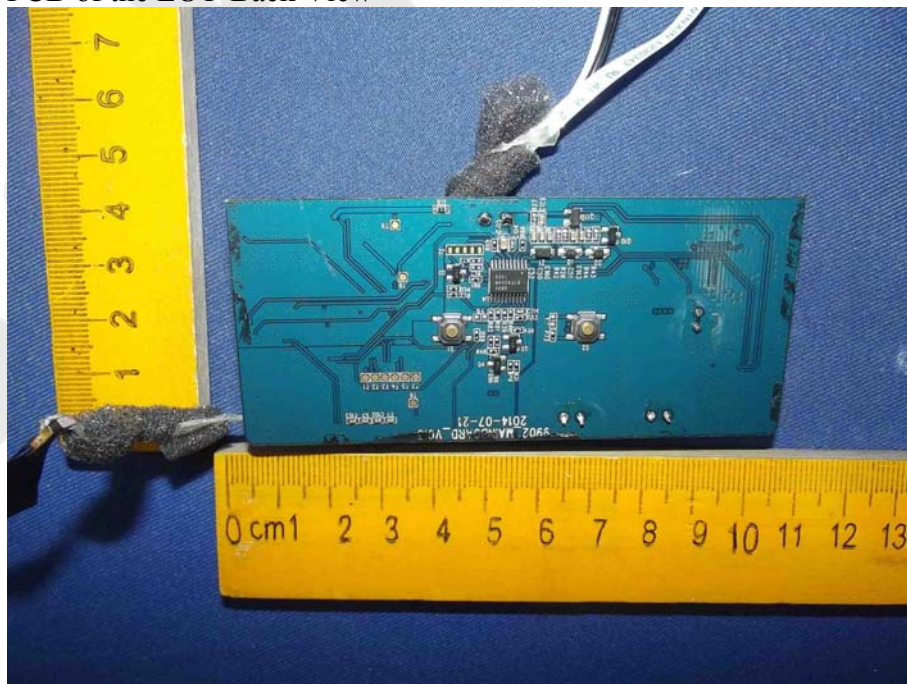

Figure 15  
PCB of the EUT-Front View



Figure 16  
PCB of the EUT-Back View

