

FCC TEST REPORT

For

Anker Technology Co., Limited.

PowerPort Wireless

Model No.: A2511

Prepared For : Anker Technology Co., Limited.
Address : Room 1318-19, Hollywood Plaza, 610 Nathan Road, Mongkok, Kowloon,
Hongkong

Prepared By : Shenzhen Anbotek Compliance Laboratory Limited
Address : 1/F., Building 1, SEC Industrial Park, No.0409 Qianhai Road, Nanshan
District, Shenzhen, Guangdong, China
Tel: (86) 755-26066544 Fax: (86) 755-26014772

Report Number : R0217080095W1
Date of Test : Sept. 03~10, 2017
Date of Report : Sept. 11, 2017

Contents

1. General Information.....	4
1.1. Client Information.....	4
1.2. Description of Device (EUT).....	4
1.3. Auxiliary Equipment Used During Test.....	4
1.4. Description of Test Modes.....	5
1.5. List of channels.....	5
1.6. Description Of Test Setup.....	6
1.7. Test Equipment List.....	7
1.8. Measurement Uncertainty.....	8
1.9. Description of Test Facility.....	8
2. Summary of Test Results.....	9
3. Conducted Emission Test.....	10
3.1. Test Standard and Limit.....	10
3.2. Test Setup.....	10
3.3. Test Procedure.....	10
3.4. Test Data.....	10
4. Radiation Spurious Emission and Band Edge.....	15
4.1. Test Standard and Limit.....	15
4.2. Test Setup.....	15
4.3. Test Procedure.....	16
4.4. Test Data.....	17
APPENDIX I -- TEST SETUP PHOTOGRAPH.....	21
APPENDIX II -- EXTERNAL PHOTOGRAPH.....	23
APPENDIX III -- INTERNAL PHOTOGRAPH.....	27

TEST REPORT

Applicant : Anker Technology Co., Limited.
Manufacturer : Lengend Intelligence Co., Ltd
Product Name : PowerPort Wireless
Model No. : A2511
Trade Mark : **ANKER**
Rating(s) : Input: DC 5.0V 2A
Output: DC 5.0V 1A

Test Standard(s) : FCC Part15 Subpart C 2016, Paragraph 15.209

Test Method(s) : ANSI C63.10: 2013

The device described above is tested by Shenzhen Anbotek Compliance Laboratory Limited to determine the maximum emission levels emanating from the device and the severe levels of the device can endure and its performance criterion. The measurement results are contained in this test report and Shenzhen Anbotek Compliance Laboratory Limited is assumed full of responsibility for the accuracy and completeness of these measurements. Also, this report shows that the EUT (Equipment Under Test) is technically compliant with the FCC Part 15 Subpart C requirements.

This report applies to above tested sample only and shall not be reproduced in part without written approval of Shenzhen Anbotek Compliance Laboratory Limited.

Date of Test : Sept. 03~10, 2017

Prepared by :



Winkey Wang

(Tested Engineer / Winkey Wang)

Reviewer :

Tangcy. T.

(Project Manager / Tangcy. T)

Approved & Authorized Signer :

Tom Chen

(Manager / Tom Chen)

1. General Information

1.1. Client Information

Applicant	:	Anker Technology Co., Limited.
Address	:	Room 1318-19, Hollywood Plaza, 610 Nathan Road, Mongkok, Kowloon, Hongkong
Manufacturer	:	Lengend Intelligence Co., Ltd
Address	:	Building C, Area A, Longquan technology garden, Huaxing Road, Longhua District, Shenzhen, China.

1.2. Description of Device (EUT)

Product Name	:	PowerPort Wireless	
Model No.	:	A2511	
Trade Mark	:	ANKER	
Test Power Supply	:	AC 120V, 60Hz for adapter / AC 240V, 60Hz for adapter	
Product Description	:	Operation Frequency:	110-205KHz
	:	Number of Channel:	20 Channels
	:	Modulation Type:	MSK
	:	Antenna Type:	Inductive loop coil Antenna
	:	Antenna Gain(Peak):	0 dBi
Remark: 1) For a more detailed features description, please refer to the manufacturer's specifications or the User's Manual.			

1.3. Auxiliary Equipment Used During Test

Mobile Phone	:	Manufacturer: NOKIA
	:	M/N: N920 S/N: 356355051634804 CE , FCC, DOC
Adapter	:	Manufacturer: SAMSUNG
	:	M/N: ETA-U90CBC S/N: RT6FB17ZS/B-E Input: 100-240V~50/60Hz 0.35A Output: DC 5V, 2000mA

1.4. Description of Test Modes

To investigate the maximum EMI emission characteristics generated from EUT, the test system was pre-scanning tested based on the consideration of following EUT operation mode or test configuration mode which possibly have effect on EMI emission level. Each of these EUT operation mode(s) or test configuration mode(s) mentioned above was evaluated respectively.

Pretest Mode	Description
Mode 1	CH01
Mode 2	CH10
Mode 3	CH20
Mode 4	Keeping TX mode

For Conducted Emission	
Final Test Mode	Description
Mode 4	Keeping TX mode

For Radiated Emission	
Final Test Mode	Description
Mode 1	CH01
Mode 2	CH10
Mode 3	CH20

1.5. List of channels

Channel	Freq. (MHz)	Channel	Freq. (MHz)	Channel	Freq. (MHz)	Channel	Freq. (MHz)
1	0.110	6	0.135	11	0.160	16	0.185
2	0.115	7	0.140	12	0.165	17	0.190
3	0.120	8	0.145	13	0.170	18	0.195
4	0.125	9	0.150	14	0.175	19	0.200
5	0.130	10	0.155	15	0.180	20	0.205

1.6. Description Of Test Setup

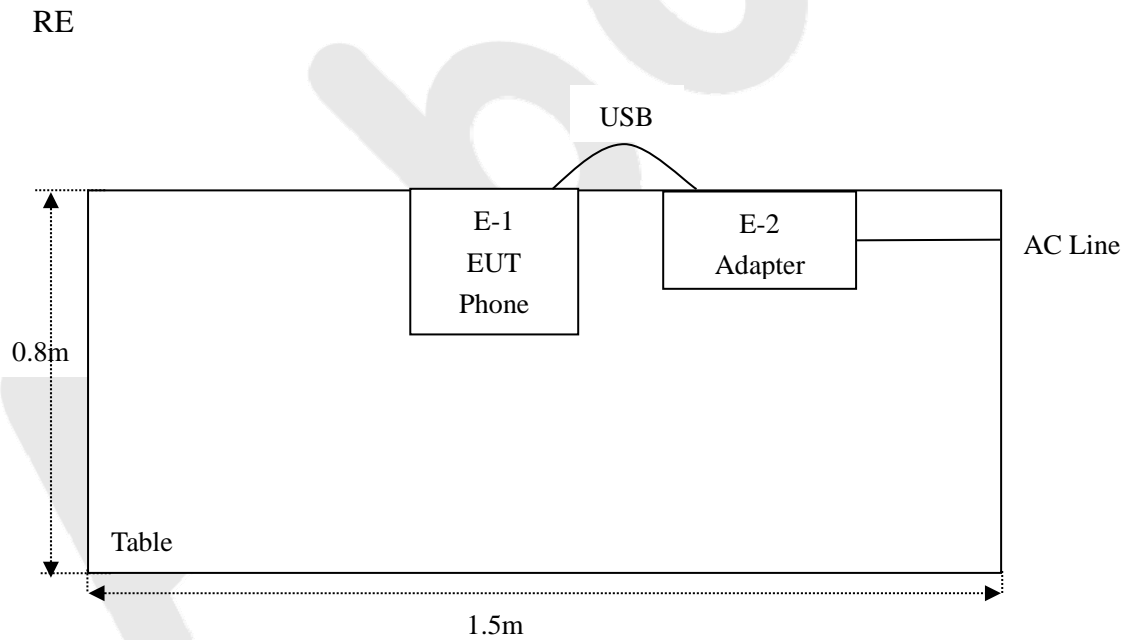
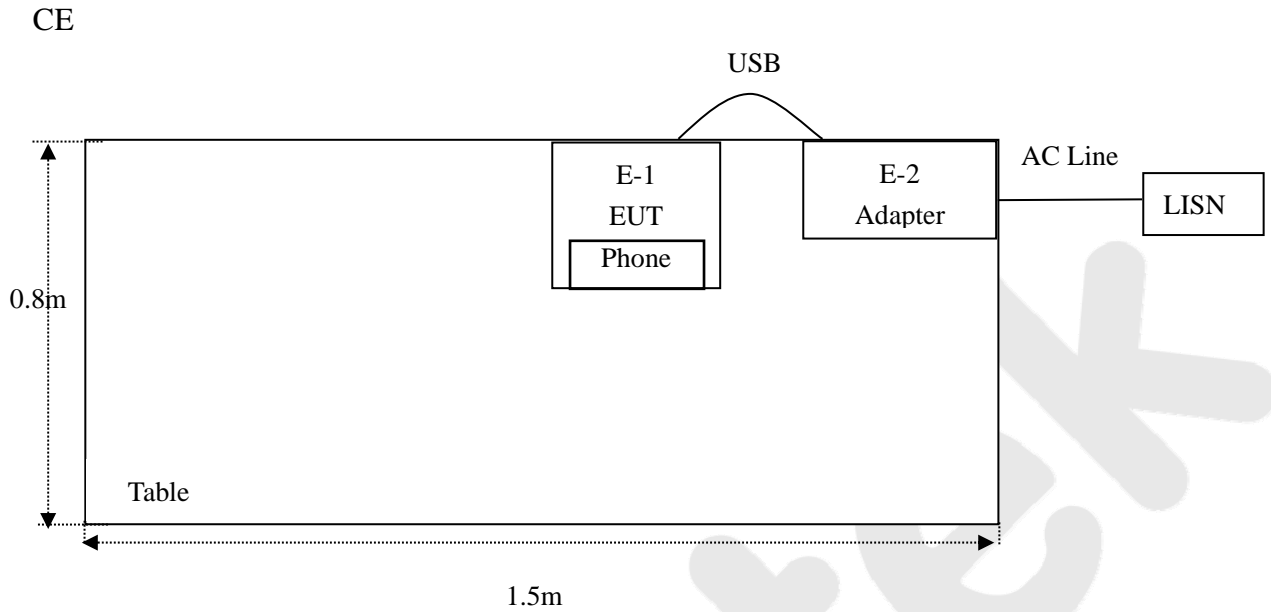

1.7. Test Equipment List

Item	Equipment	Manufacturer	Model No.	Serial No.	Last Cal.	Cal. Interval
1.	L.I.S.N. Artificial Mains Network	Rohde & Schwarz	ENV216	100055	May 27, 2017	1 Year
2.	EMI Test Receiver	Rohde & Schwarz	ESCI	100627	May 27, 2017	1 Year
3.	RF Switching Unit	Compliance Direction	RSU-M2	38303	May 27, 2017	1 Year
4.	Spectrum Analysis	Agilent	E4407B	US39390582	May 27, 2017	1 Year
5.	Preamplifier	SKET Electronic	BK1G18G30 D	KD17503	May 27, 2017	1 Year
6.	EMI Test Receiver	Rohde & Schwarz	ESPI	101604	May 27, 2017	1 Year
7.	Double Ridged Horn Antenna	Instruments corporation	GTH-0118	351600	May 31, 2017	1 Year
8.	Bilog Broadband Antenna	Schwarzbeck	VULB9163	VULB 9163-289	May 31, 2017	1 Year
9.	Loop Antenna	Schwarzbeck	HFH2-Z2	100047	Apr. 03, 2017	1 Year
10.	Pre-amplifier	SONOMA	310N	186860	May 27, 2017	1 Year
11.	EMI Test Software EZ-EMC	SHURPLE	N/A	N/A	N/A	N/A
12.	Power Sensor	DAER	RPR3006W	15I00041SN045	May 27, 2017	1 Year
13.	Power Sensor	DAER	RPR3006W	15I00041SN046	May 27, 2017	1 Year
14.	MXA Spectrum Analysis	Agilent	N9020A	MY51170037	May 27, 2017	1 Year
15.	MXG RF Vector Signal Generator	Agilent	N5182A	MY48180656	May 27, 2017	1 Year
16.	Signal Generator	Agilent	E4421B	MY41000743	May 27, 2017	1 Year
17.	DC Power supply	IVYTECH	IV6003	1601D6030007	May 26, 2017	1 Year
18.	TEMP&HUMI PROGRAMMABLE CHAMBER	Sertep	ZJ-HWHS80 B	ZJ-17042804	Mar. 03, 2017	1 Year

1.8. Measurement Uncertainty

Radiation Uncertainty	:	Ur = 4.1 dB (Horizontal)
		Ur = 4.3 dB (Vertical)
Conduction Uncertainty	:	Uc = 3.4dB

1.9. Description of Test Facility

The test facility is recognized, certified, or accredited by the following organizations:

FCC-Designation No.: CN5023

Shenzhen Anbotek Compliance Laboratory Limited, EMC Laboratory has been registered and fully described in a report filed with the (FCC) Federal Communications Commission. The acceptance letter from the FCC is maintained in our files. Designation CN5023, July 31, 2017.

ISED-Registration No.: 8058A-1

Shenzhen Anbotek Compliance Laboratory Limited, EMC Laboratory has been registered and fully described in a report filed with the (ISED) Innovation, Science and Economic Development Canada. The acceptance letter from the ISED is maintained in our files. Registration 8058A-1, June 13, 2016.

Test Location

All Emissions tests were performed at Shenzhen Anbotek Compliance Laboratory Limited. at 1/F., Building 1, SEC Industrial Park, No.0409 Qianhai Road, Nanshan District, Shenzhen, Guangdong, China

2. Summary of Test Results

Standard Section	Test Item	Result
FCC Part 15, Paragraph 15.207	Conducted Emission Test	PASS
FCC Part 15, Paragraph 15.209(a)(f)	Spurious Emission	PASS

Anbotek

3. Conducted Emission Test

3.1. Test Standard and Limit

Test Standard	FCC Part15 Section 15.207		
Test Limit	Frequency	Maximum RF Line Voltage (dBuV)	
		Quasi-peak Level	Average Level
	150kHz~500kHz	66 ~ 56 *	56 ~ 46 *
	500kHz~5MHz	56	46
5MHz~30MHz	60	50	

Remark: (1) *Decreasing linearly with logarithm of the frequency.
(2) The lower limit shall apply at the transition frequency.

3.2. Test Setup

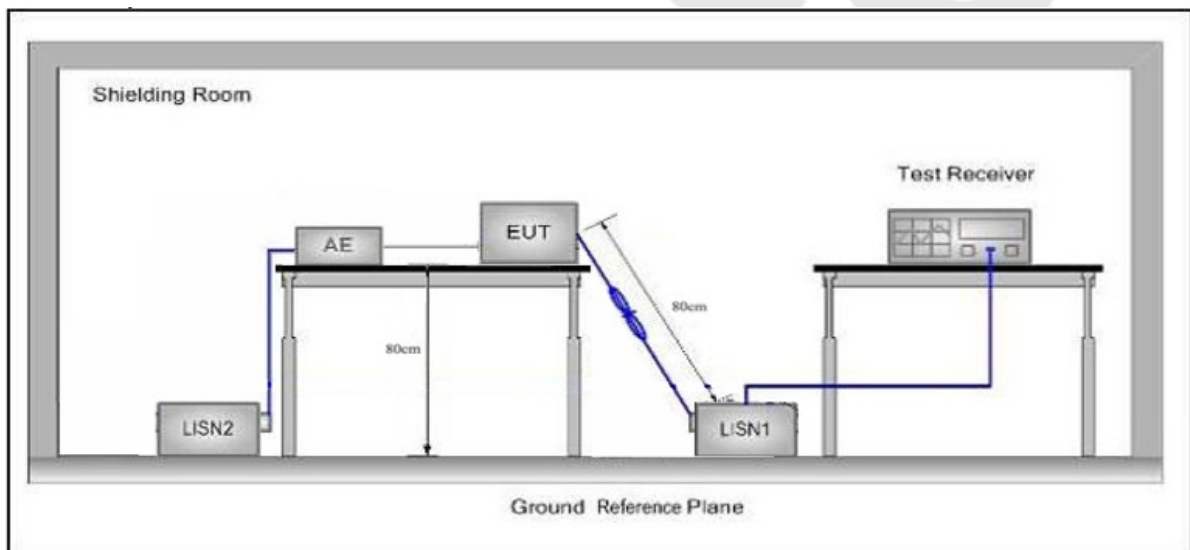

3.3. Test Procedure

The EUT system is connected to the power mains through a line impedance stabilization network (L.I.S.N.). This provides a 50ohm coupling impedance for the EUT system. Please refer the block diagram of the test setup and photographs. Both sides of AC line are checked to find out the maximum conducted emission. In order to find the maximum emission levels, the relative positions of equipment and all of the interface cables shall be changed according to FCC ANSI C63.10-2013 on Conducted Emission Measurement.

The bandwidth of test receiver (ESCI) set at 9kHz.

The frequency range from 150kHz to 30MHz is checked.

3.4. Test Data

Please to see the following pages

Conducted Emission Test Data

Test Site: 1# Shielded Room
 Operating Condition: Keeping TX mode
 Test Specification: AC 120V, 60Hz for adapter
 Comment: Live Line
 Tem.:25°C Hum.:50%

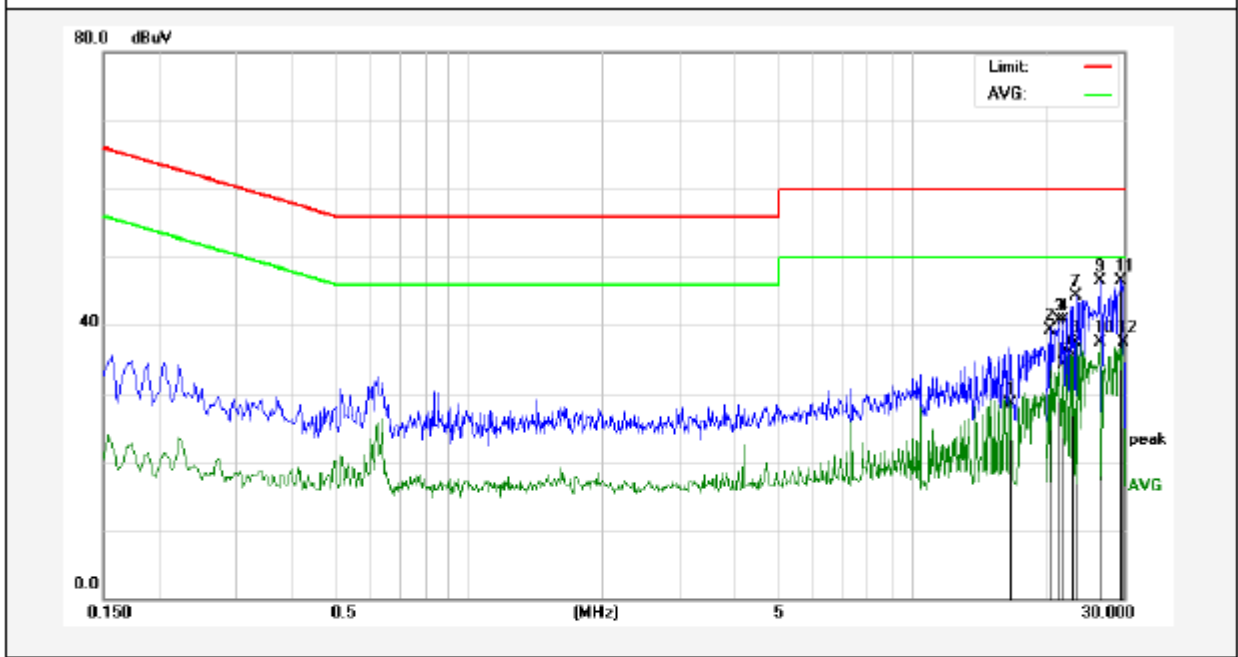

No.	Freq. (MHz)	Reading (dBuV)	Factor (dB)	Result (dBuV)	Limit dBuV	Over Limit (dB)	Detector	Remark
1	16.6580	8.20	20.29	28.49	50.00	-21.51	AVG	
2	20.4180	19.07	20.33	39.40	60.00	-20.60	QP	
3	21.5900	20.32	20.32	40.64	60.00	-19.36	QP	
4	22.0260	20.33	20.32	40.65	60.00	-19.35	QP	
5	22.0260	14.07	20.32	34.39	50.00	-15.61	AVG	
6	22.9060	15.29	20.31	35.60	50.00	-14.40	AVG	
7	23.3020	23.93	20.30	44.23	60.00	-15.77	QP	
8	23.3020	17.22	20.30	37.52	50.00	-12.48	AVG	
9	26.4300	26.24	20.28	46.52	60.00	-13.48	QP	
10	26.4300	17.30	20.28	37.58	50.00	-12.42	AVG	
11	29.5700	26.33	20.27	46.60	60.00	-13.40	QP	
12	29.8020	17.22	20.27	37.49	50.00	-12.51	AVG	

Conducted Emission Test Data

Test Site: 1# Shielded Room
 Operating Condition: Keeping TX mode
 Test Specification: AC 120V, 60Hz for adapter
 Comment: Neutral Line
 Tem.:25°C Hum.:50%

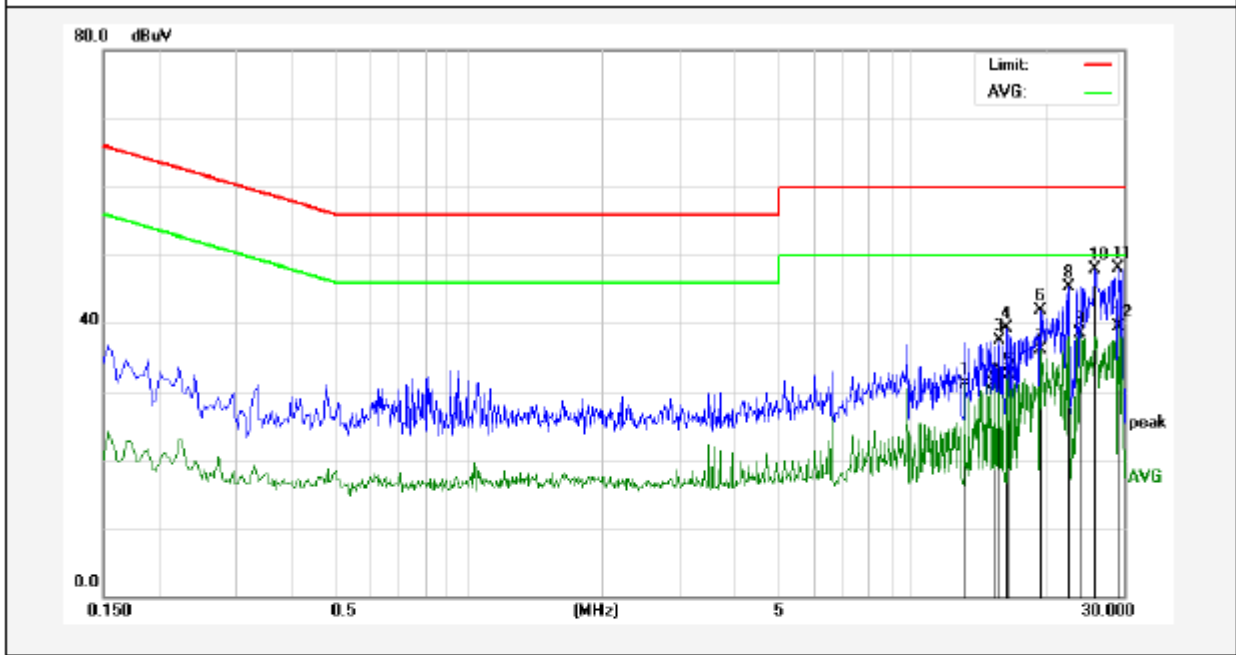

No.	Freq. (MHz)	Reading (dBuV)	Factor (dB)	Result (dBuV)	Limit dBuV	Over Limit (dB)	Detector	Remark
1	13.1780	10.74	20.29	31.03	50.00	-18.97	AVG	
2	15.3420	10.78	20.27	31.05	50.00	-18.95	AVG	
3	15.7820	17.20	20.27	37.47	60.00	-22.53	QP	
4	16.3300	19.00	20.28	39.28	60.00	-20.72	QP	
5	16.5540	12.23	20.28	32.51	50.00	-17.49	AVG	
6	19.4740	21.51	20.33	41.84	60.00	-18.16	QP	
7	19.4740	15.72	20.33	36.05	50.00	-13.95	AVG	
8	22.6060	25.03	20.31	45.34	60.00	-14.66	QP	
9	23.7780	18.17	20.29	38.46	50.00	-11.54	AVG	
10	25.7420	27.56	20.28	47.84	60.00	-12.16	QP	
11	29.1180	27.92	20.27	48.19	60.00	-11.81	QP	
12	29.1180	19.18	20.27	39.45	50.00	-10.55	AVG	

Conducted Emission Test Data

Test Site: 1# Shielded Room
 Operating Condition: Keeping TX mode
 Test Specification: AC 240V, 60Hz for adapter
 Comment: Live Line
 Tem.:25°C Hum.:50%

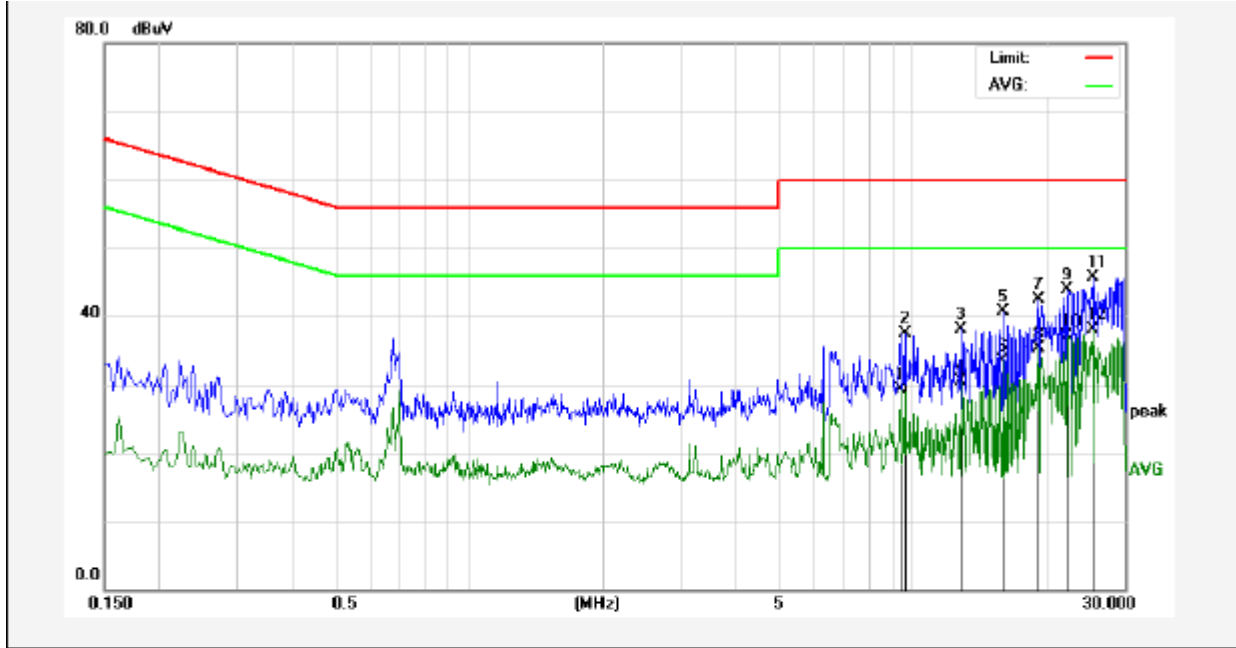

No.	Freq. (MHz)	Reading (dBuV)	Factor (dB)	Result (dBuV)	Limit dBuV	Over Limit (dB)	Detector	Remark
1	9.3900	8.95	20.32	29.27	50.00	-20.73	AVG	
2	9.5980	17.22	20.33	37.55	60.00	-22.45	QP	
3	12.7940	17.90	20.30	38.20	60.00	-21.80	QP	
4	12.7940	10.27	20.30	30.57	50.00	-19.43	AVG	
5	15.9980	20.42	20.28	40.70	60.00	-19.30	QP	
6	15.9980	13.28	20.28	33.56	50.00	-16.44	AVG	
7	19.1259	22.09	20.33	42.42	60.00	-17.58	QP	
8	19.1259	15.04	20.33	35.37	50.00	-14.63	AVG	
9	22.2540	23.66	20.31	43.97	60.00	-16.03	QP	
10	22.2540	16.74	20.31	37.05	50.00	-12.95	AVG	
11	25.3900	25.52	20.28	45.80	60.00	-14.20	QP	
12	25.3900	17.73	20.28	38.01	50.00	-11.99	AVG	

Conducted Emission Test Data

Test Site: 1# Shielded Room
 Operating Condition: Keeping TX mode
 Test Specification: AC 240V, 60Hz for adapter
 Comment: Neutral Line
 Tem.:25°C Hum.:50%

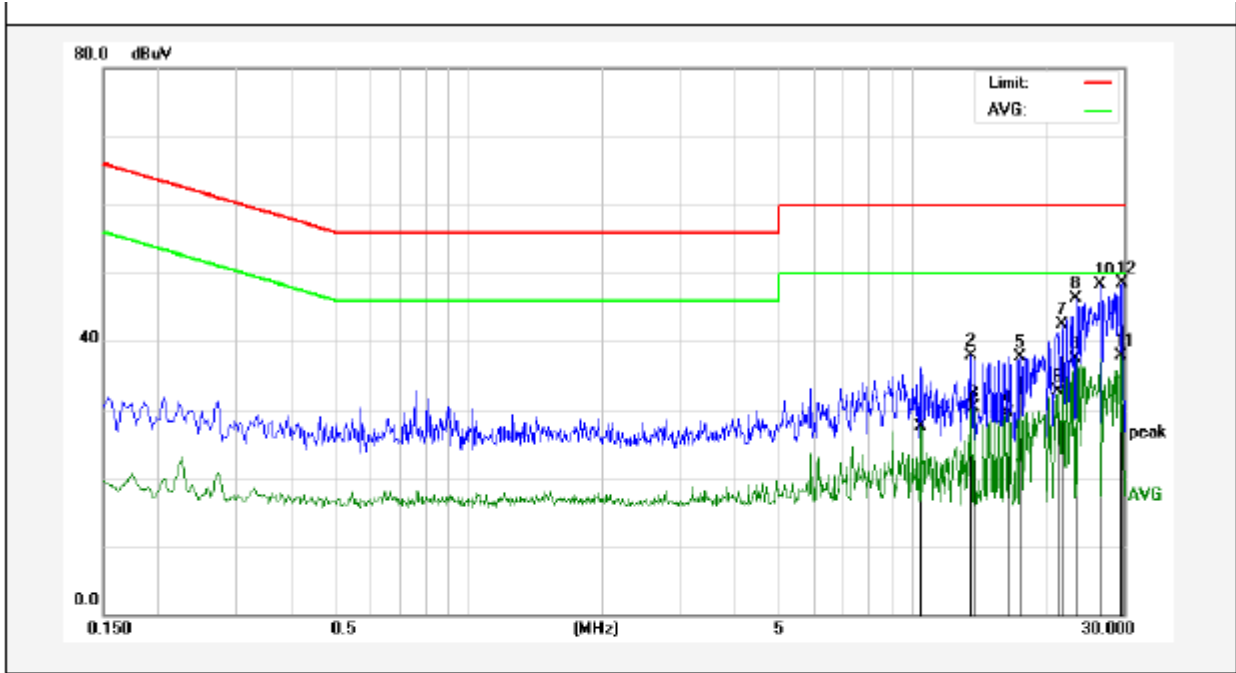

No.	Freq. (MHz)	Reading (dBuV)	Factor (dB)	Result (dBuV)	Limit dBuV	Over Limit (dB)	Detector	Remark
1	10.4300	7.23	20.33	27.56	50.00	-22.44	AVG	
2	13.5620	17.57	20.28	37.85	60.00	-22.15	QP	
3	13.7580	9.99	20.28	30.27	50.00	-19.73	AVG	
4	16.4380	9.28	20.28	29.56	50.00	-20.44	AVG	
5	17.5380	17.47	20.30	37.77	60.00	-22.23	QP	
6	21.3700	12.42	20.32	32.74	50.00	-17.26	AVG	
7	21.8100	22.14	20.32	42.46	60.00	-17.54	QP	
8	23.3020	25.99	20.30	46.29	60.00	-13.71	QP	
9	23.3020	17.20	20.30	37.50	50.00	-12.50	AVG	
10	26.4300	28.02	20.28	48.30	60.00	-11.70	QP	
11	29.5620	17.69	20.27	37.96	50.00	-12.04	AVG	
12	29.7140	28.23	20.27	48.50	60.00	-11.50	QP	

4. Radiation Spurious Emission and Band Edge

4.1. Test Standard and Limit

Test Standard	FCC Part15 C Section 15.209 and 15.205				
Test Limit	Frequency (MHz)	Field strength (microvolt/meter)	Limit (dBuV/m)	Remark	Measurement distance (m)
	0.009MHz~0.490MHz	2400/F(kHz)	-	-	300
	0.490MHz-1.705MHz	24000/F(kHz)	-	-	30
	1.705MHz-30MHz	30	-	-	30
	30MHz~88MHz	100	40.0	Quasi-peak	3
	88MHz~216MHz	150	43.5	Quasi-peak	3
	216MHz~960MHz	200	46.0	Quasi-peak	3
	960MHz~1000MHz	500	54.0	Quasi-peak	3
	Above 1000MHz	500	54.0	Average	3
-		74.0	Peak	3	

Remark:

(1)The lower limit shall apply at the transition frequency.

(2) 15.35(b), Unless otherwise specified, the limit on peak radio frequency emissions is 20dB above the maximum permitted average emission limit applicable to the equipment under test. This peak limit applies to the total peak emission level radiated by the device.

4.2. Test Setup

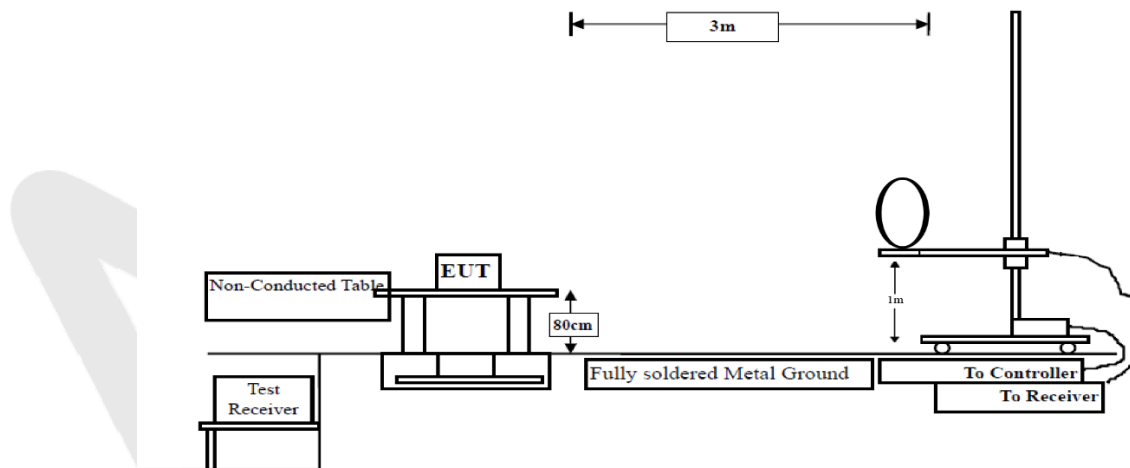

Figure 1. Below 30MHz

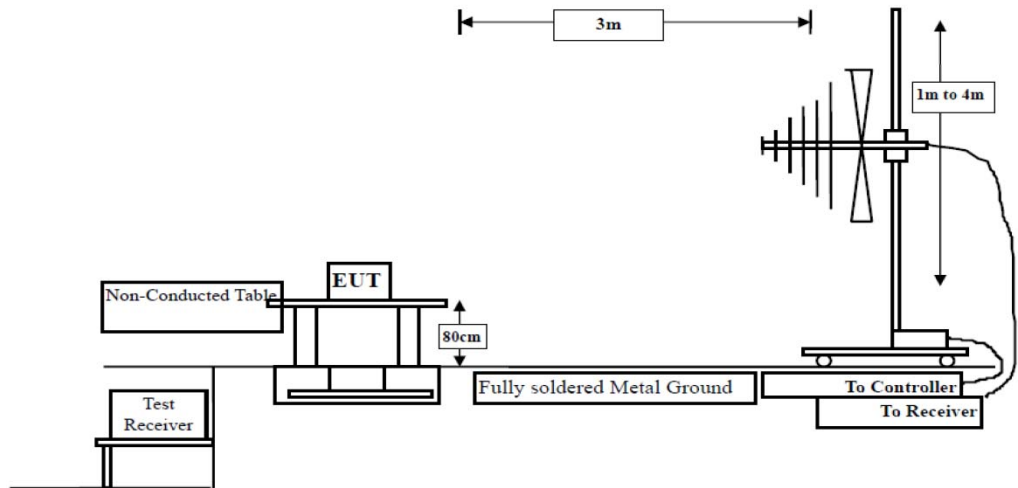

Figure 2. 30MHz to 1GHz

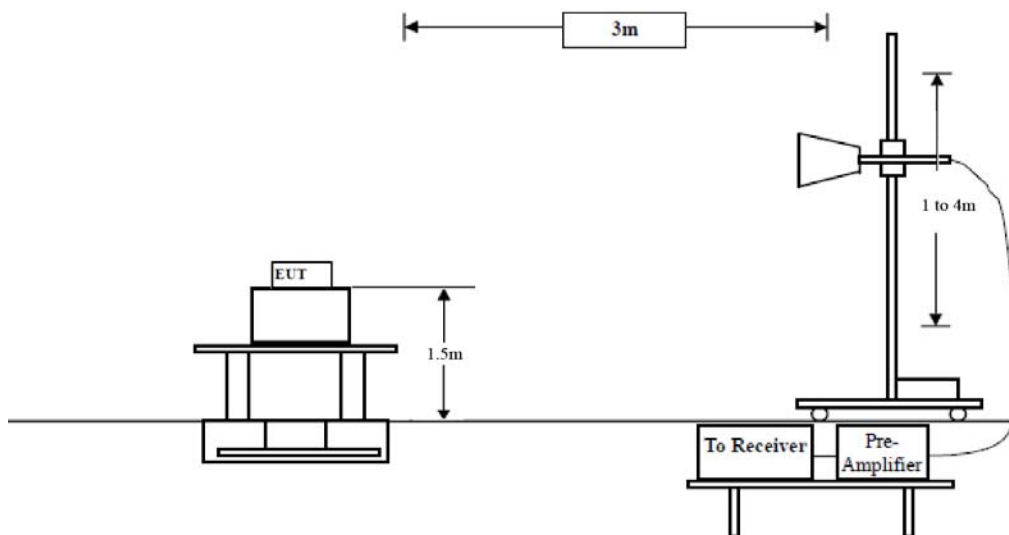

Figure 3. Above 1 GHz

4.3. Test Procedure

For below 1GHz: The EUT is placed on a turntable, which is 0.8m above the ground plane.

For above 1GHz: The EUT is placed on a turntable, which is 1.5m above the ground plane.

The turn table can rotate 360 degrees to determine the position of the maximum emission level. The EUT is set 3 meters away from the receiving antenna which is mounted on a antenna tower. The antenna can be moved up and down from 1 to 4 meters to find out the maximum emission level. Rotated the EUT through three orthogonal axes to determine the maximum emissions, both horizontal and vertical polarization of the antenna are set on test. The EUT is tested in 9*6*6 Chamber. The device is evaluated in xyz orientation.

For 9kHz to 150kHz, Set the spectrum analyzer as:

RBW = 200Hz, VBW =1kHz, Detector= Quasi-Peak, Trace mode= Max hold, Sweep- auto couple.

For 150kHz to 30MHz, Set the spectrum analyzer as:

RBW = 9KHz, VBW =30kHz, Detector= Quasi-Peak, Trace mode= Max hold, Sweep- auto couple.

For 30MHz to 1000MHz, Set the spectrum analyzer as:

RBW = 100kHz, VBW =300kHz, Detector= Quasi-Peak, Trace mode= Max hold, Sweep- auto couple.

4.4. Test Data

PASS

Anbotek

Test Results

(Between 9KHz – 30MHz)

Job No.:	0217080095W		
Standard:	FCC PART15 C _3m	Power Source:	AC120V/60Hz for adapter
Test item:	Radiation Test	Temp.(C)/Hum.(%RH):	24.4(C)/50%RH
Test Mode:	TX Mode	Distance:	3m

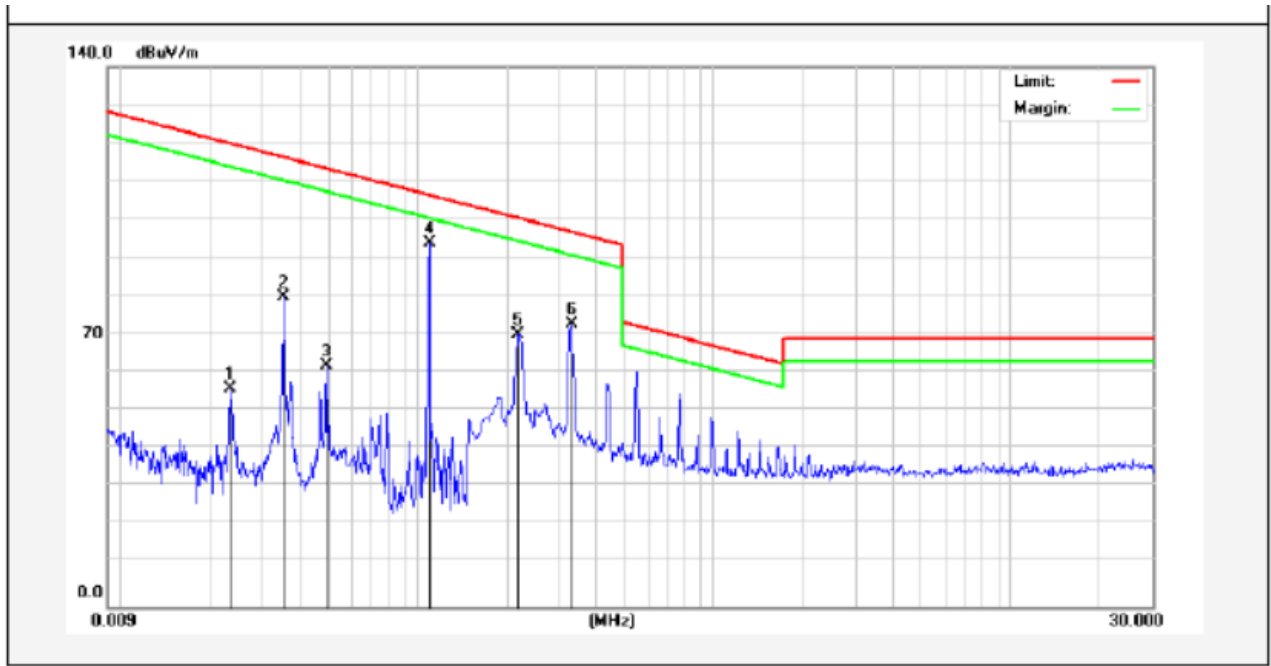

Frequency (MHz)	Read Level (dBuV)	Antenna Factor (dB/m)	Cable Loss (dB)	Preamp Factor (dB)	Level (dBuV/m)	Limit (dBuV/m)	Over Limit (dB)	Detector	degree
									(dgc)
0.0235	34.65	19.30	2.53	0	56.48	140.11	-83.63	Peak	15
0.0235	32.69	19.30	2.53	0	54.52	120.11	-65.59	AV	15
0.0355	58.55	19.30	2.53	0	80.38	136.54	-56.16	Peak	33
0.0355	56.79	19.30	2.53	0	78.62	116.54	-37.92	AV	33
0.0495	40.57	19.29	2.54	0	62.40	133.66	-71.26	Peak	124
0.0495	37.91	19.29	2.54	0	59.74	113.66	-53.92	AV	124
0.1096	72.34	19.36	2.55	0	94.25	106.77	-12.52	QP	101
0.2180	48.47	19.63	2.59	0	70.69	100.81	-30.12	QP	324
0.3300	50.30	20.32	2.60	0	73.22	97.22	-24.00	QP	0

Remark: According to FCC PART 15.209 (d), the emission limits for the frequency bands 9–90 kHz, 110–490 kHz and above 1000 MHz, Radiated emission limits in these three bands are based on measurements employing an average detector.

(Between 30MHz –1000 MHz)

Job No.:	0217080095W	Polarization:	Horizontal
Standard:	FCC PART15 C _3m	Power Source:	AC 120V/ 60Hz for adapter
Test item:	Radiation Test	Temp.(C)/Hum.(%RH):	24.4(C)/50%RH
Test Mode:	TX Mode	Distance:	3m

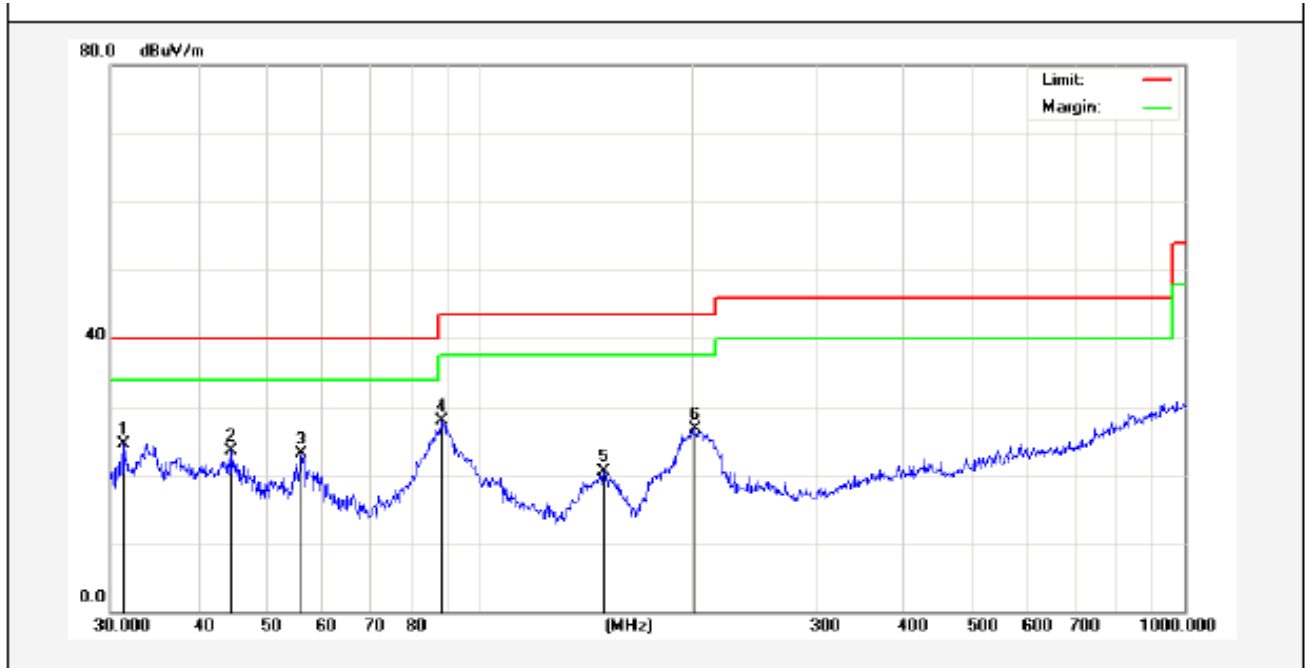

No.	Freq. (MHz)	Reading (dBuV/m)	Factor (dB/m)	Result (dBuV/m)	Limit (dBuV/)	Over Limit (dB)	Detector	Height (cm)	degree (deg)	Remark
1	31.2893	40.91	-16.33	24.58	40.00	-15.42	QP	300	46	
2	44.4308	35.93	-12.39	23.54	40.00	-16.46	QP	300	95	
3	56.0007	38.15	-15.03	23.12	40.00	-16.88	QP	300	147	
4	88.6524	50.07	-22.20	27.87	43.50	-15.63	QP	300	201	
5	150.0108	43.90	-23.34	20.56	43.50	-22.94	QP	300	276	
6	202.8104	47.40	-20.77	26.63	43.50	-16.87	QP	300	360	



Job No.:	0217080095W	Plarization:	Vertical
Standard:	FCC PART15 C _3m	Power Source:	AC 120V/60Hz for adapter
Test item:	Radiation Test	Temp.(C)/Hum.(%RH):	24.4(C)/50%RH
Test Mode:	TX Mode	Distance:	3m

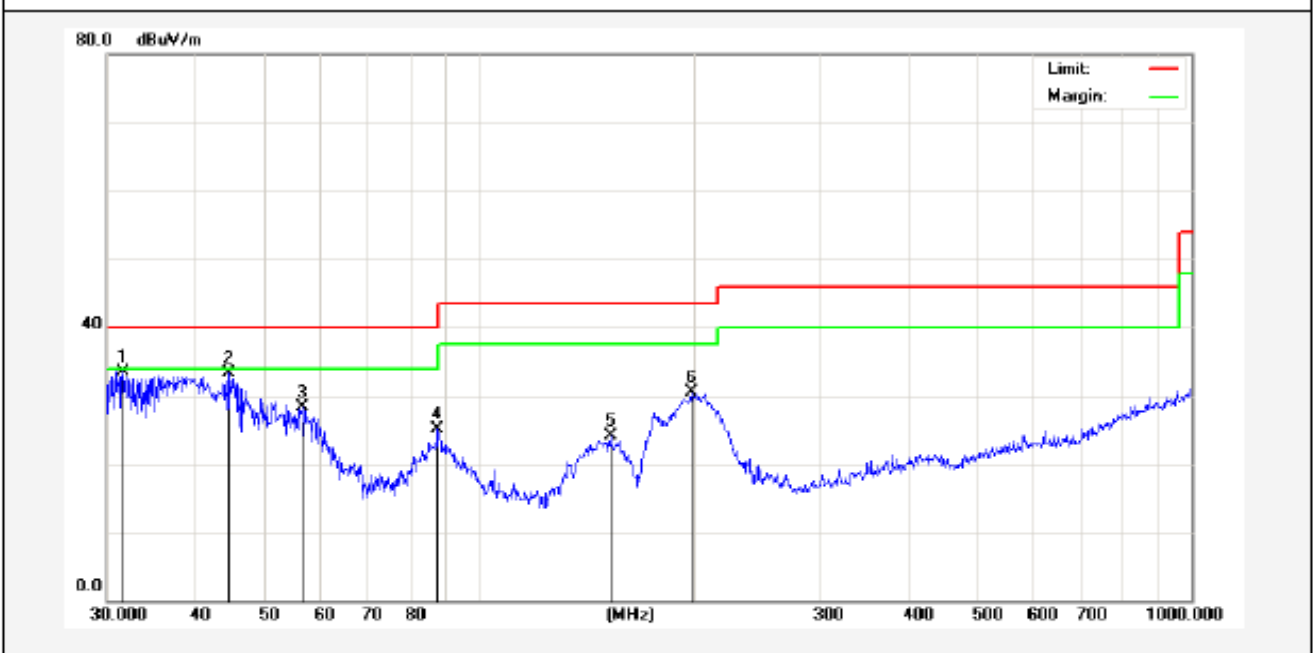

No.	Freq. (MHz)	Reading (dBuV/m)	Factor (dB/m)	Result (dBuV/m)	Limit (dBuV/)	Over Limit (dB)	Detector	Height (cm)	degree (deg)	Remark
1	31.6202	49.63	-16.17	33.46	40.00	-6.54	QP	300	32	
2	44.4308	45.77	-12.39	33.38	40.00	-6.62	QP	300	96	
3	56.5929	43.43	-15.08	28.35	40.00	-11.65	QP	300	154	
4	87.4177	43.12	-18.11	25.01	40.00	-14.99	QP	300	203	
5	152.6641	42.24	-18.22	24.02	43.50	-19.48	QP	300	275	
6	198.5880	46.31	-15.88	30.43	43.50	-13.07	QP	300	360	



APPENDIX I -- TEST SETUP PHOTOGRAPH

Photo of Conducted Emission Measurement



Photo of Radiation Emission Test

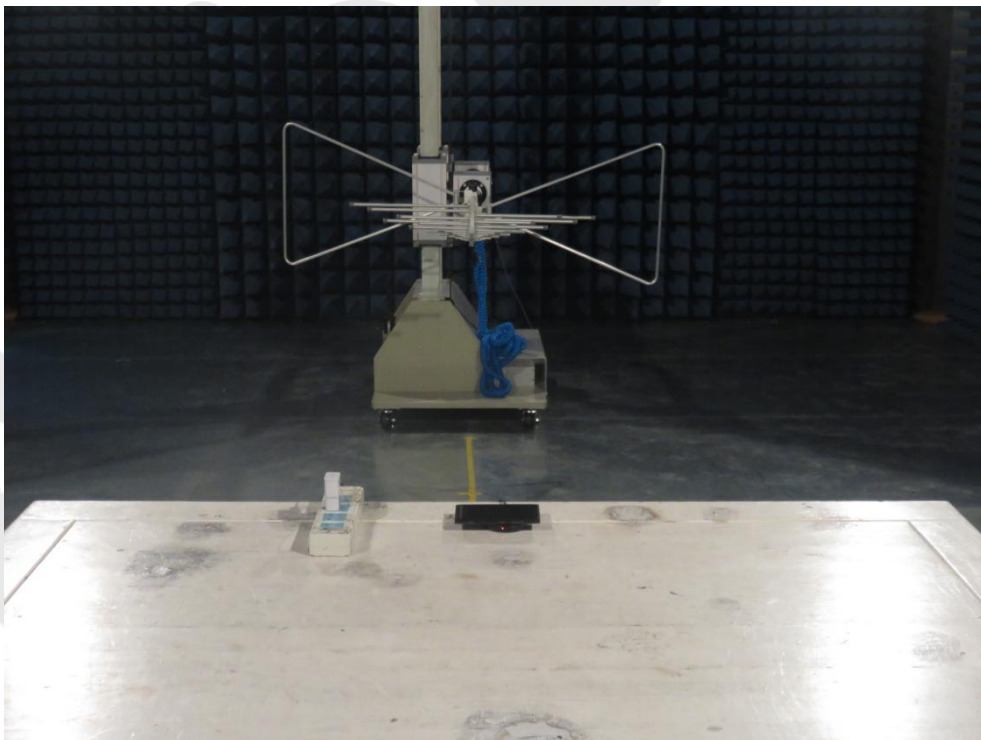

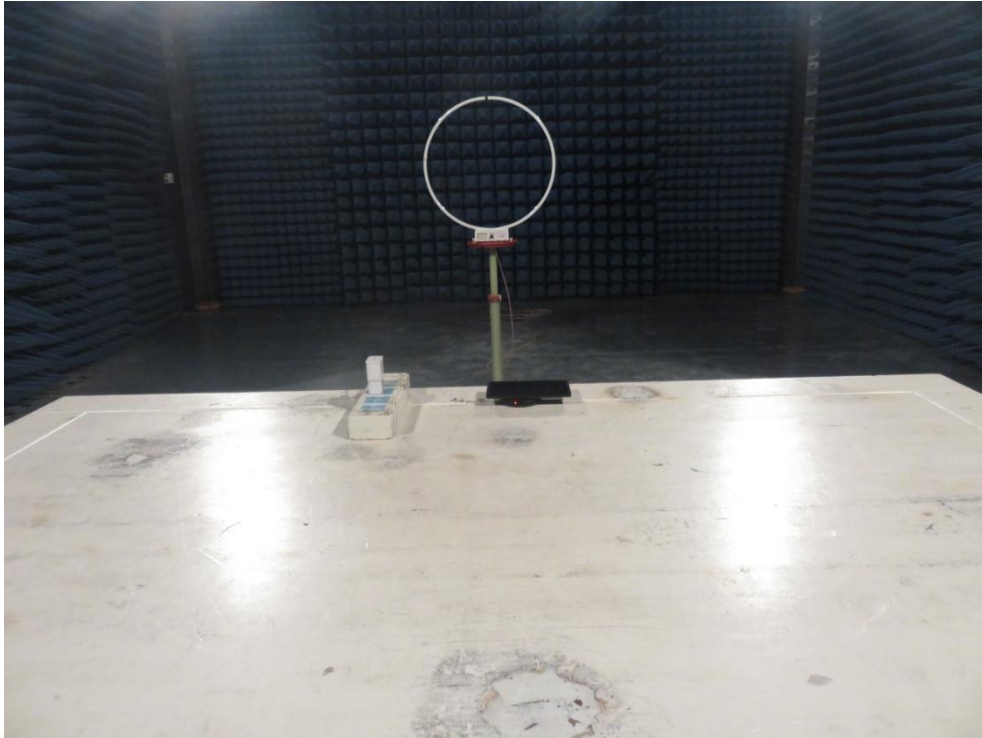

Anbotek

APPENDIX II -- EXTERNAL PHOTOGRAPH

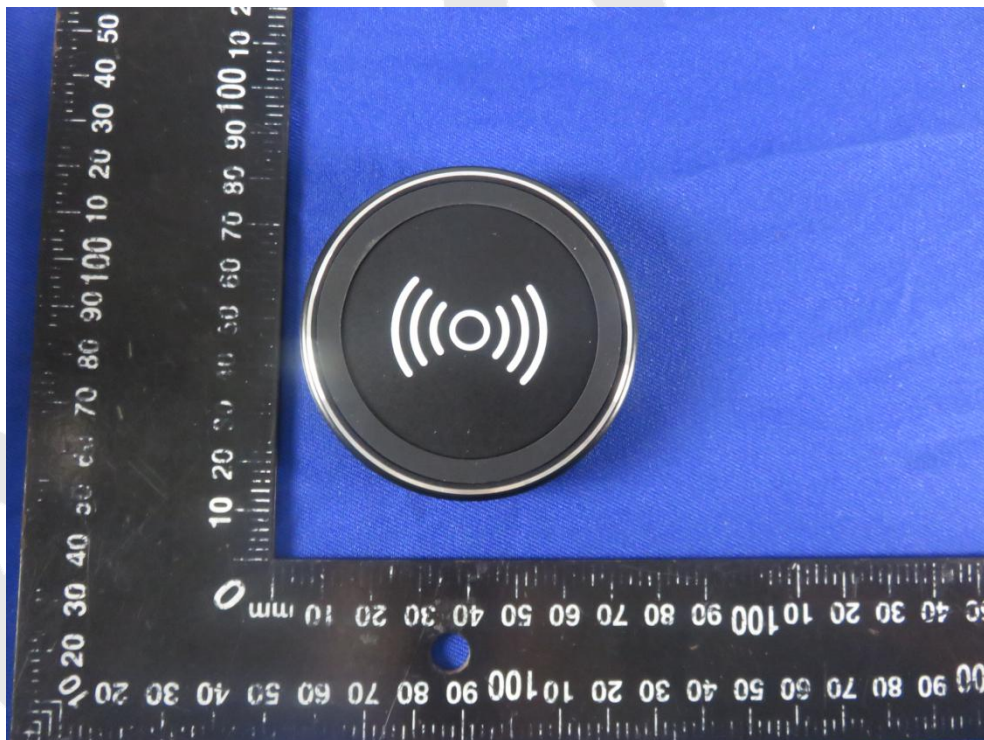

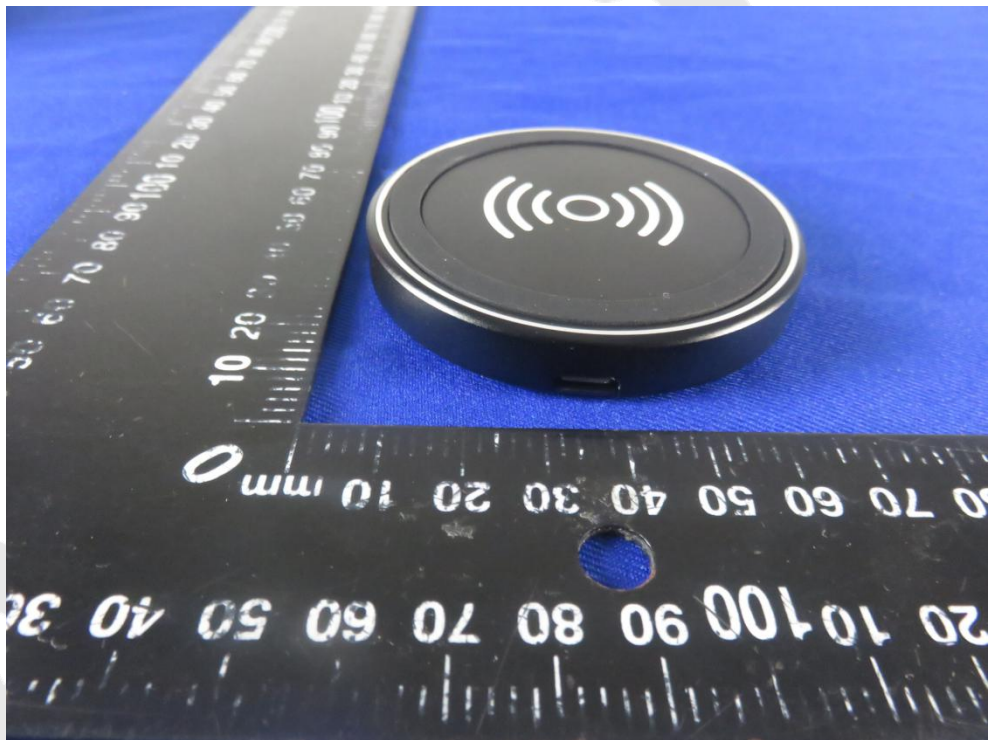

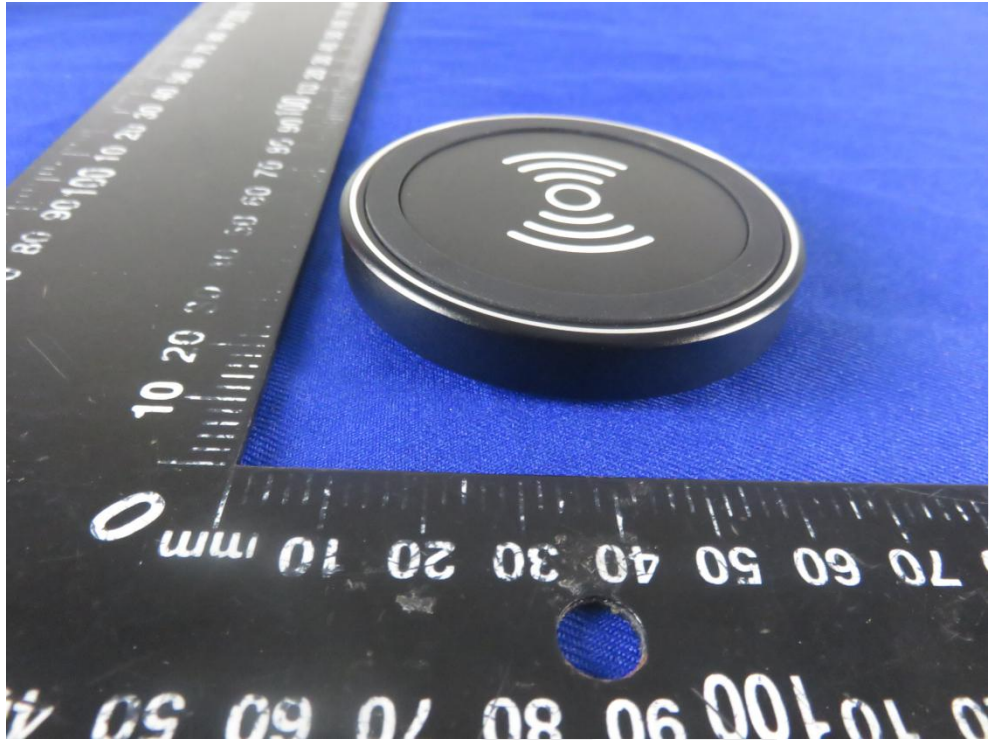

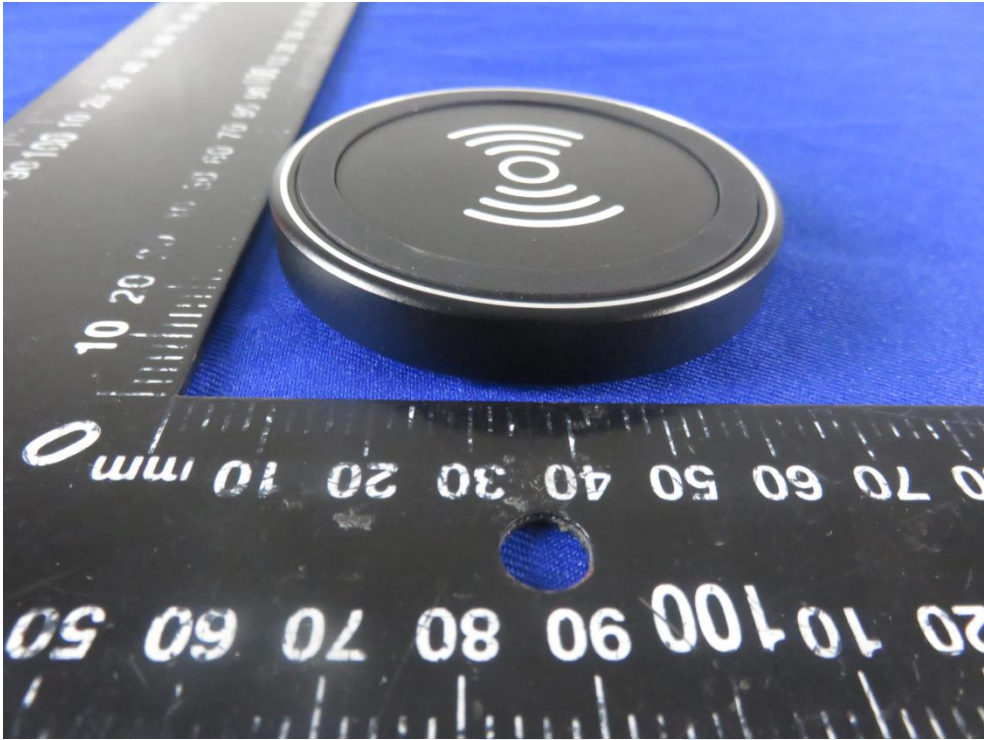

Anbotek

APPENDIX III -- INTERNAL PHOTOGRAPH

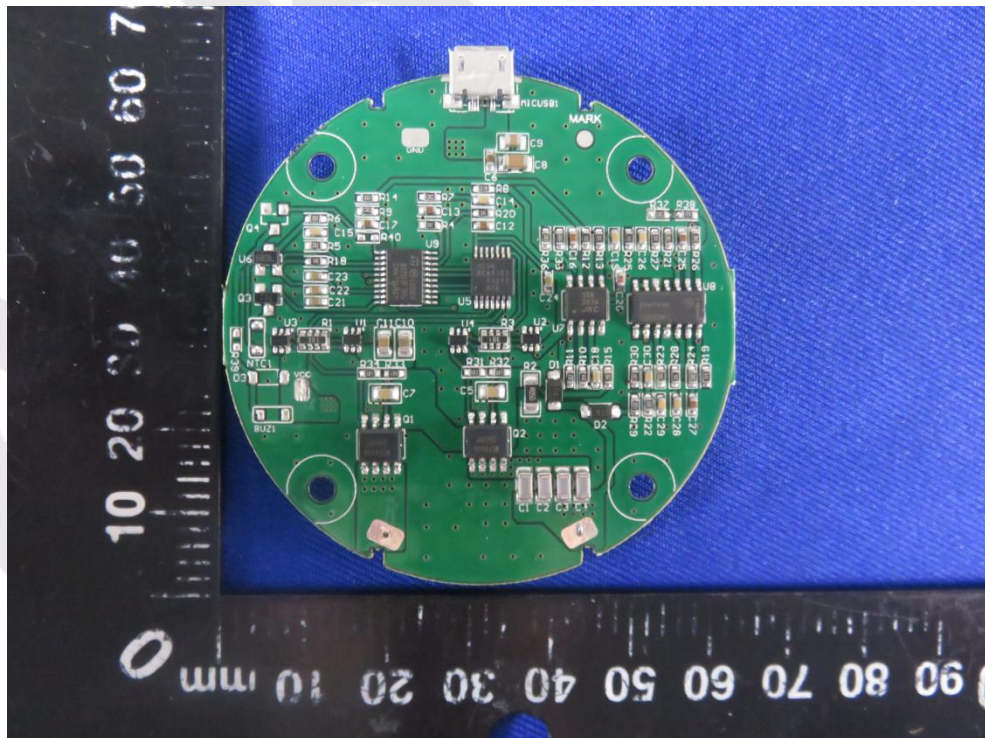
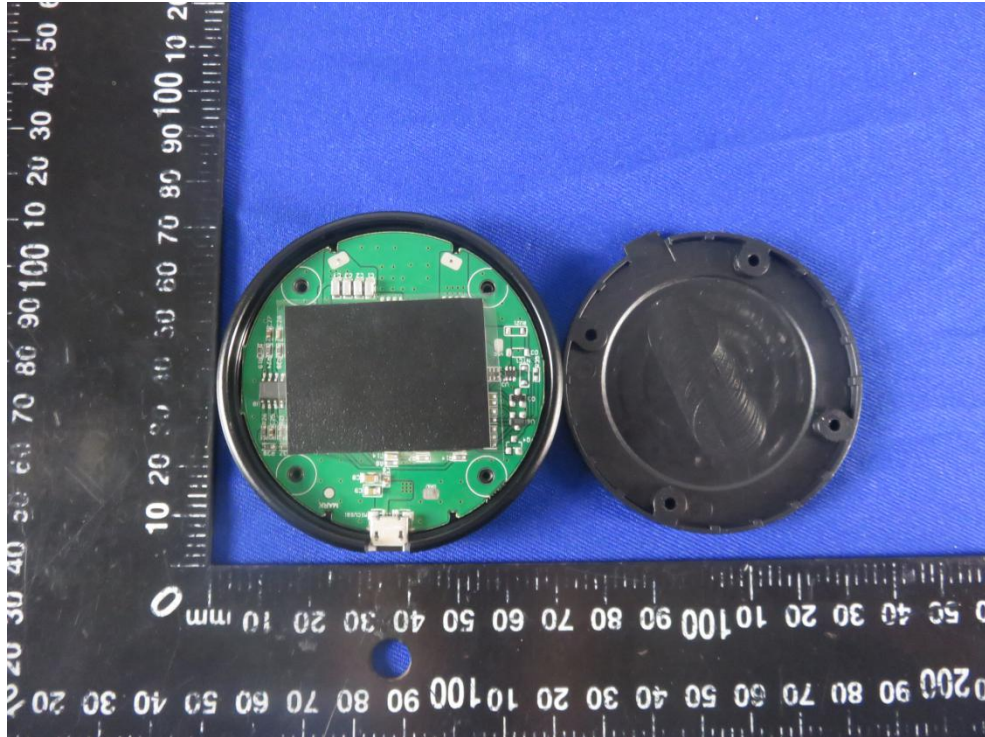

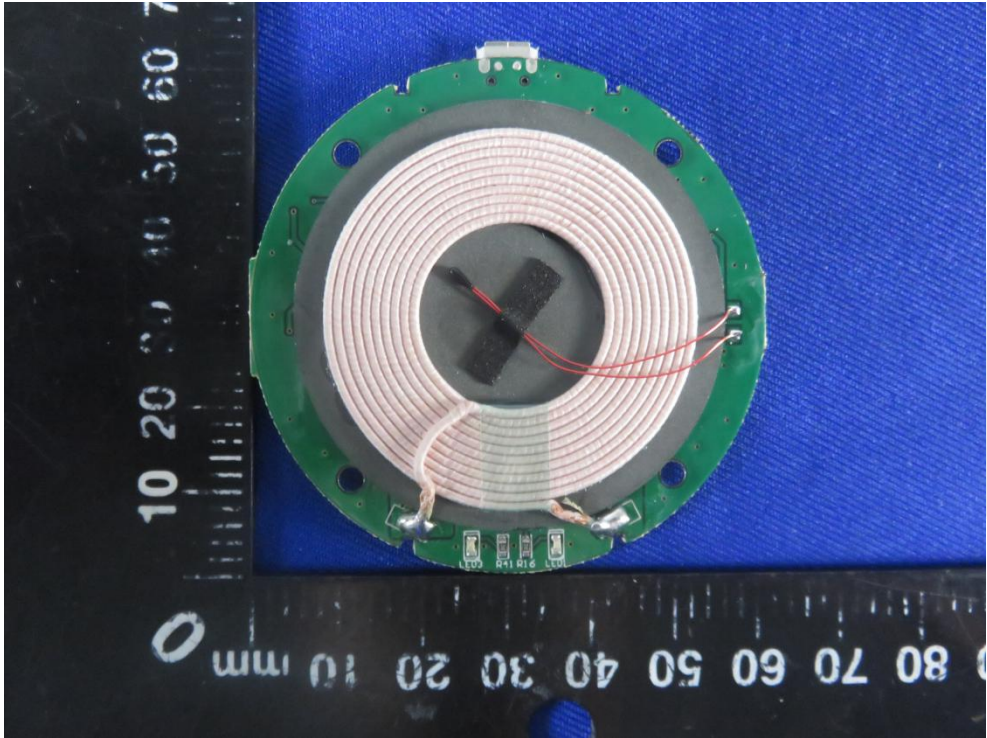

Inductive loop coil Antenna

