

FCC TEST REPORT
for
Wintop Electronics Co., Limited

2.4GHz Wireless Optical Mouse
Model No.: WM-709, MP1975BLK,
MP1975BLU, MP1975RED, MP1975PUR

Prepared for : Wintop Electronics Co., Limited
Address : Unit 04 7/F, Bright Way Tower 33, Mong Kok RD KL,
HONGKONG

Prepared By : Shenzhen Anbotek Compliance Laboratory Limited
Address : 1/F., Building 1, SEC Industrial Park, No.0409 Qianhai Road,
Nanshan District, Shenzhen, Guangdong, China
Tel: (86) 755-26066544
Fax: (86) 755-26014772

Report Number : R011507849I
Date of Test : Jul. 29~Aug. 11, 2015
Date of Report : Aug. 12, 2015

TABLE OF CONTENTS

Description	Page
Test Report	
1. GENERAL INFORMATION.....	4
1.1. Description of Device (EUT).....	4
1.2. Auxiliary Equipment Used during Test.....	5
1.3. Description of Test Facility.....	5
1.4. Measurement Uncertainty.....	5
2. TEST PROCEDURE.....	6
3. RADIATION INTERFERENCE.....	7
3.1. Requirements (15.249, 15.209):.....	7
3.2. Test Procedure.....	7
3.3. Test Results.....	7
4. BANDEDGE.....	13
4.1. Requirements (15.249):.....	13
4.2. Test Procedure.....	13
4.3. Test Configuration:.....	13
4.4. Test Results.....	14
5. OCCUPIED BANDWIDTH.....	23
5.1. Requirements :	23
5.2. Test SET-UP.....	23
5.3 Test Equipment.....	23
5.4. Test Results.....	23
6. ANTENNA APPLICATION.....	26
6.1. Antenna requirement.....	26
6.2. Result.....	26
7. PHOTOGRAPH.....	27
7.1. Photo of Radiation Emission Test.....	27

TEST REPORT

Applicant : Wintop Electronics Co., Limited
Manufacturer : Shenzhen Wintop Electronics Co., Limited
EUT : 2.4GHz Wireless Optical Mouse
Model No. : WM-709, MP1975BLK, MP1975BLU, MP1975RED, MP1975PUR
Serial No. : N.A.
Trade Mark : N.A.
Rating : DC 1.5V, 6mA Max.

Measurement Procedure Used:

FCC Part15 Subpart C, Paragraph 15.207, 15.249 & 15.209

The device described above is tested by Shenzhen Anbotek Compliance Laboratory Limited to determine the maximum emission levels emanating from the device and the severe levels of the device can endure and its performance criterion. The measurement results are contained in this test report and Shenzhen Anbotek Compliance Laboratory Limited is assumed full of responsibility for the accuracy and completeness of these measurements. Also, this report shows that the EUT (Equipment Under Test) is technically compliant with the FCC Part 15 Subpart C requirements.

This report applies to above tested sample only and shall not be reproduced in part without written approval of Shenzhen Anbotek Compliance Laboratory Limited.

Date of Test : Jul. 29~Aug. 11, 2015

Prepared by : Kebo Zhang
(Tested Engineer / Kebo Zhang)

Reviewer : Amy Ding
(Project Manager / Amy Ding)

Approved & Authorized Signer : Tom Chen
(Manager / Tom Chen)

1. GENERAL INFORMATION

1.1. Description of Device (EUT)

EUT	: 2.4GHz Wireless Optical Mouse
Model Number	: WM-709, MP1975BLK, MP1975BLU, MP1975RED, MP1975PUR (Note: All samples are the same except the model number and colour, so we prepare “WM-709” for test only.)
Test Power Supply	: DC 1.5V
Frequency	: 2405~2472MHz
Channel Space	: 1MHz
No. of Channels	: 68
Antenna Specification	: PCB Antenna:1.76 dBi
Applicant Address	: Wintop Electronics Co., Limited Unit 04 7/F, Bright Way Tower 33, Mong Kok RD KL, HONGKONG
Manufacturer Address	: Shenzhen Wintop Electronics Co., Limited Huaguan Industrial Park, Xinhe Road, Baolai Industrial District, Shangmugu, Pinghu Town, Longgang District, Shenzhen City, 518000, China
Factory Address	: Shenzhen Wintop Electronics Co., Limited Huaguan Industrial Park, Xinhe Road, Baolai Industrial District, Shangmugu, Pinghu Town, Longgang District, Shenzhen City, 518000, China
Date of receipt	: Jul. 29, 2015
Date of Test	: Jul. 29~Aug. 11, 2015

1.2. Auxiliary Equipment Used during Test

N/A

1.3. Description of Test Facility

The test facility is recognized, certified, or accredited by the following organizations:

CNAS - LAB Code: L3503

Shenzhen Anbotek Compliance Laboratory Limited., Laboratory has been assessed and in compliance with CNAS/CL01: 2006 accreditation criteria for testing laboratories (identical to ISO/IEC 17025:2005 General Requirements) for the Competence of Testing Laboratories.

FCC-Registration No.: 752021

Shenzhen Anbotek Compliance Laboratory Limited, EMC Laboratory has been registered and fully described in a report filed with the (FCC) Federal Communications Commission. The acceptance letter from the FCC is maintained in our files. Registration 752021, July 10, 2013.

IC-Registration No.: 8058A-1

Shenzhen Anbotek Compliance Laboratory Limited., EMC Laboratory has been registered and fully described in a report filed with the (IC) Industry Canada. The acceptance letter from the IC is maintained in our files. Registration 8058A-1, February 22, 2013.

Test Location

All Emissions tests were performed at Shenzhen Anbotek Compliance Laboratory Limited. at 1/F., Building 1, SEC Industrial Park, No.0409 Qianhai Road, Nanshan District, Shenzhen, Guangdong, China

1.4. Measurement Uncertainty

Radiation Uncertainty	:	Ur = 4.1 dB (Horizontal) Ur = 4.3 dB (Vertical)
Conduction Uncertainty	:	Uc = 3.4dB

2. Test Procedure

GENERAL: This report shall NOT be reproduced except in full without the written approval of Shenzhen Anbotek Compliance Laboratory Limited. The EUT was transmitting a test signal during the testing.

RADIATION INTERFERENCE: The test procedure used was ANSI STANDARD C63.10-2013 using a spectrum analyzer with a pre-selector. The analyzer was calibrated in dB above a microvolt at the output of the antenna. The resolution bandwidth was 100KHz and the video bandwidth was 300KHz up to 1.0GHz and 1.0MHz with a video BW of 3.0MHz above 1.0GHz. The ambient temperature of the EUT was 74.3oF with a humidity of 69%.

FORMULA OF CONVERSION FACTORS: The Field Strength at 3m was established by adding the meter reading of the spectrum analyzer (which is set to read in units of dBuV) to the antenna correction factor supplied by the antenna manufacturer. The antenna correction factors are stated in terms of dB. The gain of the Preselector was accounted for in the Spectrum Analyzer Meter Reading.

Example:

Freq (MHz) METER READING + ACF = FS
20 dBuV + 10.36 dB = 30.36 dBuV/m @ 3m

ANSI STANDARD C63.10-2013 10.1.7 MEASUREMENT PROCEDURES: The EUT was placed on a table 80 cm high and with dimensions of 1m by 1.5m. The EUT was placed in the center of the table (1.5m side). The table used for radiated measurements is capable of continuous rotation.

When an emission was found, the table was rotated to produce the maximum signal strength. At this point, the antenna was raised and lowered from 1m to 4m. The antenna was placed in both the horizontal and vertical planes.

3. Radiation Interference

3.1. Requirements (15.249, 15.209):

FIELD STRENGTH of Fundamental: @3M 902-928 MHZ 2.4-2.4835 GHz 94 dB μ V/m @3m	FIELD STRENGTH of Harmonics 54 dB μ V/m @3m	S15.209 30 - 88 MHz 88 - 216 MHz 216 - 960 MHz ABOVE 960 MHz	40 dBuV/m 43.5 46 54dBuV/m
--	---	--	---

Emissions radiated outside of the specified frequency bands, except for harmonics, shall be attenuated by at least 50 dB below the level of the fundamental or to the general radiated emission limits in 15.209, whichever is the lesser attenuation.

3.2. Test Procedure

For below 1GHz, the EUT is placed on a turn table which is 0.8 meter high above the ground. For above 1GHz, the EUT is placed on a turn table which is 1.5 meter high above the ground. The turn table can rotate 360 degrees to determine the position of the maximum emission level. The EUT is set 3 meters away from the receiving antenna which is mounted on a antenna tower. The antenna can be moved up and down from 1 to 4 meters to find out the maximum emission level. Both horizontal and vertical polarization of the antenna are set on test.

All readings from 30MHz to 1GHz are quasi-peak values with a resolution bandwidth of 120kHz. All reading are above 1GHz, peak & average values with a resolution bandwidth of 1MHz. The EUT is tested in 9*6*6 Chamber. The device is evaluated in xyz orientation. The test results are listed in Section 4.3.

Test Equipment

Item	Equipment	Manufacturer	Model No.	Serial No.	Last Cal.	Cal. Interval
1.	Spectrum Analysis	Agilent	E4407B	US39390582	Apr. 17, 2015	1 Year
2.	Preamplifier	Instruments corporation	EMC011830	980100	Apr. 17, 2015	1 Year
3.	EMI Test Receiver	Rohde & Schwarz	ESPI	101604	Apr. 17, 2015	1 Year
4.	Double Ridged Horn Antenna	Instruments corporation	GTH-0118	351600	Apr. 20, 2015	1 Year
5.	Bilog Broadband Antenna	Schwarzbeck	VULB9163	VULB 9163-289	Apr. 20, 2015	1 Year
6.	Pre-amplifier	SONOMA	310N	186860	Apr. 17, 2015	1 Year
7.	EMI Test Software EZ-EMC	SHURPLE	N/A	N/A	N/A	N/A

3.3. Test Results

PASS.

Please refer the following pages. Only the worst case (x orientation).

Below 1GHz:

Job No.:	011507849I	Polarziation:	Horizontal
Standard:	(RE)FCC PART15 C _3m	Power Source:	DC 1.5V
Test item:	Radiation Test	Temp.(C)/Hum.(%RH):	24.3(C)/55%RH
Mode:	ON	Distance:	3m
Note:	30-1000MHz		

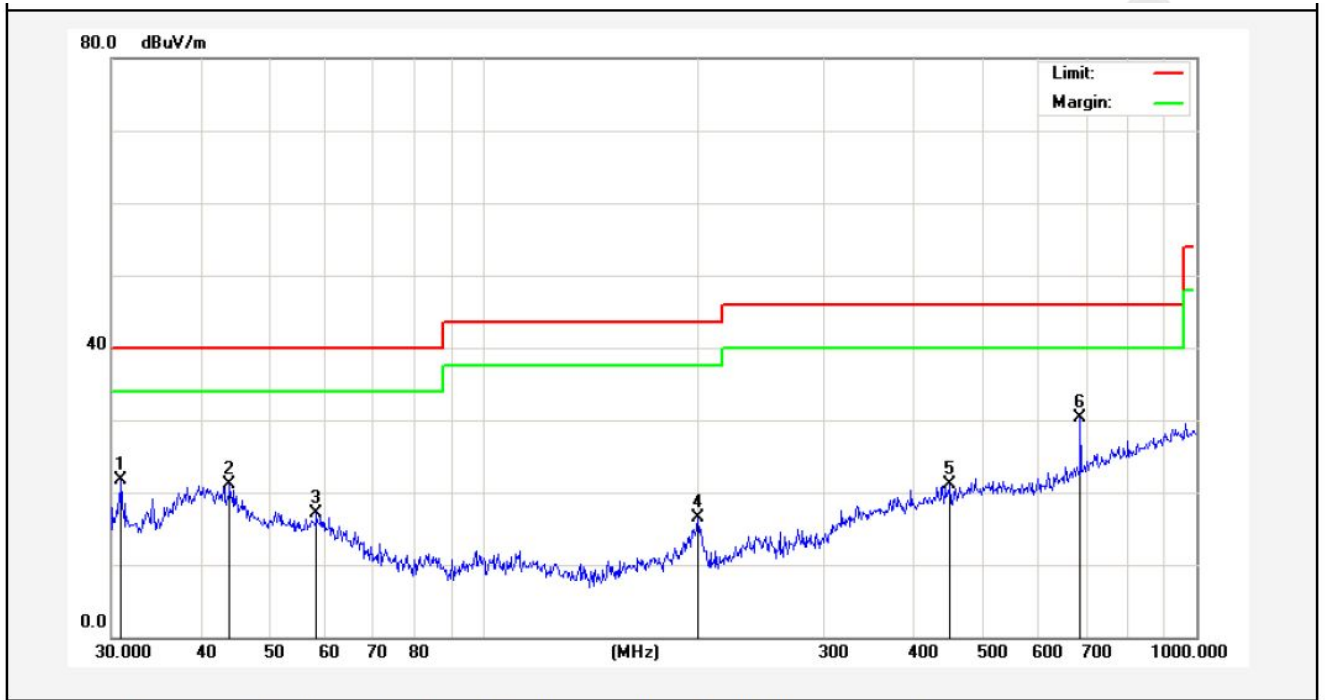

No.	Freq. (MHz)	Reading (dBuV/m)	Factor (dB/m)	Result (dBuV/m)	Limit (dBuV/)	Over Limit (dB)	Detector	Height (cm)	degree (deg)	Remark
1	30.9618	38.07	-16.44	21.63	40.00	-18.37	peak			
2	43.9658	33.04	-11.92	21.12	40.00	-18.88	peak			
3	58.2030	32.32	-15.23	17.09	40.00	-22.91	peak			
4	199.9856	37.46	-20.87	16.59	43.50	-26.91	peak			
5	451.1349	33.33	-12.15	21.18	46.00	-24.82	peak			
6	687.1507	39.17	-8.83	30.34	46.00	-15.66	peak			

Job No.:	011507849I	Polarziation:	Vertical
Standard:	(RE)FCC PART15 C _3m	Power Source:	DC 1.5V
Test item:	Radiation Test	Temp.(C)/Hum.(%RH):	24.3(C)/55%RH
Mode:	ON	Distance:	3m
Note:	30-1000MHz		

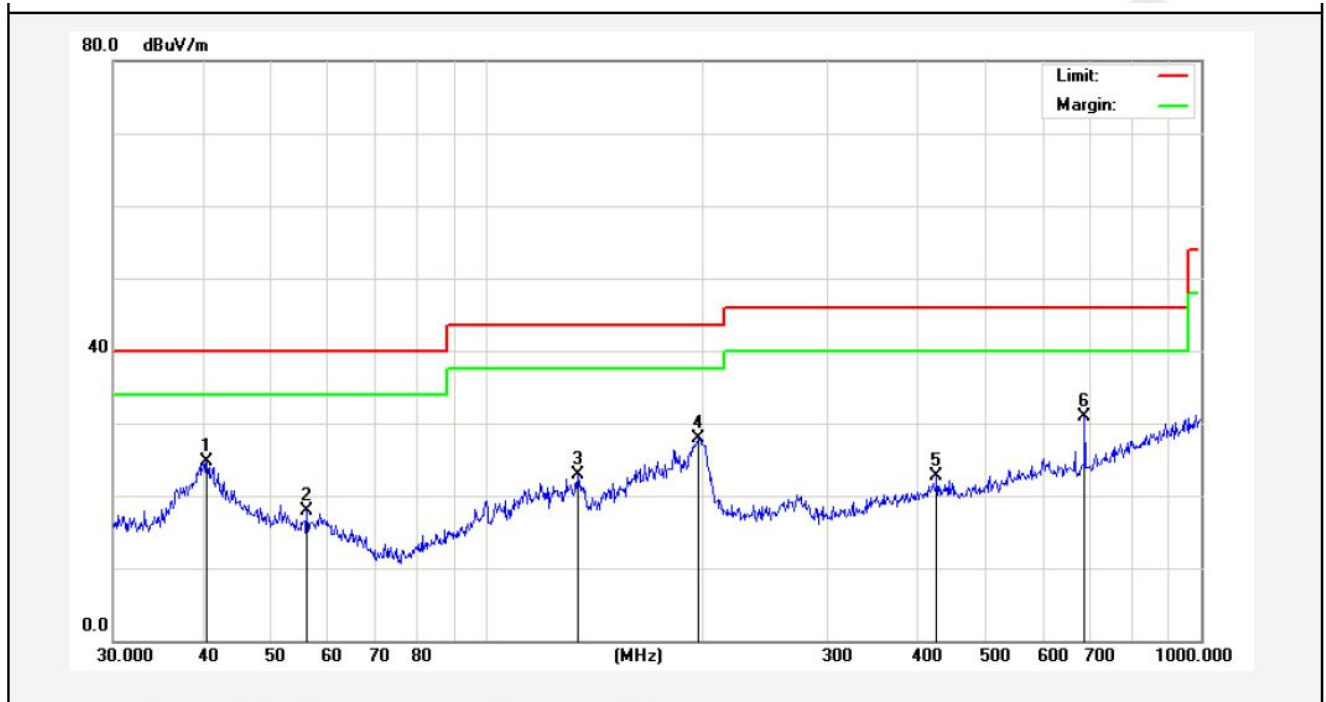

No.	Freq. (MHz)	Reading (dBuV/m)	Factor (dB/m)	Result (dBuV/m)	Limit (dBuV/)	Over Limit (dB)	Detector	Height (cm)	degree (deg)	Remark
1	40.5591	35.28	-10.58	24.70	40.00	-15.30	peak			
2	56.0007	32.89	-15.03	17.86	40.00	-22.14	peak			
3	134.0882	41.00	-18.09	22.91	43.50	-20.59	peak			
4	197.8928	43.81	-15.88	27.93	43.50	-15.57	peak			
5	426.5210	33.96	-11.25	22.71	46.00	-23.29	peak			
6	687.1507	39.51	-8.58	30.93	46.00	-15.07	peak			

Above 1 GHz:

Horizontal
CH Low (2405MHz)

Frequency MHz	Cable Loss dB	Ant Factor dB/m	Preamp Factor dB	Read Level dBμV	Level dBμV/m	Limit dBμV/m	Over Limit dB	Remark
2405.000	2.17	31.21	35.30	87.48	85.56	114.0	-28.44	Peak
2405.000	2.17	31.21	35.30	77.58	75.66	94.0	-18.34	AV
4810.380	2.56	34.01	34.71	46.25	48.11	74.0	-25.89	Peak
4810.380	2.56	34.01	34.71	35.27	37.13	54.0	-16.87	AV
7215.630	2.98	36.16	35.15	43.93	47.92	74.0	-26.08	Peak
7215.630	2.98	36.16	35.15	34.61	38.60	54.0	-15.40	AV
9620.000	---	---	---	---	---	---	---	---
12025.00	---	---	---	---	---	---	---	---
14430.00	---	---	---	---	---	---	---	---
16835.00	---	---	---	---	---	---	---	---
---		.						

Vertical
CH Low (2405MHz)

Frequency MHz	Cable Loss dB	Ant Factor dB/m	Preamp Factor dB	Read Level dBμV	Level dBμV/m	Limit dBμV/m	Over Limit dB	Remark
2405.000	2.17	31.21	35.30	86.25	84.33	114.0	-29.67	Peak
2405.000	2.17	31.21	35.30	80.01	78.09	94.0	-15.91	AV
4810.440	2.56	34.01	34.71	47.89	49.75	74.0	-24.25	Peak
4810.440	2.56	34.01	34.71	37.36	39.22	54.0	-14.78	AV
7215.570	2.98	36.16	35.15	42.15	46.14	74.0	-27.86	Peak
7215.570	2.98	36.16	35.15	33.21	37.20	54.0	-16.80	AV
9620.000	---	---	---	---	---	---	---	---
12025.00	---	---	---	---	---	---	---	---
14430.00	---	---	---	---	---	---	---	---
16835.00	---	---	---	---	---	---	---	---

Horizontal
CH Middle (2448MHz)

Frequency MHz	Cable Loss dB	Ant Factor dB/m	Preamp Factor dB	Read Level dBμV	Level dBμV/m	Limit dBμV/m	Over Limit dB	Remark
2448.000	2.19	31.22	34.60	88.52	87.33	114.0	-26.67	Peak
2448.000	2.19	31.22	34.60	79.95	78.76	94.0	-15.24	AV
4896.320	2.57	35.00	34.58	42.36	45.35	74.0	-28.65	Peak
4896.320	2.57	35.00	34.58	35.84	38.83	54.0	-15.17	AV
7344.750	3.00	36.17	35.14	42.58	46.61	74.0	-27.39	Peak
7344.750	3.00	36.17	35.14	35.20	39.23	54.0	-14.77	AV
9792.000	---	---	---	---	---	---	---	---
12240.00	---	---	---	---	---	---	---	---
14688.00	---	---	---	---	---	---	---	---
17136.00	---	---	---	---	---	---	---	---
---	---	---	---	---	---	---	---	---

Vertical
CH Middle (2448MHz)

Frequency MHz	Cable Loss dB	Ant Factor dB/m	Preamp Factor dB	Read Level dBμV	Level dBμV/m	Limit dBμV/m	Over Limit dB	Remark
2448.000	2.19	31.22	34.60	90.25	89.06	114.0	-24.94	Peak
2448.000	2.19	31.22	34.60	81.56	80.37	94.0	-13.63	AV
4896.170	2.57	35.00	34.58	43.22	46.21	74.0	-27.79	Peak
4896.170	2.57	35.00	34.58	39.89	42.88	54.0	-11.12	AV
7344.430	3.00	36.17	35.14	44.75	48.78	74.0	-25.22	Peak
7344.430	3.00	36.17	35.14	36.29	40.32	54.0	-13.68	AV
9792.000	---	---	---	---	---	---	---	---
12240.00	---	---	---	---	---	---	---	---
14688.00	---	---	---	---	---	---	---	---
17136.00	---	---	---	---	---	---	---	---
---	---	---	---	---	---	---	---	---

Horizontal
CH High (2472MHz)

Frequency MHz	Cable Loss dB	Ant Factor dB/m	Preamp Factor dB	Read Level dBμV	Level dBμV/m	Limit dBμV/m	Over Limit dB	Remark
2472.000	2.20	31.65	36.00	91.25	89.10	114.0	-24.90	Peak
2472.000	2.20	31.65	36.00	83.36	81.21	94.0	-12.79	AV
4944.230	2.58	35.06	34.79	45.91	48.76	74.0	-25.24	Peak
4944.230	2.58	35.06	34.79	37.52	40.37	54.0	-13.63	AV
7416.830	3.02	36.19	34.90	47.13	51.44	74.0	-22.56	Peak
7416.830	3.02	36.20	35.20	39.44	43.46	54.0	-10.54	AV
9768.000	---	---	---	---	---	---	---	---
12210.00	---	---	---	---	---	---	---	---
14652.00	---	---	---	---	---	---	---	---
17304.00	---	---	---	---	---	---	---	---
---	---	---	---	---	---	---	---	---

Vertical
CH High (2472MHz)

Frequency MHz	Cable Loss dB	Ant Factor dB/m	Preamp Factor dB	Read Level dBμV	Level dBμV/m	Limit dBμV/m	Over Limit dB	Remark
2472.000	2.20	31.65	36.00	94.12	91.97	114.0	-22.03	Peak
2472.000	2.20	31.65	36.00	84.69	82.54	94.0	-11.46	AV
4944.380	2.58	35.06	34.79	47.21	50.06	74.0	-23.94	Peak
4944.380	2.58	35.06	34.79	37.45	40.30	54.0	-13.70	AV
7416.860	3.02	36.19	34.90	45.37	49.68	74.0	-24.32	Peak
7416.860	3.02	36.20	35.20	38.97	42.99	54.0	-11.01	AV
9768.000	---	---	---	---	---	---	---	---
12210.00	---	---	---	---	---	---	---	---
14652.00	---	---	---	---	---	---	---	---
17304.00	---	---	---	---	---	---	---	---
---	---	---	---	---	---	---	---	---

NOTE: “ --- ” in the table above means the reading of emissions are attenuated more than 20dB below the permissible limits or the field strength is too small to be measured. The results of different modulations are the same.

4. Bandedge

4.1. Requirements (15.249):

The field strength of any emissions appearing outside the band edges and up to 10 kHz above and below the band edges shall be attenuated at least 50 dB below the level of the carrier or to the general limits of 15.249.

4.2. Test Procedure

The EUT is placed on a turn table which is 1.5 meter high above the ground. The turn table can rotate 360 degrees to determine the position of the maximum emission level. The EUT is set 3 meters away from the receiving antenna which is mounted on a antenna tower. The antenna can be moved up and down from 1 to 4 meters to find out the maximum emission level. Both horizontal and vertical polarization of the antenna are set on test. The device is evaluated in xyz orientation.

Test Equipment

Item	Equipment	Manufacturer	Model No.	Serial No.	Last Cal.	Cal. Interval
1.	Spectrum Analysis	Agilent	E4407B	US39390582	Apr. 17, 2015	1 Year
2.	Preamplifier	Instruments corporation	EMC011830	980100	Apr. 17, 2015	1 Year
3.	EMI Test Receiver	Rohde & Schwarz	ESPI	101604	Apr. 17, 2015	1 Year
4.	Double Ridged Horn Antenna	Instruments corporation	GTH-0118	351600	Apr. 20, 2015	1 Year
5.	Bilog Broadband Antenna	Schwarzbeck	VULB9163	VULB 9163-289	Apr. 20, 2015	1 Year
6.	Pre-amplifier	SONOMA	310N	186860	Apr. 17, 2015	1 Year
7.	EMI Test Software EZ-EMC	SHURPLE	N/A	N/A	N/A	N/A

4.3. Test Configuration:

30M to 1G emissions:

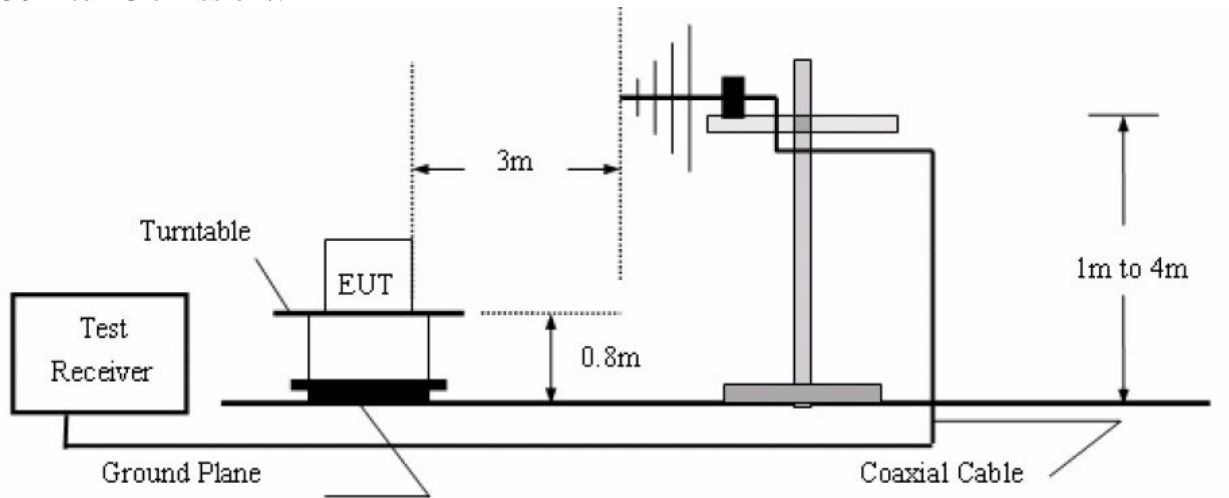

1G to 40G emissions:

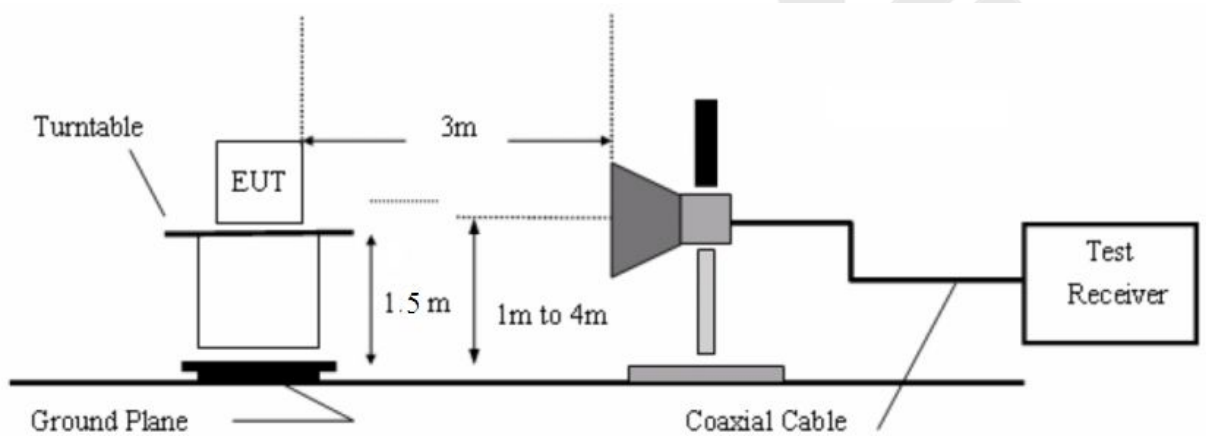

4.4. Test Results

Pass.

Please refer the following plot. Only the worst case (x orientation).

Job No.:	011507849I	Polarization:	Horizontal
Standard:	(RE)FCC PART15 C_3m	Power Source:	DC 1.5V
Test item:	Radiation Test	Temp.(C)/Hum.(%RH):	24.3(C)/55%RH
Note:	PEAK	Distance:	3m

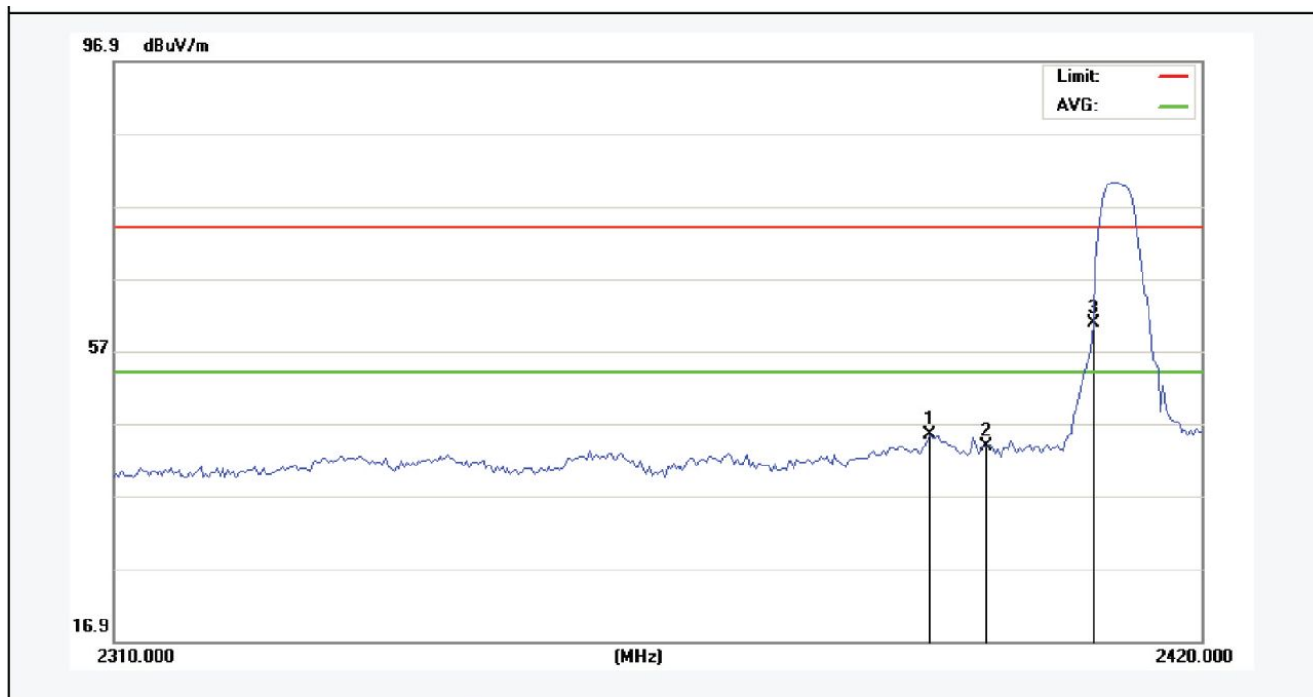

No.	Freq. (MHz)	Reading (dBuV/m)	Factor (dB/m)	Result (dBuV/m)	Limit (dBuV/)	Over Limit (dB)	Detector	Height (cm)	degree (deg)	Remark
1	2384.750	47.89	-2.53	45.36	74.00	-28.64	peak			
2	2390.000	46.38	-2.51	43.87	74.00	-30.13	peak			
3	2400.000	63.24	-2.49	60.75	74.00	-13.25	peak			

Job No.:	011507849I	Polarization:	Vertical
Standard:	(RE)FCC PART15 C _3m	Power Source:	DC 1.5V
Test item:	Radiation Test	Temp.(C)/Hum.(%RH):	24.3(C)/55%RH
Note:	PEAK	Distance:	3m

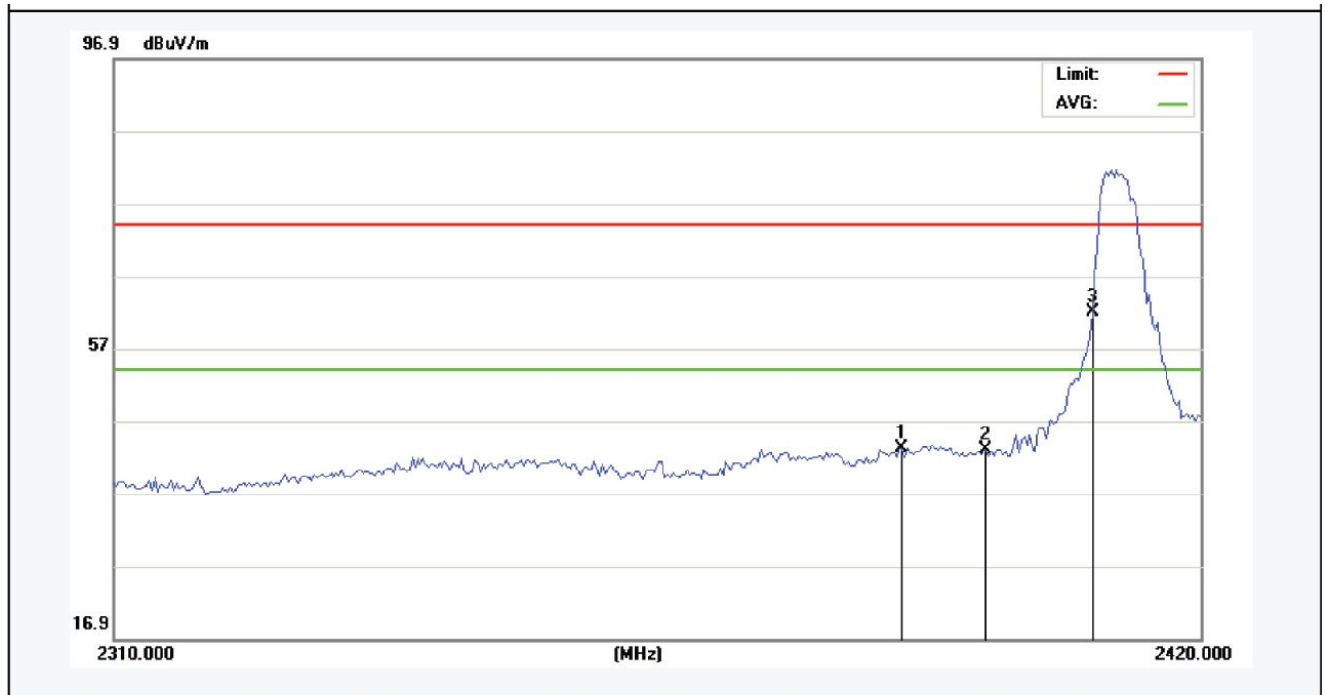

No.	Freq. (MHz)	Reading (dBuV/m)	Factor (dB/m)	Result (dBuV/m)	Limit (dBuV/)	Over Limit (dB)	Detector	Height (cm)	degree (deg)	Remark
1	2382.250	45.65	-2.53	43.12	74.00	-30.88	peak			
2	2390.000	45.42	-2.51	42.91	74.00	-31.09	peak			
3	2400.000	64.42	-2.49	61.93	74.00	-12.07	peak			



Job No.:	011507849I	Polarization:	Horizontal
Standard:	(RE)FCC PART15 C _3m	Power Source:	DC 1.5V
Test item:	Radiation Test	Temp.(C)/Hum.(%RH):	24.3(C)/55%RH
Note:	AV	Distance:	3m

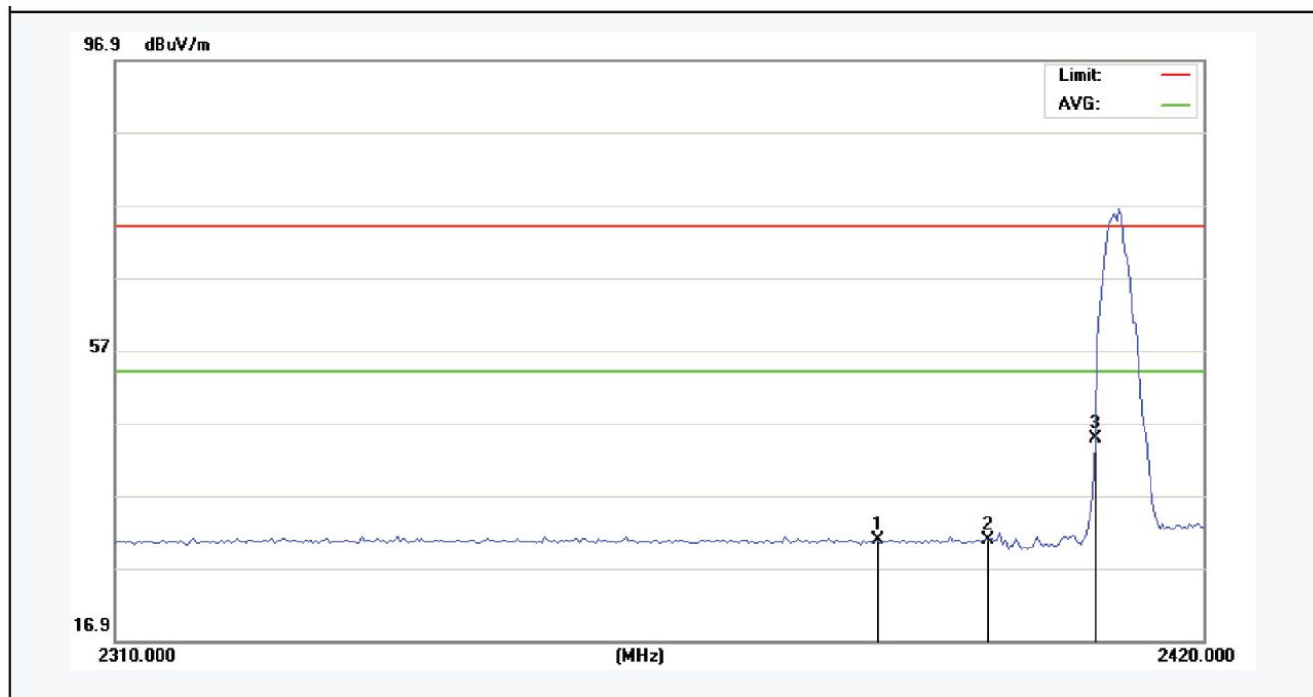

No.	Freq. (MHz)	Reading (dBuV/m)	Factor (dB/m)	Result (dBuV/m)	Limit (dBuV/)	Over Limit (dB)	Detector	Height (cm)	degree (deg)	Remark
1	2379.750	33.35	-2.54	30.81	54.00	-23.19	AVG			
2	2390.000	33.23	-2.51	30.72	54.00	-23.28	AVG			
3	2400.000	47.25	-2.49	44.76	54.00	-9.24	AVG			



Job No.:	011507849I	Polarization:	Vertical
Standard:	(RE)FCC PART15 C_3m	Power Source:	DC 1.5V
Test item:	Radiation Test	Temp.(C)/Hum.(%RH):	24.3(C)/55%RH
Note:	AV	Distance:	3m

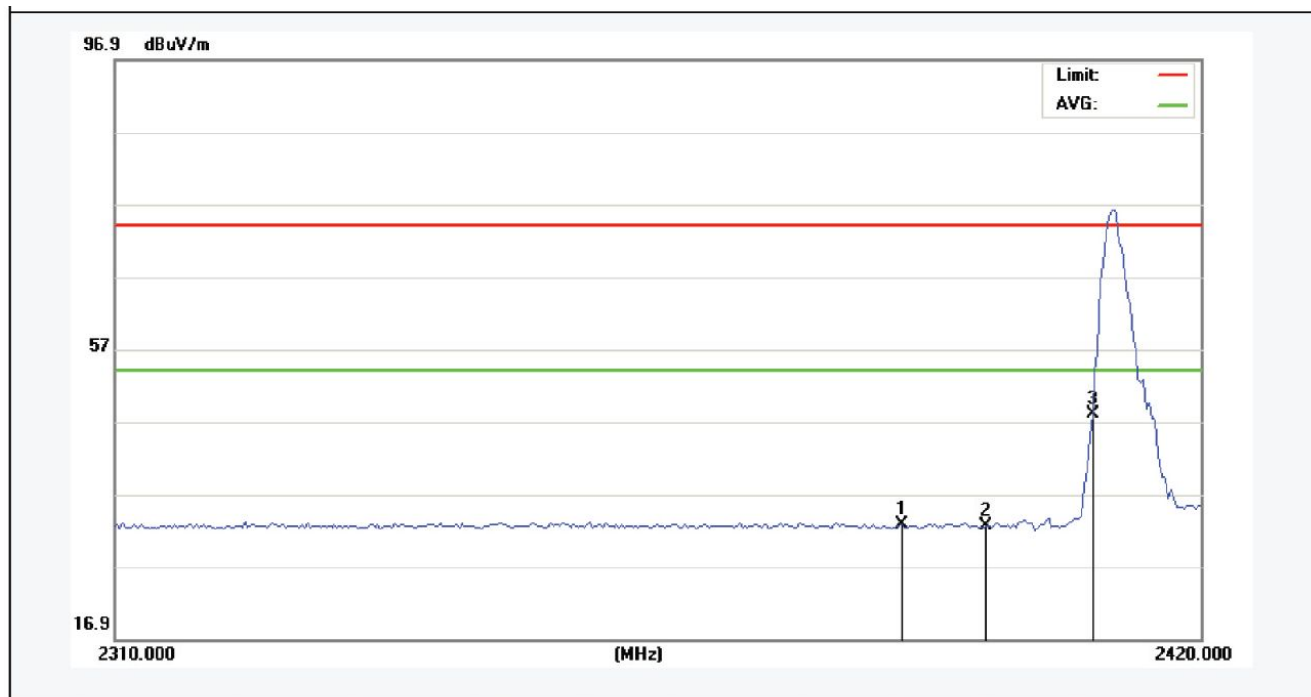

No.	Freq. (MHz)	Reading (dBuV/m)	Factor (dB/m)	Result (dBuV/m)	Limit (dBuV/)	Over Limit (dB)	Detector	Height (cm)	degree (deg)	Remark
1	2382.250	35.33	-2.53	32.80	54.00	-21.20	AVG			
2	2390.000	35.04	-2.51	32.53	54.00	-21.47	AVG			
3	2400.000	50.40	-2.49	47.91	54.00	-6.09	AVG			



Job No.:	011507849I	Polarization:	Horizontal
Standard:	(RE)FCC PART15 C_3m	Power Source:	DC 1.5V
Test item:	Radiation Test	Temp.(C)/Hum.(%RH):	24.3(C)/55%RH
Note:	PEAK	Distance:	3m

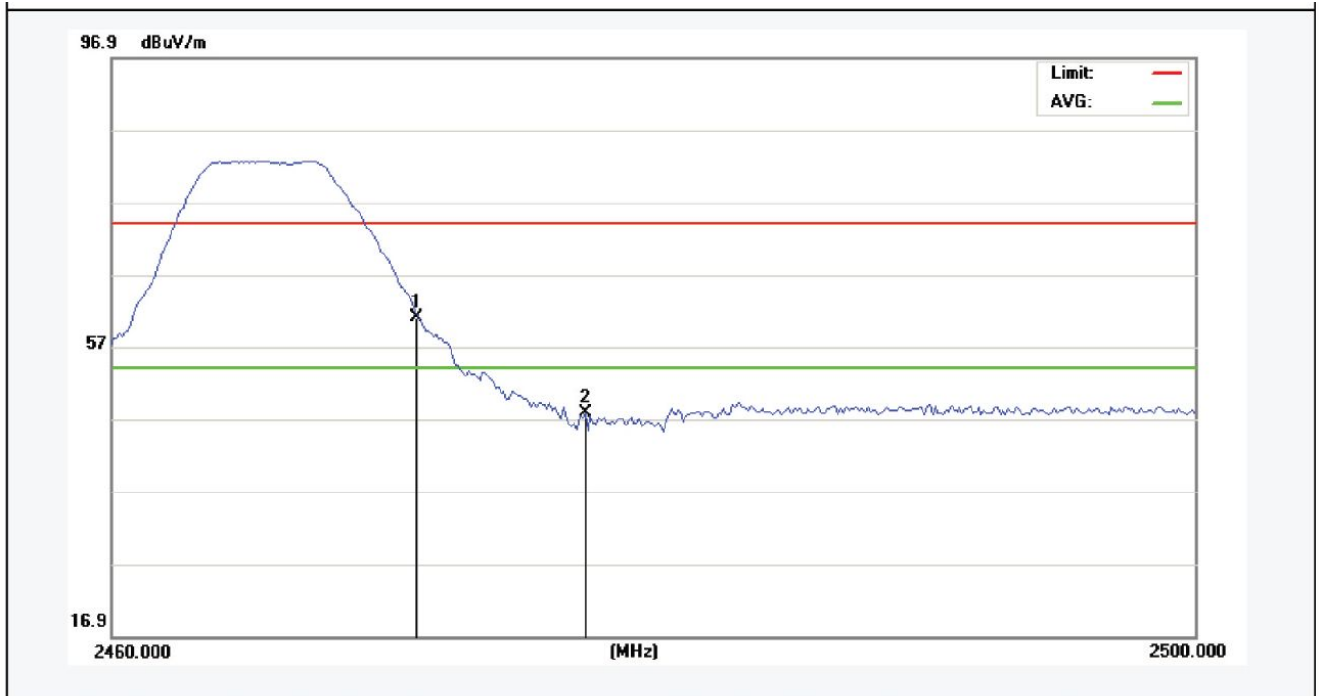

No.	Freq. (MHz)	Reading (dBuV/m)	Factor (dB/m)	Result (dBuV/m)	Limit (dBuV/)	Over Limit (dB)	Detector	Height (cm)	degree (deg)	Remark
1	2483.500	63.37	-2.31	61.06	74.00	-12.94	peak			
2	2487.063	50.01	-2.30	47.71	74.00	-26.29	peak			

A M

Job No.:	011507849I	Polarization:	Vertical
Standard:	(RE)FCC PART15 C _3m	Power Source:	DC 1.5V
Test item:	Radiation Test	Temp.(C)/Hum.(%RH):	24.3(C)/55%RH
Note:	PEAK	Distance:	3m

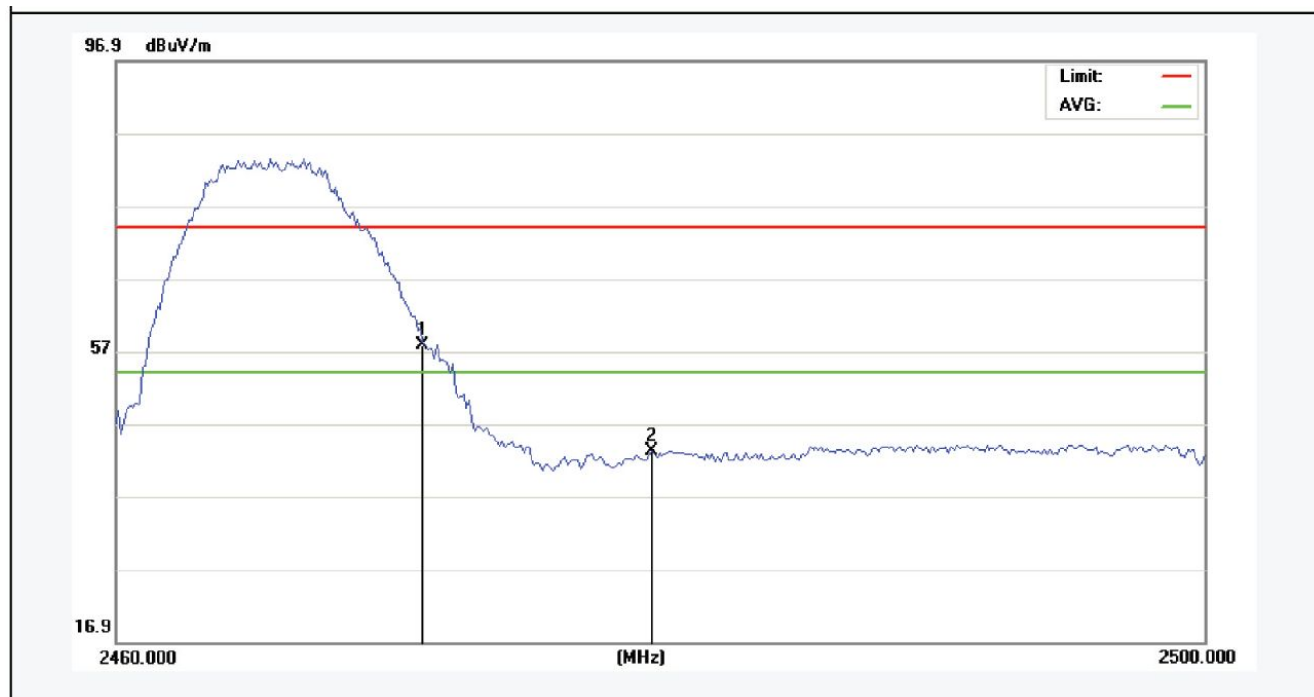

No.	Freq. (MHz)	Reading (dBuV/m)	Factor (dB/m)	Result (dBuV/m)	Limit (dBuV/)	Over Limit (dB)	Detector	Height (cm)	degree (deg)	Remark
1	2483.500	60.17	-2.31	57.86	74.00	-16.14	peak			
2	2488.327	45.52	-2.30	43.22	74.00	-30.78	peak			

A M

Job No.:	011507849I	Polarization:	Horizontal
Standard:	(RE)FCC PART15 C _3m	Power Source:	DC 1.5V
Test item:	Radiation Test	Temp.(C)/Hum.(%RH):	24.3(C)/55%RH
Note:	AV	Distance:	3m

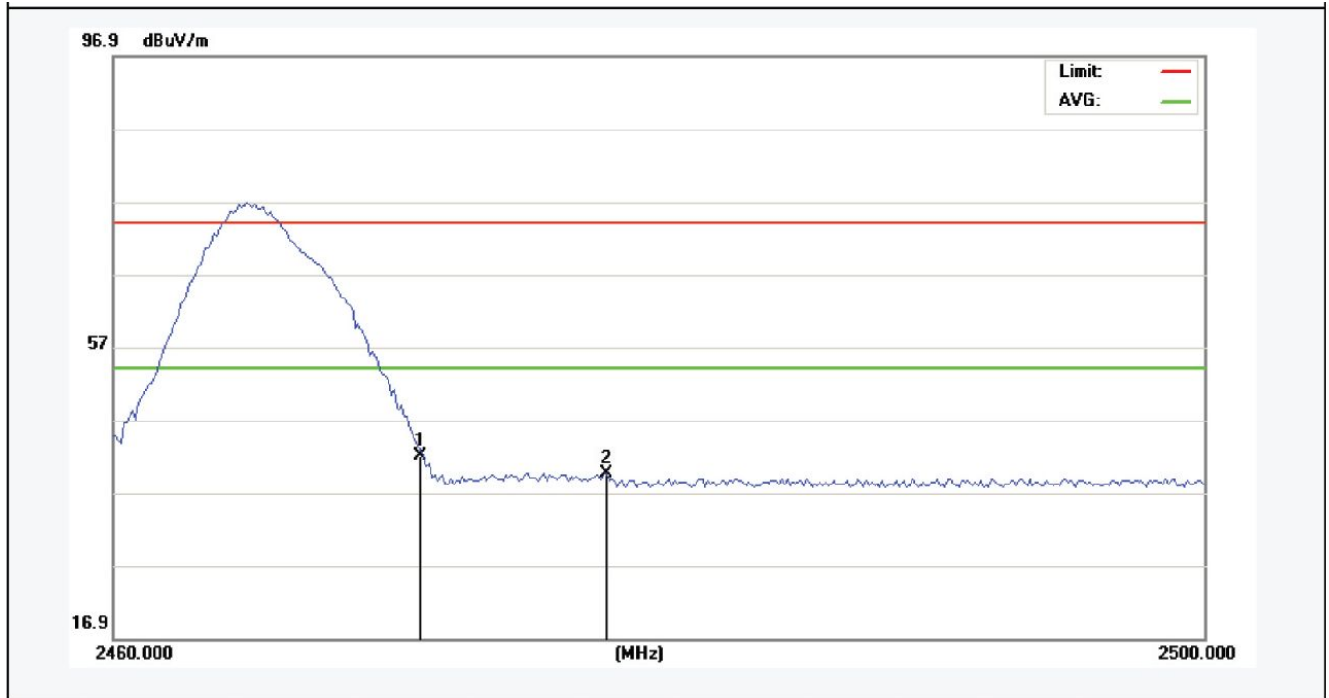

No.	Freq. (MHz)	Reading (dBuV/m)	Factor (dB/m)	Result (dBuV/m)	Limit (dBuV/)	Over Limit (dB)	Detector	Height (cm)	degree (deg)	Remark
1	2483.500	44.30	-2.31	41.99	54.00	-12.01	AVG			
2	2487.407	41.88	-2.30	39.58	54.00	-14.42	AVG			

Job No.:	011507849I	Polarization:	Vertical
Standard:	(RE)FCC PART15 C _3m	Power Source:	DC 1.5V
Test item:	Radiation Test	Temp.(C)/Hum.(%RH):	24.3(C)/55%RH
Note:	AV	Distance:	3m

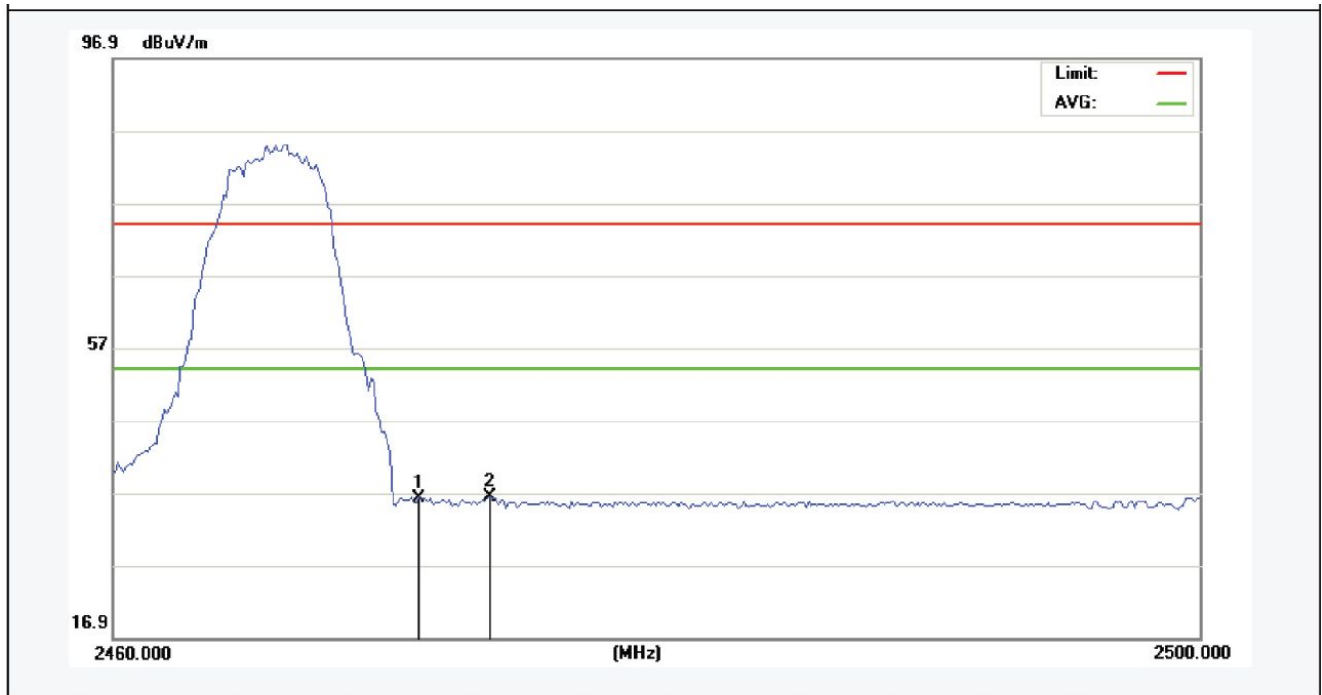

No.	Freq. (MHz)	Reading (dBuV/m)	Factor (dB/m)	Result (dBuV/m)	Limit (dBuV/)	Over Limit (dB)	Detector	Height (cm)	degree (deg)	Remark
1	2483.500	38.56	-2.31	36.25	54.00	-17.75	AVG			
2	2484.992	38.63	-2.30	36.33	54.00	-17.67	AVG			



5. Occupied Bandwidth

5.1. Requirements :

According to 15.215 (c), intentional radiators operating under the alternative provisions to the general emission limits, as contained in §§15.217 through 15.257 and in Subpart E of this part, must be designed to ensure that the 20 dB bandwidth of the emission, or whatever bandwidth may otherwise be specified in the specific rule section under which the equipment operates, is contained within the frequency band designated in the rule section under which the equipment is operated. The requirement to contain the designated bandwidth of the emission within the specified frequency band includes the effects from frequency sweeping, frequency hopping and other modulation techniques that may be employed as well as the frequency stability of the transmitter over expected variations in temperature and supply voltage. If a frequency stability is not specified in the regulations, it is recommended that the fundamental emission be kept within at least the central 80% of the permitted band in order to minimize the possibility of out-of-band operation.

5.2. Test SET-UP

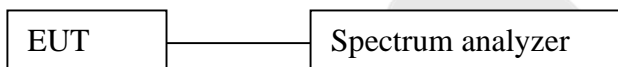

5.3 Test Equipment

Item	Equipment	Manufacturer	Model No.	Serial No.	Last Cal.	Cal. Interval
1.	Spectrum Analysis	Agilent	E4407B	US39390582	Apr. 17, 2015	1 Year
2.	Preamplifier	Instruments corporation	EMC011830	980100	Apr. 17, 2015	1 Year
3.	EMI Test Receiver	Rohde & Schwarz	ESPI	101604	Apr. 17, 2015	1 Year
4.	Double Ridged Horn Antenna	Instruments corporation	GTH-0118	351600	Apr. 20, 2015	1 Year
5.	Bilog Broadband Antenna	Schwarzbeck	VULB9163	VULB 9163-289	Apr. 20, 2015	1 Year
6.	Pre-amplifier	SONOMA	310N	186860	Apr. 17, 2015	1 Year
7.	EMI Test Software EZ-EMC	SHURPLE	N/A	N/A	N/A	N/A

5.4. Test Results

Pass.

Please refer the following plot.

20dB Down:

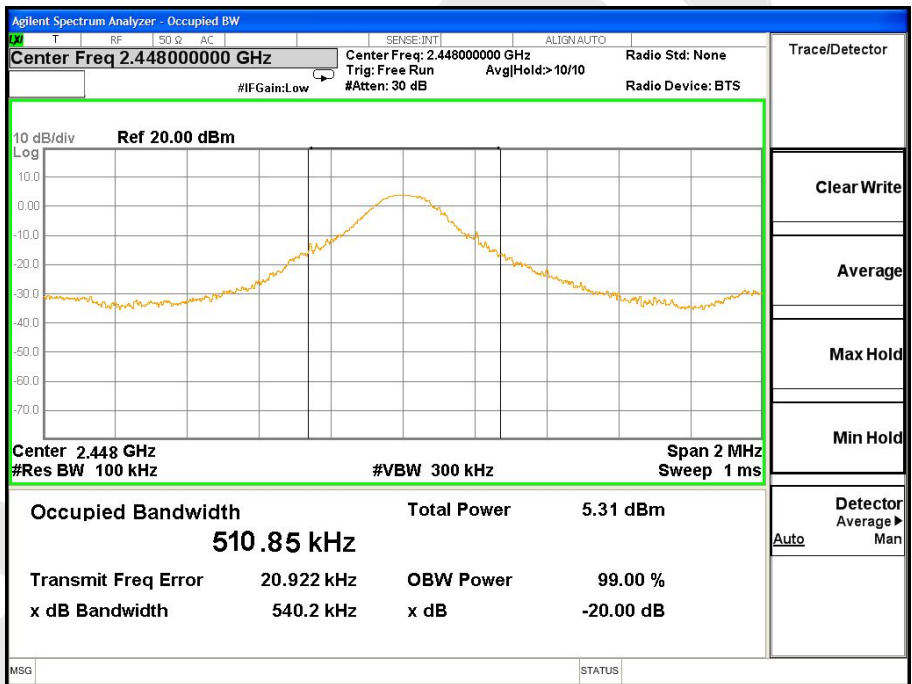
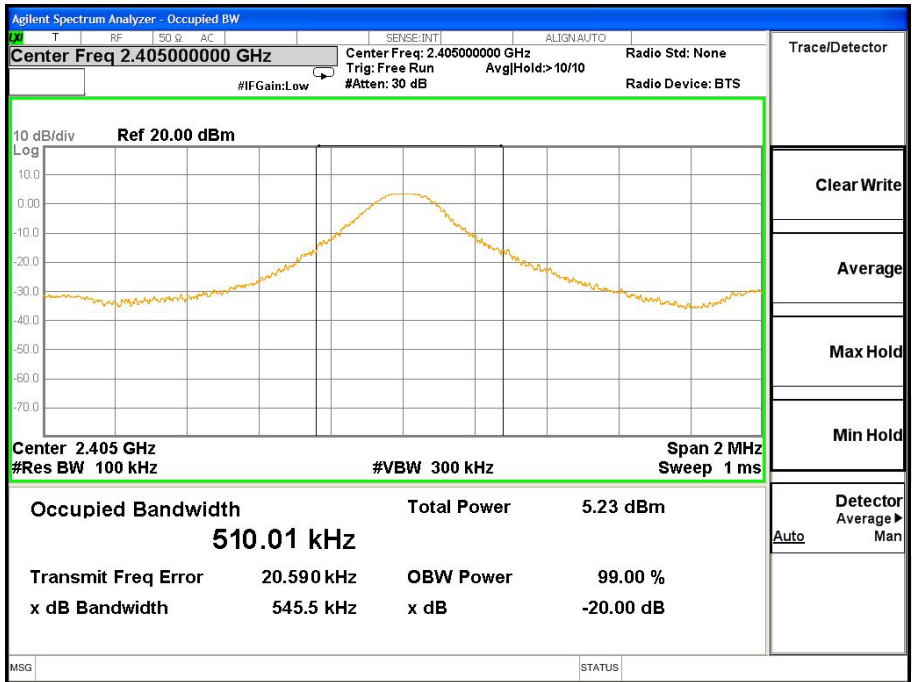

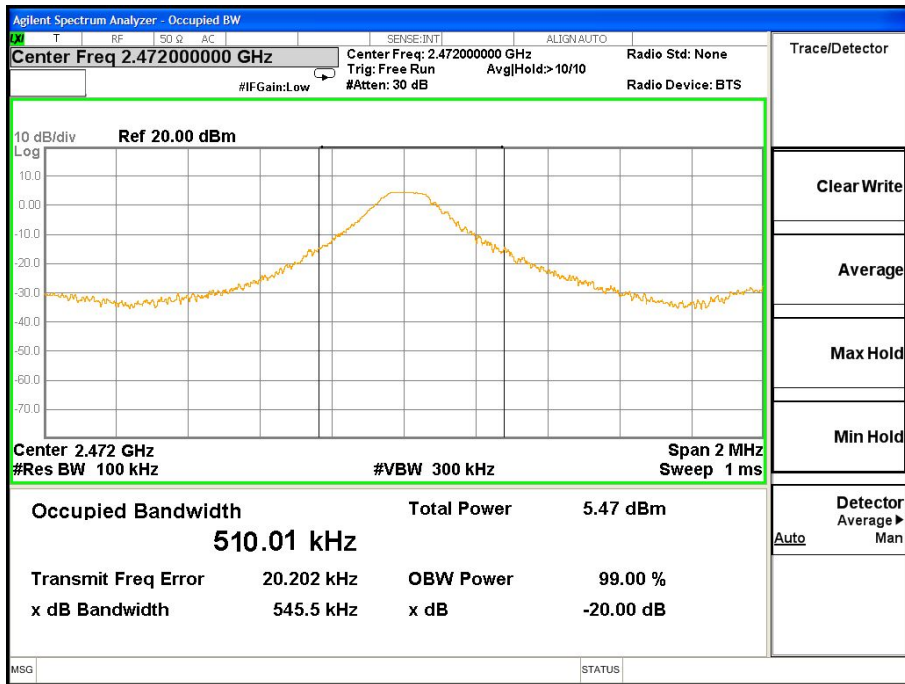

Anbotek

6. ANTENNA APPLICATION

6.1. Antenna requirement

The EUT'S antenna is met the requirement of FCC part 15C section 15.203.

An intentional radiator shall be designed to ensure that no antenna other than that furnished by the responsible party shall be used with the device. The use of a permanently attached antenna or of an antenna that uses a unique coupling to the intentional radiator shall be considered sufficient to comply with the provisions of this section. The manufacturer may design the unit so that a broken antenna can be replaced by the user, but the use of a standard antenna jack or electrical connector is prohibited. This requirement does not apply to carrier current devices or to devices operated under the provisions of §15.211, §15.213, §15.217, §15.219, or §15.221. Further, this requirement does not apply to intentional radiators that must be professionally installed, such as perimeter protection systems and some field disturbance sensors, or to other intentional radiators which, in accordance with §15.31(d), must be measured at the installation site. However, the installer shall be responsible for ensuring that the proper antenna is employed so that the limits in this part are not exceeded.

6.2. Result

The EUT's antenna used a PCB antenna which is permanently attached, The antenna's gain is 1.76dBi and meets the requirement.

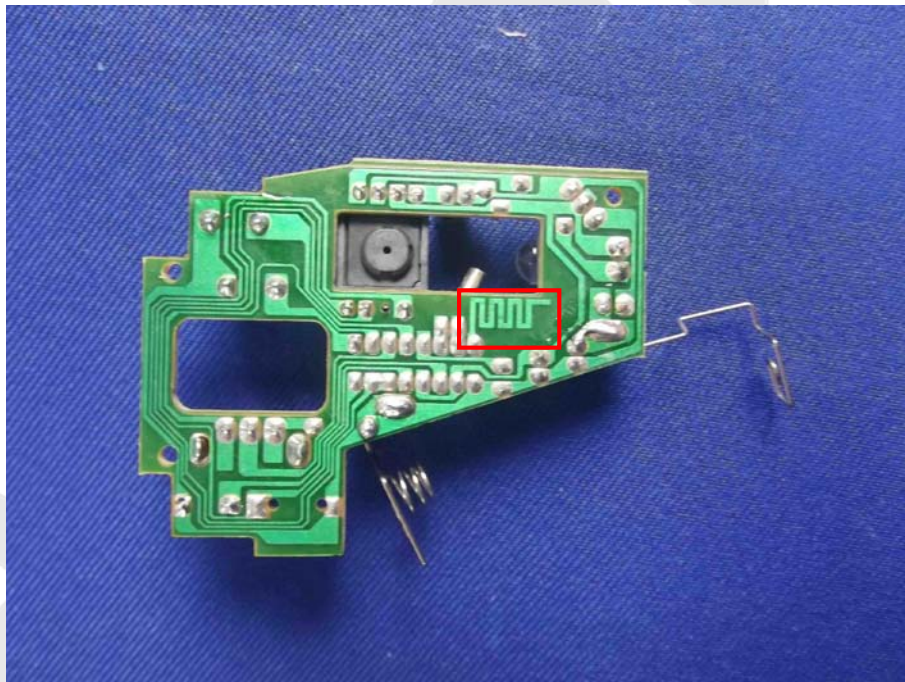

7. PHOTOGRAPH

7.1. Photo of Radiation Emission Test

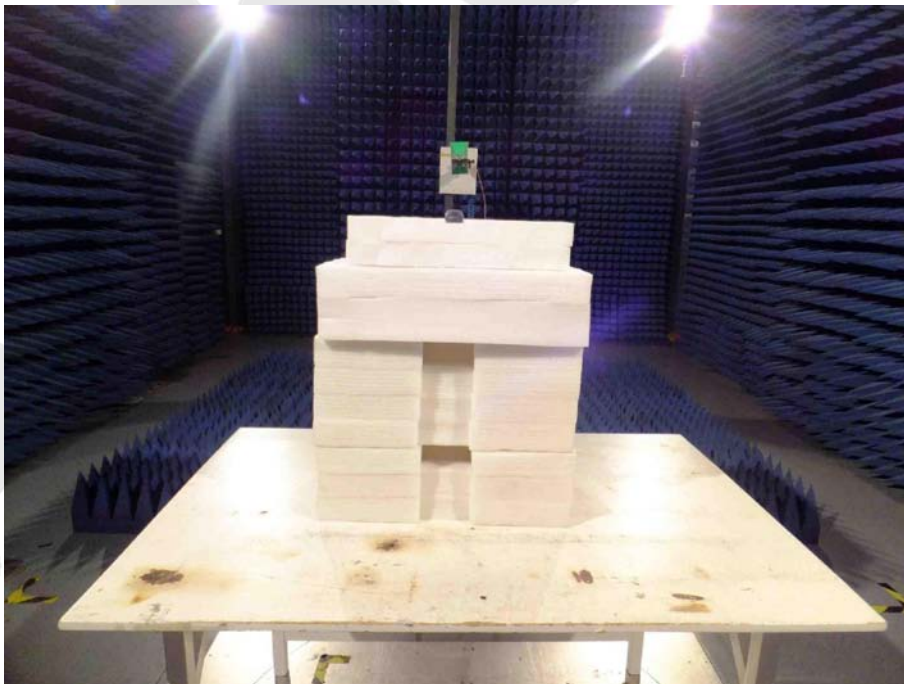
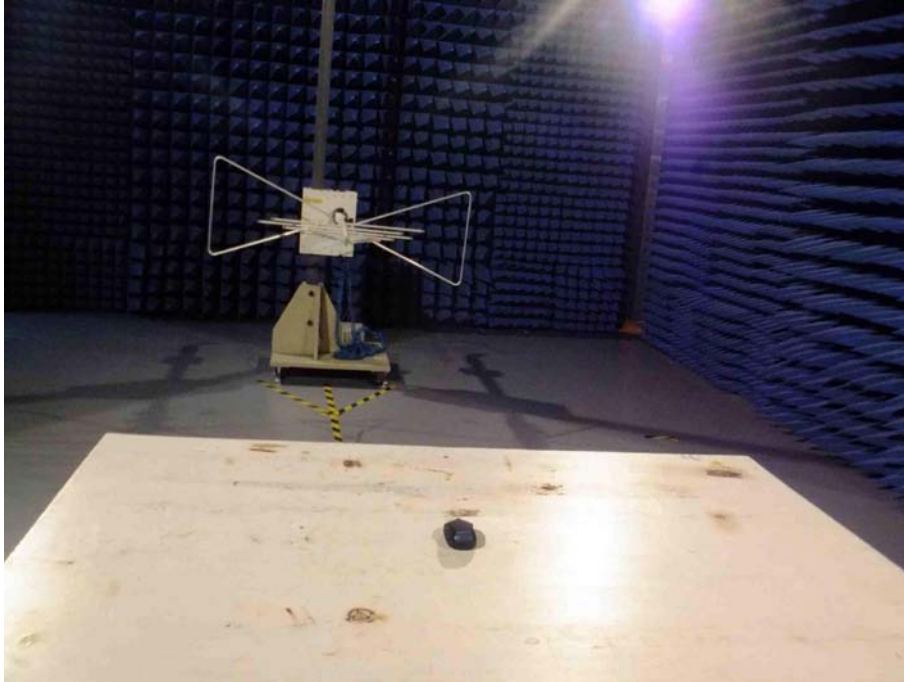

APPENDIX I (External Photos)

Figure 1
The EUT-Series View

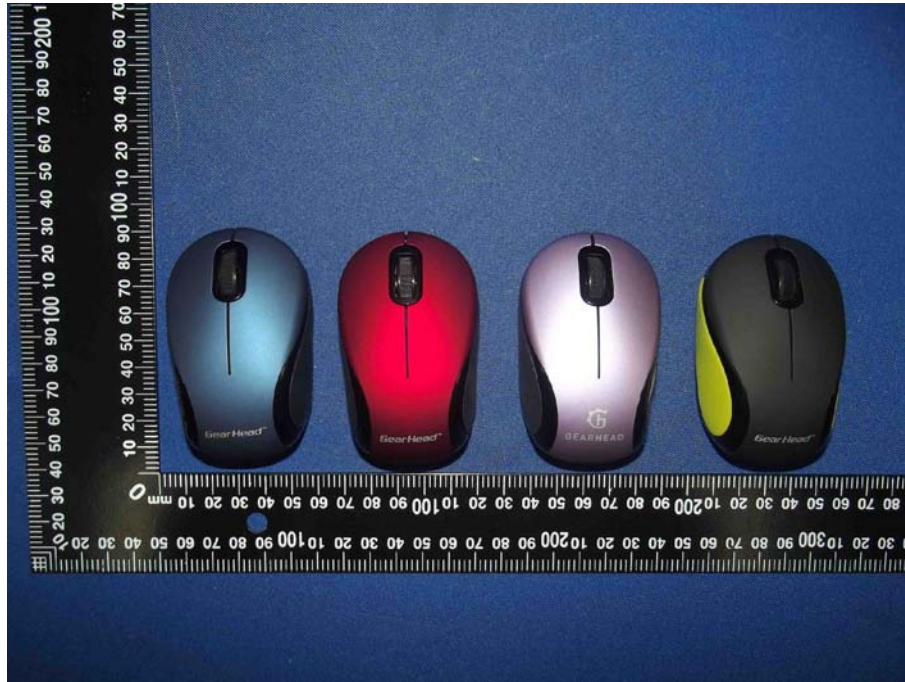

Figure 2
The EUT-Top View

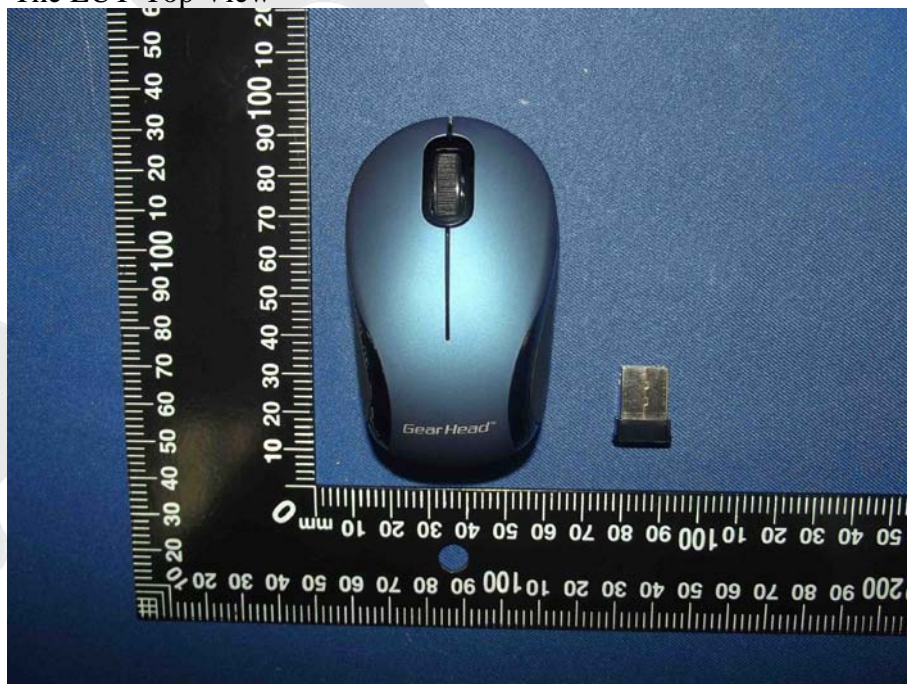

Figure 3
The EUT-Bottom View



Figure 4
The EUT-Front View



Figure 5
The EUT-Back View



Figure 6
The EUT-Right View



Figure 7
The EUT-Left View



APPENDIX II (Internal Photos)

Figure 8
The EUT-Inside View



Figure 9
PCB of the EUT-Front View

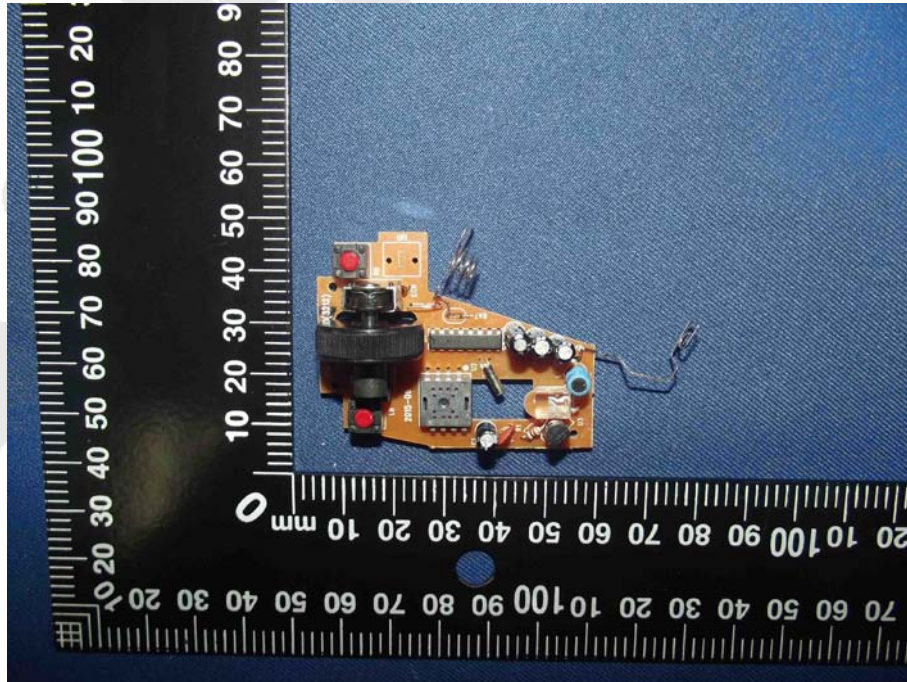

Figure 10
PCB of the EUT-Back View

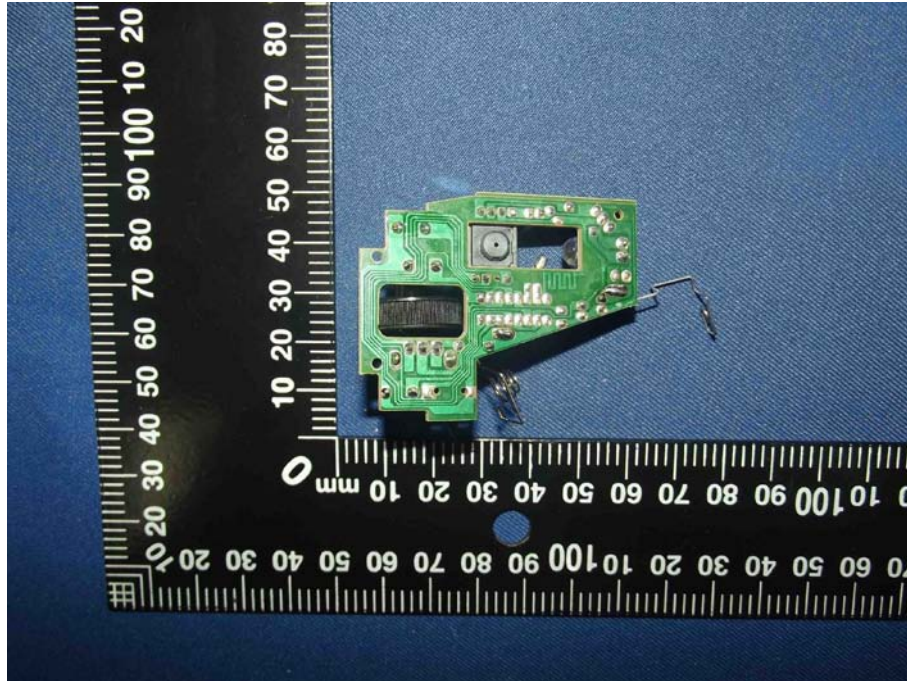

Figure 11
PCB of the EUT-Module View

