

# FCC Report

**Application Purpose** : Original grant  
**Applicant Name:** : WINTOP ELECTRONICS CO., LIMITED  
**FCC ID** : 2AB75-GM-769  
**Equipment Type** : Rechargeable Dual Mode Wired&Wireless Gaming mouse  
**Model Name** : GM-769  
**Report Number** : FCC16063755-1  
**Standard(S)** : FCC Part 15 Subpart C Section 15.249  
**Date Of Receipt** : June 24, 2016  
**Date Of Issue** : July 8, 2016

**Test By** : Fall Ma  
(Fall Ma)

**Reviewed By** : Robie Chen  
Robie Chen)

**Authorized by** : Michal Ling  
(Michal Ling)

**Prepared by** : **Shenzhen WST Testing Technology Co., Ltd.**  
1F, No.9 Building, TGK Science & Technology Park Yangtian Rd., NO.72 Bao'an Dist., GuangDong, China

**REPORT REVISE RECORD**

<b>Report Version</b>	<b>Revise Time</b>	<b>Issued Date</b>	<b>Valid Version</b>	<b>Notes</b>
V1.0	/	July 8, 2016	Valid	Original Report
V1.1	/	July 15, 2016	Valid	Original Report

Table of Contents	Page
<b>1. GENERAL INFORMATION .....</b>	<b>5</b>
<b>2. TEST DESCRIPTION .....</b>	<b>7</b>
2.1 MEASUREMENT UNCERTAINTY .....	7
2.2 DESCRIPTION OF TEST MODES .....	8
2.3 CONFIGURATION OF SYSTEM UNDER TEST .....	9
2.4 DESCRIPTION OF SUPPORT UNITS .....	9
<b>3. SUMMARY OF TEST RESULTS .....</b>	<b>10</b>
<b>4. MEASUREMENT INSTRUMENTS .....</b>	<b>11</b>
<b>5. ANTENNA REQUIREMENTS .....</b>	<b>12</b>
5.1 STANDARD APPLICABLE .....	12
5.2 TEST RESULT .....	12
<b>6. CONDUCTED EMISSIONS MEASUREMENT .....</b>	<b>13</b>
6.1 POWER LINE CONDUCTED EMISSION LIMITS .....	13
6.2 TEST PROCEDURE .....	14
6.3 TEST SETUP .....	14
6.4 ENVIRONMENTAL CONDITIONS .....	14
6.5 TEST RESULTS .....	14
<b>7. RADIATED EMISSION MEASUREMENT .....</b>	<b>15</b>
7.1 RADIATED EMISSION LIMITS .....	15
7.2 TEST EQUIPMENT SETUP .....	16
7.3 TEST PROCEDURE .....	16
7.4 TEST SETUP .....	17
7.5 ENVIRONMENTAL CONDITIONS .....	18
7.6 TEST RESULTS .....	19
<b>8. 20DB OCCUPIED BANDWIDTH .....</b>	<b>25</b>
8.1 STANDARD APPLICABLE .....	25
8.2 TEST PROCEDURE .....	25
8.3 TEST SETUP .....	25
8.4 ENVIRONMENTAL CONDITIONS .....	25
8.5 TEST RESULTS .....	26

**Table of Contents**

**Page**

**9. PHOTOGRAPHS OF TEST SETUP.....28**  
**10. PHOTOGRAPHS OF EUT .....30**

## 1. GENERAL INFORMATION

### GENERAL DESCRIPTION OF EUT

Equipment Type	Rechargeable Dual Mode Wired&Wireless Gaming mouse
Test Model	GM-769
Brand Name	N/A
Applicant	WINTOP ELECTRONICS CO., LIMITED
Address	Unit 04 7/F, Bright Way Tower 33, Mong Kok RDKL, HONGKONG
Manufacturer	Shenzhen Wintop Electronics Co., Limited
Address	HuaGuan Industrial Park, Xinhe Road, Baolai Industrial District, Shangmugu, Pinghu Town, Longgang District, Shenzhen City, 518000, China
Hardware version:	GM-769-MA438E-5+MA6599E-6
Software version:	GM769-MosArt-2.4g+Wired V1.0 2015-11-26
Operating Voltage	3.7V 300mA 1.11WH
Operating Frequency	2407-2477MHz
Channels	71
Channel Spacing	1MHz
Modulation Type	FSK
Antenna Type:	PCB Antenna
Antenna gain:	5dBi
Data of receipt	24-June-2016
Date of test	25-June-2016 to 06-July-2016
Deviation	None
Condition of Test Sample	Normal

**We hereby certify that:**

The above equipment was tested by Shenzhen WST Testing Technology Co., Ltd.

Registration Number: 939433

The data evaluation, test procedures, and equipment configurations shown in this report were made in accordance with the procedures given in ANSI C 63.4:2014. The sample tested as described in this report is in compliance with the FCC Rules Part15 Subpart C.

The test results of this report relate only to the tested sample identified in this report.

## 2. TEST DESCRIPTION

### 2.1 MEASUREMENT UNCERTAINTY

The reported uncertainty of measurement  $y \pm U$ , where expanded uncertainty  $U$  is based on a standard uncertainty multiplied by a coverage factor of  $k=2$ , providing a level of confidence of approximately 95%.

No.	Item	Uncertainty
1	Conducted Emission Test	$\pm 3.2\text{dB}$
2	RF power, conducted	$\pm 0.16\text{dB}$
3	Spurious emissions, conducted	$\pm 0.21\text{dB}$
4	All emissions, radiated(<1G)	$\pm 4.7\text{dB}$
5	All emissions, radiated(>1G)	$\pm 4.7\text{dB}$
6	Temperature	$\pm 0.5^\circ\text{C}$
7	Humidity	$\pm 2\%$

## 2.2 DESCRIPTION OF TEST MODES

The system was configured for testing in engineering mode, which was provided by the manufacturer. The engineering mode was configured under maximum power output and switched the channels by keys.

71 channels were provided by the manufacturer.

Channel List							
Channel	Frequency (MHz)	Channel	Frequency (MHz)	Channel	Frequency (MHz)	Channel	Frequency (MHz)
00	2407	18	2425	36	2443	54	2461
01	2408	19	2426	37	2444	55	2462
02	2409	20	2427	38	2445	56	2463
03	2410	21	2428	39	2446	57	2464
04	2411	22	2429	40	2447	58	2465
05	2412	23	2430	41	2448	59	2466
06	2413	24	2431	42	2449	60	2467
07	2414	25	2432	43	2450	61	2468
08	2415	26	2433	44	2451	62	2469
09	2416	27	2434	45	2452	63	2470
10	2417	28	2435	46	2453	64	2471
11	2418	29	2436	47	2454	65	2472
12	2419	30	2437	48	2455	66	2473
13	2420	31	2438	49	2456	67	2474
14	2421	32	2439	50	2457	68	2475
15	2422	33	2440	51	2458	69	2476
16	2423	34	2441	52	2459	70	2477
17	2424	35	2442	53	2460		

Test Mode List		
Test Mode	Description	Remark
TM1	Low Channel	2407MHz
TM2	Middle Channel	2442MHz
TM3	High Channel	2477MHz

**Note:**

- (1) The measurements are performed at the highest, middle, lowest available channels.
- (2) Record the worst case of each test item in this report.



### 2.3 CONFIGURATION OF SYSTEM UNDER TEST

EUT

(EUT: Rechargeable Dual Mode Wired&Wireless Gaming mouse)

### 2.4 DESCRIPTION OF SUPPORT UNITS

The EUT has been tested as an independent unit together with other necessary accessories or support units. The following support units or accessories were used to form a representative test configuration during the tests.

Item	Equipment	Model No.	ID or Specification	Remark
1	/	/	/	/

**Note:**

- (1) *All the equipment/cables were placed in the worst-case configuration to maximize the emission during the test.*
- (2) *Grounding was established in accordance with the manufacturer's requirements and conditions for the intended use.*

### 3. SUMMARY OF TEST RESULTS

Test procedures according to the technical standards:

FCC Part15 (15.249) , Subpart C			
Standard Section	Test Item	Judgment	Remark
§15.203	Antenna Requirement	PASS	
§15.207	Conducted Emission	N/A	
§15.249 (a)	Field Strength of Fundamental	PASS	
§15.249 (a) (d)/ §15.209	Spurious Emissions	PASS	
§15.249 (d)/ §15.205	Band Edge	PASS	
§15.215 (c)	20dB Occupied Bandwidth	PASS	

**Note:**

1. Pass: Test item meets the requirement.
2. Fail: Test item does not meet the requirement.
3. N/A: Test case does not apply to the test object.
4. The test result judgment is decided by the limit of test standard.

**4. MEASUREMENT INSTRUMENTS**

Kind of Equipment	Manufacturer	Type No.	Serial No.	Last Calibrated	Calibrated until
EMI Test Receiver	R&S	ESCI	100005	2015-08-19	2016-08-18
LISN	Mestec	AN3016	04/10040	2015-08-19	2016-08-18
Coaxial cable	Megalon	LMR400	C001	2015-08-19	2016-08-18
System Controller	CT	SC100	011208	2015-08-19	2016-08-18
Bi-log Antenna	SUNOL Sciences	JB3	A021907	2015-09-13	2016-09-12
Spectrum Analyzer	R&S	FSU	100114	2015-08-19	2016-08-18
Horn Antenna	SCHWARZBECK	9120D	1141	2015-08-19	2016-08-18
Loop Antenna	EMCO	6502	00042960	2015-08-19	2016-08-18
Pre Amplifier	H.P.	HP8447E	2945A02715	2015-10-13	2016-10-12
Pre-Amplifier	CDSI	PAP-1G18-38	7621	2015-10-13	2016-10-12
9*6*6 Anechoic	SAEMC	L×W×H 9×6×6	A002	2015-08-21	2016-08-20
RF cable	H+S	SUCOFLEX 102	R002	2015-08-19	2016-08-18
Horn Antenna	SCHWARZBECK	BBHA 9170	1123	2015-08-19	2016-08-18

## **5. ANTENNA REQUIREMENTS**

### **5.1 STANDARD APPLICABLE**

According to FCC Part 15.203, an intentional radiator shall be designed to ensure that no antenna other than that furnished by the responsible party shall be used with the device. The use of a permanently attached antenna or of an antenna that uses a unique coupling to the intentional radiator shall be considered sufficient to comply with the provisions of this section.

### **5.2 TEST RESULT**

This product has an PCB antenna, fulfill the requirement of this section.

## 6. CONDUCTED EMISSIONS MEASUREMENT

### 6.1 POWER LINE CONDUCTED EMISSION LIMITS (Frequency Range 150KHz-30MHz)

The specification used was with the FCC Part 15.207 Limit.

FREQUENCY (MHz)	Class A (dBuV)		Class B (dBuV)		Standard
	Quasi-peak	Average	Quasi-peak	Average	
0.15 -0.5	79.00	66.00	66 - 56 *	56 - 46 *	FCC
0.50 -5.0	73.00	60.00	56.00	46.00	FCC
5.0 -30.0	73.00	60.00	60.00	50.00	FCC

Note:

- (1) The tighter limit applies at the band edges.
- (2) The limit of " \* " marked band means the limitation decreases linearly with the logarithm of the frequency in the range.

The following table is the setting of the receiver

Receiver Parameters	Setting
Attenuation	10 dB
Start Frequency	0.15 MHz
Stop Frequency	30 MHz
IF Bandwidth	9 kHz

### 6.2 TEST PROCEDURE

The setup of EUT is according with per ANSI C63.4-2009 measurement procedure

- a. The EUT was placed 0.4 meters from the horizontal ground plane with EUT being connected to the power mains through a line impedance stabilization network (LISN). All other support equipments powered from additional LISN(s). The LISN provide 50 Ohm/ 50uH of coupling impedance for the measuring instrument.
- b. Interconnecting cables that hang closer than 40 cm to the ground plane shall be folded back and forth in the center forming a bundle 30 to 40 cm long.
- c. I/O cables that are not connected to a peripheral shall be bundled in the center. The end of the cable may be terminated, if required, using the correct terminating impedance. The overall length shall not exceed 1 m.
- d. LISN at least 80 cm from nearest part of EUT chassis.
- e. For the actual test configuration, please refer to the related Item –EUT Test Photos.

### 6.3 TEST SETUP

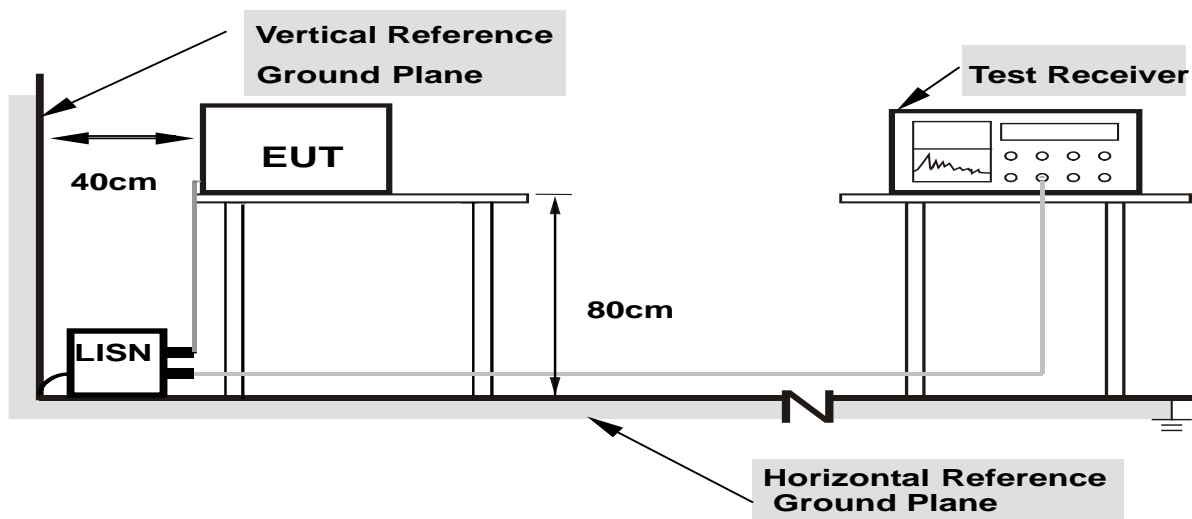

- Note: 1.Support units were connected to second LISN.  
 2.Both of LISNs (AMN) are 80 cm from EUT and at least 80 from other units and other metal planes**

### 6.4 ENVIRONMENTAL CONDITIONS

Temperature:	24 °C
Relative Humidity:	60 %
ATM Pressure:	1012 mbar

### 6.5 TEST RESULTS

The EUT is supplied by 3.0V from AAA battery, so Conducted Emission is not applicable.

## 7. RADIATED EMISSION MEASUREMENT

### 7.1 RADIATED EMISSION LIMITS

According to §15.249(a), the field strength of emissions from intentional radiators operated within these frequency bands shall comply with the following:

Fundamental Frequency	Field strength of fundamental (milli-volts/meter)	Field strength of Harmonics (micro-volts/meter)
902-928 MHz	50	500
2400-2483.5 MHz	50	500
5725-5875 MHz	50	500
24.0-24.25 GHz	250	2500

As per FCC§15.249 (c), Field strength limits are specified at a distance of 3 meters.

(d) Emissions radiated outside of the specified frequency bands, except for harmonics, shall be attenuated by at least 50 dB below the level of the fundamental or to the general radiated emission limits in §15.209, whichever is the lesser attenuation.

Frequencies (MHz)	Field Strength (micorvolts/meter)	Measurement Distance (meters)
0.009~0.490	2400/F(KHz)	300
0.490~1.705	24000/F(KHz)	30
1.705~30.0	30	30
30~88	100	3
88~216	150	3
216~960	200	3
Above 960	500	3

The emission limit in this paragraph is based on measurement instrumentation employing an average detector. The provisions in §15.35 for limiting peak emissions apply. Spurious Radiated Emissions measurements starting below or at the lowest crystal frequency.

Emissions radiated outside of the specified frequency bands, except for harmonics, shall be attenuated by at least 50 dB below the level of the fundamental or to the general radiated emission limits in Section 15.209, whichever is the lesser attenuation.

## 7.2 TEST EQUIPMENT SETUP

During the radiated emission test, the EMI test receiver & Spectrum Analyzer Setup were set with the following configurations:

Spectrum Parameter	Setting
Attenuation	Auto
Start Frequency	1000 MHz
Stop Frequency	10th carrier harmonic
RB / VB (emission in restricted band)	1 MHz / 1 MHz for Peak, 1 MHz / 10Hz for Average

Receiver Parameter	Setting
Attenuation	Auto
Start ~ Stop Frequency	9kHz~150kHz / RB 200Hz for QP
Start ~ Stop Frequency	150kHz~30MHz / RB 9kHz for QP
Start ~ Stop Frequency	30MHz~1000MHz / RB 120kHz for QP

## 7.3 TEST PROCEDURE

- a. The measuring distance of at 3 m shall be used for measurements at frequency up to 1GHz. For frequencies above 1GHz, any suitable measuring distance may be used.
- b. The EUT was placed on the top of a rotating table 0.8 meters above the ground at a 3 meter open area test site. The table was rotated 360 degrees to determine the position of the highest radiation.
- c. The height of the equipment or of the substitution antenna shall be 0.8 m; the height of the test antenna shall vary between 1 m to 4 m. Both horizontal and vertical polarizations of the antenna are set to make the measurement.
- d. The initial step in collecting conducted emission data is a spectrum analyzer peak detector mode pre-scanning the measurement frequency range. Significant peaks are then marked and then Quasi Peak detector mode re-measured.
- e. If the Peak Mode measured value compliance with and lower than Quasi Peak Mode Limit, the EUT shall be deemed to meet QP Limits and then no additional QP Mode measurement performed.
- f. For the actual test configuration, please refer to the related Item –EUT Test Photos.



## 7.4 TEST SETUP

### (A) Radiated Emission Test-Up Frequency Below 30MHz

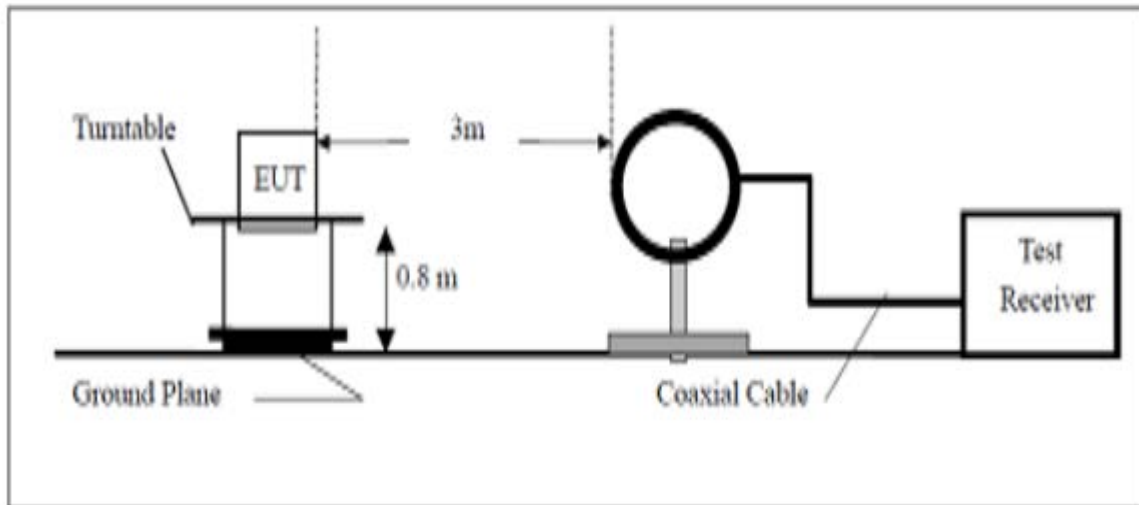

### (B) Radiated Emission Test-Up Frequency 30MHz~1GHz

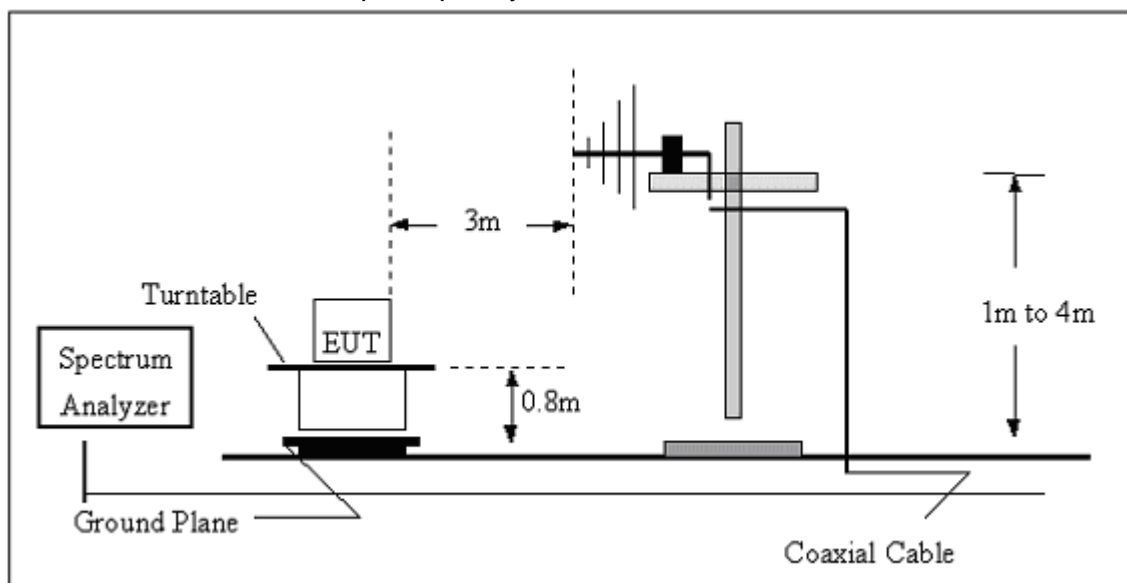

## (C) Radiated Emission Test-Up Frequency Above 1GHz

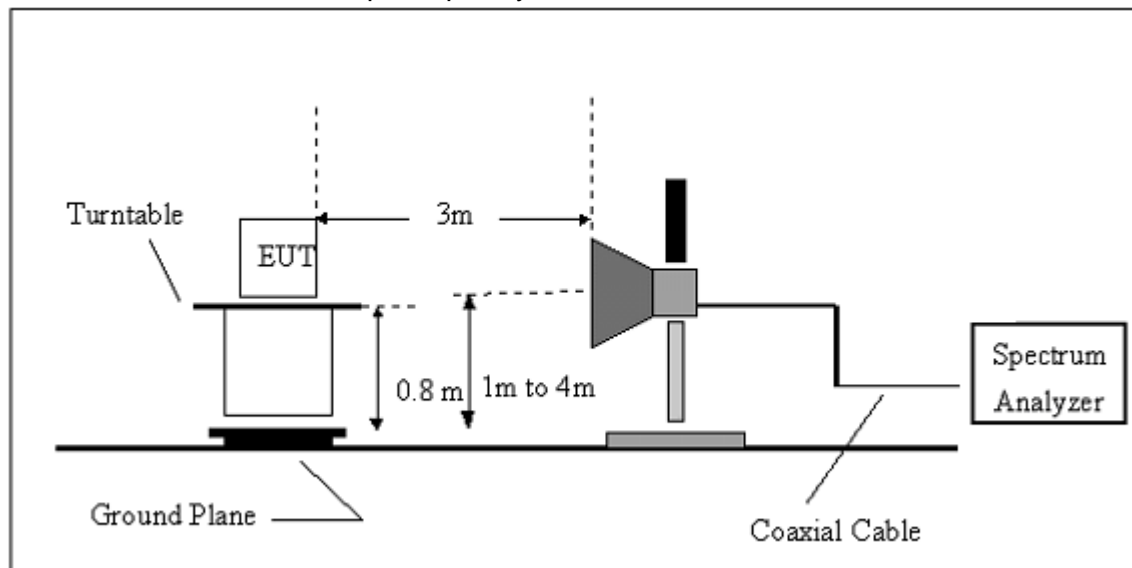

## 7.5 ENVIRONMENTAL CONDITIONS

Temperature:	25 °C
Relative Humidity:	57 %
ATM Pressure:	1012 mbar

## 7.6 TEST RESULTS

### Field Strength of Fundamental

Frequency	Reading	Correct Factor	Emission Level	Limit	Margin	Polar	Detector
(MHz)	(dBUV/m)	dB/m	(dBUV/m)	(dBUV/m)	(dB)	H/V	
2407	94.16	-8.67	85.49	114	-28.51	H	PK
2407	92.09	-8.67	83.42	94	-10.58	H	AV
2442	92.40	-8.4	84.00	114	-30.00	H	PK
2442	90.33	-8.4	81.93	94	-12.07	H	AV
2477	95.42	-8.25	87.17	114	-26.83	H	PK
2477	90.29	-8.25	82.04	94	-11.96	H	AV
2407	92.63	-8.67	83.96	114	-30.04	V	PK
2407	90.77	-8.67	82.10	94	-11.90	V	AV
2442	94.03	-8.4	85.63	114	-28.37	V	PK
2442	90.95	-8.4	82.55	94	-11.45	V	AV
2477	95.94	-8.25	87.69	114	-26.31	V	PK
2477	92.27	-8.25	84.02	94	-9.98	V	AV

**Note:**

1. Correction Factor= Antenna Factor + Cable loss - Pre-amplifier; Emission Level=Peak Reading + Correction Factor; Margin=Emission Level - Limit.

## Spurious Emissions

Frequency Range (9 kHz-30MHz)

Freq.	Emission Level	Limit	Margin	State
(MHz)	(dBuV/m)	(dBuV/m)	(dB)	P/F
--	--	--	--	P
--	--	--	--	P

**Note:**

1. *Emission Level=Reading+ Cable loss-Antenna factor-Amp factor*
2. *The emission levels are 20 dB below the limit value, which are not reported. It is deemed to comply with the requirement.*

Frequency Range (30MHz-1000MHz)

Horizontal:

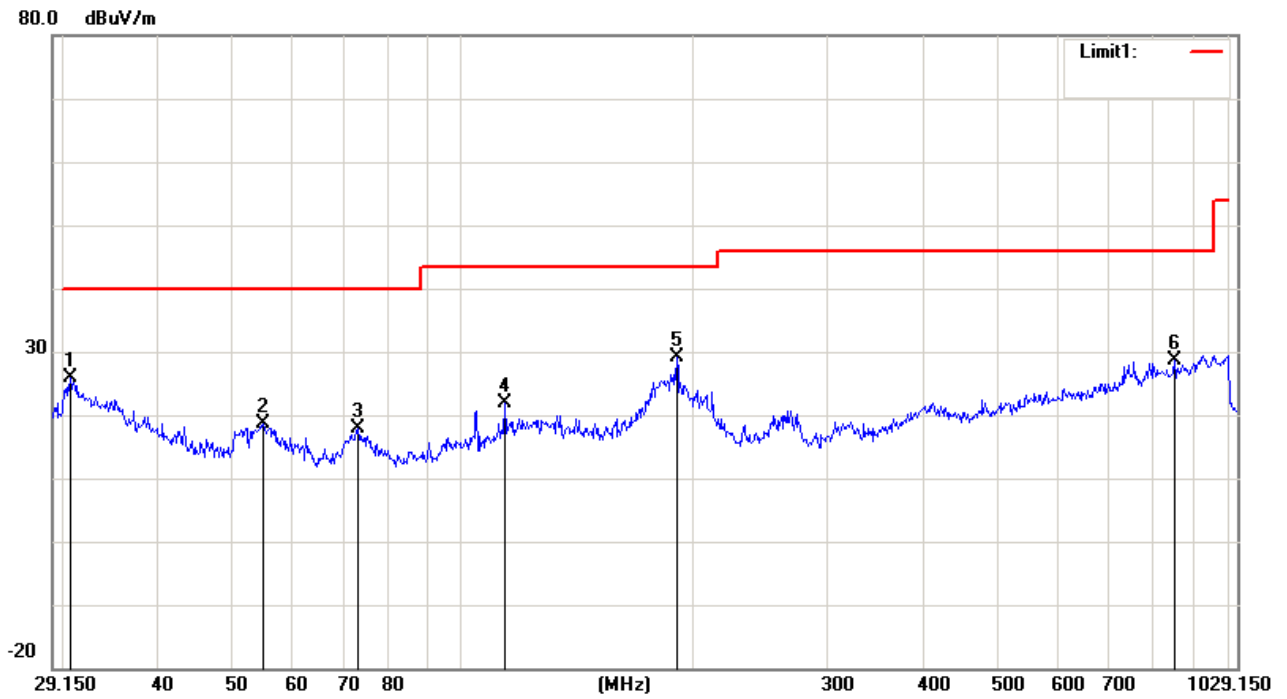

No.	Mk.	Freq. MHz	Reading Level dBuV	Correct Factor dB	Measure- ment dBuV/m	Limit dBuV/m	Over dB	Detector
1	*	30.7511	22.90	2.99	25.89	40.00	-14.11	peak
2		54.9740	28.21	-9.50	18.71	40.00	-21.29	peak
3		73.1113	25.52	-7.64	17.88	40.00	-22.12	peak
4		113.7407	24.92	-2.97	21.95	43.50	-21.55	peak
5		190.7007	34.37	-5.28	29.09	43.50	-14.41	peak
6		852.0076	23.74	4.82	28.56	46.00	-17.44	peak

Vertical:

80.0 dBuV/m

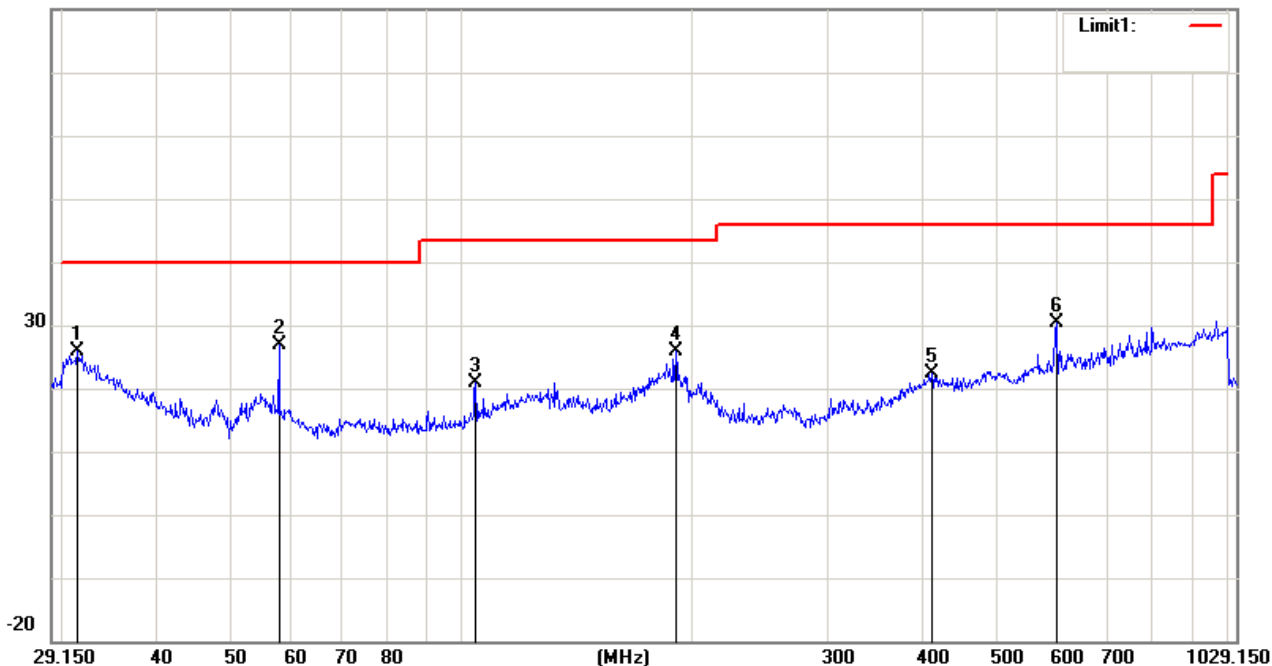

No.	Mk.	Freq. MHz	Reading Level dBuV	Correct Factor dB	Measure- ment dBuV/m	Limit dBuV/m	Over dB	Detector
1		31.5279	23.45	2.46	25.91	40.00	-14.09	peak
2	*	57.7866	36.38	-9.43	26.95	40.00	-13.05	peak
3		104.4162	26.05	-5.11	20.94	43.50	-22.56	peak
4		190.7007	31.07	-5.28	25.79	43.50	-17.71	peak
5		411.7986	24.36	-2.02	22.34	46.00	-23.66	peak
6		598.6977	29.43	1.00	30.43	46.00	-15.57	peak

**Note:**

Measurements were conducted in all channels (high, middle, low), and the worst case (low channel) was submitted only.

## Frequency Range (Above 1G)

Frequency	Reading	Correct Factor	Emission Level	Limit	Margin	Polar	Detector
(MHz)	(dBuV/m)	dB/m	(dBuV/m)	(dBuV/m)	(dB)	H/V	
Low Channel-2407MHz							
4810	56.05	-1.29	54.76	74	-19.24	H	PK
4810	40.50	-1.29	39.21	54	-14.79	H	AV
7215	50.13	6.51	56.64	74	-17.36	H	PK
7215	33.18	6.51	39.69	54	-14.31	H	AV
4810	55.81	-1.29	54.52	74	-19.48	V	PK
4810	41.88	-1.29	40.59	54	-13.41	V	AV
7215	44.11	6.51	50.62	74	-23.38	V	PK
7215	34.04	6.51	40.55	54	-13.45	V	AV
Middle Channel-2442MHz							
4896	58.68	-0.98	57.70	74	-16.30	H	PK
4896	46.32	-0.98	45.34	54	-8.66	H	AV
7344	44.12	6.83	50.95	74	-23.05	H	PK
7344	30.35	6.83	37.18	54	-16.82	H	AV
4896	58.99	-0.98	58.01	74	-15.99	V	PK
4896	42.90	-0.98	41.92	54	-12.08	V	AV
7344	43.99	6.83	50.82	74	-23.18	V	PK
7344	29.51	6.83	36.34	54	-17.66	V	AV
High Channel-2477MHz							
4944	56.45	-0.8	55.65	74	-18.35	H	PK
4944	42.70	-0.8	41.90	54	-12.10	H	AV
7416	44.33	6.94	51.27	74	-22.73	H	PK
7416	33.50	6.94	40.44	54	-13.56	H	AV
4944	56.60	-0.8	55.80	74	-18.20	V	PK
4944	40.73	-0.8	39.93	54	-14.07	V	AV
7416	45.85	6.94	52.79	74	-21.21	V	PK
7416	32.98	6.94	39.92	54	-14.08	V	AV

**Note:**

1. Correction Factor= Antenna Factor + Cable loss - Pre-amplifier; Emission Level=Peak Reading + Correction Factor; Margin=Emission Level - Limit.
2. The emission levels of other frequencies are very lower than the limit and not show in test report.
3. Measurements were conducted from 1 GHz to the 10th harmonic of highest fundamental frequency.

## OUT OF BAND EMISSION

Frequency	Reading	Correct Factor	Emission Level	Limit	Margin	Polar	Detector
(MHz)	(dBuV/m)	dB/m	(dBuV/m)	(dBuV/m)	(dB)	H/V	
Low Channel-2407MHz							
2390	67.55	-8.73	58.82	74	-15.18	H	PK
2390	47.24	-8.73	38.51	54	-15.49	H	AV
2390	66.15	-8.73	57.42	74	-16.58	V	PK
2390	46.62	-8.73	37.89	54	-16.11	V	AV
High Channel-2477MHz							
2483.5	68.53	-8.17	60.36	74	-13.64	H	PK
2483.5	46.33	-8.17	38.16	54	-15.84	H	AV
2483.5	68.25	-8.17	60.08	74	-13.92	V	PK
2483.5	46.48	-8.17	38.31	54	-15.69	V	AV

**Note:**

1. Correction Factor= Antenna Factor + Cable loss - Pre-amplifier; Emission Level=Peak Reading + Correction Factor; Margin=Emission Level - Limit.

2. The emission levels of other frequencies are very lower than the limit and not show in test report.

3. Measurements were conducted from 1 GHz to the 10th harmonic of highest fundamental frequency.



## 8. 20DB OCCUPIED BANDWIDTH

### 8.1 STANDARD APPLICABLE

According to 15.215 (c), intentional radiators operating under the alternative provisions to the general emission limits, as contained in §§15.217 through 15.257 and in Subpart E of this part, must be designed to ensure that the 20 dB bandwidth of the emission, or whatever bandwidth may otherwise be specified in the specific rule section under which the equipment operates, is contained within the frequency band designated in the rule section under which the equipment is operated. The requirement to contain the designated bandwidth of the emission within the specified frequency band includes the effects from frequency sweeping, frequency hopping and other modulation techniques that may be employed as well as the frequency stability of the transmitter over expected variations in temperature and supply voltage. If a frequency stability is not specified in the regulations, it is recommended that the fundamental emission be kept within at least the central 80% of the permitted band in order to minimize the possibility of out-of-band operation.

### 8.2 TEST PROCEDURE

According to the ANSI 63.4-2009, the emission bandwidth test method as follows.

1. According to the follow Test-setup, keep the relative position between the artificial antenna and the EUT.
2. Set to the maximum power setting and enable the EUT transmit continuously.
3. Use the following spectrum analyzer settings for 20dB Bandwidth measurement.  
Span = approximately 2 to 3 times the 20 dB bandwidth, centered on a hopping channel;  
RBW 1% of the 20 dB bandwidth; VBW RBW; Sweep = auto; Detector function =peak; Trace = max hold.
4. Measure and record the results in the test report.

### 8.3 TEST SETUP



### 8.4 ENVIRONMENTAL CONDITIONS

Temperature:	22 °C
Relative Humidity:	58 %
ATM Pressure:	1012 mbar

### 8.5 TEST RESULTS

Frequency	20dB Bandwidth (kHz)	Result
2407 MHz	2067	PASS
2442 MHz	2083	PASS
2477 MHz	2075	PASS

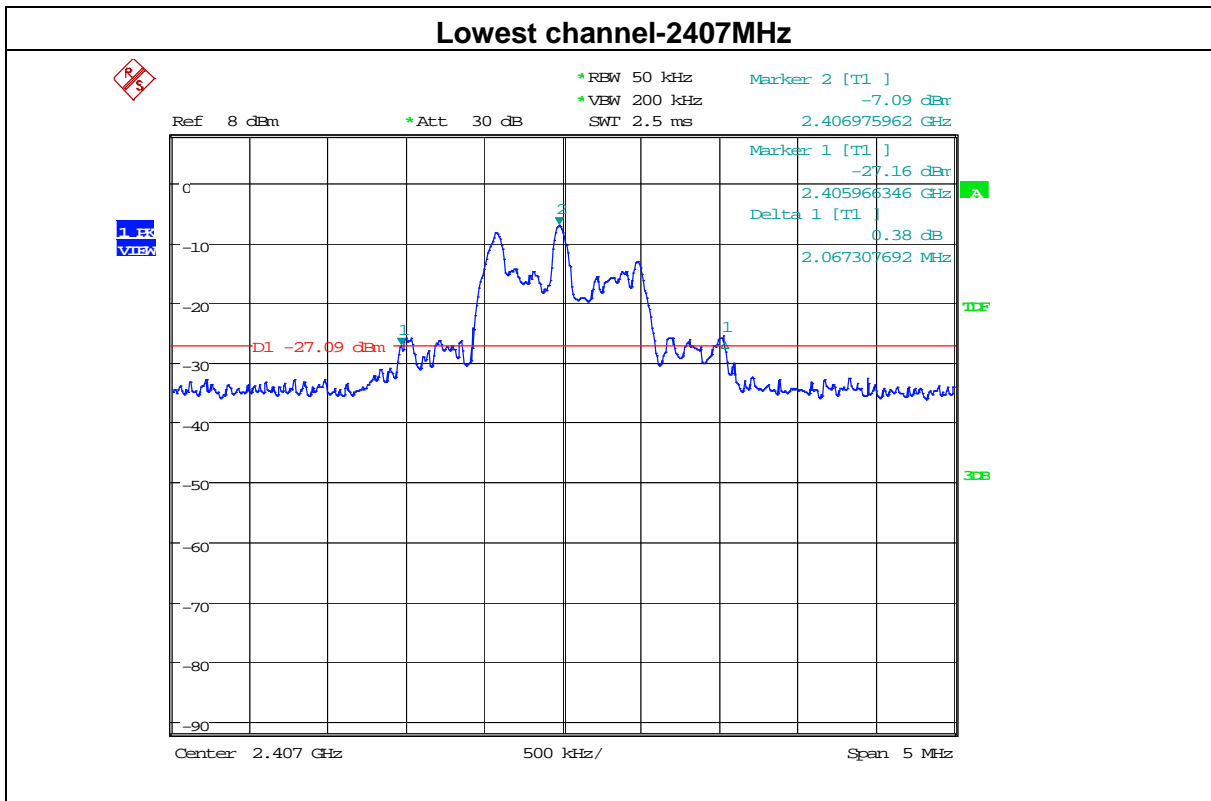

### Middle channel-2442MHz

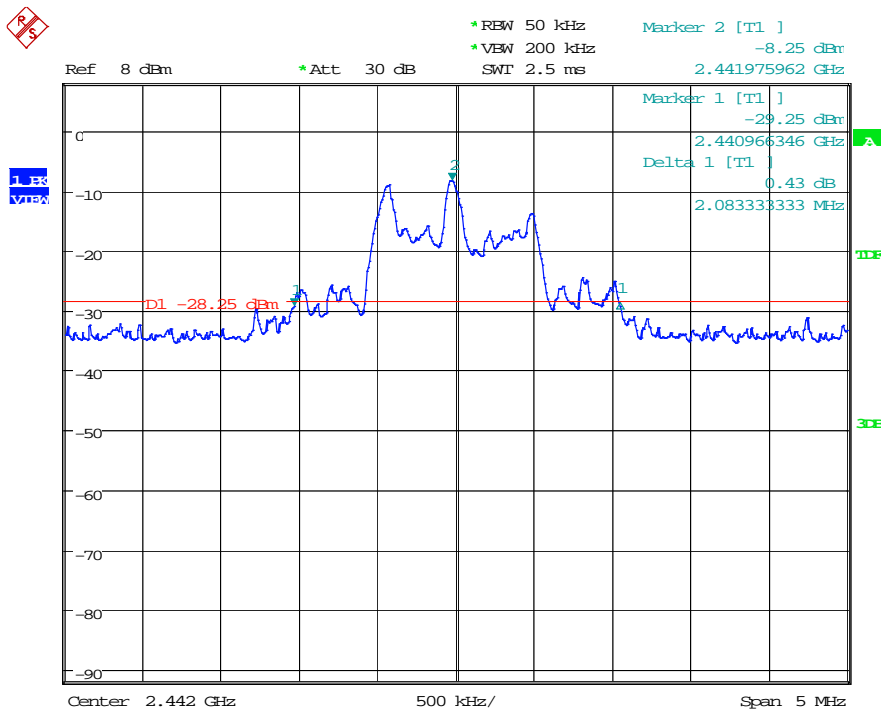

### Highest channel-2477MHz

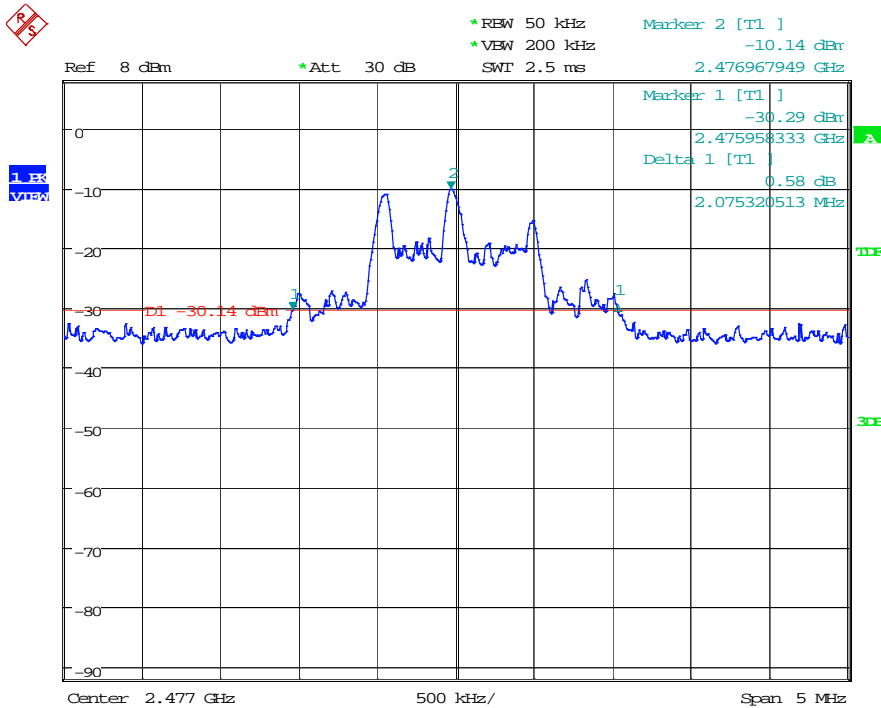

## 9. PHOTOGRAPHS OF TEST SETUP

RADIATED EMISSION TEST

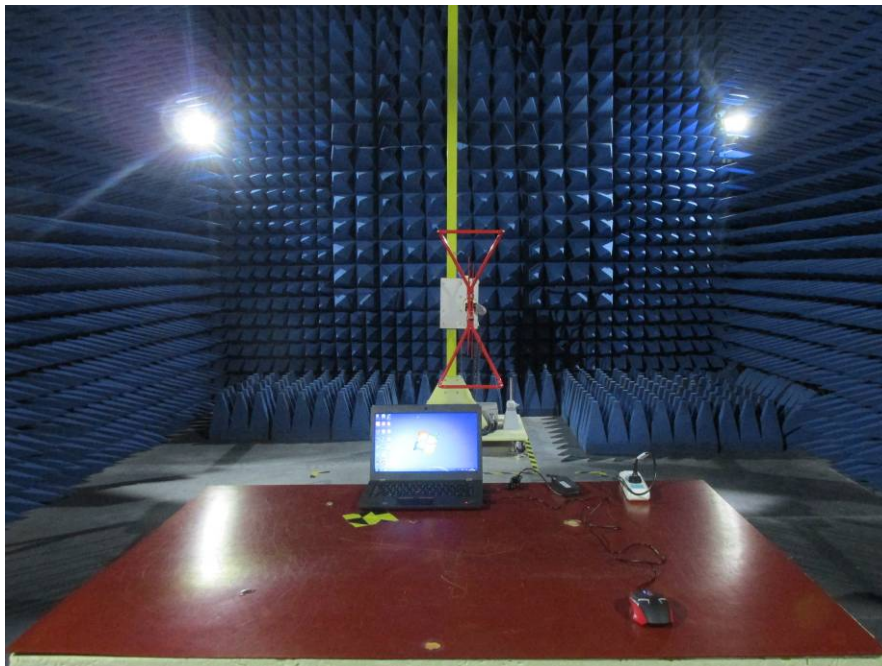

RADIATED EMISSION TEST

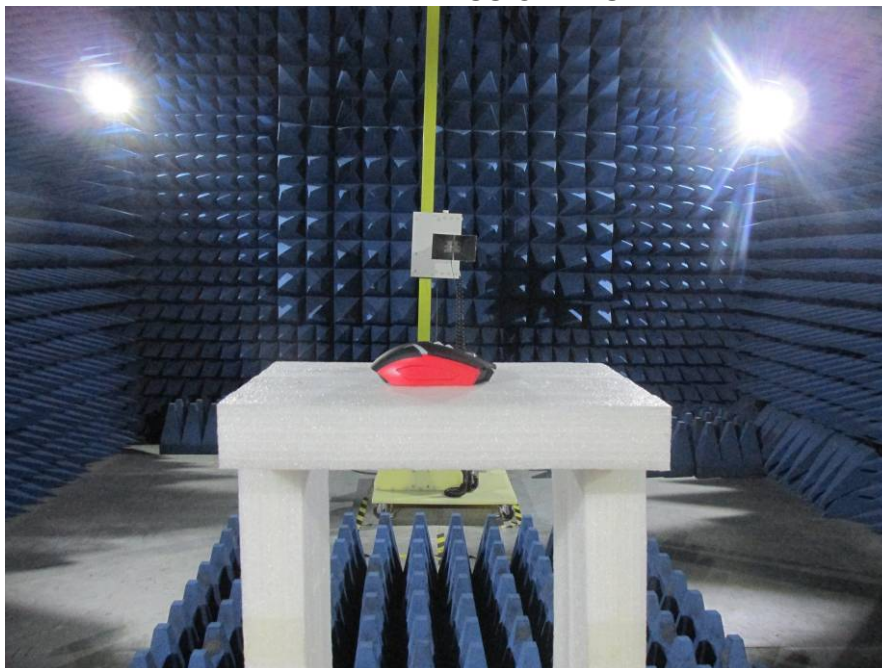

### RF TEST

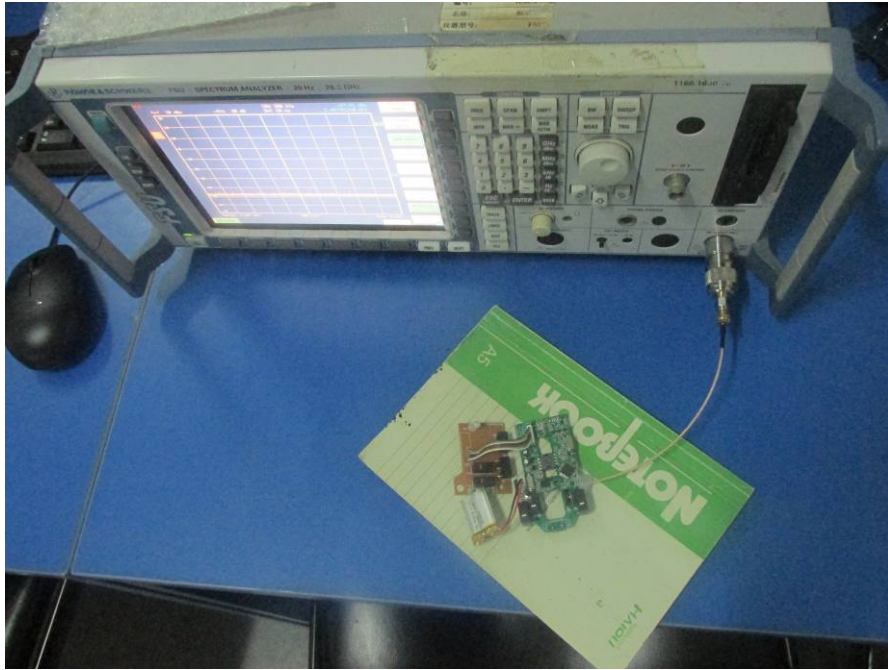

## 10. PHOTOGRAPHS OF EUT

Appearance photograph of EUT



Appearance photograph of EUT



Internal photograph of EUT



Internal photograph of EUT



Appearance photograph of EUT



Appearance photograph of EUT





Appearance photograph of EUT



Appearance photograph of EUT

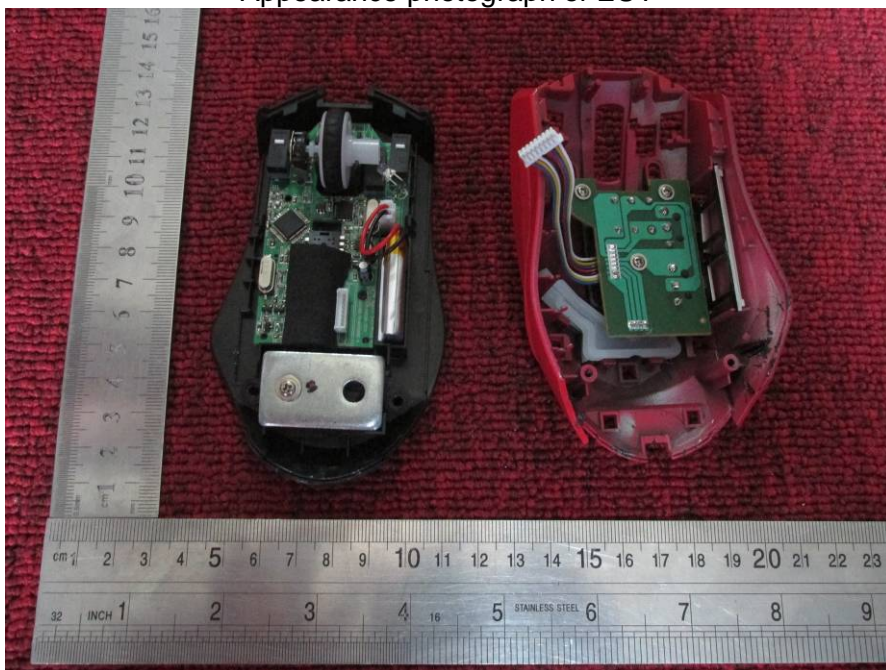

Appearance photograph of EUT

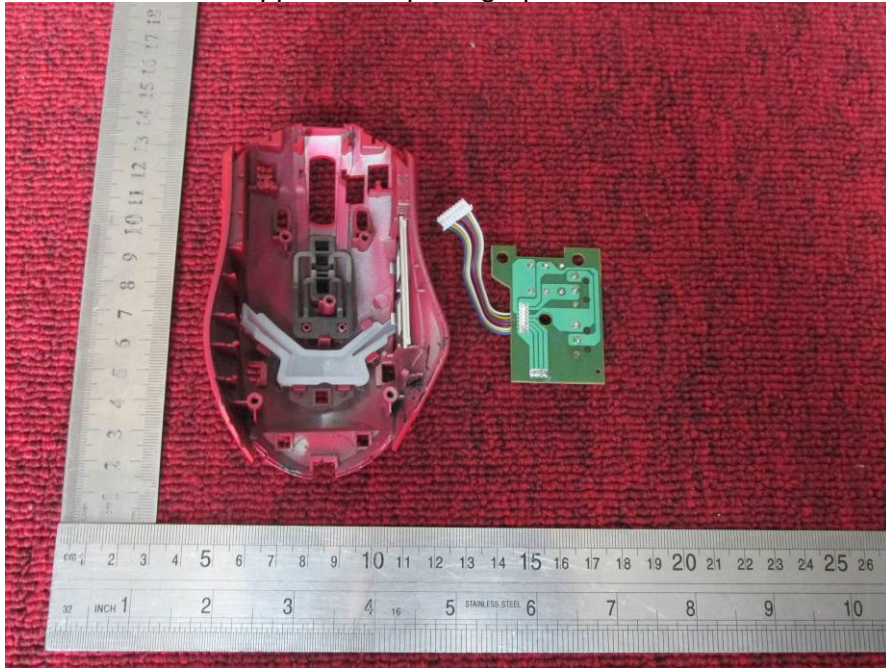

Appearance photograph of EUT

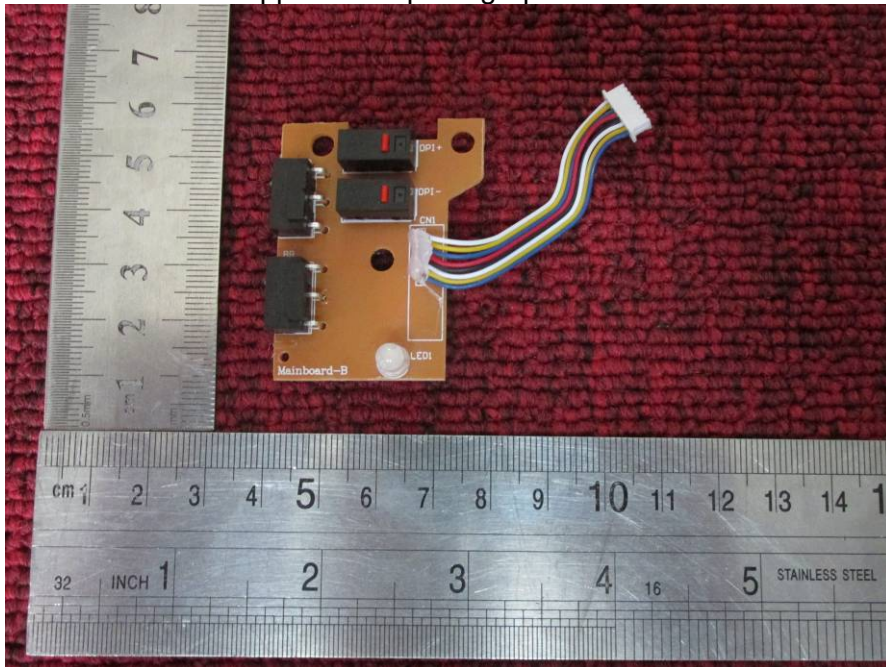

Appearance photograph of EUT

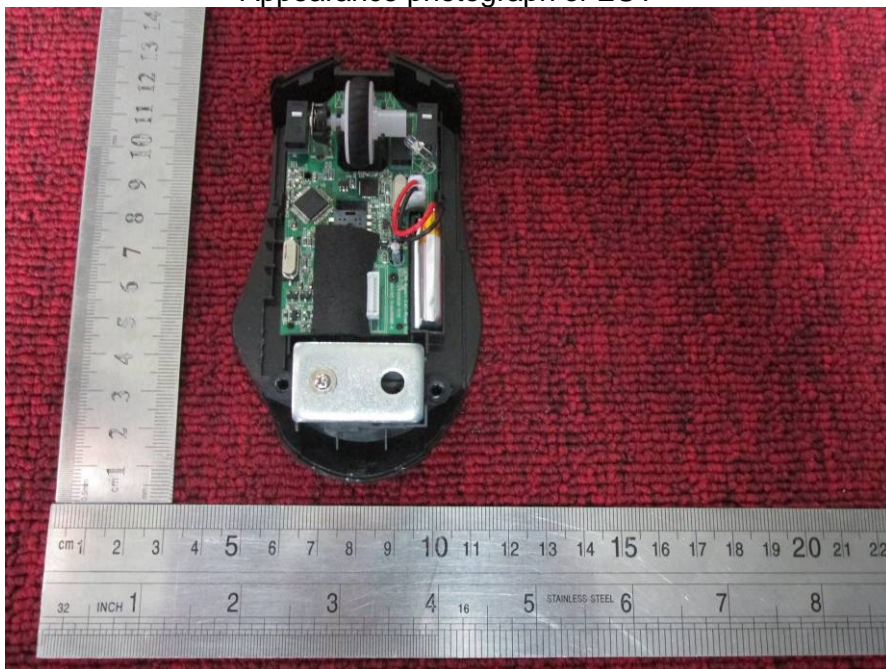

Appearance photograph of EUT



Internal photograph of EUT

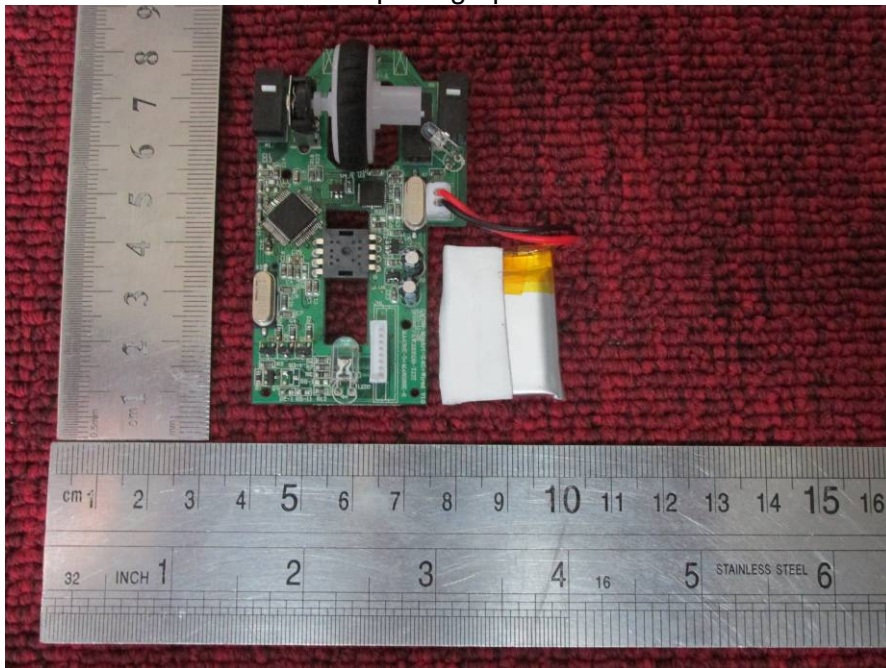

Internal photograph of EUT

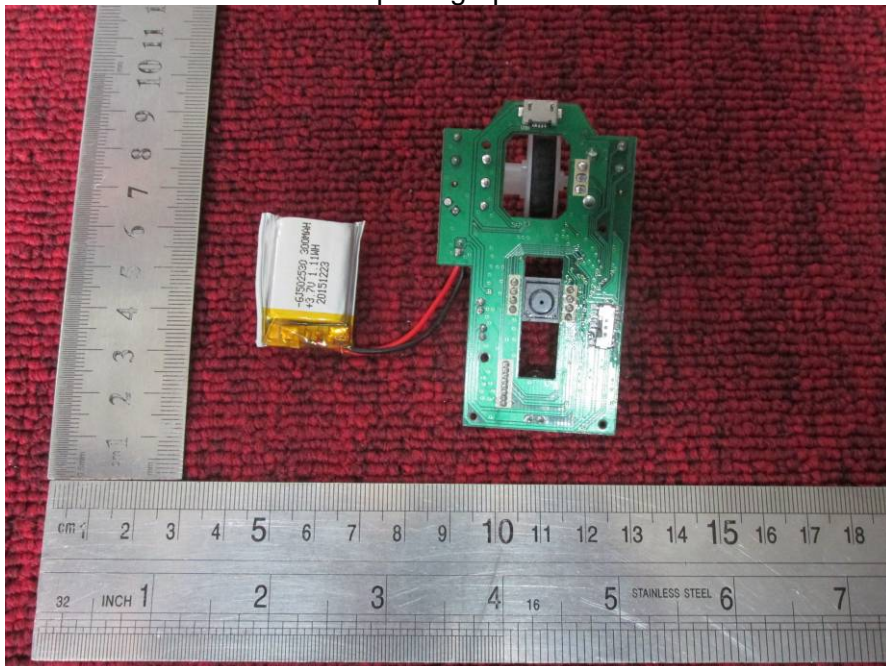

Internal photograph of EUT



Internal photograph of EUT

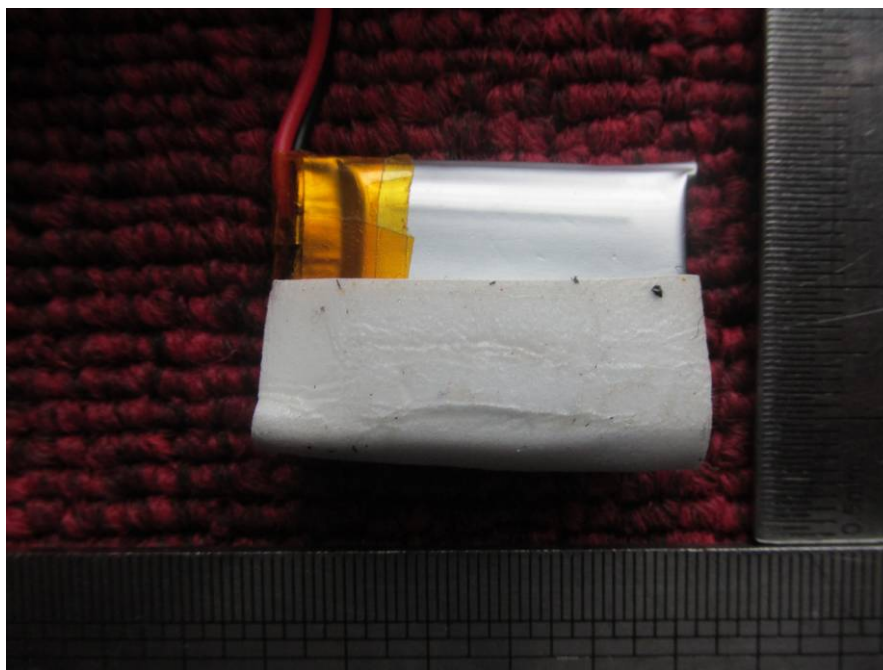

Internal photograph of EUT

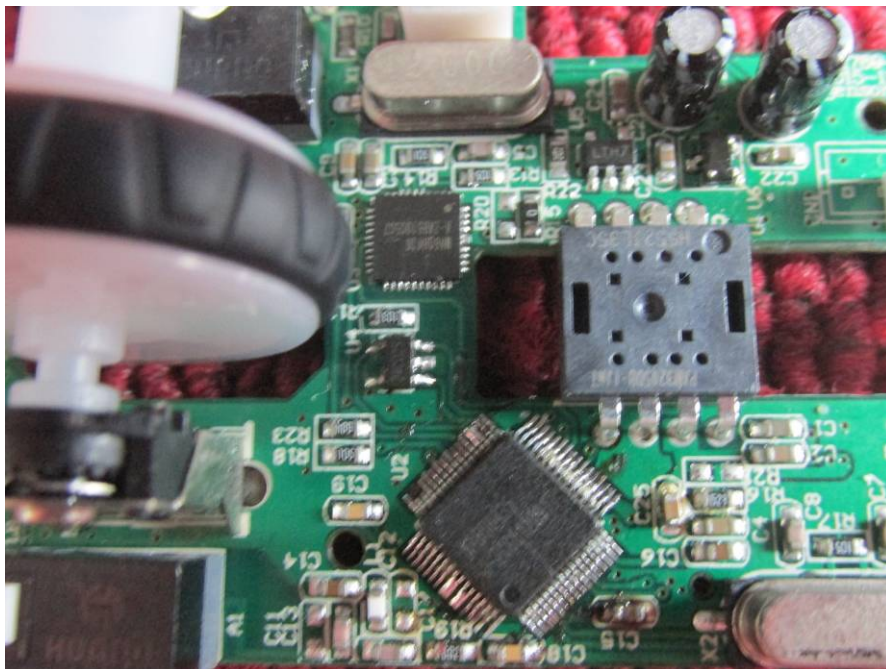

Internal photograph of EUT

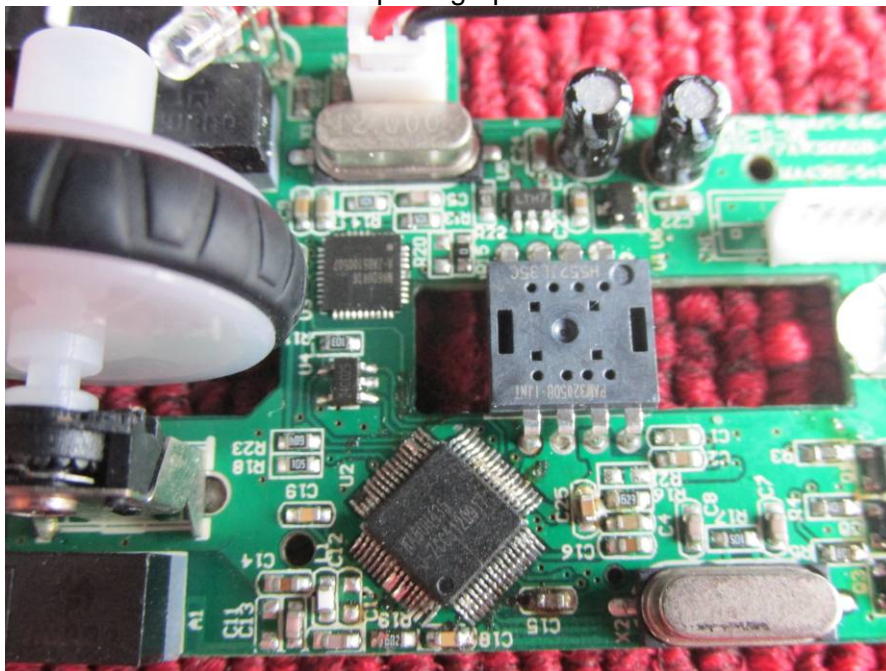

Internal photograph of EUT

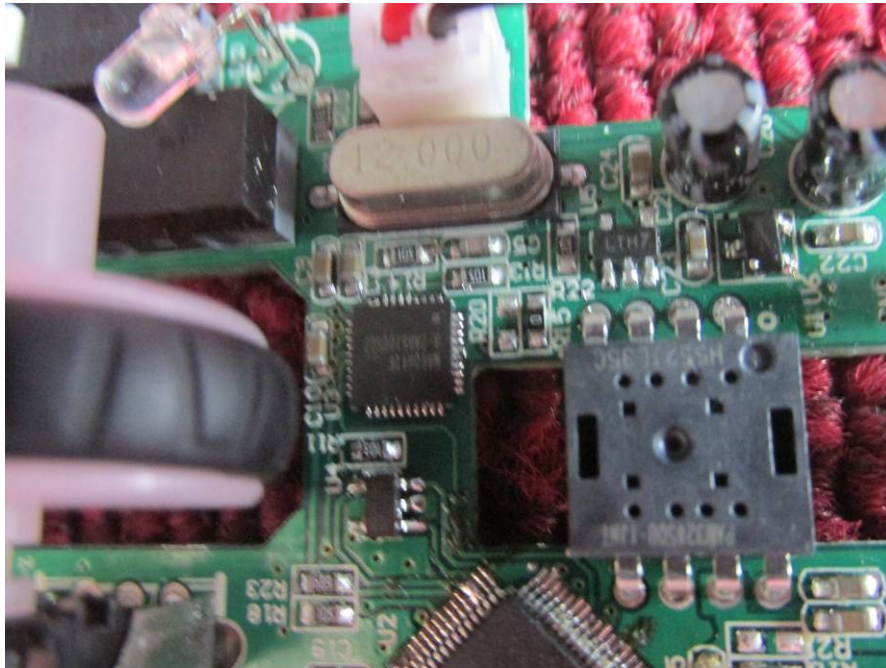

—END OF REPORT—