

REPORT REVISE RECORD

Report Version	Revise Time	Issued Date	Valid Version	Notes
V1.0	/	December 26, 2015	Valid	Original Report

Table of Contents	Page
1. GENERAL INFORMATION	5
2. TEST DESCRIPTION	7
2.1 MEASUREMENT UNCERTAINTY	7
2.2 DESCRIPTION OF TEST MODES	8
2.3 TABLE OF PARAMETERS OF TEXT SOFTWARE SETTING	9
2.4 CONFIGURATION OF SYSTEM UNDER TEST	9
2.5 DESCRIPTION OF SUPPORT UNITS (CONDUCTED MODE)	10
3. SUMMARY OF TEST RESULTS	11
4. MEASUREMENT INSTRUMENTS	12
5. EMC EMISSION TEST	13
5.1 CONDUCTED EMISSION MEASUREMENT	13
5.1.1 POWER LINE CONDUCTED EMISSION LIMITS	13
5.1.2 TEST PROCEDURE	14
5.1.3 DEVIATION FROM TEST STANDARD	14
5.1.4 TEST SETUP	14
5.1.5 EUT OPERATING CONDITIONS	14
5.1.6 TEST RESULTS	15
5.2 RADIATED EMISSION MEASUREMENT	17
5.2.1 RADIATED EMISSION LIMITS	17
5.2.2 TEST PROCEDURE	18
5.2.3 DEVIATION FROM TEST STANDARD	18
5.2.4 TEST SETUP	19
5.2.5 EUT OPERATING CONDITIONS	20
5.2.5.1 RESULTS (BELOW 30 MHZ)	21
5.2.5.2 TEST RESULTS (BETWEEN 30M – 1000 MHZ)	22
5.2.5.3 TEST RESULTS(1GHZ TO 25GHZ)	24
6. NUMBER OF HOPPING CHANNEL	
6.1 APPLIED PROCEDURES / LIMIT	32
6.2 TEST PROCEDURE	32
6.3 DEVIATION FROM STANDARD	32
6.4 TEST SETUP	32
6.5 EUT OPERATION CONDITIONS	32
6.6 TEST RESULTS	33
7. AVERAGE TIME OF OCCUPANCY	
7.1 APPLIED PROCEDURES / LIMIT	34

Table of Contents	Page
7.2 TEST PROCEDURE	34
7.3 DEVIATION FROM STANDARD	34
7.4 TEST SETUP	35
7.5 EUT OPERATION CONDITIONS	35
7.6 TEST RESULTS	36
8. HOPPING CHANNEL SEPARATION MEASUREMENT	
8.1 APPLIED PROCEDURES / LIMIT	38
8.2 TEST PROCEDURE	38
8.3 DEVIATION FROM STANDARD	38
8.4 TEST SETUP	38
8.5 EUT OPERATION CONDITIONS	38
8.6 TEST RESULTS	39
9. BANDWIDTH TEST	
9.1 APPLIED PROCEDURES / LIMIT	41
9.2 TEST PROCEDURE	41
9.3 DEVIATION FROM STANDARD	41
9.4 TEST SETUP	41
9.5 EUT OPERATION CONDITIONS	41
9.6 TEST RESULTS	42
10. PEAK OUTPUT POWER TEST	
10.1 APPLIED PROCEDURES / LIMIT	44
10.2 TEST PROCEDURE	44
10.3 DEVIATION FROM STANDARD	44
10.4 TEST SETUP	44
10.5 EUT OPERATION CONDITIONS	44
10.6 TEST RESULTS	45
11. ANTENNA APPLICATION	53
12. EUT TEST PHOTO	54
13. PHOTOGRAPHS OF EUT	56

1. GENERAL INFORMATION

GENERAL DESCRIPTION OF EUT

Test Model	BT-588C
Derivative Model Name	MI-BTE03, 8041968, 8041969
Model difference	All models are identical in circuitry and electrical, mechanical and physical construction, only different on model name and color. All tests are carried out on BT-588C
Applicant	WINTOP ELECTRONICS CO., LIMITED
Address	Unit 04 7/F, Bright Way Tower 33, Mong Kok RD KL, HONGKONG
Manufacturer	Shenzhen Wintop Electronics Co., Limited
Address	HuaGuan Industrial Park, Xinhe Road, Baolai Industrial District, Shangmugu, Pinghu Town, Longgang District, Shenzhen City, 518000, China
Equipment Type	In-ear Bluetooth stereo headphone
Brand Name	N/A
Hardware version:	N/A
Software version:	N/A
Extreme Temp. Tolerance	-10°C to +50°C
Battery information:	Model: 401119 Voltage: 3.7V Capacity: 55mAh
Adapter Information:	N/A
Operating Frequency	2402-2480MHz
Channels	79
Channel Spacing	1MHz
Modulation Type	GFSK, $\pi/4$ -DQPSK, 8-DPSK
Version	3.0
Antenna Type:	PCB Antenna
Antenna gain:	2.0dBi
Data of receipt	December 18, 2015
Date of test	December 18, 2015 to December 26, 2015
Deviation	None
Condition of Test Sample	Normal

We hereby certify that:

The above equipment was tested by Shenzhen WST Testing Technology Co., Ltd.

1F, No.9 Building, TKG Science & Technology Park Yangtian Rd., NO.72 Bao'an Dist., Guangdong, China

Registration Number: 939433

The data evaluation, test procedures, and equipment configurations shown in this report were made in accordance with the procedures given in ANSI C 63.4:2009. The sample tested as described in this report is in compliance with the FCC Rules Part 15 Subpart C.

The test results of this report relate only to the tested sample identified in this report.

2. TEST DESCRIPTION

2.1 MEASUREMENT UNCERTAINTY

The reported uncertainty of measurement $y \pm U$, where expanded uncertainty U is based on a standard uncertainty multiplied by a coverage factor of $k=2$, providing a level of confidence of approximately **95 %**.

No.	Item	Uncertainty
1	Conducted Emission Test	$\pm 3.2\text{dB}$
2	RF power, conducted	$\pm 0.16\text{dB}$
3	Spurious emissions, conducted	$\pm 0.21\text{dB}$
4	All emissions, radiated(<1G)	$\pm 4.7\text{dB}$
5	All emissions, radiated(>1G)	$\pm 4.7\text{dB}$
6	Temperature	$\pm 0.5^\circ\text{C}$
7	Humidity	$\pm 2\%$

2.2 DESCRIPTION OF TEST MODES

To investigate the maximum EMI emission characteristics generates from EUT, the test system was pre-scanning tested base on the consideration of following EUT operation mode or test configuration mode which possible have effect on EMI emission level. Each of these EUT operation mode(s) or test configuration mode(s) mentioned above was evaluated respectively.

Pretest Mode	Description
Mode 1	CH00
Mode 2	CH39
Mode 3	CH78
Mode 4	Normal Hopping

For Conducted Emission	
Final Test Mode	Description
Mode 4	Normal Hopping

For Radiated Emission	
Final Test Mode	Description
Mode 1	CH00
Mode 2	CH39
Mode 3	CH78

Note:

(1) The measurements are performed at the highest, middle, lowest available channels.

(2) The data rate was set in 1Mbps, 2 Mbps, 3 Mbps for radiated emission due to the highest RF output power.

(3) Record the worst case of each test item in this report.

2.3 TABLE OF PARAMETERS OF TEXT SOFTWARE SETTING

During testing channel & power controlling software provided by the customer was used to control the operating channel as well as the output power level. The RF output power selection is for the setting of RF output power expected by the customer and is going to be fixed on the firmware of the final end product power parameters of FHSS

Test software Version	N/A		
Frequency	2402 MHz	2441 MHz	2480 MHz
Parameters(1Mbps)	DEF	DEF	DEF
Parameters(2Mbps)	DEF	DEF	DEF
Parameters(3Mbps)	DEF	DEF	DEF

2.4 CONFIGURATION OF SYSTEM UNDER TEST

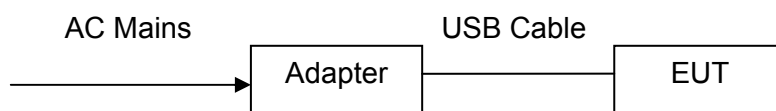

(EUT: In-ear Bluetooth stereo headphone)

I/O Port of EUT			
I/O Port Type	Q'TY	Cable	Tested with
USB port	1	0.3m USB cable, unshielded	1

2.5 DESCRIPTION OF SUPPORT UNITS (CONDUCTED MODE)

The EUT has been tested as an independent unit together with other necessary accessories or support units. The following support units or accessories were used to form a representative test configuration during the tests.

Item	Equipment	Mfr/Brand	Model/Type No.	Series No.	Note
1	Adapter	/	/	/	/

Note:

- (1) The support equipment was authorized by Declaration of Confirmation.
- (2) For detachable type I/O cable should be specified the length in cm in 『Length』 column.
- (3) “YES” is means “shielded” “with core”; “NO” is means “unshielded” “without core”.

3. SUMMARY OF TEST RESULTS

Test procedures according to the technical standards:

FCC Part15 (15.247) , Subpart C			
Standard Section	Test Item	Judgment	Remark
15.207	Conducted Emission	PASS	
15.247(a)(1)	Hopping Channel Separation	PASS	
15.247(b)(1)	Peak Output Power	PASS	
15.247(c)	Radiated Spurious Emission	PASS	
15.247(a)(iii)	Number of Hopping Frequency	PASS	
15.247(a)(iii)	Dwell Time	PASS	
15.247(a)(1)	Bandwidth	PASS	
15.205	Band Edge Emission	PASS	
15.203	Antenna Requirement	PASS	

NOTE:

(1) "N/A" denotes test is not applicable in this test report.

4. MEASUREMENT INSTRUMENTS

NAME OF EQUIPMENT	MANUFACTURER	MODEL	SERIAL NUMBER	Calibration Date	Calibration Due.
EMI Test Receiver	R&S	ESCI	100005	08/19/2015	08/18/2016
ESPI Test Receiver	ROHDE&SCHWARZ	ESPI	101139	08/19/2015	08/18/2015
LISN	AFJ	LS16	16010222119	08/19/2015	08/18/2016
LISN(EUT)	Mestec	AN3016	04/10040	08/19/2015	08/18/2016
Universal Radio Communication Tester	R&S	CMU 200	1100.0008.02	08/19/2015	08/18/2016
Coaxial cable	Megalon	LMR400	N/A	08/12/2015	08/11/2016
GPIB cable	Megalon	GPIB	N/A	08/12/2015	08/11/2016
Spectrum Analyzer	R&S	FSU	100114	08/19/2015	08/18/2016
Pre Amplifier	H.P.	HP8447E	2945A02715	10/13/2015	10/12/2016
Pre-Amplifier	CDSI	PAP-1G18-38	--	10/13/2015	10/12/2016
Bi-log Antenna	SUNOL Sciences	JB3	A021907	09/13/2015	09/12/2016
9*6*6 Anechoic	--	--	--	08/21/2015	08/20/2016
Horn Antenna	COMPLIANCE ENGINEERING	CE18000	--	09/13/2015	09/12/2016
Horn Antenna	SCHWARZBECK	BBHA9120D	9120D-631	08/23/2015	08/22/2016
Cable	TIME MICROWAVE	LMR-400	N-TYPE04	04/25/2015	04/24/2016
System-Controller	CCS	N/A	N/A	N.C.R	N.C.R
Turn Table	CCS	N/A	N/A	N.C.R	N.C.R
Antenna Tower	CCS	N/A	N/A	N.C.R	N.C.R
RF cable	Murata	MXHQ87WA3000	-	08/21/2015	08/20/2016
Loop Antenna	EMCO	6502	00042960	08/22/2015	08/21/2016
Horn Antenna	SCHWARZBECK	BBHA 9170	1123	08/19/2015	08/18/2016
Power meter	Anritsu	ML2487A	6K00003613	08/23/2015	08/22/2016
Power sensor	Anritsu	MX248XD	--	08/19/2015	08/18/2016

5. EMC EMISSION TEST

5.1 CONDUCTED EMISSION MEASUREMENT

5.1.1 POWER LINE CONDUCTED EMISSION Limits (Frequency Range 150KHz-30MHz)

FREQUENCY (MHz)	Class A (dBuV)		Class B (dBuV)		Standard
	Quasi-peak	Average	Quasi-peak	Average	
0.15 -0.5	79.00	66.00	66 - 56 *	56 - 46 *	FCC
0.50 -5.0	73.00	60.00	56.00	46.00	FCC
5.0 -30.0	73.00	60.00	60.00	50.00	FCC

Note:

- (1) The tighter limit applies at the band edges.
- (2) The limit of " * " marked band means the limitation decreases linearly with the logarithm of the frequency in the range.

The following table is the setting of the receiver

Receiver Parameters	Setting
Attenuation	10 dB
Start Frequency	0.15 MHz
Stop Frequency	30 MHz
IF Bandwidth	9 kHz

5.1.2 TEST PROCEDURE

- The EUT was placed 0.4 meters from the horizontal ground plane with EUT being connected to the power mains through a line impedance stabilization network (LISN). All other support equipments powered from additional LISN(s). The LISN provide 50 Ohm/ 50uH of coupling impedance for the measuring instrument.
- Interconnecting cables that hang closer than 40 cm to the ground plane shall be folded back and forth in the center forming a bundle 30 to 40 cm long.
- I/O cables that are not connected to a peripheral shall be bundled in the center. The end of the cable may be terminated, if required, using the correct terminating impedance. The overall length shall not exceed 1 m.
- LISN at least 80 cm from nearest part of EUT chassis.
- For the actual test configuration, please refer to the related Item –EUT Test Photos.

5.1.3 DEVIATION FROM TEST STANDARD

No deviation

5.1.4 TEST SETUP

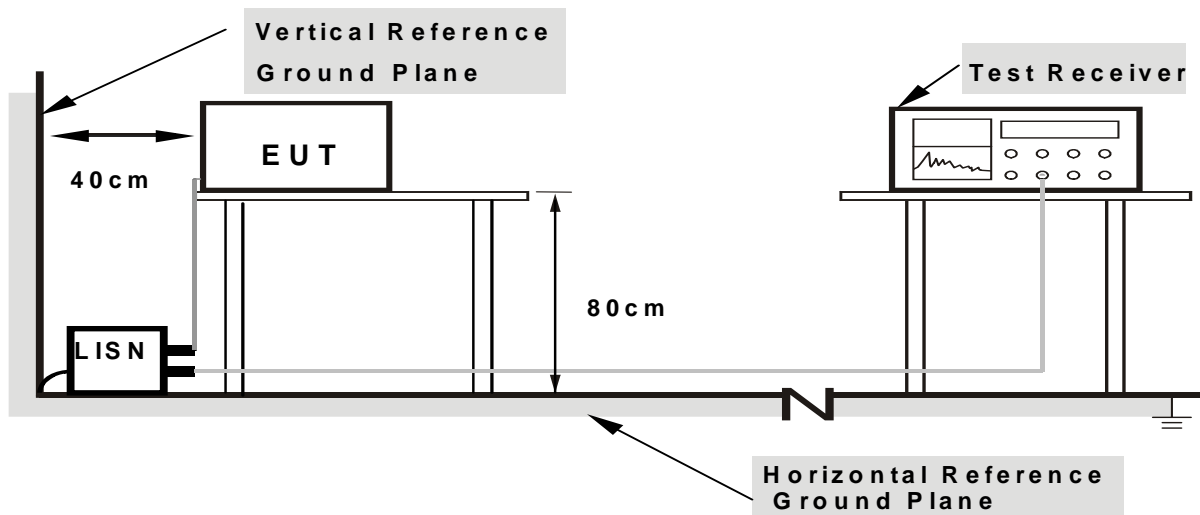

- Note:** 1. Support units were connected to second LISN.
 2. Both of LISNs (AMN) are 80 cm from EUT and at least 80 cm from other units and other metal planes

5.1.5 EUT OPERATING CONDITIONS

The EUT was configured for testing in a typical fashion (as a customer would normally use it). The EUT has been programmed to continuously transmit during test. This operating condition was tested and used to collect the included data.

5.1.6 TEST RESULTS

EUT	In-ear Bluetooth stereo headphone	Model Name	BT-588C
Temperature	26 °C	Relative Humidity	54%
Pressure	1010hPa	Phase	L
Test Date	December 21, 2015	Test Mode	Mode 4
Voltage	120V/60Hz		

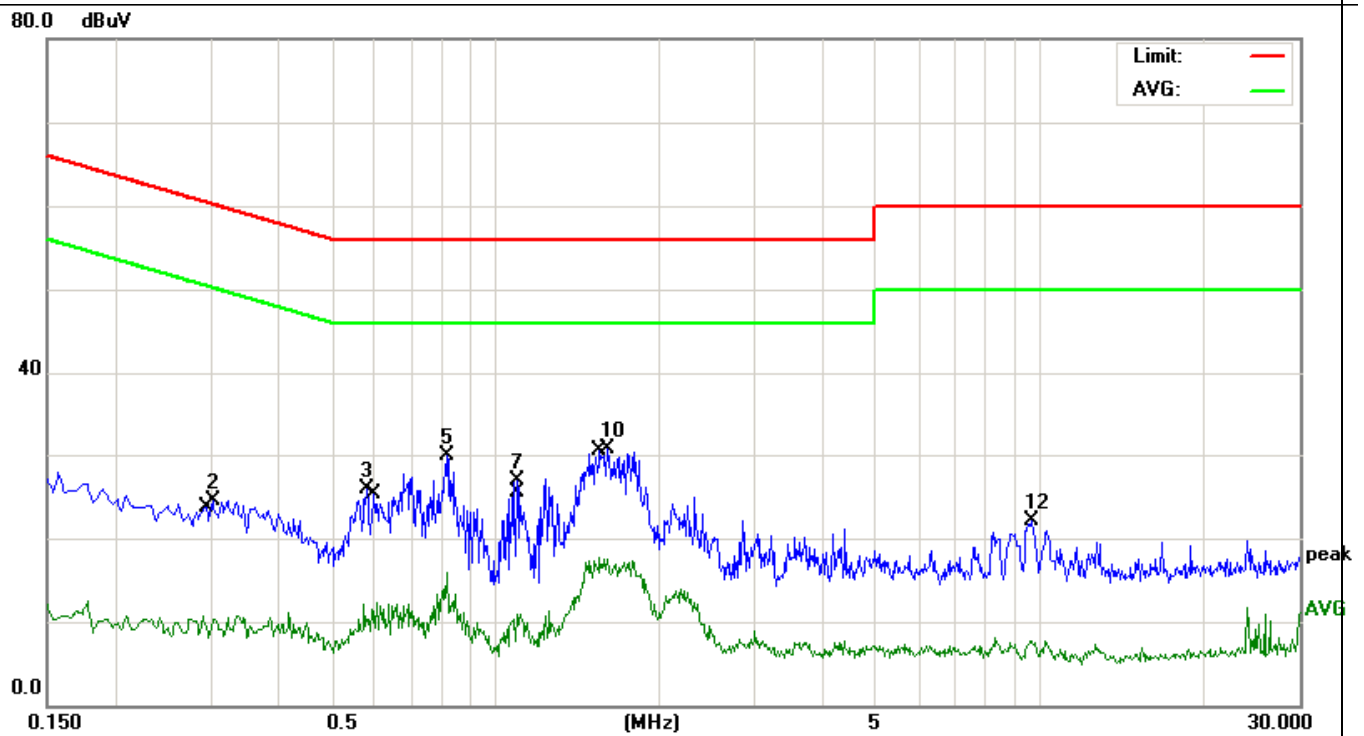

No. Mk.	Freq. MHz	Reading Level dBuV	Correct Factor dB	Measurement dBuV	Limit dBuV	Over dB	Detector
1	0.2900	0.05	10.62	10.67	50.52	-39.85	AVG
2	0.3020	13.82	10.65	24.47	60.19	-35.72	peak
3	0.5820	15.30	10.65	25.95	56.00	-30.05	peak
4	0.6060	1.58	10.71	12.29	46.00	-33.71	AVG
5	0.8139	19.41	10.56	29.97	56.00	-26.03	peak
6	0.8139	5.43	10.56	15.99	46.00	-30.01	AVG
7	1.0940	16.32	10.57	26.89	56.00	-29.11	peak
8	1.1140	0.29	10.57	10.86	46.00	-35.14	AVG
9	1.5540	7.21	10.59	17.80	46.00	-28.20	AVG
10 *	1.6019	20.04	10.59	30.63	56.00	-25.37	peak
11	9.6140	-2.65	10.42	7.77	50.00	-42.23	AVG
12	9.6620	11.61	10.42	22.03	60.00	-37.97	peak

Remark: All the modes have been investigated, and only worst mode is presented in this report.

EUT	In-ear Bluetooth stereo headphone	Model Name	BT-588C
Temperature	26 °C	Relative Humidity	54%
Pressure	1010hPa	Phase	N
Test Date	December 21, 2015	Test Mode	Mode 4
Voltage	120V/60Hz		

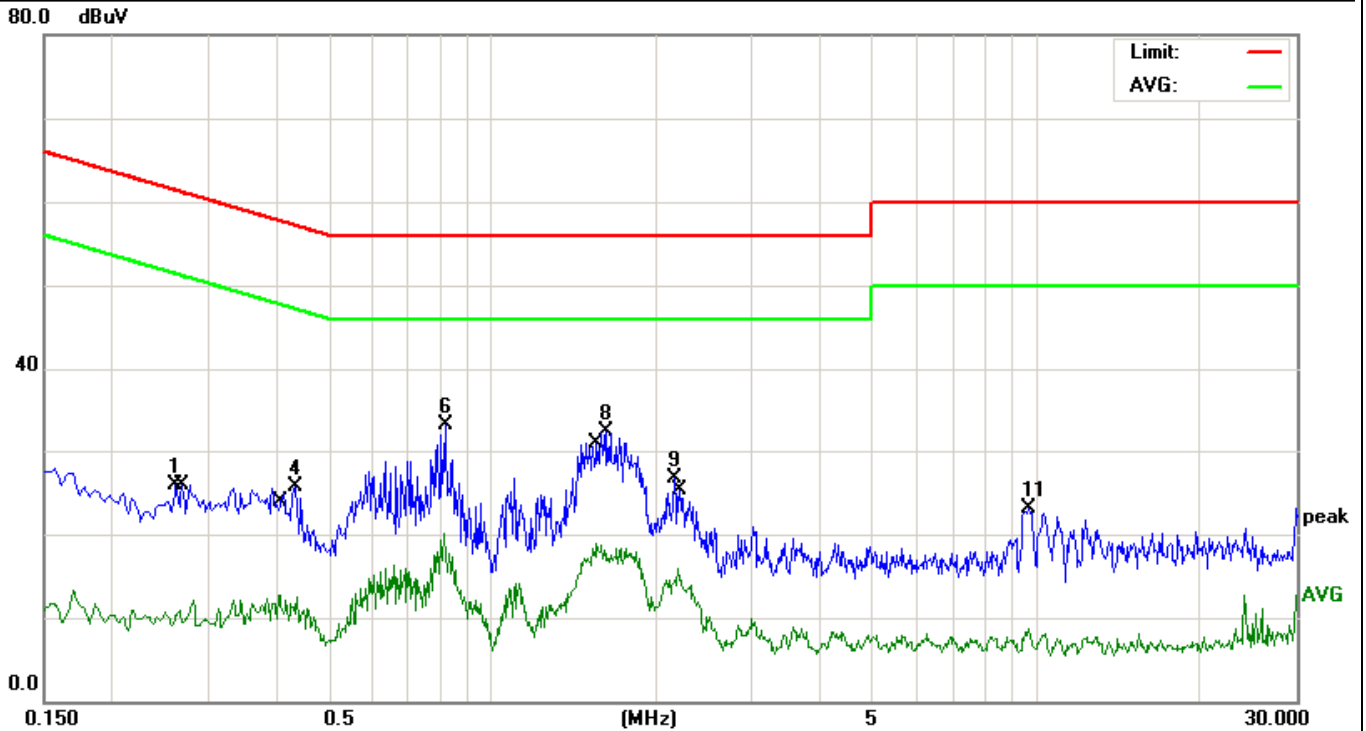

No.	Mk.	Freq. MHz	Reading Level dBuV	Correct Factor dB	Measure- ment dBuV	Limit dBuV	Over dB	Detector
1		0.2620	15.42	10.52	25.94	61.36	-35.42	peak
2		0.2660	0.32	10.53	10.85	51.24	-40.39	AVG
3		0.4060	2.25	10.49	12.74	47.73	-34.99	AVG
4		0.4340	15.23	10.47	25.70	57.18	-31.48	peak
5		0.8139	9.51	10.56	20.07	46.00	-25.93	AVG
6	*	0.8180	22.46	10.58	33.04	56.00	-22.96	peak
7		1.5540	8.21	10.59	18.80	46.00	-27.20	AVG
8		1.6260	21.74	10.59	32.33	56.00	-23.67	peak
9		2.1660	16.10	10.60	26.70	56.00	-29.30	peak
10		2.1900	5.25	10.61	15.86	46.00	-30.14	AVG
11		9.6700	12.76	10.42	23.18	60.00	-36.82	peak
12		9.6700	-1.66	10.42	8.76	50.00	-41.24	AVG

Remark: All the modes have been investigated, and only worst mode is presented in this report.

5.2 RADIATED EMISSION MEASUREMENT

5.2.1 RADIATED EMISSION LIMITS (Frequency Range 9kHz-1000MHz)

20dBc in any 100 kHz bandwidth outside the operating frequency band. In case the emission fall within the restricted band specified on 15.205(a), then the 15.209(a) limit in the table below has to be followed.

Frequencies (MHz)	Field Strength (micorvolts/meter)	Measurement Distance (meters)
0.009~0.490	2400/F(KHz)	300
0.490~1.705	24000/F(KHz)	30
1.705~30.0	30	30
30~88	100	3
88~216	150	3
216~960	200	3
Above 960	500	3

LIMITS OF RADIATED EMISSION MEASUREMENT (Above 1000MHz)

FREQUENCY (MHz)	Limit (dBuV/m) (at 3M)	
	PEAK	AVERAGE
Above 1000	74	54

Notes:

- (1) The limit for radiated test was performed according to FCC PART 15C.
- (2) The tighter limit applies at the band edges.
- (3) Emission level (dBuV/m)=20log Emission level (uV/m).

Spectrum Parameter	Setting
Attenuation	Auto
Start Frequency	1000 MHz
Stop Frequency	10th carrier harmonic
RB / VB (emission in restricted band)	1 MHz / 1 MHz for Peak, 1 MHz / 10Hz for Average

Receiver Parameter	Setting
Attenuation	Auto
Start ~ Stop Frequency	9kHz~150kHz / RB 200Hz for QP
Start ~ Stop Frequency	150kHz~30MHz / RB 9kHz for QP
Start ~ Stop Frequency	30MHz~1000MHz / RB 120kHz for QP

5.2.2 TEST PROCEDURE

- a. The measuring distance of at 3 m shall be used for measurements at frequency up to 1GHz. For frequencies above 1GHz, any suitable measuring distance may be used.
- b. The EUT was placed on the top of a rotating table 0.8 meters above the ground at a 3 meter open area test site. The table was rotated 360 degrees to determine the position of the highest radiation.
- c. The height of the equipment or of the substitution antenna shall be 0.8 m; the height of the test antenna shall vary between 1 m to 4 m. Both horizontal and vertical polarizations of the antenna are set to make the measurement.
- d. The initial step in collecting conducted emission data is a spectrum analyzer peak detector mode pre-scanning the measurement frequency range. Significant peaks are then marked and then Quasi Peak detector mode re-measured.
- e. If the Peak Mode measured value compliance with and lower than Quasi Peak Mode Limit, the EUT shall be deemed to meet QP Limits and then no additional QP Mode measurement performed.
- f. For the actual test configuration, please refer to the related Item –EUT Test Photos.

Note:

Both horizontal and vertical antenna polarities were tested and performed pretest to three orthogonal axis. The worst case emissions were reported

5.2.3 DEVIATION FROM TEST STANDARD

No deviation

5.2.4 TEST SETUP

(A) Radiated Emission Test-Up Frequency Below 30MHz

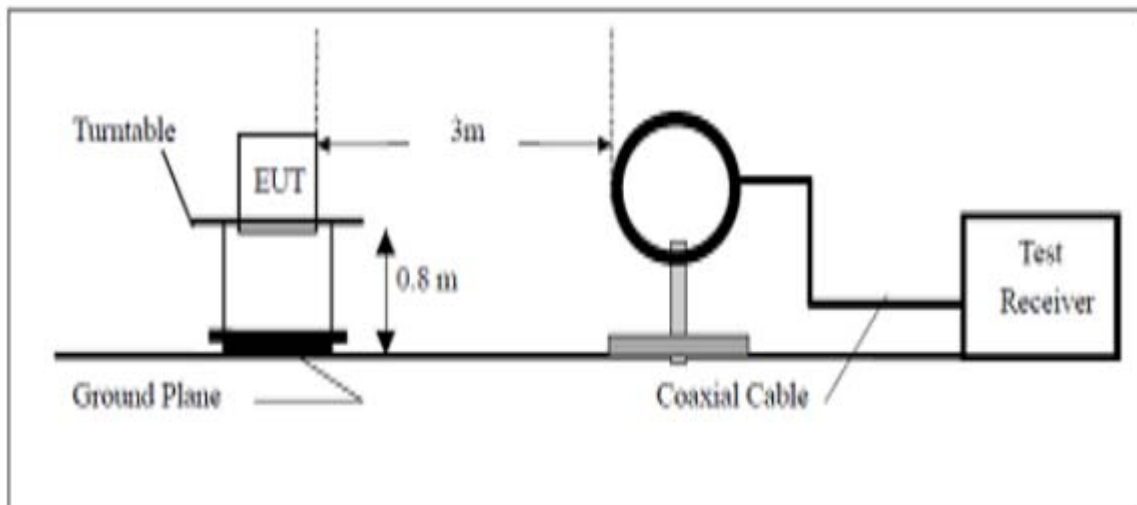

(B) Radiated Emission Test-Up Frequency 30MHz~1GHz

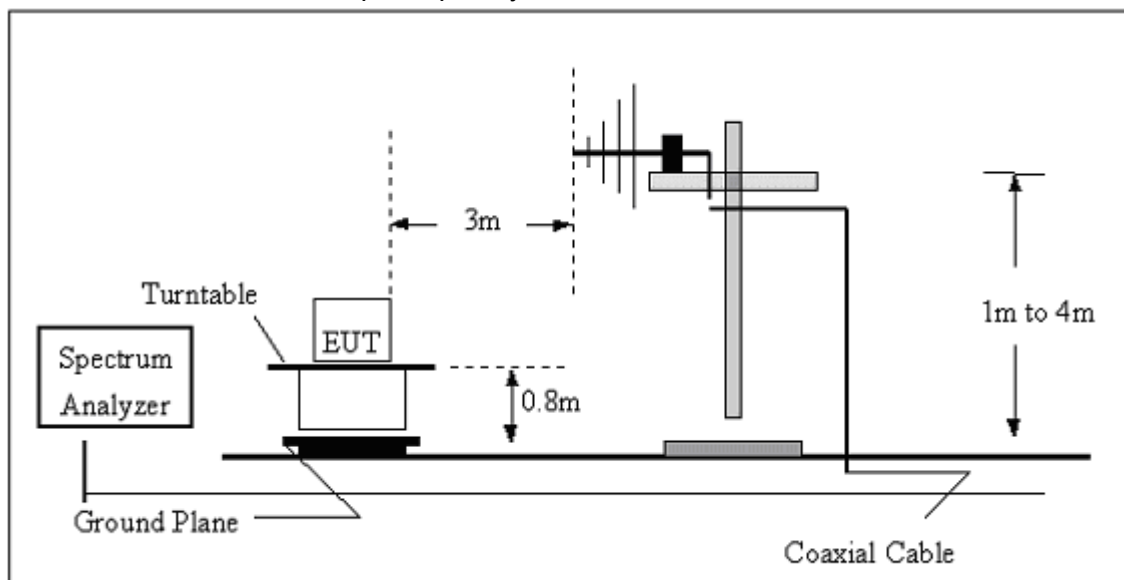

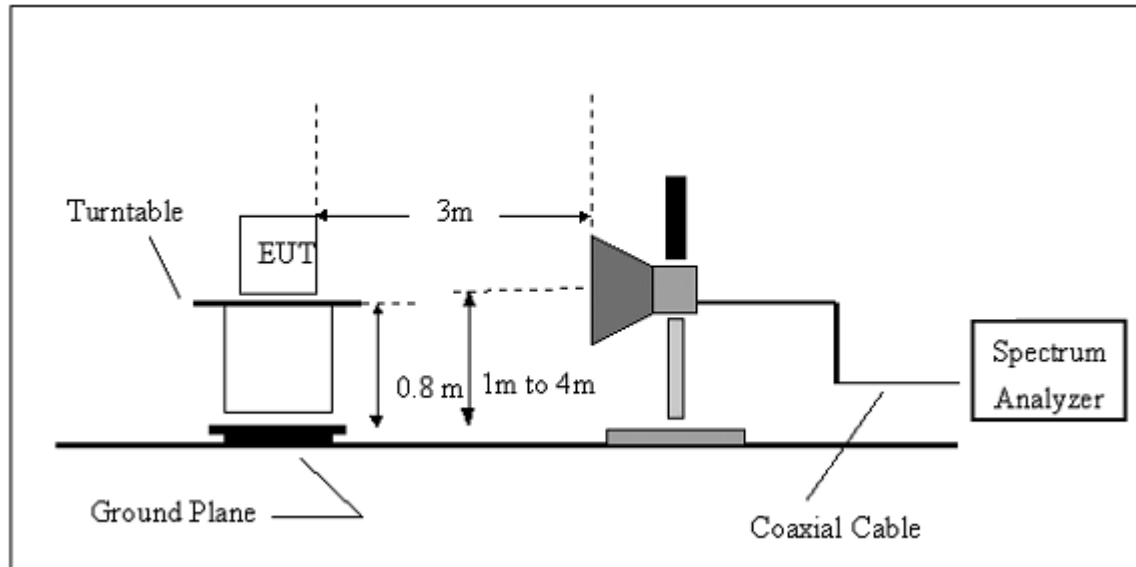
(C) Radiated Emission Test-Up Frequency Above 1GHz**5.2.5 EUT OPERATING CONDITIONS**

The EUT tested system was configured as the statements of 2.4 Unless otherwise a special operating condition is specified in the follows during the testing.

5.2.5.1 RESULTS (BELOW 30 MHZ)

EUT	In-ear Bluetooth stereo headphone	Model Name	BT-588C
Temperature	20 °C	Relative Humidity	48%
Pressure	1010 hPa	Polarization	---
Test Mode	Mode 1/ Mode 2/ Mode 3	Test Date	December 21, 2015

Freq.	Reading	Limit	Margin	State
(MHz)	(dBuV/m)	(dBuV/m)	(dB)	P/F
--	--	--	--	P
--	--	--	--	P

NOTE:

No result in this part for margin above 20dB.

Distance extrapolation factor = $20 \log (\text{specific distance}/\text{test distance})$ (dB);

Limit line = specific limits (dBuV) + distance extrapolation factor.

All the x/y/z orientation has been investigated, and only worst case is presented in this report.

5.2.5.2 TEST RESULTS (BETWEEN 30M – 1000 MHZ)

EUT	In-ear Bluetooth stereo headphone	Model Name	BT-588C
Temperature	20 °C	Relative Humidity	48%
Pressure	1010 hPa	Polarization :	Horizontal
Test Mode	Mode 1 with GFSK modulation	Test Date	December 21, 2015

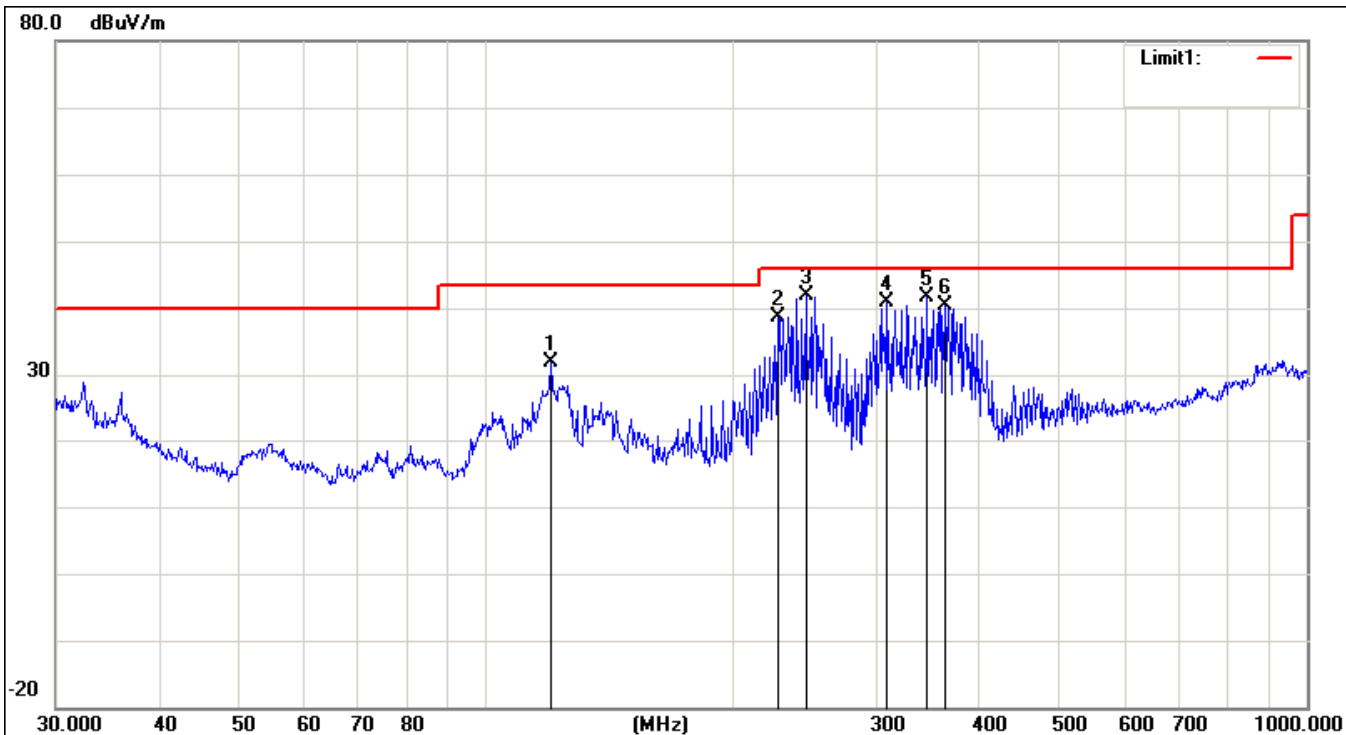

No.	Mk.	Freq.	Reading Level	Correct Factor	Measurement	Limit	Over	
		MHz	dBuV	dB	dBuV/m	dBuV/m	dB	Detector
1		119.8556	34.22	-2.33	31.89	43.50	-11.61	peak
2		227.6906	44.34	-5.80	38.54	46.00	-7.46	peak
3	*	245.9509	48.35	-6.46	41.89	46.00	-4.11	peak
4		308.9126	45.37	-4.47	40.90	46.00	-5.10	peak
5		345.5952	45.88	-4.37	41.51	46.00	-4.49	peak
6		362.9844	44.25	-3.83	40.42	46.00	-5.58	peak

Remark: All the modes have been investigated, and only worst mode is presented in this report.

EUT	In-ear Bluetooth stereo headphone	Model Name	BT-588C
Temperature	20 °C	Relative Humidity	48%
Pressure	1010 hPa	Polarization :	Vertical
Test Mode	Mode 1 with GFSK modulation	Test Date	December 21, 2015

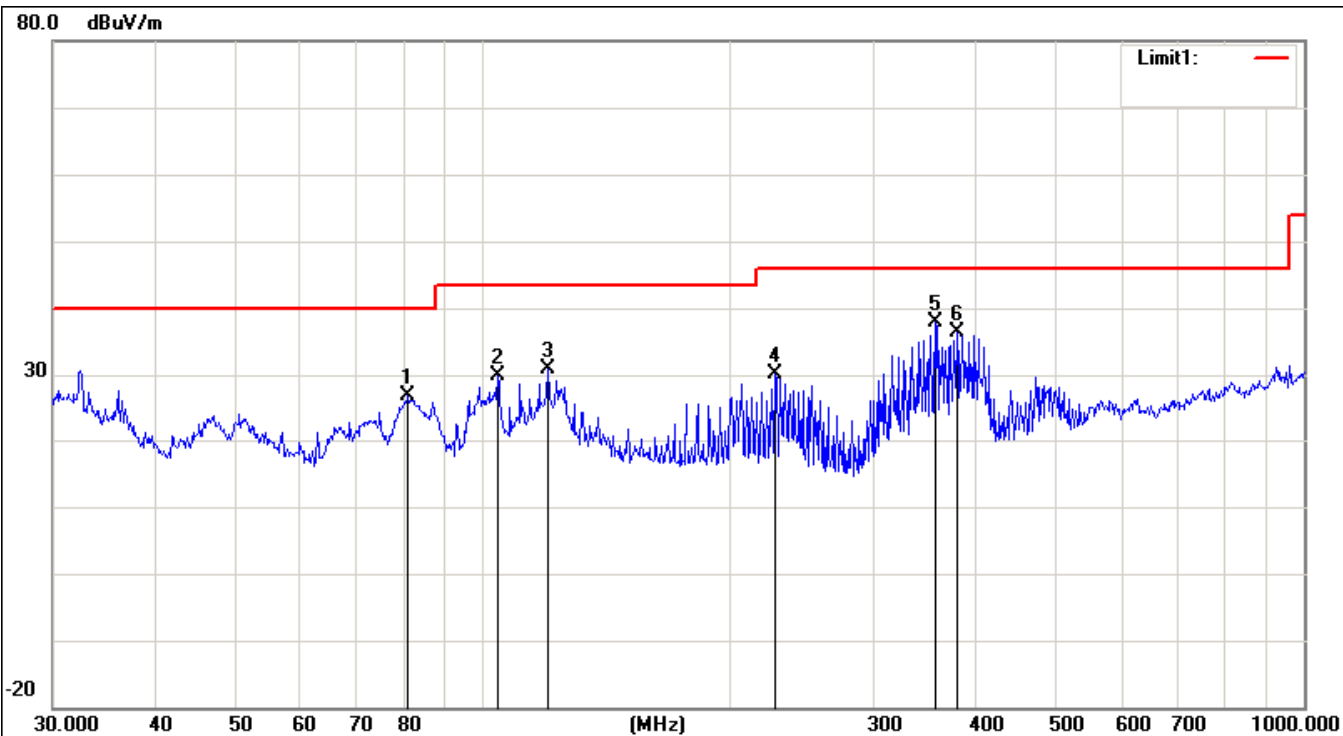

No.	Mk.	Freq. MHz	Reading Level dBuV	Correct Factor dB	Measure- ment dBuV/m	Limit dBuV/m	Over dB	Detector
1		80.9275	34.60	-7.79	26.81	40.00	-13.19	peak
2		104.1701	35.16	-5.18	29.98	43.50	-13.52	peak
3		119.8556	33.31	-2.33	30.98	43.50	-12.52	peak
4		227.6906	35.82	-5.80	30.02	46.00	-15.98	peak
5	*	356.6758	41.88	-4.02	37.86	46.00	-8.14	peak
6		378.5843	39.65	-3.34	36.31	46.00	-9.69	peak

Remark: All the modes have been investigated, and only worst mode is presented in this report.

5.2.5.3 TEST RESULTS(1GHZ TO 25GHZ)

Note: *the worst case is 1Mbps(GFSK)mode as result in this part.*

EUT	In-ear Bluetooth stereo headphone	Model Name	BT-588C
Temperature	20 °C	Relative Humidity	48%
Pressure	1010 hPa	Test Mode	Mode 1 TX(1Mbps)
Test Date	December 21, 2015		

Freq. (MHz)	Ant. Pol.	Emission Level(dBuV)		Limit 3m(dBuV/m)		Over(dB)	
		PK	AV	PK	AV	PK	AV
4804	V	59.59	39.86	74	54	-14.41	-14.14
7206	V	58.55	39.99	74	54	-15.45	-14.01
4804	H	58.17	40.06	74	54	-15.83	-13.94
7206	H	58.94	39.94	74	54	-15.06	-14.06

Remark:

All emissions not reported were more than 20dB below the specified limit or in the noise floor.
All the x/y/z orientation has been investigated, and only worst case is presented in this report.

EUT	In-ear Bluetooth stereo headphone	Model Name	BT-588C
Temperature	20 °C	Relative Humidity	48%
Pressure	1010 hPa	Test Mode	Mode 2 TX(1Mbps)
Test Date	December 21, 2015		

Freq. (MHz)	Ant.Pol.	Emission Level(dBuV)		Limit 3m(dBuV/m)		Over(dB)	
		PK	AV	PK	AV	PK	AV
4882	V	58.19	41.83	74	54	-15.81	-12.17
7323	V	59.89	40.59	74	54	-14.11	-13.41
4882	H	58.58	40.41	74	54	-15.42	-13.59
7323	H	59.88	40.88	74	54	-14.12	-13.12

Remark:

All emissions not reported were more than 20dB below the specified limit or in the noise floor.
All the x/y/z orientation has been investigated, and only worst case is presented in this report.

EUT	In-ear Bluetooth stereo headphone	Model Name	BT-588C
Temperature	20 °C	Relative Humidity	48%
Pressure	1010 hPa	Test Mode	Mode 3 TX(1Mbps)
Test Date	December 21, 2015		

Freq. (MHz)	Ant.Pol.	Emission Level(dBuV)		Limit 3m(dBuV/m)		Over(dB)	
		PK	AV	PK	AV	PK	AV
4960	V	60.43	39.90	74	54	-13.57	-14.10
7440	V	59.79	39.92	74	54	-14.21	-14.08
4960	H	59.00	40.01	74	54	-15.00	-13.99
7440	H	58.41	39.41	74	54	-15.59	-14.59

Remark:

All emissions not reported were more than 20dB below the specified limit or in the noise floor.
All the x/y/z orientation has been investigated, and only worst case is presented in this report.

5.2.5.4 TEST RESULTS (Restricted Bands Requirements)

Test result for 1Mbps Mode:

EUT	In-ear Bluetooth stereo headphone	Model Name	BT-588C
Temperature	20 °C	Relative Humidity	48%
Pressure	1010 hPa	Test Date	December 21, 2015
Test Mode	TX /Mode1-1Mbps	Polarization	Vertical

Frequency	Meter Reading	Factor	Emission Level	Limits	Margin	Detector Type
(MHz)	(dBμV)	(dB)	(dBμV/m)	(dBμV/m)	(dB)	
2382	60.07	-8.76	51.31	74	22.69	peak
2382	53.25	-8.76	44.49	54	9.51	AVG
2390	59.90	-8.73	51.17	74	22.83	peak
2390	54.85	-8.73	46.12	54	7.88	AVG

Remark:

Factor = Antenna Factor + Cable Loss – Pre-amplifier.

All the x/y/z orientation has been investigated, and only worst case is presented in this report.

EUT	In-ear Bluetooth stereo headphone	Model Name	BT-588C
Temperature	20 °C	Relative Humidity	48%
Pressure	1010 hPa	Test Date	December 21, 2015
Test Mode	TX /2402MHz-1Mbps	Polarization	Horizontal

Frequency	Meter Reading	Factor	Emission Level	Limits	Margin	Detector Type
(MHz)	(dBμV)	(dB)	(dBμV/m)	(dBμV/m)	(dB)	
2376	64.29	-8.76	55.53	74	18.47	peak
2376	53.22	-8.76	44.46	54	9.54	AVG
2390	60.47	-8.73	51.74	74	22.26	peak
2390	56.17	-8.73	47.44	54	6.56	AVG

Remark:

Factor = Antenna Factor + Cable Loss – Pre-amplifier.

All the x/y/z orientation has been investigated, and only worst case is presented in this report.

EUT	In-ear Bluetooth stereo headphone	Model Name	BT-588C
Temperature	20 °C	Relative Humidity	48%
Pressure	1010 hPa	Test Date	December 21, 2015
Test Mode	TX /2480MHz-1Mbps	Polarization	Vertical

Frequency	Meter Reading	Factor	Emission Level	Limits	Margin	Detector Type
(MHz)	(dB μ V)	(dB)	(dB μ V/m)	(dB μ V/m)	(dB)	
2483.5	62.78	-8.17	54.61	74	19.39	peak
2483.5	54.68	-8.17	46.51	54	7.49	AVG

Remark:

Factor = Antenna Factor + Cable Loss – Pre-amplifier.

All the x/y/z orientation has been investigated, and only worst case is presented in this report.

EUT	In-ear Bluetooth stereo headphone	Model Name	BT-588C
Temperature	20 °C	Relative Humidity	48%
Pressure	1010 hPa	Test Date	December 21, 2015
Test Mode	TX /2480MHz-1Mbps	Polarization	Horizontal

Frequency	Meter Reading	Factor	Emission Level	Limits	Margin	Detector Type
(MHz)	(dB μ V)	(dB)	(dB μ V/m)	(dB μ V/m)	(dB)	
2483.5	63.93	-8.17	55.76	74	18.24	peak
2483.5	54.01	-8.17	45.84	54	8.16	AVG

Remark:

Factor = Antenna Factor + Cable Loss – Pre-amplifier.

All the x/y/z orientation has been investigated, and only worst case is presented in this report.

Test result for 3Mbps Mode:

EUT	In-ear Bluetooth stereo headphone	Model Name	BT-588C
Temperature	20 °C	Relative Humidity	48%
Pressure	1010 hPa	Test Date	December 21, 2015
Test Mode	TX /2402MHz-3Mbps	Polarization	Vertical

Frequency	Meter Reading	Factor	Emission Level	Limits	Margin	Detector Type
(MHz)	(dB μ V)	(dB)	(dB μ V/m)	(dB μ V/m)	(dB)	
2387	63.51	-8.76	54.75	74	19.25	peak
2387	56.03	-8.76	47.27	54	6.73	AVG
2390	61.03	-8.73	52.30	74	21.70	peak
2390	54.52	-8.73	45.79	54	8.21	AVG

Remark:

Factor = Antenna Factor + Cable Loss – Pre-amplifier.

All the x/y/z orientation has been investigated, and only worst case is presented in this report.

EUT	In-ear Bluetooth stereo headphone	Model Name	BT-588C
Temperature	20 °C	Relative Humidity	48%
Pressure	1010 hPa	Test Date	December 21, 2015
Test Mode	TX /2402MHz-3Mbps	Polarization	Horizontal

Frequency	Meter Reading	Factor	Emission Level	Limits	Margin	Detector Type
(MHz)	(dB μ V)	(dB)	(dB μ V/m)	(dB μ V/m)	(dB)	
2384	61.91	-8.76	53.15	74	20.85	peak
2384	55.97	-8.76	47.21	54	6.79	AVG
2390	61.35	-8.73	52.62	74	21.38	peak
2390	54.83	-8.73	46.10	54	7.90	AVG

Remark:

Factor = Antenna Factor + Cable Loss – Pre-amplifier.

All the x/y/z orientation has been investigated, and only worst case is presented in this report.

EUT	In-ear Bluetooth stereo headphone	Model Name	BT-588C
Temperature	20 °C	Relative Humidity	48%
Pressure	1010 hPa	Test Date	December 21, 2015
Test Mode	TX /2480MHz-3Mbps	Polarization	Vertical

Frequency	Meter Reading	Factor	Emission Level	Limits	Margin	Detector Type
(MHz)	(dBμV)	(dB)	(dBμV/m)	(dBμV/m)	(dB)	
2483.5	60.52	-8.17	52.35	74	21.65	peak
2483.5	53.81	-8.17	45.64	54	8.36	AVG

Remark:

Factor = Antenna Factor + Cable Loss – Pre-amplifier.

All the x/y/z orientation has been investigated, and only worst case is presented in this report.

EUT	In-ear Bluetooth stereo headphone	Model Name	BT-588C
Temperature	20 °C	Relative Humidity	48%
Pressure	1010 hPa	Test Date	December 21, 2015
Test Mode	TX /2480MHz-3Mbps	Polarization	Horizontal

Frequency	Meter Reading	Factor	Emission Level	Limits	Margin	Detector Type
(MHz)	(dBμV)	(dB)	(dBμV/m)	(dBμV/m)	(dB)	
2483.5	60.67	-8.17	52.50	74	21.50	peak
2483.5	54.15	-8.17	45.98	54	8.02	AVG

Remark:

Factor = Antenna Factor + Cable Loss – Pre-amplifier.

All the x/y/z orientation has been investigated, and only worst case is presented in this report.

Test result for hopping mode:

EUT	In-ear Bluetooth stereo headphone	Model Name	BT-588C
Temperature	20 °C	Relative Humidity	48%
Pressure	1010 hPa	Test Date	December 21, 2015
Test Mode	hopping mode-1Mbps	Polarization	Vertical

Frequency (MHz)	Meter Reading (dB μ V)	Factor (dB)	Emission Level (dB μ V/m)	Limits (dB μ V/m)	Margin (dB)	Detector Type
2381	61.42	-8.76	52.66	74	21.34	peak
2381	54.21	-8.76	45.45	54	8.55	AVG
2390	62.61	-8.73	53.88	74	20.12	peak
2390	54.77	-8.73	46.04	54	7.96	AVG

Remark:

Factor = Antenna Factor + Cable Loss – Pre-amplifier.

All the x/y/z orientation has been investigated, and only worst case is presented in this report.

EUT	In-ear Bluetooth stereo headphone	Model Name	BT-588C
Temperature	20 °C	Relative Humidity	48%
Pressure	1010 hPa	Test Date	January 21, 2015
Test Mode	Hopping mode-1Mbps	Polarization	Horizontal

Frequency (MHz)	Meter Reading (dB μ V)	Factor (dB)	Emission Level (dB μ V/m)	Limits (dB μ V/m)	Margin (dB)	Detector Type
2378	64.51	-8.76	55.75	74	18.25	peak
2378	53.54	-8.76	44.78	54	9.22	AVG
2390	63.91	-8.73	55.18	74	18.82	peak
2390	56.90	-8.73	48.17	54	5.83	AVG

Remark:

Factor = Antenna Factor + Cable Loss – Pre-amplifier.

All the x/y/z orientation has been investigated, and only worst case is presented in this report.

EUT	In-ear Bluetooth stereo headphone	Model Name	BT-588C
Temperature	20 °C	Relative Humidity	48%
Pressure	1010 hPa	Test Date	December 21, 2015
Test Mode	Hopping mode-1Mbps	Polarization	Vertical

Frequency	Meter Reading	Factor	Emission Level	Limits	Margin	Detector Type
(MHz)	(dB μ V)	(dB)	(dB μ V/m)	(dB μ V/m)	(dB)	
2483.5	62.35	-8.17	54.18	74	19.82	peak
2483.5	54.73	-8.17	46.56	54	7.44	AVG

Remark:

Factor = Antenna Factor + Cable Loss – Pre-amplifier.

All the x/y/z orientation has been investigated, and only worst case is presented in this report.

EUT	In-ear Bluetooth stereo headphone	Model Name	BT-588C
Temperature	20 °C	Relative Humidity	48%
Pressure	1010 hPa	Test Date	December 21, 2015
Test Mode	Hopping mode-1Mbps	Polarization	Horizontal

Frequency	Meter Reading	Factor	Emission Level	Limits	Margin	Detector Type
(MHz)	(dB μ V)	(dB)	(dB μ V/m)	(dB μ V/m)	(dB)	
2483.5	61.48	-8.17	53.31	74	20.69	peak
2483.5	53.12	-8.17	44.95	54	9.05	AVG

Remark:

Factor = Antenna Factor + Cable Loss – Pre-amplifier.

All the x/y/z orientation has been investigated, and only worst case is presented in this report.

6. NUMBER OF HOPPING CHANNEL**6.1 APPLIED PROCEDURES / LIMIT**

FCC Part15 (15.247) , Subpart C				
Section	Test Item	Limit	Frequency Range (MHz)	Result
15.247 (a)(1)(iii)	Number of Hopping Channel	≥15	2400-2483.5	PASS

Spectrum Parameters	Setting
Attenuation	Auto
Span Frequency	> Operating Frequency Range
RB	1MHz
VB	3MHz
Detector	Peak
Trace	Max Hold
Sweep Time	Auto

6.2 TEST PROCEDURE

- a. The EUT was directly connected to the spectrum analyzer and antenna output port as show in the block diagram below,
- b. Spectrum Setting: RBW= 1MHz, VBW=3MHz, Sweep time = Auto.

6.3 DEVIATION FROM STANDARD

No deviation.

6.4 TEST SETUP**6.5 EUT OPERATION CONDITIONS**

The EUT tested system was configured as the statements of 2.4 Unless otherwise a special operating condition is specified in the follows during the testing.

6.6 TEST RESULTS

EUT	In-ear Bluetooth stereo headphone	Model Name	BT-588C
Temperature	25 °C	Relative Humidity	60%
Pressure	1015 hPa	Test Date	December 22, 2015
Test Mode	Hopping Mode	Number of Hopping Channel	79

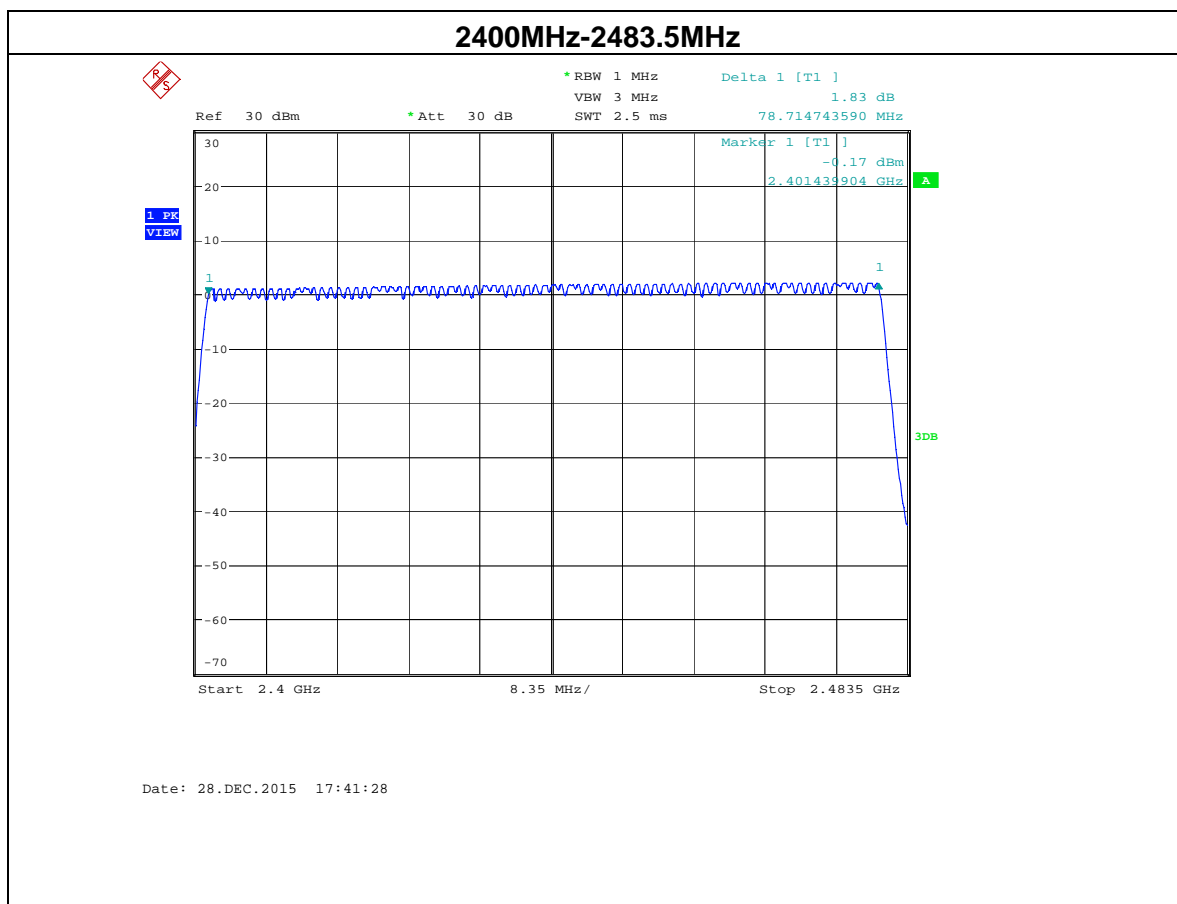

7. AVERAGE TIME OF OCCUPANCY**7.1 APPLIED PROCEDURES / LIMIT**

FCC Part15 (15.247) , Subpart C				
Section	Test Item	Limit	Frequency Range (MHz)	Result
15.247 (a)(1)(iii)	Average Time of Occupancy	0.4sec	2400-2483.5	PASS

7.2 TEST PROCEDURE

- a. The EUT test port was connected to the spectrum analyzer with RF cable and antenna connector.
- b. Set RBW of spectrum analyzer to 1MHz and VBW to 3MHz.
- c. Use a video trigger with the trigger level set to enable triggering only on full pulses.
- d. Sweep Time is more than once pulse time.
- e. Set the center frequency on any frequency would be measure and set the frequency span to zero span.
- f. Measure the maximum time duration of one single pulse.
- g. Set the EUT for DH5, DH3 and DH1 packet transmitting.
- h. Measure the maximum time duration of one single pulse.
- i. DH1 Dwell time = Pulse time*(1600/2/79)*31.6S
DH3 Dwell time = Pulse time*(1600/4/79)*31.6S
DH5 Dwell time = Pulse time*(1600/6/79)*31.6S

7.3 DEVIATION FROM STANDARD

No deviation.

7.4 TEST SETUP

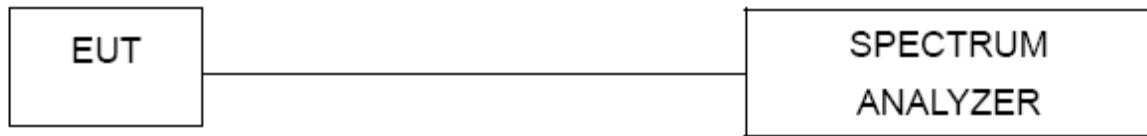

7.5 EUT OPERATION CONDITIONS

The EUT tested system was configured as the statements of 2.4 Unless otherwise a special operating condition is specified in the follows during the testing.

7.6 TEST RESULTS

Note: *the worst case is DH-3Mbps as result in this part.*

EUT	In-ear Bluetooth stereo headphone	Model Name	BT-588C
Temperature	25 °C	Relative Humidity	60%
Pressure	1012 hPa	Test Date	December 22, 2015
Test Mode	DH5-1Mbps		

Data Packet	Frequency	Pulse time(ms)	Dwell Time(S)	Limits (S)
DH5	2402MHz	2.772	0.296	0.4
DH5	2441MHz	1.314	0.140	0.4
DH5	2480MHz	3.253	0.347	0.4

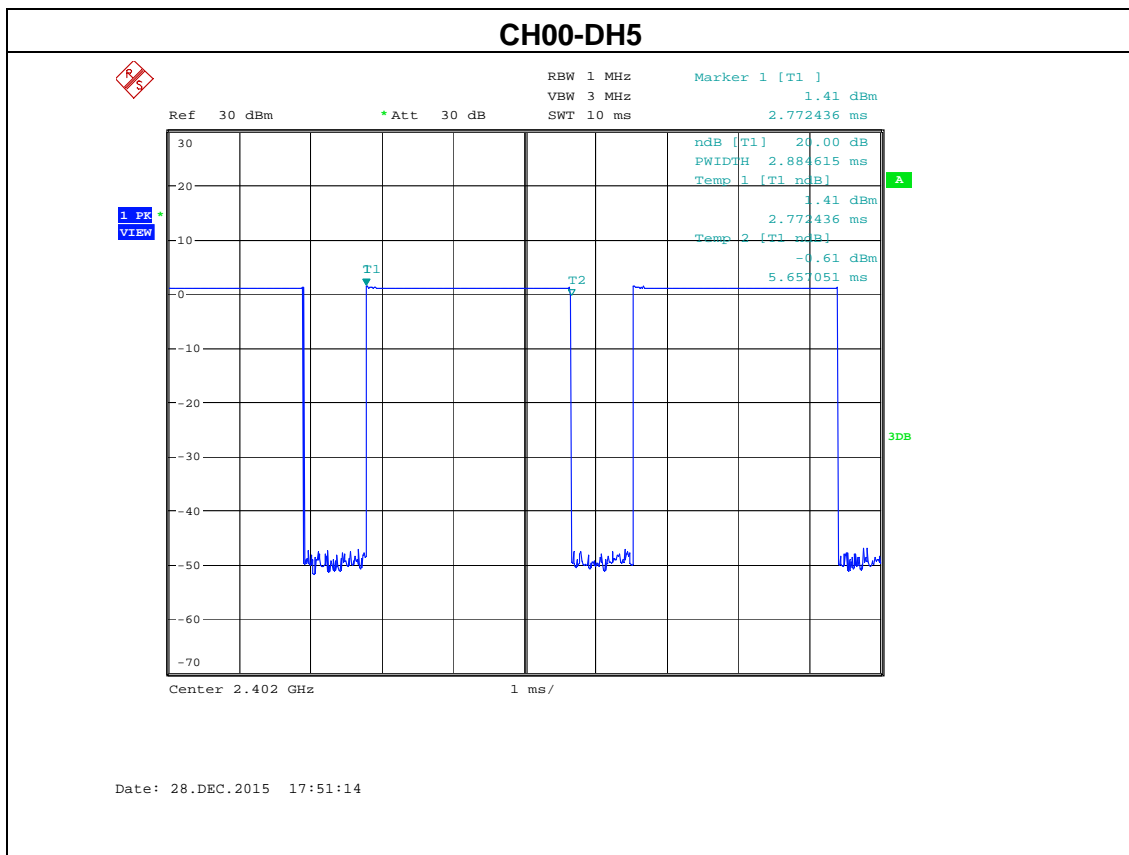

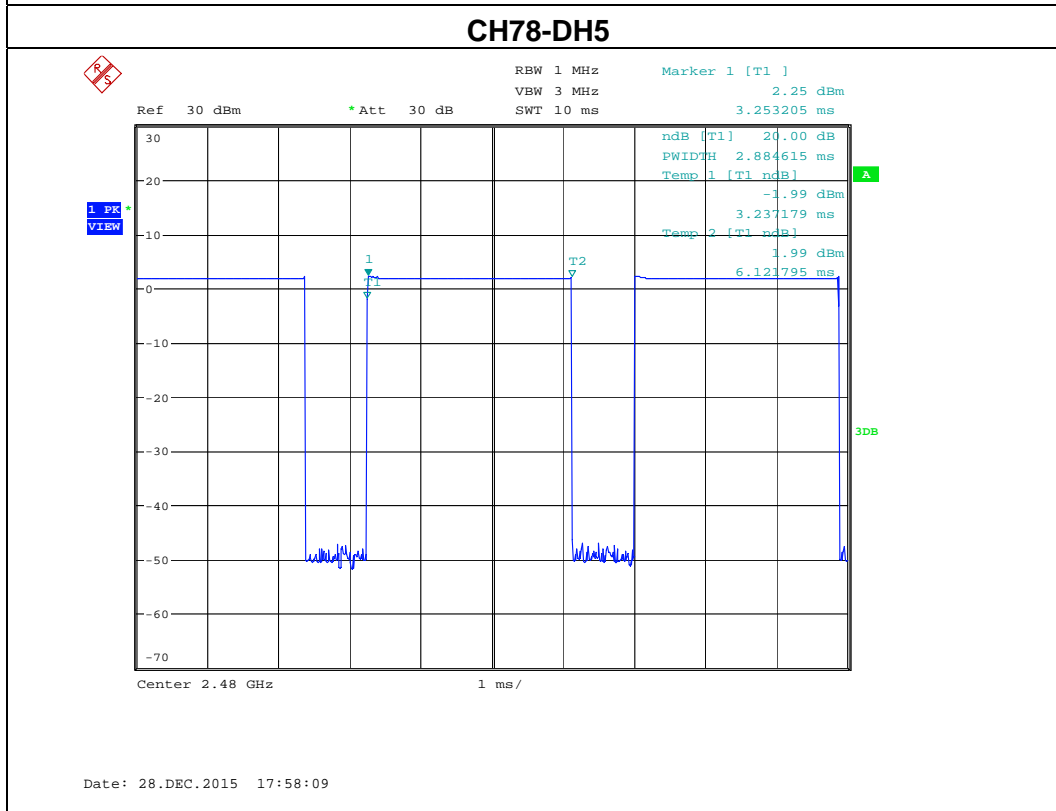
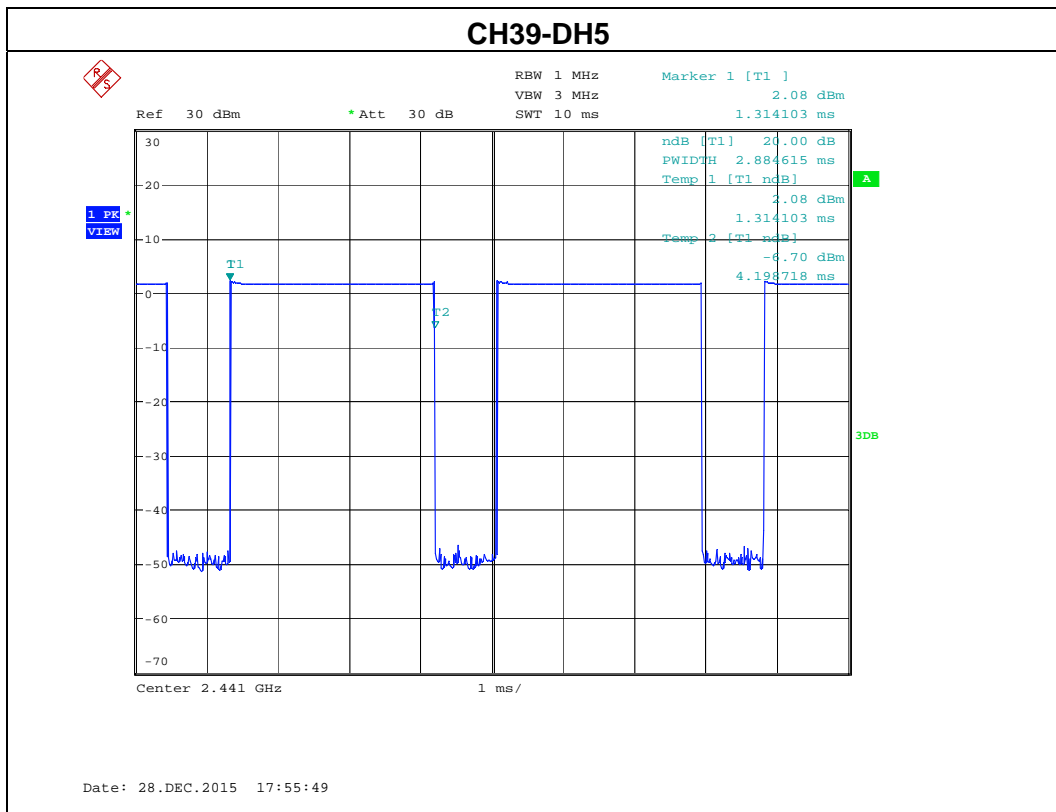

8. HOPPING CHANNEL SEPARATION MEASUREMENT

8.1 APPLIED PROCEDURES / LIMIT

Frequency hopping systems operating in the 2400-2483.5 MHz band may have hopping channel carrier frequencies that are separated by 25 kHz or two-thirds of the 20 dB bandwidth of the hopping channel, whichever is greater.

Spectrum Parameter	Setting
Attenuation	Auto
Span Frequency	> Measurement Bandwidth or Channel Separation
RB	Resolution (or IF) Bandwidth (RBW) \geq 1% of the span
VB	Video (or Average) Bandwidth (VBW) \geq RBW
Detector	Peak
Trace	Max hold
Sweep Time	Auto

8.2 TEST PROCEDURE

1. Check the calibration of the measuring instrument using either an internal calibrator or a known signal from an external generator.
2. Set the spectrum analyzer as follows: Span = wide enough to capture the peaks of two adjacent channels: Resolution (or IF) Bandwidth (RBW) \geq 1% of the span; Video (or Average) Bandwidth (VBW) \geq RBW; Sweep = auto; Detector function = peak; Trace = max hold
3. Measure the separation between the peaks of the adjacent channels using the marker-delta function.
4. Repeat above procedures until all frequencies measured were complete.

8.3 DEVIATION FROM STANDARD

No deviation.

8.4 TEST SETUP

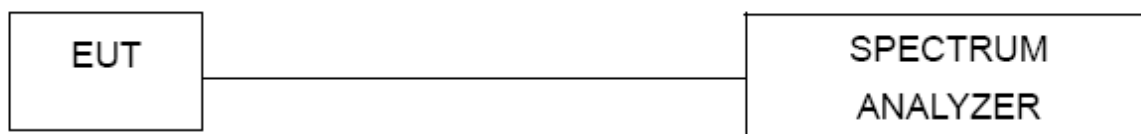

8.5 EUT OPERATION CONDITIONS

The EUT was programmed to be in continuously transmitting mode.

8.6 TEST RESULTS

EUT	In-ear Bluetooth stereo headphone	Model Name	BT-588C
Temperature	25 °C	Relative Humidity	60%
Pressure	1012 hPa	Test Result	Pass
Test Mode	CH00 / CH39 /CH78 (1Mbps Mode)	Test Date	December 22, 2015

Channel number	Channel frequency (MHz)	Separation Read value (KHz)	Separation limit 2/3 20db down BW(KHz)
00	2402	1005	555
39	2441	1005	558
78	2480	1000	558

Note: 20db bandwidth refer to section 6.1.5

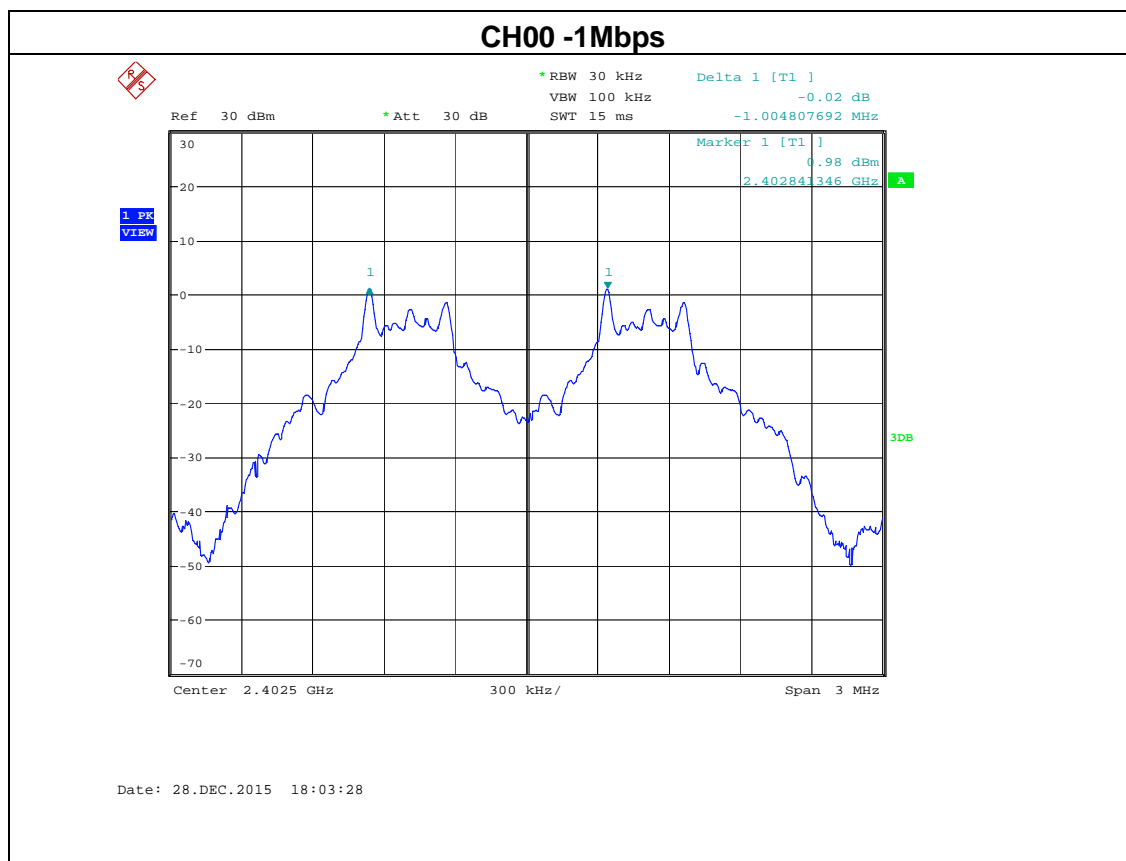

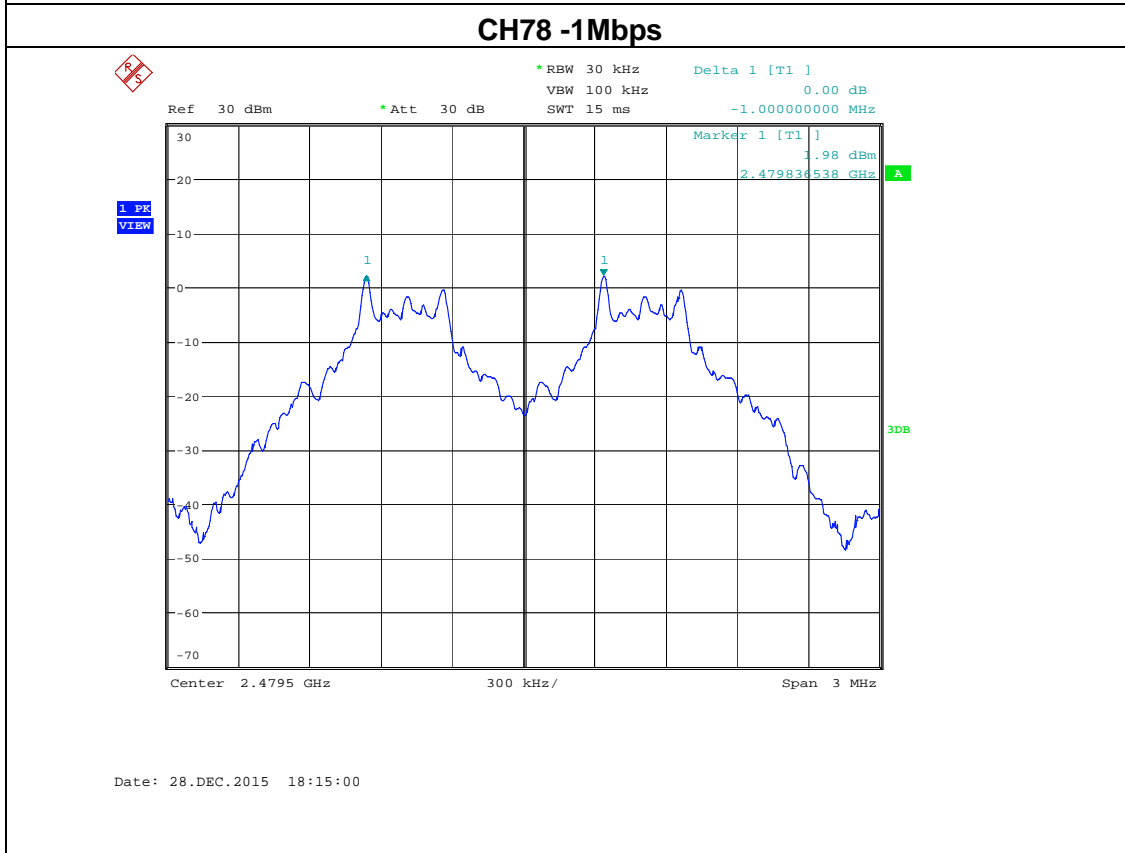
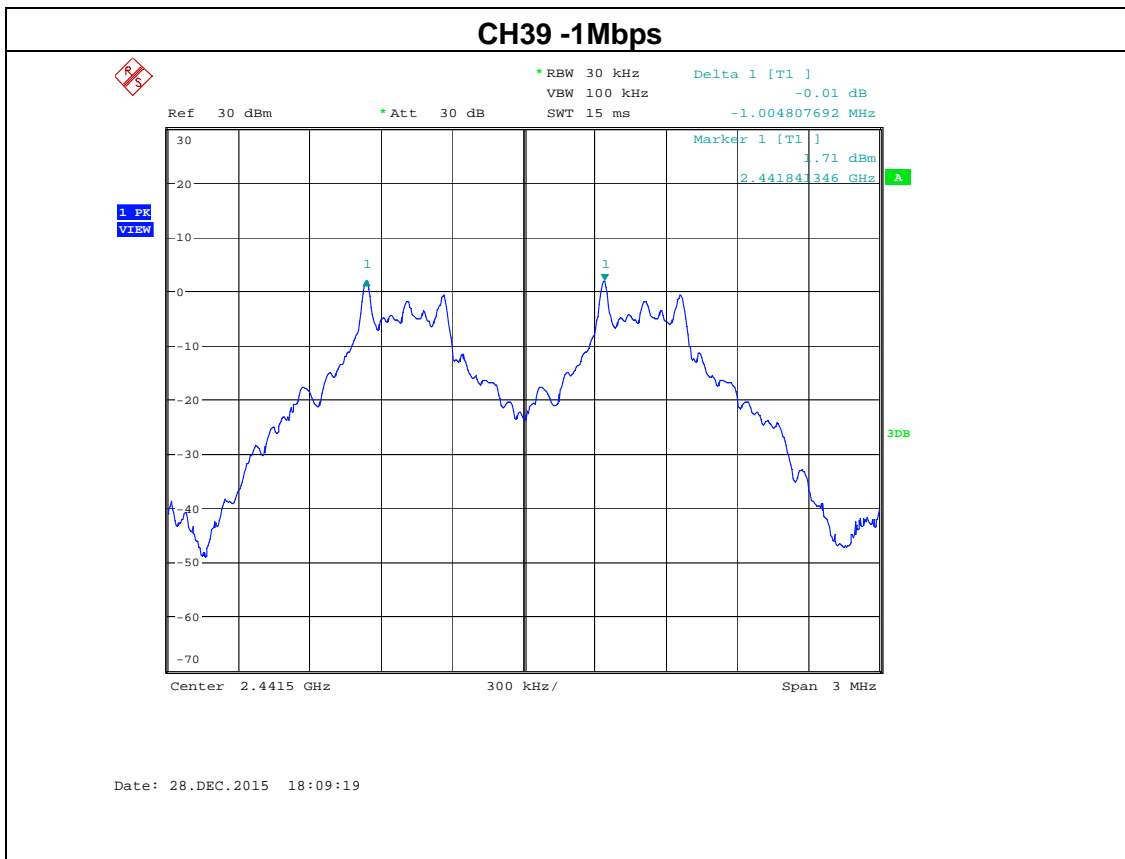

9. BANDWIDTH TEST

9.1 APPLIED PROCEDURES / LIMIT

FCC Part15 (15.247) , Subpart C				
Section	Test Item	Limit	Frequency Range (MHz)	Result
15.247 (a)(1)	Bandwidth	(20dB bandwidth)	2400-2483.5	PASS

Spectrum Parameter	Setting
Attenuation	Auto
Span Frequency	> Measurement Bandwidth or Channel Separation
RB	30kHz
VB	100 kHz
Detector	Peak
Trace	Max hold
Sweep Time	Auto

9.2 TEST PROCEDURE

1. Check the calibration of the measuring instrument (spectrum analyzer) using either an internal calibrator or a known signal from an external generator.
2. Set the spectrum analyzer as follows: VBW =30kHz, RBW=100kHz, Sweep = auto Detector function = peak ,Trace = max hold
3. Measure the highest amplitude appearing on spectral display and record the level to calculate results.
4. Repeat above procedures until all frequencies measured were complete.

9.3 DEVIATION FROM STANDARD

No deviation.

9.4 TEST SETUP



9.5 EUT OPERATION CONDITIONS

The EUT tested system was configured as the statements of 2.4 Unless otherwise a special operating condition is specified in the follows during the testing.

9.6 TEST RESULTS

EUT	In-ear Bluetooth stereo headphone	Model Name	BT-588C
Temperature	25 °C	Relative Humidity	60%
Pressure	1012 hPa	Test Mode	CH00/CH39/C78(1Mbps)
Test Date	December 22, 2015		

Frequency	20dB Bandwidth (kHz)	Result
2402 MHz	836	PASS
2441 MHz	849	PASS
2480 MHz	846	PASS

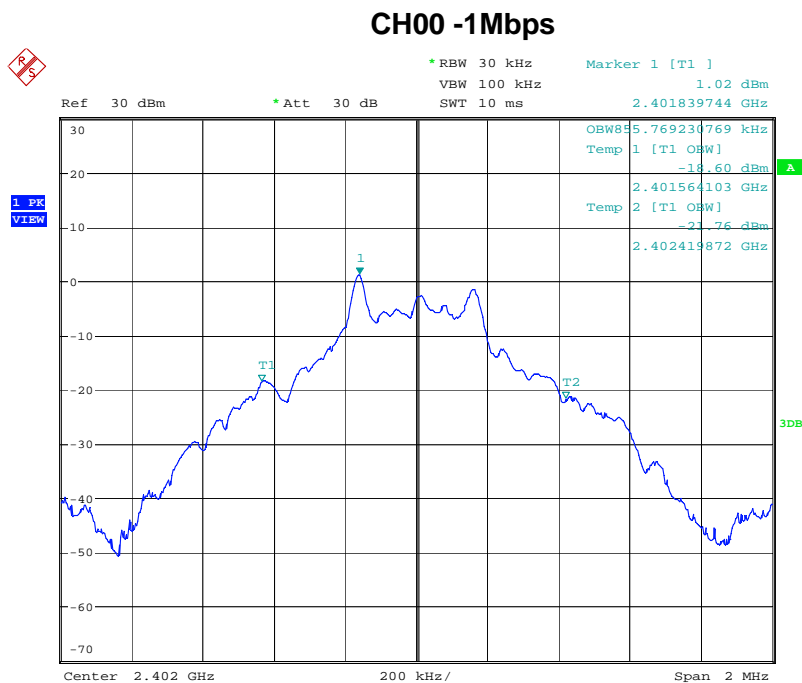

Date: 28.DEC.2015 18:25:20

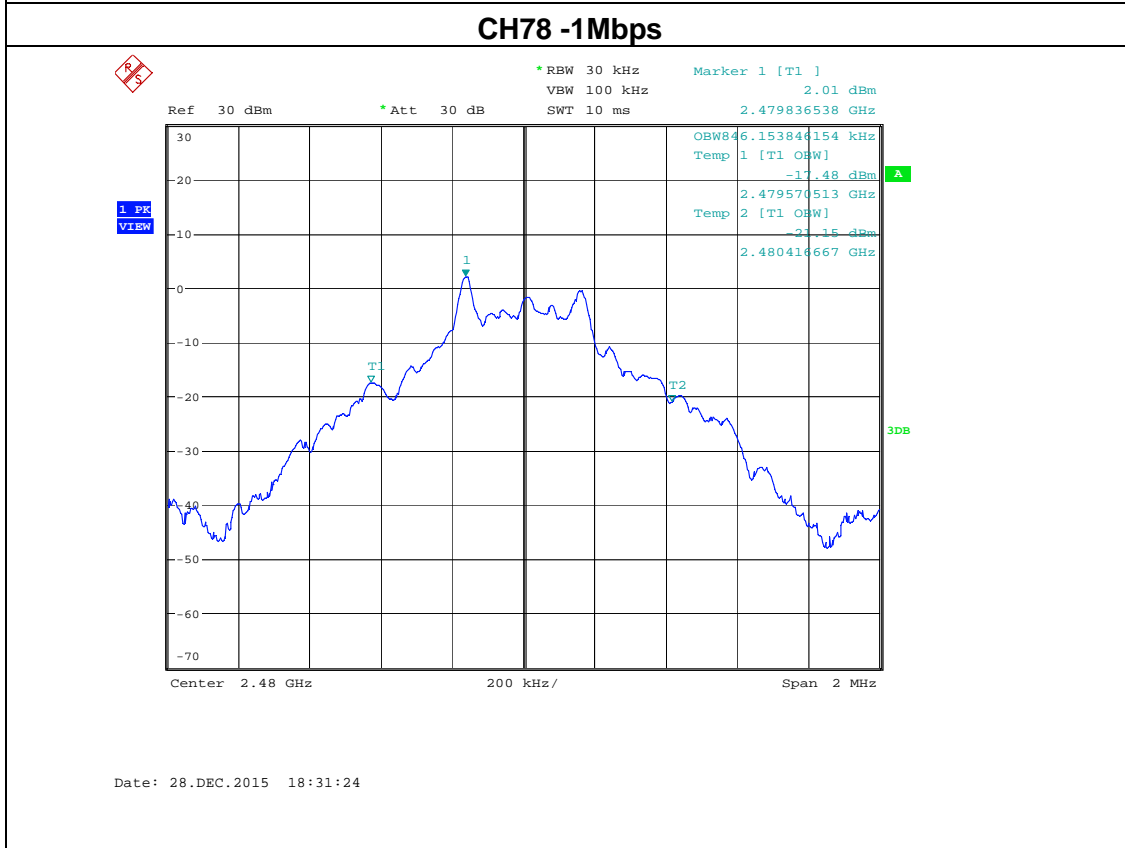
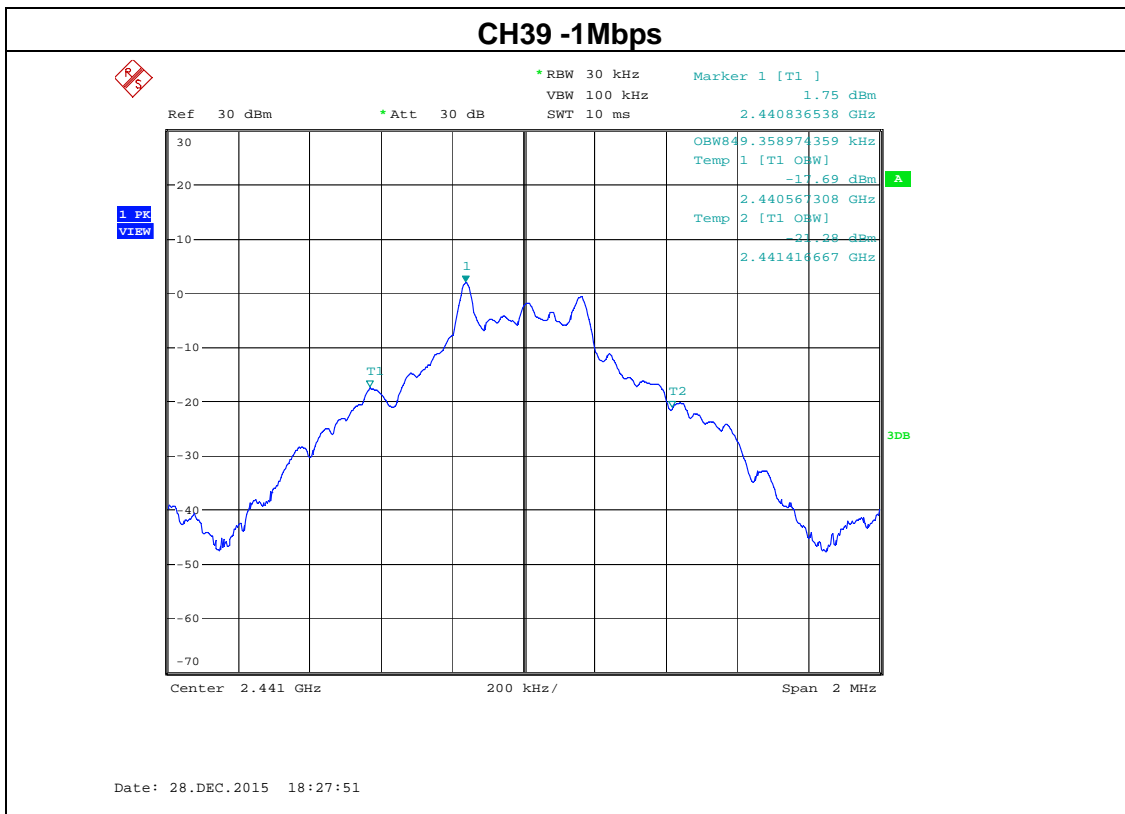

10. PEAK OUTPUT POWER TEST**10.1 APPLIED PROCEDURES / LIMIT**

FCC Part15 (15.247) , Subpart C				
Section	Test Item	Limit	Frequency Range (MHz)	Result
15.247 (b)(i)	Peak Output Power	0.125 w or 20.96dBm	2400-2483.5	PASS

10.2 TEST PROCEDURE

- a. The EUT was directly connected to the power meter and antenna output port as show in the block diagram below,
- b. Setting : RBW \geq the 20 dB bandwidth of the emission being measured
 - Span \geq approximately 3 times the 20 dB bandwidth, centered on a hopping channel
 - VBW \geq RBW
 - Sweep = auto
 - Detector function = peak
 - Trace = max hold

10.3 DEVIATION FROM STANDARD

No deviation.

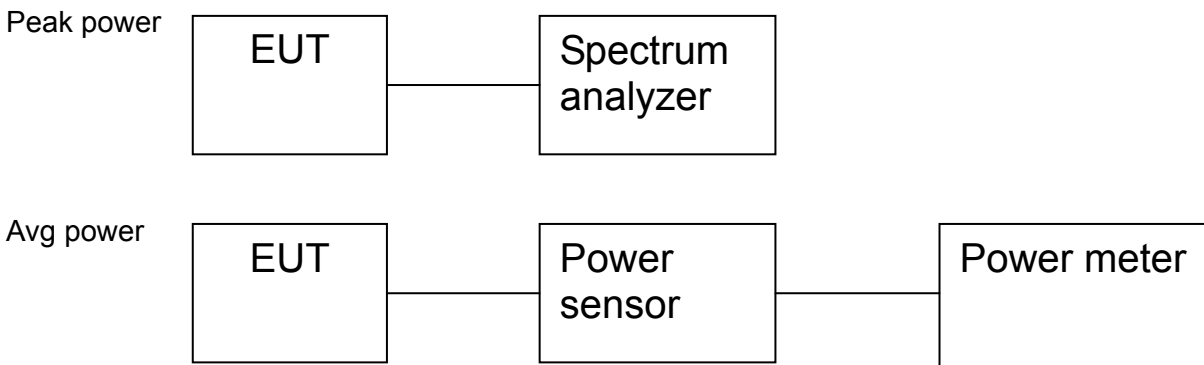
10.4 TEST SETUP**10.5 EUT OPERATION CONDITIONS**

The EUT tested system was configured as the statements of 2.4 Unless otherwise a special operating condition is specified in the follows during the testing.

10.6 TEST RESULTS

EUT	In-ear Bluetooth stereo headphone	Model Name	BT-588C
Temperature	25 °C	Relative Humidity	60%
Pressure	1012 hPa	Test Mode	CH00/ CH39 /CH78 (1M/2M/3Mbps Mode)
Test Date	December 22, 2015		

Test Channel	Frequency (MHz)	Peak Output Power (dBm)	LIMIT(dBm)	Result
1Mbps				
CH00	2402	1.41	20.96	Pass
CH39	2441	2.11	20.96	Pass
CH78	2480	2.36	20.96	Pass
2Mbps				
CH00	2402	-0.32	20.96	Pass
CH39	2441	0.74	20.96	Pass
CH78	2480	1.28	20.96	Pass
3Mbps				
CH00	2402	-0.31	20.96	Pass
CH39	2441	0.75	20.96	Pass
CH78	2480	1.27	20.96	Pass

CH00 -1Mbps

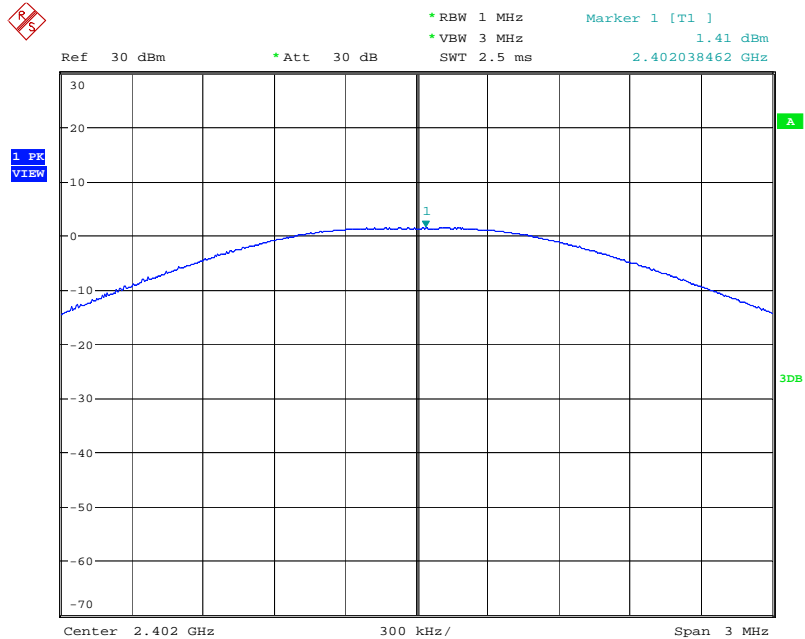

Date: 28.DEC.2015 18:37:07

CH39 -1Mbps

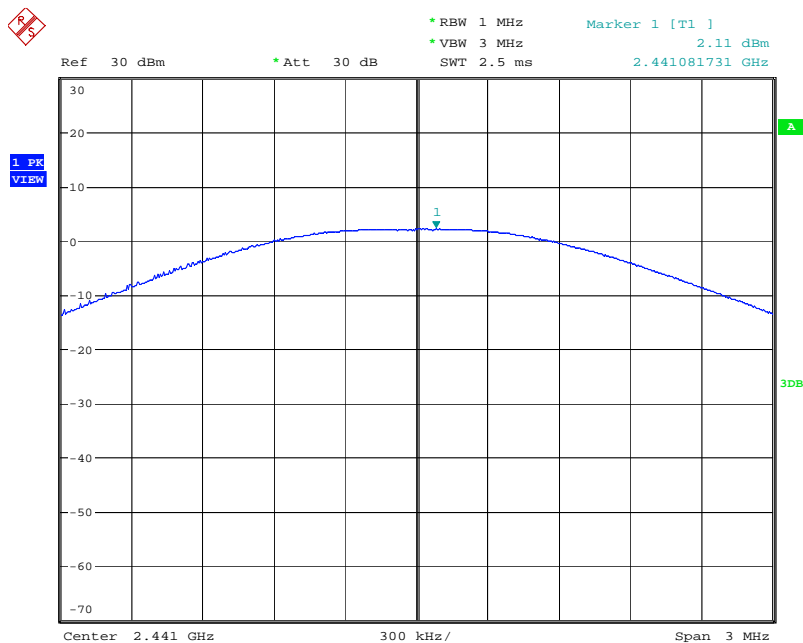

Date: 28.DEC.2015 18:36:20

CH78 -1Mbps

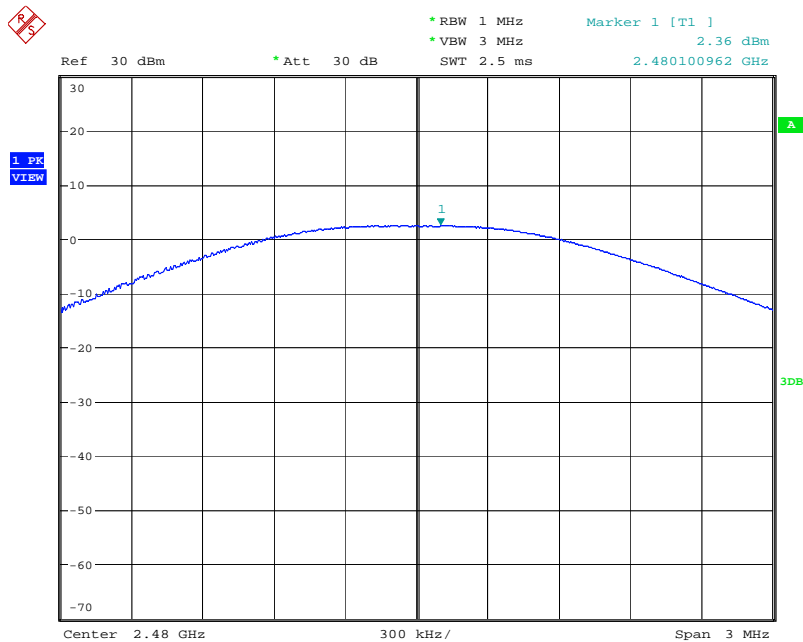

Date: 28.DEC.2015 18:33:54

CH00 -2Mbps

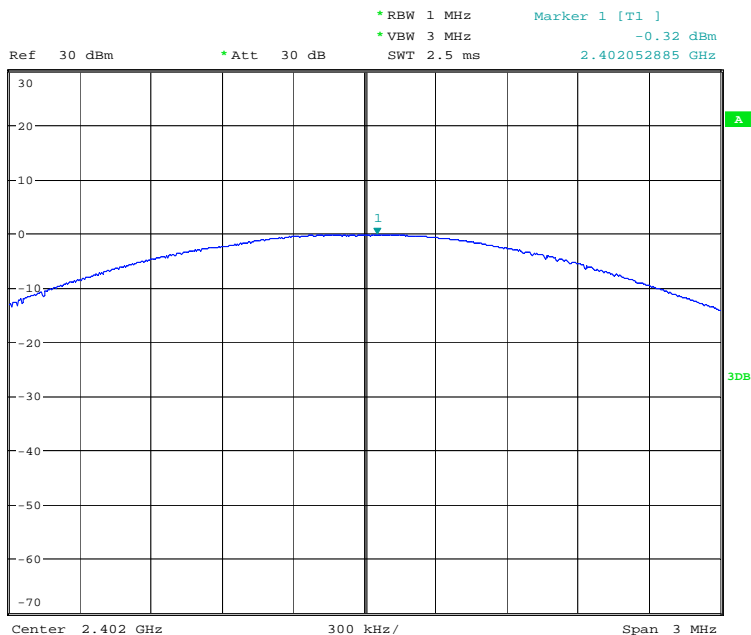

Date: 28.DEC.2015 18:40:16

CH39 -2Mbps

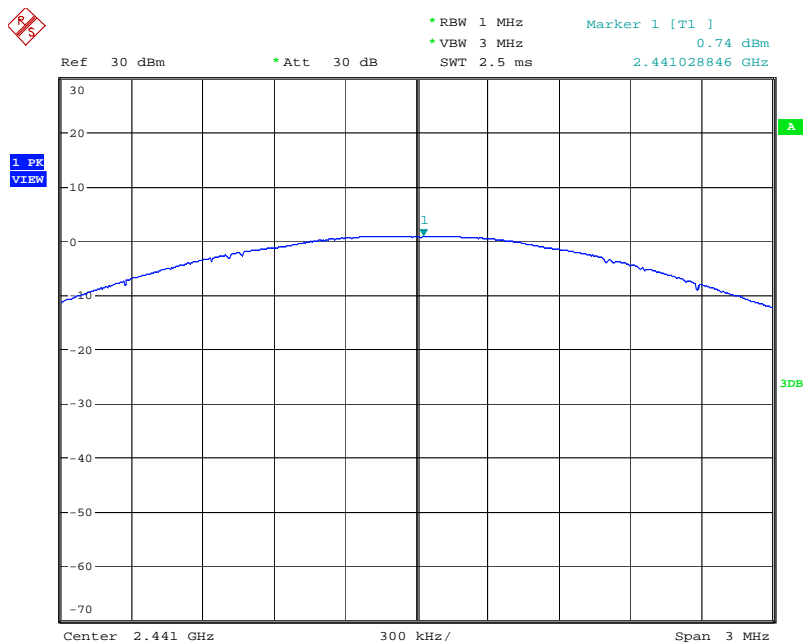

Date: 28.DEC.2015 18:41:40

CH78 -2Mbps

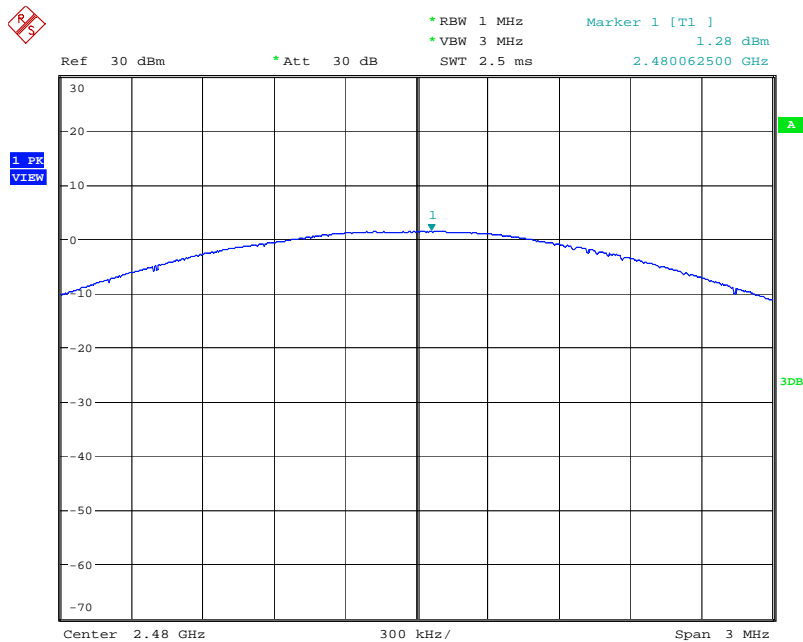

Date: 28.DEC.2015 18:45:21

CH00 -3Mbps

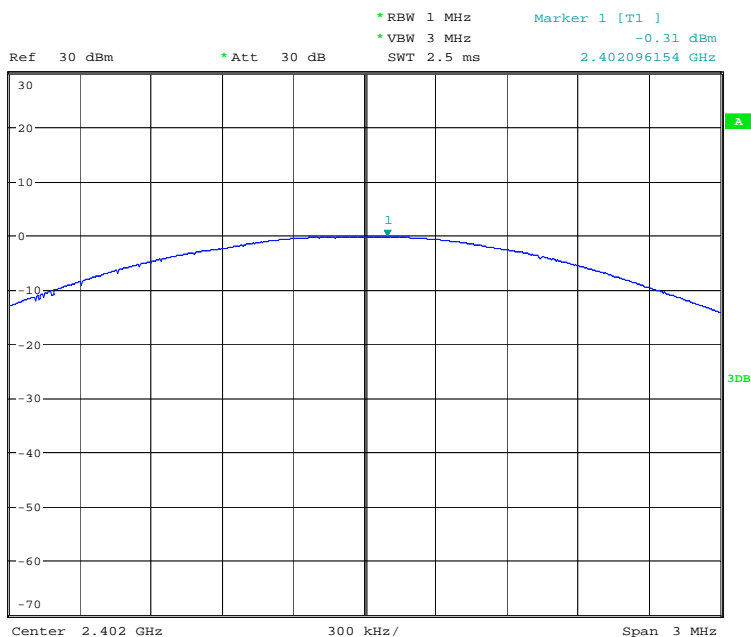

Date: 28.DEC.2015 18:50:59

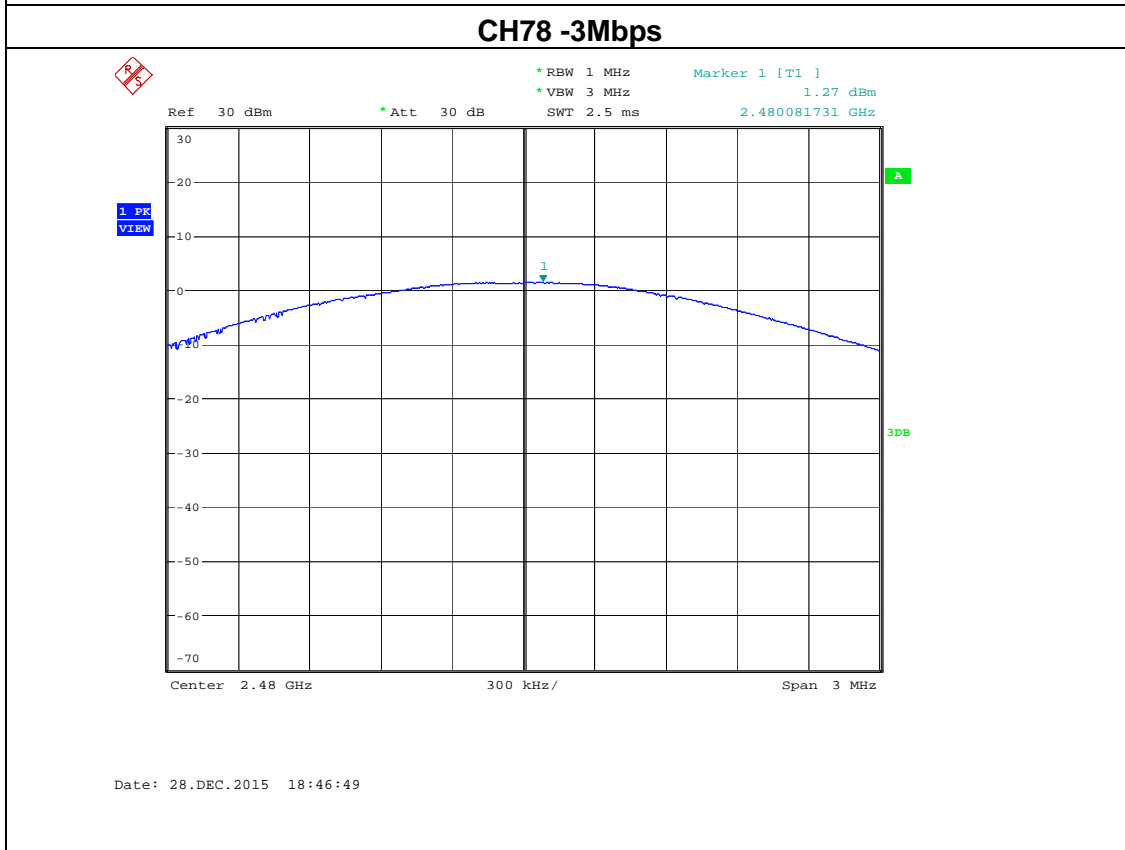
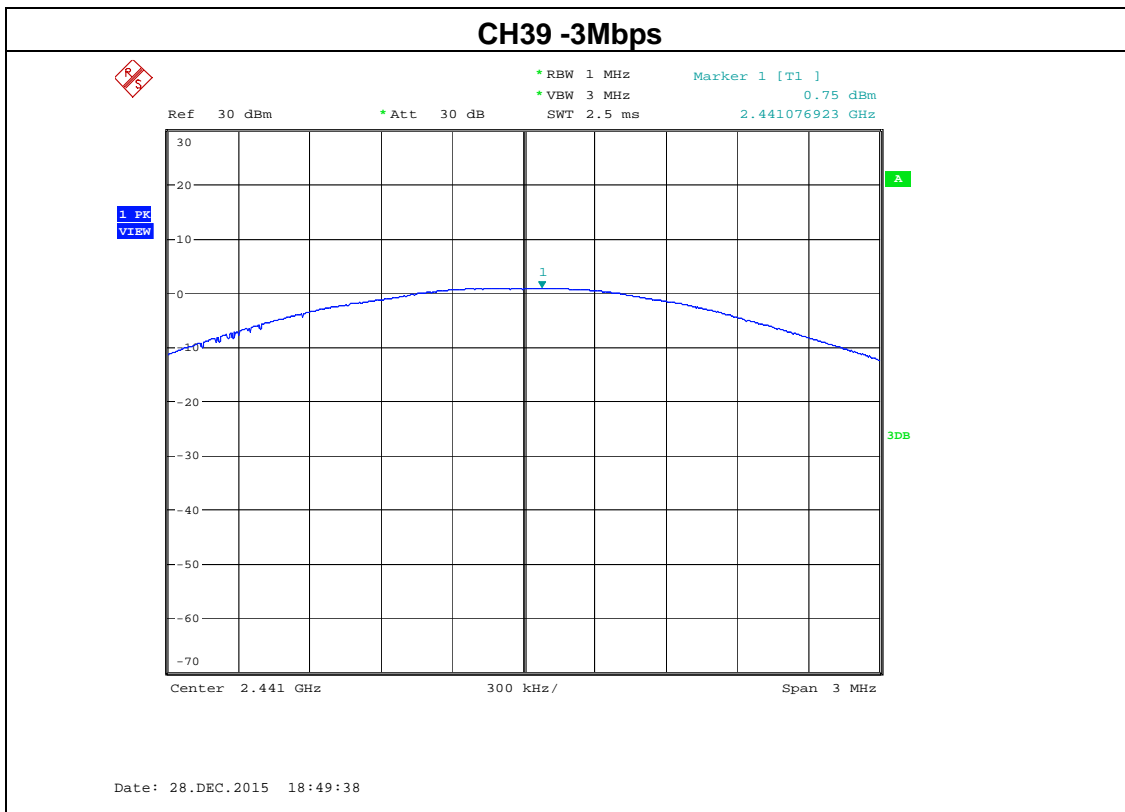

Average power

	Average Conducted Power (dBm)		
BT 2402-2480 MHz	0CH	39CH	78CH
1Mbps	1.18	1.76	1.97
2Mbps	-0.27	0.62	1.07
3Mbps	-0.26	0.63	1.06

:

11. ANTENNA APPLICATION

11.1 Antenna requirement

The EUT'S antenna is met the requirement of FCC part 15C section 15.203 and 15.247

FCC part 15C section 15.247 requirements: Systems operating in the 2402-2480MHz band that are used exclusively for fixed.

11.2 Result

The EUT's antenna integrated on PCB, The antenna's gain is 2.0dBi and meets the requirement.

12. EUT TEST PHOTO

CONDUCTED EMISSION TEST



RADIATED EMISSION TEST

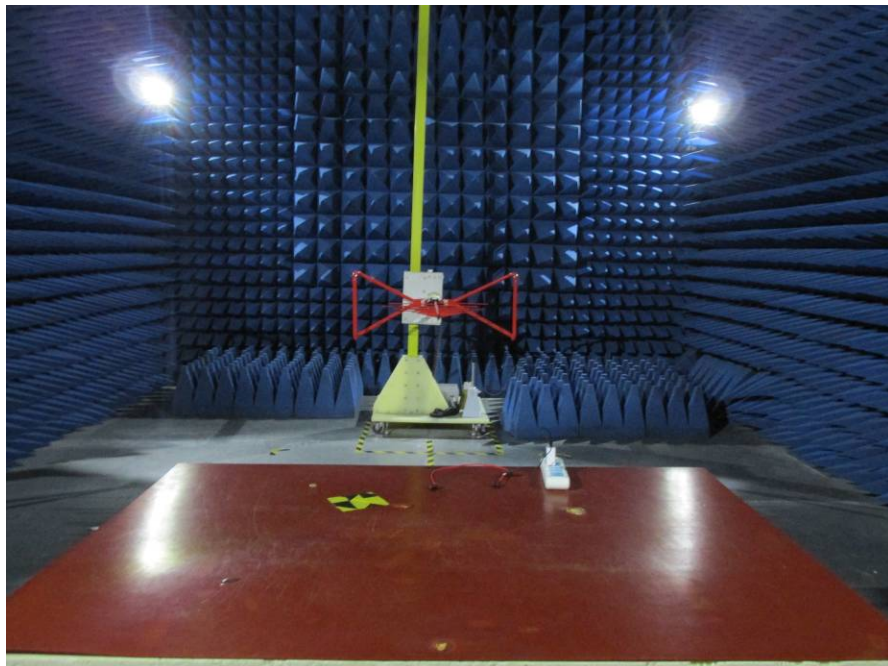

RADIATED EMISSION TEST

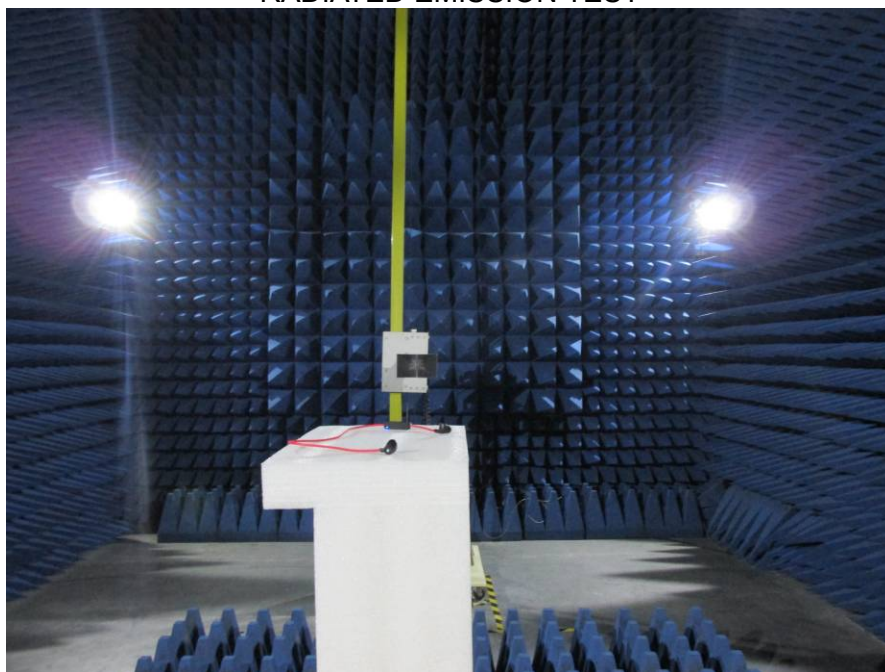

13. PHOTOGRAPHS OF EUT

Appearance photograph of EUT

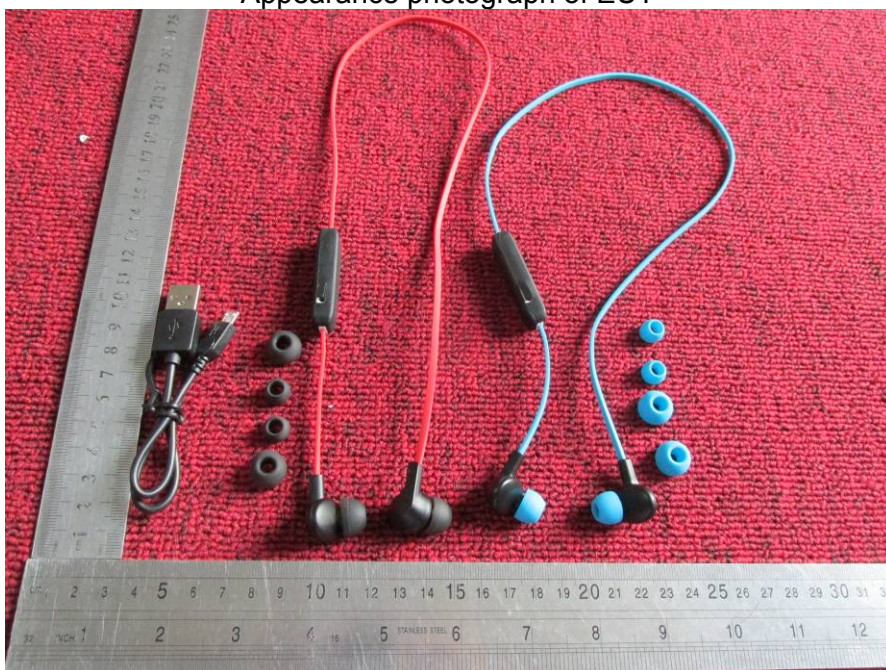

Appearance photograph of EUT



Appearance photograph of EUT

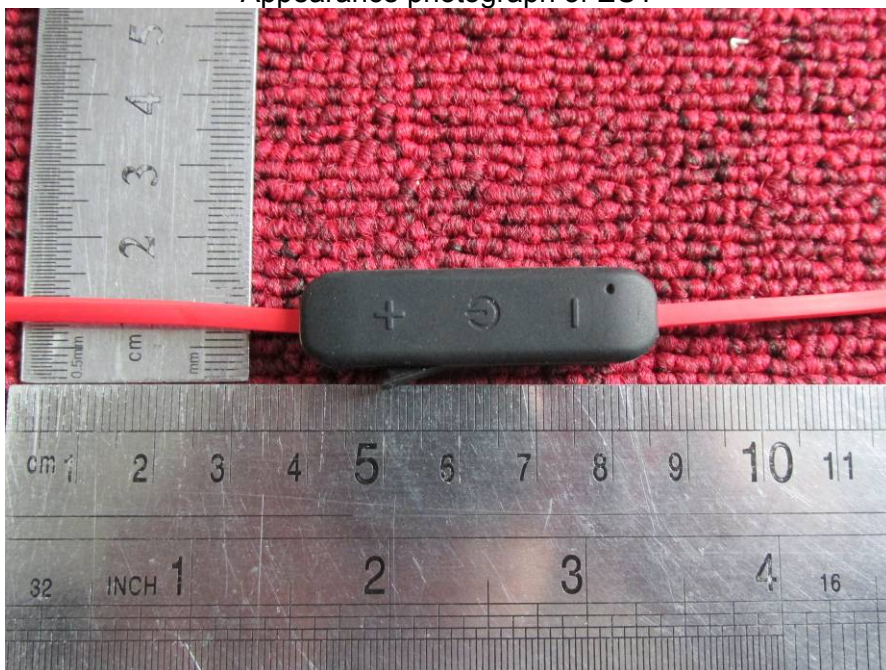

Appearance photograph of EUT



Appearance photograph of EUT

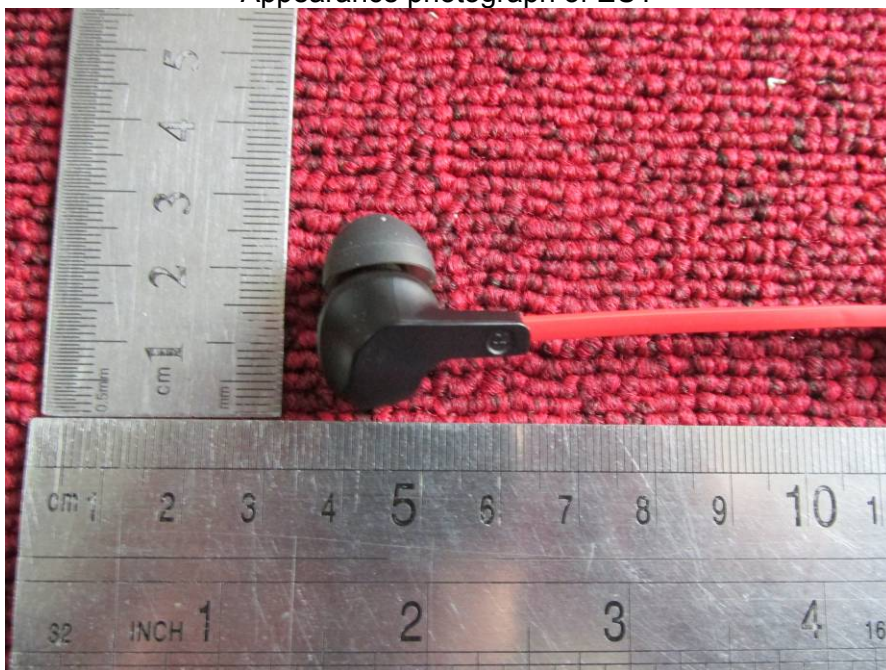

Appearance photograph of EUT

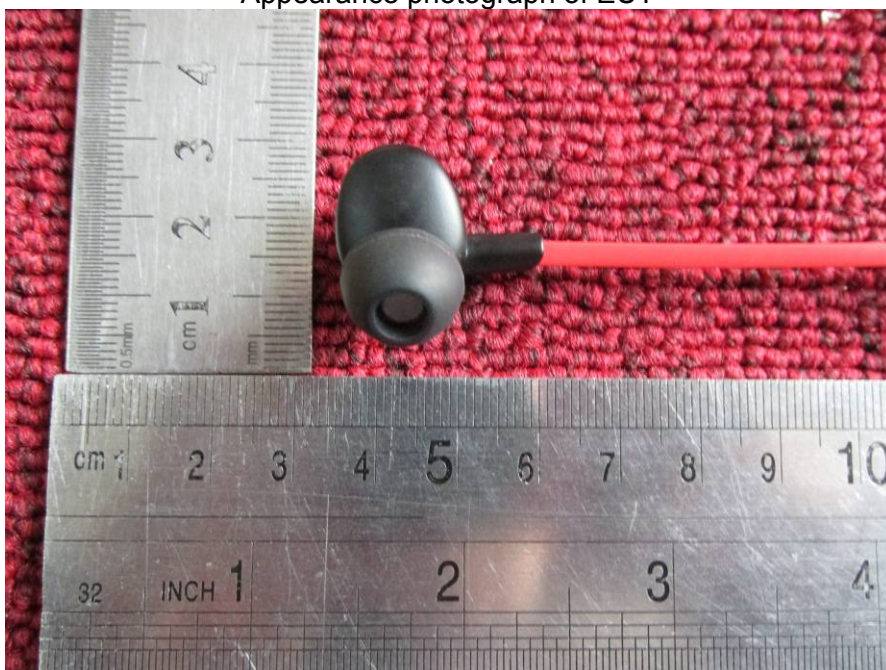

Internal photograph of EUT

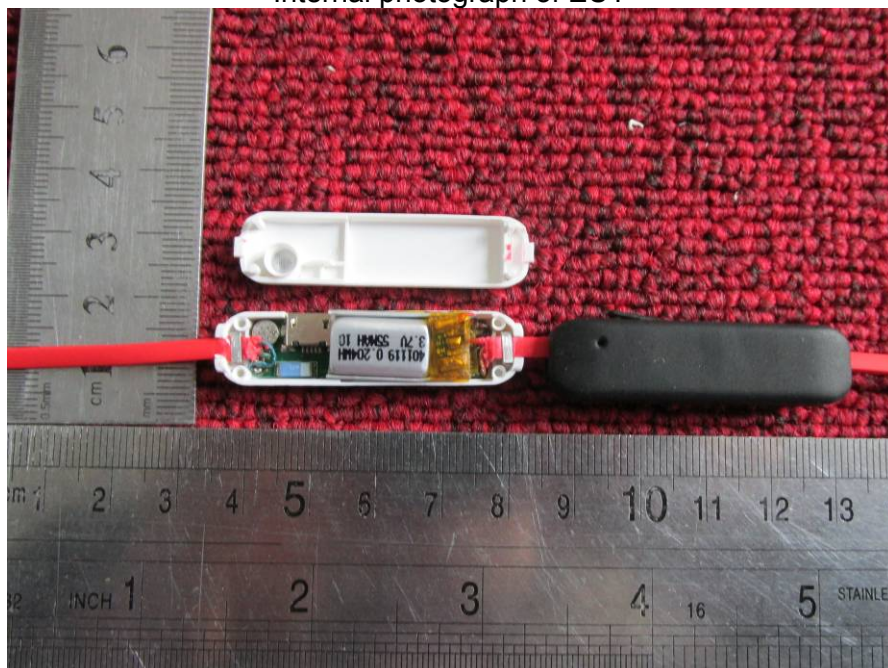

Internal photograph of EUT

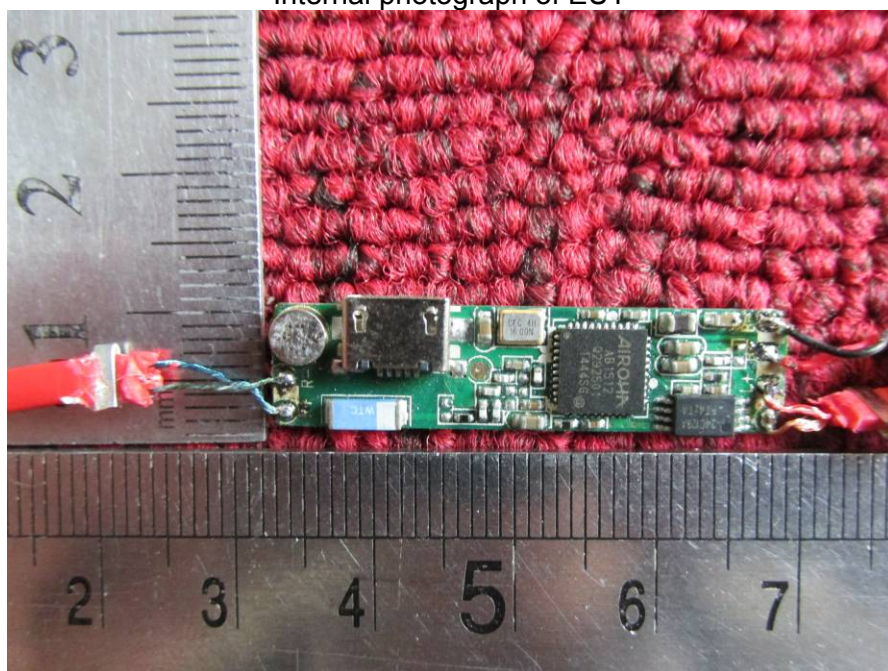

Internal photograph of EUT

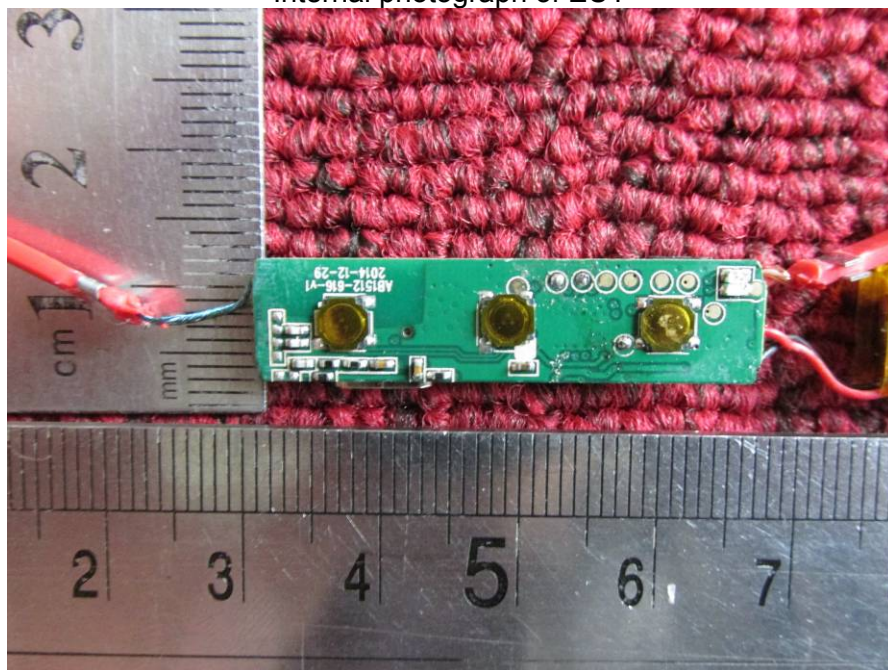

Internal photograph of EUT



Internal photograph of EUT

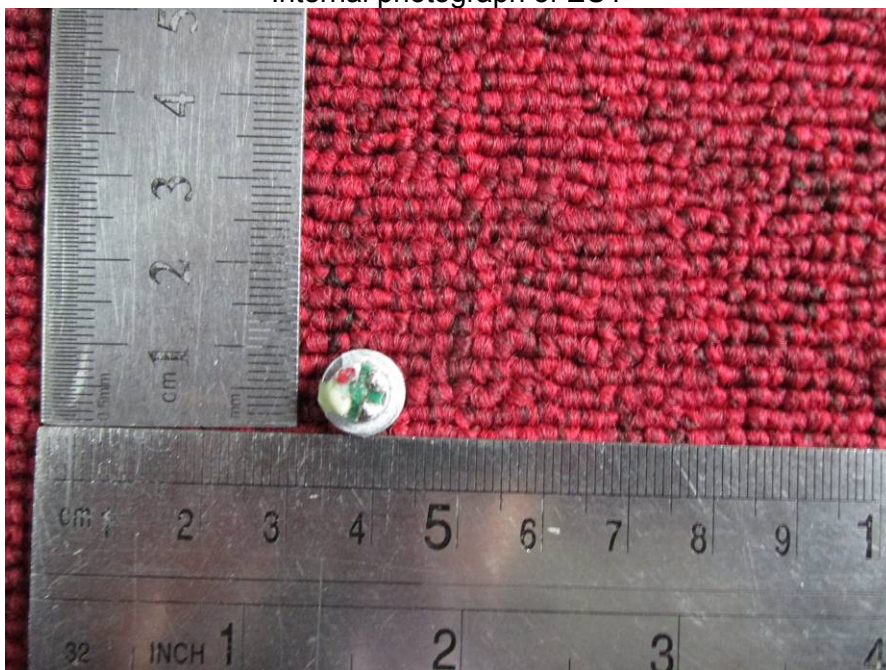

Internal photograph of EUT

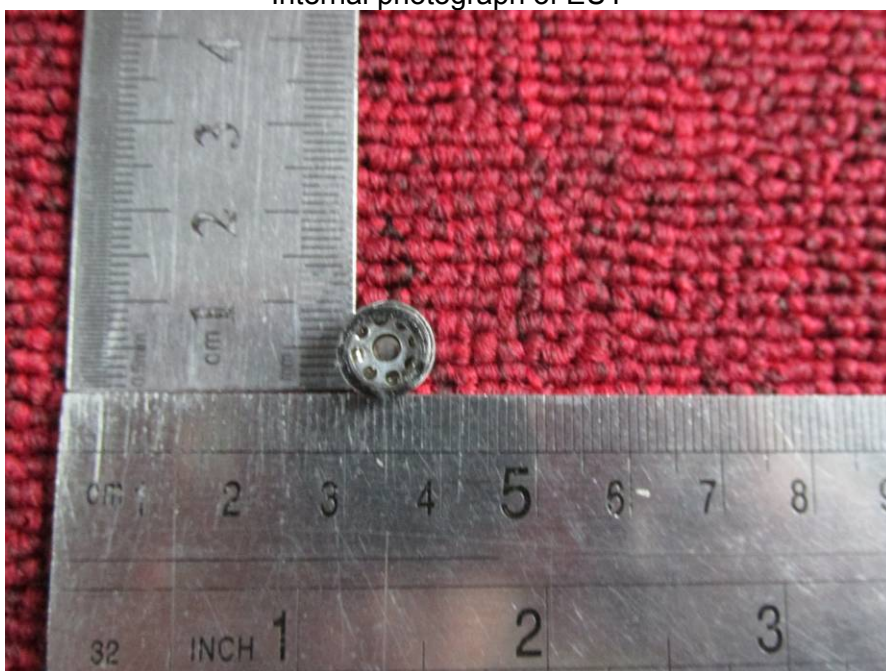

—END OF REPORT—