

FCC TEST REPORT  
for  
Wintop Electronics Co., Limited  
  
BLUETOOTH WIRELESS MOUSE  
Model No.: BM-709L, MBT9650RED,  
MBT9650BLU, MBT9650PUR, MBT9650BLK

Prepared for : Wintop Electronics Co., Limited  
Address : Unit 04 7/F, Bright Way Tower 33, Mong Kok RD KL,  
HONGKONG

Prepared By : Shenzhen Anbotek Compliance Laboratory Limited  
Address : 1/F., Building 1, SEC Industrial Park, No.0409 Qianhai Road,  
Nanshan District, Shenzhen, Guangdong, China  
Tel: (86) 755-26066544  
Fax: (86) 755-26014772

Report Number : R011508067I  
Date of Test : Aug. 04~ 11, 2015  
Date of Report : Aug. 12, 2015

## TABLE OF CONTENTS

Description	Page
Test Report	
<b>1. GENERAL INFORMATION.....</b>	<b>5</b>
1.1 Description of Device (EUT).....	5
1.2 Auxiliary Equipment Used during Test.....	6
1.3 Description of Test Facility.....	6
1.4 Measurement Uncertainty.....	6
<b>2. TEST PROCEDURE.....</b>	<b>7</b>
<b>3. RADIATION INTERFERENCE.....</b>	<b>8</b>
3.1 Requirements (15.247, 15.209):.....	8
3.2 Test Procedure.....	8
3.3 Test Configuration.....	9
3.4 Test Results.....	10
<b>4. CHANNEL SEPARATION TEST.....</b>	<b>19</b>
4.1 Measurement Procedure.....	19
4.2 Test SET-UP.....	19
4.3 Test Equipment.....	19
4.4 Test Results.....	20
<b>5. 20DB BANDWIDTH TEST.....</b>	<b>22</b>
5.1 Measurement Procedure.....	22
5.2 Test SET-UP.....	22
5.3 Test Equipment.....	22
5.4 Test Results.....	22
<b>6. QUANTITY OF HOPPING CHANNEL TEST.....</b>	<b>24</b>
6.1 Measurement Procedure.....	24
6.2 Test SET-UP.....	24
6.3 Test Equipment.....	24
6.4 Test Results.....	24
<b>7. DWELL TIME TEST.....</b>	<b>26</b>
7.1 Measurement Procedure.....	26
7.2 Test SET-UP.....	26
7.3 Test Equipment.....	26
7.4 Test Results.....	26
<b>8. MAXIMUM PEAK OUTPUT POWER TEST.....</b>	<b>28</b>
8.1 Measurement Procedure.....	28
8.2 Test SET-UP.....	28
8.3 Test Equipment.....	28
8.4 Test Results.....	29
<b>9. BAND EDGE TEST.....</b>	<b>31</b>
9.1 Measurement Procedure.....	31
9.2 Test SET-UP.....	31
9.3 Test Equipment.....	32

---

9.4 Test Results.....	32
<b>10. ANTENNA APPLICATION.....</b>	<b>36</b>
10.1 Antenna requirement.....	36
10.2 Result.....	36
<b>11. PHOTOGRAPH.....</b>	<b>37</b>
11.1 Photo of Radiation Emission Test.....	37
<b>APPENDIX I (EXTERNAL PHOTOS).....</b>	<b>38</b>
<b>APPENDIX II (INTERNAL PHOTOS).....</b>	<b>42</b>



## TEST REPORT

Applicant : Wintop Electronics Co., Limited  
Manufacturer : Shenzhen Wintop Electronics Co., Limited  
EUT : BLUETOOTH WIRELESS MOUSE  
Model No. : BM-709L, MBT9650RED, MBT9650BLU, MBT9650PUR,  
MBT9650BLK  
Serial No. : N.A.  
Trade Mark : N.A.  
Rating : DC 1.5V, 12mA

Measurement Procedure Used:

FCC Part15 Subpart C 2014, Paragraph 15.207, 15.247 & 15.209

The device described above is tested by Shenzhen Anbotek Compliance Laboratory Limited to determine the maximum emission levels emanating from the device and the severe levels of the device can endure and its performance criterion. The measurement results are contained in this test report and Shenzhen Anbotek Compliance Laboratory Limited is assumed full of responsibility for the accuracy and completeness of these measurements. Also, this report shows that the EUT (Equipment Under Test) is technically compliant with the FCC Part 15 Subpart C requirements.

This report applies to above tested sample only and shall not be reproduced in part without written approval of Shenzhen Anbotek Compliance Laboratory Limited.

Date of Test : Aug. 04~ 11, 2015

*Kebo Zhang*

Prepared by :

(Tested Engineer / Kebo Zhang)

*Amy Ding*

Reviewer :

(Project Manager / Amy Ding)

*Tom Chen*

Approved & Authorized Signer :

(Manager / Tom Chen)

## 1. GENERAL INFORMATION

### 1.1 Description of Device (EUT)

EUT	: BLUETOOTH WIRELESS MOUSE
Model Number	: BM-709L, MBT9650RED, MBT9650BLU, MBT9650PUR, MBT9650BLK (Note: All samples are the same except the model number and colour, so we prepare “BM-709L” for test only.)
Test Power Supply	: DC 1.5V
Frequency	: 2402~2480MHz
Antenna Specification	: PCB Antenna: 0.1763dBi
Modulation	: GFSK, $\pi/4$ DQPSK, 8DPSK
Applicant Address	: Wintop Electronics Co., Limited Unit 04 7/F, Bright Way Tower 33, Mong Kok RD KL, HONGKONG
Manufacturer Address	: Shenzhen Wintop Electronics Co., Limited Huaguan Industrial Park, Xinhe Road, Baolai Industrial District, Shangmugu, Pinghu Town, Longgang District, Shenzhen City, 518000, China
Factory Address	: Shenzhen Wintop Electronics Co., Limited Huaguan Industrial Park, Xinhe Road, Baolai Industrial District, Shangmugu, Pinghu Town, Longgang District, Shenzhen City, 518000, China
Date of receipt	: Aug. 04, 2015
Date of Test	: Aug. 04~ 11, 2015

## 1.2 Auxiliary Equipment Used during Test

Notebook : Manufacturer: FUJITSU  
Model: LH531

Printer : Manufacturer: Brother  
M/N: MFC-3360C  
S/N: N/A  
CE, FCC: DOC

## 1.3 Description of Test Facility

The test facility is recognized, certified, or accredited by the following organizations:

### **CNAS - LAB Code: L3503**

Shenzhen Anbotek Compliance Laboratory Limited., Laboratory has been assessed and in compliance with CNAS/CL01: 2006 accreditation criteria for testing laboratories (identical to ISO/IEC 17025:2005 General Requirements) for the Competence of Testing Laboratories.

### **FCC-Registration No.: 752021**

Shenzhen Anbotek Compliance Laboratory Limited, EMC Laboratory has been registered and fully described in a report filed with the (FCC) Federal Communications Commission. The acceptance letter from the FCC is maintained in our files. Registration 752021, July 10, 2013.

### **IC-Registration No.: 8058A-1**

Shenzhen Anbotek Compliance Laboratory Limited., EMC Laboratory has been registered and fully described in a report filed with the (IC) Industry Canada. The acceptance letter from the IC is maintained in our files. Registration 8058A, February 22, 2013.

### **Test Location**

All Emissions tests were performed at  
Shenzhen Anbotek Compliance Laboratory Limited. at 1/F., Building 1, SEC  
Industrial Park, No.0409 Qianhai Road, Nanshan District, Shenzhen, Guangdong,  
China

## 1.4 Measurement Uncertainty

Radiation Uncertainty : Ur = 4.1 dB (Horizontal)  
Ur = 4.3 dB (Vertical)

Conduction Uncertainty : Uc = 3.4dB

## 2. Test Procedure

**GENERAL:** This report shall NOT be reproduced except in full without the written approval of Shenzhen Anbotek Compliance Laboratory Limited. The EUT was transmitting a test signal during the testing.

**RADIATION INTERFERENCE:** The test procedure used was ANSI STANDARD C63.10-2013 using a spectrum analyzer with a pre-selector. The analyzer was calibrated in dB above a microvolt at the output of the antenna. The resolution bandwidth was 100KHz and the video bandwidth was 300KHz up to 1.0GHz and 1.0MHz with a video BW of 3.0MHz above 1.0GHz. The ambient temperature of the EUT was 74.3oF with a humidity of 69%.

**FORMULA OF CONVERSION FACTORS:** The Field Strength at 3m was established by adding the meter reading of the spectrum analyzer (which is set to read in units of dBuV) to the antenna correction factor supplied by the antenna manufacturer. The antenna correction factors are stated in terms of dB. The gain of the Preselector was accounted for in the Spectrum Analyzer Meter Reading.

**Example:**

Freq (MHz) METER READING + ACF = FS  
20 dBuV + 10.36 dB = 30.36 dBuV/m @ 3m

**ANSI STANDARD C63.10-2013 10.1.7 MEASUREMENT PROCEDURES:** The EUT was placed on a table 80 cm high and with dimensions of 1m by 1.5m. The EUT was placed in the center of the table (1.5m side). The table used for radiated measurements is capable of continuous rotation.

When an emission was found, the table was rotated to produce the maximum signal strength. At this point, the antenna was raised and lowered from 1m to 4m. The antenna was placed in both the horizontal and vertical planes.

### 3. Radiation Interference

#### 3.1 Requirements (15.247, 15.209):

##### 3.1.1. Test Limits (< 30 MHz)

Frequency (MHz)	Field Strength (microvolts/meter)	Measurement Distance (meter)
0.009-0.490	2400/F(kHz)	300
0.490-1.705	24000/F(kHz)	30
1.705-30.0	30	30

##### 3.1.2. Test Limits (≥ 30 MHz)

FIELD STRENGTH of Fundamental: @3M	FIELD STRENGTH of Harmonics	S15.209	
902-928 MHz		30 - 88 MHz	40 dBuV/m
2.4-2.4835 GHz		88 - 216 MHz	43.5
94 dBμV/m @3m	54 dBμV/m @3m	216 - 960 MHz	46
		ABOVE 960 MHz	54dBuV/m

For range 9KHz~30MHz, The measured value is really too low to be recorded.

Emissions radiated outside of the specified frequency bands, except for harmonics, shall be attenuated by at least 50 dB below the level of the fundamental or to the general radiated emission limits in 15.209, whichever is the lesser attenuation.

#### 3.2 Test Procedure

For below 1GHz: The EUT is placed on a turntable, which is 0.8m above the ground plane.  
 For above 1GHz: The EUT is placed on a turntable, which is 1.5m above the ground plane.  
 The turn table can rotate 360 degrees to determine the position of the maximum emission level.  
 The EUT is set 3 meters away from the receiving antenna which is mounted on a antenna tower.  
 The antenna can be moved up and down from 1 to 4 meters to find out the maximum emission level. Rotated the EUT through three orthogonal axes to determine the maximum emissions, both horizontal and vertical polarization of the antenna are set on test. The EUT is tested in 9\*6\*6 Chamber. The device is evaluated in xy orientation.

##### **For 30MHz to 1000MHz:**

Set the spectrum analyzer as:  
 RBW = 100kHz, VBW =300kHz,  
 Detector= Quasi-Peak  
 Trace mode= Max hold.  
 Sweep- auto couple.

##### **For Above 1GHz:**

Set the spectrum analyzer as:  
 RBW = 1MHz, VBW =3MHz,  
 Detector= Peak



Trace mode= Max hold.  
Sweep- auto couple.

Set the spectrum analyzer as:  
RBW =1MHz, VBW =10Hz  
Detector= Average  
Trace mode= Max hold.  
Sweep- auto couple.

Test Equipment

Item	Equipment	Manufacturer	Model No.	Serial No.	Last Cal.	Cal. Interval
1.	Spectrum Analysis	Agilent	E4407B	US39390582	Apr. 17, 2015	1 Year
2.	Preamplifier	Instruments corporation	EMC011830	980100	Apr. 17, 2015	1 Year
3.	EMI Test Receiver	Rohde & Schwarz	ESPI	101604	Apr. 17, 2015	1 Year
4.	Double Ridged Horn Antenna	Instruments corporation	GTH-0118	351600	Apr. 20, 2015	1 Year
5.	Bilog Broadband Antenna	Schwarzbeck	VULB9163	VULB 9163-289	Apr. 20, 2015	1 Year
6.	Pre-amplifier	SONOMA	310N	186860	Apr. 17, 2015	1 Year
7.	EMI Test Software EZ-EMC	SHURPLE	N/A	N/A	N/A	N/A

3.3 Test Configuration

3.3.1. 9k to 30MHz emissions:

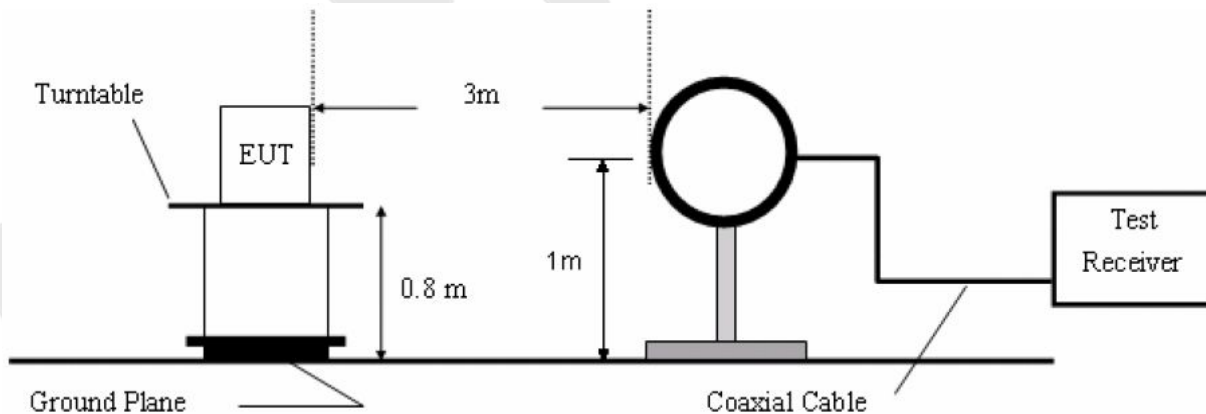

3.3.2. 30M to 1G emissions:

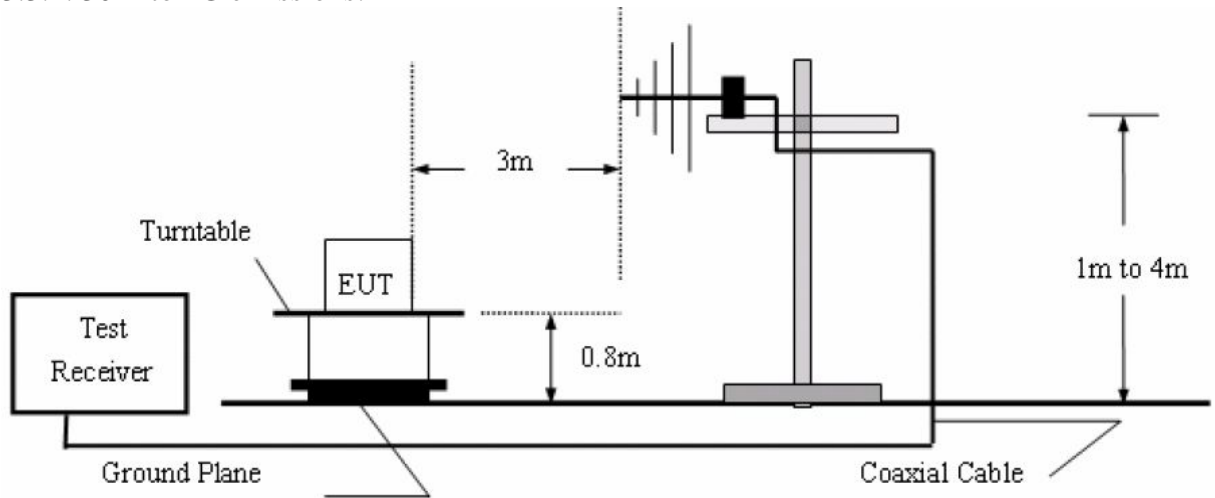

3.3.3. 1G to 40G emissions:

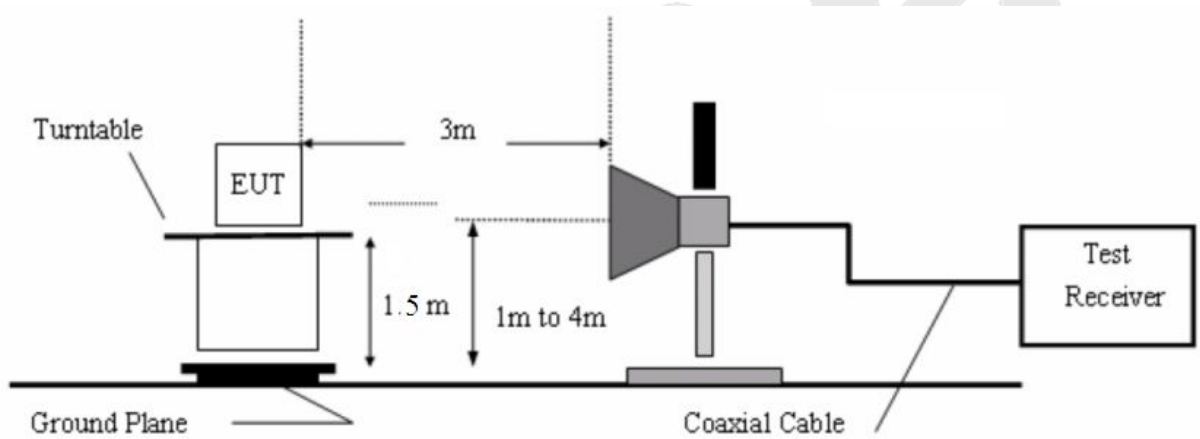

3.4 Test Results

PASS.

Please refer the following pages. Only the worst case (x orientation).

Job No.:	011508067I	Polarization:	Horizontal
Standard:	(RE)FCC PART 15C _3m	Power Source:	DC 1.5V
Test item:	Radiation Test (30~1000MHz)	Temp.(C)/Hum.(%RH):	24.3( C)/55%RH
Test Mode:	On	Distance:	3m

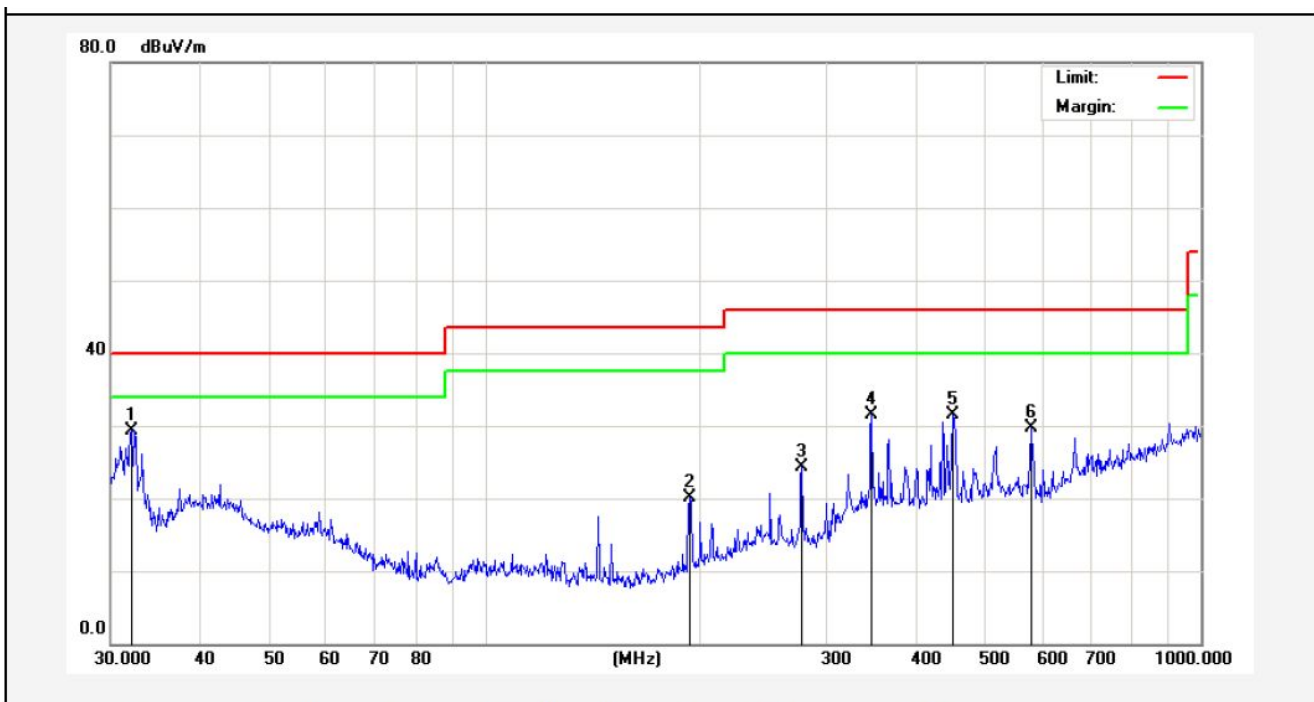

No.	Freq. (MHz)	Reading (dBuV/m)	Factor (dB/m)	Result (dBuV/m)	Limit (dBuV/)	Over Limit (dB)	Detector	Height (cm)	degree (deg)	Remark
1	32.0667	45.22	-15.85	29.37	40.00	-10.63	peak			
2	193.0945	41.02	-20.91	20.11	43.50	-23.39	peak			
3	277.0935	42.55	-18.33	24.22	46.00	-21.78	peak			
4	346.8092	45.54	-14.08	31.46	46.00	-14.54	peak			
5	449.5558	43.65	-12.16	31.49	46.00	-14.51	peak			
6	578.6699	40.89	-11.18	29.71	46.00	-16.29	peak			

Job No.:	011508067I	Polarization:	Vertical
Standard:	(RE)FCC PART 15C _3m	Power Source:	DC 1.5V
Test item:	Radiation Test (30~1000MHz)	Temp.(C)/Hum.(%RH):	24.3( C)/55%RH
Test Mode:	On	Distance:	3m

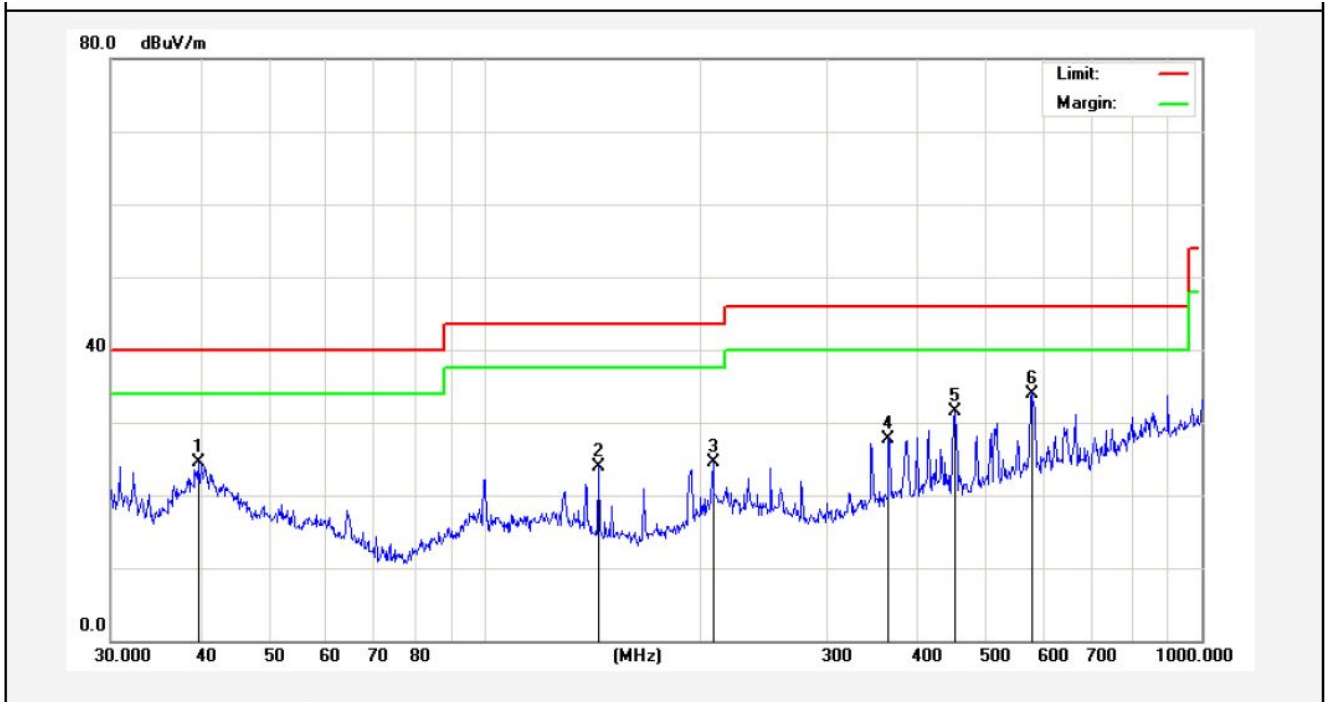

No.	Freq. (MHz)	Reading (dBuV/m)	Factor (dB/m)	Result (dBuV/m)	Limit (dBuV/)	Over Limit (dB)	Detector	Height (cm)	degree (deg)	Remark
1	39.7146	35.04	-10.59	24.45	40.00	-15.55	peak			
2	143.8295	42.35	-18.43	23.92	43.50	-19.58	peak			
3	207.8501	40.04	-15.57	24.47	43.50	-19.03	peak			
4	365.5391	40.22	-12.56	27.66	46.00	-18.34	peak			
5	452.7197	43.23	-11.78	31.45	46.00	-14.55	peak			
6	578.6699	43.61	-9.61	34.00	46.00	-12.00	peak			

Job No.:	011508067I	Polarization:	Horizontal
Standard:	(RE)FCC PART 15C_Class B_3m	Power Source:	DC 1.5V
Test item:	Radiation Test (Above 1GHz)	Temp.(C)/Hum.(%RH):	24.3( C)/55%RH
Test Mode:	TX(2402 MHz)	Distance:	3m

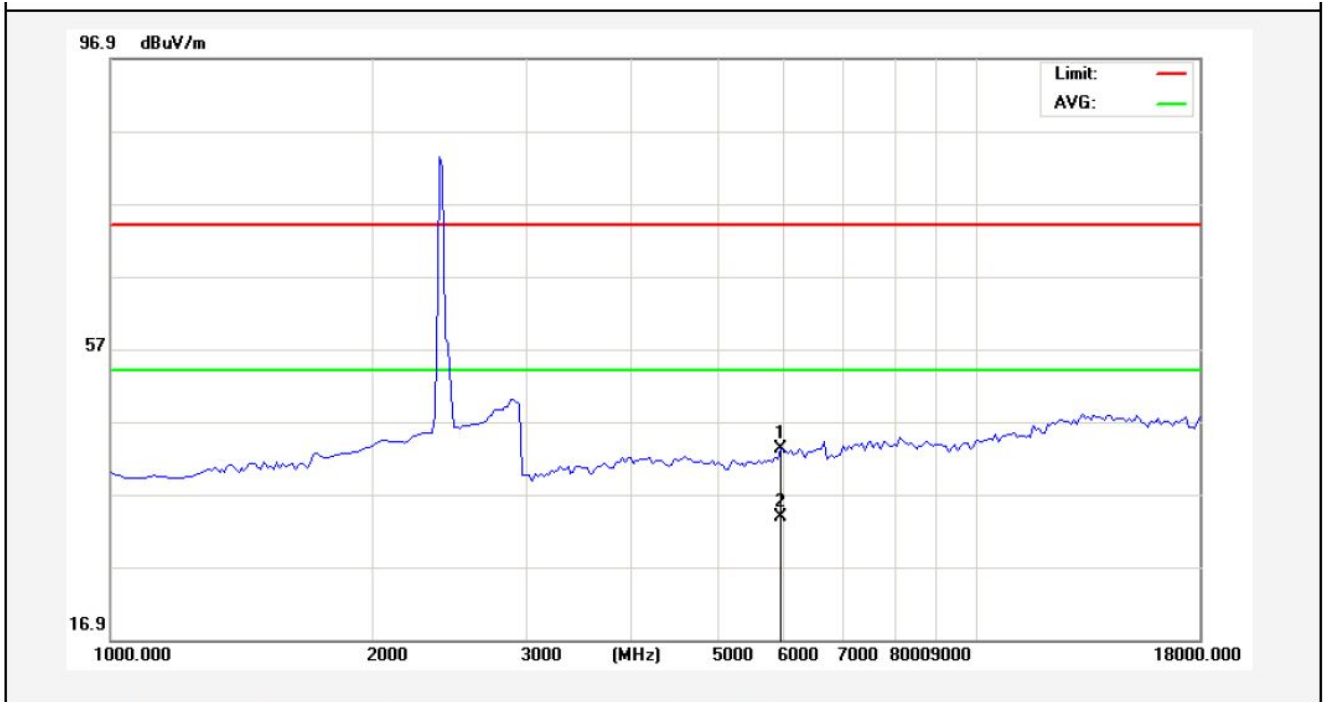

No.	Freq. (MHz)	Reading (dBuV/m)	Factor (dB/m)	Result (dBuV/m)	Limit (dBuV/)	Over Limit (dB)	Detector	Height (cm)	degree (deg)	Remark
1	5930.000	36.48	6.69	43.17	74.00	-30.83	peak			
2	5930.000	27.16	6.69	33.85	54.00	-20.15	AVG			

A M

Job No.:	011508067I	Polarization:	Vertical
Standard:	(RE)FCC PART 15C_Class B_3m	Power Source:	DC 1.5V
Test item:	Radiation Test (Above 1GHz)	Temp.(C)/Hum.(%RH):	24.3( C)/55%RH
Test Mode:	TX(2402 MHz)	Distance:	3m

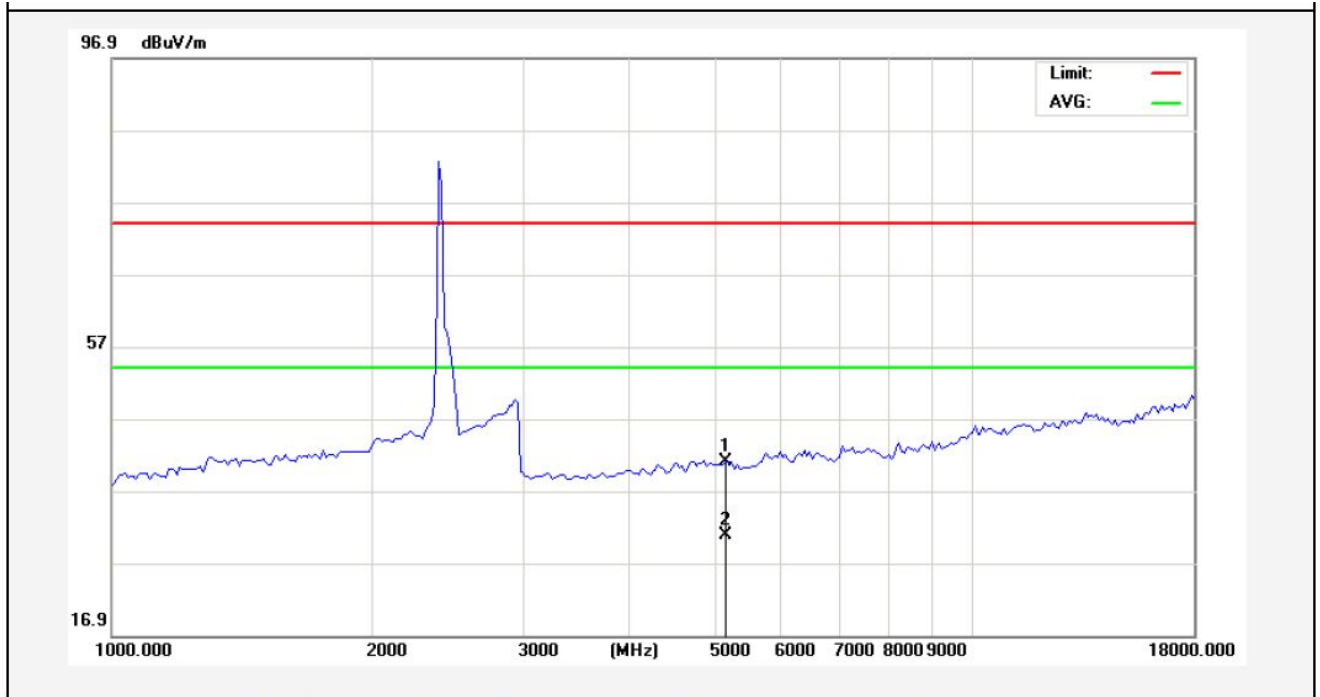

No.	Freq. (MHz)	Reading (dBuV/m)	Factor (dB/m)	Result (dBuV/m)	Limit (dBuV/)	Over Limit (dB)	Detector	Height (cm)	degree (deg)	Remark
1	5165.000	37.23	3.76	40.99	74.00	-33.01	peak			
2	5165.000	26.98	3.76	30.74	54.00	-23.26	AVG			

<b>Job No.:</b>	<b>011508067I</b>	<b>Polarization:</b>	<b>Horizontal</b>
<b>Standard:</b>	<b>(RE)FCC PART 15C_Class B_3m</b>	<b>Power Source:</b>	<b>DC 1.5V</b>
<b>Test item:</b>	<b>Radiation Test (Above 1GHz)</b>	<b>Temp.(C)/Hum.(%RH):</b>	<b>24.3( C)/55%RH</b>
<b>Test Mode:</b>	<b>TX(2441 MHz)</b>	<b>Distance:</b>	<b>3m</b>

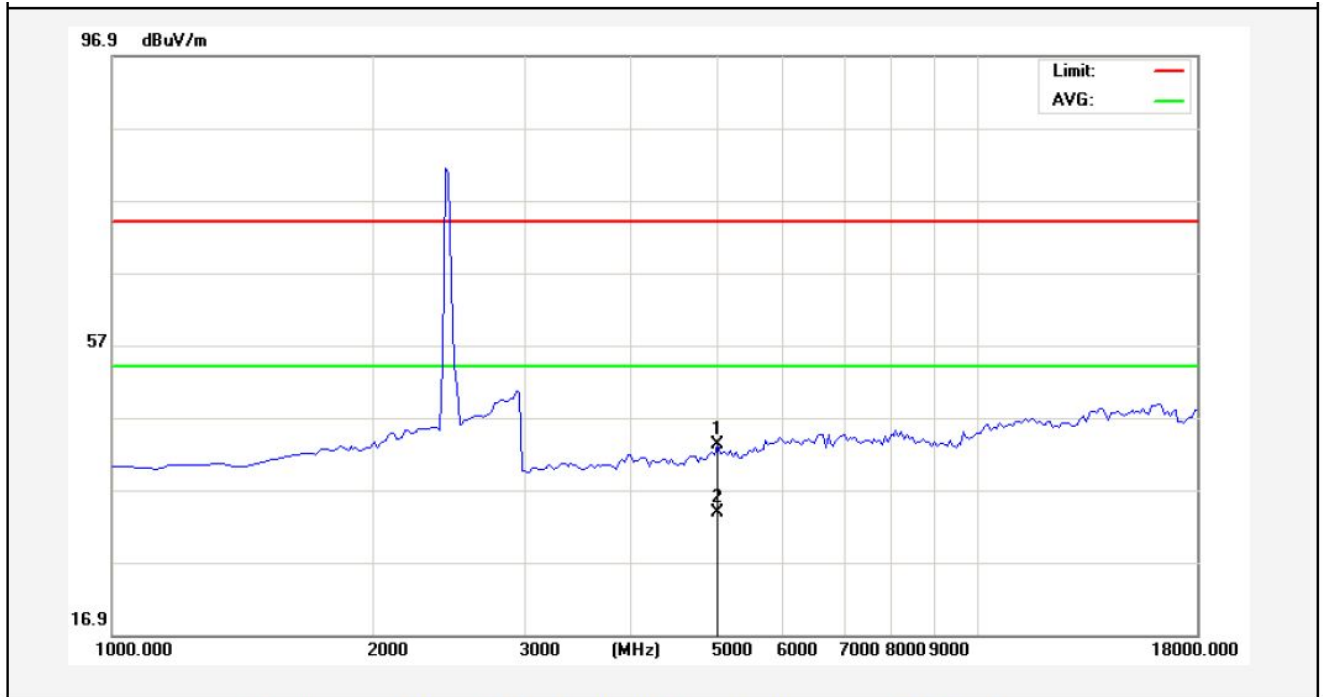

No.	Freq. (MHz)	Reading (dBuV/m)	Factor (dB/m)	Result (dBuV/m)	Limit (dBuV/)	Over Limit (dB)	Detector	Height (cm)	degree (deg)	Remark
1	5037.500	39.53	3.67	43.20	74.00	-30.80	peak			
2	5037.500	30.04	3.67	33.71	54.00	-20.29	AVG			

AMT



Job No.:	011508067I	Polarization:	Vertical
Standard:	(RE)FCC PART 15C_Class B_3m	Power Source:	DC 1.5V
Test item:	Radiation Test (Above 1GHz)	Temp.(C)/Hum.(%RH):	24.3( C)/55%RH
Test Mode:	TX(2441 MHz)	Distance:	3m

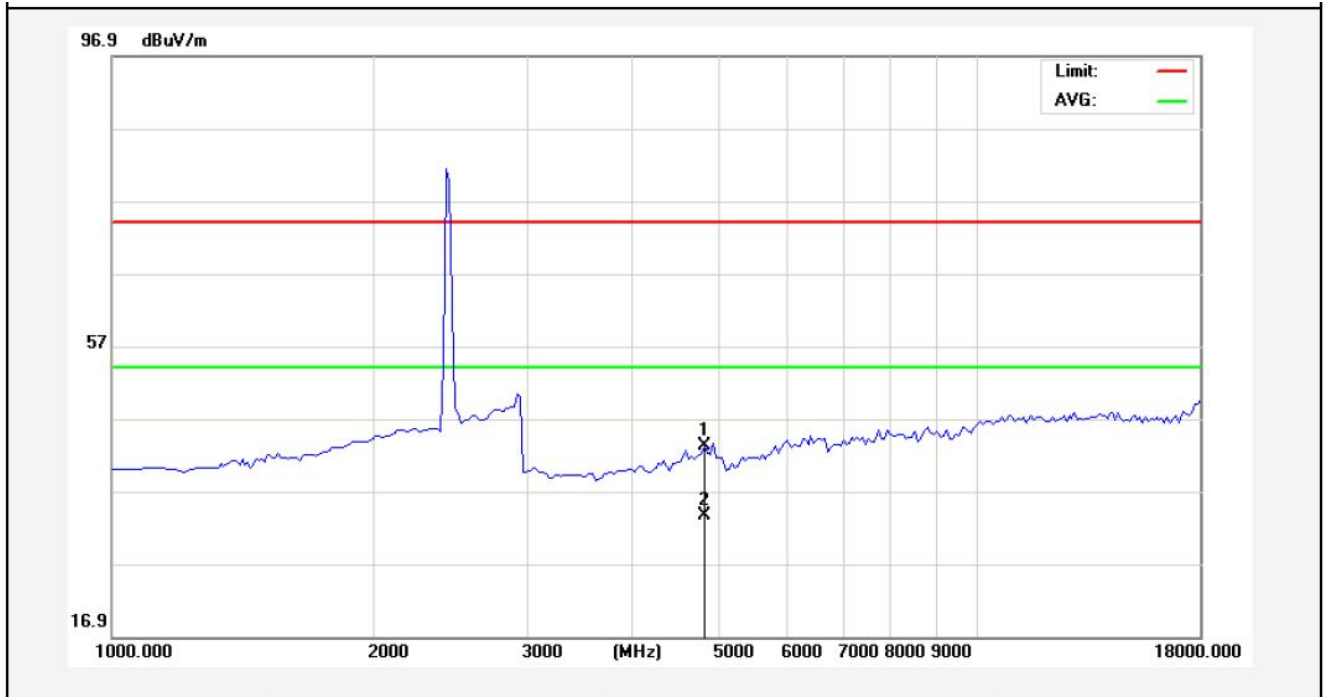

No.	Freq. (MHz)	Reading (dBuV/m)	Factor (dB/m)	Result (dBuV/m)	Limit (dBuV/)	Over Limit (dB)	Detector	Height (cm)	degree (deg)	Remark
1	4831.962	39.81	3.35	43.16	74.00	-30.84	peak			
2	4831.962	30.32	3.35	33.67	54.00	-20.33	AVG			



Job No.:	011508067I	Polarization:	Horizontal
Standard:	(RE)FCC PART 15C_Class B_3m	Power Source:	DC 1.5V
Test item:	Radiation Test (Above 1GHz)	Temp.(C)/Hum.(%RH):	24.3( C)/55%RH
Test Mode:	TX(2480 MHz)	Distance:	3m

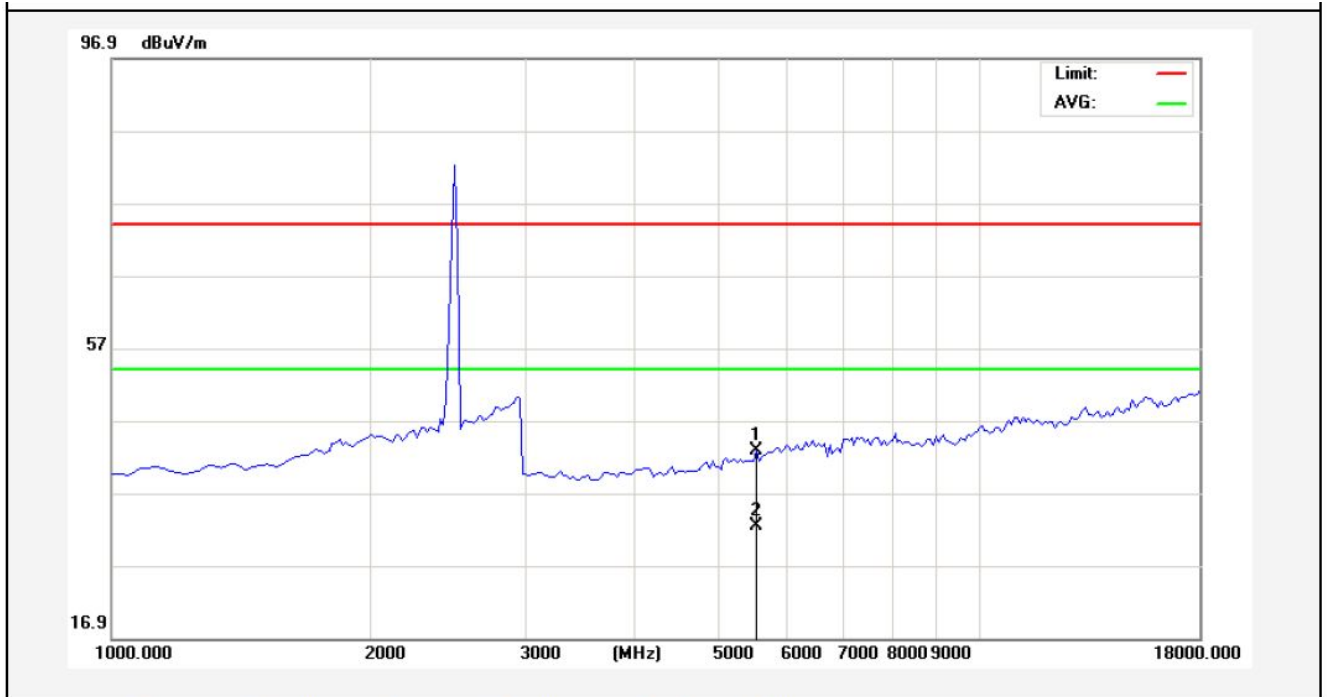

No.	Freq. (MHz)	Reading (dBuV/m)	Factor (dB/m)	Result (dBuV/m)	Limit (dBuV/)	Over Limit (dB)	Detector	Height (cm)	degree (deg)	Remark
1	5547.500	38.48	4.28	42.76	74.00	-31.24	peak			
2	5547.500	28.05	4.28	32.33	54.00	-21.67	AVG			

AMR

Job No.:	011508067I	Polarization:	Vertical
Standard:	(RE)FCC PART 15C_Class B_3m	Power Source:	DC 1.5V
Test item:	Radiation Test (Above 1GHz)	Temp.(C)/Hum.(%RH):	24.3( C)/55%RH
Test Mode:	TX(2480 MHz)	Distance:	3m

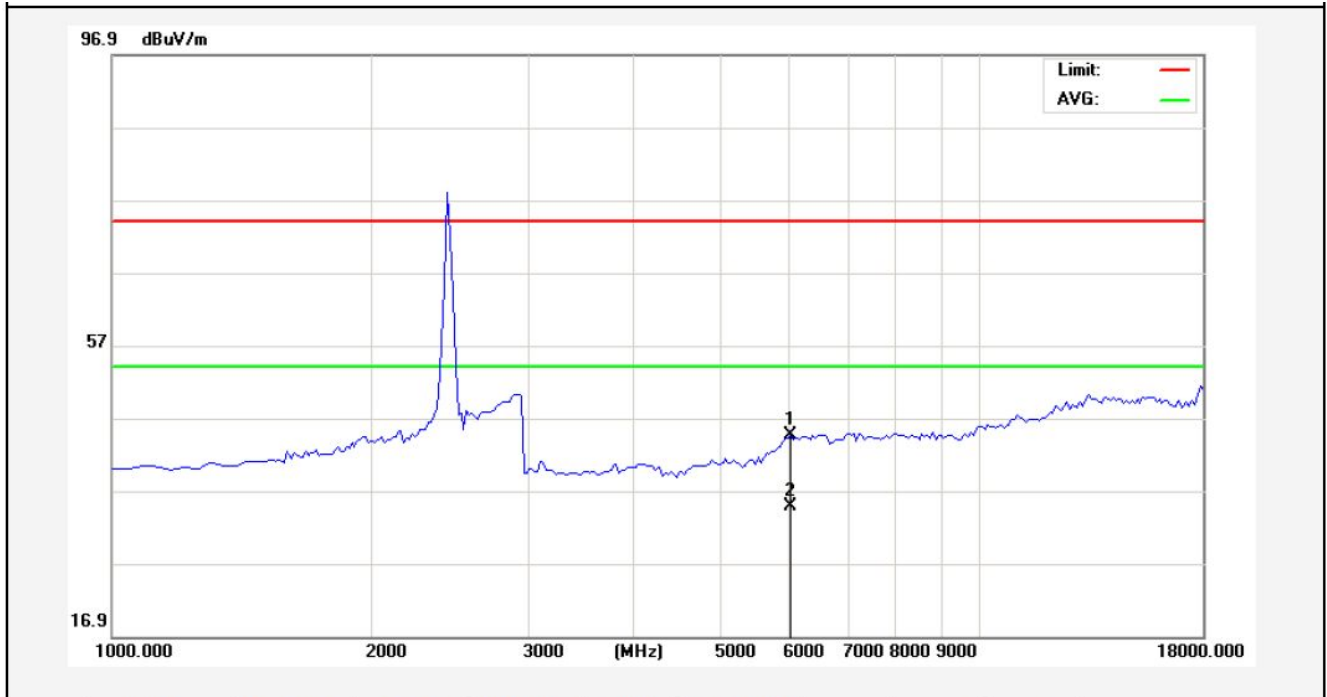

No.	Freq. (MHz)	Reading (dBuV/m)	Factor (dB/m)	Result (dBuV/m)	Limit (dBuV/)	Over Limit (dB)	Detector	Height (cm)	degree (deg)	Remark
1	6057.500	37.50	7.18	44.68	74.00	-29.32	peak			
2	6057.500	27.64	7.18	34.82	54.00	-19.18	AVG			

AMR

## 4. CHANNEL SEPARATION TEST

### 4.1 Measurement Procedure

The EUT must have its hopping function enabled. Using the following spectrum analyzer settings:

1. Span= Wide enough to capture the peaks of two adjacent channels
2. Set the RBW = 30 kHz.
3. Set the VBW = 100 kHz.
4. Sweep time = auto couple.
5. Detector function = peak.
6. Trace mode = max hold.
7. Allow trace to fully stabilize.

### 4.2 Test SET-UP

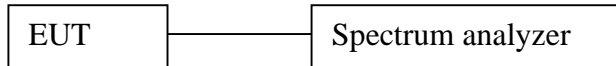

### 4.3 Test Equipment

Item	Equipment	Manufacturer	Model No.	Serial No.	Last Cal.	Cal. Interval
1.	Spectrum Analysis	Agilent	E4407B	US39390582	Apr. 17, 2015	1 Year
2.	Preamplifier	Instruments corporation	EMC011830	980100	Apr. 17, 2015	1 Year
3.	EMI Test Receiver	Rohde & Schwarz	ESPI	101604	Apr. 17, 2015	1 Year
4.	Double Ridged Horn Antenna	Instruments corporation	GTH-0118	351600	Apr. 20, 2015	1 Year
5.	Bilog Broadband Antenna	Schwarzbeck	VULB9163	VULB 9163-289	Apr. 20, 2015	1 Year
6.	Pre-amplifier	SONOMA	310N	186860	Apr. 17, 2015	1 Year
7.	EMI Test Software EZ-EMC	SHURPLE	N/A	N/A	N/A	N/A

#### 4.4 Test Results

Test Item : Frequency Separation Test Mode : CH Low ~ CH High  
Test Voltage : DC 1.5V Temperature : 24°C  
Test Result : PASS Humidity : 55%RH

Channel	Frequency (MHz)	Separation Read Value (kHz)	Limit (kHz)	Modulation Mode
Low	2401	1002	928.5	BDR
Mid	2441	1008	927.4	BDR
High	2480	1002	927.1	BDR
Low	2401	1020	838.7	EDR
Mid	2441	1020	838.7	EDR
High	2480	1002	836.7	EDR

Remark:

1. The limit of mode (EDR) is 2/3 of 20dB BW;



Test Mode: BDR---Low



Test Mode: BDR---Mid



Test Mode: BDR---High

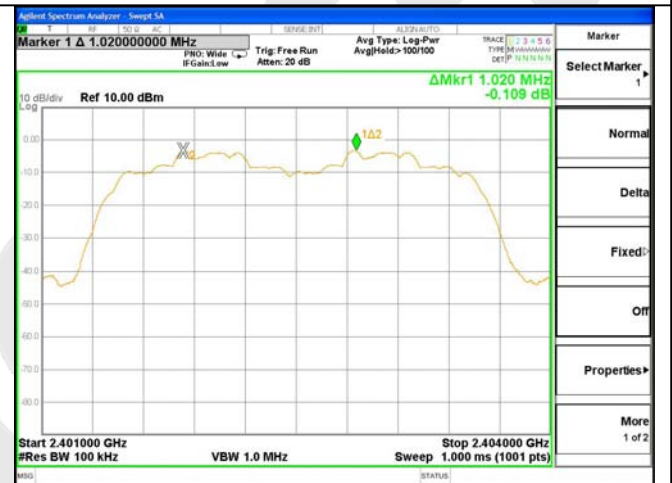

Test Mode: EDR---Low



Test Mode: EDR---Mid



Test Mode: EDR---High

## 5. 20DB BANDWIDTH TEST

### 5.1 Measurement Procedure

Using the following spectrum analyzer settings:

1. Span= approximately 2 to 3 times the 20dB bandwidth, centered on a hopping channel.
2. Set the RBW = 30 kHz.
3. Set the VBW = 100 kHz.
4. Sweep time = auto couple.
5. Detector function = peak.
6. Trace mode = max hold.
7. Allow trace to fully stabilize.

### 5.2 Test SET-UP

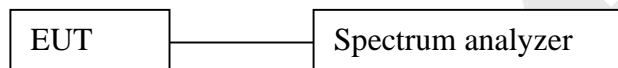

### 5.3 Test Equipment

Same as the equipment listed in 4.3.

### 5.4 Test Results

Test Item	: 20dB BW	Test Mode	: CH Low ~ CH High
Test Voltage	: DC 1.5V	Temperature	: 24°C
Test Result	: PASS	Humidity	: 55%RH

Channel	Frequency (MHz)	20dB Down BW(kHz)	Modulation Mode
Low	2401	928.5	BDR
Mid	2441	927.4	BDR
High	2480	927.1	BDR
Low	2401	1258.0	EDR
Mid	2441	1258.0	EDR
High	2480	1255.0	EDR

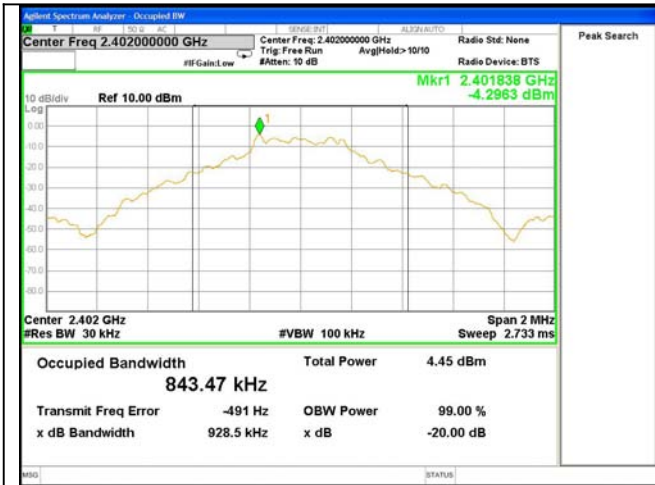

Test Mode: BDR---Low

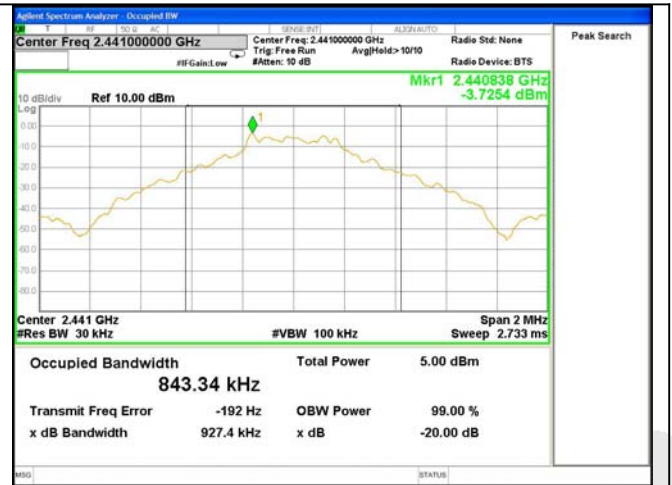

Test Mode: BDR---Mid

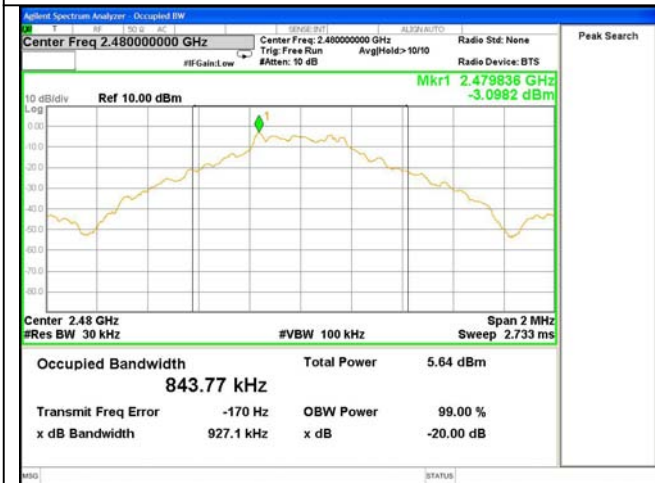

Test Mode: BDR---High

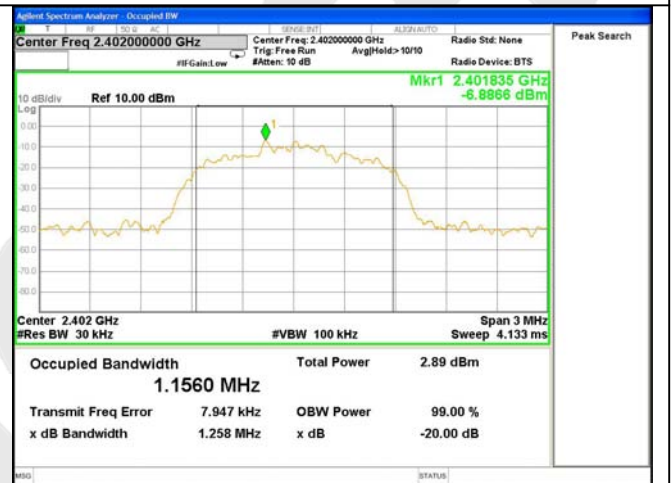

Test Mode: EDR---Low

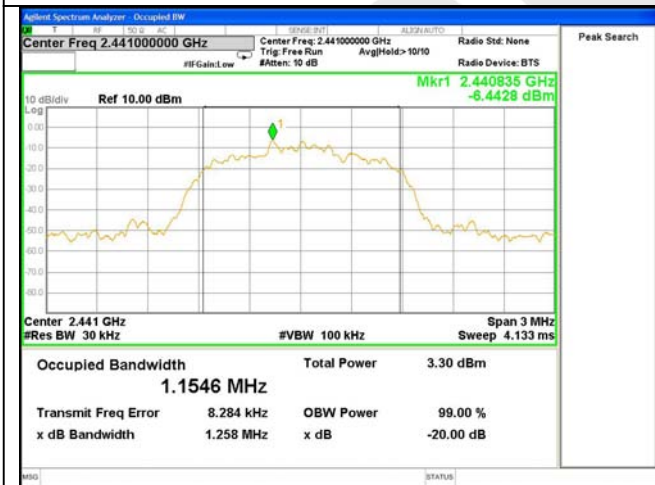

Test Mode: EDR---Mid

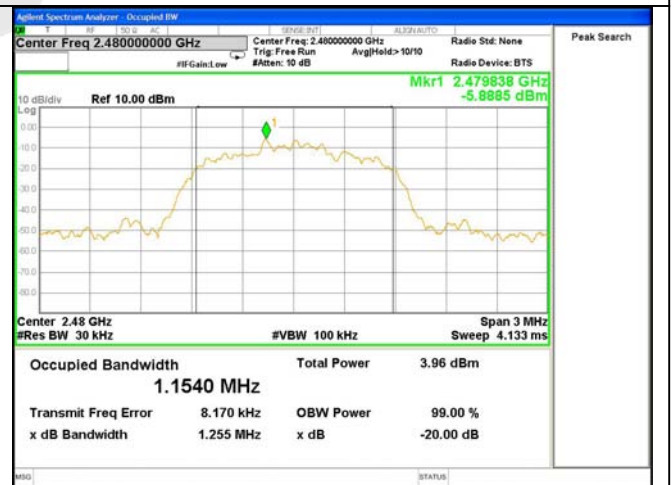

Test Mode: EDR---High



## 6. QUANTITY OF HOPPING CHANNEL TEST

### 6.1 Measurement Procedure

The EUT must have its hopping function enabled. Using the following spectrum analyzer setting:

1. Span= the frequency band of operation
2. Set the RBW = 1 MHz.
3. Set the VBW = 1 MHz.
4. Sweep time = auto couple.
5. Detector function = peak.
6. Trace mode = max hold.
7. Allow trace to fully stabilize.

### 6.2 Test SET-UP

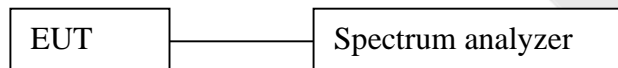

### 6.3 Test Equipment

Same as the equipment listed in 4.3.

### 6.4 Test Results

Test Item	: Number of Hopping Frequency	Test Mode	: CH Low ~ CH High
Test Voltage	: DC 1.5V	Temperature	: 24°C
Test Result	: PASS	Humidity	: 55%RH

Hopping Channel Frequency Range	Quantity of Hopping Channel	Quantity of Hopping Channel
2402-2480	79	> 15



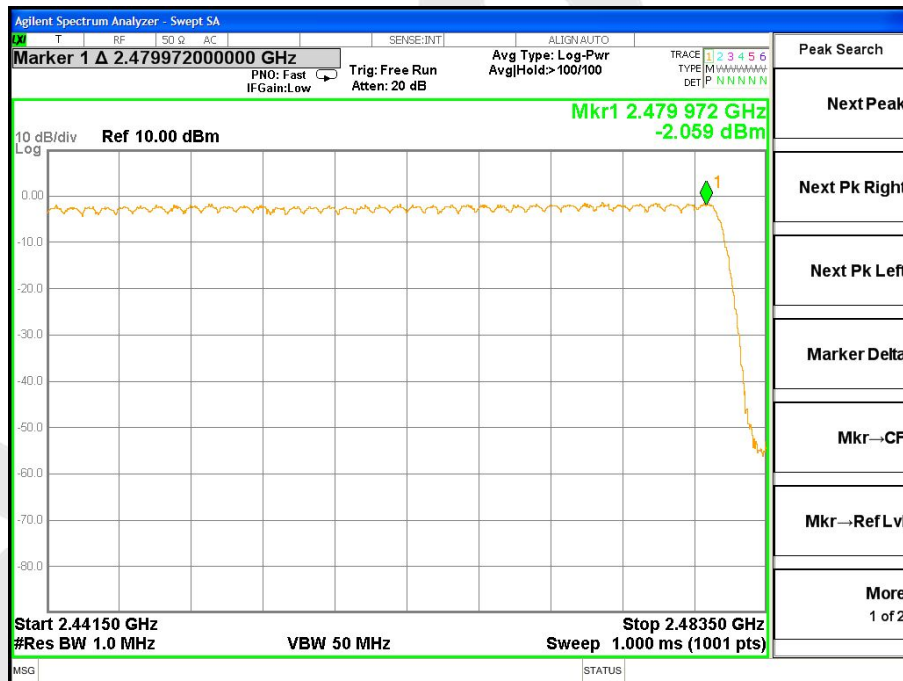
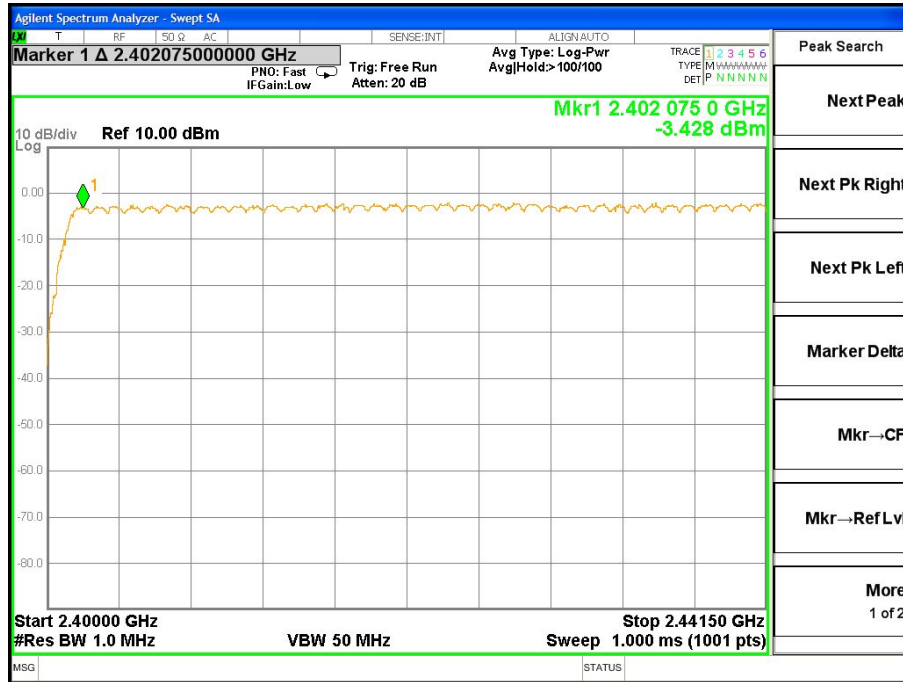

## 7. DWELL TIME TEST

### 7.1 Measurement Procedure

The EUT must have its hopping function enabled. Use the following spectrum analyzer settings:

1. Span= zero span, centered on a hopping channel
2. Set the RBW = 1 MHz.
3. Set the VBW = 1 MHz.
4. Sweep time = as necessary to capture the entire dwell time per hopping channel.
5. Detector function = peak.
6. Trace mode = max hold.
7. Allow trace to fully stabilize.

### 7.2 Test SET-UP

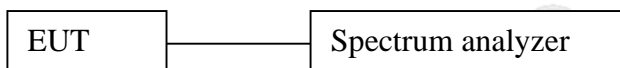

### 7.3 Test Equipment

Same as the equipment listed in 4.3.

### 7.4 Test Results

Test Item	: Time of Occupancy	Test Mode	: CH Low ~ CH High
Test Voltage	: DC 1.5V	Temperature	: 24°C
Test Result	: PASS	Humidity	: 55%RH

Package Type	Pulse width (ms)	Time slot length(ms)	Dwell time (ms)	Limit (s)
DH1	0.364	time slot length *1600/2 /79 * 31.6	116.48	0.4
DH3	1.620	time slot length *1600/4 /79 * 31.6	259.20	0.4
DH5	2.870	time slot length *1600/6 /79 * 31.6	306.13	0.4



DH1



DH3



DH5



/

## 8. MAXIMUM PEAK OUTPUT POWER TEST

### 8.1 Measurement Procedure

- a. Check the calibration of the measuring instrument(SA) using either an internal calibrator or a known signal from an external generator.
- b. Turn on the EUT and connect it to measurement instrument. Then set it to any one convenient frequency within its operating range. Set a reference level on the measuring instrument equal to the highest peak value.
- c. The center frequency of the spectrum analyzer is set to the fundamental frequency and using proper RBW and VBW setting.
- d. Measure the captured power within the band and recording the plot.
- e. Repeat above procedures until all frequencies required were complete.

Using the following spectrum analyzer settings:

1. Span= approximately 5 times the 20dB bandwidth, centered on a hopping channel
2. Set the RBW = 3 MHz.
3. Set the VBW = 3 MHz.
4. Sweep time = auto couple.
5. Detector function = peak.
6. Trace mode = max hold.
7. Allow trace to fully stabilize.

### 8.2 Test SET-UP

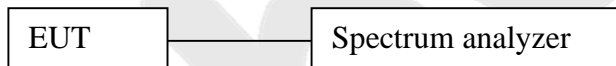

### 8.3 Test Equipment

Same as the equipment listed in 4.3.

### 8.4 Test Results

Test Item	: Max. peak output power	Test Mode	: CH Low ~ CH High
Test Voltage	: DC 1.5V	Temperature	: 24°C
Test Result	: PASS	Humidity	: 55%RH

Channel Frequency (MHz)	Peak Power output(mW)	Peak Power output(dBm)	Peak Power Limit(mW)	Results	Modulation
2402	0.585	-2.327	1000	PASS	BDR
2441	0.687	-1.631	1000	PASS	BDR
2480	0.835	-0.782	1000	PASS	BDR
2402	0.595	-2.257	125	PASS	EDR
2441	0.705	-1.520	125	PASS	EDR
2480	<b>0.847</b>	<b>-0.723</b>	125	PASS	EDR

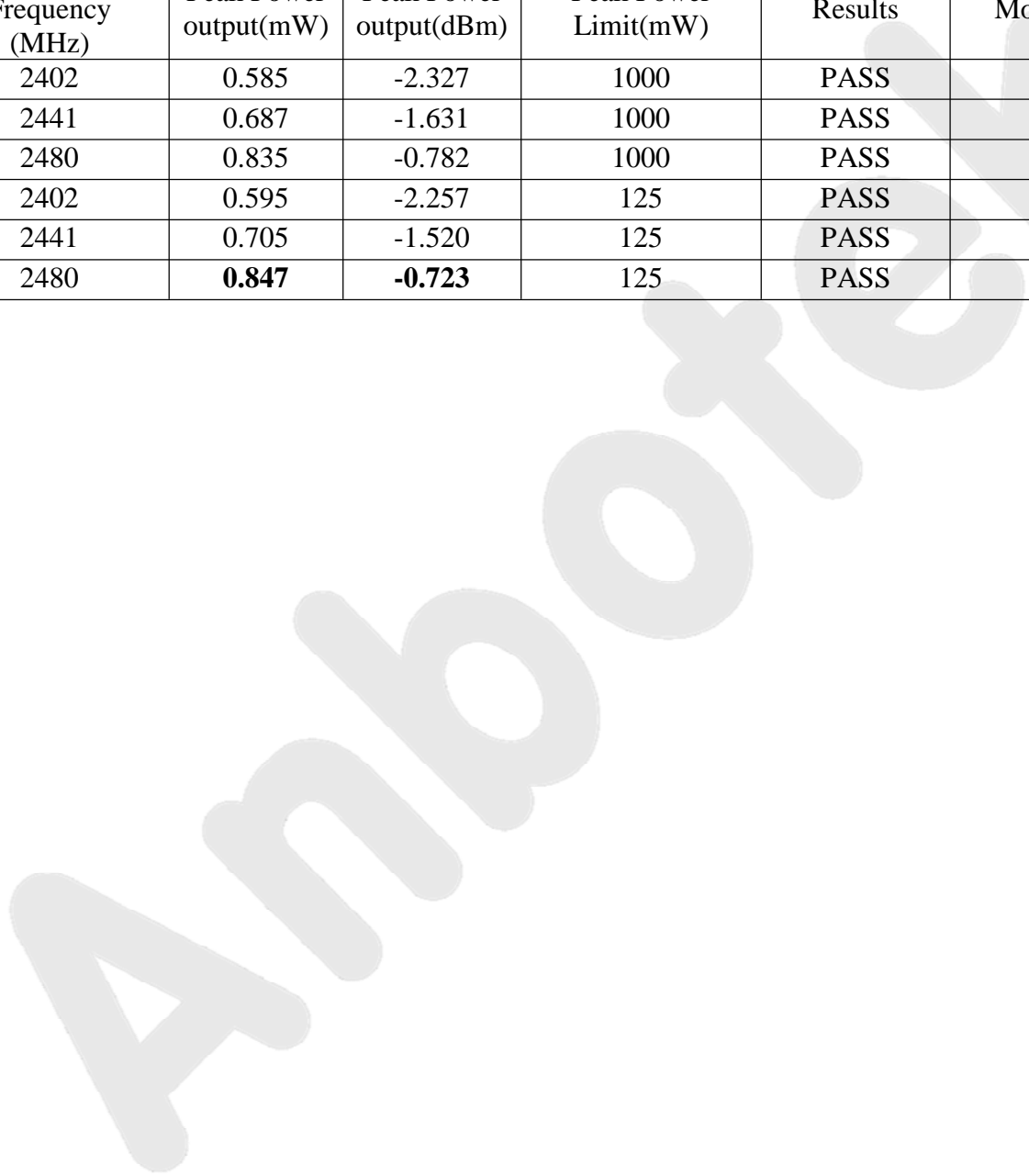

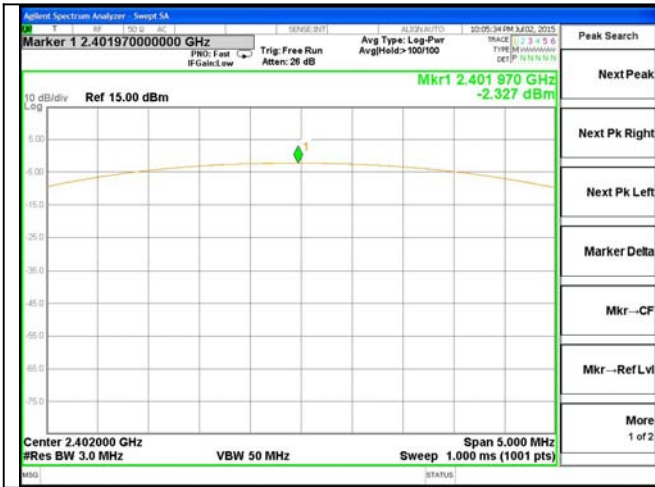

Test Mode: BDR---Low

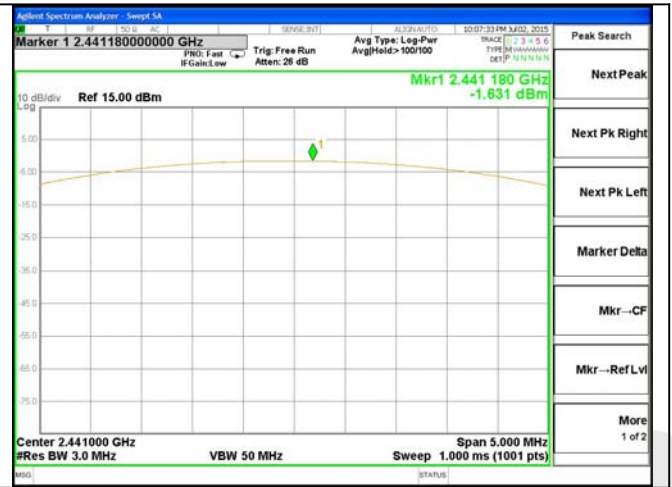

Test Mode: BDR---Mid

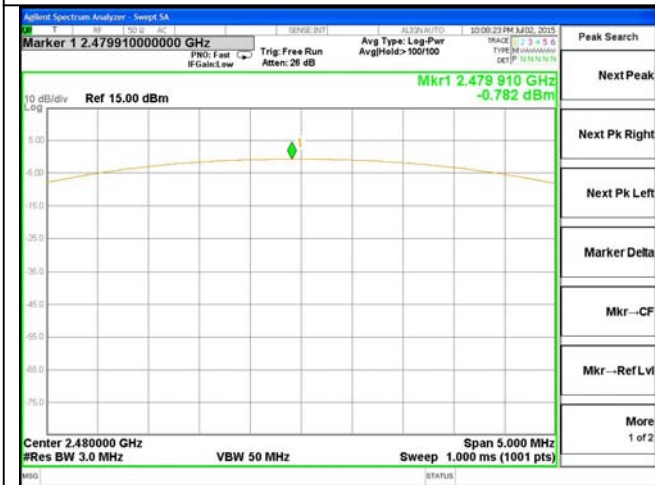

Test Mode: BDR---High

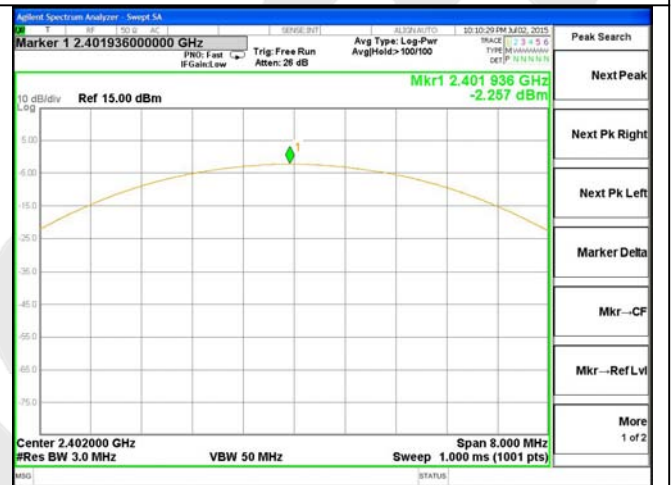

Test Mode: EDR---Low

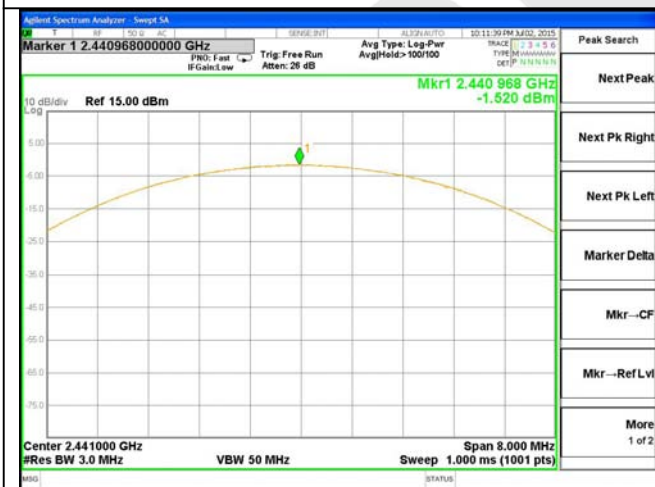

Test Mode: EDR---Mid

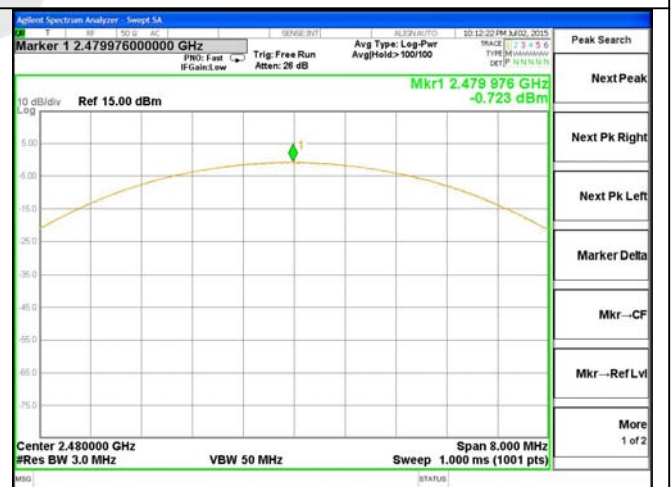

Test Mode: EDR---High

## 9. BAND EDGE TEST

### 9.1 Measurement Procedure

#### A) Conducted Emission method:

1. Check the calibration of the measuring instrument using either an internal calibrator or a known signal from an external generator.
2. Position the EUT without connection to measurement instrument. Put it on the Rotated table and turn on the EUT and make it operate in transmitting mode. Then set it to low Channel and High Channel within its operating range, and make sure the instrument is operated in its linear range.
3. Set both RBW and VBW of spectrum analyzer to 100kHz with a convenient frequency span including 100kHz bandwidth from band edge,
4. Measurement the highest amplitude appearing on spectral display and set it as a reference level. Plot the graph with marking the highest point and edge frequency.
5. Report above procedures until all measured frequencies were complete.

#### B) Radiated Emission method:

The EUT is placed on a turn table which is 1.5 meter high above the ground. The turn table can rotate 360 degrees to determine the position of the maximum emission level. The EUT is set 3 meters away from the receiving antenna which is mounted on a antenna tower. The antenna can be moved up and down from 1 to 4 meters to find out the maximum emission level. Rotated the EUT through three orthogonal axes to determine the maximum emissions, both horizontal and vertical polarization of the antenna are set on test. The EUT is tested in 9\*6\*6 Chamber. for Radiated emissions restricted band RBW= 1 MHz, VBW= 3 MHz.

### 9.2 Test SET-UP

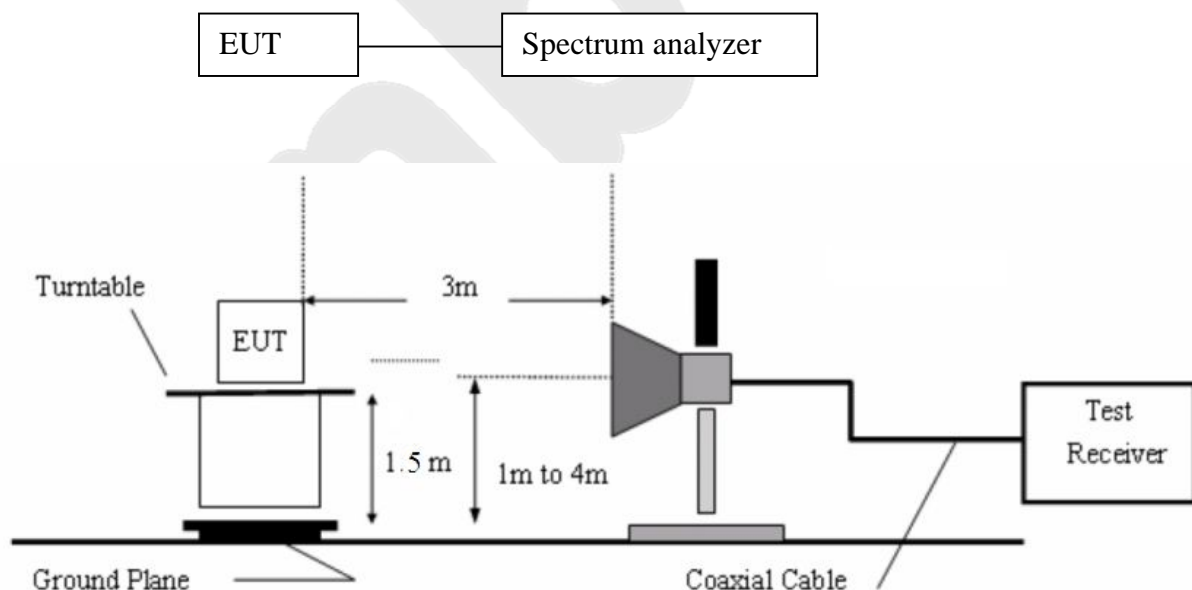

### 9.3 Test Equipment

Same as the equipment listed in 4.3.

### 9.4 Test Results

Pass.

Please refer the following data.

Test Item	: Band eadge	Test Mode	: CH Low ~ CH High
Test Voltage	: DC 1.5V	Temperature	: 24°C
Test Result	: PASS	Humidity	: 55%RH

**For Hopping Mode:**





Test Mode: BDR



Test Mode: BDR

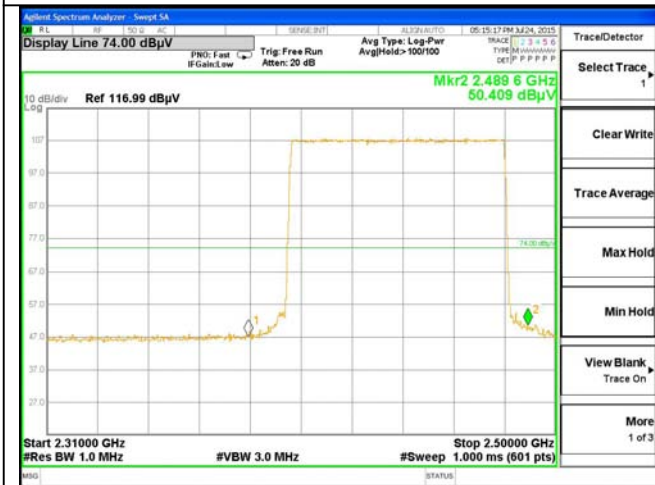

Test Mode: EDR

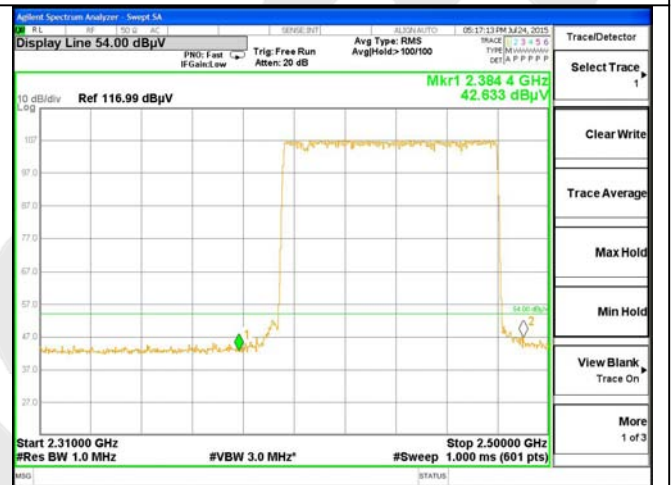

Test Mode: EDR

Test Item	: Band edge	Test Mode	: CH Low ~ CH High
Test Voltage	: DC 1.5V	Temperature	: 24°C
Test Result	: PASS	Humidity	: 55%RH

**For Non-Hopping Mode:**

1. Conducted Test

Frequency (MHz)	Peak Power Output(dBm)	Emission read Value(dBm)	Result of Band edge(dBc)	Band edge Limit(dBc)	Modulation
<2400	-2.319	-58.971	56.652	>20dBc	BDR
	-2.885	-57.612	54.727	>20dBc	EDR
>2483.5	-0.786	-53.311	52.525	>20dBc	BDR
	-1.364	-51.783	50.419	>20dBc	EDR

2. Radiated emission Test

Frequency (MHz)	Antenna polarization (H/V)	Emission (dBuV/m)		Band edge Limit (dBuV/m)		Modulation
		PK	AV	PK	AV	
<2400	V	56.21	39.21	74.00	54.00	BDR
	V	53.58	37.69	74.00	54.00	EDR
>2483.5	V	55.37	37.57	74.00	54.00	BDR
	V	52.90	34.32	74.00	54.00	EDR



Test Mode: BDR

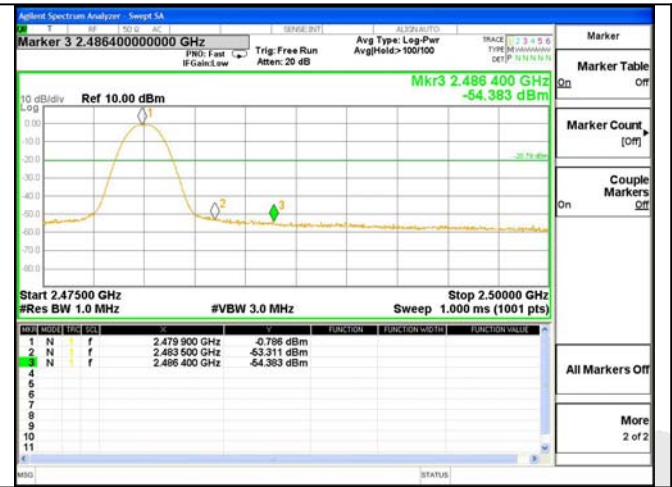

Test Mode: BDR



Test Mode: EDR



Test Mode: EDR

## 10. ANTENNA APPLICATION

### 10.1 Antenna requirement

The EUT'S antenna is met the requirement of FCC part 15C section 15.203 and 15.247.

FCC part 15C section 15.247 requirements:

Systems operating in the 2402-2480MHz band that are used exclusively for fixed, point-to-point operations may employ transmitting antennas with directional gain greater than 6dBi provided the maximum peak output power of the intentional radiator is reduced by 1dB for every 3dB that the directional gain of the antenna exceeds 6dBi.

### 10.2 Result

The EUT's antenna used a PCB Antenna, The antenna's gain is 0.1763dBi and meets the requirement.

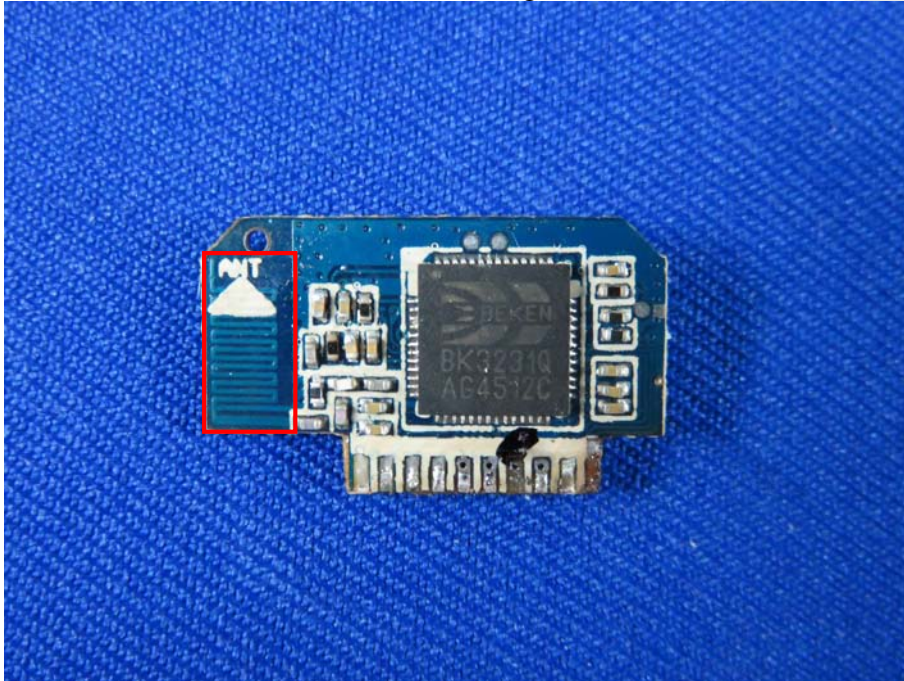



## 11. PHOTOGRAPH

### 11.1 Photo of Radiation Emission Test

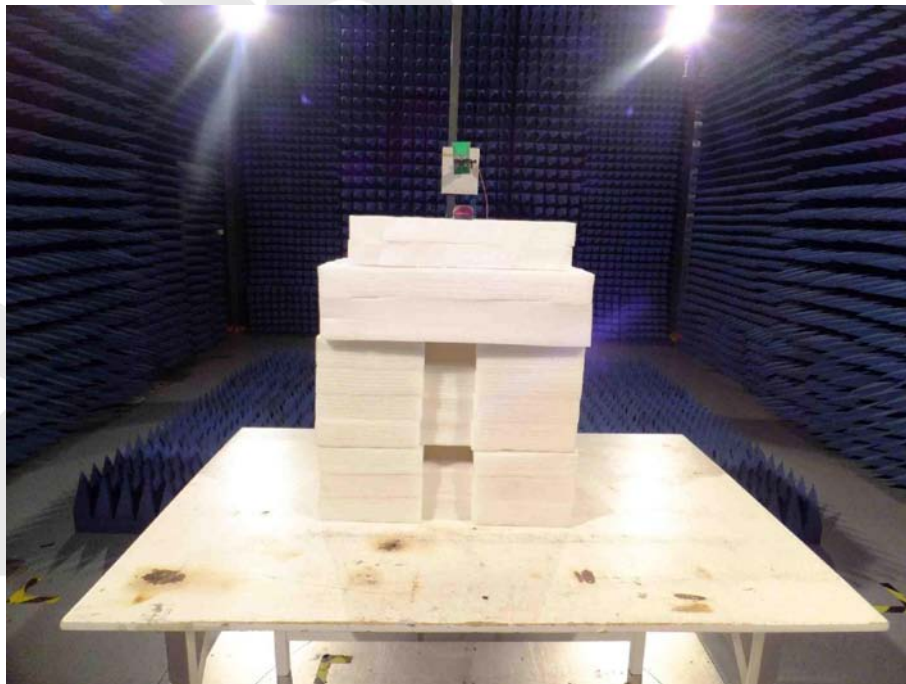

## APPENDIX I (EXTERNAL PHOTOS)

Figure 1  
The EUT-Series View



Figure 2  
The EUT-Top View





Figure 3  
The EUT-Bottom View



Figure 4  
The EUT-Front View



Figure 5  
The EUT-Back View



Figure 6  
The EUT-Right View





Figure 7  
The EUT-Left View



## APPENDIX II (INTERNAL PHOTOS)

Figure 8  
The EUT-Inside View



Figure 9  
PCB of the EUT-Front View

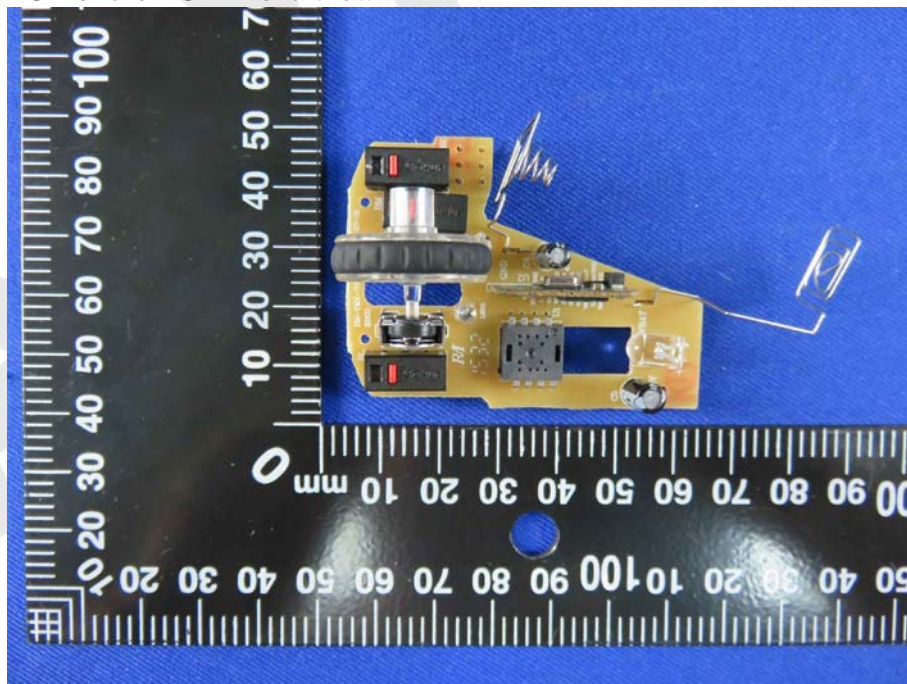



Figure 10  
PCB of the EUT-Back View

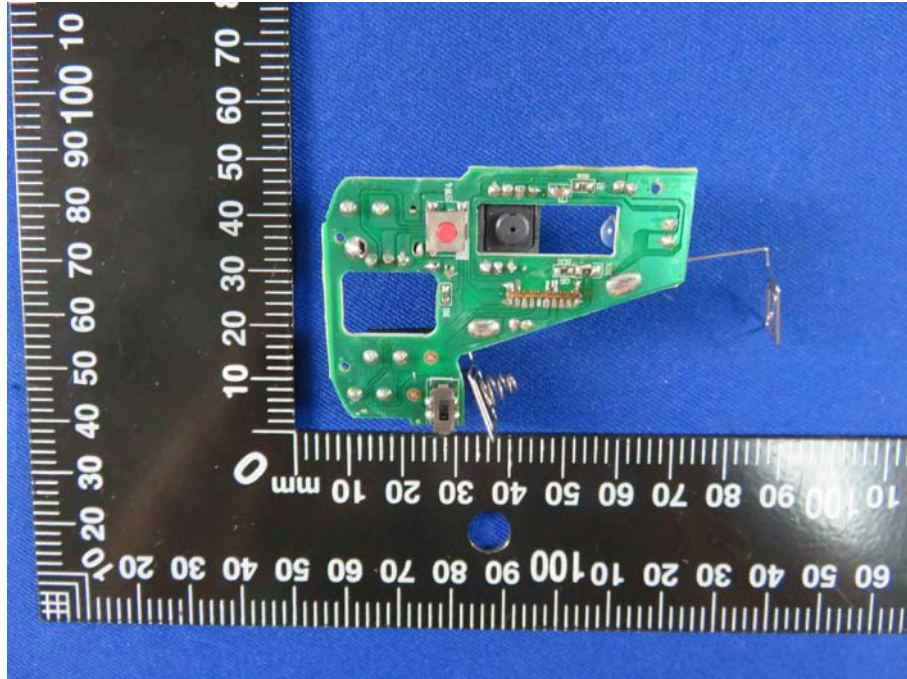

Figure 11  
PCB of the EUT-Front View

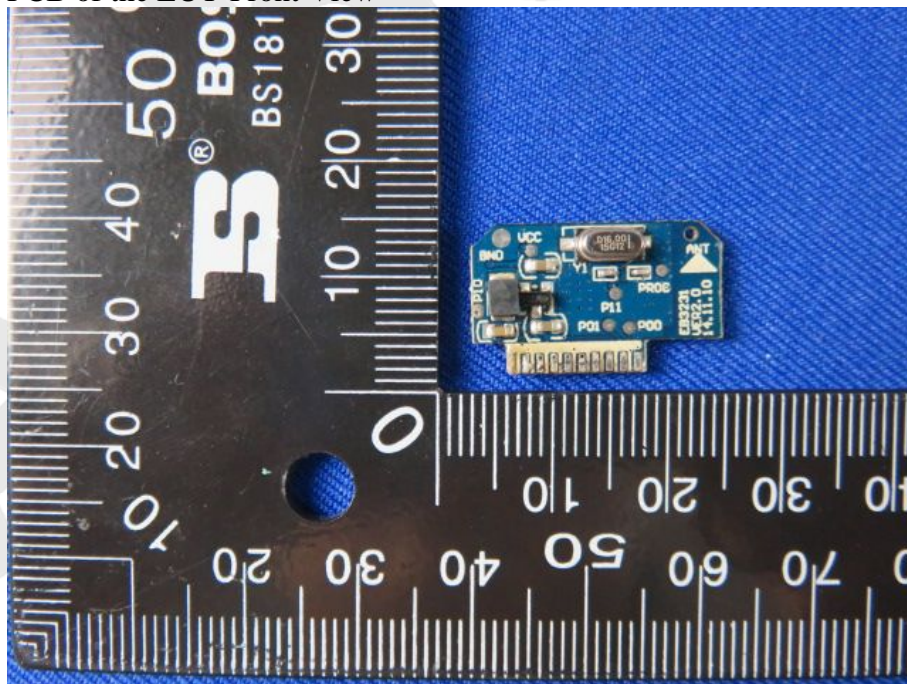

Figure 12  
PCB of the EUT-Back View

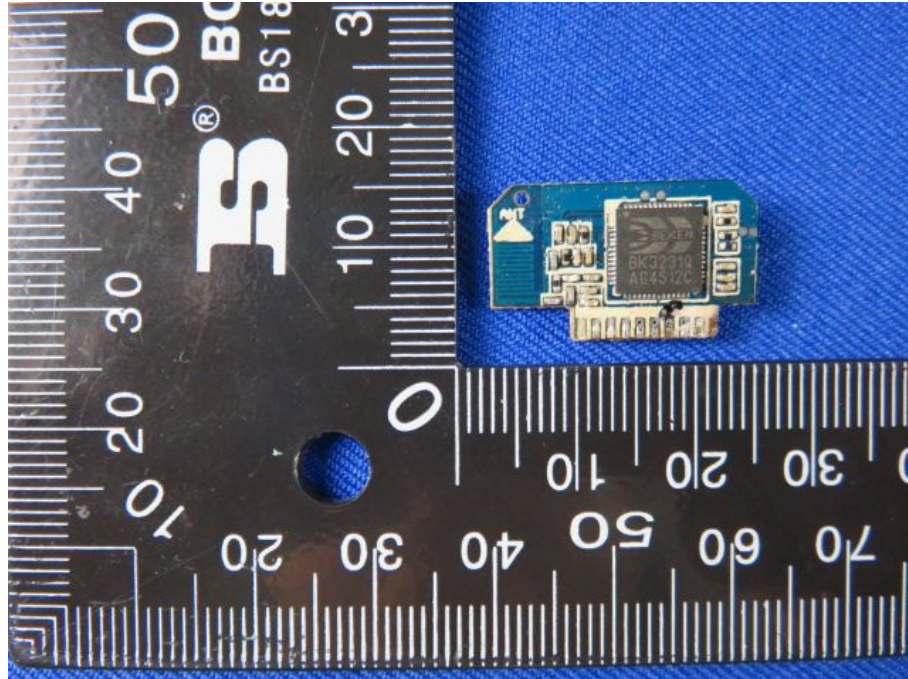

Figure 13  
PCB of the EUT-Front View

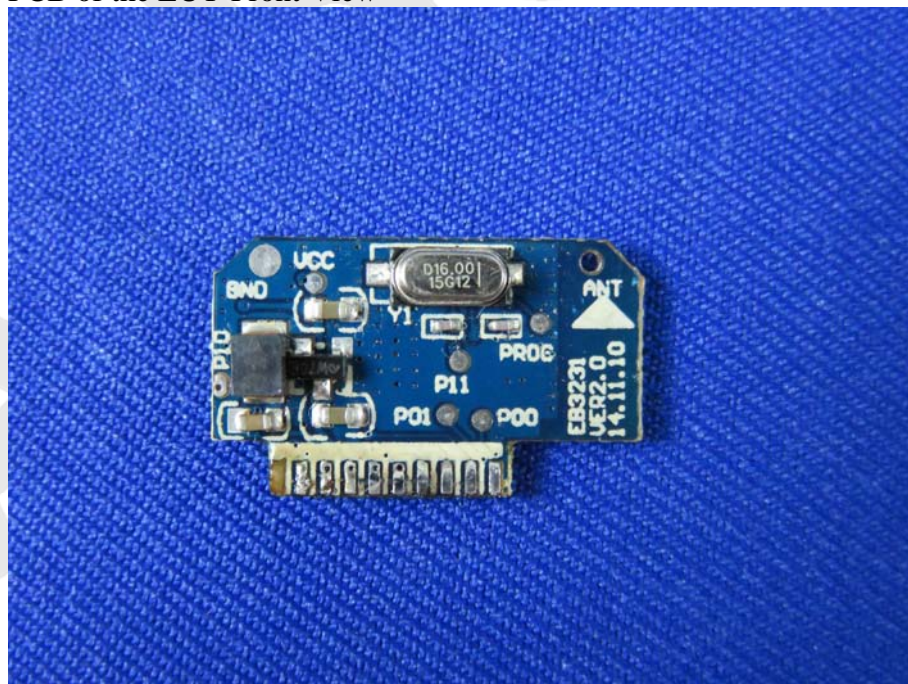



Figure 14  
PCB of the EUT-Back View

