

# AT3216 Series

## Multilayer Chip Antenna

### Features

- ❖ Monolithic SMD with small, low-profile and light-weight type.
- ❖ Wide bandwidth
- ❖ RoHS compliant



### Applications

- ❖ Bluetooth/Wireless LAN/Home RF
- ❖ ISM band 2.4GHz applications

### Specifications

Part Number	Operating Frequency (MHz)	Peak Gain (XZ-V)	Average Gain (XZ-V)	VSWR	Impedance
<b>AT3216</b> <b>-B2R7HAA</b>	2400 ~ 2500	0.5 dBi typ.	-0.5 dBi typ.	2 max.	50 Ω

Q'ty/Reel (pcs) : 3,000pcs  
 Operating Temperature Range : -40 ~ +85 °C  
 Storage Temperature Range : +5 ~ +35 °C, Humidity 45~75%RH  
 Storage Period : 12 months max.  
 Power Capacity : 2W max.

### Part Number

AT    3216    -    B    2R7    HAA    □    □  
 ①        ②        ③        ④        ⑤        ⑥        ⑦

① Type	AT : Antenna	② Dimensions ( L × W )	3.2× 1.6 mm
③ Material Code	B	④ Initial center frequency	2R7=2700MHz
⑤ Specification Code	HAA	⑥ Packaging	T: Tape & Reel B: Bulk
⑦ Soldering	/LF=lead-free		

## Terminal Configuration

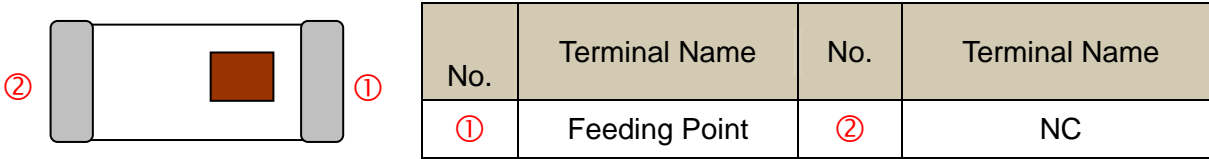

## Dimensions and Recommended PC Board Pattern

Unit : mm

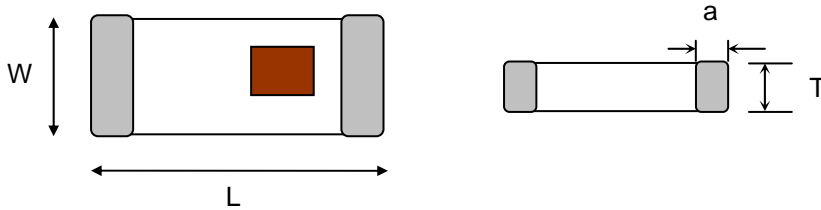

Mark	L	W	T	a
Dimensions	3.2±0.2	1.6±0.2	1.3+ 0.1/-0.2	0.5±0.3

(a) Without Matching Circuits

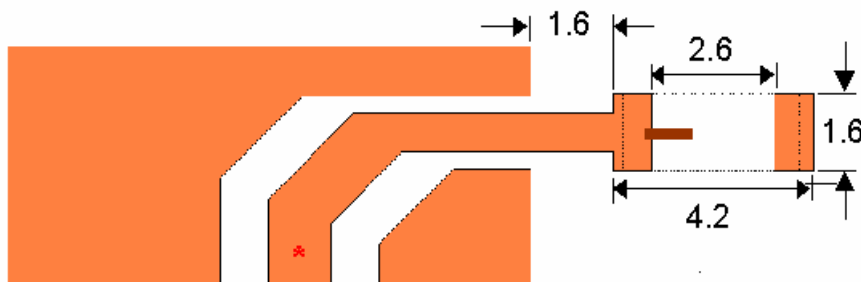

(b) With Matching Circuits

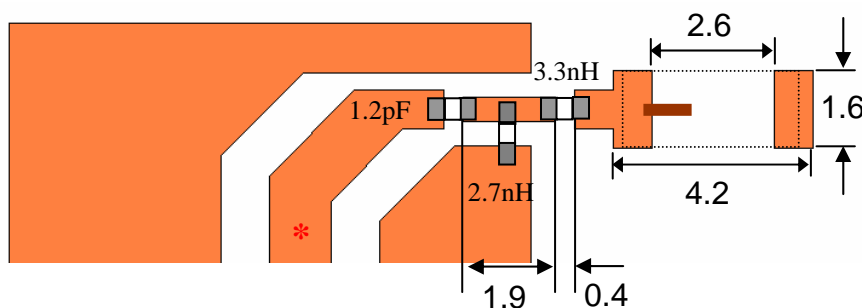

\*Line width should be designed to match 50Ω characteristic impedance, depending on PCB material and thickness.

### Typical Electrical Characteristics (T=25°C)

#### ❖ Test Board

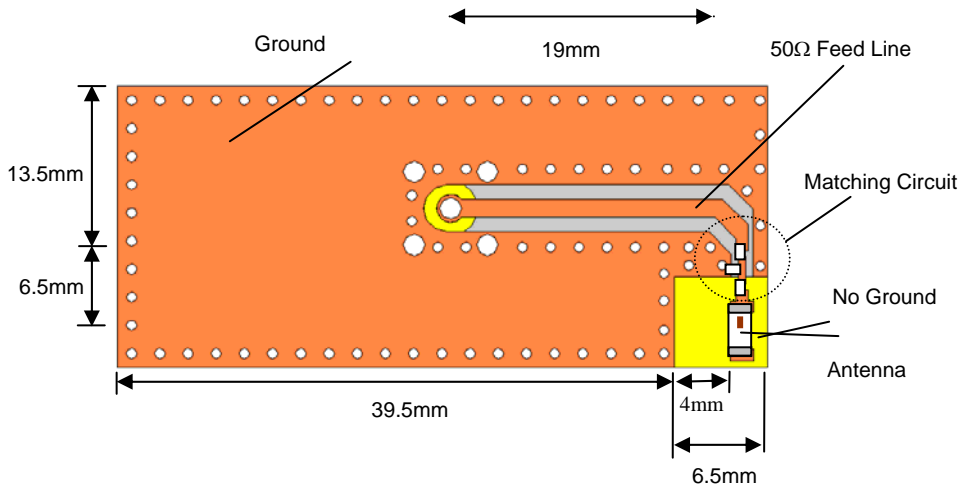

#### ❖ Return Loss

(a) Without Matching Circuits

(b) With Matching Circuits

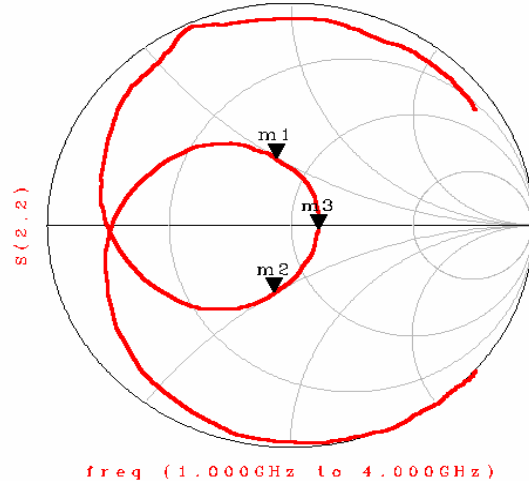
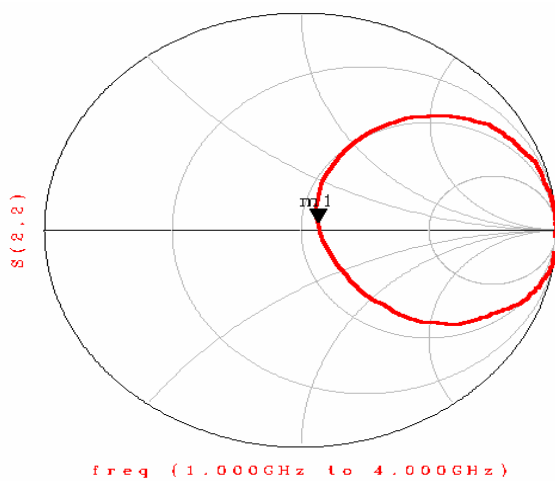
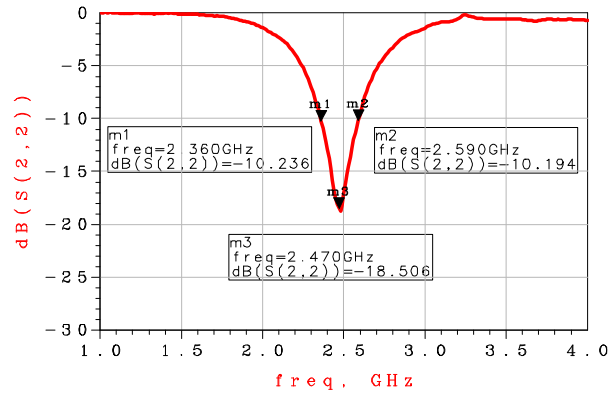
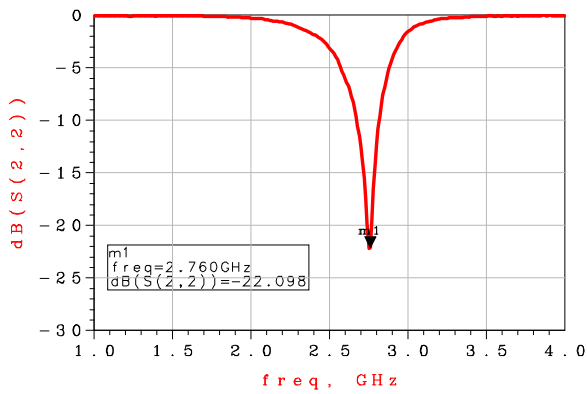

#### Radiation Patterns

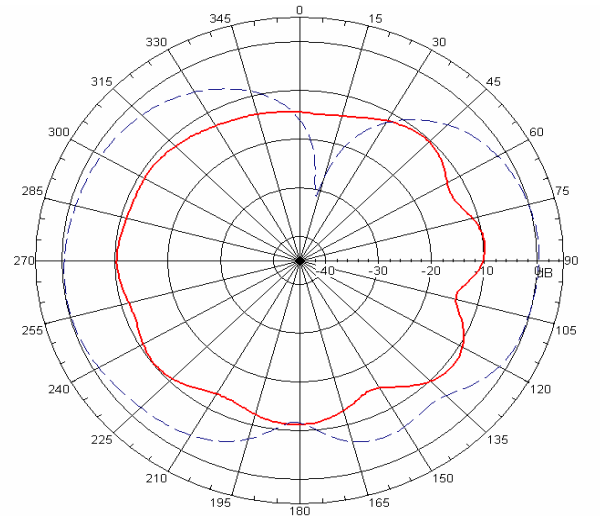
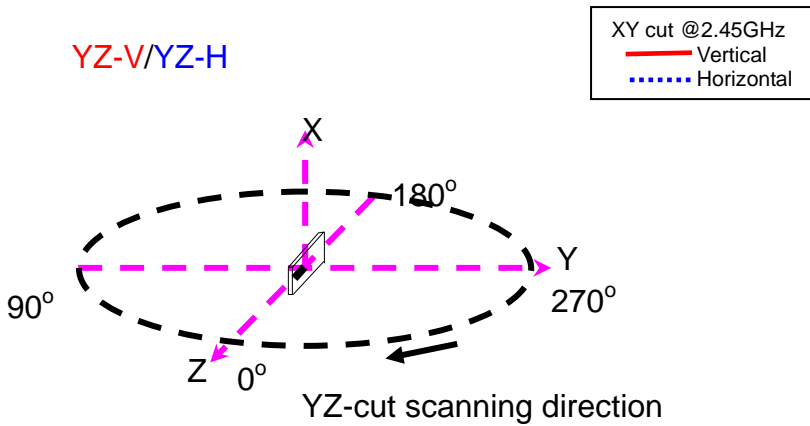
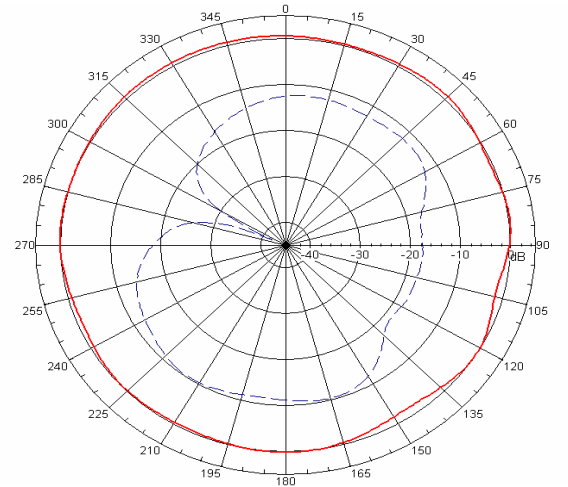
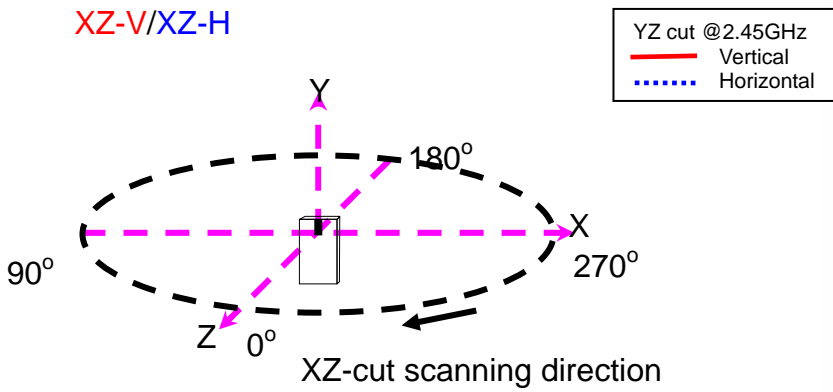
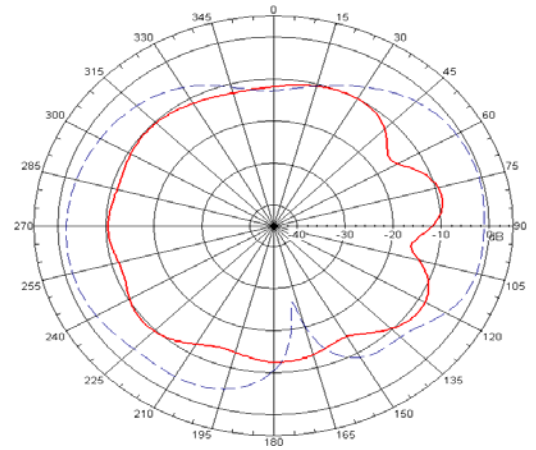
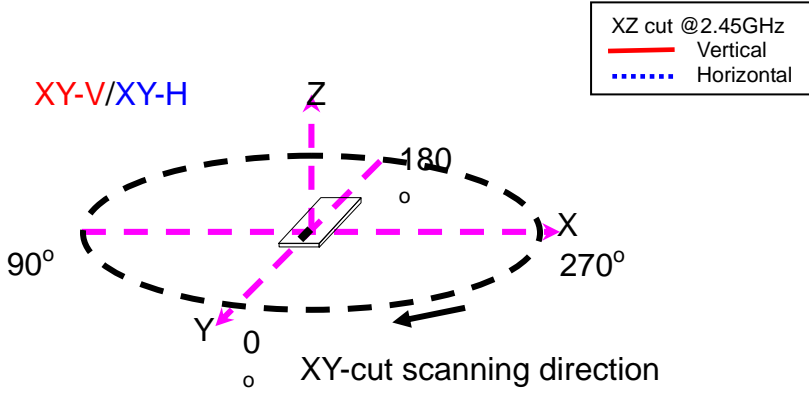

## Taping Specifications

### ❖Tape & Reel Dimensions (Unit: mm) vs. Quantity (pcs)

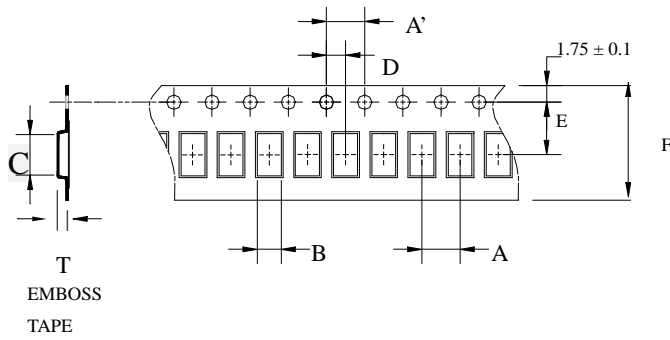

Type	A	A'	B	C	D	E	F	T	Quantity/per reel	Tape material
AT3216	4.0±	4.0±	1.95±	3.5±	2.0±	3.5±	8.00±	1.50±	3,000pcs	Plastic (Embossed)
	0.1	0.05	0.1	0.1	0.05	0.05	0.2	0.1		

### ❖Reel Dimensions (Unit: mm)

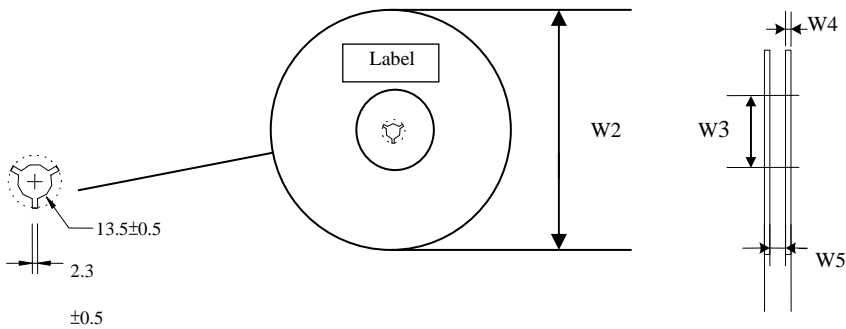

Label: Customer's Name,  
ACX P/N, Q'ty, Date,  
ACX Corp.

Type	W2	W3	W4	W5
AT3216	178±1	60±1	1.4±0.2	17±0.5

### ❖Leader and Trailer Tape

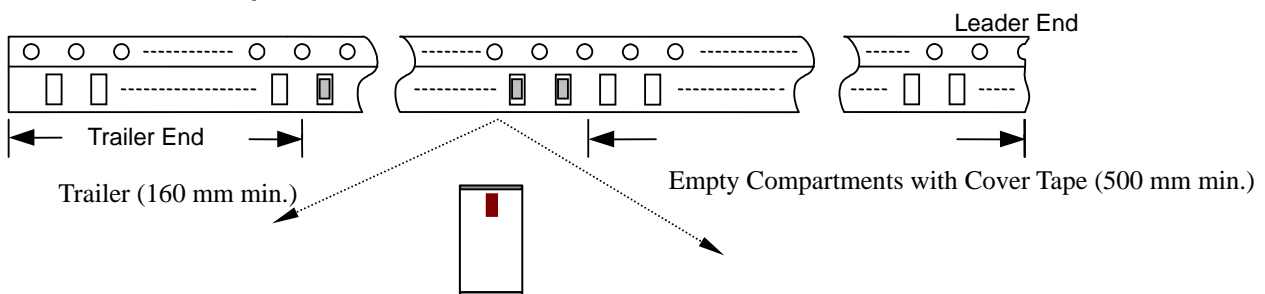

❖ **Peel-off Force**

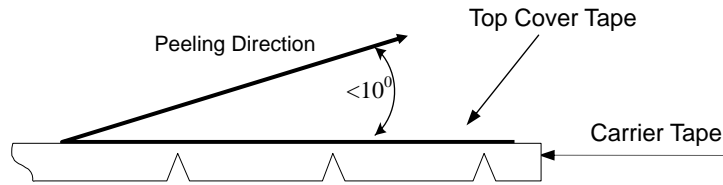

Peel-off force should be in the range of 0.1 – 0.6 N at a peel-off speed of  $300 \pm 10$  mm/min .

❖ **Storage Conditions**

- (1) Temperature: 15 ~35°C , relative humidity (RH): 45~75%.
- (2) Non-corrosive environment

**Notes**

❖ The contents of this data sheet are subject to change without notice. Please confirm the specifications and delivery conditions when placing your order.

## Mechanical & Environmental Characteristics

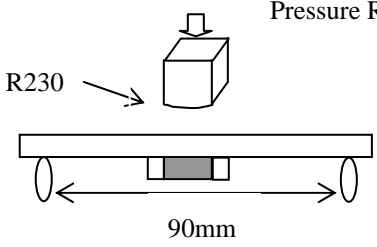
Item	Requirements	Procedure
Solderability	<ol style="list-style-type: none"> <li>No apparent damage</li> <li>More than 95% of the terminal electrode shall be covered with new solder</li> </ol>	<ol style="list-style-type: none"> <li>Preheat: <math>120 \pm 5^\circ\text{C}</math></li> <li>Solder: <math>245 \pm 5^\circ\text{C}</math> for <math>5 \pm 1</math> sec</li> </ol>
Soldering strength (Termination Adhesion)	<ol style="list-style-type: none"> <li>1kg minimum</li> </ol>	<ol style="list-style-type: none"> <li>Solder specimen onto test jig.</li> <li>Apply push force at 0.5mm/s until electrode pads are peeled off or ceramic are broken. Pushing force is applied to longitude direction</li> </ol>
Deflection (Substrate Bending)	<ol style="list-style-type: none"> <li>No apparent damage</li> </ol>	<ol style="list-style-type: none"> <li>Solder specimen onto test jig (FR4, 0.8mm) using the recommend soldering profile.</li> <li>Apply a bending force of 2mm deflection</li> </ol> 
Heat/Humidity Resistance	<ol style="list-style-type: none"> <li>No apparent damage</li> <li>Fulfill the electrical specification after test</li> </ol>	<ol style="list-style-type: none"> <li>Temperature: <math>85 \pm 2^\circ\text{C}</math></li> <li>Humidity: 90% ~ 95% RH</li> <li>Duration: <math>1000 \pm 48</math>hrs</li> <li>Recovery: 1-2hrs</li> </ol>
Thermal shock (Temperature Cycle)	<ol style="list-style-type: none"> <li>No apparent damage</li> <li>Fulfill the electrical specification after test</li> </ol>	<ol style="list-style-type: none"> <li>One cycle/step 1 : <math>125 \pm 5^\circ\text{C}</math> for 30 min step 2 : <math>-40 \pm 5^\circ\text{C}</math> for 30 min</li> <li>No of cycles : 100</li> <li>Recovery: 1-2 hrs</li> </ol>
Low Temperature Resistance	<ol style="list-style-type: none"> <li>No apparent damage</li> <li>Fulfill the electrical specification after test</li> </ol>	<ol style="list-style-type: none"> <li>Temperature: <math>-40 \pm 5^\circ\text{C}</math></li> <li>Duration: <math>500 \pm 24</math>hrs</li> <li>Recovery: 1-2hrs</li> </ol>

## Soldering Conditions

### ❖ Typical Soldering Profile for Lead-free Process

Reflow Soldering :

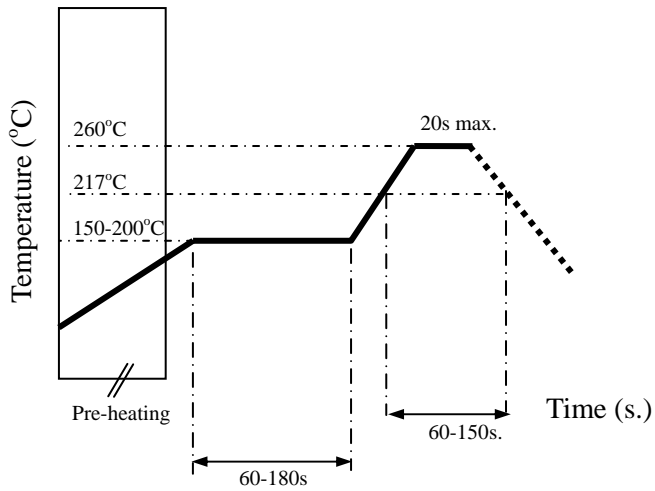

## Notes

❖ The contents of this data sheet are subject to change without notice. Please confirm the specifications and delivery conditions when placing your order.

### **Advanced Ceramic X Corp.**

16 Tzu Chiang Road, Hsinchu Industrial District Hsinchu Hsien 303, Taiwan

TEL:886-3-5987008 FAX:886-3-5987001

E-mail: [acx@acxc.com.tw](mailto:acx@acxc.com.tw)

<http://www.acxc.com.tw>