

FCC REPORT

(Bluetooth)

Applicant: HUNG WAI HOLDINGS LIMITED
Address of Applicant: Unit 11, 12/F., New Commerce Centre, 19 On Sum Street, Shatin, Hong Kong

Equipment Under Test (EUT)

Product Name: 17.3" LCD non-touch screen android quad core player
Model No.: DT173-AS4G1-1080-SL
FCC ID: 2AB6Z-DT173-AS4G1
Applicable standards: FCC CFR Title 47 Part 15 Subpart C Section 15.247
Date of sample receipt: 27 Apr., 2018
Date of Test: 27 Apr., to 25 May, 2018
Date of report issued: 25 May, 2018
Test Result: PASS *

* In the configuration tested, the EUT complied with the standards specified above.

Authorized Signature:



Bruce Zhang
Laboratory Manager

This report details the results of the testing carried out on one sample. The results contained in this test report do not relate to other samples of the same product and does not permit the use of the CCIS product certification mark. The manufacturer should ensure that all products in series production are in conformity with the product sample detailed in this report.

This report may only be reproduced and distributed in full. If the product in this report is used in any configuration other than that detailed in the report, the manufacturer must ensure the new system complies with all relevant standards.

This document cannot be reproduced except in full, without prior written approval of the Company. Any unauthorized alteration, forgery or falsification of the content or appearance of this document is unlawful and offenders may be prosecuted to the fullest extent of the law. Unless otherwise stated the results shown in this test report refer only to the sample(s) tested and such sample(s) are retained for 90 days only.

2 Version

Version No.	Date	Description
00	25 May, 2018	Android player Main board with wireless module (FCC ID: 2AB6Z-A18RK31) and same antenna were used by the device, only AC Power Line Conducted Emission and Radiated Spurious Emission were re-tested.

Tested by:

Carrey Chen

Test Engineer

Date:

25 May, 2018

Reviewed by:

Wimer Zhang

Project Engineer

Date:

25 May, 2018

3 Contents

Page

1	COVER PAGE	1
2	VERSION	2
3	CONTENTS	3
4	TEST SUMMARY	4
5	GENERAL INFORMATION	5
5.1	CLIENT INFORMATION	5
5.2	GENERAL DESCRIPTION OF E.U.T.	5
5.3	TEST ENVIRONMENT AND TEST MODE	6
5.4	DESCRIPTION OF SUPPORT UNITS	6
5.5	MEASUREMENT UNCERTAINTY.....	6
5.6	LABORATORY FACILITY	6
5.7	LABORATORY LOCATION	6
5.8	TEST INSTRUMENTS LIST.....	7
6	TEST RESULTS AND MEASUREMENT DATA	8
6.1	ANTENNA REQUIREMENT.....	8
6.2	CONDUCTED EMISSIONS	9
6.3	CONDUCTED OUTPUT POWER	12
6.4	20DB OCCUPY BANDWIDTH	13
6.5	CARRIER FREQUENCIES SEPARATION.....	14
6.6	HOPPING CHANNEL NUMBER.....	15
6.7	DWELL TIME	16
6.8	PSEUDORANDOM FREQUENCY HOPPING SEQUENCE	17
6.9	BAND EDGE.....	18
6.9.1	Conducted Emission Method	18
6.9.2	Radiated Emission Method	19
6.10	SPURIOUS EMISSION.....	32
6.10.1	Conducted Emission Method.....	32
6.10.2	Radiated Emission Method.....	33
7	TEST SETUP PHOTO	38
8	EUT CONSTRUCTIONAL DETAILS	39

4 Test Summary

Test Items	Section in CFR 47	Result
Antenna Requirement	15.203 & 15.247 (c)	Pass*
AC Power Line Conducted Emission	15.207	Pass
Conducted Peak Output Power	15.247 (b)(1)	Pass*
20dB Occupied Bandwidth	15.247 (a)(1)	Pass*
Carrier Frequencies Separation	15.247 (a)(1)	Pass*
Hopping Channel Number	15.247 (a)(1)	Pass*
Dwell Time	15.247 (a)(1)	Pass*
Spurious Emission	15.205 & 15.209	Pass
Band Edge	15.247(d)	Pass
<p><i>Pass: The EUT complies with the essential requirements in the standard.</i></p> <p><i>Pass*: Please refer to the FCC ID: 2AB6Z-A18RK31</i></p>		

5 General Information

5.1 Client Information

Applicant:	HUNG WAI HOLDINGS LIMITED
Address:	Unit 11, 12/F., New Commerce Centre, 19 On Sum Street, Shatin, Hong Kong
Manufacturer:	HUNG WAI ELECTRONICS (HUIZHOU) LTD
Address:	3rd floor, NO. 1, Minfeng Road, Huinan High and New Technology Industry Park, Huiao Avenue, Huizhou City, Guangdong

5.2 General Description of E.U.T.

Product Name:	17.3" LCD non-touch screen android quad core player
Model No.:	DT173-AS4G1-1080-SL
Operation Frequency:	2402MHz~2480MHz
Transfer rate:	1/2/3 Mbits/s
Number of channel:	79
Modulation type:	GFSK, $\pi/4$ -DQPSK, 8DPSK
Modulation technology:	FHSS
Antenna Type:	External Antenna
Antenna gain:	2.0 dBi
Power supply:	AC 120V/60Hz
AC adapter:	Model No.:PS30D120K 2000UD Input: AC100-240V, 50/60Hz, 800mA Output: DC 12V, 2000mA

Operation Frequency each of channel for GFSK, $\pi/4$ -DQPSK, 8DPSK

Channel	Frequency	Channel	Frequency	Channel	Frequency	Channel	Frequency
0	2402MHz	20	2422MHz	40	2442MHz	60	2462MHz
1	2403MHz	21	2423MHz	41	2443MHz	61	2463MHz
2	2404MHz	22	2424MHz	42	2444MHz	62	2464MHz
3	2405MHz	23	2425MHz	43	2445MHz	63	2465MHz
4	2406MHz	24	2426MHz	44	2446MHz	64	2466MHz
5	2407MHz	25	2427MHz	45	2447MHz	65	2467MHz
...
15	2417MHz	35	2437MHz	55	2457MHz	75	2477MHz
16	2418MHz	36	2438MHz	56	2458MHz	76	2478MHz
17	2419MHz	37	2439MHz	57	2459MHz	77	2479MHz
18	2420MHz	38	2440MHz	58	2460MHz	78	2480MHz
19	2421MHz	39	2441MHz	59	2461MHz		

Remark: Channel 0, 39 & 78 selected for GFSK, $\pi/4$ -DQPSK and 8DPSK.

5.3 Test environment and test mode

Operating Environment:	
Temperature:	24.0 °C
Humidity:	54 % RH
Atmospheric Pressure:	1010 mbar
Test Modes:	
Non-hopping mode:	Keep the EUT in continuous transmitting mode with worst case data rate.
Hopping mode:	Keep the EUT in hopping mode.
Remark	GFSK (1 Mbps) is the worst case mode.
The sample was placed 0.8m (below 1GHz)/1.5m (above 1GHz) above the ground plane of 3m chamber*. Measurements in both horizontal and vertical polarities were performed. During the test, each emission was maximized by: having the EUT continuously working with a fresh battery, investigated all operating modes, rotated about all 3 axis (X, Y & Z) and considered typical configuration to obtain worst position, manipulating interconnecting cables, rotating the turntable, varying antenna height from 1m to 4m in both horizontal and vertical polarizations. The emissions worst-case are shown in Test Results of the following pages.	

5.4 Description of Support Units

The EUT has been tested as an independent unit.

5.5 Measurement Uncertainty

Parameters	Expanded Uncertainty
Conducted Emission (9kHz ~ 30MHz)	2.14 dB (k=2)
Radiated Emission (9kHz ~ 30MHz)	4.24 dB (k=2)
Radiated Emission (30MHz ~ 1000MHz)	4.35 dB (k=2)
Radiated Emission (1GHz ~ 18GHz)	4.44 dB (k=2)
Radiated Emission (18GHz ~ 26.5GHz)	4.56 dB (k=2)

5.6 Laboratory Facility

The test facility is recognized, certified, or accredited by the following organizations:

- **FCC - Registration No.: 727551**

Shenzhen Zhongjian Nanfang Testing Co., Ltd. has been accredited as a testing laboratory by FCC (Federal Communications Commission). The Registration No. is 727551.

- **IC - Registration No.: 10106A-1**

The 3m Semi-anechoic chamber of Shenzhen Zhongjian Nanfang Testing Co., Ltd. has been Registered by Certification and Engineering Bureau of Industry Canada for radio equipment testing with Registration No.: 10106A-1.

- **CNAS - Registration No.: CNAS L6048**

Shenzhen Zhongjian Nanfang Testing Co., Ltd. is accredited to ISO/IEC 17025:2005 General Requirements for the Competence of Testing and Calibration laboratories for the competence of testing. The Registration No. is CNAS L6048.

- **A2LA - Registration No.: 4346.01**

This laboratory is accredited in accordance with the recognized International Standard ISO/IEC 17025:2005 General requirements for the competence of testing and calibration laboratories. The test scope can be found as below link: <https://portal.a2la.org/scopepdf/4346-01.pdf>

5.7 Laboratory Location

Shenzhen Zhongjian Nanfang Testing Co., Ltd.
 Address: No. B-C, 1/F., Building 2, Laodong No.2 Industrial Park, Xixiang Road,
 Bao'an District, Shenzhen, Guangdong, China
 Tel: +86-755-23118282, Fax: +86-755-23116366
 Email: info@ccis-cb.com, Website: http://www.ccis-cb.com

5.8 Test Instruments list

Radiated Emission:					
Test Equipment	Manufacturer	Model No.	Serial No.	Cal. Date (mm-dd-yy)	Cal. Due date (mm-dd-yy)
3m SAC	SAEMC	9m*6m*6m	966	07-22-2017	07-21-2020
Loop Antenna	SCHWARZBECK	FMZB1519B	00044	02-25-2018	02-24-2019
BiConiLog Antenna	SCHWARZBECK	VULB9163	497	02-25-2018	02-24-2019
Horn Antenna	SCHWARZBECK	BBHA9120D	916	02-25-2018	02-24-2019
EMI Test Software	AUDIX	E3	6.110919b	N/A	N/A
Pre-amplifier	HP	8447D	2944A09358	03-07-2018	03-06-2019
Pre-amplifier	CD	PAP-1G18	11804	03-07-2018	03-06-2019
Spectrum analyzer	Rohde & Schwarz	FSP30	101454	03-07-2018	03-06-2019
EMI Test Receiver	Rohde & Schwarz	ESRP7	101070	03-07-2018	03-06-2019
Cable	ZDECL	Z108-NJ-NJ-81	1608458	03-07-2018	03-06-2019
Cable	MICRO-COAX	MFR64639	K10742-5	03-07-2018	03-06-2019
Cable	SUHNER	SUCOFLEX100	58193/4PE	03-07-2018	03-06-2019

Conducted Emission:					
Test Equipment	Manufacturer	Model No.	Serial No.	Cal. Date (mm-dd-yy)	Cal. Due date (mm-dd-yy)
EMI Test Receiver	Rohde & Schwarz	ESCI	101189	03-07-2018	03-06-2019
Pulse Limiter	SCHWARZBECK	OSRAM 2306	9731	03-07-2018	03-06-2019
LISN	CHASE	MN2050D	1447	02-25-2018	02-24-2019
LISN	Rohde & Schwarz	ESH3-Z5	8438621/010	07-21-2017	07-20-2018
Cable	HP	10503A	N/A	03-07-2018	03-06-2019
EMI Test Software	AUDIX	E3	6.110919b	N/A	N/A

6 Test results and measurement data

6.1 Antenna Requirement

Standard requirement:	FCC Part 15 C Section 15.203 & 247(c)
<p>15.203 requirement: An intentional radiator shall be designed to ensure that no antenna other than that furnished by the responsible party shall be used with the device. The use of a permanently attached antenna or of an antenna that uses a unique coupling to the intentional radiator, the manufacturer may design the unit so that a broken antenna can be replaced by the user, but the use of a standard antenna jack or electrical connector is prohibited.</p> <p>15.247(c) (1)(i) requirement: (i) Systems operating in the 2400-2483.5 MHz band that is used exclusively for fixed. Point-to-point operations may employ transmitting antennas with directional gain greater than 6dBi provided the maximum conducted output power of the intentional radiator is reduced by 1 dB for every 3 dB that the directional gain of the antenna exceeds 6dBi.</p>	
E.U.T Antenna:	
<p>The Bluetooth antenna is an External antenna which permanently attached, and the best case gain of the antenna is 2.0 dBi.</p>	
	

6.2 Conducted Emissions

Test Requirement:	FCC Part 15 C Section 15.207		
Test Method:	ANSI C63.10:2013		
Test Frequency Range:	150 kHz to 30 MHz		
Class / Severity:	Class B		
Receiver setup:	RBW=9 kHz, VBW=30 kHz, Sweep time=auto		
Limit:	Frequency range (MHz)	Limit (dBuV)	
		Quasi-peak	Average
	0.15-0.5	66 to 56*	56 to 46*
	0.5-5	56	46
	5-30	60	50
* Decreases with the logarithm of the frequency.			
Test setup:	<p>Remark: E.U.T: Equipment Under Test LISN: Line Impedance Stabilization Network Test table height=0.8m</p>		
Test procedure:	<ol style="list-style-type: none"> 1. The E.U.T and simulators are connected to the main power through a line impedance stabilization network (L.I.S.N.). This provides a 50ohm/50uH coupling impedance for the measuring equipment. 2. The peripheral devices are also connected to the main power through a LISN that provides a 50ohm/50uH coupling impedance with 50ohm termination. (Please refer to the block diagram of the test setup and photographs). 3. Both sides of A.C. line are checked for maximum conducted interference. In order to find the maximum emission, the relative positions of equipment and all of the interface cables must be changed according to ANSI C63.4: 2014 on conducted measurement. 		
Test Instruments:	Refer to section 5.8 for details		
Test mode:	Hopping mode		
Test results:	Pass		

Measurement Data:

Test Phase: Line

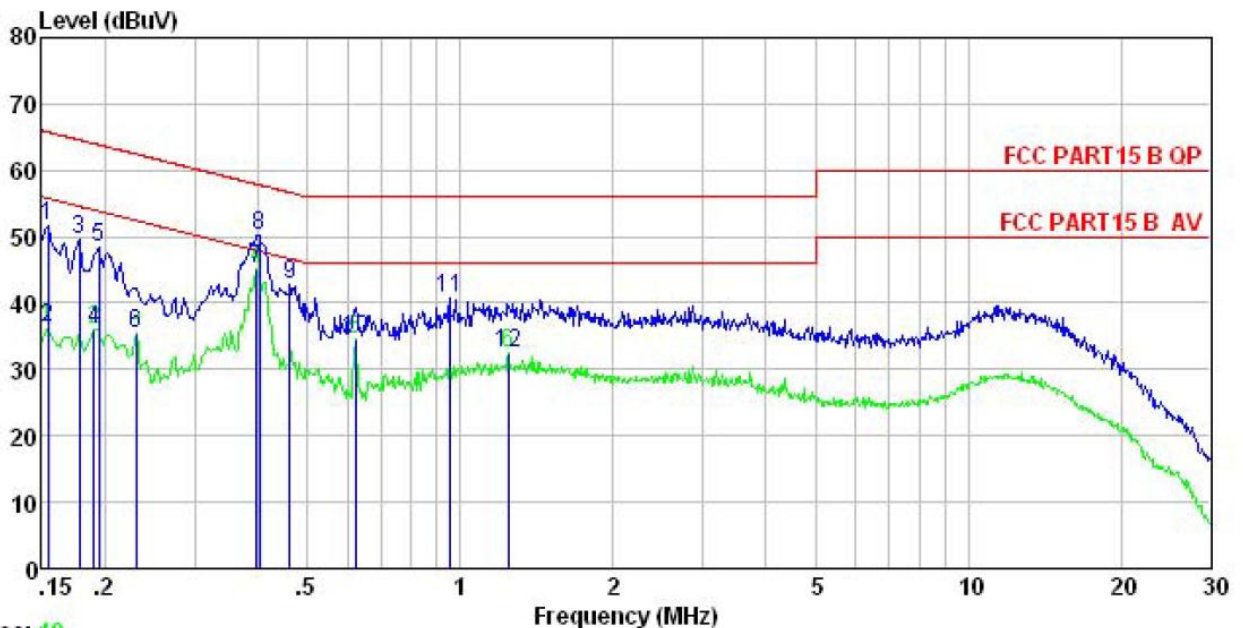

Trace: 19

Site : CCIS Shielding Room
 Condition : FCC PART15 B QP LISN LINE
 EUT : 17.3" LCD non-touch screen android quad
 : core player
 Model : DT173-AS4G1-1080-SL
 Test mode : BT Mode
 Power Rating : AC 120V/60Hz
 Environment : Temp:25.5°C Humi:55%
 Test Engineer: Yaro
 Remark :

	Read Freq	Level	LISN Factor	Cable Loss	Level	Limit	Over	Remark
	MHz	dBuV	dB	dB	dBuV	dBuV	dB	
1	0.154	40.76	0.18	10.78	51.72	65.78	-14.06	QP
2	0.154	25.32	0.18	10.78	36.28	55.78	-19.50	Average
3	0.178	38.72	0.16	10.77	49.65	64.59	-14.94	QP
4	0.190	25.10	0.16	10.76	36.02	54.02	-18.00	Average
5	0.194	37.39	0.15	10.76	48.30	63.84	-15.54	QP
6	0.230	24.60	0.14	10.75	35.49	52.44	-16.95	Average
7	0.398	34.30	0.12	10.72	45.14	47.90	-2.76	Average
8	0.402	39.45	0.12	10.72	50.29	57.81	-7.52	QP
9	0.461	32.08	0.12	10.74	42.94	56.67	-13.73	QP
10	0.621	23.55	0.13	10.77	34.45	46.00	-11.55	Average
11	0.953	29.70	0.13	10.86	40.69	56.00	-15.31	QP
12	1.242	21.48	0.13	10.90	32.51	46.00	-13.49	Average

Notes:

1. An initial pre-scan was performed on the line and neutral lines with peak detector.
2. Quasi-Peak and Average measurement were performed at the frequencies with maximized peak emission.
3. Final Level = Receiver Read level + LISN Factor + Cable Loss.

Test Phase: Neutral

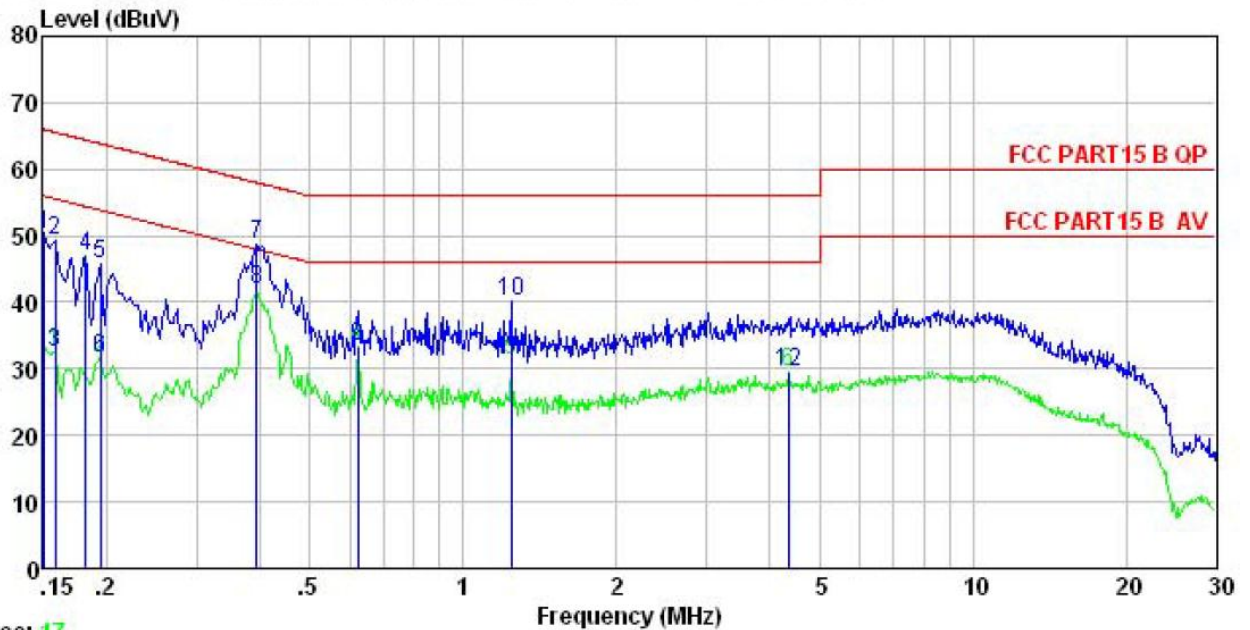

Trace: 17

Site : CCIS Shielding Room
 Condition : FCC PART15 B QP LISN NEUTRAL
 EUT : 17.3" LCD non-touch screen android quad
 : core player
 Model : DT173-AS4G1-1080-SL
 Test mode : BT Mode
 Power Rating : AC 120V/60Hz
 Environment : Temp:25.5°C Humi:55%
 Test Engineer: Yaro
 Remark :

	Read Freq	LISN Level	Cable Factor	Cable Loss	Level	Limit	Over	Remark
	MHz	dBuV	dB	dB	dBuV	dBuV	dB	
1	0.151	38.33	0.99	10.78	50.10	65.96	-15.86	QP
2	0.158	37.59	0.98	10.77	49.34	65.56	-16.22	QP
3	0.158	20.77	0.98	10.77	32.52	55.56	-23.04	Average
4	0.182	35.18	0.94	10.77	46.89	64.42	-17.53	QP
5	0.194	34.07	0.93	10.76	45.76	63.84	-18.08	QP
6	0.194	20.02	0.93	10.76	31.71	53.84	-22.13	Average
7	0.393	37.04	0.97	10.72	48.73	57.99	-9.26	QP
8	0.393	30.22	0.97	10.72	41.91	47.99	-6.08	Average
9	0.621	21.87	0.97	10.77	33.41	46.00	-12.59	Average
10	1.242	28.14	0.97	10.90	40.01	56.00	-15.99	QP
11	1.242	19.54	0.97	10.90	31.41	46.00	-14.59	Average
12	4.338	17.78	1.00	10.88	29.66	46.00	-16.34	Average

Notes:

1. An initial pre-scan was performed on the line and neutral lines with peak detector.
2. Quasi-Peak and Average measurement were performed at the frequencies with maximized peak emission.
3. Final Level = Receiver Read level + LISN Factor + Cable Loss.

6.3 Conducted Output Power

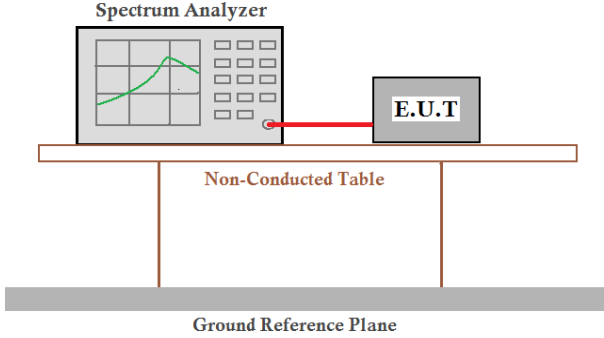
Test Requirement:	FCC Part 15 C Section 15.247 (b)(1)
Test Method:	ANSI C63.10:2013 and DA00-705
Receiver setup:	RBW=1MHz, VBW=3MHz, Detector=Peak (If 20dB BW ≤1 MHz) RBW=3MHz, VBW=10MHz, Detector=Peak (If 20dB BW > 1 MHz and < 3MHz)
Limit:	For frequency hopping systems operating in the 2400-2483.5 MHz band employing at least 75 non-overlapping hopping channels: 1 watt. For all other frequency hopping systems in the 2400-2483.5 MHz band: 0.125 watts.
Test setup:	 <p>The diagram illustrates the test setup. A Spectrum Analyzer is connected to an E.U.T. (Equipment Under Test) via a red cable. Both the Spectrum Analyzer and the E.U.T. are placed on a Non-Conducted Table. The table is supported by two vertical legs. Below the table is a Ground Reference Plane.</p>
Test Instruments:	Refer to section 5.8 for details
Test mode:	Non-hopping mode
Test results:	Please refer to the FCC ID: 2AB6Z-A18RK31

6.4 20dB Occupy Bandwidth

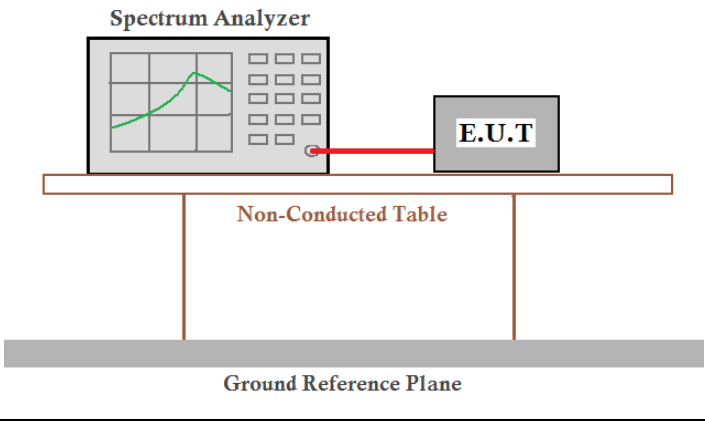
Test Requirement:	FCC Part 15 C Section 15.247 (a)(1)
Test Method:	ANSI C63.10:2013 and DA00-705
Receiver setup:	RBW=30 kHz, VBW=100 kHz, detector=Peak
Limit:	NA
Test setup:	 <p>The diagram illustrates the test setup. A Spectrum Analyzer is connected to an E.U.T. (Equipment Under Test) via a red cable. Both the Spectrum Analyzer and the E.U.T. are placed on a Non-Conducted Table. The table is supported by two legs and sits on a Ground Reference Plane, which is represented by a thick grey bar at the bottom of the diagram.</p>
Test Instruments:	Refer to section 5.8 for details
Test mode:	Non-hopping mode
Test results:	Please refer to the FCC ID: 2AB6Z-A18RK31

6.5 Carrier Frequencies Separation

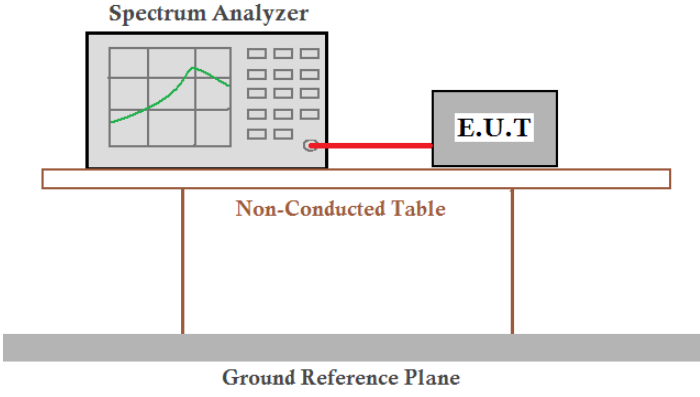
Test Requirement:	FCC Part 15 C Section 15.247 (a)(1)
Test Method:	ANSI C63.10:2013 and DA00-705
Receiver setup:	RBW=100 kHz, VBW=300 kHz, detector=Peak
Limit:	a) 0.025MHz or the 20dB bandwidth (whichever is greater) b) 0.025MHz or 2/3 of the 20dB bandwidth (whichever is greater)
Test setup:	 <p>The diagram illustrates the test setup. A Spectrum Analyzer is connected via a red cable to an E.U.T. (Equipment Under Test). Both are placed on a Non-Conducted Table. Below the table is a Ground Reference Plane.</p>
Test Instruments:	Refer to section 5.8 for details
Test mode:	Hopping mode
Test results:	Please refer to the FCC ID: 2AB6Z-A18RK31

6.6 Hopping Channel Number

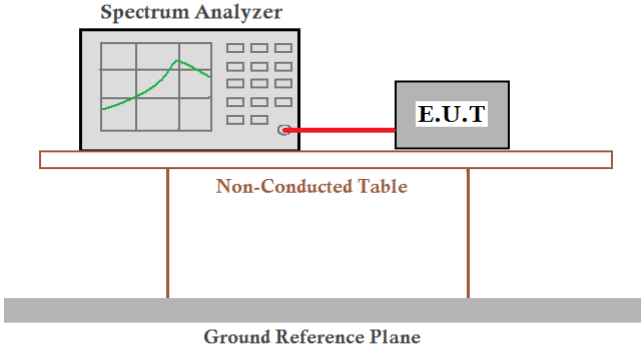
Test Requirement:	FCC Part 15 C Section 15.247 (a)(1)
Test Method:	ANSI C63.10:2013 and DA00-705
Receiver setup:	RBW=100 kHz, VBW=300 kHz, Frequency range=2400MHz-2483.5MHz, Detector=Peak
Limit:	15 channels
Test setup:	 <p>The diagram illustrates the test setup. A Spectrum Analyzer is connected to an E.U.T. (Equipment Under Test) via a red cable. Both are placed on a Non-Conducted Table, which is supported by a Ground Reference Plane.</p>
Test Instruments:	Refer to section 5.8 for details
Test mode:	Hopping mode
Test results:	Please refer to the FCC ID: 2AB6Z-A18RK31

6.7 Dwell Time

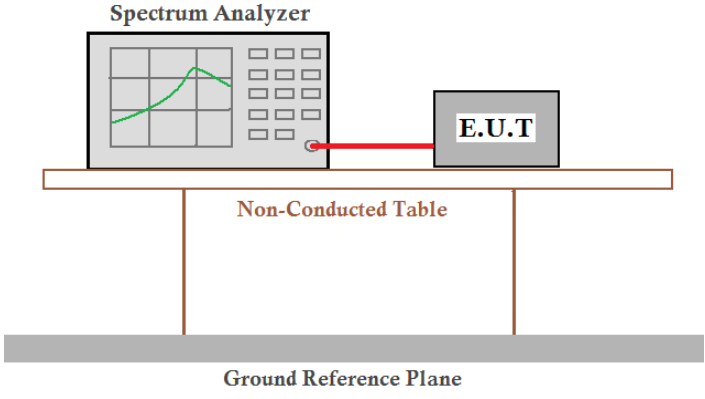
Test Requirement:	FCC Part 15 C Section 15.247 (a)(1)
Test Method:	ANSI C63.10:2013 and KDB DA00-705
Receiver setup:	RBW=1 MHz, VBW=1 MHz, Span=0 Hz, Detector=Peak
Limit:	0.4 Second
Test setup:	 <p>The diagram illustrates the test setup. A Spectrum Analyzer is connected to an E.U.T. (Equipment Under Test) via a red cable. Both are placed on a Non-Conducted Table, which is supported by a Ground Reference Plane.</p>
Test Instruments:	Refer to section 5.8 for details
Test mode:	Hopping mode
Test results:	Please refer to the FCC ID: 2AB6Z-A18RK31

6.8 Pseudorandom Frequency Hopping Sequence

Test Requirement:	FCC Part 15 C Section 15.247 (a)(1) requirement:
<p>Frequency hopping systems shall have hopping channel carrier frequencies separated by a minimum of 25 kHz or the 20 dB bandwidth of the hopping channel, whichever is greater.</p> <p>Alternatively, Frequency hopping systems operating in the 2400-2483.5 MHz band may have hopping channel carrier frequencies that are separated by 25 kHz or two-thirds of the 20 dB bandwidth of the hopping channel, whichever is greater, provided the systems operate with an output power no greater than 125 mW. The system shall hop to channel frequencies that are selected at the system hopping rate from a Pseudorandom ordered list of hopping frequencies. Each frequency must be used equally on the average by each transmitter. The system receivers shall have input bandwidths that match the hopping channel bandwidths of their corresponding transmitters and shall shift frequencies in synchronization with the transmitted signals.</p>	
EUT Pseudorandom Frequency Hopping Sequence	
<p>The pseudorandom sequence may be generated in a nine-stage shift register whose 5th and 9th stage outputs are added in a modulo-two addition stage. And the result is fed back to the input of the first stage. The sequence begins with the first ONE of 9 consecutive ONES; i.e. the shift register is initialized with nine ones.</p> <ul style="list-style-type: none"> • Number of shift register stages: 9 • Length of pseudo-random sequence: $2^9 - 1 = 511$ bits • Longest sequence of zeros: 8 (non-inverted signal) <div data-bbox="256 909 1294 1055" style="text-align: center;"> </div> <p style="text-align: center;"><i>Linear Feedback Shift Register for Generation of the PRBS sequence</i></p> <p>An example of Pseudorandom Frequency Hopping Sequence as follow:</p> <div data-bbox="256 1155 1241 1294" style="text-align: center;"> </div> <p>Each frequency used equally on the average by each transmitter. The system receivers have input bandwidths that match the hopping channel bandwidths of their corresponding transmitters and shift frequencies in synchronization with the transmitted signals.</p>	

6.9 Band Edge

6.9.1 Conducted Emission Method

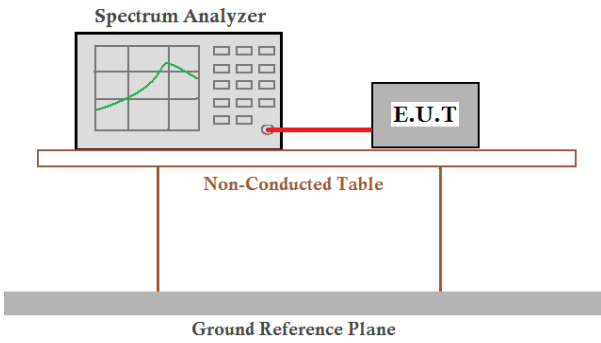
Test Requirement:	FCC Part 15 C Section 15.247 (d)
Test Method:	ANSI C63.10:2013 and DA00-705
Receiver setup:	RBW=100 kHz, VBW=300 kHz, Detector=Peak
Limit:	In any 100 kHz bandwidth outside the frequency band in which the spread spectrum intentional radiator is operating, the radio frequency power that is produced by the intentional radiator shall be at least 20 dB below that in the 100 kHz bandwidth within the band that contains the highest level of the desired power, based on either an RF conducted or a radiated measurement.
Test setup:	 <p>The diagram illustrates the test setup. A Spectrum Analyzer is connected to an E.U.T. (Equipment Under Test) via a red cable. Both are placed on a Non-Conducted Table, which is supported by a Ground Reference Plane.</p>
Test Instruments:	Refer to section 5.8 for details
Test mode:	Non-hopping mode and hopping mode
Test results:	Please refer to the FCC ID: 2AB6Z-A18RK31

6.9.2 Radiated Emission Method

Test Requirement:	FCC Part 15 C Section 15.209 and 15.205				
Test Method:	ANSI C63.10: 2013				
Test Frequency Range:	2.3GHz to 2.5GHz				
Test Distance:	3m				
Receiver setup:	Frequency	Detector	RBW	VBW	Remark
	Above 1GHz	Peak	1MHz	3MHz	Peak Value
		RMS	1MHz	3MHz	Average Value
Limit:	Frequency	Limit (dBuV/m @3m)		Remark	
	Above 1GHz	54.00		Average Value	
		74.00		Peak Value	
Test setup:					
Test Procedure:	<ol style="list-style-type: none"> 1. The EUT was placed on the top of a rotating table 1.5meters above the ground at a 3 meter camber. The table was rotated 360 degrees to determine the position of the highest radiation. 2. The EUT was set 3 meters away from the interference-receiving antenna, which was mounted on the top of a variable-height antenna tower. 3. The antenna height is varied from one meter to four meters above the ground to determine the maximum value of the field strength. Both horizontal and vertical polarizations of the antenna are set to make the measurement. 4. For each suspected emission, the EUT was arranged to its worst case and then the antenna was tuned to heights from 1 meter to 4 meters and the rota table was turned from 0 degrees to 360 degrees to find the maximum reading. 5. The test-receiver system was set to Peak Detect Function and Specified Bandwidth with Maximum Hold Mode. 6. If the emission level of the EUT in peak mode was 10dB lower than the limit specified, then testing could be stopped and the peak values of the EUT would be reported. Otherwise the emissions that did not have 10dB margin would be re-tested one by one using peak, quasi-peak or average method as specified and then reported in a data sheet. 				
Test Instruments:	Refer to section 5.8 for details				
Test mode:	Non-hopping mode				
Test results:	Passed				

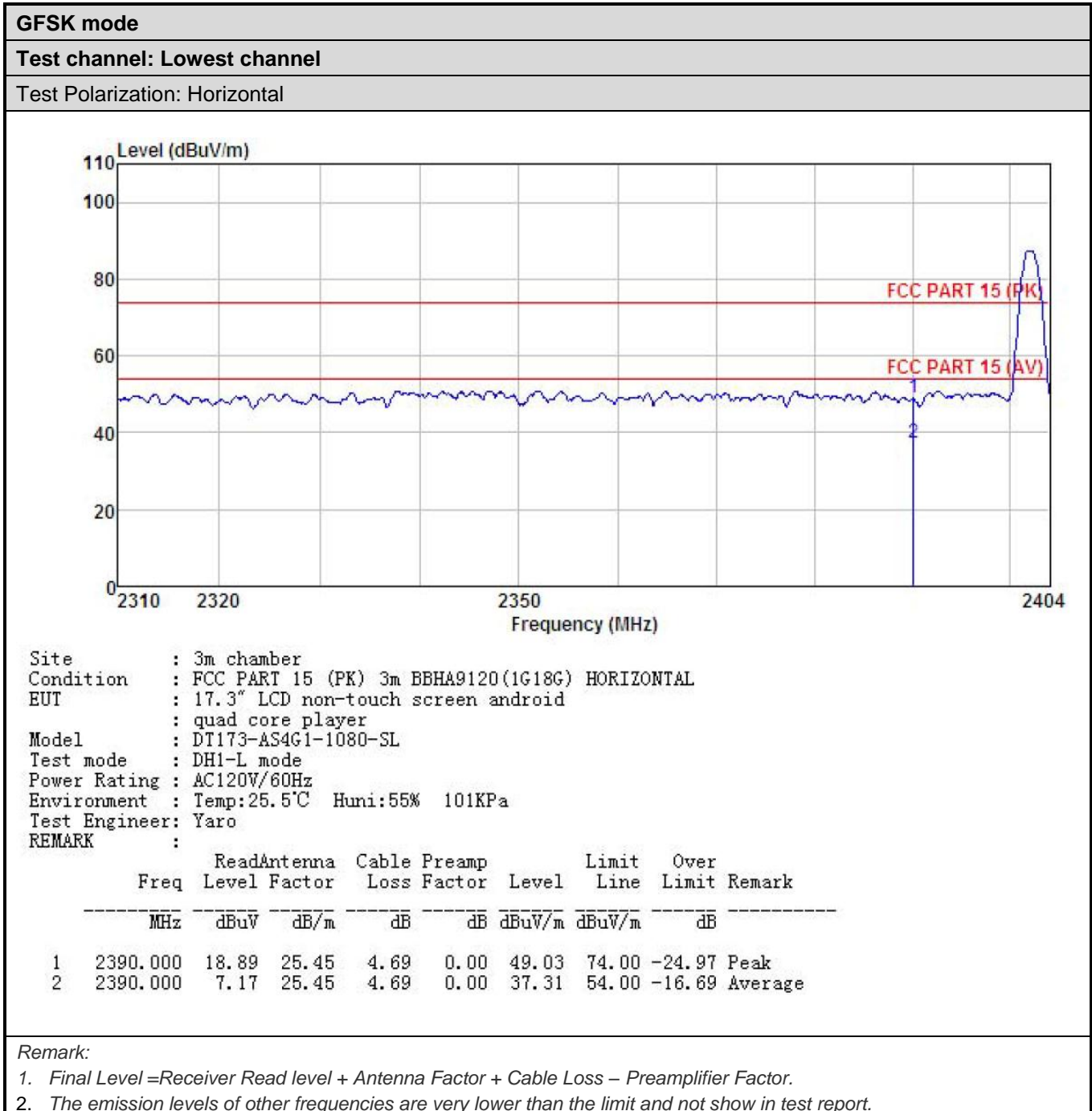

Test Polarization: Vertical

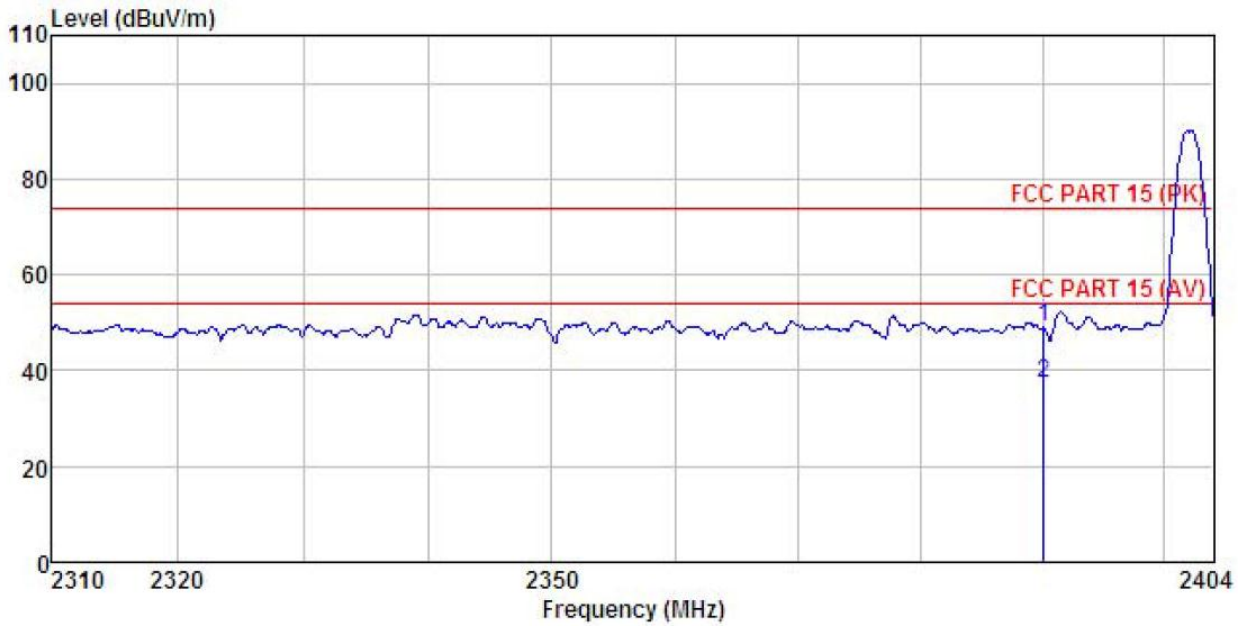

Site : 3m chamber
 Condition : FCC PART 15 (PK) 3m BBHA9120(1G18G) VERTICAL
 EUT : 17.3" LCD non-touch screen android
 : quad core player
 Model : DT173-AS4G1-1080-SL
 Test mode : DH1-L mode
 Power Rating : AC120V/60Hz
 Environment : Temp:25.5°C Humi:55% 101KPa
 Test Engineer: Yaro
 REMARK :

	Read	Antenna	Cable	Preamp	Limit	Over		
Freq	Level	Factor	Loss	Factor	Level	Line	Limit	
-----	-----	-----	-----	-----	-----	-----	-----	
MHz	dBuV	dB/m	dB	dB	dBuV/m	dBuV/m	dB	
1	2390.000	18.86	25.45	4.69	0.00	49.00	74.00	-25.00 Peak
2	2390.000	7.13	25.45	4.69	0.00	37.27	54.00	-16.73 Average

Remark:

1. Final Level = Receiver Read level + Antenna Factor + Cable Loss - Pre-amplifier Factor.
2. The emission levels of other frequencies are very lower than the limit and not show in test report.

Test channel: Highest channel

Test Polarization: Horizontal

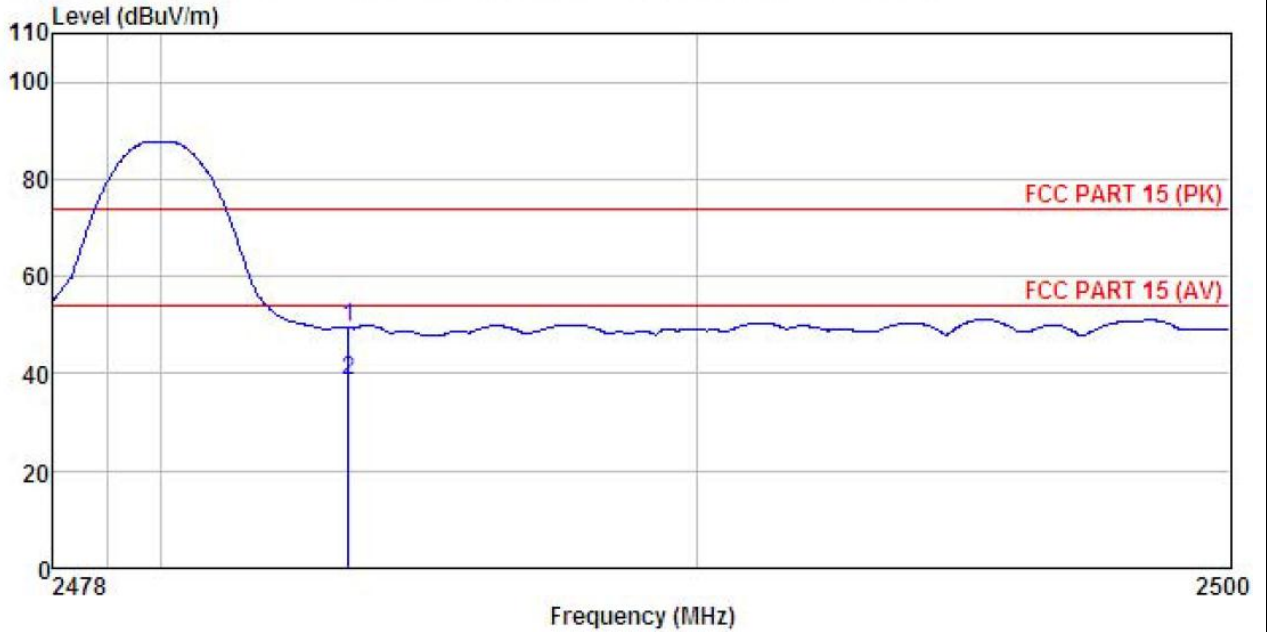

Site : 3m chamber
 Condition : FCC PART 15 (PK) 3m BBHA9120(1G18G) HORIZONTAL
 EUT : 17.3" LCD non-touch screen android
 : quad core player
 Model : DT173-AS4G1-1080-SL
 Test mode : DH1-H mode
 Power Rating : AC120V/60Hz
 Environment : Temp:25.5°C Humi:55% 101KPa
 Test Engineer: Yaro
 REMARK :

	Read	Antenna	Cable	Preamp	Limit	Over	
Freq	Level	Factor	Loss	Factor	Level	Line	Limit Remark
MHz	dBuV	dB/m	dB	dB	dBuV/m	dBuV/m	dB
1	2483.500	19.06	25.66	4.81	0.00	49.53	74.00 -24.47 Peak
2	2483.500	8.15	25.66	4.81	0.00	38.62	54.00 -15.38 Average

Remark:

1. Final Level = Receiver Read level + Antenna Factor + Cable Loss - Pre-amplifier Factor.
2. The emission levels of other frequencies are very lower than the limit and not show in test report.

Test Polarization: Vertical

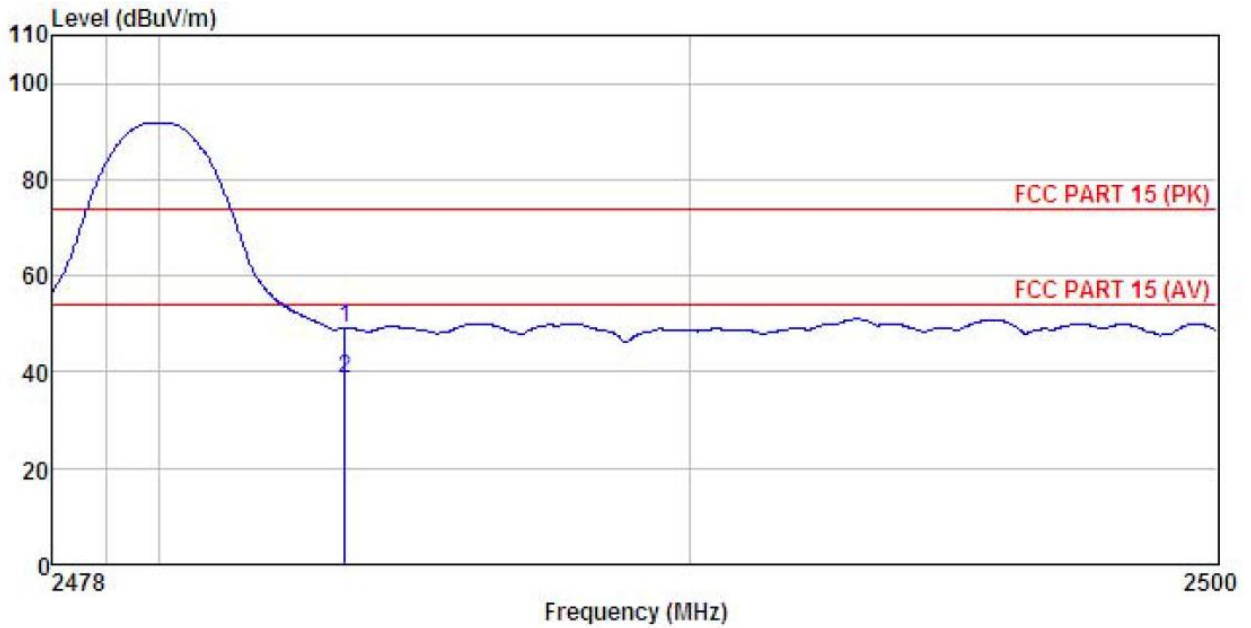

Site : 3m chamber
 Condition : FCC PART 15 (PK) 3m BBHA9120(1G18G) VERTICAL
 EUT : 17.3" LCD non-touch screen android
 : quad core player
 Model : DT173-AS4G1-1080-SL
 Test mode : DH1-H mode
 Power Rating : AC120V/60Hz
 Environment : Temp:25.5°C Humi:55% 101KPa
 Test Engineer: Yaro
 REMARK :

	Read	Antenna	Cable	Preamp	Level	Limit	Over	
Freq	Level	Factor	Loss	Factor	Level	Line	Limit	Remark
MHz	dBuV	dB/m	dB	dB	dBuV/m	dBuV/m	dB	
1	2483.500	18.60	25.66	4.81	0.00	49.07	74.00	-24.93 Peak
2	2483.500	8.19	25.66	4.81	0.00	38.66	54.00	-15.34 Average

Remark:

1. Final Level = Receiver Read level + Antenna Factor + Cable Loss - Pre-amplifier Factor.
2. The emission levels of other frequencies are very lower than the limit and not show in test report.

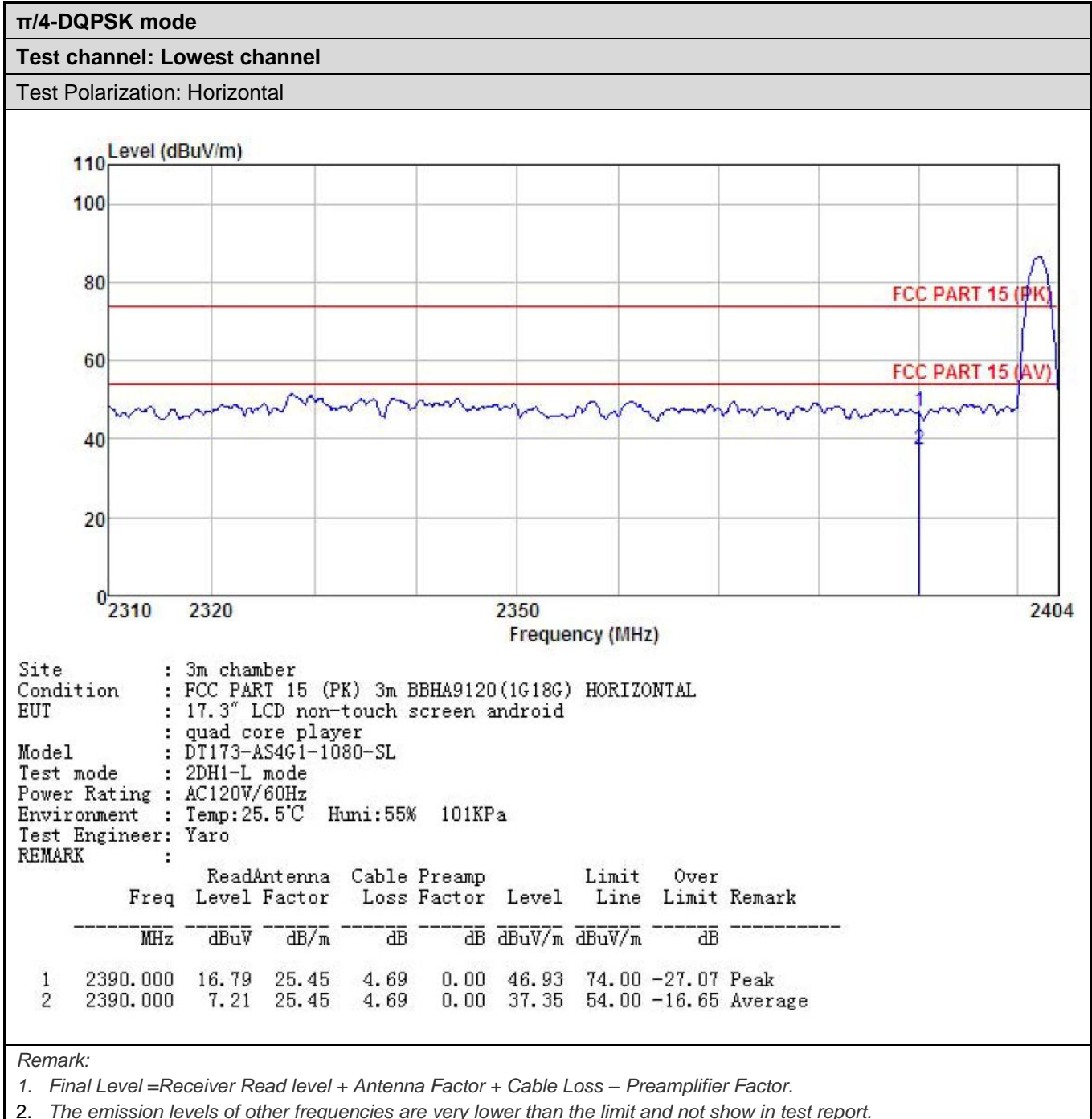

Test Polarization: Vertical

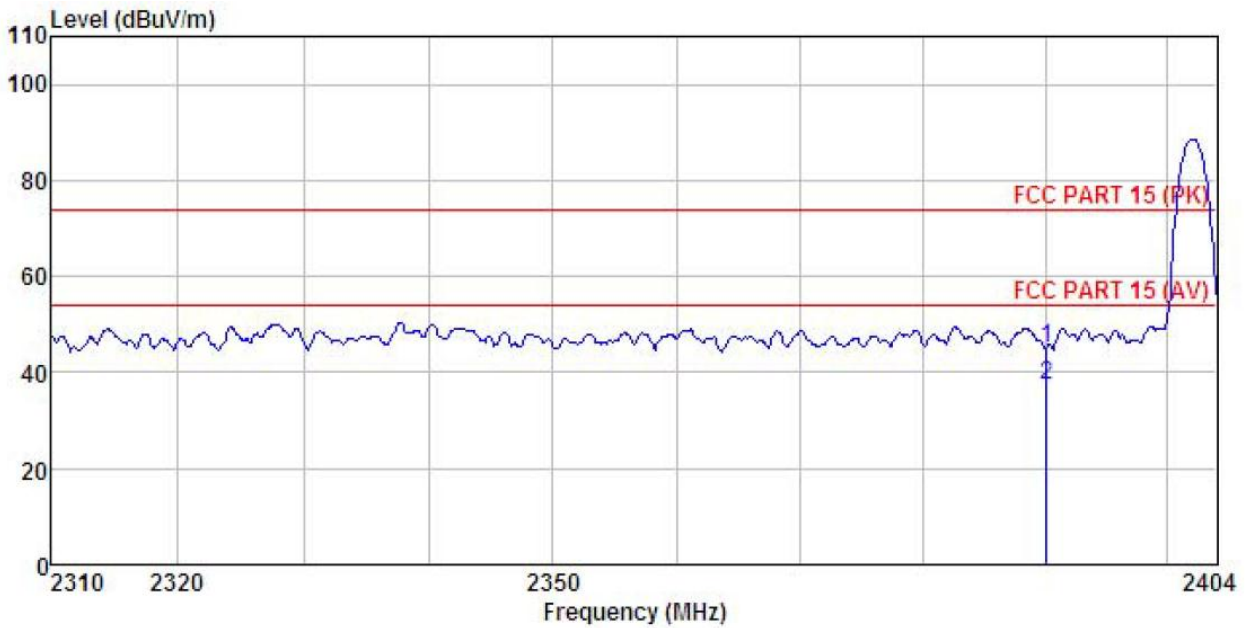

Site : 3m chamber
 Condition : FCC PART 15 (PK) 3m BBHA9120(1G18G) VERTICAL
 EUT : 17.3" LCD non-touch screen android
 : quad core player
 Model : DT173-AS4G1-1080-SL
 Test mode : 2DH1-L mode
 Power Rating : AC120V/60Hz
 Environment : Temp:25.5°C Humi:55% 101KPa
 Test Engineer: Yaro
 REMARK :

	Read	Antenna	Cable	Preamp	Level	Limit	Over	
-----	Level	Factor	Loss	Factor	Line	Limit	Limit	Remark
-----	dBuV	dB/m	dB	dB	dBuV/m	dBuV/m	dB	-----
1	2390.000	14.92	25.45	4.69	0.00	45.06	74.00	-28.94 Peak
2	2390.000	7.18	25.45	4.69	0.00	37.32	54.00	-16.68 Average

Remark:

1. Final Level = Receiver Read level + Antenna Factor + Cable Loss - Pre-amplifier Factor.
2. The emission levels of other frequencies are very lower than the limit and not show in test report.

Test channel: Highest channel

Test Polarization: Horizontal

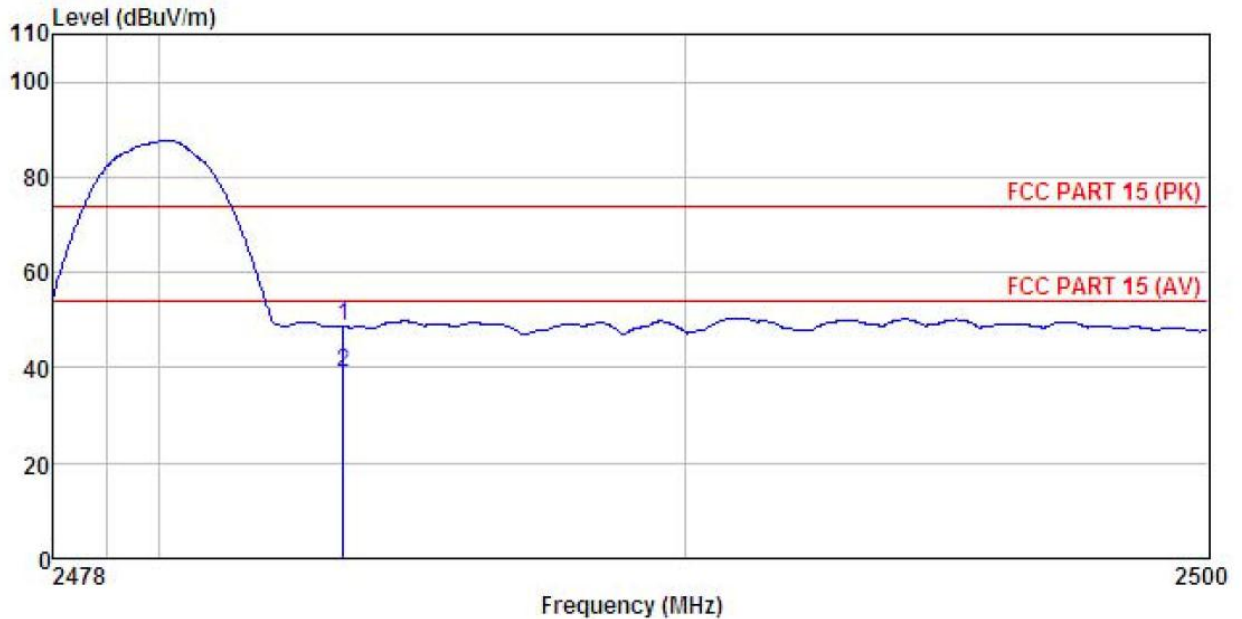

Site : 3m chamber
 Condition : FCC PART 15 (PK) 3m BBHA9120(1G18G) HORIZONTAL
 EUT : 17.3" LCD non-touch screen android
 : quad core player
 Model : DT173-AS4G1-1080-SL
 Test mode : 2DH1-H mode
 Power Rating : AC120V/60Hz
 Environment : Temp:25.5°C Humi:55% 101KPa
 Test Engineer: Yaro
 REMARK :

	Read	Antenna	Cable	Preamp	Limit	Over	
Freq	Level	Factor	Loss	Factor	Level	Line	Limit Remark
MHz	dBuV	dB/m	dB	dB	dBuV/m	dBuV/m	dB
1	2483.500	18.20	25.66	4.81	0.00	48.67	74.00 -25.33 Peak
2	2483.500	8.42	25.66	4.81	0.00	38.89	54.00 -15.11 Average

Remark:

1. Final Level = Receiver Read level + Antenna Factor + Cable Loss - Pre-amplifier Factor.
2. The emission levels of other frequencies are very lower than the limit and not show in test report.

Test Polarization: Vertical

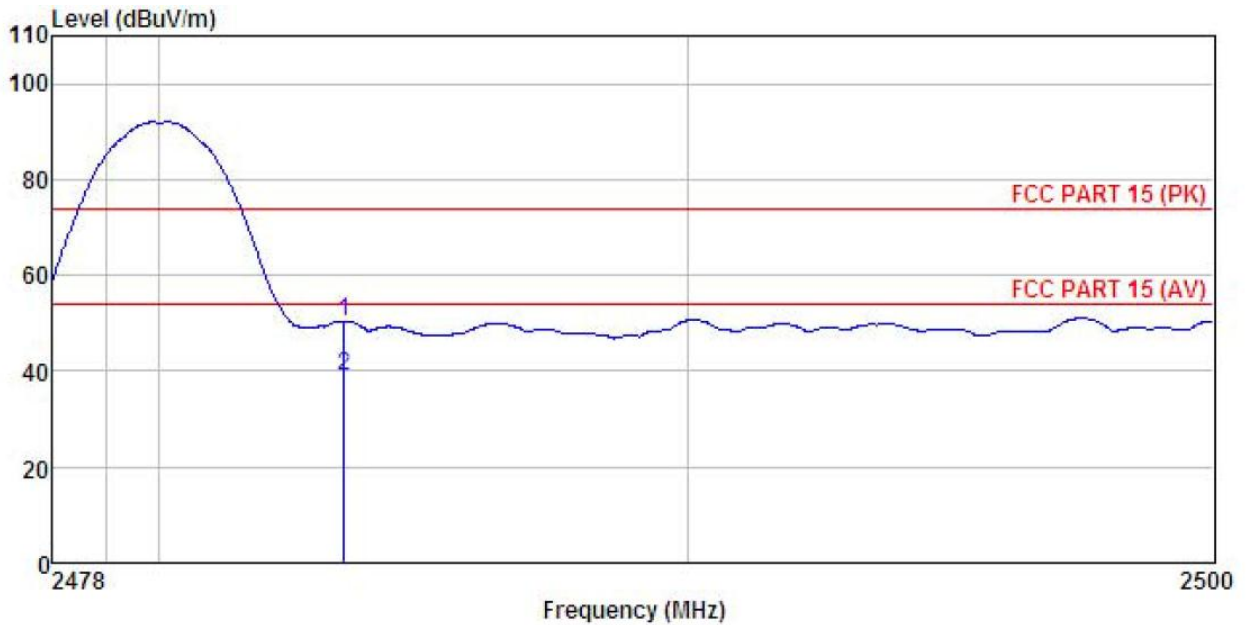

Site : 3m chamber
 Condition : FCC PART 15 (PK) 3m BBHA9120(1G18G) VERTICAL
 EUT : 17.3" LCD non-touch screen android
 : quad core player
 Model : DT173-AS4G1-1080-SL
 Test mode : 2DH1-H mode
 Power Rating : AC120V/60Hz
 Environment : Temp:25.5°C Humi:55% 101KPa
 Test Engineer: Yaro
 REMARK :

	Read	Antenna	Cable	Preamp	Limit	Over	
Freq	Level	Factor	Loss	Factor	Line	Limit	Remark
MHz	dBuV	dB/m	dB	dB	dBuV/m	dBuV/m	dB
1	2483.500	20.04	25.66	4.81	0.00	50.51	74.00 -23.49 Peak
2	2483.500	8.45	25.66	4.81	0.00	38.92	54.00 -15.08 Average

Remark:

1. Final Level = Receiver Read level + Antenna Factor + Cable Loss - Pre-amplifier Factor.
2. The emission levels of other frequencies are very lower than the limit and not show in test report.

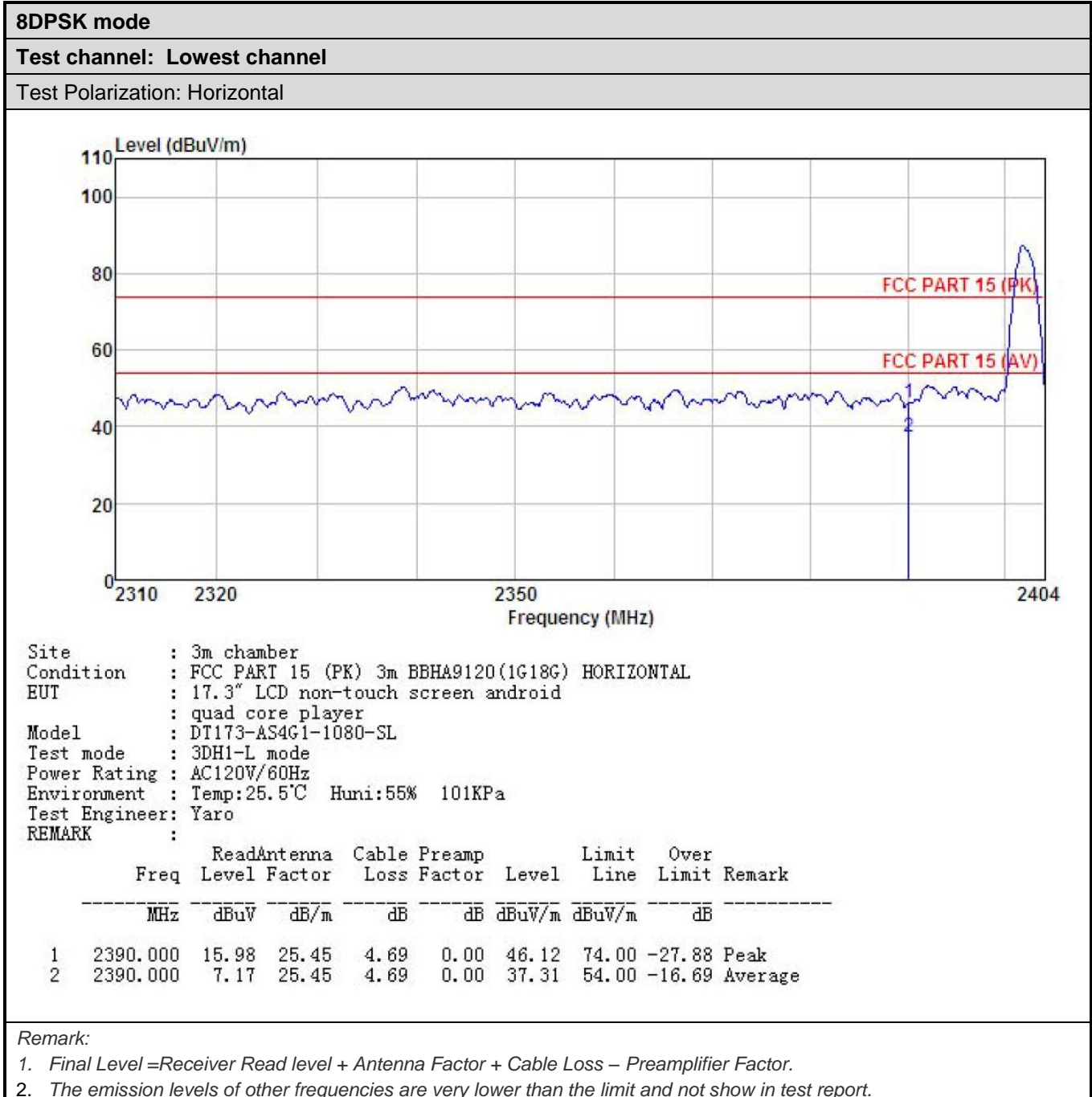

Test Polarization: Vertical

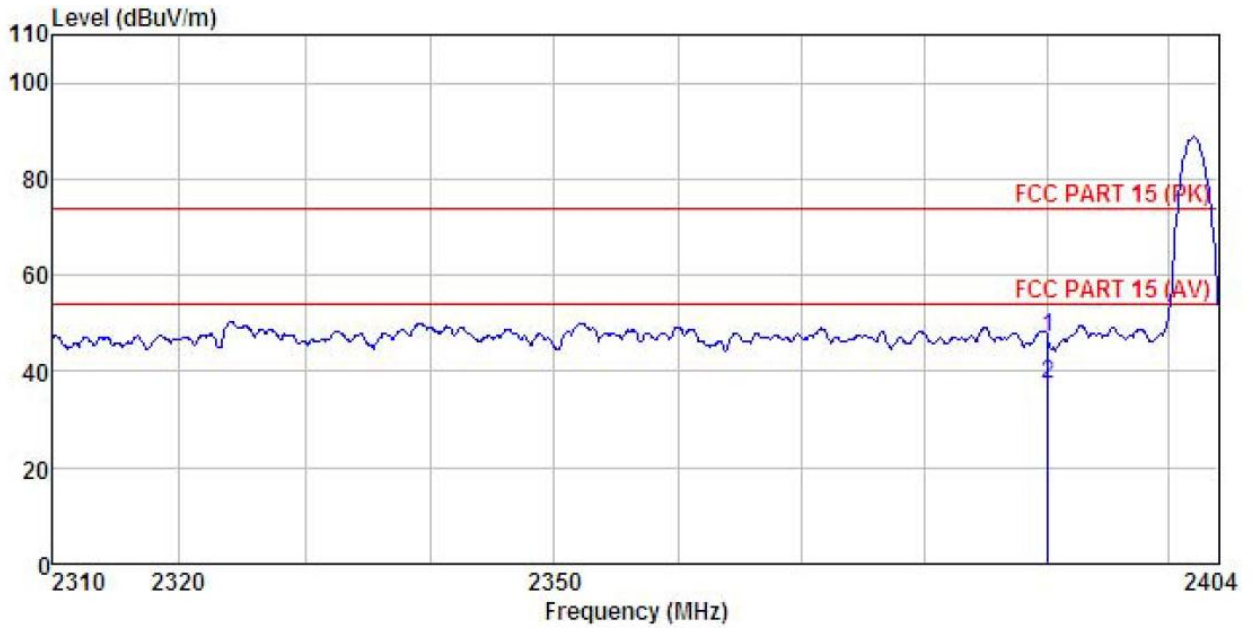

Site : 3m chamber
 Condition : FCC PART 15 (PK) 3m BBHA9120(1G18G) VERTICAL
 EUT : 17.3" LCD non-touch screen android
 : quad core player
 Model : DT173-AS4G1-1080-SL
 Test mode : 3DH1-L mode
 Power Rating : AC120V/60Hz
 Environment : Temp:25.5°C Humi:55% 101KPa
 Test Engineer: Yaro
 REMARK :

	Freq	Read Level	Antenna Factor	Cable Loss	Preamp Factor	Level	Limit Line	Over Limit	Remark
	MHz	dBuV	dB/m	dB	dB	dBuV/m	dBuV/m	dB	
1	2390.000	17.03	25.45	4.69	0.00	47.17	74.00	-26.83	Peak
2	2390.000	7.19	25.45	4.69	0.00	37.33	54.00	-16.67	Average

Remark:

1. Final Level = Receiver Read level + Antenna Factor + Cable Loss – Pre-amplifier Factor.
2. The emission levels of other frequencies are very lower than the limit and not show in test report.

Test channel: Highest channel

Test Polarization: Horizontal

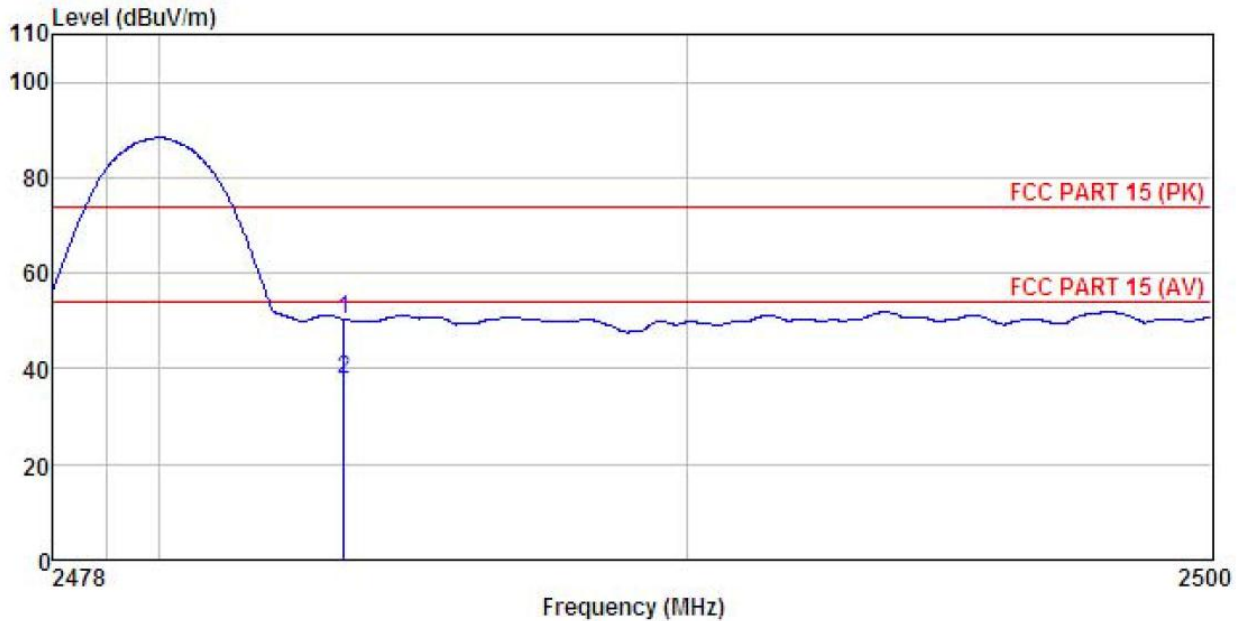

Site : 3m chamber
 Condition : FCC PART 15 (PK) 3m BBHA9120(1G18G) HORIZONTAL
 EUT : 17.3" LCD non-touch screen android
 : quad core player
 Model : DT173-AS4G1-1080-SL
 Test mode : 3DH1-H mode
 Power Rating : AC120V/60Hz
 Environment : Temp:25.5°C Humi:55% 101KPa
 Test Engineer: Yaro
 REMARK :

	Read	Antenna	Cable	Preamp	Limit	Over	
Freq	Level	Factor	Loss	Factor	Level	Line	Limit Remark
MHz	dBuV	dB/m	dB	dB	dBuV/m	dBuV/m	dB
1	2483.500	19.96	25.66	4.81	0.00	50.43	74.00 -23.57 Peak
2	2483.500	7.35	25.66	4.81	0.00	37.82	54.00 -16.18 Average

Remark:

1. Final Level = Receiver Read level + Antenna Factor + Cable Loss - Pre-amplifier Factor.
2. The emission levels of other frequencies are very lower than the limit and not show in test report.

Test Polarization: Vertical

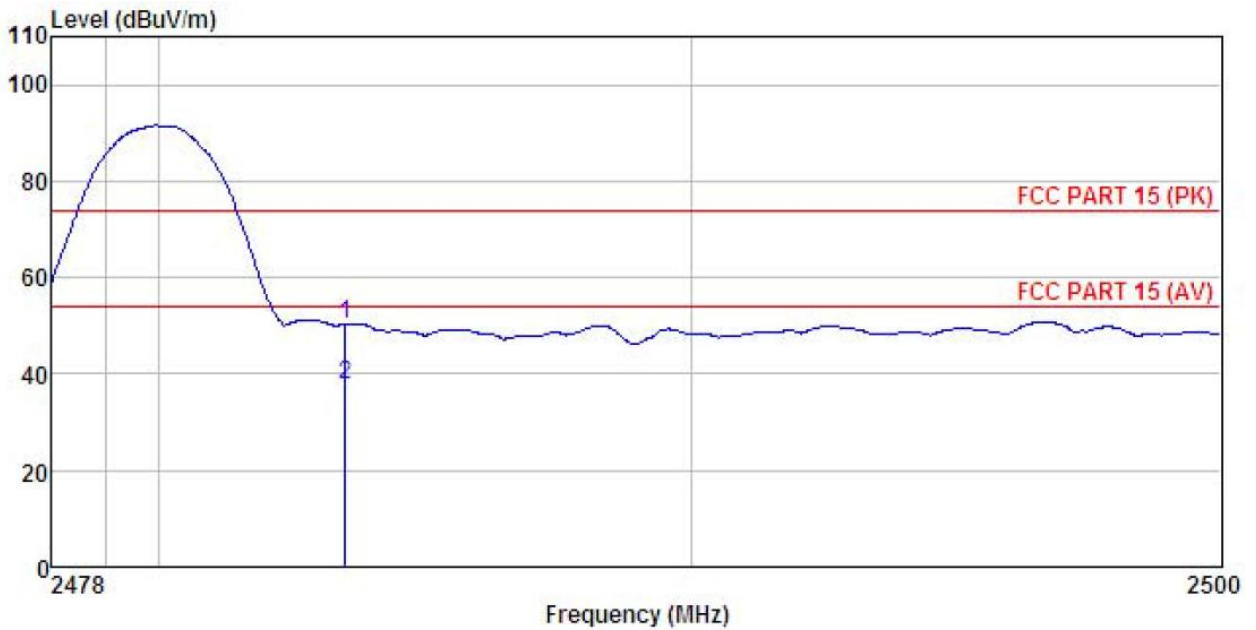

Site : 3m chamber
 Condition : FCC PART 15 (PK) 3m BBHA9120(1G18G) VERTICAL
 EUT : 17.3" LCD non-touch screen android
 : quad core player
 Model : DT173-AS4G1-1080-SL
 Test mode : 3DH1-H mode
 Power Rating : AC120V/60Hz
 Environment : Temp:25.5°C Humi:55% 101KPa
 Test Engineer: Yaro
 REMARK :

	Read	Antenna	Cable	Preamp	Limit	Over	
Freq	Level	Factor	Loss	Factor	Level	Line	Limit Remark
MHz	dBuV	dB/m	dB	dB	dBuV/m	dBuV/m	dB
1	2483.500	19.74	25.66	4.81	0.00	50.21	74.00 -23.79 Peak
2	2483.500	7.38	25.66	4.81	0.00	37.85	54.00 -16.15 Average

Remark:

1. Final Level = Receiver Read level + Antenna Factor + Cable Loss - Pre-amplifier Factor.
2. The emission levels of other frequencies are very lower than the limit and not show in test report.

6.10 Spurious Emission

6.10.1 Conducted Emission Method

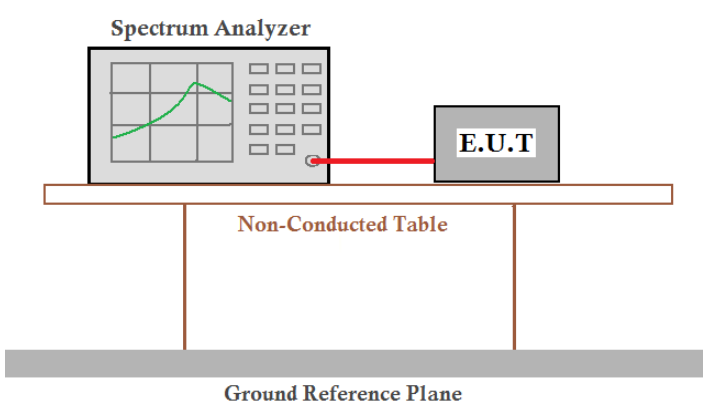
Test Requirement:	FCC Part 15 C Section 15.247 (d)
Test Method:	ANSI C63.10:2013 and DA00-705
Limit:	In any 100 kHz bandwidth outside the frequency band in which the spread spectrum intentional radiator is operating, the radio frequency power that is produced by the intentional radiator shall be at least 20 dB below that in the 100 kHz bandwidth within the band that contains the highest level of the desired power, based on either an RF conducted or a radiated measurement.
Test setup:	 <p>The diagram illustrates the test setup. A Spectrum Analyzer is connected to an E.U.T. (Equipment Under Test) via a red cable. Both the Spectrum Analyzer and the E.U.T. are placed on a Non-Conducted Table. The table is supported by a Ground Reference Plane.</p>
Test Instruments:	Refer to section 5.8 for details
Test mode:	Non-hopping mode
Test results:	Please refer to the FCC ID: 2AB6Z-A18RK31

6.10.2 Radiated Emission Method

Test Requirement:	FCC Part 15 C Section 15.209				
Test Method:	ANSI C63.10: 2013				
Test Frequency Range:	9 kHz to 25 GHz				
Test Distance:	3m				
Receiver setup:	Frequency	Detector	RBW	VBW	Remark
	30MHz-1GHz	Quasi-peak	120kHz	300kHz	Quasi-peak Value
	Above 1GHz	Peak	1MHz	3MHz	Peak Value
		RMS	1MHz	3MHz	Average Value
Limit:	Frequency	Limit (dBuV/m @3m)		Remark	
	30MHz-88MHz	40.0		Quasi-peak Value	
	88MHz-216MHz	43.5		Quasi-peak Value	
	216MHz-960MHz	46.0		Quasi-peak Value	
	960MHz-1GHz	54.0		Quasi-peak Value	
	Above 1GHz	54.0		Average Value	
		74.0		Peak Value	
Test setup:	Below 1GHz				
	Above 1GHz				
Test Procedure:	1. The EUT was placed on the top of a rotating table 0.8m(below 1GHz) /1.5m(above 1GHz) above the ground at a 3 meter chamber. The table				

	<p>was rotated 360 degrees to determine the position of the highest radiation.</p> <ol style="list-style-type: none"> 2. The EUT was set 3 meters away from the interference-receiving antenna, which was mounted on the top of a variable-height antenna tower. 3. The antenna height is varied from one meter to four meters above the ground to determine the maximum value of the field strength. Both horizontal and vertical polarizations of the antenna are set to make the measurement. 4. For each suspected emission, the EUT was arranged to its worst case and then the antenna was tuned to heights from 1 meter to 4 meters and the rota table was turned from 0 degrees to 360 degrees to find the maximum reading. 5. The test-receiver system was set to Peak Detect Function and Specified Bandwidth with Maximum Hold Mode. 6. If the emission level of the EUT in peak mode was 10dB lower than the limit specified, then testing could be stopped and the peak values of the EUT would be reported. Otherwise the emissions that did not have 10dB margin would be re-tested one by one using peak, quasi-peak or average method as specified and then reported in a data sheet.
Test Instruments:	Refer to section 5.8 for details
Test mode:	Non-hopping mode
Test results:	Pass
Remark:	<ol style="list-style-type: none"> 1. Pre-scan all kind of the place mode (X-axis, Y-axis, Z-axis), and found the Y-axis is the worst case. 2. 9 kHz to 30 MHz is noise floor, so only shows the data of above 30MHz in this report.

Measurement Data (worst case):
Below 1GHz:

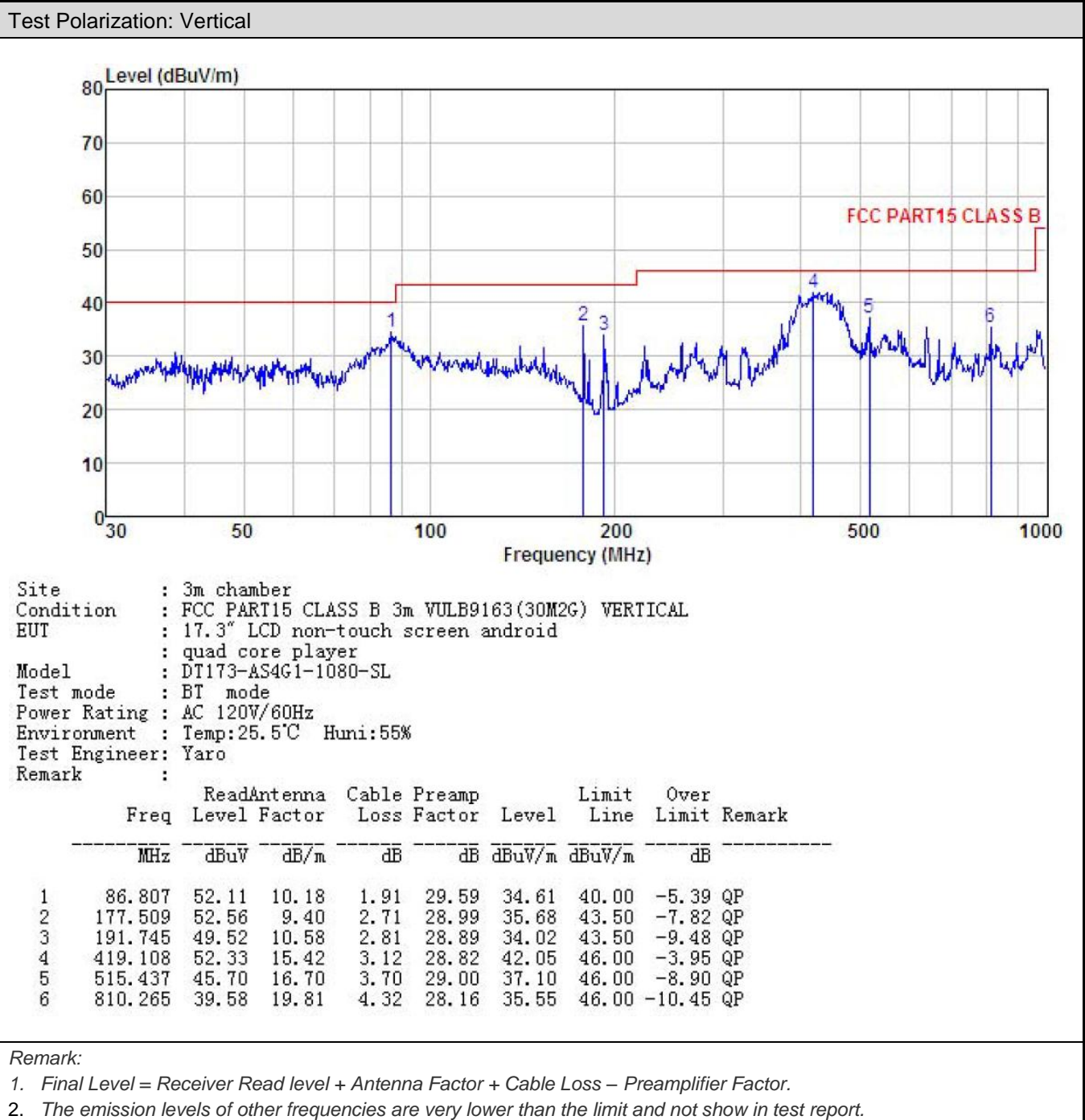

Test Polarization: Horizontal

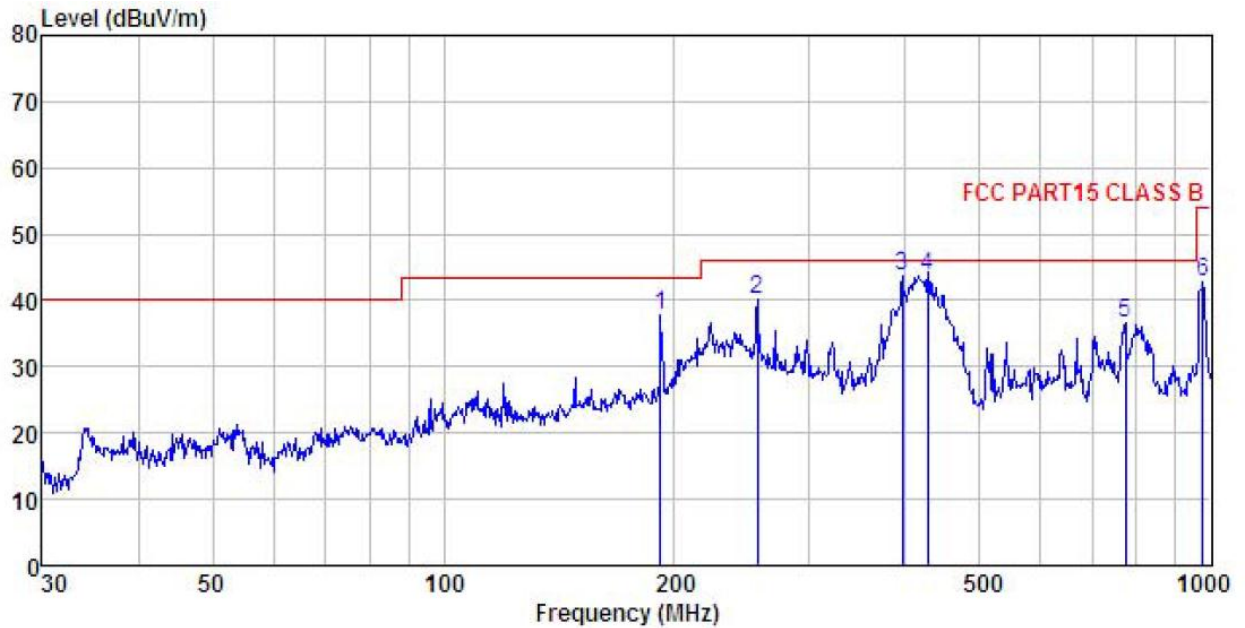

Site : 3m chamber
 Condition : FCC PART15 CLASS B 3m VULB9163(30M2G) HORIZONTAL
 EUT : 17.3" LCD non-touch screen android
 : quad core player
 Model : DT173-AS4G1-1080-SL
 Test mode : BT mode
 Power Rating : AC 120V/60Hz
 Environment : Temp:25.5°C Humi:55%
 Test Engineer: Yaro
 Remark :

	Freq	ReadAntenna	Cable	Preamp	Level	Limit	Over	
	MHz	Level	Loss	Factor	dBuV/m	Line	Limit	Remark
		dBuV	Factor			dBuV/m	dBuV/m	
			dB/m	dB				
				dB				
1	191.745	53.43	10.58	2.81	28.89	37.93	43.50	-5.57 QP
2	256.521	53.68	12.30	2.83	28.53	40.28	46.00	-5.72 QP
3	396.242	54.62	14.76	3.08	28.76	43.70	46.00	-2.30 QP
4	428.019	53.88	15.60	3.15	28.83	43.80	46.00	-2.20 QP
5	774.158	40.99	19.60	4.36	28.34	36.61	46.00	-9.39 QP
6	975.753	44.51	21.50	4.34	27.57	42.78	54.00	-11.22 QP

Remark:

1. Final Level = Receiver Read level + Antenna Factor + Cable Loss - Preamplifier Factor.
2. The emission levels of other frequencies are very lower than the limit and not show in test report.

Above 1GHz:

Test channel: Lowest channel								
Detector: Peak Value								
Frequency (MHz)	Read Level (dBuV)	Antenna Factor (dB/m)	Cable Loss (dB)	Preamp Factor (dB)	Level (dBuV/m)	Limit Line (dBuV/m)	Over Limit (dB)	Polarization
4804.00	47.24	30.85	6.80	41.81	43.08	74.00	-30.92	Vertical
4804.00	46.30	30.85	6.80	41.81	42.14	74.00	-31.86	Horizontal
Detector: Average Value								
Frequency (MHz)	Read Level (dBuV)	Antenna Factor (dB/m)	Cable Loss (dB)	Preamp Factor (dB)	Level (dBuV/m)	Limit Line (dBuV/m)	Over Limit (dB)	Polarization
4804.00	37.99	30.85	6.80	41.81	33.83	54.00	-20.17	Vertical
4804.00	36.30	30.85	6.80	41.81	32.14	54.00	-21.86	Horizontal
Test channel: Middle channel								
Detector: Peak Value								
Frequency (MHz)	Read Level (dBuV)	Antenna Factor (dB/m)	Cable Loss (dB)	Preamp Factor (dB)	Level (dBuV/m)	Limit Line (dBuV/m)	Over Limit (dB)	Polarization
4882.00	47.08	31.20	6.86	41.84	43.30	74.00	-30.70	Vertical
4882.00	46.47	31.20	6.86	41.84	42.69	74.00	-31.31	Horizontal
Detector: Average Value								
Frequency (MHz)	Read Level (dBuV)	Antenna Factor (dB/m)	Cable Loss (dB)	Preamp Factor (dB)	Level (dBuV/m)	Limit Line (dBuV/m)	Over Limit (dB)	Polarization
4882.00	38.53	31.20	6.86	41.84	34.75	54.00	-19.25	Vertical
4882.00	37.54	31.20	6.86	41.84	33.76	54.00	-20.24	Horizontal
Test channel: Highest channel								
Detector: Peak Value								
Frequency (MHz)	Read Level (dBuV)	Antenna Factor (dB/m)	Cable Loss (dB)	Preamp Factor (dB)	Level (dBuV/m)	Limit Line (dBuV/m)	Over Limit (dB)	Polarization
4960.00	46.99	31.63	6.91	41.87	43.66	74.00	-30.34	Vertical
4960.00	47.30	31.63	6.91	41.87	43.97	74.00	-30.03	Horizontal
Detector: Average Value								
Frequency (MHz)	Read Level (dBuV)	Antenna Factor (dB/m)	Cable Loss (dB)	Preamp Factor (dB)	Level (dBuV/m)	Limit Line (dBuV/m)	Over Limit (dB)	Polarization
4960.00	37.10	31.63	6.91	41.87	33.77	54.00	-20.23	Vertical
4960.00	37.69	31.63	6.91	41.87	34.36	54.00	-19.64	Horizontal
<i>Remark:</i>								
1. Final Level = Receiver Read level + Antenna Factor + Cable Loss – Preamplifier Factor.								
2. The emission levels of other frequencies are very lower than the limit and not show in test report.								