

Dynamic Frequency Selection (DFS) Test Report

FCC Part15 Subpart E

Product Name : AB-R1
Model No. : AB-R1
FCC ID : 2AB6UABR1
IC ID : 12163A-ABR1

Applicant : August Home, INC.

Address : 657 Bryant Street San Francisco, CA 94107 USA

Date of Receipt : Jul. 17, 2015
Test Date : Jul. 17, 2015~ Jul. 31, 2015
Issued Date : Aug. 13, 2015
Report No. : 1570462R-RF-FCC-DFS
Report Version : V1.1

The test results relate only to the samples tested.

The test report shall not be reproduced except in full without the written approval of QuieTek Corporation.

DFS Test Report

Issued Date: Aug. 13, 2015

Report No. : 1570462R-RF-FCC-DFS



Product Name : AB-R1
Applicant : August Home, INC.
Address : 657 Bryant Street San Francisco, CA 94107 USA
Manufacturer : August Home, INC.
Address : 657 Bryant Street San Francisco, CA 94107 USA
Model No. : AB-R1
EUT Voltage : AC 16V
FCC ID : 2AB6UABR1
IC ID : 12163A-ABR1
Applicable Standard : FCC CFR Title 47 Part 15 Subpart E: 2014
FCC OET Order 14-30A1 (2014)
KDB 905462 D02 v01r01
KDB 905462 D03 v01r01
RSS-247 Issue 1
Test Result : Pass
Performed Location : Suzhou EMC laboratory
No.99 Hongye Rd., Suzhou Industrial Park Loufeng Hi-Tech
Development Zone., SuZhou, China
TEL: +86-512-6251-5088 / FAX: +86-512-6251-5098
FCC Registration Number: 800392, IC Lab Code: 4075B
Operation Mode : Master device
(5470~5725MHz) Slaver device with radar detection function
 Slaver device without radar detection function

Documented By : Elaine Wang
Elaine Wang Senior Engineer
Reviewed By : Harry Zhao
Harry Zhao RF/Engineering Manager
Approved By : Dream Cao
Dream Cao Director

TABLE OF CONTENTS

Description	Page
1. GENERAL INFORMATION	4
1.1. EUT Description	4
1.2. Standard Requirement	6
1.3. UNII Device Description	6
1.4. Test Equipment	7
1.5. Test Setup	7
1.6. Limits	8
1.7. Client Device requirement	15
1.8. Radar Waveform Calibration	16
1.9. Radar Waveform Calibration Result	17
2. Channel Move Time and Channel Closing Transmission Time	19
2.1. Test Procedure	19
2.2. Test Requirement	19
2.3. Uncertainty	19
2.4. Test Result of Channel Move Time and Channel Closing Transmission Time	20

1. GENERAL INFORMATION

1.1. EUT Description

Product Name	AB-R1
Applicant	August Home, INC.
Address	657 Bryant Street San Francisco, CA 94107 USA
FCC ID.	2AB6UABR1
IC	12163A-ABR1
Model No.	AB-R1
DFS Frequency Range	5250-5350 MHz; 5470-5725MHz
Number of Channels	For 5250-5350 MHz 802.11a/n-20 MHz: 4 802.11n-40 MHz: 2 For 5470-5725MHz 802.11a/n-20 MHz: 11 802.11n-40 MHz: 5
Data Rate	802.11a/n-20MHz: 6 - 135Mbps ; 802.11n-40MHz: up 270Mbps
Channel Control	Auto
Type of Modulation	802.11a/n: OFDM
Antenna type	Dipole Antenna
Peak Antenna Gain	3.7dBi @ 5GHz
Master	
Product Name	Cisco Aironet IOS Access Point
Model No.	AIR-AP1252AG-A-K9

802.11a/n-20MHz Center Working Frequency of Each Channel:

Channel	Frequency	Channel	Frequency	Channel	Frequency	Channel	Frequency
Channel 52:	5260 MHz	Channel 56:	5280 MHz	Channel 60:	5300 MHz	Channel 64	5320 MHz

Channel	Frequency	Channel	Frequency	Channel	Frequency	Channel	Frequency
Channel 100:	5500 MHz	Channel 104:	5520 MHz	Channel 108:	5540 MHz	Channel 112:	5560 MHz
Channel 116:	5580 MHz	Channel 120:	5600 MHz	Channel 124:	5620 MHz	Channel 128:	5640 MHz
Channel 132:	5660 MHz	Channel 136:	5680 MHz	Channel 140:	5700 MHz	N/A	N/A

802.11n-40MHz Center Working Frequency of Each Channel:

Channel	Frequency	Channel	Frequency	Channel	Frequency	Channel	Frequency
Channel 54:	5270 MHz	Channel 62:	5310 MHz	N/A	N/A	N/A	N/A

Channel	Frequency	Channel	Frequency	Channel	Frequency	Channel	Frequency
---------	-----------	---------	-----------	---------	-----------	---------	-----------

Channel 102: 5510 MHz Channel 110: 5550 MHz Channel 118: 5590 MHz Channel 126: 5630 MHz
Channel 134: 5670 MHz

1.2. Standard Requirement

FCC Part 15.407:

U-NII devices operating in the 5.25-5.35 GHz band and the 5.47-5.725 GHz band shall employ a TPC mechanism. The U-NII device is required to have the capability to operate at least 6 dB below the mean EIRP value of 30dBm. A TPC mechanism is not required for systems with an E.I.R.P. of less than 500mW.

1.3. UNII Device Description

The UUT operates in the following band: 5250-5350MHz and 5470-5725 MHz

The UUT is a Client Device that does not have radar detection capability and ad-hoc function. The highest gain antenna assembly utilized with the EUT has a maximum gain of 2.65dBi in 5GHz frequency band. The 50-ohm Tx/Rx antenna port is connected to the test system to perform conducted tests. TPC is not required since the maximum EIRP is less than 500mW (27dBm).

The UUT utilizes 802.11a/n IP based architecture. Two nominal channel bandwidths, 20 MHz and 40MHz are implemented.

WLAN traffic is generated by streaming the video file "TestFile.mp2" from the Master device to the Slave device in full motion video mode using the "Nero Show Time 3" with the V3.0.1.3 Codec package.

The master device is a Cisco 802.11a/b/g/n Access Point. The Cisco Access Point FCC ID: LDK102061.

The UUT is a client device without radar detection therefore the interference threshold level is not required.

Statement: Information regarding the parameters of the detected Radar Waveforms is not available to the end user.

1.4. Test Equipment

Dynamic Frequency Selection (DFS) / TR-8

Instrument	Manufacturer	Type No.	Serial No	Cal. Due Date
Spectrum Analyzer	Agilent	N9010A	MY48030494	2016.05.12
Vector Signal Generator	Agilent	E4438C	MY49070163	2016.03.28

Instrument	Manufacturer	Type No.	Serial No
Splitter/Combiner (Qty: 2)	Mini-Circuits	ZAPD-50W 4.2-6.0 GHz	NN256400424
Splitter/Combiner (Qty: 2)	MCLI	PS3-7	4463/4464
ATT (Qty: 1)	Mini-Circuits	VAT-30+	30912
Laptop PC	Asus	N80V	8BN0AS226971468
RF Cable (Qty: 6)	Mini-Circuits	N/A	DFS-1~6

Software	Manufacturer	Function
Pulse Building	Agilent	Radar Signal Generation Software
DFS Tool	Agilent	DFS Test Software

1.5. Test Setup

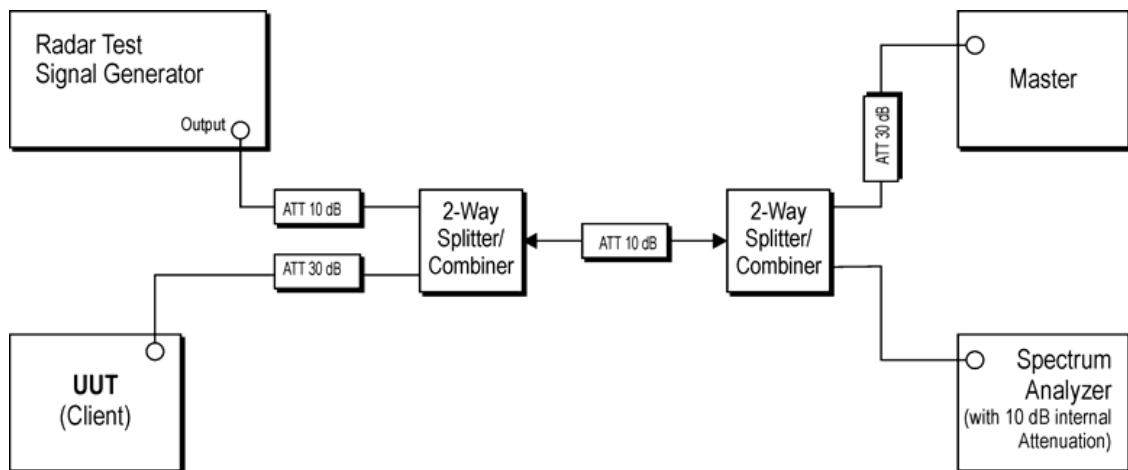

DFS Set-up Photo: Slave and Spectrum Analyzer



1.6. Limits

According to §15.407(h), 905462 D02 UNII DFS Compliance Procedures New Rules v01 and FCC 14-30 APPENDIX “COMPLIANCE MEASUREMENT PROCEDURES FOR UNLICENSED NATIONAL INFORMATION INFRASTRUCTURE DEVICES OPERATING IN THE 5250-5350 MHz AND 5470-5725MHz BANDS INCORPORATING DYNAMIC FREQUENCY SELECTION”.

Applicability of DFS requirements prior to use of a channel

Requirement	Operational Mode		
	Master	Client (without radar detection)	Client (with radar detection)
Non-Occupancy Period	Yes	Not Required	Yes
DFS Detection Threshold	Yes	Not Required	Yes
Channel Availability Check Time	Yes	Not Required	Not Required

U-NII Detection Bandwidth	Yes	Not Required	Yes
---------------------------	-----	---------------------	-----

Applicability of DFS requirements during normal operation

Requirement	Operational Mode	
	Master or Client (with radar detection)	Client (without radar detection)
DFS Detection Threshold	Yes	Not Required
Channel Closing Transmission Time	Yes	Yes
Channel Move Time	Yes	Yes
U-NII Detection Bandwidth	Yes	Not required

Additional requirements for devices with multiple bandwidth modes	Master Device or Client with Radar Detection	Client (without radar detection)
U-NII Detection Bandwidth and Statistical Performance Check	All BW modes must be tested	Not required
Channel Move Time and Channel Closing Transmission Time	Test using widest BW mode available	Test using the widest BW mode available for the link
All other tests	Any single BW mode	Not required
<p>Note: Frequencies selected for statistical performance check (Section 7.8.4) should include several frequencies within the radar detection bandwidth and frequencies near the edge of the radar detection bandwidth. For 802.11 devices it is suggested to select frequencies in all 20 MHz channel blocks and a null frequencies between the bonded 20 MHz channel blocks.</p>		

DFS Detection Thresholds for Master Devices and Client Devices With Radar Detection

Maximum Transmit Power	Value (see note)
EIRP ≥ 200 milliwatt	-64 dBm
EIRP < 200 milliwatt and power spectral density < 10 dBm/MHz	-62 dBm
EIRP < 200 milliwatt that do not meet the power spectral density requirement	-62 dBm
<p>Note 1: This is the level at the input of the receiver assuming a 0 dBi receive antenna.</p> <p>Note 2: Throughout these test procedures an additional 1 dB has been added to the amplitude of the test transmission waveforms to account for variations in measurement equipment. This will ensure that the test signal is at or above the detection threshold level to trigger a DFS response.</p> <p>Note3: EIRP is based on the highest antenna gain. For MIMO devices refer to KDB Publication 662911 D01.</p>	

DFS Response requirement values

Parameter	Value
Non-Occupancy Period	Minimum 30 minutes
Channel Availability Check Time	60 Seconds
Channel Move Time	10 Seconds (See Note1)
Channel Closing Transmission Time	200 milliseconds + an aggregate of 60 milliseconds over remaining 10 second period. (See Notes 1 and 2)
U-NII Detection Bandwidth	Minimum 100% of the U-NII 99% transmission power bandwidth. See Note 3.
<p>Note 1: Channel Move Time and the Channel Closing Transmission Time should be performed with Radar Type 0. The measurement timing begins at the end of the Radar Type 0 burst.</p> <p>Note 2: The Channel Closing Transmission Time is comprised of 200 milliseconds starting at the beginning of the Channel Move Time plus any additional intermittent control signals required to facilitate a Channel move (an aggregate of 60 milliseconds) during the remainder of the 10 second period. The aggregate duration of control signals will not count quiet periods in between transmissions.</p> <p>Note 3: During the U-NII Detection Bandwidth detection test, radar type 0 should be used. For each frequency step the minimum percentage of detection is 90 percent. Measurements are performed with no data traffic.</p>	

Short Pulse Radar Test Waveforms

Table 5 – Short Pulse Radar Test Waveforms

Radar Type	Pulse Width (μsec)	PRI (μsec)	Number of Pulses	Minimum Percentage of Successful Detection	Minimum Number of Trials
0	1	1428	18	See Note 1	See Note 1
1	1	Test A: 15 unique PRI values randomly selected from the list of 23 PRI values in Table 5a	Roundup $\left\{ \left(\frac{1}{360} \right) \cdot \left(\frac{19 \cdot 10^6}{PRI_{\mu sec}} \right) \right\}$	60%	30
		Test B: 15 unique PRI values randomly selected within the range of 518-3066 μ sec, with a minimum increment of 1 μ sec, excluding PRI values selected in Test A			
2	1-5	150-230	23-29	60%	30
3	6-10	200-500	16-18	60%	30
4	11-20	200-500	12-16	60%	30
Aggregate (Radar Types 1-4)				80%	120
Note 1: Short Pulse Radar Type 0 should be used for the detection bandwidth test, channel move time, and channel closing time tests.					

A minimum of 30 unique waveforms are required for each of the Short Pulse Radar Types 2 through 4. If more than 30 waveforms are used for Short Pulse Radar Types 2 through 4, then each additional waveform must also be unique and not repeated from the previous waveforms. If more than 30 waveforms are used for Short Pulse Radar Type 1, then each additional waveform is generated with Test B and must also be unique and not repeated from the previous waveforms in Tests A or B.

For example if in Short Pulse Radar Type 1 Test B a PRI of 3066 usec is selected, the number of

pulses would be = Roundup $\left\{ \left(\frac{1}{360} \right) \cdot \left(\frac{19 \cdot 10^6}{3066} \right) \right\} = \text{Roundup}\{17.2\} = 18.$

Table 5a - Pulse Repetition Intervals Values for Test A

Pulse Repetition Frequency Number	Pulse Repetition Frequency (Pulses Per Second)	Pulse Repetition Interval (Microseconds)
1	1930.5	518
2	1858.7	538
3	1792.1	558
4	1730.1	578
5	1672.2	598
6	1618.1	618
7	1567.4	638
8	1519.8	658
9	1474.9	678
10	1432.7	698
11	1392.8	718
12	1355	738
13	1319.3	758
14	1285.3	778
15	1253.1	798
16	1222.5	818
17	1193.3	838
18	1165.6	858
19	1139	878
20	1113.6	898
21	1089.3	918
22	1066.1	938
23	326.2	3066

The aggregate is the average of the percentage of successful detections of Short Pulse Radar Types 1-4.

Long Pulse Radar Test Signal

Radar Waveform	Bursts	Pulses Per Burst	Pulse Width (μ sec)	Chirp Width (MHz)	PRI (μ sec)	Minimum Percentage of Successful Detection	Minimum Trials
5	8-20	1-3	50-100	5-20	1000-2000	80%	30

The parameters for this waveform are randomly chosen. Thirty unique waveforms are required for the long pulse radar test signal. If more than 30 waveforms are used for the long pulse radar test signal, then each additional waveform must also be unique and not repeated from the previous waveforms.

Frequency Hopping Radar Test Signal

Radar Waveform	Pulse Width (μsec)	PRI (μsec)	Hopping Sequence Length (msec)	Pulses Per Hop	Hopping Rate (kHz)	Minimum Percentage of Successful Detection	Minimum Trials
6	1	333	300	9	.333	70%	30

For the Frequency Hopping Radar Type, the same *Burst* parameters are used for each waveform. The hopping sequence is different for each waveform and a 100-length segment is selected from the hopping sequence defined by the following algorithm:

The first frequency in a hopping sequence is selected randomly from the group of 475 integer frequencies from 5250 – 5724 MHz. Next, the frequency that was just chosen is removed from the group and a frequency is randomly selected from the remaining 474 frequencies in the group. This process continues until all 475 frequencies are chosen for the set. For selection of a random frequency, the frequencies remaining within the group are always treated as equally likely.

1.7. Client Device requirement

- a) A Client Device will not transmit before having received appropriate control signals from a Master Device.
- b) A Client Device will stop all its transmissions whenever instructed by a Master Device to which it is associated and will meet the Channel Move Time and Channel Closing Transmission Time requirements. The Client Device will not resume any transmissions until it has again received control signals from a Master Device.
- c) If a Client Device is performing In-Service Monitoring and detects a Radar Waveform above the DFS Detection Threshold, it will inform the Master Device. This is equivalent to the Master Device detecting the Radar Waveform and d) through f) of section 5.1.1 apply.
- d) Irrespective of Client Device or Master Device detection the Channel Move Time and Channel Closing Transmission Time requirements remain the same.
- e) The client test frequency must be monitored to ensure no transmission of any type has occurred for 30 minutes. Note: If the client moves with the master, the device is considered compliant if nothing appears in the client non-occupancy period test. For devices that shut down (rather than moving channels), no beacons should appear.

1.8. Radar Waveform Calibration

The following equipment setup was used to calibrate the conducted radar waveform. A spectrum analyzer was used to establish the test signal level for each radar type. During this process there were replace 50ohm terminal from master and client device and no transmissions by either the master or client device. The spectrum analyzer was switched to the zero span (time domain) at the frequency of the radar waveform generator. Peak detection was utilized. The spectrum analyzer resolution bandwidth (RBW) and video bandwidth (VBW) were set to 3MHz and 3 MHz.

The signal generator amplitude was set so that the power level measured at the spectrum analyzer was -61dBm due to the interference threshold level is not required.

Conducted Calibration Setup

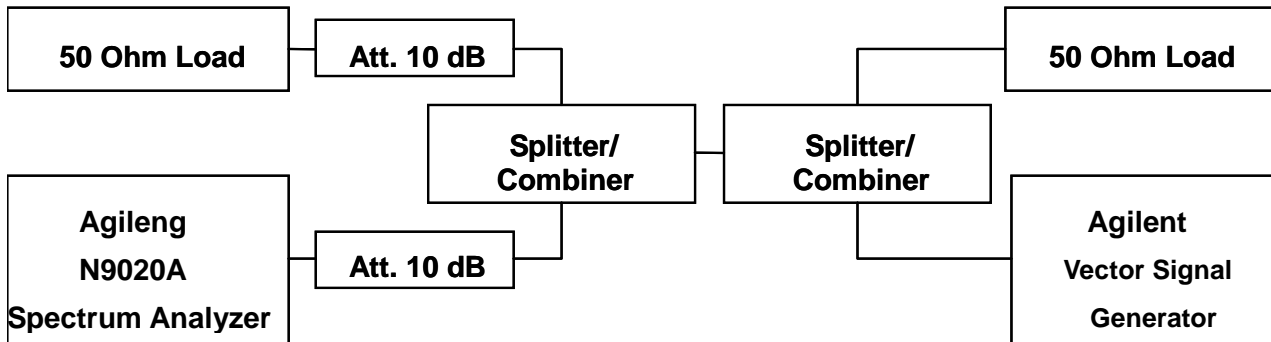

1.9. Radar Waveform Calibration Result

Radar Type 0 Calibration Plot (5300MHz)

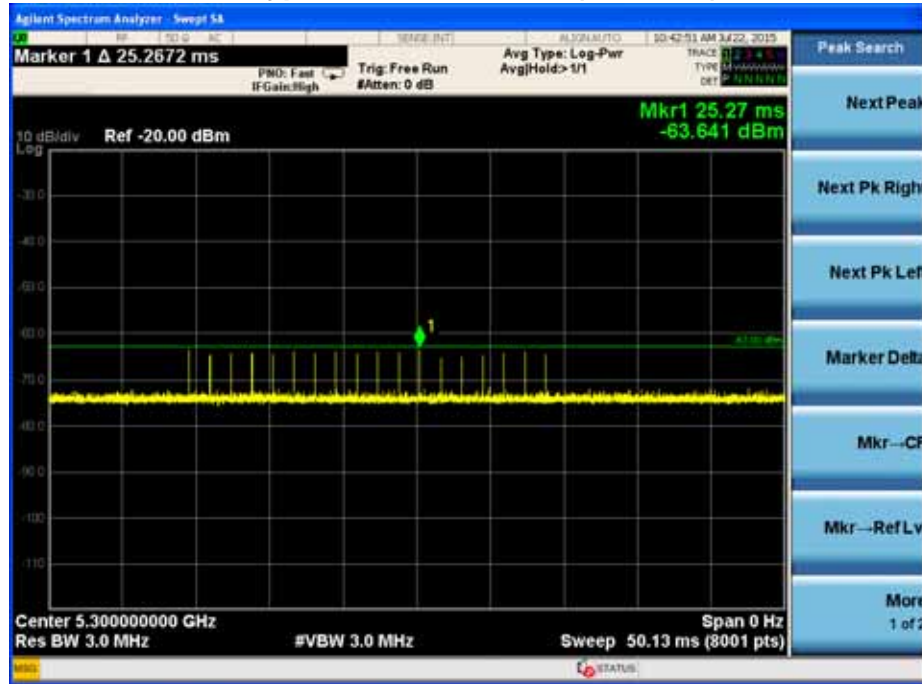

Radar Type 0 Calibration Plot (5310MHz)

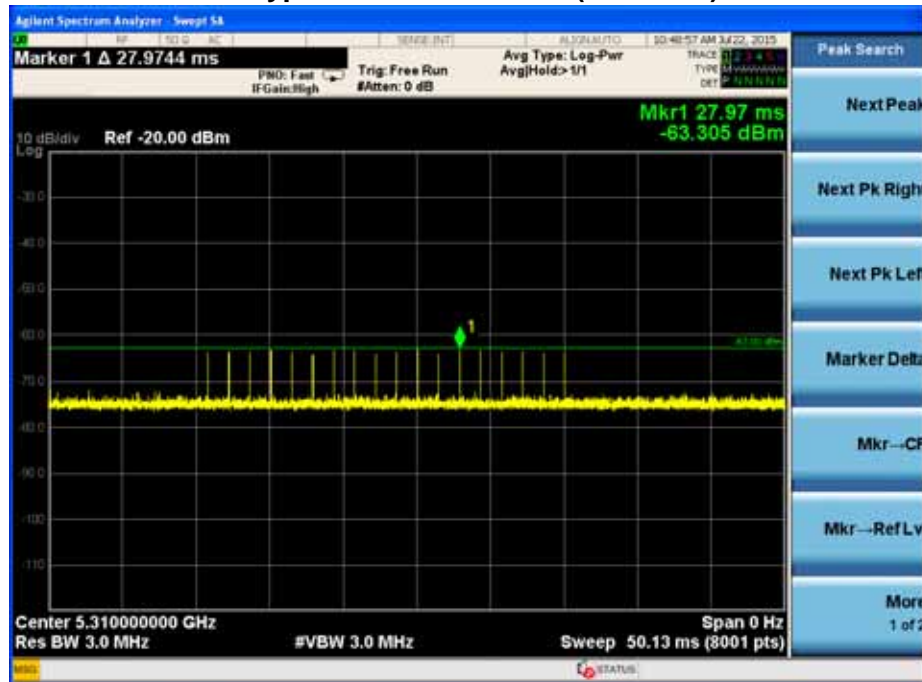

Radar Type 0 Calibration Plot (5500MHz)

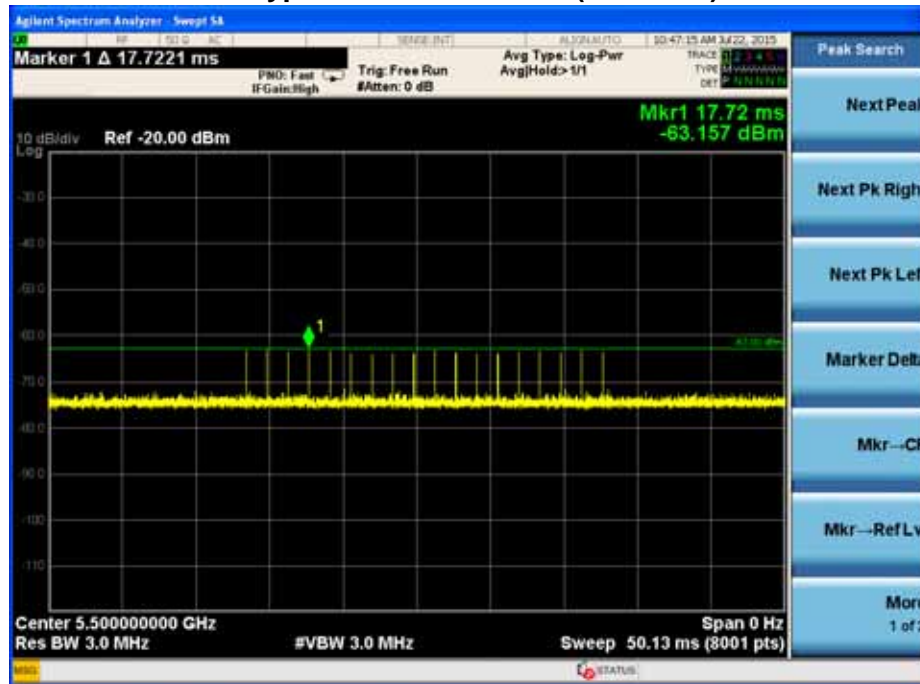

Radar Type 0 Calibration Plot (5510MHz)

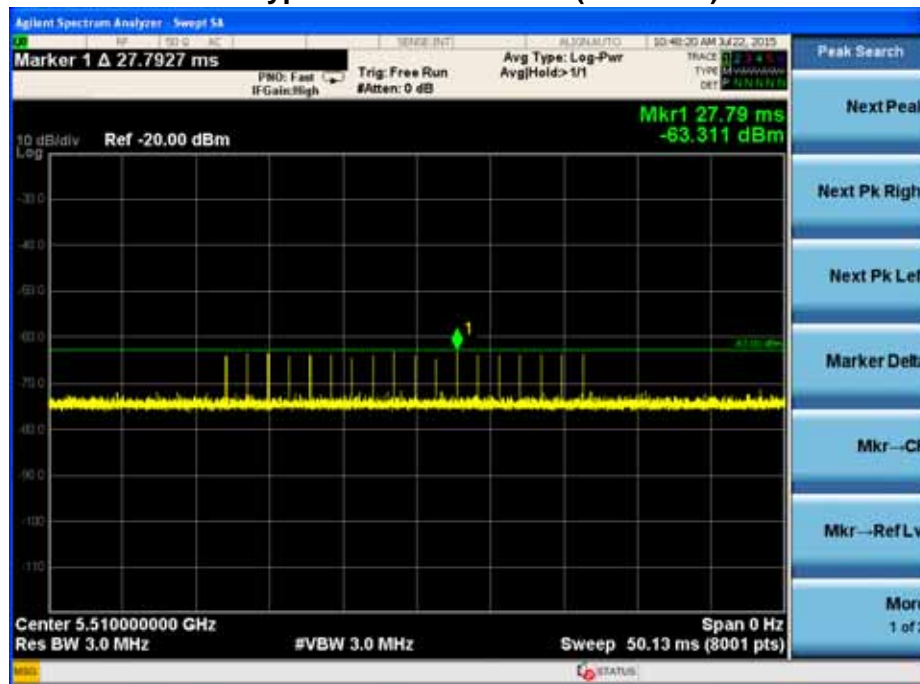

2. Channel Move Time and Channel Closing Transmission Time

2.1. Test Procedure

These tests define how the following DFS parameters are verified during In-Service Monitoring; Channel Closing Transmission Time and Channel Move Time.

The steps below define the procedure to determine the above mentioned parameters when a radar burst with a level -61dBm is generated on the operating channel of the U-NII device.

A U-NII device operating as a Client device will associate with the Master device at 5500MHz.

During the in-service monitoring detection probability and channel moving tests the system was configured with a streaming video file from the master device (sourced by the PC connected to the master device via an Ethernet interface) to the client device. The streamed file was the "FCC" test file and the client device was using Media Player Classic as required by FCC Part 15 Subpart E.

Observe the transmissions of the EUT at the end of the radar burst on the operating channel for duration greater than 10 seconds. Measure and record the transmissions from the spectrum analyzer during the observation time (Channel Move Time). Compare the channel move time and channel closing transmission time results to the limits defined in the DFS Response requirement values table.

2.2. Test Requirement

Parameter	Value
Channel Move Time	10 Seconds
Channel Closing Transmission Time	200 milliseconds + approx. 60 milliseconds over remaining 10 seconds period

2.3. Uncertainty

± 1ms.

2.4. Test Result of Channel Move Time and Channel Closing Transmission Time

Product : Wireless Sensor
Type 0 radar at 5300MHz

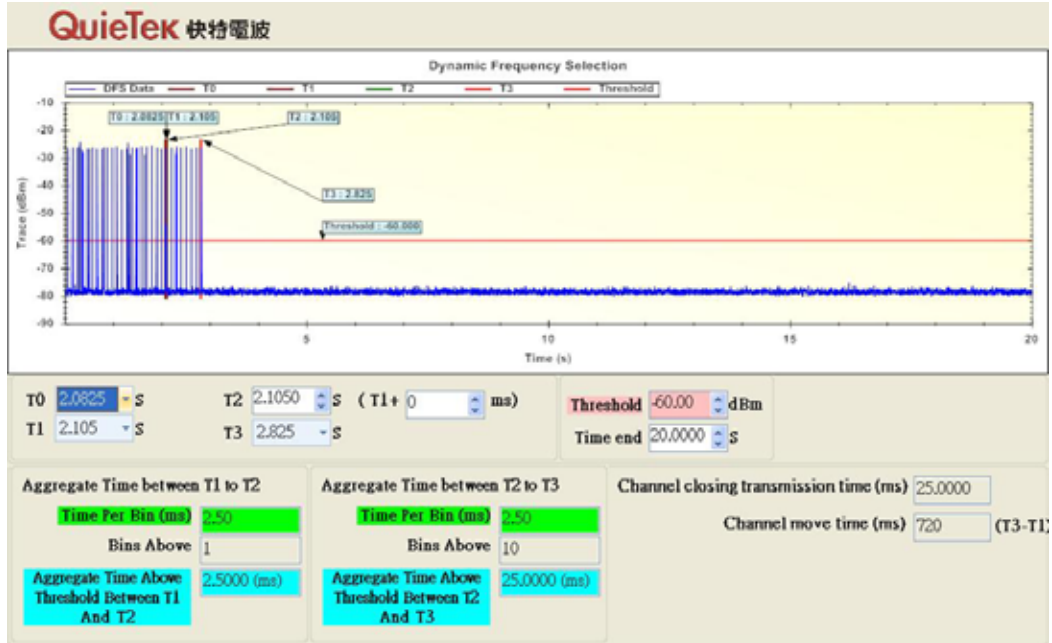

Test Item	Limit	Results
Channel Move Time	10 s	Pass
Channel Closing Transmission Time	200ms + an aggregate of 60ms over remaining 10 seconds period.	Pass

Type 0 radar at 5310MHz

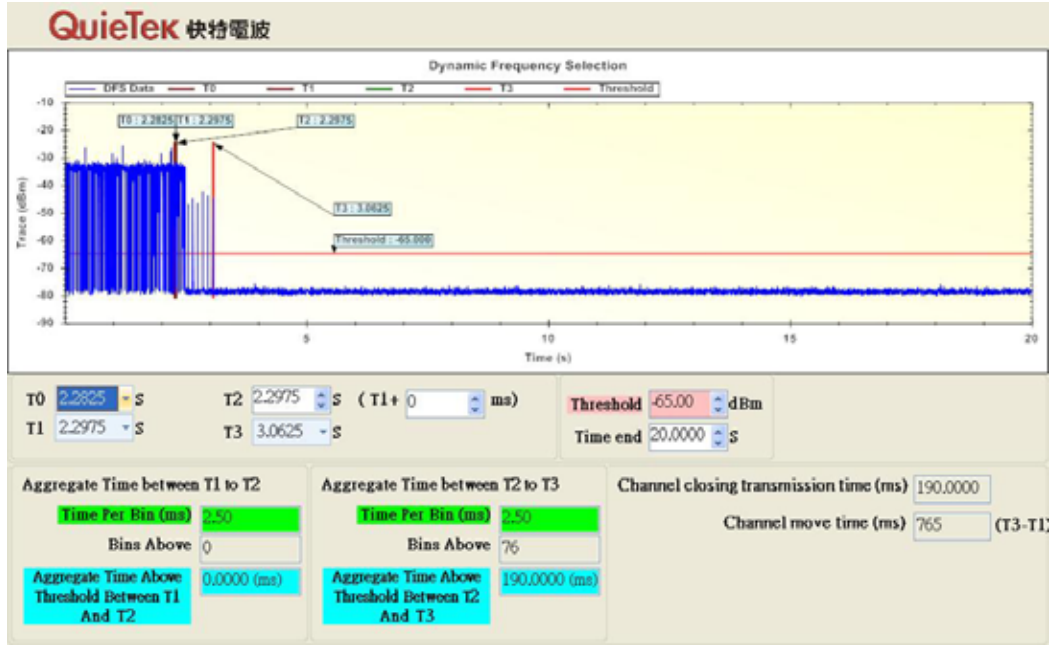

Test Item	Limit	Results
Channel Move Time	10 s	Pass
Channel Closing Transmission Time	200ms + an aggregate of 60ms over remaining 10 seconds period.	Pass

Type 0 radar at 5500MHz

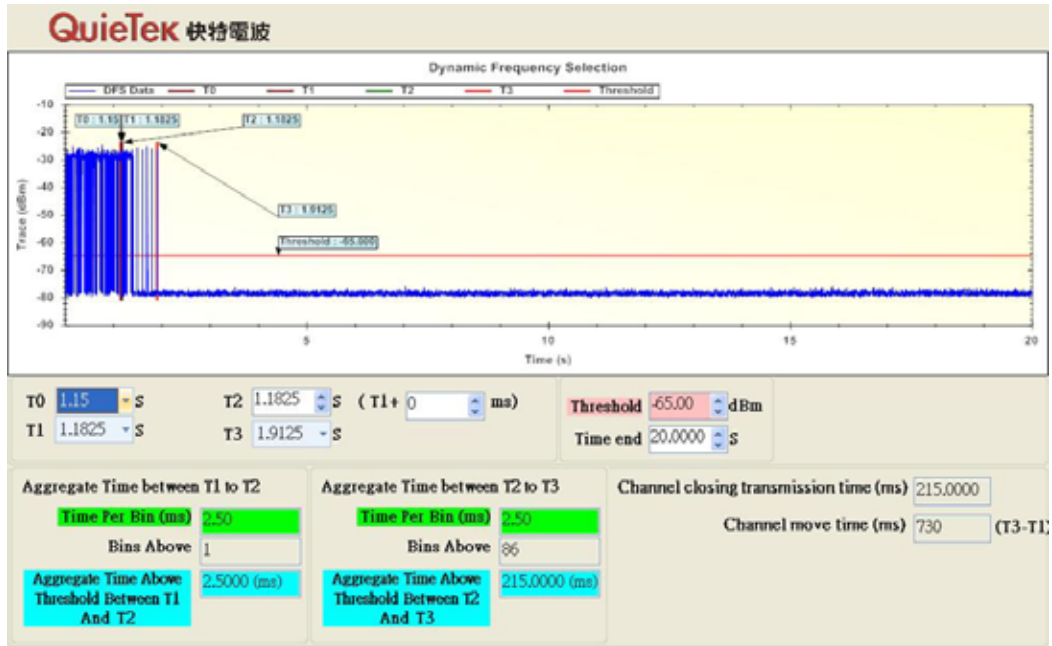

Test Item	Limit	Results
Channel Move Time	10 s	Pass
Channel Closing Transmission Time	200ms + an aggregate of 60ms over remaining 10 seconds period.	Pass

Type 0 radar at 5510MHz

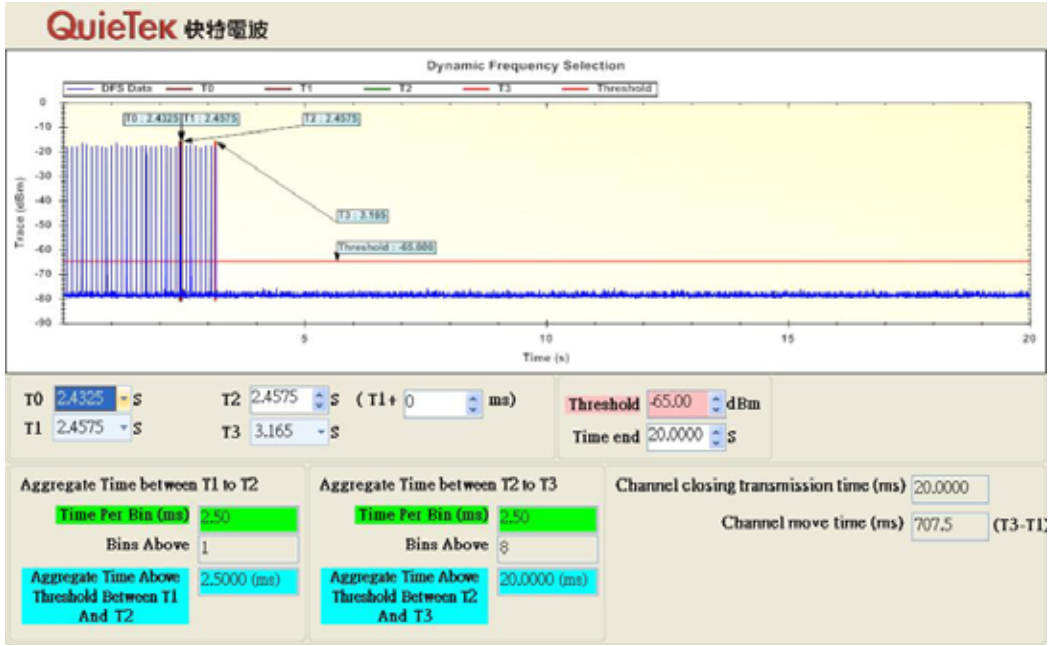

Test Item	Limit	Results
Channel Move Time	10 s	Pass
Channel Closing Transmission Time	200ms + an aggregate of 60ms over remaining 10 seconds period.	Pass

The End