

# Test Report

## FCC Part15 Subpart E

Product Name : AB-R1  
Model No. : AB-R1  
FCC ID : 2AB6UABR1  
IC : 12163A-ABR1

Applicant : August Home, INC.

Address : 657 Bryant Street San Francisco, CA 94107 USA

Date of Receipt : Jul. 17, 2015  
Test Date : Jul. 17, 2015~ Jul. 31, 2015  
Issued Date : Jul. 31, 2015  
Report No. : 1570462R-RF-US-P09V01  
Report Version : V1.0

The test results relate only to the samples tested.

The test results shown in the test report are traceable to the national/international standard through the calibration of the equipment and evaluated measurement uncertainty herein.

This report must not be used to claim product endorsement by any agency of the government.

The test report shall not be reproduced without the written approval of QuieTek Corporation.

## Test Report Certification

Issued Date : Jul. 31, 2015

Report No. : 1570462R-RF-US-P09V01



Product Name : AB-R1  
Applicant : August Home, INC.  
Address : 657 Bryant Street San Francisco, CA 94107 USA  
Manufacturer : August Home, INC.  
Address : 657 Bryant Street San Francisco, CA 94107 USA  
Model No. : AB-R1  
FCC ID : 2AB6UABR1  
IC : 12163A-ABR1  
EUT Voltage : AC 16V  
Brand Name : August  
Applicable Standard : FCC CFR Title 47 Part 15 Subpart E: 2015  
ANSI C63.4:2014;  
ANSI C63.10:2013;  
789033 D02 General UNII Test Procedures New Rules v01  
Industry Canada RSS-Gen Issue 4  
Industry Canada RSS-247 Issue 1  
Test Result : Complied  
Performed Location : Suzhou EMC Laboratory  
No.99 Hongye Rd., Suzhou Industrial Park Loufeng Hi-Tech  
Development Zone., Suzhou, China  
TEL: +86-512-6251-5088 / FAX: +86-512-6251-5098  
FCC Registration Number: 800392; IC Lab Code: 4075B

Documented By : Elaine Wang  
Elaine Wang Senior Engineer  
Reviewed By : Harry Zhao  
Harry Zhao RF Engineering Manager  
Approved By : Dream Cao  
Dream Cao Director

## Laboratory Information

We, **Quietek Corporation**, are an independent EMC and safety consultancy that was established the whole facility in our laboratories. The test facility has been accredited/accepted(audited or listed) by the following related bodies in compliance with ISO 17025, EN 45001 and specified testing scope:

<b>Taiwan R.O.C.</b>	<b>:</b>	<b>BSMI, NCC</b>
<b>USA</b>	<b>:</b>	<b>FCC</b>
<b>Japan</b>	<b>:</b>	<b>VCCI</b>
<b>China</b>	<b>:</b>	<b>CNAS</b>

The related certificate for our laboratories about the test site and management system can be downloaded from Quietek Corporation's Web Site :<http://www.quietek.com/tw/ctg/cts/accreditations.htm>

The address and introduction of Quietek Corporation's laboratories can be founded in our Web site :  
<http://www.quietek.com/>

If you have any comments, Please don't hesitate to contact us. Our contact information is as below:

### **HsinChu Testing Laboratory :**

No.75-2, 3rd Lin, Wangye Keng, Yonghxing Tsuen, Qionglin Shiang, Hsinchu County 307, Taiwan, R.O.C.  
TEL:+886-3-592-8858 / FAX:+886-3-592-8859                      E-Mail : [service@quietek.com](mailto:service@quietek.com)

### **LinKou Testing Laboratory :**

No.5-22, Ruishukeng, Linkou Dist., New Taipei City 24451, Taiwan, R.O.C.  
TEL : 886-2-8601-3788 / FAX : 886-2-8601-3789                      E-Mail : [service@quietek.com](mailto:service@quietek.com)

### **Suzhou Testing Laboratory :**

No.99 Hongye Rd., Suzhou Industrial Park Loufeng Hi-Tech Development Zone., SuZhou, China  
TEL : +86-512-6251-5088 / FAX : 86-512-6251-5098                      E-Mail : [service@quietek.com](mailto:service@quietek.com)

## TABLE OF CONTENTS

Description	Page
1. General Information.....	7
1.1. EUT Description .....	7
1.2. Mode of Operation.....	11
1.3. Tested System Details .....	12
1.4. Configuration of Tested System.....	13
1.5. EUT Exercise Software.....	14
2. Technical Test.....	15
2.1. Summary of Test Result.....	15
For FCC .....	15
For IC 16	
2.2. Test Environment.....	16
3. Conducted Emission.....	17
3.1. Test Equipment.....	17
3.2. Test Setup.....	17
3.3. Limit.....	18
3.4. Test Procedure .....	18
3.5. Uncertainty .....	19
3.6. Test Result.....	20
4. Radiated Emission.....	22
4.1. Test Equipment.....	22
4.2. Test Setup.....	23
4.3. Limit.....	24
4.4. Test Procedure .....	24
4.5. Uncertainty .....	25
4.6. Test Result.....	26
5. Occupied Bandwidth.....	34
5.1. Test Equipment.....	34
5.2. Test Setup.....	34
5.3. Limit.....	34
5.4. Test Procedure .....	35
5.5. Uncertainty .....	36
5.6. Test Result.....	37
6. 6dB Occupied Bandwidth .....	56
6.1. Test Equipment.....	56
6.2. Test Setup.....	56
6.3. Limit.....	56
6.4. Test Procedure .....	57

6.5.	Uncertainty .....	57
6.6.	Test Result.....	58
7.	Power Output.....	64
7.1.	Test Equipment.....	64
7.2.	Test Setup.....	64
7.3.	Limit.....	64
7.4.	Test Procedure .....	66
7.5.	Uncertainty .....	66
7.6.	Test Result.....	67
8.	Peak Power Spectral Density .....	71
8.1.	Test Equipment.....	71
8.2.	Test Setup.....	71
8.3.	Limit.....	71
8.4.	Test Procedure .....	73
8.5.	Uncertainty .....	73
8.6.	Test Result.....	74
9.	Radiated Emission Band Edge .....	94
9.1.	Test Equipment.....	94
9.2.	Test Setup.....	94
9.3.	Limit.....	94
9.4.	Test Procedure .....	97
9.5.	Uncertainty .....	97
9.6.	Test Result.....	98
10.	Frequency Stability .....	140
10.1.	Test Equipment.....	140
10.2.	Test Setup.....	140
10.3.	Limit.....	140
10.4.	Test Procedure .....	141
10.5.	Uncertainty .....	141
10.6.	Test Result.....	142

### History of This Test Report

REPORT NO.	VERSION	DESCRIPTION	ISSUED DATE
1570462R-RF-US-P09V01	V1.0	Initial Issued Report	Jul. 31, 2015

## 1. General Information

### 1.1. EUT Description

Product Name	AB-R1
Brand Name	August
Model No.	AB-R1
EUT Voltage	AC 16V
Frequency Range	<p><b>For 2.4GHz Band</b> 802.11b/g/n(20MHz): 2412~2462MHz</p> <p><b>For 5GHz Band</b> 802.11a/n(20MHz):5180~5320MHz, 5500~5700MHz, 5745~5825MHz 802.11n(40MHz):5190~5310MHz, 5510~5670MHz, 5755~5795MHz</p>
Channel Number	<p><b>For 2.4GHz Band</b> 802.11b/g/n(20MHz): 11</p> <p><b>For 5GHz Band</b> 802.11a/n(20MHz): 24 802.11n(40MHz): 12</p>
Type of Modulation	802.11b: DSSS
	802.11a/g/n: OFDM
Data Rate	802.11a/g: 6/9/12/18/24/36/48/54 Mbps
	802.11b: 1/2/5.5/11 Mbps
	802.11n: up to 150 Mbps
Channel Control	Auto
Antenna Delivery	1*Tx + 1*Rx
Antenna Type	Reference to Antenna List
Peak Antenna Gain	Reference to Antenna List

**For 5.0GHz Band**

802.11a/n(20MHz) Working Frequency of Each Channel:

Channel	Frequency	Channel	Frequency	Channel	Frequency	Channel	Frequency
36	5180 MHz	40	5200 MHz	44	5220 MHz	48	5240MHz
52	5260 MHz	56	5280 MHz	60	5300 MHz	64	5320MHz
100	5500 MHz	104	5520 MHz	108	5540 MHz	112	5560 MHz
116	5580 MHz	120	5600 MHz	124	5620 MHz	128	5640 MHz
132	5660 MHz	136	5680 MHz	140	5700 MHz	149	5745 MHz
153	5765 MHz	157	5785 MHz	161	5805 MHz	165	5825 MHz

802.11n(40MHz) Working Frequency of Each Channel:

Channel	Frequency	Channel	Frequency	Channel	Frequency	Channel	Frequency
38	5190 MHz	46	5230 MHz	54	5270 MHz	62	5310 MHz
102	5510 MHz	110	5550 MHz	118	5590 MHz	126	5630 MHz
134	5670 MHz	142	5710 MHz	151	5755 MHz	159	5795 MHz

**Antenna List**

Antenna	Manufacturer	Model No.	Peak Gain
PIFA Antenna	N/A	WA-P-LB-01 -134	2.4GHz band: 3.13dBi 5GHz Band: 2.65dBi



Power Parameter Value of the test software

Test Mode	Test Channel	Ant 1
802.11a	5180	-1
	5200	-1
	5240	-1
	5260	-1
	5300	-1
	5320	-1
	5500	-1
	5600	-1
	5700	-1
	5745	-1
	5785	-1
	5825	-1
802.11n(20MHz)	5180	-1
	5200	-1
	5240	-1
	5260	-1
	5300	-1
	5320	-1
	5500	-1
	5600	-1
	5700	-1
	5745	-1
	5785	-1
	5825	-1
802.11n(40MHz)	5190	-1
	5230	-1
	5270	-1
	5310	-1
	5510	-1
	5550	-1
	5670	-1
	5755	-1
	5795	-1
	5825	-1

The test mode of the test software can support.

Test Mode	Ant 1
802.11a	√
802.11n(20MHz)	√
802.11n(40MHz)	√

Duty Cycle

Test Mode	Duty Cycle
802.11a	96.5%
802.11n(20MHz)	94.3%
802.11n(40MHz)	91.2%

## 1.2. Mode of Operation

QuieTek has verified the construction and function in typical operation. All the test modes were carried out with the EUT in normal operation, which was shown in this test report and defined as:

Test Mode
Mode 1: Transmit by 802.11a
Mode 2: Transmit by 802.11n(20MHz)
Mode 3: Transmit by 802.11n(40MHz)

### Note:

1. Regards to the frequency band operation: the lowest, middle and highest frequency of channel were selected to perform the test, then shown on this report.
2. The radiation measure measurements are performed in X, Y, Z axis positioning. Only the worst case is shown in the report.
3. The channel of 5600MHz presented in the report is only adaptive to FCC test.

### 1.3. Tested System Details

The types for all equipments, plus descriptions of all cables used in the tested system (including inserted cards) are:

Product		Manufacturer	Model No.	Serial No.	Power Cord
1	Notebook	Asus	N80V	8BN0AS226971468	N/A

### 1.4. Configuration of Tested System

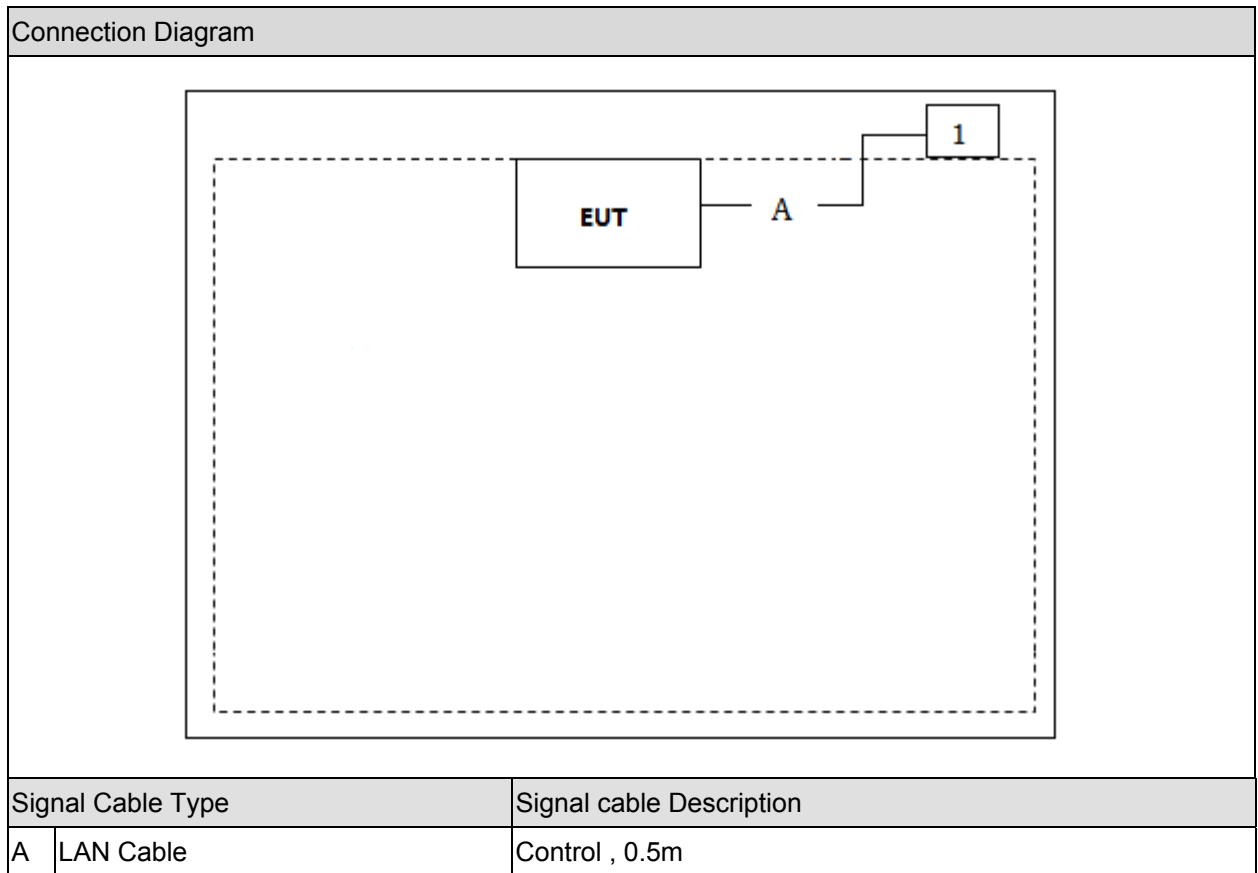

### 1.5. EUT Exercise Software

1	Setup the EUT and simulators as shown on above.
2	Turn on the power of equipment.
3	Run the RF test software , and set the test mode and channel, then press OK to start continue Transmit or receive.

## 2. Technical Test

### 2.1. Summary of Test Result

- No deviations from the test standards  
 Deviations from the test standards as below description:

#### For FCC

Performed Test Item	Normative References	Test Performed	Deviation
Conducted Emission	FCC CFR Title 47 Part 15 Subpart E: 2014 Section 15.207	Yes	No
Radiated Emission	FCC CFR Title 47 Part 15 Subpart E: 2014 Section 15.209	Yes	No
26dB Occupied Bandwidth	FCC CFR Title 47 Part 15 Subpart E: 2014 Section 15.407(a)	Yes	No
6dB Occupied Bandwidth	FCC CFR Title 47 Part 15 Subpart E:2014 Section 15.407(e)	Yes	No
Power Output	FCC CFR Title 47 Part 15 Subpart E: 2014 Section 15.407(a)	Yes	No
Peak Power Spectral Density	FCC CFR Title 47 Part 15 Subpart E: 2014 Section 15.407(a)	Yes	No
Radiated Emission Band Edge	FCC CFR Title 47 Part 15 Subpart E: 2014 Section 15.205, 15.407(b)	Yes	No
Frequency Stability	FCC CFR Title 47 Part 15 Subpart E: 2014 Section 15.407(g)	Yes	No

**For IC**

Performed Test Item	Normative References	Test Performed	Deviation
Conducted Emission	RSS-Gen Issue 4 November 2014 Section 8.8	Yes	No
Radiated Emission	RSS-247 Issue 1 May 2015 Section 5.5	Yes	No
99% Occupied Bandwidth	RSS-Gen Issue 4 November 2014 Section 6.6	Yes	No
6dB Occupied Bandwidth	RSS-247 Issue 1 May 2015 Section 6.2	Yes	No
Power Output	RSS-247 Issue 1 May 2015 Section 6.2	Yes	No
Peak Power Spectral Density	RSS-247 Issue 1 May 2015 Section 6.2	Yes	No
Radiated Emission Band Edge	RSS-Gen Issue 4 November 2014 Section 8.10	Yes	No
Frequency Stability	RSS-Gen Issue 4 November 2014 Section 8.11	Yes	No

**2.2. Test Environment**

Items	Required (IEC 68-1)	Actual
Temperature (°C)	15-35	21
Humidity (%RH)	25-75	50
Barometric pressure (mbar)	860-1060	950-1000



### 3. Conducted Emission

#### 3.1. Test Equipment

Conducted Emission / TR-1

Instrument	Manufacturer	Type No.	Serial No.	Cal. Due Date
EMI Test Receiver	R&S	ESCI	100726	2016.03.28
Two-Line V-Network	R&S	ENV216	100043	2016.03.28
Two-Line V-Network	R&S	ENV216	100044	2015.09.16
50ohm Coaxial Switch	Anritsu	MP59B	6200464462	2016.03.01
50ohm Termination	SHX	TF2	07081401	2015.09.16
Temperature/Humidity Meter	zhicheng	ZC1-2	TR1-TH	2016.01.08

Note: All equipments are calibrated with traceable calibrations. Each calibration is traceable to the national or international standards.

#### 3.2. Test Setup

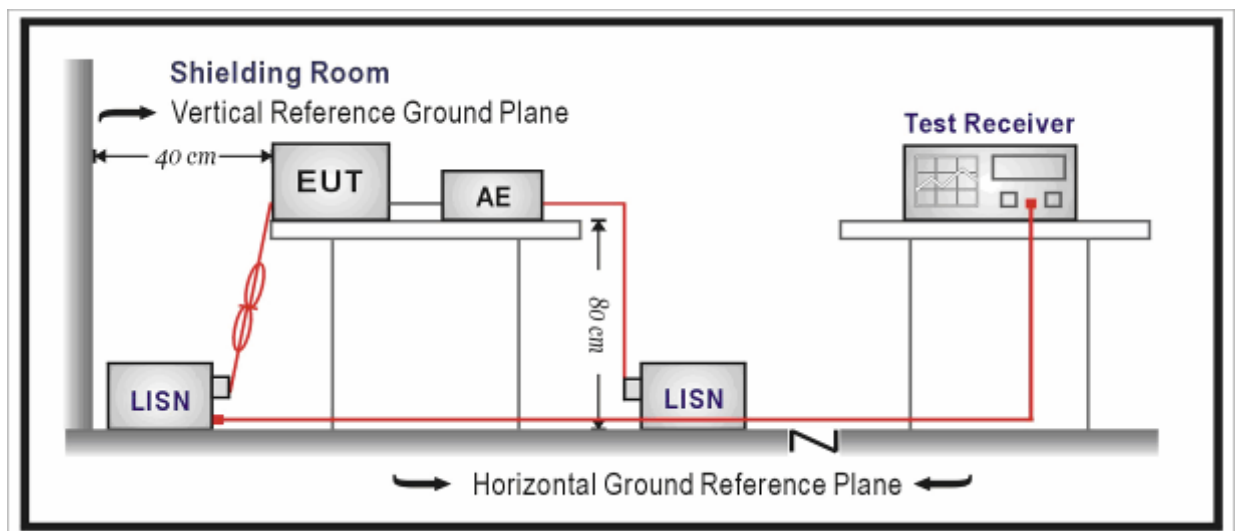

### 3.3. Limit

For FCC&IC

FCC Part 15 Subpart C Paragraph 15.207 Limits		
Frequency (MHz)	QP (dBuV)	AV (dBuV)
0.15 - 0.50	66 - 56	56 - 46
0.50 - 5.0	56	46
5.0 - 30	60	50

Note 1: The lower limit shall apply at the transition frequencies.

Note 2: The limit decreases linearly with the logarithm of the frequency in the range 0.15 MHz to 0.5 MHz.

### 3.4. Test Procedure

according to ANSI C63.4:2014& ANSI C63.10:2013&789033 D02 General UNII Test Procedures New Rules v01& FCC CFR Title 47 Part 15 Subpart E: 2014& Industry Canada RSS-Gen Issue 4 Industry Canada RSS-247 Issue 1

The EUT was placed on a platform of nominal size, 1 m by 1.5 m, raised 80 cm above the conducting ground plane. The vertical conducting plane was located 40 cm to the rear of the EUT. All other surfaces of EUT were at least 80 cm from any other grounded conducting surface. The EUT and simulators are connected to the main power through a line impedance stabilization network (LISN). The LISN provides a 50 ohm /50uH coupling impedance for the measuring equipment. The peripheral devices are also connected to the main power through a LISN. (Please refer to the block diagram of the test setup and photographs)

Each current-carrying conductor of the EUT power cord, except the ground (safety) conductor, was individually connected through a LISN to the input power source.

The excess length of the power cord between the EUT and the LISN receptacle were folded back and forth at the center of the lead to form a bundle not exceeding 40 cm in length.

Conducted emissions were investigated over the frequency range from 0.15MHz to 30MHz using a receiver bandwidth of 9kHz.

### **3.5. Uncertainty**

The measurement uncertainty is defined as  $\pm 2.02$  dB

### 3.6. Test Result

Engineer: Scott	
Site: TR5	Time: 2015/07/31 - 10:25
Limit: FCC_Part15.207_CE_AC Power_ClassB	Margin: 0
Probe: ENV216_101044(0.009-30MHz)	Polarity: Line
EUT: AB-R1	Power: AC 16V
Note: Mode 1 802.11 a	

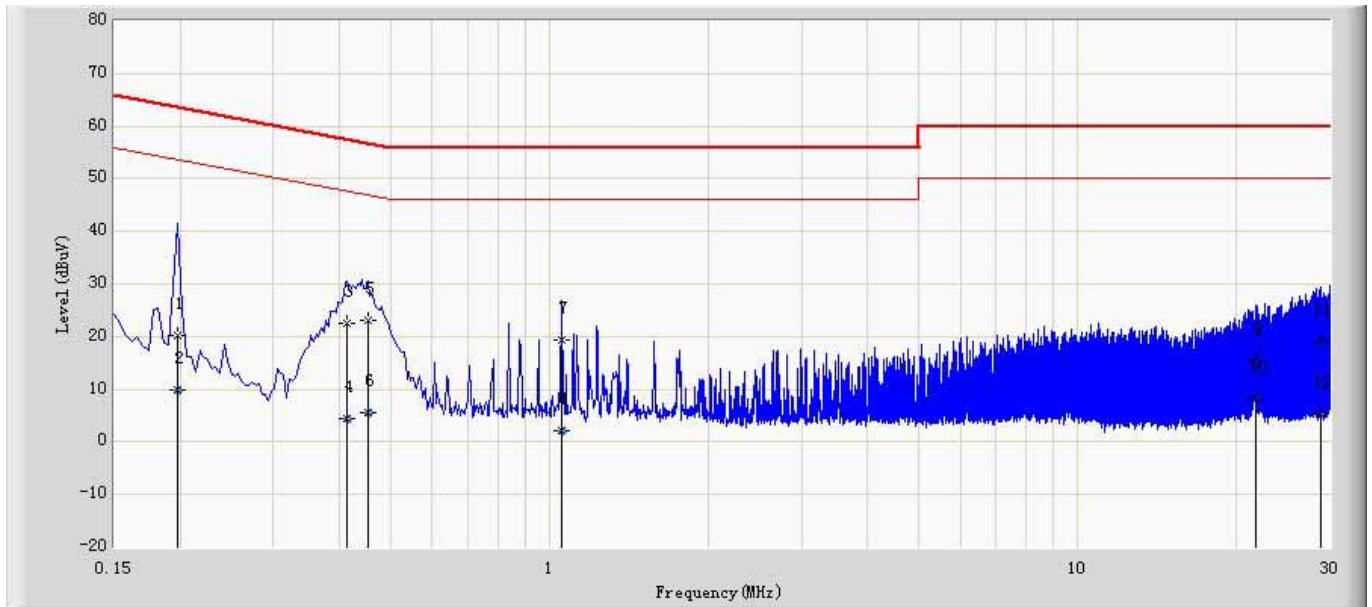

No	Mark	Frequency (MHz)	Measure Level (dBuV)	Reading Level (dBuV)	Over Limit (dB)	Limit (dBuV)	Factor (dB)	Type
1		0.198	20.302	10.442	-43.392	63.694	9.860	QP
2		0.198	9.750	-0.110	-43.944	53.694	9.860	AV
3		0.414	22.436	12.539	-35.132	57.568	9.897	QP
4		0.414	4.536	-5.362	-43.032	47.568	9.897	AV
5	*	0.454	23.114	13.210	-33.687	56.802	9.904	QP
6		0.454	5.610	-4.294	-41.191	46.802	9.904	AV
7		1.054	19.368	9.560	-36.632	56.000	9.808	QP
8		1.054	2.262	-7.546	-43.738	46.000	9.808	AV
9		21.670	15.345	4.802	-44.655	60.000	10.543	QP
10		21.670	8.111	-2.432	-41.889	50.000	10.543	AV
11		28.902	19.155	8.546	-40.845	60.000	10.609	QP
12		28.902	5.287	-5.322	-44.713	50.000	10.609	AV

Engineer: Scott	
Site: TR5	Time: 2015/07/31 - 10:31
Limit: FCC_Part15.207_CE_AC Power_ClassB	Margin: 0
Probe: ENV216_101044(0.009-30MHz)	Polarity: Neutral
EUT: AB-R1	Power: AC 16V
Note: Mode 1 802.11a	

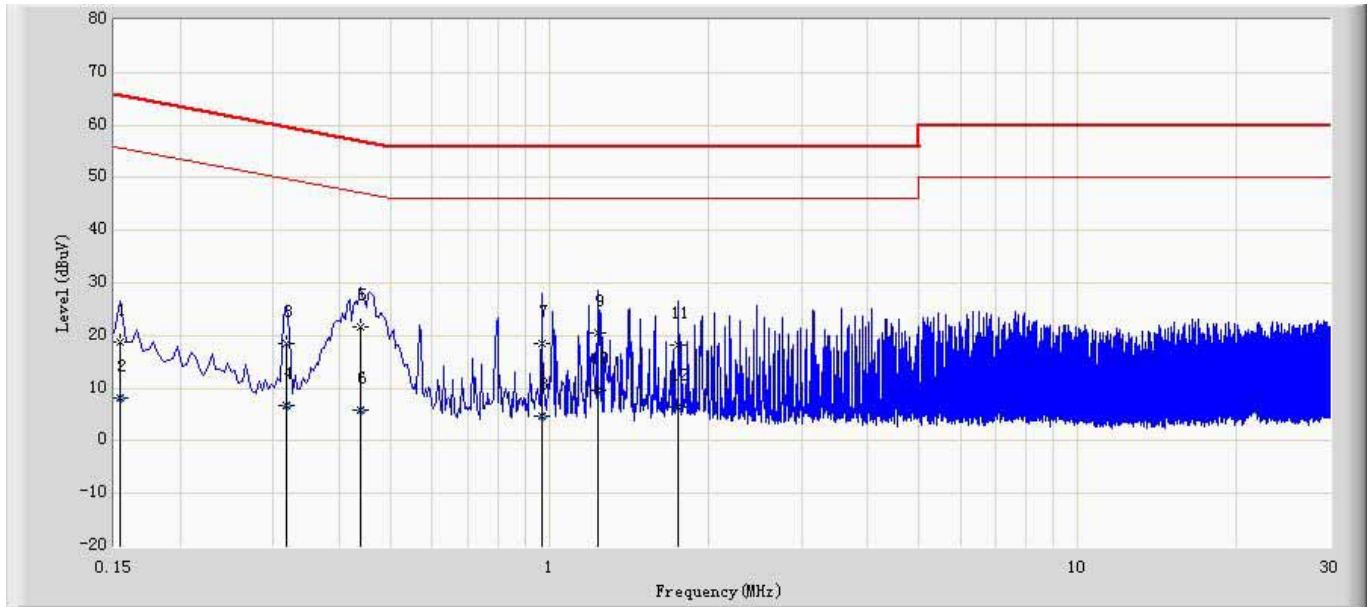

No	Mark	Frequency (MHz)	Measure Level (dBuV)	Reading Level (dBuV)	Over Limit (dB)	Limit (dBuV)	Factor (dB)	Type
1		0.154	18.875	8.892	-46.906	65.781	9.982	QP
2		0.154	8.261	-1.722	-47.520	55.781	9.982	AV
3		0.318	18.423	8.464	-41.336	59.759	9.959	QP
4		0.318	6.621	-3.338	-43.138	49.759	9.959	AV
5	*	0.438	21.701	11.673	-35.398	57.100	10.029	QP
6		0.438	5.764	-4.265	-41.336	47.100	10.029	AV
7		0.966	18.626	8.603	-37.374	56.000	10.023	QP
8		0.966	4.697	-5.326	-41.303	46.000	10.023	AV
9		1.234	20.554	10.540	-35.446	56.000	10.014	QP
10		1.234	9.554	-0.460	-36.446	46.000	10.014	AV
11		1.754	18.109	8.142	-37.891	56.000	9.967	QP
12		1.754	6.513	-3.454	-39.487	46.000	9.967	AV

Note: All the test modes are pretested and mode 1 802.11b mode was found to be the worst mode, so the data of this test mode was recorded.

## 4. Radiated Emission

### 4.1. Test Equipment

#### Radiated Emission / AC-2

Instrument	Manufacturer	Type No.	Serial No.	Cal. Due Date
EMI Test Receiver	R&S	ESCI	100573	2016.03.28
Loop Antenna	R&S	HFH2-Z2	833799/003	2015.11.17
Bilog Chainenna	Teseq GmbH	CBL6112D	27611	2015.10.15
Coaxial Cable	Huber+Suhner	SUCOFLEX 106	AC2-C	2016.03.01
Temperature/Humidity Meter	Zhicheng	ZC1-2	AC2-TH	2016.01.08

#### Radiated Emission / AC-5

Instrument	Manufacturer	Type No.	Serial No.	Cal. Due Date
Spectrum Analyzer	Agilent	N9020A	MY49100159	2016.03.28
Spectrum Analyzer	Agilent	E4446A	MY45300103	2016.01.07
Preamplifier	Miteq	NSP1800-25	1364185	2016.05.05
Preamplifier	Quietek	AP-040G	CHM-0906001	2016.05.05
DRG Horn	ETS-Lindgren	3117	00123988	2016.01.21
Broad-Band Horn Antenna	Schwarzbeck	BBHA9170	294	2015.11.24
Coaxial Cable	Huber+Suhner	SUCOFLEX 106	AC5-C1	2016.03.01
Coaxial Cable	Huber+Suhner	SUCOFLEX 106	AC5-C2	2016.03.01
Coaxial Cable	Huber+Suhner	SUCOFLEX 102	AC5-C3	2016.03.01
EMI Receiver	Agilent	N9038A	MY51210196	2016.06.09
Temperature/Humidity Meter	Zhichen	ZC1-2	AC5-TH	2016.01.08

Note 1: All equipments are calibrated with traceable calibrations. Each calibration is traceable to the national or international standards.

## 4.2. Test Setup

For FCC&IC

Below 30MHz Test Setup:

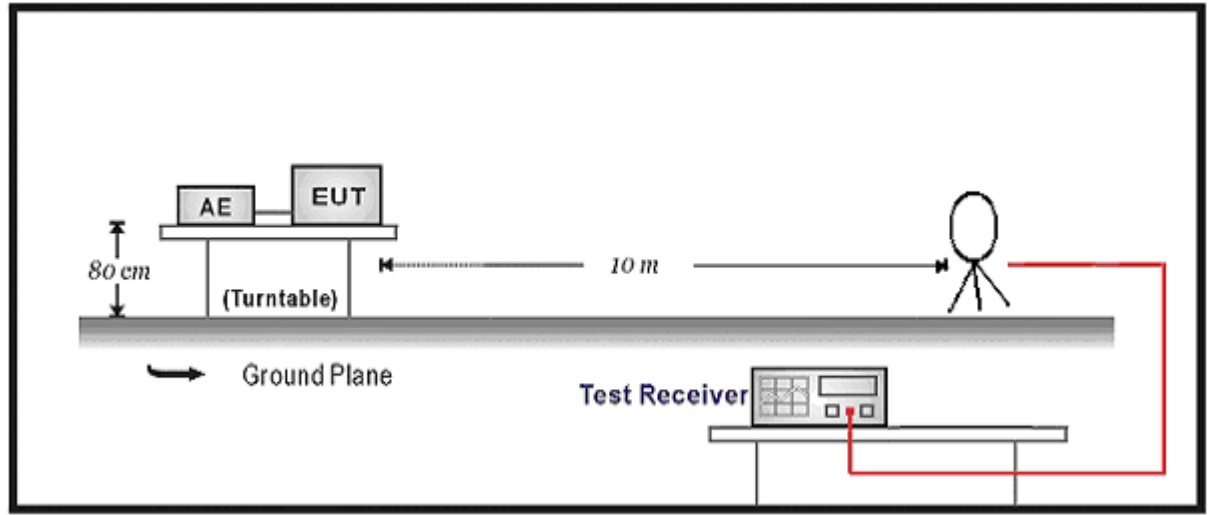

Below 1GHz Test Setup:

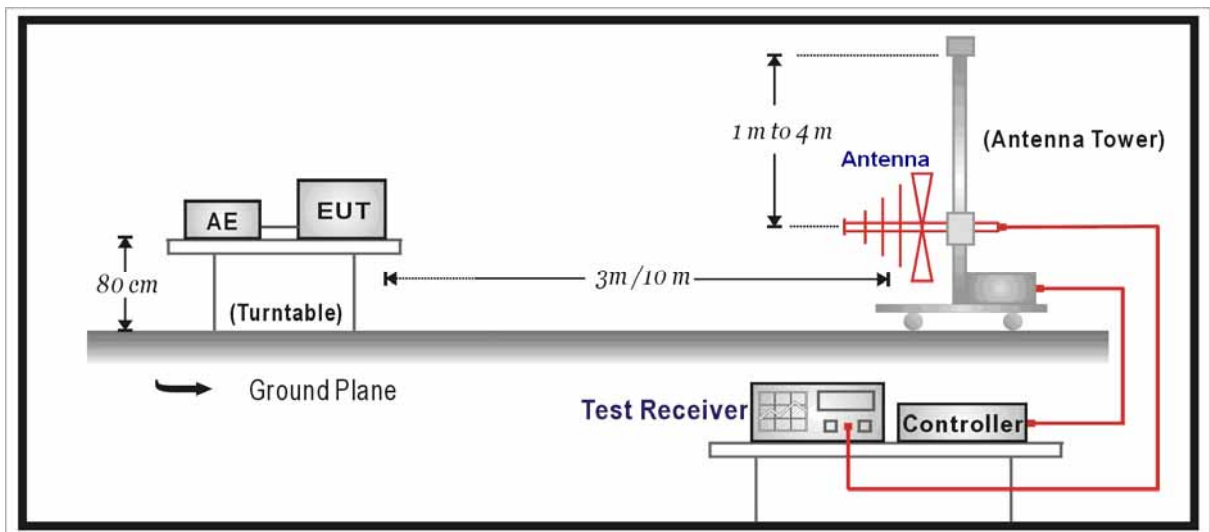

Above 1GHz Test Setup:

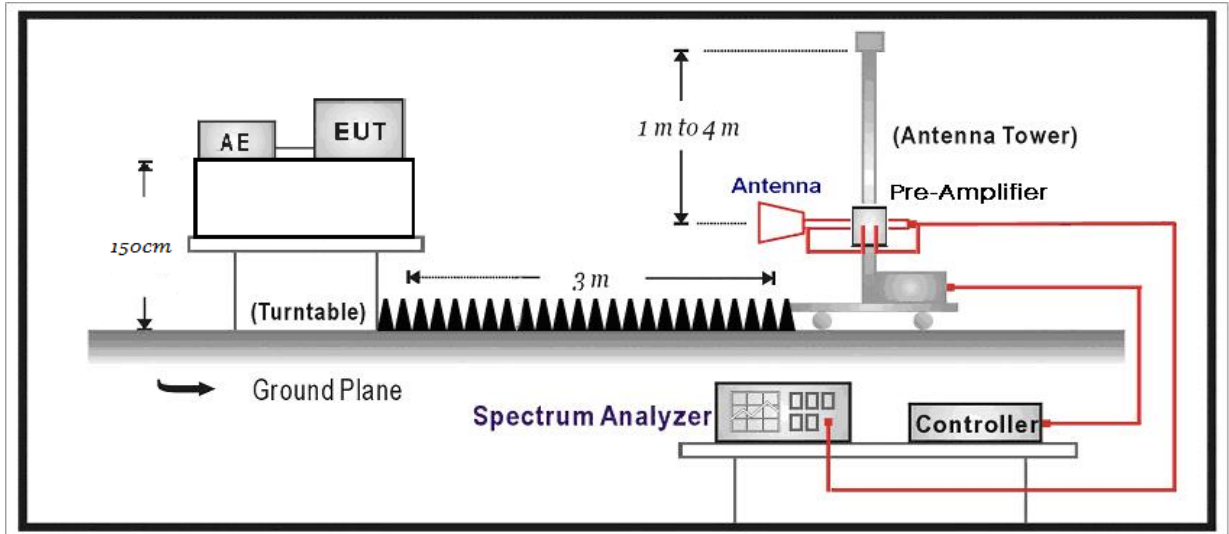

**4.3. Limit**

FCC Part 15 Subpart C Paragraph 15.209		
Frequency (MHz)	Distance (m)	Level (dBuV/m)
30 - 88	3	40
88 - 216	3	43.5
216 - 960	3	46
Above 960	3	54

Note 1: The lower limit shall apply at the transition frequency.

Note 2: Distance refers to the distance in meters between the measuring instrument Chainenna and the closed point of any part of the device or system.

Note 3:  $E$  field strength (dBuV/m) =  $20 \log E$  field strength (uV/m)

**4.4. Test Procedure**

According to ANSI C63.4:2014& ANSI C63.10:2013&789033 D02 General UNII Test Procedures New Rules v01& FCC CFR Title 47 Part 15 Subpart E: 2014& Industry Canada RSS-Gen Issue 4 Industry Canada RSS-247 Issue 1

The EUT is placed on a turn table which is 0.8 meter above ground. The turn table is rotated 360 degrees to determine the position of the maximum emission level. The EUT was



positioned such that the distance from Chainenna to the EUT was 3 meters.

The Chainenna is scanned from 1 meter to 4 meters to find out the maximum emission level. This is repeated for both horizontal and vertical polarization of the Chainenna. In order to find the maximum emission, all of the interface cables were manipulated according to ANSI C63.4:2014 on radiated measurement.

The resolution bandwidth below 1GHz setting on the field strength meter is 120 kHz and above 1GHz is 1MHz.

The frequency range from 30MHz to 10th harmonic is checked.

Note: When doing emission measurement above 1GHz, the horn Chainenna will be bended down a little (as horn Chainenna has the narrow beamwidth) in order to keeping the Chainenna in the “cone of radiation” of EUT. The 3dB beamwidth is 60~10 degrees for H-plane and 90~10 degrees for E-plane.

#### **4.5. Uncertainty**

The measurement uncertainty above 1G is defined as  $\pm 3.9$  dB  
below 1G is defined as  $\pm 3.8$  dB

#### 4.6. Test Result

All of the test result shown indicates the worst case, and spectrum analyzer parameters setting as shown below:

Peak detector: RBW = 1MHz, VBW = 3MHz, sweep time = 200ms;

Average detector: RBW = 1MHz, VBW = 10Hz, sweep time = auto.

Mode1: Transmit by 802.11a

CH	Antenna	Frequency (MHz)	Reading Level (dBuV/m)	Factor (dB)	Measure Level (dBuV/m)	Limit (dBuV/m)	Margin (dB)	Detector
36	H	10360.0	31.8	17.3	49.1	54(Note3)	-4.9	PK
	H	15540.0	23.1	23.8	46.9	54(Note3)	-7.1	PK
	V	10360.0	32.0	17.3	49.3	54(Note3)	-4.7	PK
	V	15540.0	22.7	23.8	46.5	54(Note3)	-7.5	PK
40	H	10400.0	31.3	18.7	50.0	54(Note3)	-4.0	PK
	H	15600.0	19.9	27.5	47.4	54(Note3)	-6.6	PK
	V	10400.0	31.3	18.7	50.0	54(Note3)	-4.0	PK
	V	15600.0	19.6	27.5	47.1	54(Note3)	-6.9	PK
48	H	10480.0	31.8	17.2	49.0	54(Note3)	-5.0	PK
	H	15720.0	19.5	26.4	45.9	54(Note3)	-8.1	PK
	V	10480.0	32.0	17.2	49.2	54(Note3)	-4.8	PK
	V	15720.0	19.7	26.4	46.1	54(Note3)	-7.9	PK
52	H	10520.0	31.3	18.8	50.1	54(Note3)	-3.9	PK
	H	15780.0	17.5	26.9	44.4	54(Note3)	-9.6	PK
	V	10520.0	31.1	18.8	49.9	54(Note3)	-4.1	PK
	V	15780.0	17.3	26.9	44.2	54(Note3)	-9.8	PK
60	H	10600.0	30.3	17.8	48.1	54(Note3)	-5.9	PK
	H	15900.0	14.7	25.7	40.4	54(Note3)	-13.6	PK
	V	10600.0	31.5	17.8	49.3	54(Note3)	-4.7	PK
	V	15900.0	14.1	25.7	39.8	54(Note3)	-14.2	PK
64	H	10640.0	32.2	18.2	50.4	54(Note3)	-3.6	PK
	H	15960.0	12.9	28.0	40.9	54(Note3)	-13.1	PK
	V	10640.0	32.3	18.2	50.5	54(Note3)	-3.5	PK
	V	15960.0	13.4	28.0	41.4	54(Note3)	-12.6	PK
100	H	11000.0	32.6	18.8	51.4	54(Note3)	-2.6	PK
	H	16500.0	20.6	27.2	47.8	54(Note3)	-6.2	PK
	V	11000.0	33.0	18.8	51.8	54(Note3)	-2.2	PK
	V	16500.0	20.7	27.2	47.9	54(Note3)	-6.1	PK

120	H	11200.0	33.1	19.8	52.9	54(Note3)	-1.1	PK
	H	16800.0	22.4	26.7	49.1	54(Note3)	-4.9	PK
	V	11200.0	32.2	19.8	52.0	54(Note3)	-2.0	PK
	V	16800.0	22.3	26.7	49.0	54(Note3)	-5.0	PK
140	H	11400.0	32.7	20.1	52.8	54(Note3)	-1.2	PK
	H	17100.0	23.3	25.8	49.1	54(Note3)	-4.9	PK
	V	11400.0	32.6	20.1	52.7	54(Note3)	-1.3	PK
	V	17100.0	23.3	25.8	49.1	54(Note3)	-4.9	PK
149	H	11490.0	32.0	21.7	53.7	54(Note3)	-0.3	PK
	H	17235.0	23.7	26.1	49.8	54(Note3)	-4.2	PK
	V	11490.0	32.8	21.7	54.5	74	-19.5	PK
	V	11490.0	32.8	21.7	39.5	54	-14.5	AV
	V	11492.4	19.8	21.7	41.5	54(Note3)	-12.5	PK
157	H	11570.0	32.6	22.4	55.0	74	-19.0	PK
	H	11568.7	20.7	22.5	43.2	54	-10.8	AV
	H	17355.0	22.6	25.8	48.4	54(Note3)	-5.6	PK
	V	11570.0	32.3	22.4	54.7	74	-19.3	PK
	V	11572.1	18.6	22.4	41.0	54	-13.0	AV
	V	17355.0	23.1	25.8	48.9	54(Note3)	-5.1	PK
165	H	11650.0	30.7	23.2	53.9	54(Note3)	-0.1	PK
	H	17475.0	22.5	25.9	48.4	54(Note3)	-5.6	PK
	V	11650.0	31.3	23.2	54.5	74	-19.5	PK
	V	11651.7	19.2	23.4	42.6	54	-11.4	AV
	V	17475.0	22.3	25.9	48.2	54(Note3)	-5.8	PK

Note: 1. Measure Level = Reading Level + Factor.

2. The test frequency range, 9kHz~30MHz, 18GHz~25GHz, both of the worst case are at least 6dB below the limits, therefore no data appear in the report.

3. This limit applies for using average detector, if the test result on peak is lower than average limit, then average measurement needn't be performed.

## Mode2: Transmit by 802.11n(20MHz)

CH	Antenna	Frequency (MHz)	Reading Level (dBuV/m)	Factor (dB)	Measure Level (dBuV/m)	Limit (dBuV/m)	Margin (dB)	Detector
36	H	10360.0	31.4	17.3	48.7	54(Note3)	-5.3	PK
	H	15540.0	21.2	23.8	45.0	54(Note3)	-9.0	PK
	V	10360.0	31.8	17.3	49.1	54(Note3)	-4.9	PK
	V	15540.0	21.7	23.8	45.5	54(Note3)	-8.5	PK
40	H	10400.0	30.0	18.7	48.7	54(Note3)	-5.3	PK
	H	15600.0	19.9	27.5	47.4	54(Note3)	-6.6	PK
	V	10400.0	32.0	18.7	50.7	54(Note3)	-3.3	PK
	V	15600.0	19.1	27.5	46.6	54(Note3)	-7.4	PK
48	H	10480.0	32.4	17.2	49.6	54(Note3)	-4.4	PK
	H	15720.0	19.7	26.4	46.1	54(Note3)	-7.9	PK
	V	10480.0	32.4	17.2	49.6	54(Note3)	-4.4	PK
	V	15720.0	20.6	26.4	47.0	54(Note3)	-7.0	PK
52	H	10520.0	31.6	18.8	50.4	54(Note3)	-3.6	PK
	H	15780.0	16.9	26.9	43.8	54(Note3)	-10.2	PK
	V	10520.0	30.6	18.8	49.4	54(Note3)	-4.6	PK
	V	15780.0	16.4	26.9	43.3	54(Note3)	-10.7	PK
60	H	10600.0	30.3	17.8	48.1	54(Note3)	-5.9	PK
	H	15900.0	14.8	25.7	40.5	54(Note3)	-13.5	PK
	V	10600.0	30.5	17.8	48.3	54(Note3)	-5.7	PK
	V	15900.0	14.7	25.7	40.4	54(Note3)	-13.6	PK
64	H	10640.0	32.3	18.2	50.5	54(Note3)	-3.5	PK
	H	15960.0	12.2	28.0	40.2	54(Note3)	-13.8	PK
	V	10640.0	32.6	18.2	50.8	54(Note3)	-3.2	PK
	V	15960.0	12.7	28.0	40.7	54(Note3)	-13.3	PK
100	H	11000.0	32.2	18.8	51.0	54(Note3)	-3.0	PK
	H	16500.0	20.2	27.2	47.4	54(Note3)	-6.6	PK
	V	11000.0	31.9	18.8	50.7	54(Note3)	-3.3	PK
	V	16500.0	19.5	27.2	46.7	54(Note3)	-7.3	PK

120	H	11200.0	32.6	19.8	52.4	54(Note3)	-1.6	PK
	H	16800.0	21.7	26.7	48.4	54(Note3)	-5.6	PK
	V	11200.0	32.2	19.8	52.0	54(Note3)	-2.0	PK
	V	16800.0	22.6	26.7	49.3	54(Note3)	-4.7	PK
140	H	11400.0	32.9	20.1	53.0	54(Note3)	-1.0	PK
	H	17100.0	22.3	25.8	48.1	54(Note3)	-5.9	PK
	V	11400.0	32.6	20.1	52.7	54(Note3)	-1.3	PK
	V	17100.0	22.7	25.8	48.5	54(Note3)	-5.5	PK
149	H	11490.0	31.3	21.7	53.0	54(Note3)	-1.0	PK
	H	17235.0	23.2	26.1	49.3	54(Note3)	-4.7	PK
	V	11490.0	31.7	21.7	53.4	54(Note3)	-0.6	PK
	V	17235.0	23.8	26.1	49.9	54(Note3)	-4.1	PK
157	H	11570.0	31.8	22.4	54.2	74	-19.8	PK
	H	11569.2	18.9	22.5	41.4	54	-12.6	AV
	H	17355.0	22.7	25.8	48.5	54(Note3)	-5.5	PK
	V	11570.0	32.0	22.4	54.4	74	-19.6	PK
	V	11572.9	19.4	22.4	41.8	54	-12.2	AV
	V	17355.0	22.3	25.8	48.1	54(Note3)	-5.9	PK
165	H	11650.0	30.1	23.2	53.3	54(Note3)	-0.7	PK
	H	17475.0	22.1	25.9	48.0	54(Note3)	-6.0	PK
	V	11650.0	31.1	23.2	54.3	74	-19.7	PK
	V	11651.1	19.5	23.3	42.8	54	-11.2	AV
	V	17475.0	22.9	25.9	48.8	54(Note3)	-5.2	PK

Note: 1. Measure Level = Reading Level + Factor.

2. The test frequency range, 9kHz~30MHz, 18GHz~25GHz, both of the worst case are at least 6dB below the limits, therefore no data appear in the report.

3. This limit applies for using average detector, if the test result on peak is lower than average limit, then average measurement needn't be performed.

## Mode3: Transmit by 802.11n(40MHz)

CH	Antenna	Frequency (MHz)	Reading Level (dBuV/m)	Factor (dB)	Measure Level (dBuV/m)	Limit (dBuV/m)	Margin (dB)	Detector
38	H	10380.0	44.5	3.9	48.4	54(Note3)	-5.6	PK
	H	15570.0	37.1	14.0	51.1	54(Note3)	-2.9	PK
	V	10380.0	44.5	3.9	48.4	54(Note3)	-5.6	PK
	V	15570.0	37.1	14.0	51.1	54(Note3)	-2.9	PK
46	H	10460.0	44.9	3.0	47.9	54(Note3)	-6.1	PK
	H	15690.0	40.3	10.3	50.6	54(Note3)	-3.4	PK
	V	10460.0	44.9	3.0	47.9	54(Note3)	-6.1	PK
	V	15690.0	40.3	10.3	50.6	54(Note3)	-3.4	PK
54	H	10540.0	44.0	3.5	47.5	54(Note3)	-6.5	PK
	H	15810.0	36.1	14.1	50.2	54(Note3)	-3.8	PK
	V	10540.0	44.0	3.5	47.5	54(Note3)	-6.5	PK
	V	15810.0	36.1	14.1	50.2	54(Note3)	-3.8	PK
62	H	10620.0	44.0	3.1	47.1	54(Note3)	-6.9	PK
	H	15930.0	33.7	14.2	47.9	54(Note3)	-6.1	PK
	V	10620.0	44.0	3.1	47.1	54(Note3)	-6.9	PK
	V	15930.0	33.7	14.2	47.9	54(Note3)	-6.1	PK
102	H	11020.0	44.5	3.4	47.9	54(Note3)	-6.1	PK
	H	16530.0	39.5	12.1	51.6	54(Note3)	-2.4	PK
	V	11020.0	44.5	3.4	47.9	54(Note3)	-6.1	PK
	V	16530.0	39.5	12.1	51.6	54(Note3)	-2.4	PK
110	H	11100.0	43.1	5.1	48.2	54(Note3)	-5.8	PK
	H	16650.0	38.1	15.0	53.1	54(Note3)	-0.9	PK
	V	11100.0	43.1	5.1	48.2	54(Note3)	-5.8	PK
	V	16650.0	38.1	15.0	53.1	54(Note3)	-0.9	PK
134	H	11340.0	44.2	5.9	50.1	54(Note3)	-3.9	PK
	H	17010.0	39.1	13.9	53.0	54(Note3)	-1.0	PK
	V	11340.0	44.2	5.9	50.1	54(Note3)	-3.9	PK
	V	17010.0	39.1	13.9	53.0	54(Note3)	-1.0	PK

151	H	11510.0	43.9	6.9	50.8	54(Note3)	-3.2	PK
	H	17265.0	39.8	11.7	51.5	54(Note3)	-2.5	PK
	V	11510.0	43.9	6.9	50.8	54(Note3)	-3.2	PK
	V	17265.0	39.8	11.7	51.5	54(Note3)	-2.5	PK
159	H	11590.0	44.8	6.5	51.3	54(Note3)	-2.7	PK
	H	17385.0	38.8	13.3	52.1	54(Note3)	-1.9	PK
	V	11590.0	44.8	6.5	51.3	54(Note3)	-2.7	PK
	V	17385.0	38.8	13.3	52.1	54(Note3)	-1.9	PK

Note: 1. Measure Level = Reading Level + Factor.

2. The test frequency range, 9kHz~30MHz, 18GHz~25GHz, both of the worst case are at least 6dB below the limits, therefore no data appear in the report.
3. This limit applies for using average detector, if the test result on peak is lower than average limit, then average measurement needn't be performed.

**The worst case of Radiated Emission below 1GHz:**

Engineer: Scott	
Site: AC2	Time: 2015/07/31 - 09:57
Limit: FCC_Part15.209_RE(3m)_ClassB	Margin: 0
Probe: AC2_10M(30-1000M)20150408	Polarity: Horizontal
EUT: AB-R1	Power: AC 16V
Note: Mode 1	

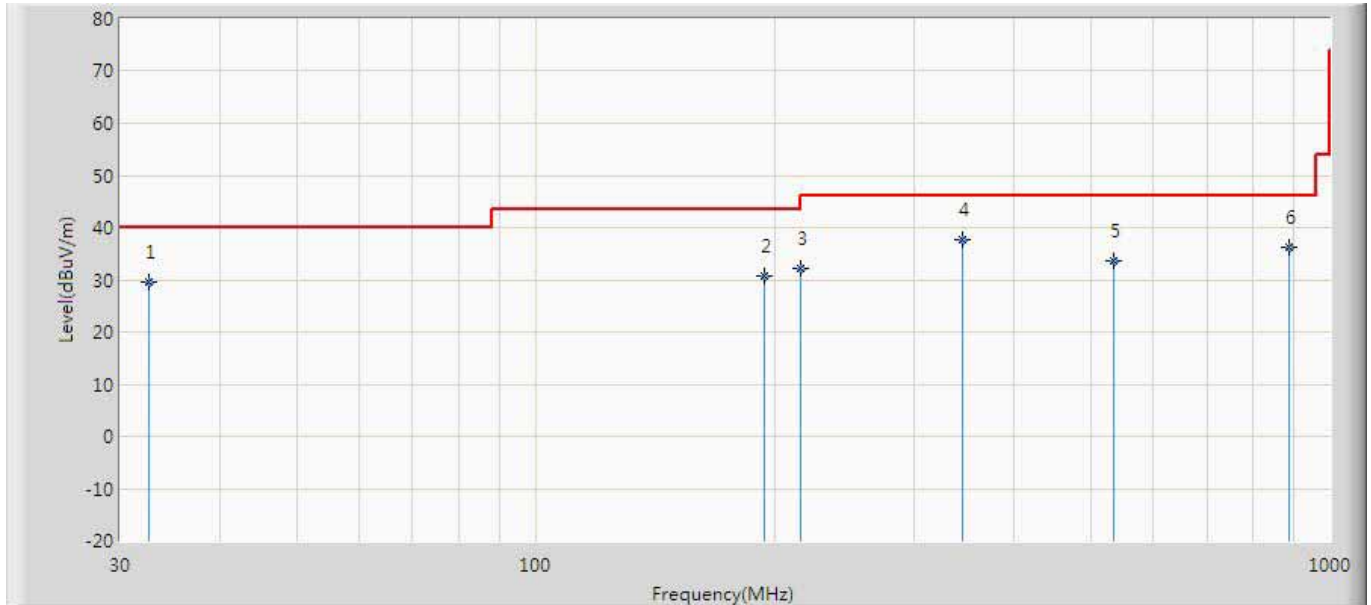

No	Mark	Frequency (MHz)	Measure Level (dBuV/m)	Reading Level (dBuV)	Over Limit (dB)	Limit (dBuV/m)	Factor (dB)	Type
1		32.545	29.489	2.300	-10.511	40.000	27.189	QP
2		194.352	30.687	13.200	-12.813	43.500	17.487	QP
3		215.625	32.169	15.100	-11.331	43.500	17.069	QP
4	*	345.124	37.789	15.800	-8.211	46.000	21.989	QP
5		533.241	33.674	5.600	-12.326	46.000	28.074	QP
6		887.968	36.362	4.200	-9.638	46.000	32.162	QP



Engineer: Scott	
Site: AC2	Time: 2015/07/31 - 09:57
Limit: FCC_Part15.209_RE(3m)_ClassB	Margin: 0
Probe: AC2_10M(30-1000M)20150408	Polarity: Vertical
EUT: AB-R1	Power: AC 16V
Note: Mode 1	

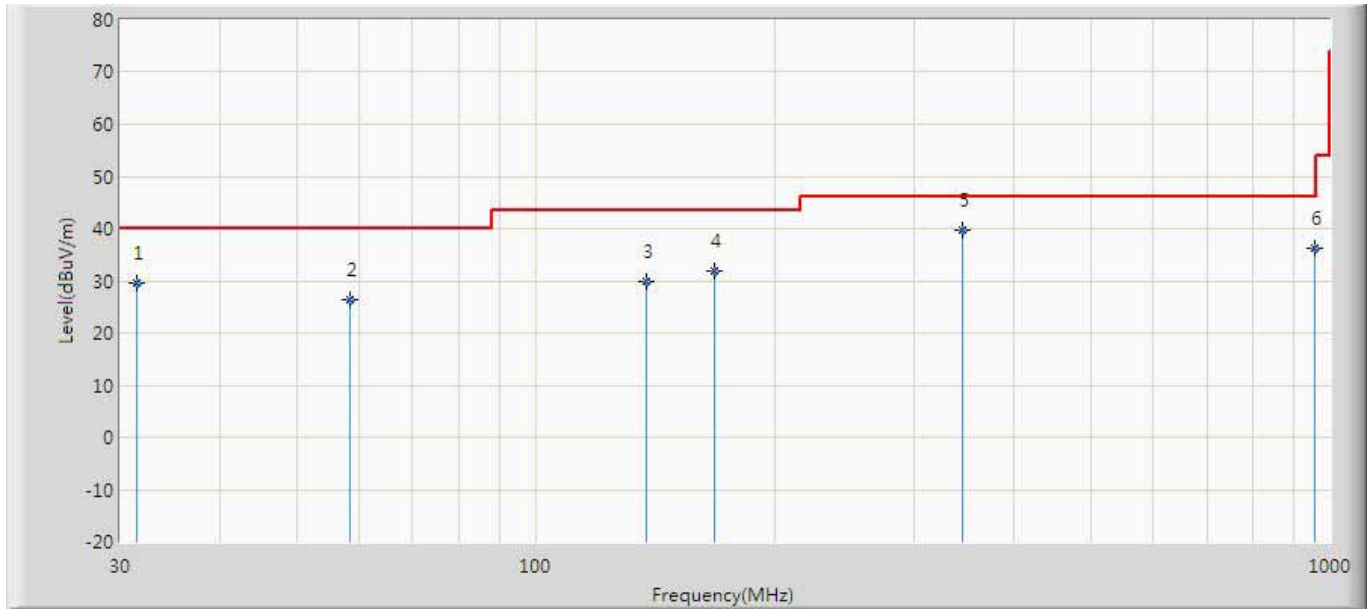

No	Mark	Frequency (MHz)	Measure Level (dBuV/m)	Reading Level (dBuV)	Over Limit (dB)	Limit (dBuV/m)	Factor (dB)	Type
1		31.425	29.564	5.900	-10.436	40.000	23.664	QP
2		58.285	26.463	9.800	-13.537	40.000	16.663	QP
3		137.865	29.857	11.100	-13.643	43.500	18.757	QP
4		168.325	31.795	12.600	-11.705	43.500	19.195	QP
5	*	345.236	39.815	15.800	-6.185	46.000	24.015	QP
6		956.758	36.114	3.200	-9.886	46.000	32.914	QP

## 5. Occupied Bandwidth

### 5.1. Test Equipment

Occupied Bandwidth / TR-8

Instrument	Manufacturer	Type No.	Serial No.	Cal. Due Date
Spectrum Analyzer	Agilent	N9010A	MY48030494	2016.03.10
Temperature/Humidity Meter	zhicheng	ZC1-2	TR8-TH	2016.04.09

Note: All equipments are calibrated with traceable calibrations. Each calibration is traceable to the national or international standards.

### 5.2. Test Setup

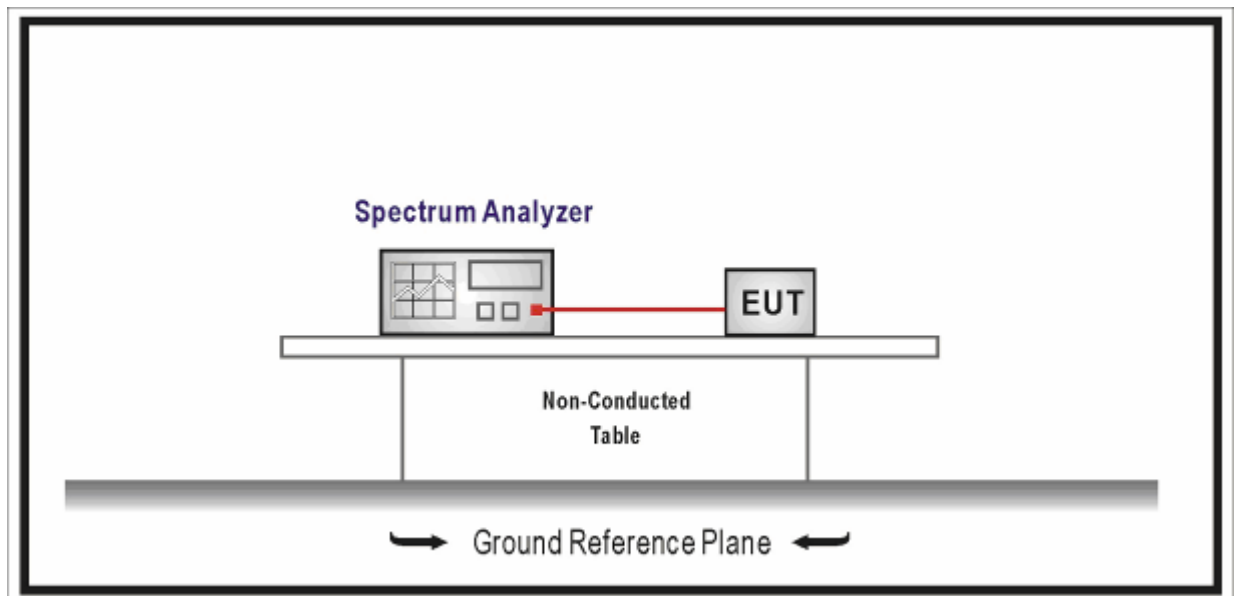

### 5.3. Limit

N/A

## 5.4. Test Procedure

According to ANSI C63.4:2014& ANSI C63.10:2013&789033 D02 General UNII Test Procedures New Rules v01& FCC CFR Title 47 Part 15 Subpart E: 2014& Industry Canada RSS-Gen Issue 4 Industry Canada RSS-247 Issue 1

### Emission Bandwidth

- a) Set RBW = approximately 1% of the emission bandwidth.
- b) Set the VBW > RBW.
- c) Detector = Peak.
- d) Trace mode = max hold.
- e) Measure the maximum width of the emission that is 26 dB down from the maximum of the emission. Compare this with the RBW setting of the analyzer. Readjust RBW and repeat measurement as needed until the RBW/EBW ratio is approximately 1%.

### 99% Occupied Bandwidth

- a) The instrument center frequency is set to the nominal EUT channel center frequency. The frequency span for the spectrum analyzer shall be between 1.5 times and 5.0 times the OBW.
- b) The nominal IF filter bandwidth (3 dB RBW) shall be in the range of 1% to 5% of the OBW, and VBW shall be approximately three times the RBW, unless otherwise specified by the applicable requirement.
- c) Set the reference level of the instrument as required, keeping the signal from exceeding the maximum input mixer level for linear operation. In general, the peak of the spectral envelope shall be more than  $[10 \log (OBW/RBW)]$  below the reference level. Specific guidance is given in 4.1.5.2.
- d) Step a) through step c) might require iteration to adjust within the specified range.
- e) Video averaging is not permitted. Where practical, a sample detection and single sweep mode shall be used. Otherwise, peak detection and max hold mode (until the trace stabilizes) shall be used.
- f) Use the 99% power bandwidth function of the instrument (if available) and report the measured bandwidth.
- g) If the instrument does not have a 99% power bandwidth function, then the trace data points are recovered and directly summed in linear power terms. The recovered amplitude data points, beginning at the lowest frequency, are placed in a running sum until 0.5% of the total is reached; that frequency is recorded as the lower frequency. The process is repeated until 99.5% of the total is reached; that frequency is recorded as the upper frequency. The 99% power bandwidth is the difference between these two frequencies.
- h) The occupied bandwidth shall be reported by providing plot(s) of the measuring instrument display; the plot axes and the scale units per division shall be clearly labeled. Tabular data may be reported in addition to the plot(s).

## 5.5. Uncertainty

The measurement uncertainty is defined as  $\pm 1$  kHz

**5.6. Test Result**

Product	:	AB-R1
Test Item	:	Occupied Bandwidth
Test Site	:	TR-8
Test Mode	:	Mode 1: Transmit by 802.11a

Channel No.	Frequency (MHz)	99% Occupied Bandwidth (MHz)	26dB Occupied Bandwidth (MHz)
36	5180	16.405	18.78
44	5200	16.424	18.92
48	5240	16.401	18.88
52	5260	16.411	18.75
60	5300	16.400	18.91
64	5320	16.426	18.80
100	5500	16.396	18.65
120	5600	16.429	18.85
140	5700	16.426	18.93
149	5745	16.465	18.88
157	5785	16.391	18.84
165	5825	16.463	19.01

**Channel 36 (5180MHz)**



### Channel 44 (5220MHz)



### Channel 48 (5240MHz)

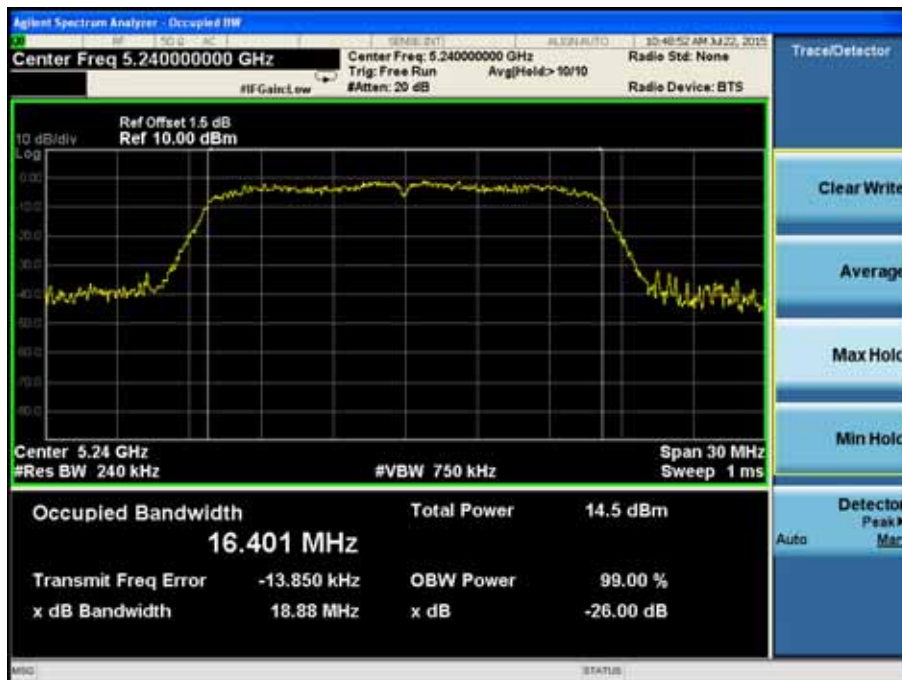

### Channel 52 (5260MHz)

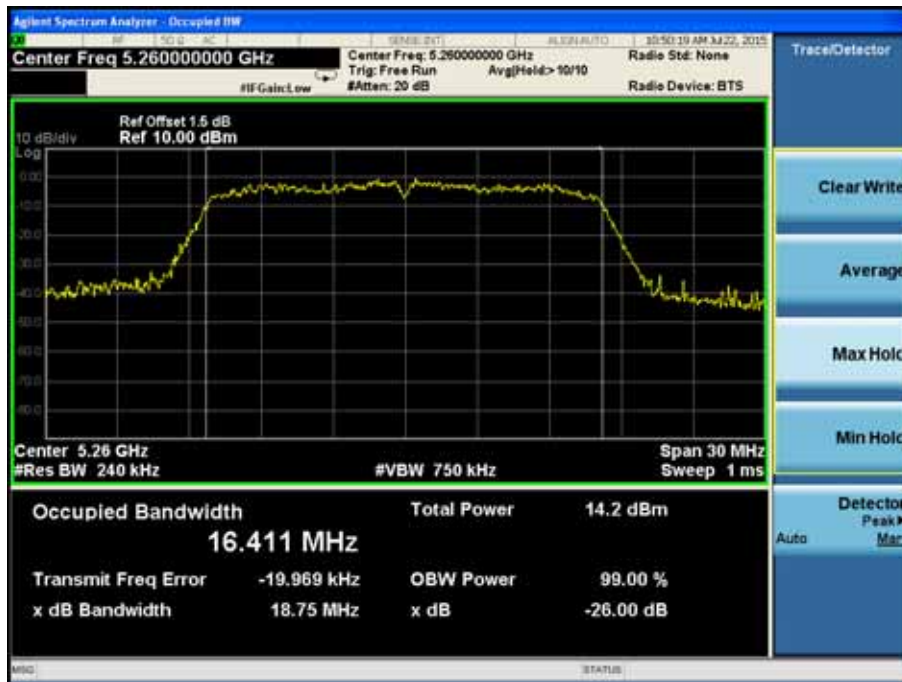

### Channel 60 (5300MHz)





### Channel 64 (5320MHz)



### Channel 100 (5500MHz)





### Channel 120 (5600MHz)

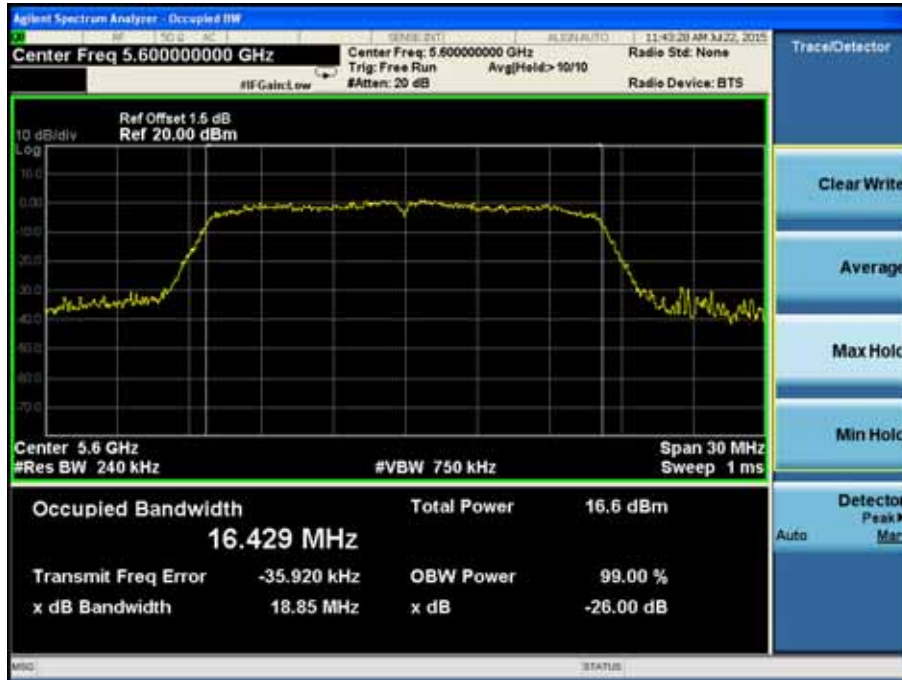

### Channel 140 (5700MHz)

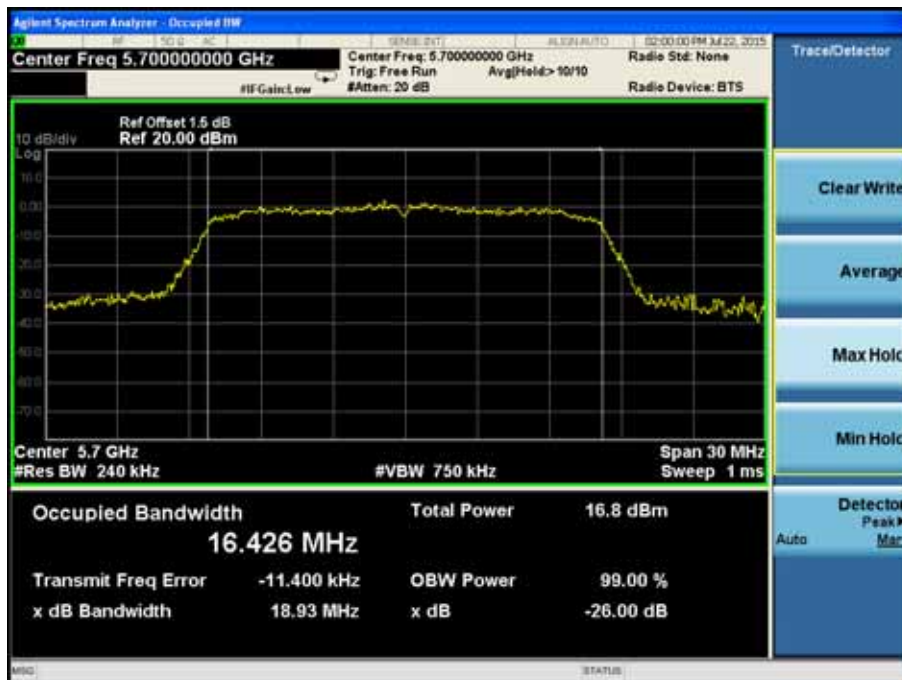

### Channel 149 (5745MHz)

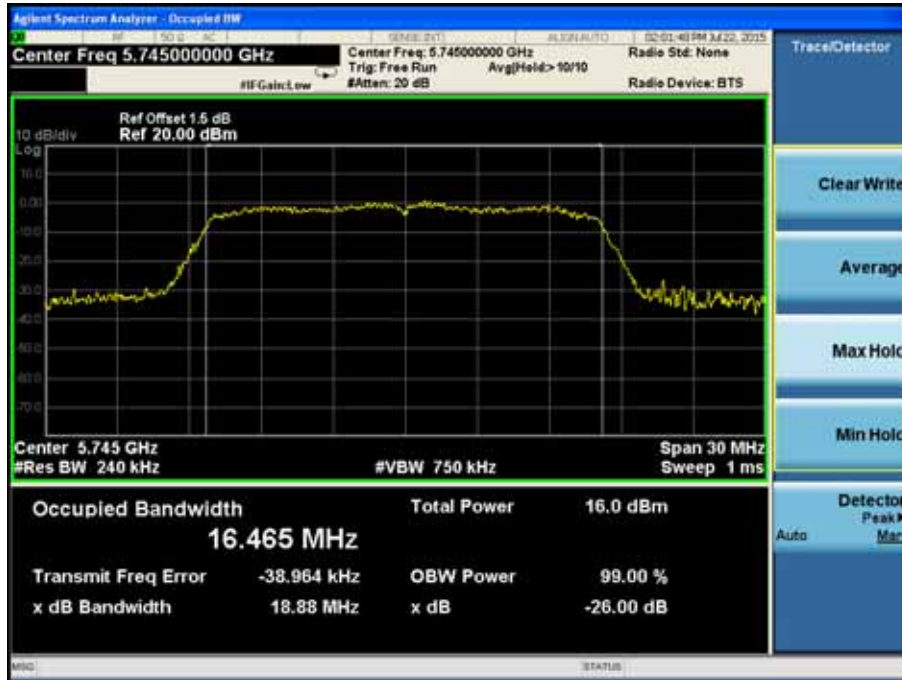

### Channel 157(5785MHz)

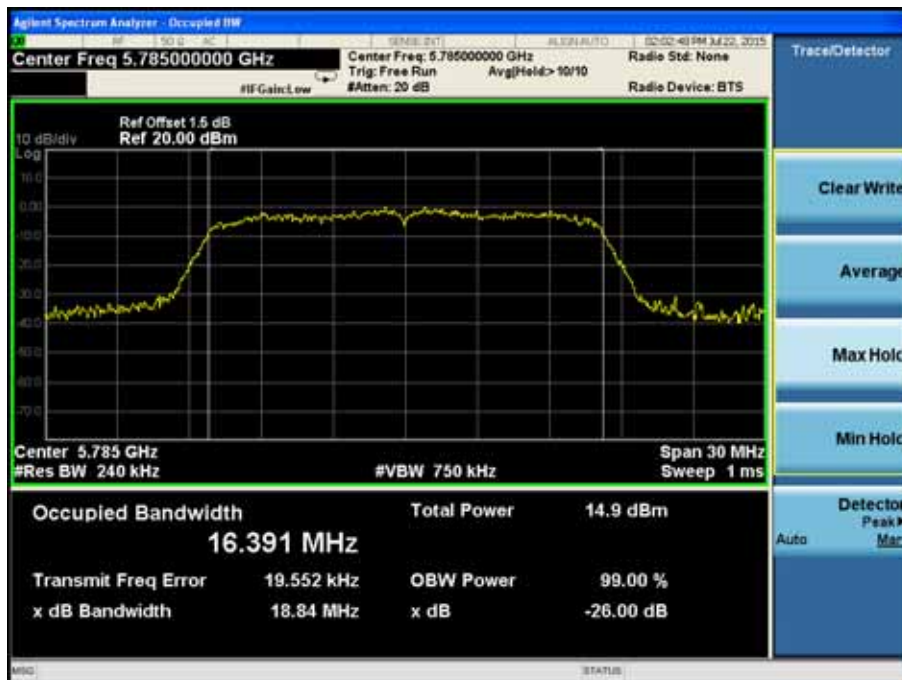

**Channel 165 (5825MHz)**

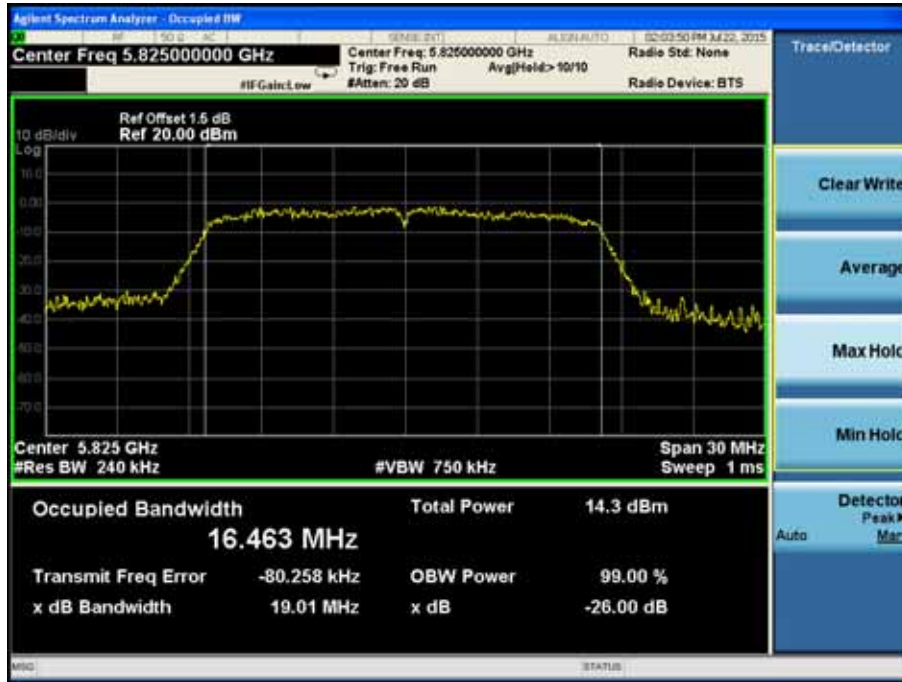

Product	: AB-R1
Test Item	: Occupied Bandwidth
Test Site	: TR-8
Test Mode	: Mode 2: Transmit by 802.11n(20MHz)

Channel No.	Frequency (MHz)	99% Occupied Bandwidth (MHz)	26dB Occupied Bandwidth (MHz)
36	5180	17.480	19.15
44	5200	17.461	19.16
48	5240	17.494	19.05
52	5260	17.506	19.36
60	5300	17.476	19.15
64	5320	17.499	19.06
100	5500	17.514	19.13
120	5600	17.479	19.37
140	5700	17.472	19.06
149	5745	17.506	19.18
157	5785	17.470	19.17
165	5825	17.501	19.17

**Channel 36 (5180MHz)**



### Channel 44 (5220MHz)

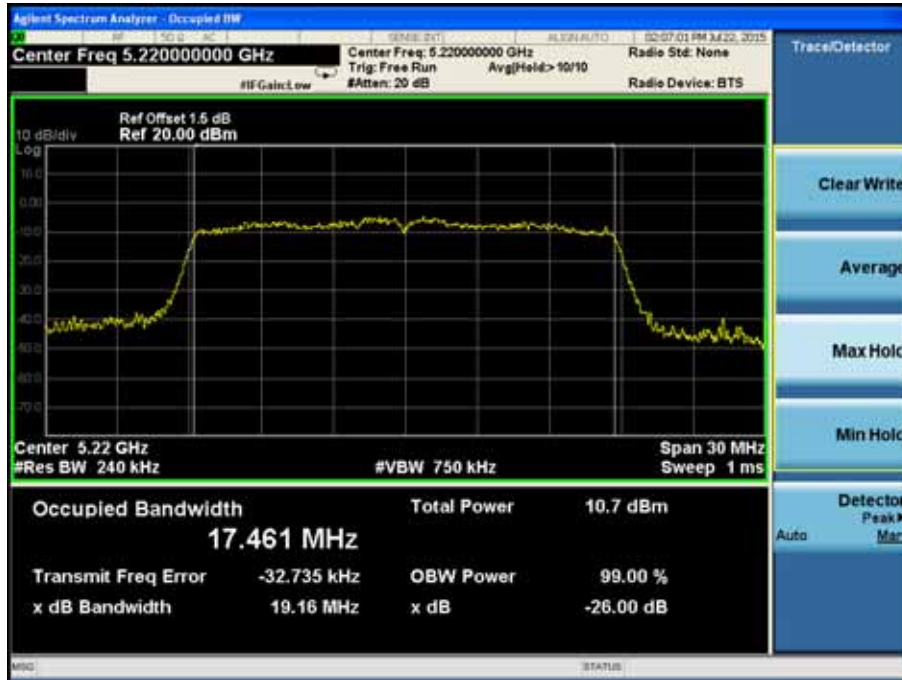

### Channel 48 (5240MHz)





### Channel 52 (5260MHz)

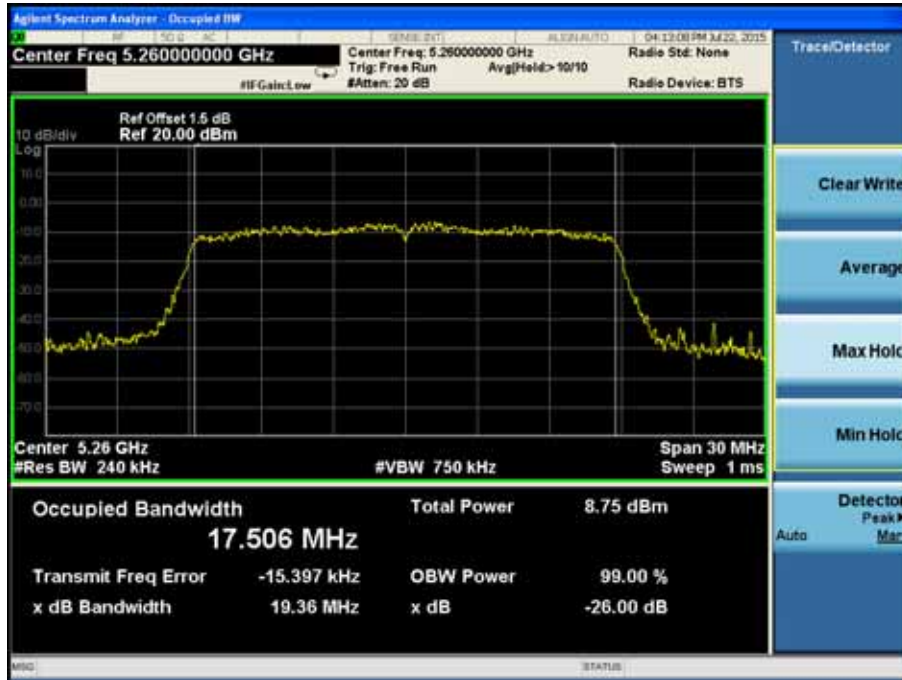

### Channel 60 (5300MHz)

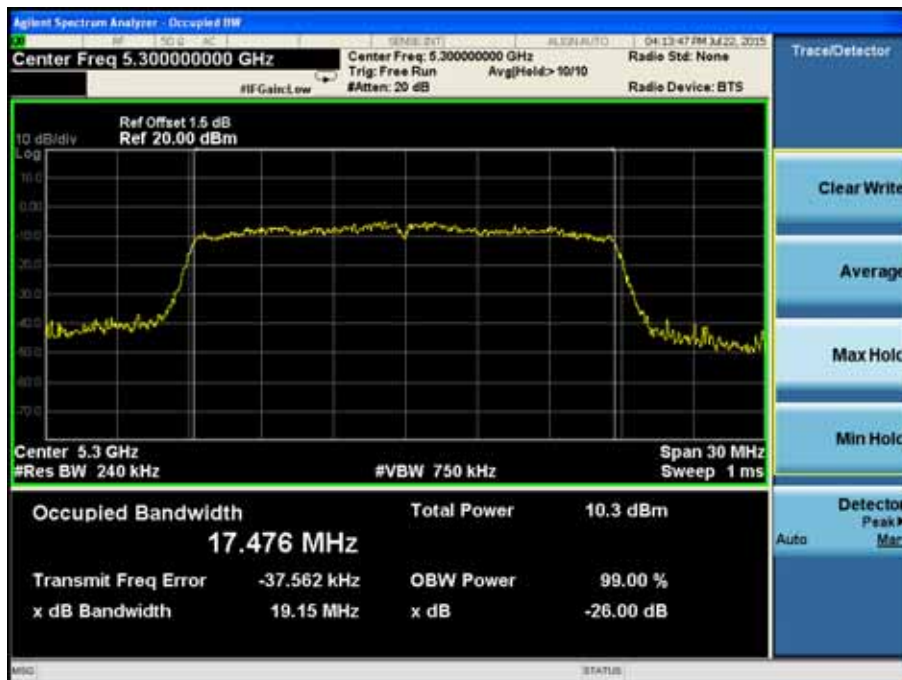

### Channel 64 (5320MHz)

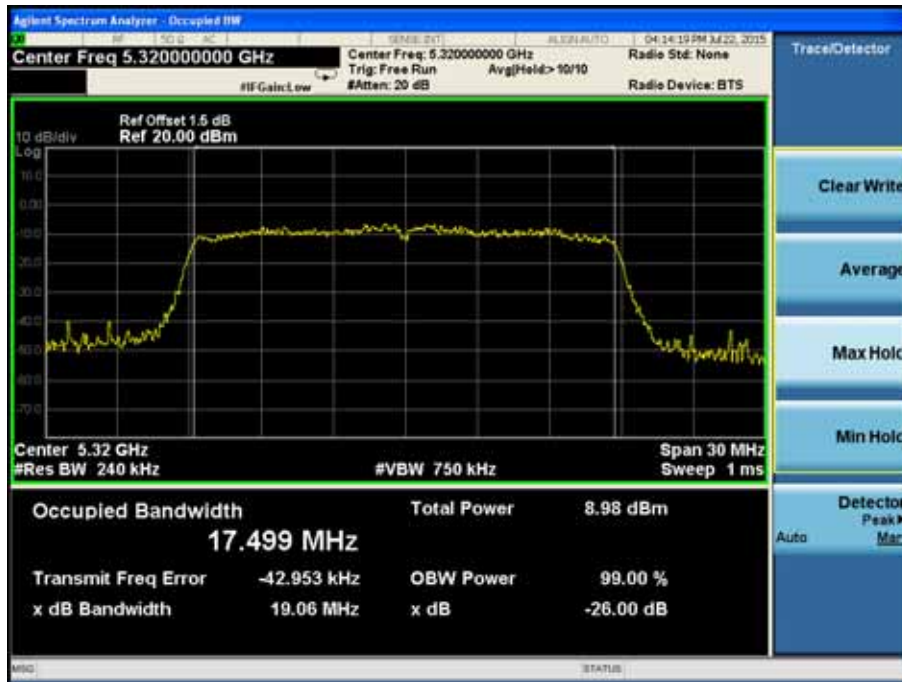

### Channel 100 (5500MHz)

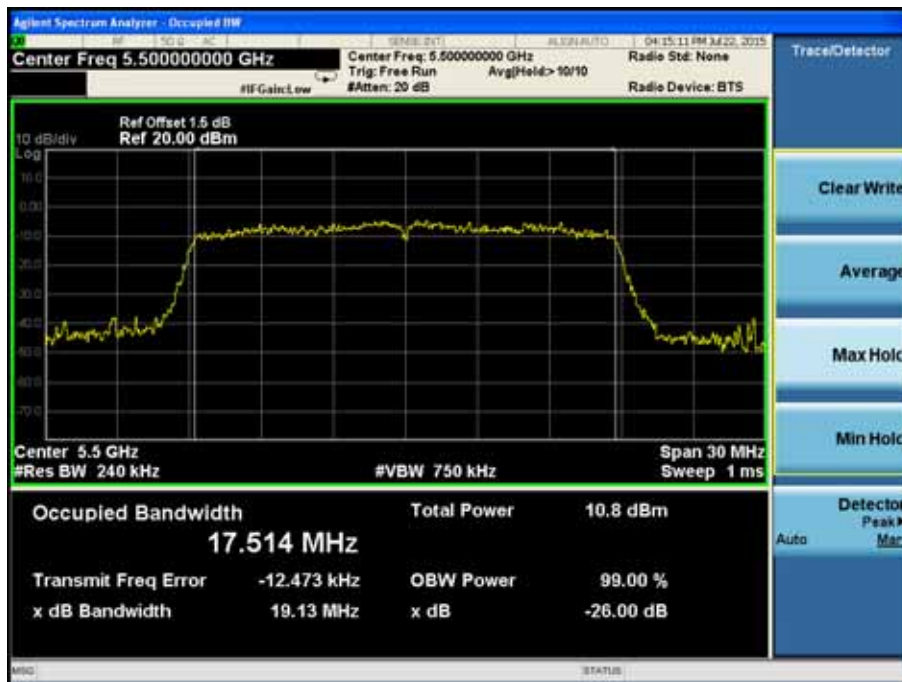

### Channel 120 (5600MHz)

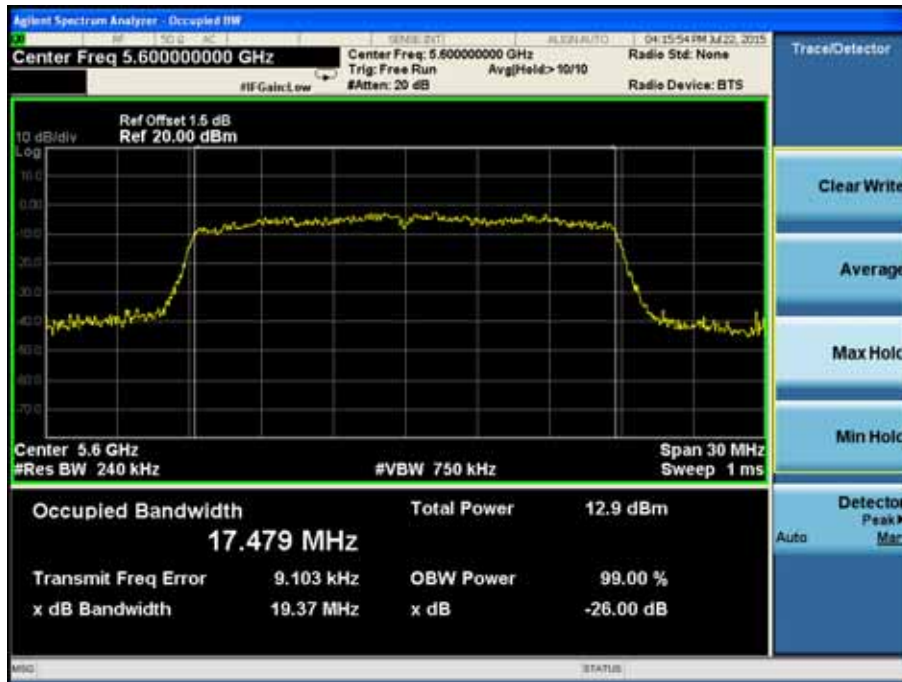

### Channel 140 (5700MHz)

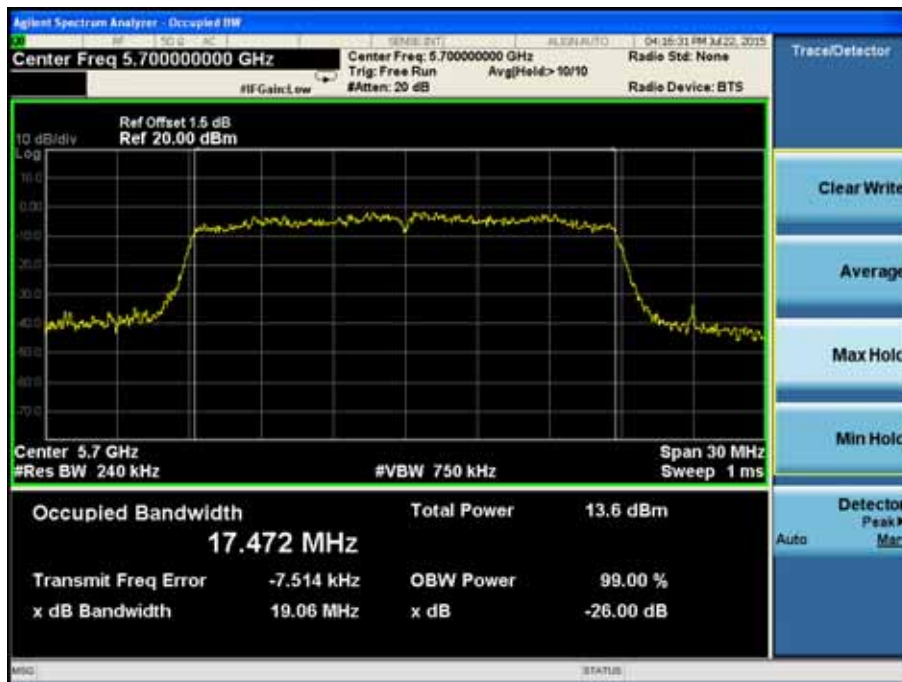



### Channel 149 (5745MHz)

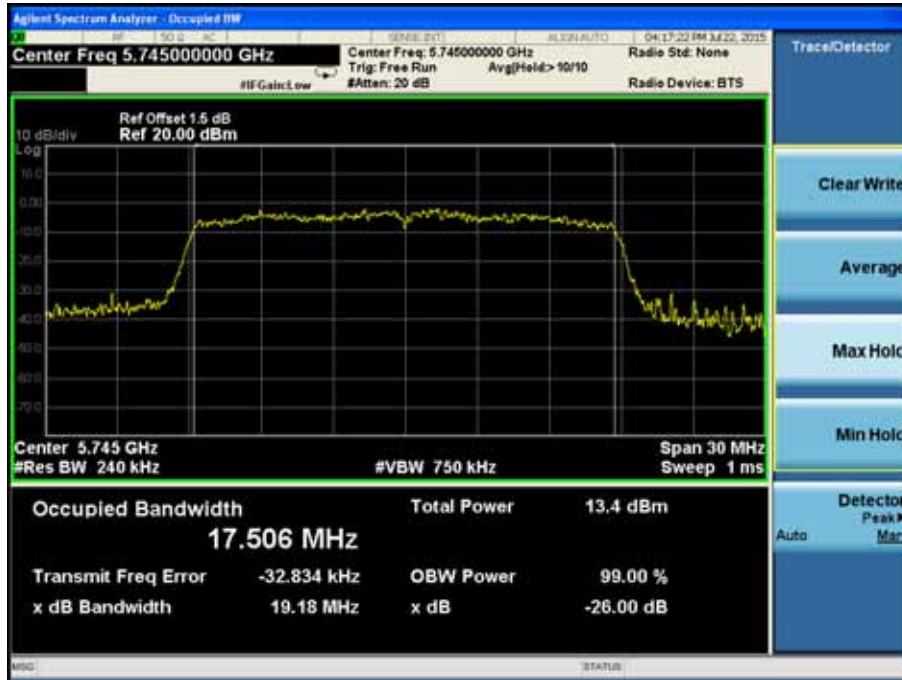

### Channel 157(5785MHz)

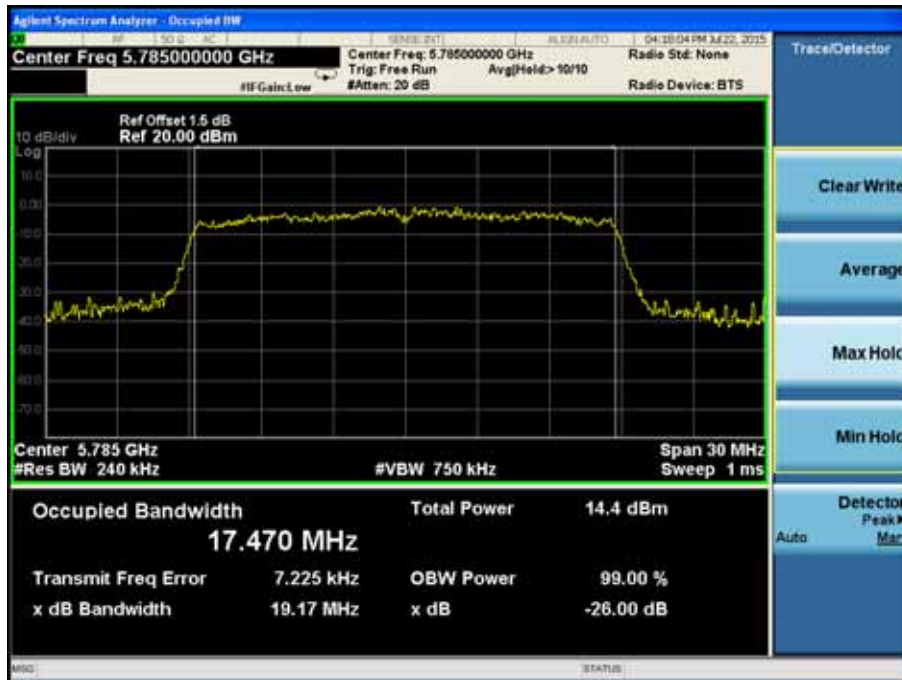

**Channel 165 (5825MHz)**

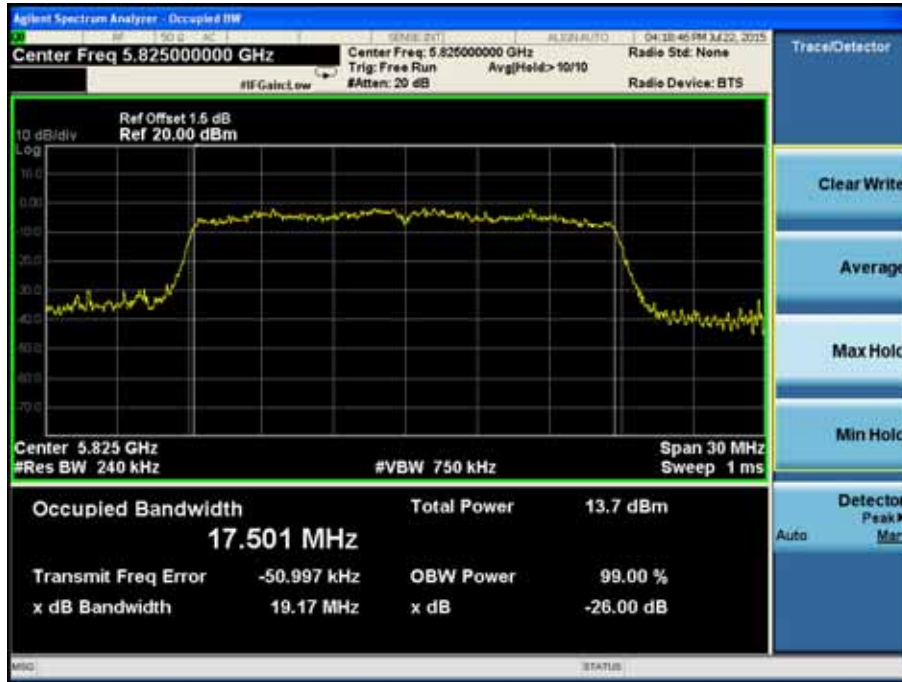

Product	: AB-R1
Test Item	: Occupied Bandwidth
Test Site	: TR-8
Test Mode	: Mode 3: Transmit by 802.11n(40MHz)

Channel No.	Frequency (MHz)	99% Occupied Bandwidth (MHz)	26dB Occupied Bandwidth (MHz)
38	5190	36.095	39.56
46	5230	36.067	39.13
54	5270	36.020	39.57
62	5310	36.029	39.18
102	5510	36.043	39.22
132	5670	36.998	39.74
151	5755	36.064	39.58
159	5795	36.342	39.68

**Channel 38 (5190MHz)**



### Channel 42 (5230MHz)



### Channel 54 (5270MHz)



### Channel 62 (5310MHz)



### Channel 102 (5510MHz)

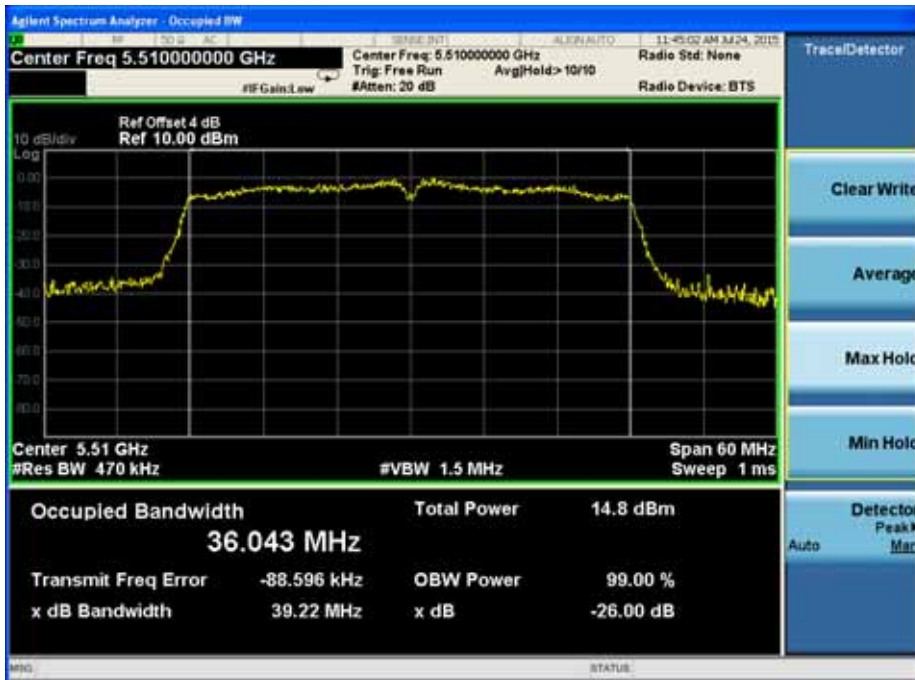



**Channel 110 (5550MHz)**

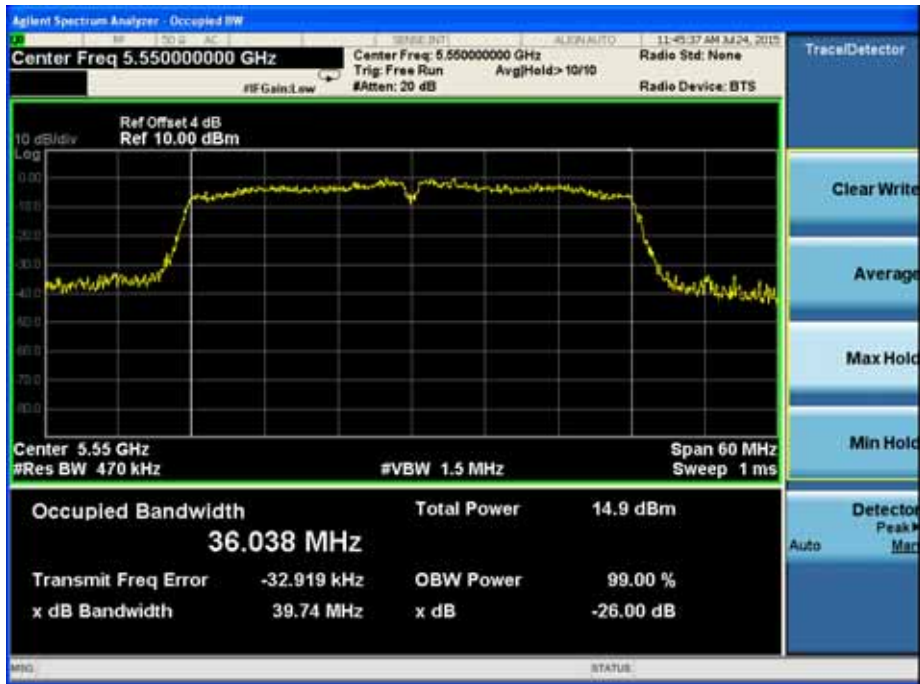

**Channel 134 (5670MHz)**



### Channel 151 (5755MHz)



### Channel 159(5795MHz)



## 6. 6dB Occupied Bandwidth

### 6.1. Test Equipment

Occupied Bandwidth / TR-8

Instrument	Manufacturer	Type No.	Serial No.	Cal. Date
Spectrum Analyzer	Agilent	N9010A	MY48030494	2016.03.10
Temperature/Humidity Meter	zhicheng	ZC1-2	TR8-TH	2016.04.09

Note: All equipments are calibrated with traceable calibrations. Each calibration is traceable to the national or international standards.

### 6.2. Test Setup

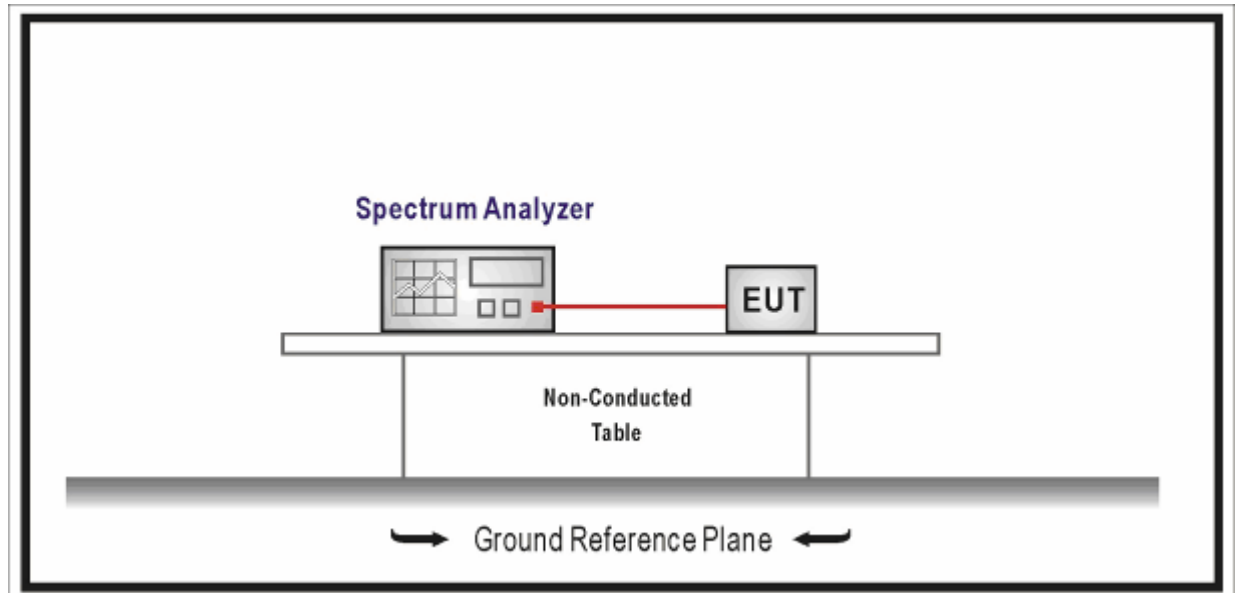

### 6.3. Limit

For FCC&IC

The minimum 6 dB bandwidth shall be 500 kHz.



## 6.4. Test Procedure

According to ANSI C63.4:2014& ANSI C63.10:2013&789033 D02 General UNII Test Procedures New Rules v01& FCC CFR Title 47 Part 15 Subpart E: 2014& Industry Canada RSS-Gen Issue 4 Industry Canada RSS-247 Issue 1

- a) Set RBW = in the range of 1% to 5% of the OBW.
- b) Set the video bandwidth (VBW)  $\geq 3 \times$  RBW.
- c) Detector = Peak.
- d) Trace mode = max hold.
- e) Sweep = auto couple.
- f) Allow the trace to stabilize.
- g) Use the -6dBm function of the instrument (if available) and report the measured bandwidth.

## 6.5. Uncertainty

The measurement uncertainty is defined as  $\pm 1$  kHz

**6.6. Test Result**

Product	:	AB-R1
Test Item	:	Occupied Bandwidth
Test Site	:	TR-8
Test Mode	:	Mode 1: Transmit by 802.11a

Channel No.	Frequency (MHz)	6dB Occupied Bandwidth (MHz)
149	5745	15.10
157	5785	14.46
165	5825	15.33

**Channel 149 (5745MHz)**

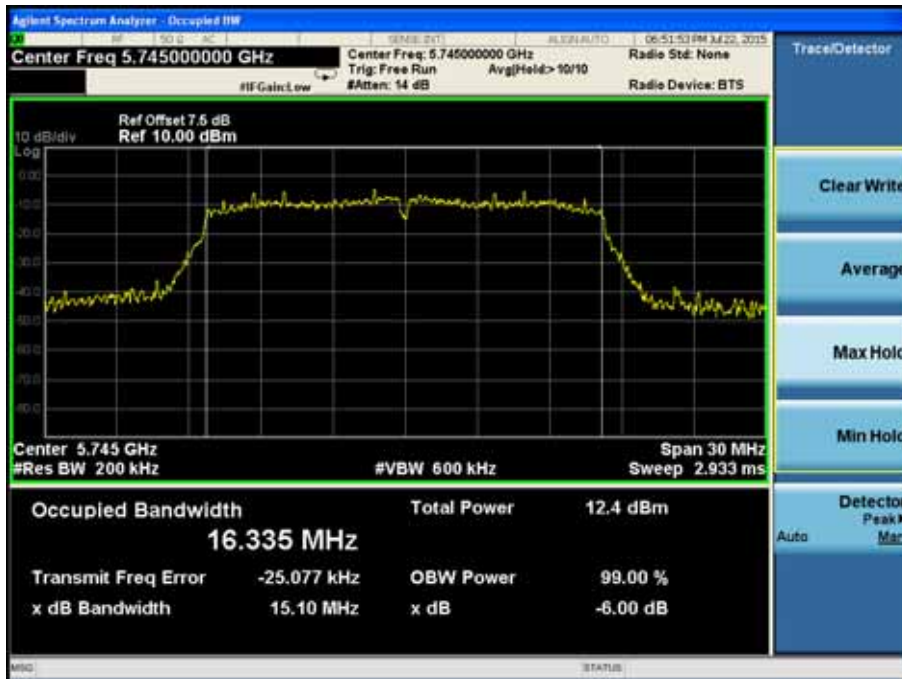

### Channel 157(5785MHz)

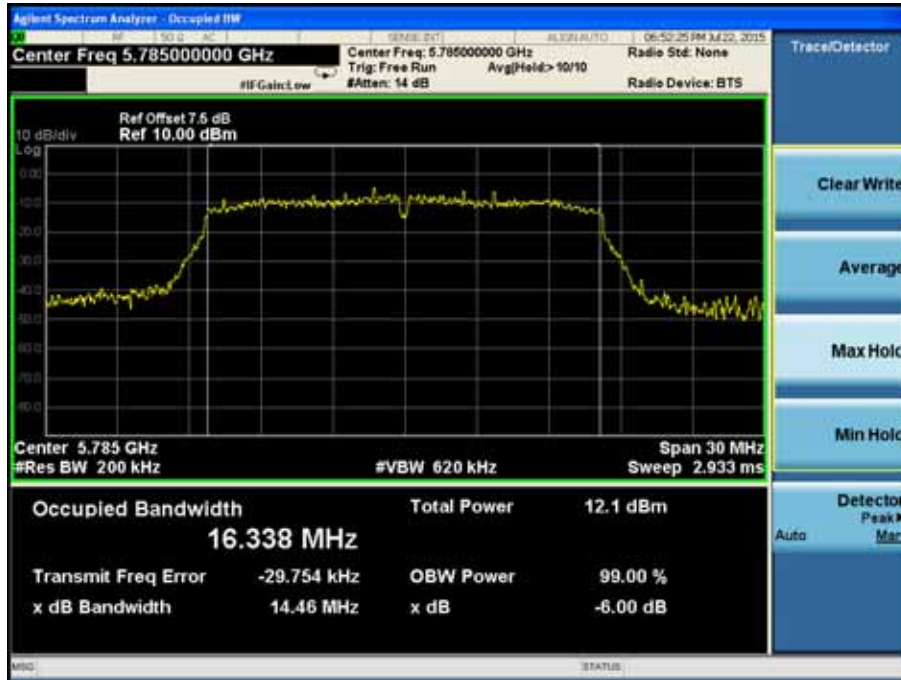

### Channel 165 (5825MHz)



Product	: AB-R1
Test Item	: Occupied Bandwidth
Test Site	: TR-8
Test Mode	: Mode 2: Transmit by 802.11n(20MHz)

Channel No.	Frequency (MHz)	6dB Occupied Bandwidth (MHz)
149	5745	15.08
157	5785	16.68
165	5825	15.66

**Channel 149 (5745MHz)**

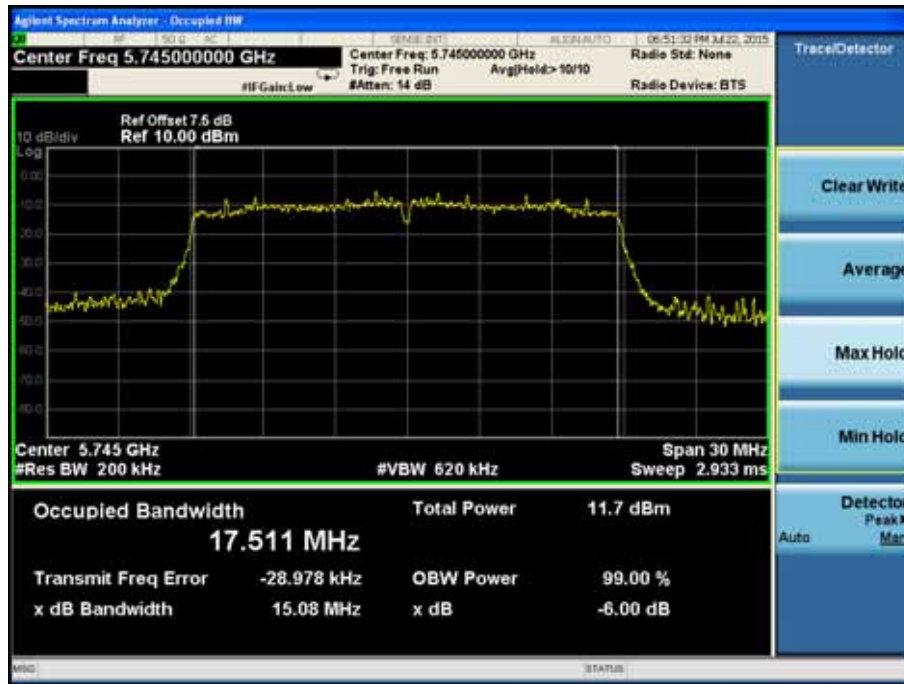

### Channel 157(5785MHz)

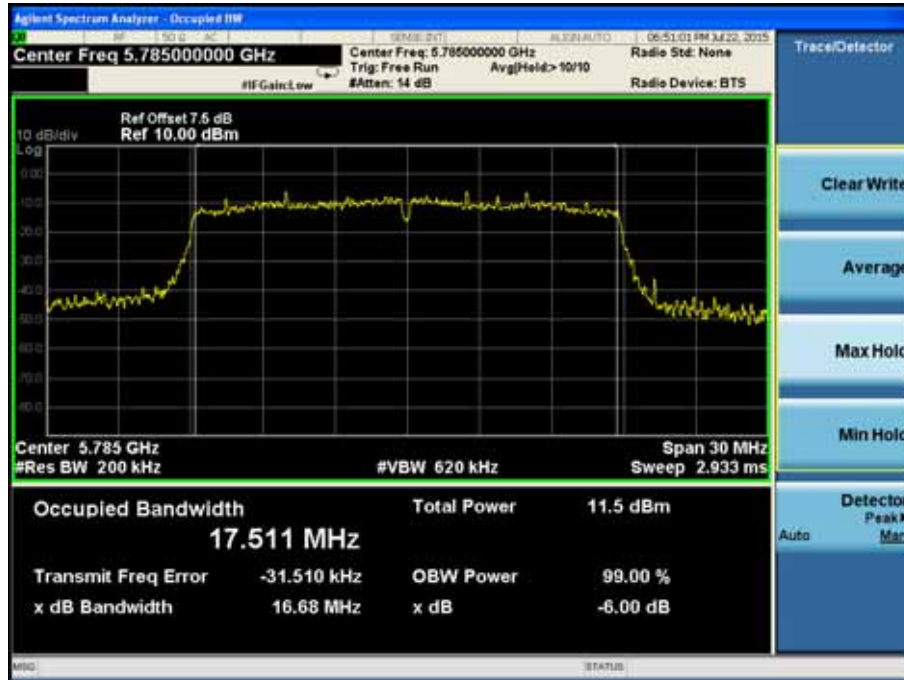

### Channel 165 (5825MHz)

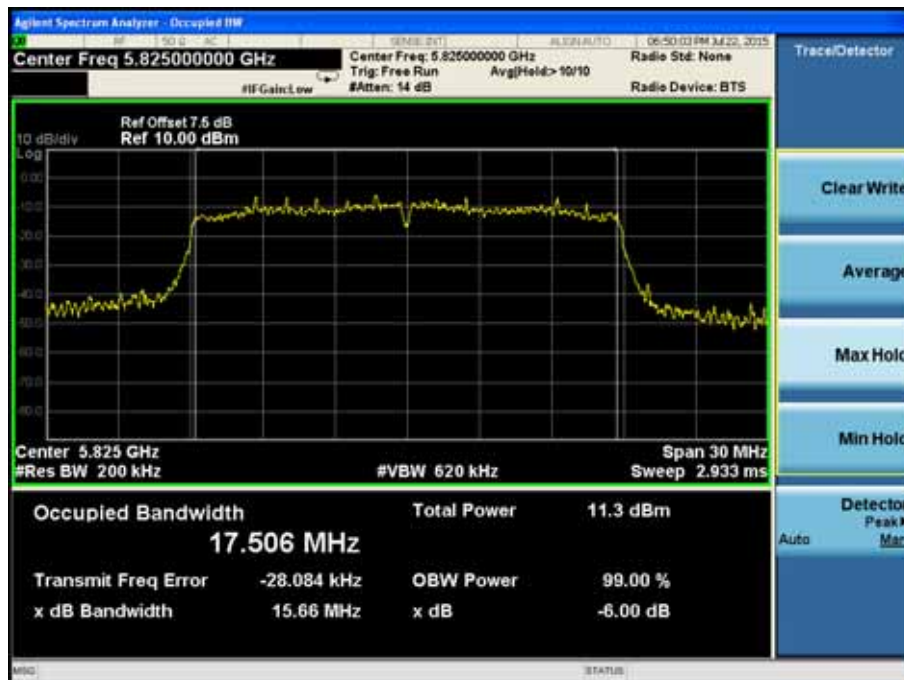

Product	: AB-R1
Test Item	: Occupied Bandwidth
Test Site	: TR-8
Test Mode	: Mode 3: Transmit by 802.11n(40MHz)

Channel No.	Frequency (MHz)	6dB Occupied Bandwidth (MHz)
151	5755	35.11
159	5795	35.15

**Channel 151 (5755MHz)**

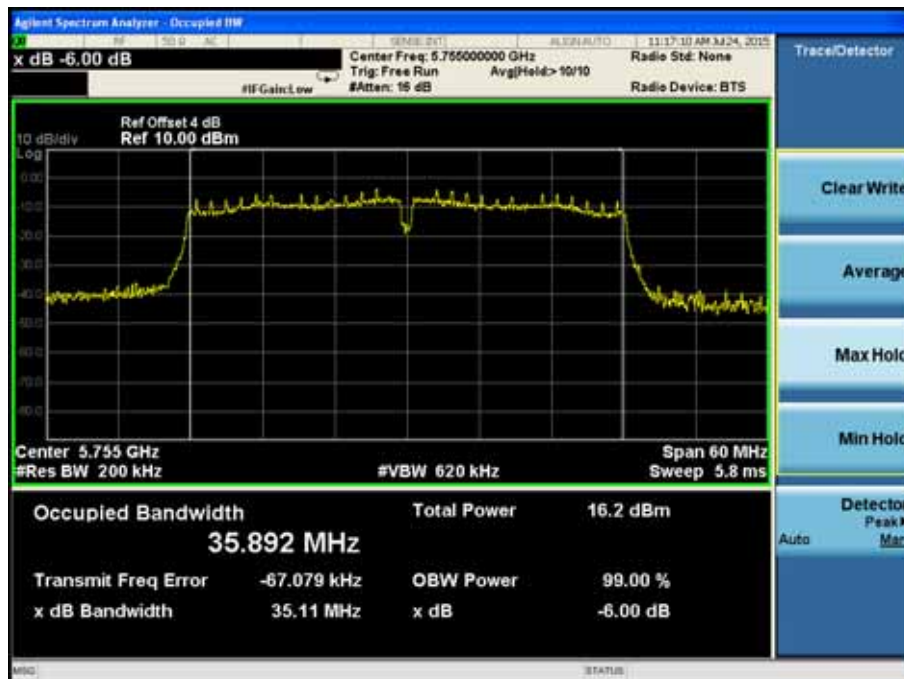

**Channel 159(5795MHz)**

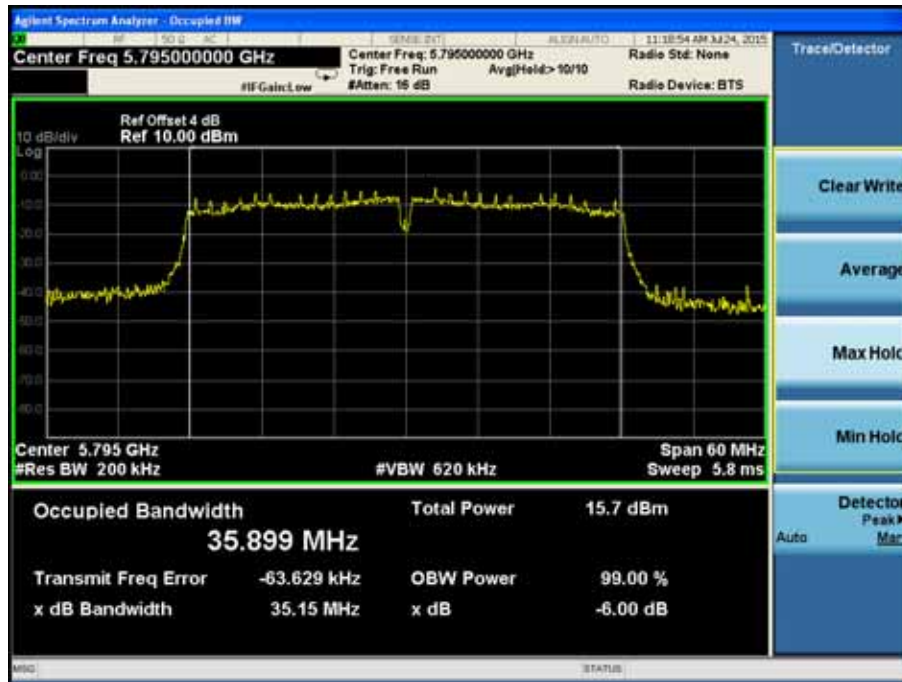



## 7. Power Output

### 7.1. Test Equipment

Power Output / TR-8

Instrument	Manufacturer	Type No.	Serial No.	Cal. Due Date
Spectrum Analyzer	Agilent	N9010A	MY48030494	2016.03.10
Temperature/Humidity Meter	zhicheng	ZC1-2	TR8-TH	2016.04.09

Note: All equipments are calibrated with traceable calibrations. Each calibration is traceable to the national or international standards.

### 7.2. Test Setup

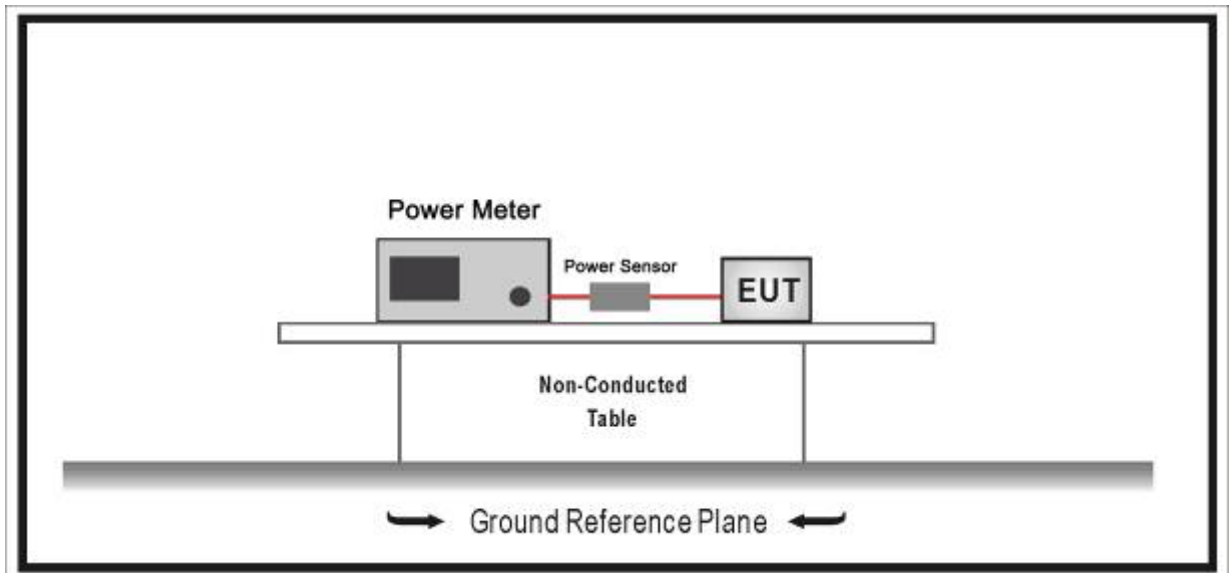

### 7.3. Limit

#### For FCC

- For an outdoor access point operating in the band 5.15-5.25 GHz, the maximum conducted output power over the frequency band of operation shall not exceed 1 W provided the maximum antenna gain does not exceed 6 dBi. In addition, the maximum power spectral density shall not exceed 17 dBm in any 1 megahertz band. If transmitting antennas of directional gain greater than 6 dBi are used, both the maximum conducted output power and the maximum power spectral density shall be reduced by the amount in dB that the directional gain of the antenna exceeds 6 dBi. The maximum e.i.r.p. at any elevation angle above 30 degrees as measured from the horizon must not exceed 125 mW (21 dBm).



- For the 5.25-5.35 GHz and 5.47-5.725 GHz bands, the maximum conducted output power over the frequency bands of operation shall not exceed the lesser of 250 mW or  $11 \text{ dBm} + 10 \log B$ , where B is the 26 dB emission bandwidth in megahertz. In addition, the maximum power spectral density shall not exceed 11 dBm in any 1 megahertz band. If transmitting antennas of directional gain greater than 6 dBi are used, both the maximum conducted output power and the maximum power spectral density shall be reduced by the amount in dB that the directional gain of the antenna exceeds 6 dBi.
- For the band 5.725-5.85 GHz, the maximum conducted output power over the frequency band of operation shall not exceed 1 W. In addition, the maximum power spectral density shall not exceed 30 dBm in any 500-kHz band. If transmitting antennas of directional gain greater than 6 dBi are used, both the maximum conducted output power and the maximum power spectral density shall be reduced by the amount in dB that the directional gain of the antenna exceeds 6 dBi. However, fixed point-to-point U-NII devices operating in this band may employ transmitting antennas with directional gain greater than 6 dBi without any corresponding reduction in transmitter conducted power. Fixed, point-to-point operations exclude the use of point-to-multipoint systems, omnidirectional applications, and multiple collocated transmitters transmitting the same information. The operator of the U-NII device, or if the equipment is professionally installed, the installer, is responsible for ensuring that systems employing high gain directional antennas are used exclusively for fixed, point-to-point operations.

#### For IC

- For the Frequency Band 5150-5250MHz, the maximum e.i.r.p. shall not exceed 200 mW or  $10 + 10 \log 10B$ , dBm, whichever power is less. B is the 99% emission bandwidth in megahertz. The e.i.r.p. spectral density shall not exceed 10 dBm in any 1.0 MHz band..
- For the Frequency Band 5250-5350MHz, the maximum conducted output power shall not exceed 250 mW or  $11 + 10 \log 10B$ , dBm, whichever is less. The power spectral density shall not exceed 11 dBm in any 1.0 MHz band.  
The maximum e.i.r.p. shall not exceed 1.0 W or  $17 + 10 \log 10B$ , dBm, whichever is less. B is the 99% emission bandwidth in megahertz. Note that devices with a maximum e.i.r.p. greater than 500 mW shall implement TPC in order to have the capability to operate at least 6 dB below the maximum permitted e.i.r.p. of 1 W.
- For the Frequency Band 5470-5600, 5650-5725MHz, The maximum conducted output power shall not exceed 250 mW or  $11 + 10 \log 10B$ , dBm, whichever is less. The power spectral density shall not exceed 11 dBm in any 1.0 MHz band.  
The maximum e.i.r.p. shall not exceed 1.0 W or  $17 + 10 \log 10B$ , dBm, whichever is less. B is the 99% emission bandwidth in megahertz. Note that devices with a maximum e.i.r.p.

greater than 500 mW shall implement TPC in order to have the capability to operate at least 6 dB below the maximum permitted e.i.r.p. of 1 W.

- For the Frequency Band 5725-5850MHz, The maximum conducted output power shall not exceed 1 W. The power spectral density shall not exceed 30 dBm in any 500 kHz band. If transmitting antennas of directional gain greater than 6 dBi are used, both the maximum conducted output power and the power spectral density shall be reduced by the amount in dB that the directional gain of the antenna exceeds 6 dBi. However, fixed point-to-point devices operating in this band may employ transmitting antennas with directional gain greater than 6 dBi without any corresponding reduction in transmitter conducted power. Fixed point-to-point operations exclude the use of point-to-multipointFootnote3 systems, omnidirectional applications and multiple collocated transmitters transmitting the same information.

#### **7.4. Test Procedure**

According to ANSI C63.4:2014& ANSI C63.10:2013&789033 D02 General UNII Test Procedures New Rules v01& FCC CFR Title 47 Part 15 Subpart E: 2014& Industry Canada RSS-Gen Issue 4 Industry Canada RSS-247 Issue 1

Use the wideband power meter to test RMS power and record the result.

#### **7.5. Uncertainty**

The measurement uncertainty is defined as  $\pm 1.27$  dB

**7.6. Test Result**

Power output test was verified over all data rates of each mode shown as below, and then choose the maximum power output (blue marker) for final test of each channel.

Power output at various data rates:

Test Mode	Bandwidth	Frequency (MHz)	Channel	Data Rate	Average Power (dBm)
802.11a	20	5180	36	6	8.15
				24	8.07
				54	8.03
802.11n(20MHz)	20	5180	36	MCS0	7.53
				MCS4	7.49
				MCS7	7.43
802.11n(40MHz)	40	5190	38	MCS0	7.44
				MCS4	7.38
				MCS7	7.31

Product	: AB-R1
Test Item	: Power Output
Test Site	: TR-8
Test Mode	: Mode 1: Transmit by 802.11a

Channel No.	Frequency (MHz)	Measurement Power Output (dBm)		Total Power (dBm)	Limit (dBm)
		Ant 1	Ant 2		
36	5180	8.15	N/A	8.15	23
44	5200	8.24	N/A	8.24	23
48	5240	8.56	N/A	8.56	23
52	5260	8.74	N/A	8.74	24
60	5300	9.02	N/A	9.02	24
64	5320	9.22	N/A	9.22	24
100	5500	10.27	N/A	10.27	24
120	5600	10.43	N/A	10.43	24
140	5700	10.44	N/A	10.44	24
149	5745	10.36	N/A	10.36	30
157	5785	10.61	N/A	10.61	30
165	5825	10.32	N/A	10.32	30

Product	: AB-R1
Test Item	: Power Output
Test Site	: TR-8
Test Mode	: Mode 2: Transmit by 802.11n(20MHz)

Channel No.	Frequency (MHz)	Measurement Power Output (dBm)		Total Power (dBm)	Limit (dBm)
		Ant 1	Ant 2		
36	5180	7.53	N/A	7.53	23
44	5200	7.63	N/A	7.63	23
48	5240	7.91	N/A	7.91	23
52	5260	8.10	N/A	8.1	24
60	5300	8.44	N/A	8.44	24
64	5320	8.69	N/A	8.69	24
100	5500	9.14	N/A	9.14	24
120	5600	9.35	N/A	9.35	24
140	5700	9.41	N/A	9.41	24
149	5745	9.36	N/A	9.36	30
157	5785	9.92	N/A	9.92	30
165	5825	9.73	N/A	9.73	30

Product	: AB-R1
Test Item	: Power Output
Test Site	: TR-8
Test Mode	: Mode 4: Transmit by 802.11n(40MHz)

Channel No.	Frequency (MHz)	Measurement Power Output (dBm)		Total Power (dBm)	Limit (dBm)
		Ant 1	Ant 2		
38	5190	7.44	N/A	7.44	23
46	5230	7.59	N/A	7.59	23
54	5270	7.61	N/A	7.61	24
62	5310	8.31	N/A	8.31	24
102	5510	9.02	N/A	9.02	24
110	5550	9.21	N/A	9.21	24
132	5670	9.35	N/A	9.35	30
151	5755	10.11	N/A	10.11	30
159	5795	10.25	N/A	10.25	30

## 8. Peak Power Spectral Density

### 8.1. Test Equipment

Peak Power Spectral Density / TR-8

Instrument	Manufacturer	Type No.	Serial No.	Cal. Due Date
Spectrum Analyzer	Agilent	N9010A	MY48030494	2016.03.10
Temperature/Humidity Meter	zhicheng	ZC1-2	TR8-TH	2016.04.09

Note: All equipments are calibrated with traceable calibrations. Each calibration is traceable to the national or international standards.

### 8.2. Test Setup

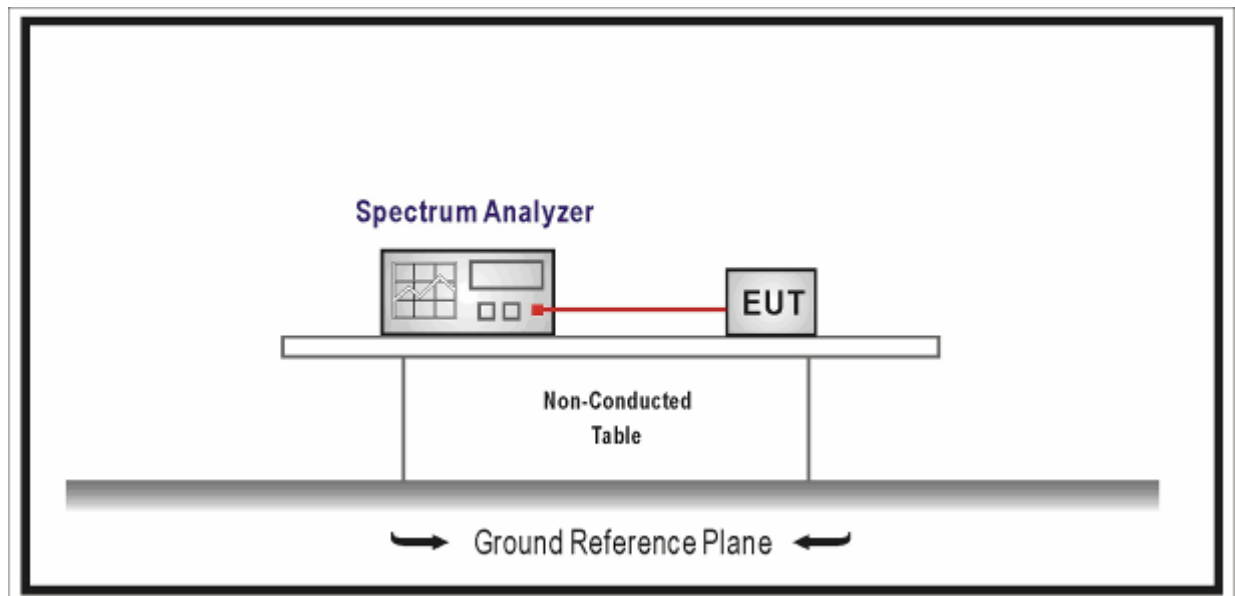

### 8.3. Limit

#### For FCC

- For an outdoor access point operating in the band 5.15-5.25 GHz, the maximum conducted output power over the frequency band of operation shall not exceed 1 W provided the maximum antenna gain does not exceed 6 dBi. In addition, the maximum power spectral density shall not exceed 17 dBm in any 1 megahertz band. If transmitting antennas of directional gain greater than 6 dBi are used, both the maximum conducted output power and the maximum power spectral density shall be reduced by the amount in dB that the directional gain of the antenna exceeds 6 dBi. The maximum e.i.r.p. at any elevation angle above 30 degrees as measured from the horizon must not exceed 125 mW

(21 dBm).

- For the 5.25-5.35 GHz and 5.47-5.725 GHz bands, the maximum conducted output power over the frequency bands of operation shall not exceed the lesser of 250 mW or  $11 \text{ dBm} + 10 \log B$ , where B is the 26 dB emission bandwidth in megahertz. In addition, the maximum power spectral density shall not exceed 11 dBm in any 1 megahertz band. If transmitting antennas of directional gain greater than 6 dBi are used, both the maximum conducted output power and the maximum power spectral density shall be reduced by the amount in dB that the directional gain of the antenna exceeds 6 dBi.
- For the band 5.725-5.85 GHz, the maximum conducted output power over the frequency band of operation shall not exceed 1 W. In addition, the maximum power spectral density shall not exceed 30 dBm in any 500-kHz band. If transmitting antennas of directional gain greater than 6 dBi are used, both the maximum conducted output power and the maximum power spectral density shall be reduced by the amount in dB that the directional gain of the antenna exceeds 6 dBi. However, fixed point-to-point U-NII devices operating in this band may employ transmitting antennas with directional gain greater than 6 dBi without any corresponding reduction in transmitter conducted power. Fixed, point-to-point operations exclude the use of point-to-multipoint systems, omnidirectional applications, and multiple collocated transmitters transmitting the same information. The operator of the U-NII device, or if the equipment is professionally installed, the installer, is responsible for ensuring that systems employing high gain directional antennas are used exclusively for fixed, point-to-point operations.

#### For IC

- For the Frequency Band 5150-5250MHz, the maximum e.i.r.p. shall not exceed 200 mW or  $10 + 10 \log_{10} B$ , dBm, whichever power is less. B is the 99% emission bandwidth in megahertz. The e.i.r.p. spectral density shall not exceed 10 dBm in any 1.0 MHz band..
- For the Frequency Band 5250-5350MHz, the maximum conducted output power shall not exceed 250 mW or  $11 + 10 \log_{10} B$ , dBm, whichever is less. The power spectral density shall not exceed 11 dBm in any 1.0 MHz band.  
The maximum e.i.r.p. shall not exceed 1.0 W or  $17 + 10 \log_{10} B$ , dBm, whichever is less. B is the 99% emission bandwidth in megahertz. Note that devices with a maximum e.i.r.p. greater than 500 mW shall implement TPC in order to have the capability to operate at least 6 dB below the maximum permitted e.i.r.p. of 1 W.
- For the Frequency Band 5470-5600, 5650-5725MHz, The maximum conducted output power shall not exceed 250 mW or  $11 + 10 \log_{10} B$ , dBm, whichever is less. The power spectral density shall not exceed 11 dBm in any 1.0 MHz band.  
The maximum e.i.r.p. shall not exceed 1.0 W or  $17 + 10 \log_{10} B$ , dBm, whichever is less. B



is the 99% emission bandwidth in megahertz. Note that devices with a maximum e.i.r.p. greater than 500 mW shall implement TPC in order to have the capability to operate at least 6 dB below the maximum permitted e.i.r.p. of 1 W.

- For the Frequency Band 5725-5850MHz, The maximum conducted output power shall not exceed 1 W. The power spectral density shall not exceed 30 dBm in any 500 kHz band. If transmitting antennas of directional gain greater than 6 dBi are used, both the maximum conducted output power and the power spectral density shall be reduced by the amount in dB that the directional gain of the antenna exceeds 6 dBi. However, fixed point-to-point devices operating in this band may employ transmitting antennas with directional gain greater than 6 dBi without any corresponding reduction in transmitter conducted power. Fixed point-to-point operations exclude the use of point-to-multipoint<sup>Footnote3</sup> systems, omnidirectional applications and multiple collocated transmitters transmitting the same information.

#### 8.4. Test Procedure

According to ANSI C63.4:2014& ANSI C63.10:2013&789033 D02 General UNII Test Procedures New Rules v01& FCC CFR Title 47 Part 15 Subpart E: 2014& Industry Canada RSS-Gen Issue 4 Industry Canada RSS-247 Issue 1.

Set span to encompass the entire emission bandwidth (EBW) of the signal.

For 5150-5725MHz

- a) Set RBW = 1 MHz.
- b) Set VBW  $\geq$  3 MHz.
- c) Sweep time = auto.
- d) Detector = RMS (i.e., power averaging), if available. Otherwise, use sample detector mode.

For 5725-5875MHz

- e) Set RBW=510KHz
- f) VBW $\geq$ 3RBW
- g) Sweep time=auto
- h) Detector = RMS (i.e., power averaging), if available. Otherwise, use sample detector mode.
- i) Scale the observed power level to an equivalent value in 500 kHz by adjusting (increase) the measured power by a bandwidth correction factor (BWCF) where BWCF =  $10\log(500\text{ kHz}/100\text{ kHz}) = 6.98\text{ dB}$ .

#### 8.5. Uncertainty

The measurement uncertainty is defined as  $\pm 1.27\text{ dB}$

**8.6. Test Result**

Product	:	AB-R1
Test Item	:	Peak Power Spectral Density
Test Site	:	TR-8
Test Mode	:	Mode 1: Transmit by 802.11a (Ant 1)

Channel No.	Frequency (MHz)	Reading Value (dBm/MHz)	Duty Cycle (%)	Total PPSD (dBm/MHz)	Limit (dBm/MHz)
36	5180	-5.087	96.5	-4.932	10
44	5200	-3.706	96.5	-3.551	10
48	5240	-2.343	96.5	-2.188	10
52	5260	-1.699	96.5	-1.544	11
60	5300	-3.066	96.5	-2.911	11
64	5320	-1.980	96.5	-1.825	11
100	5500	-4.264	96.5	-4.109	11
120	5600	-3.894	96.5	-3.739	11
140	5700	-4.141	96.5	-3.986	11

Note: When EUT duty cycle < 98%, the total PSD = Reading Level + 10\*log(1/duty cycle)

Channel No.	Frequency (MHz)	Reading Value (dBm/MHz)	Duty Cycle (%)	Total PPSD (dBm/MHz)	Limit (dBm/MHz)
149	5745	-6.875	96.5	0.260	30
157	5785	-6.867	96.5	0.268	30
165	5825	-6.952	96.5	0.183	30

### Channel 36 (5180MHz)



### Channel 44 (5220MHz)

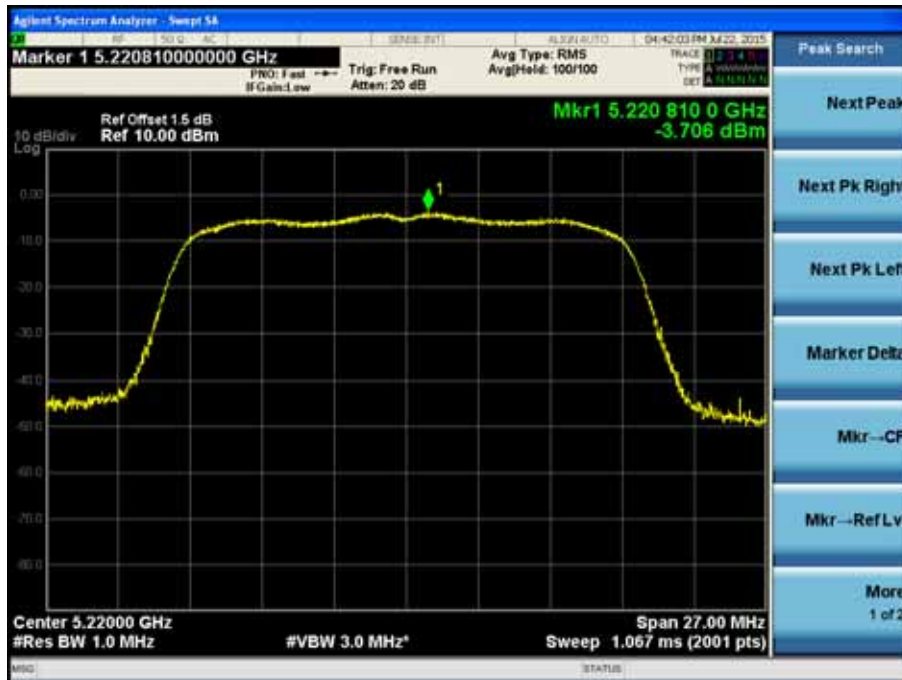

### Channel 48 (5240MHz)



### Channel 52 (5260MHz)



### Channel 60 (5300MHz)



### Channel 64 (5320MHz)



### Channel 100 (5500MHz)



### Channel 120 (5600MHz)





### Channel 140 (5700MHz)

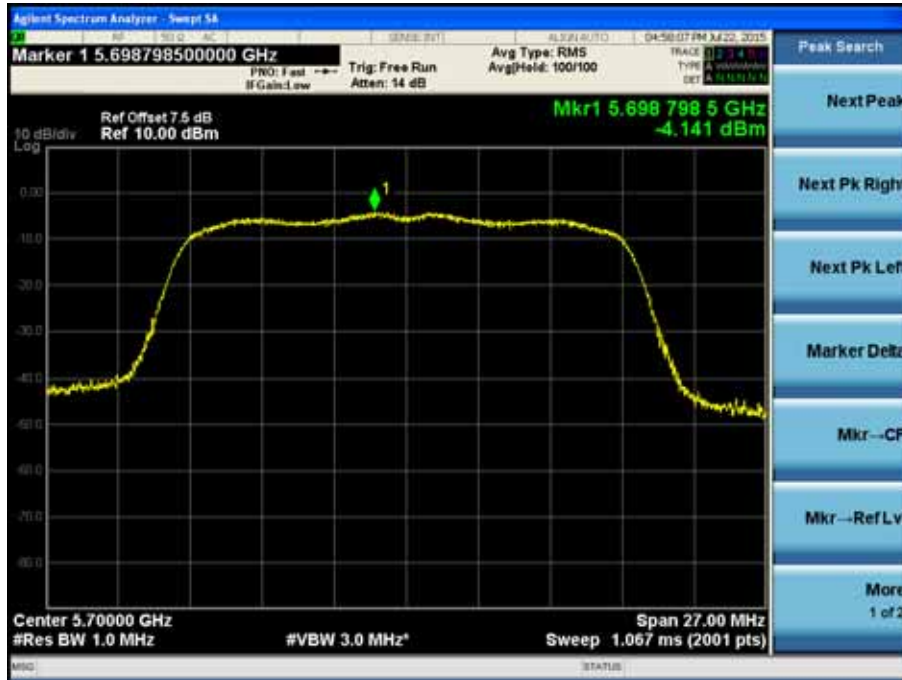

### Channel 149 (5745MHz)

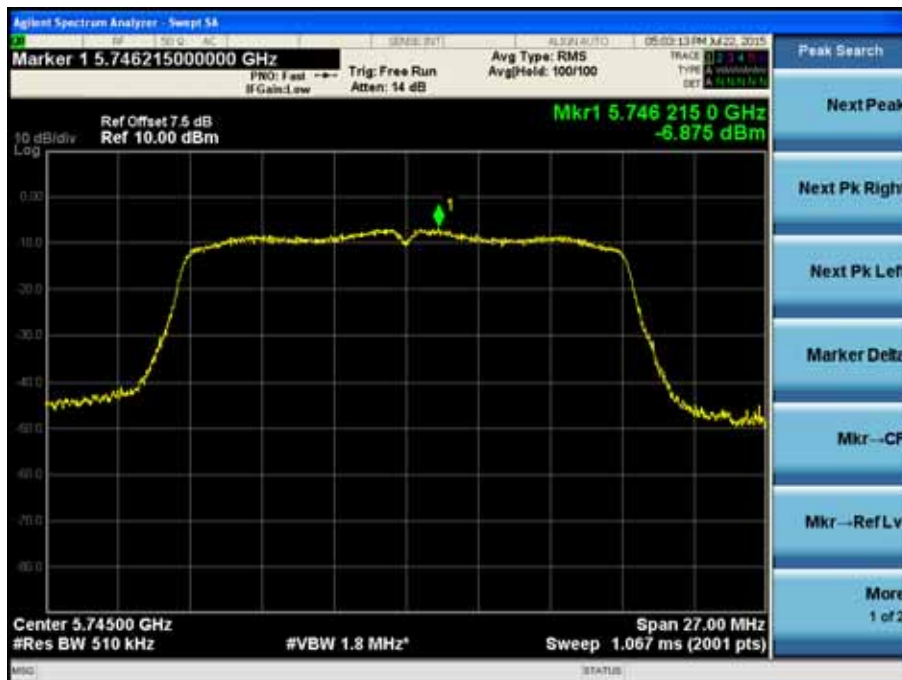

### Channel 157(5785MHz)



### Channel 165 (5825MHz)





Product	:	AB-R1
Test Item	:	Peak Power Spectral Density
Test Site	:	TR-8
Test Mode	:	Mode 2: Transmit by 802.11n(20MHz)

Channel No.	Frequency (MHz)	Reading Value (dBm/MHz)	Duty Cycle (%)	Total PPSD (dBm/MHz)	Limit (dBm/MHz)
36	5180	-7.578	94.3	-7.323	10
44	5200	-7.293	94.3	-7.038	10
48	5240	-6.663	94.3	-6.408	10
52	5260	-7.045	94.3	-6.790	11
60	5300	-6.923	94.3	-6.668	11
64	5320	-6.006	94.3	-5.751	11
100	5500	-5.560	94.3	-5.305	11
120	5600	-5.701	94.3	-5.446	11
140	5700	-5.529	94.3	-5.274	11

Channel No.	Frequency (MHz)	Reading Value (dBm/MHz)	Duty Cycle (%)	Total PPSD (dBm/MHz)	Limit (dBm/MHz)
149	5745	-7.290	94.3	-0.055	30
157	5785	-7.860	94.3	-0.625	30
165	5825	-7.987	94.3	-0.752	30

### Channel 36 (5180MHz)



### Channel 44 (5220MHz)



### Channel 48 (5240MHz)



### Channel 52 (5260MHz)

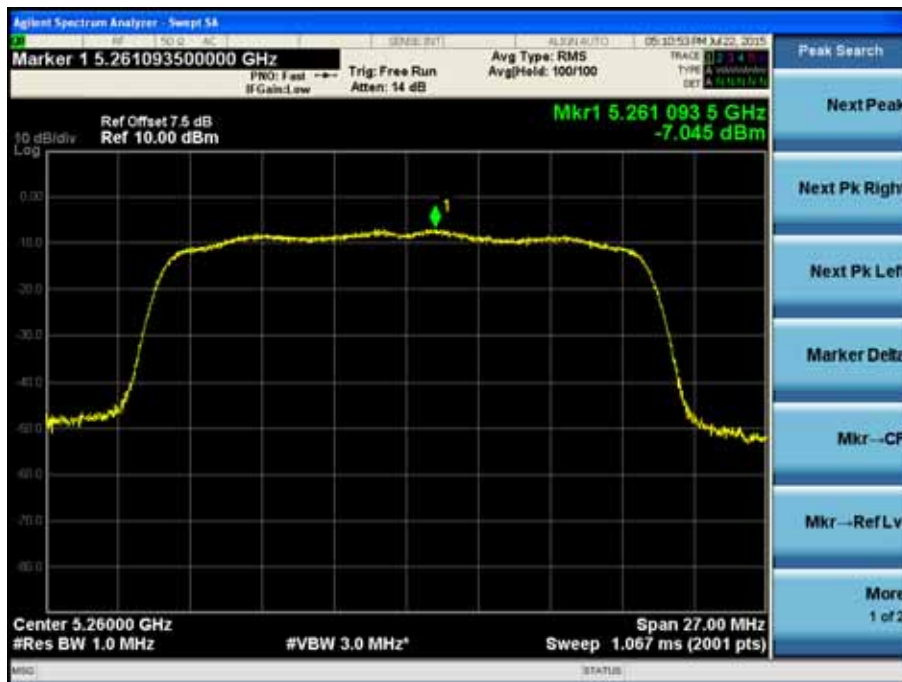

### Channel 60 (5300MHz)



### Channel 64 (5320MHz)



### Channel 100 (5500MHz)



### Channel 120 (5600MHz)



### Channel 140 (5700MHz)

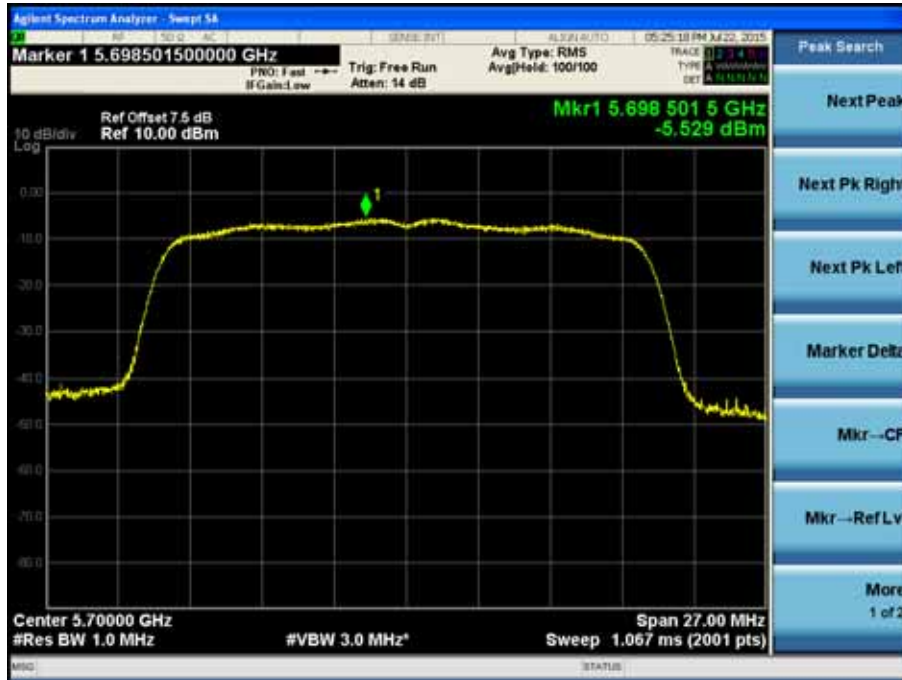

### Channel 149 (5745MHz)

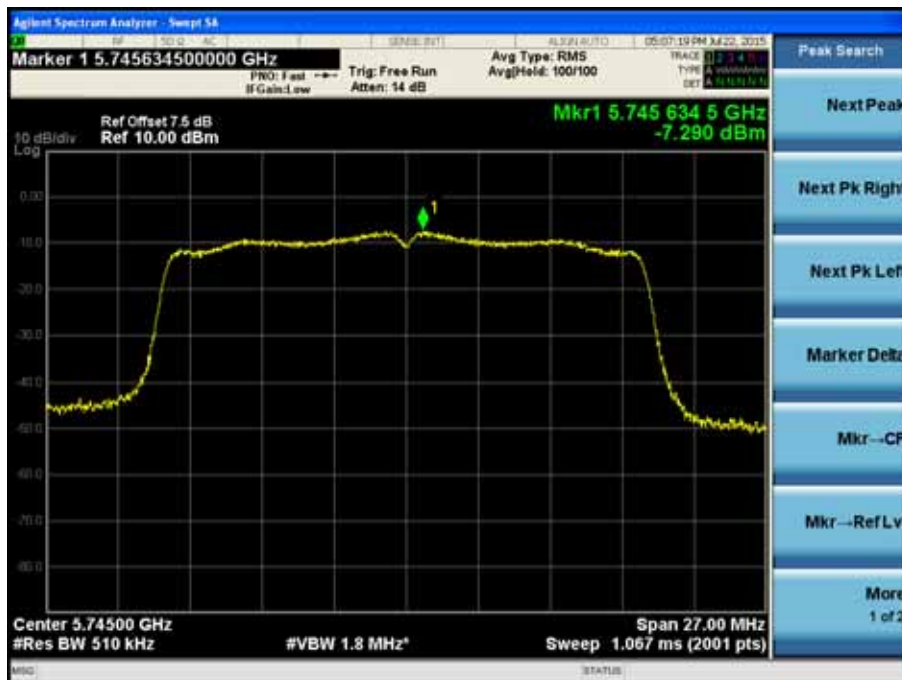



### Channel 157(5785MHz)

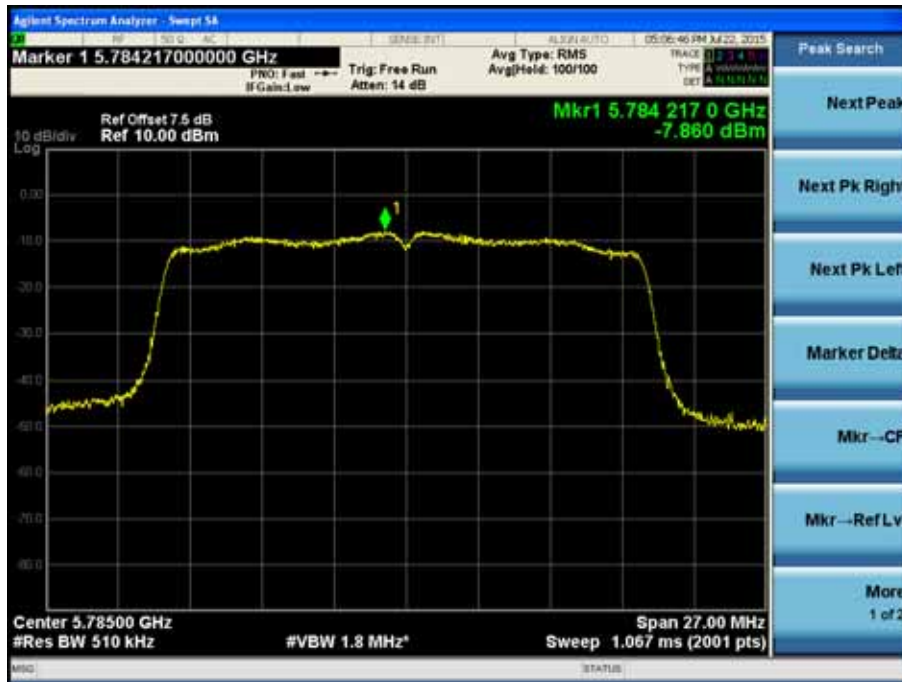

### Channel 165 (5825MHz)

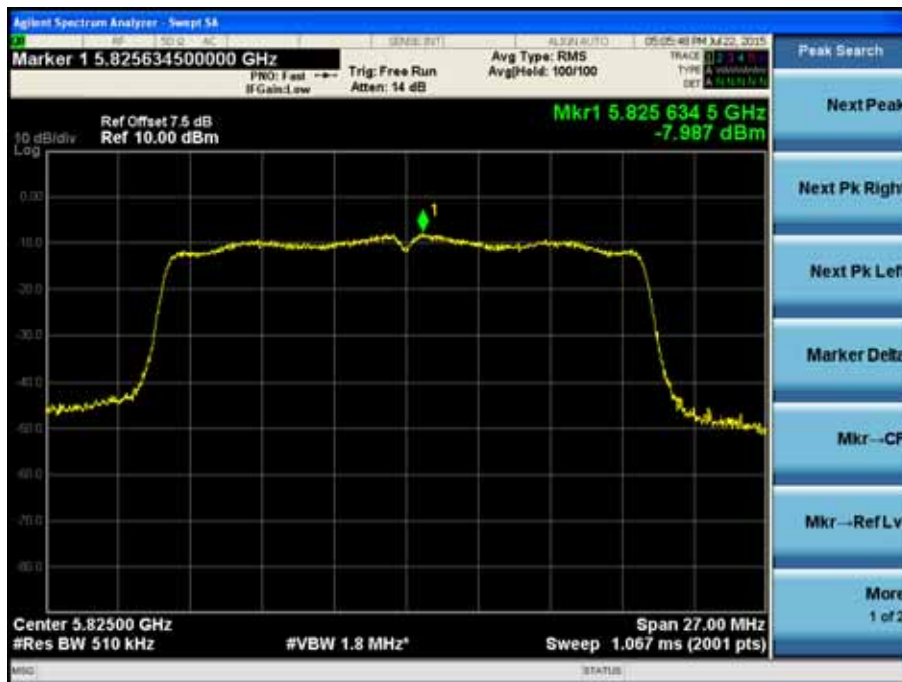

Product	:	AB-R1
Test Item	:	Peak Power Spectral Density
Test Site	:	TR-8
Test Mode	:	Mode 3: Transmit by 802.11n(40MHz)

Channel No.	Frequency (MHz)	Reading Value (dBm/MHz)	Duty Cycle (%)	Total PPSD (dBm/MHz)	Limit (dBm/MHz)
38	5190	-5.975	91.2	-5.975	10
46	5230	-5.698	91.2	-5.698	10
54	5270	-5.381	91.2	-5.381	11
62	5310	-4.835	91.2	-4.835	11
102	5510	-3.635	91.2	-3.635	11
110	5550	-3.910	91.2	-3.910	11
132	5670	-3.976	91.2	-3.976	11

Channel No.	Frequency (MHz)	Reading Value (dBm/MHz)	Duty Cycle (%)	Total PPSD (dBm/MHz)	Limit (dBm/MHz)
151	5755	-6.815	91.2	0.165	30
159	5795	-7.214	91.2	-0.234	30



### Channel 38 (5190MHz)



### Channel 42 (5230MHz)

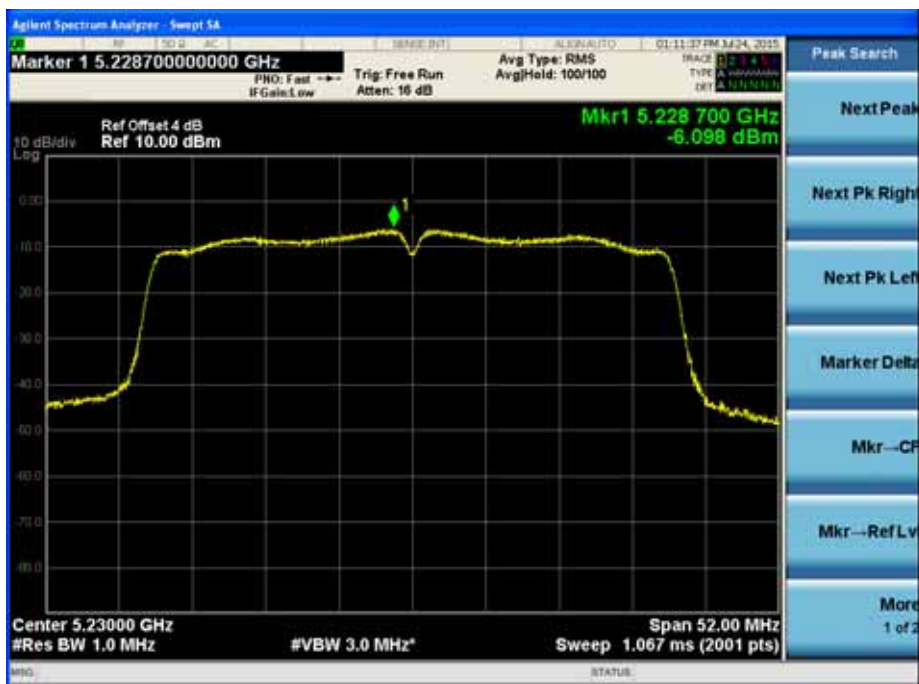

### Channel 54 (5270MHz)

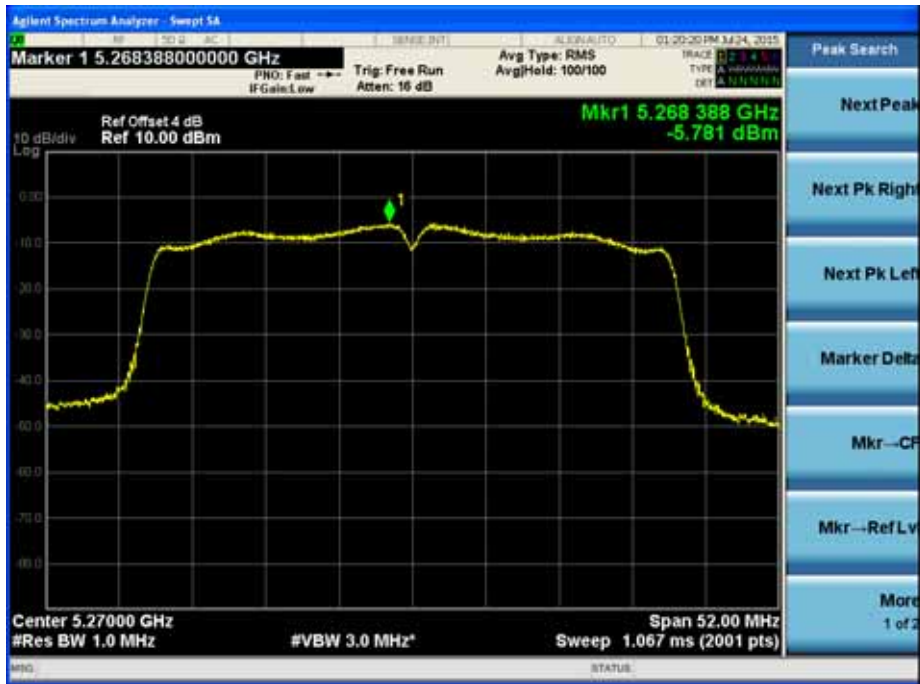

### Channel 62 (5310MHz)

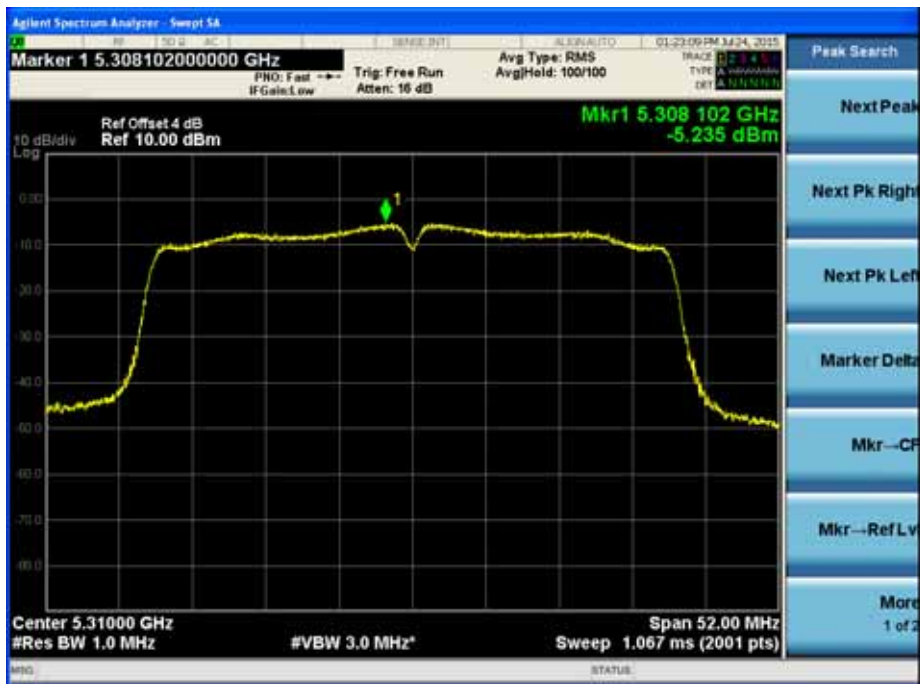

### Channel 102 (5510MHz)

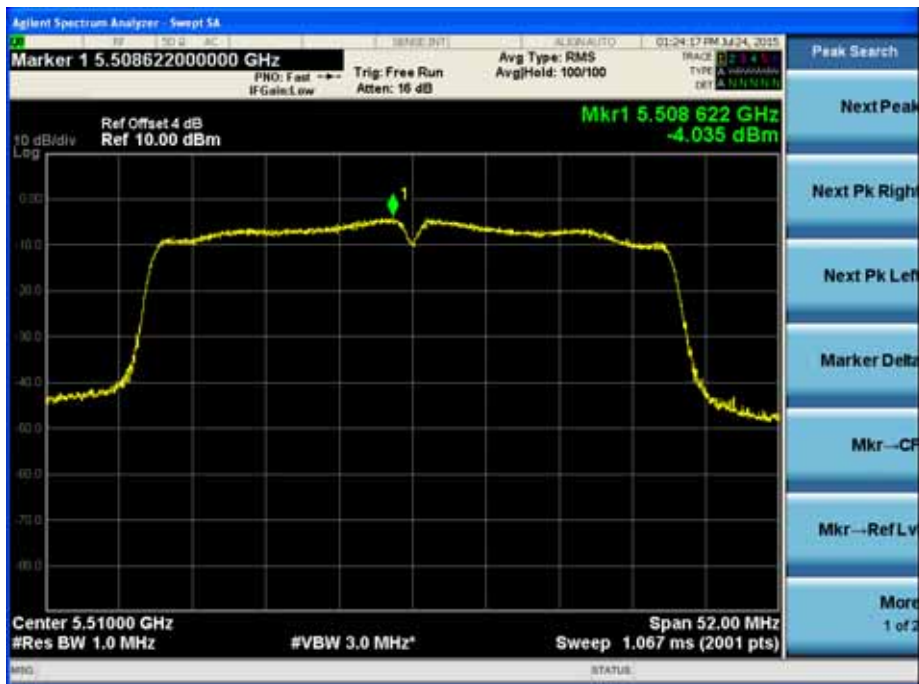

### Channel 110 (5550MHz)

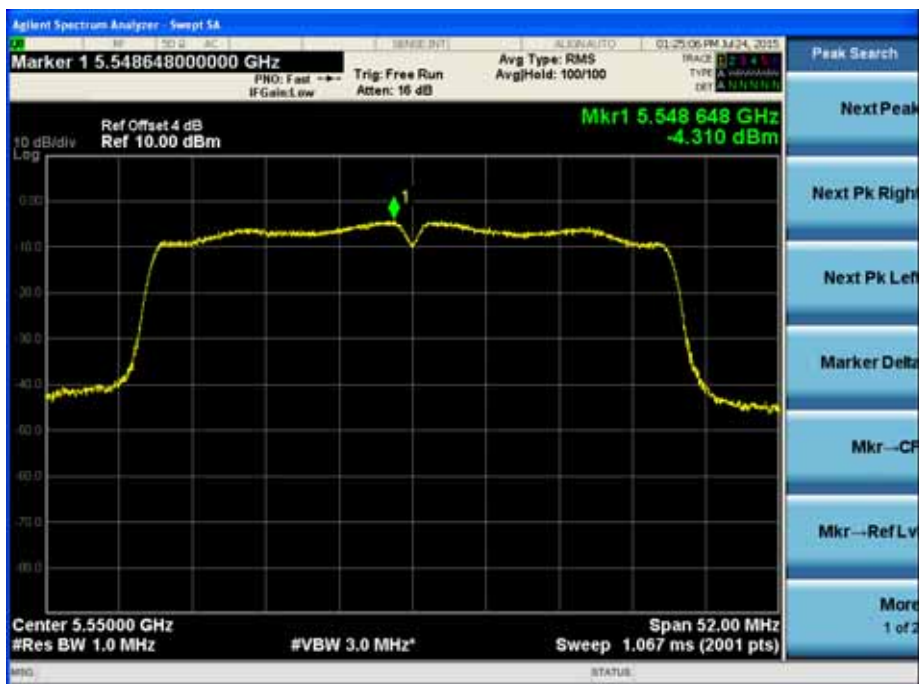

### Channel 134 (5670MHz)

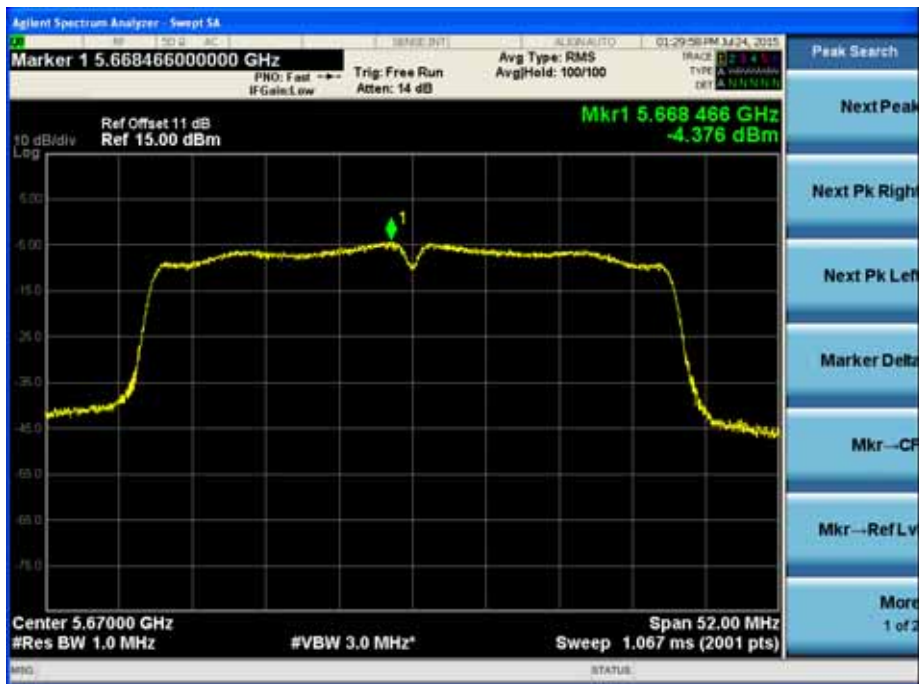

### Channel 151 (5755MHz)



### Channel 159(5795MHz)



## 9. Radiated Emission Band Edge

### 9.1. Test Equipment

☒ Radiated Emission Band Edge / AC-5

Instrument	Manufacturer	Type No.	Serial No.	Cal. Due Date
Spectrum Analyzer	Agilent	N9010A	MY48030494	2016.03.10
Preamplifier	Miteq	NSP1800-25	1364185	2016.05.03
Preamplifier	QuieTek	AP-040G	CHM-0906001	2016.05.03
Bilog Antenna	Teseq GmbH	CBL6112D	27612	2015.10.15
DRG Horn	ETS-Lindgren	3117	00123988	2016.01.07
Coaxial Cable	Huber+Suhner	SUCOFLEX 106	AC5-C1	2016.03.01
Coaxial Cable	Huber+Suhner	SUCOFLEX 106	AC5-C2	2016.03.01
Coaxial Cable	Huber+Suhner	SUCOFLEX 102	AC5-C3	2016.03.01
EMI Receiver	Agilent	N9038A	MY51210196	2016.06.09
Temperature/Humidity Meter	Zhichen	ZC1-2	AC5-TH	2016.01.08

### 9.2. Test Setup

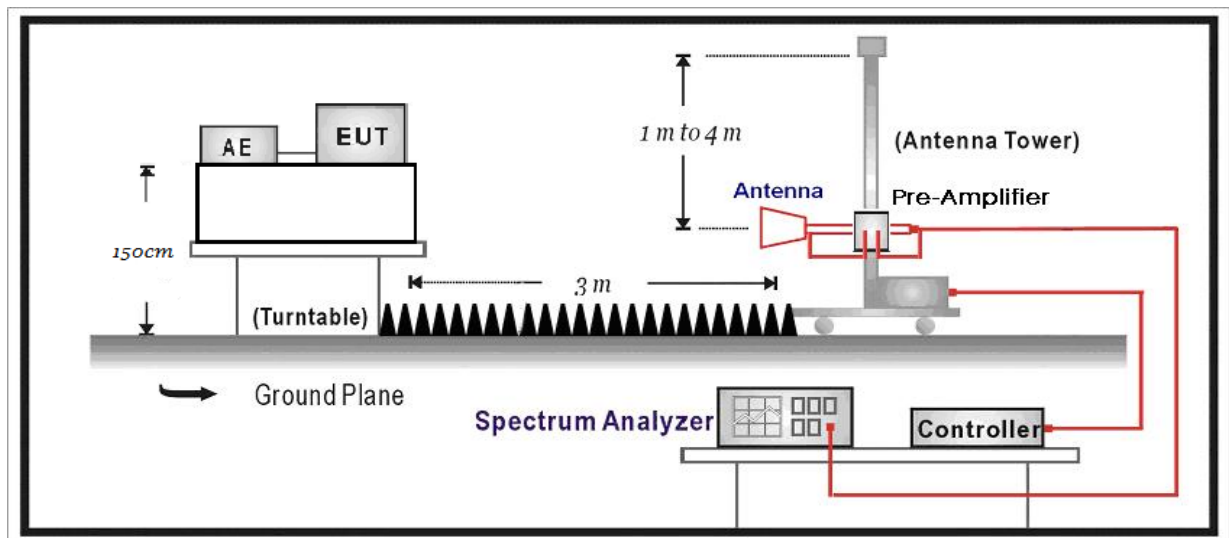

### 9.3. Limit

For FCC&IC

#### **For 15.205 requirement:**

Radiated emissions which fall in the restricted bands, as defined in Section 15.205(a) of FCC part 15, must also comply with the radiated emission limits specified in Section 15.209(a).



MHz	MHz	MHz	GHz
0.090 - 0.110	16.42 - 16.423	399.9 - 410	4.5 - 5.15
<sup>1</sup> 0.495 - 0.505	16.69475 - 16.69525	608 - 614	5.35 - 5.46
2.1735 - 2.1905	16.80425 - 16.80475	960 - 1240	7.25 - 7.75
4.125 - 4.128	25.5 - 25.67	1300 - 1427	8.025 - 8.5
4.17725 - 4.17775	37.5 - 38.25	1435 - 1626.5	9.0 - 9.2
4.20725 - 4.20775	73 - 74.6	1645.5 - 1646.5	9.3 - 9.5
6.215 - 6.218	74.8 - 75.2	1660 - 1710	10.6 - 12.7
6.26775 - 6.26825	108 - 121.94	1718.8 - 1722.2	13.25 - 13.4
6.31175 - 6.31225	123 - 138	2200 - 2300	14.47 - 14.5
8.291 - 8.294	149.9 - 150.05	2310 - 2390	15.35 - 16.2
8.362 - 8.366	156.52475 - 156.52525	2483.5 - 2500	17.7 - 21.4
8.37625 - 8.38675	156.7 - 156.9	2690 - 2900	22.01 - 23.12
8.41425 - 8.41475	162.0125 - 167.17	3260 - 3267	23.6 - 24.0
12.29 - 12.293	167.72 - 173.2	3332 - 3339	31.2 - 31.8
12.51975 - 12.52025	240 - 285	3345.8 - 3358	36.43 - 36.5
12.57675 - 12.57725	322 - 335.4	3600 - 4400	( <sup>2</sup> )

**For 15.407(b) requirement:**

- (1) For transmitters operating in the 5.15-5.25 GHz band: All emissions outside of the 5.15-5.35 GHz band shall not exceed an e.i.r.p. of -27 dBm/MHz.
- (2) For transmitters operating in the 5.25-5.35 GHz band: All emissions outside of the 5.15-5.35 GHz band shall not exceed an e.i.r.p. of -27 dBm/MHz.
- (3) For transmitters operating in the 5.47-5.725 GHz band: All emissions outside of the 5.47-5.725 GHz band shall not exceed an e.i.r.p. of -27 dBm/MHz.
- (4) For transmitters operating in the 5.725-5.85 GHz band: All emissions within the frequency range from the band edge to 10 MHz above or below the band edge shall not exceed an e.i.r.p. of -17 dBm/MHz; for frequencies 10 MHz or greater above or below the band edge, emissions shall not exceed an e.i.r.p. of -27 dBm/MHz.

Operating Frequency Band (MHz)	EIRP Limit (dBm/MHz)	Equivalent Field Strength at 3m (dBuV/m)
5150 - 5250	-27	68.3
5250 - 5350	-27	68.3
5470 - 5725	-27	68.3
5725 - 5825	-27 [Note(1)]	68.3
	-17 [Note(2)]	78.3

Note(1): Outside the frequency range 5715 - 5835MHz.

Note(2): Within the frequency range from the band edge to 10MHz below or above the band edge, 5715 – 5725MHz and 5825 - 5835MHz.



## 9.4. Test Procedure

According to ANSI C63.4:2014& ANSI C63.10:2013&789033 D02 General UNII Test Procedures New Rules v01& FCC CFR Title 47 Part 15 Subpart E: 2014& Industry Canada RSS-Gen Issue 4 Industry Canada RSS-247 Issue 1.

The EUT is placed on a turn table which is 1.5 meter above ground. The turn table is rotated 360 degrees to determine the position of the maximum emission level. The EUT was positioned such that the distance from antenna to the EUT was 3 meters.

The antenna is scanned from 1 meter to 4 meters to find out the maximum emission level. This is repeated for both horizontal and vertical polarization of the antenna. In order to find the maximum emission, all of the interface cables were manipulated according to ANSI C63.4: 2009 on radiated measurement.

Note: When doing emission measurement above 1GHz, the horn Chainenna will be bended down a little (as horn Chainenna has the narrow beamwidth) in order to keeping the Chainenna in the "cone of radiation" of EUT. The 3dB beamwidth is 10~60 degrees for H-plane and 10~90 degrees for E-plane.

## 9.5. Uncertainty

The measurement uncertainty above 1GHz is defined as  $\pm 3.9$  dB

### 9.6. Test Result

Peak detector: RBW = 1MHz, VBW = 3MHz, sweep time = 200ms;

Average detector: RBW = 1MHz, VBW = 10Hz, sweep time = auto.

Note: when the duty cycle is less than 98%, a duty cycle factor is calculated in the correction factor

Engineer: Scott	
Site: AC5	Time: 2015/07/19 - 17:19
Limit: FCC_Part15.209_RE(3m)	Margin: 0
Probe: Horn_3117_00165315(1-18GHz)	Polarity: Horizontal
EUT: AB-R1	Power: AC 16V
Note: Mode1: Transmit at CH5180 by 802.11a	

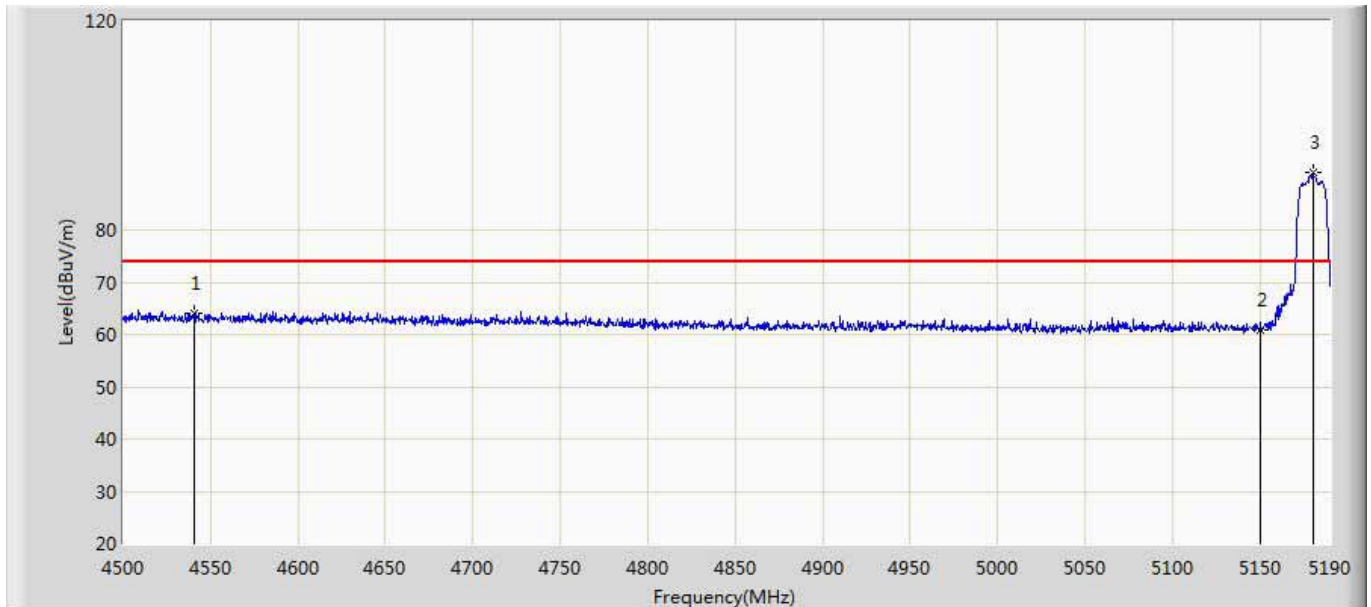

No	Mark	Frequency (MHz)	Measure Level (dBuV/m)	Reading Level (dBuV)	Over Limit (dB)	Limit (dBuV/m)	Factor (dB)	Type
1		4540.365	64.090	21.494	-9.910	74.000	42.595	PK
2		5150.000	60.941	17.544	-13.059	74.000	43.397	PK
3	*	5180.340	90.897	47.386	N/A	N/A	43.511	PK

Engineer: Scott	
Site: AC5	Time: 2015/07/19 - 17:21
Limit: FCC_Part15.209_RE(3m)	Margin: 0
Probe: Horn_3117_00165315(1-18GHz)	Polarity: Horizontal
EUT: AB-R1	Power: AC 16V
Note: Mode1: Transmit at CH5180 by 802.11a	

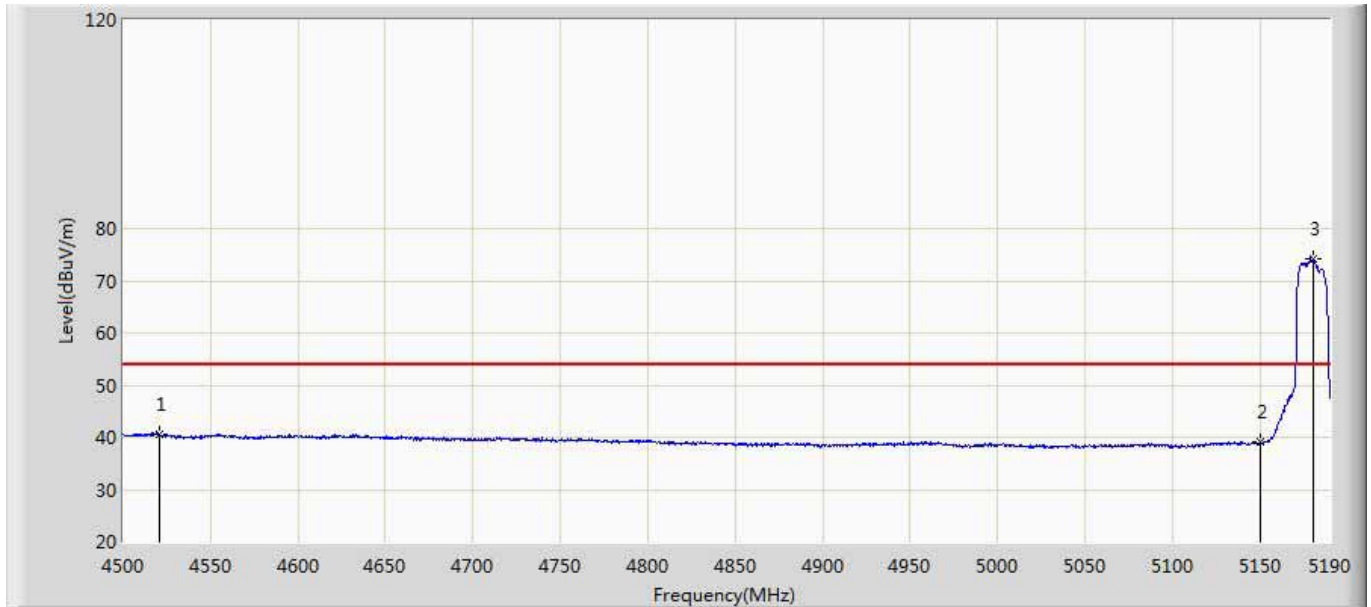

No	Mark	Frequency (MHz)	Measure Level (dBuV/m)	Reading Level (dBuV)	Over Limit (dB)	Limit (dBuV/m)	Factor (dB)	Type
1		4520.700	40.692	-2.005	-13.308	54.000	42.697	AV
2		5150.000	39.012	-4.385	-14.988	54.000	43.397	AV
3	*	5180.685	74.193	30.679	N/A	N/A	43.514	AV

Engineer: Scott	
Site: AC5	Time: 2015/07/19 - 17:25
Limit: FCC_Part15.209_RE(3m)	Margin: 0
Probe: Horn_3117_00165315(1-18GHz)	Polarity: Vertical
EUT: AB-R1	Power: AC 16V
Note: Mode1: Transmit at CH5180 by 802.11a	

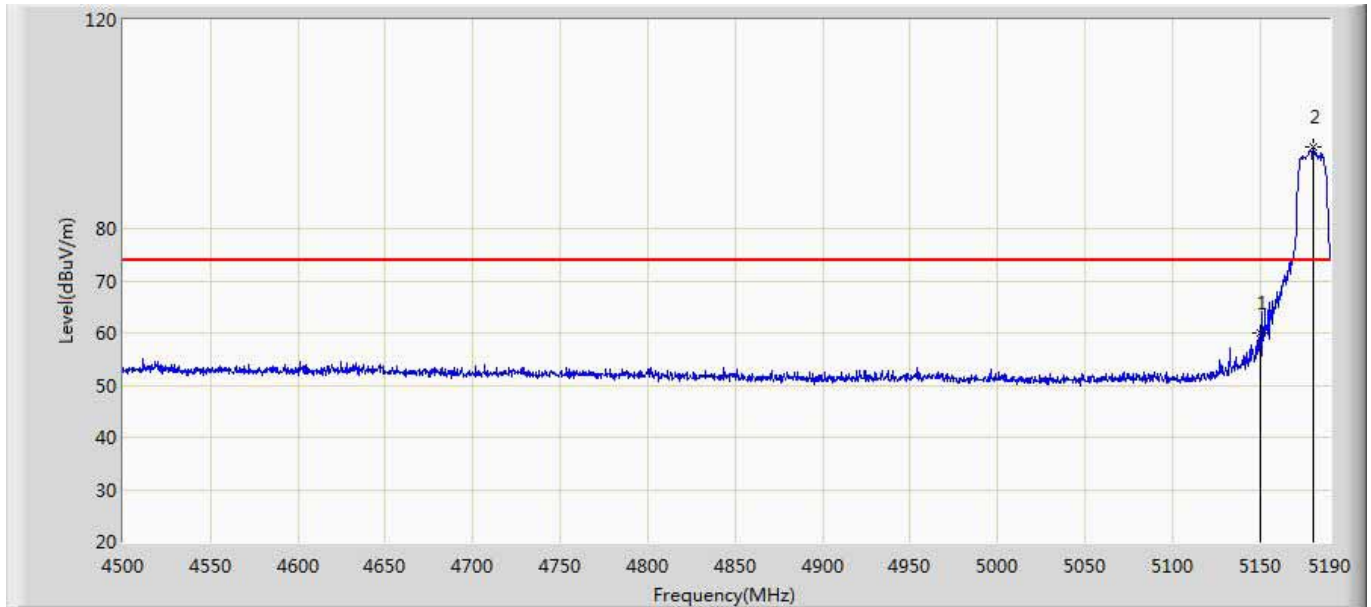

No	Mark	Frequency (MHz)	Measure Level (dBuV/m)	Reading Level (dBuV)	Over Limit (dB)	Limit (dBuV/m)	Factor (dB)	Type
1		5150.000	59.940	16.543	-14.060	74.000	43.397	PK
2	*	5180.685	95.752	52.238	N/A	N/A	43.514	PK

Engineer: Scott	
Site: AC5	Time: 2015/07/19 - 17:26
Limit: FCC_Part15.209_RE(3m)	Margin: 0
Probe: Horn_3117_00165315(1-18GHz)	Polarity: Vertical
EUT: AB-R1	Power: AC 16V
Note: Mode1: Transmit at CH5180 by 802.11a	

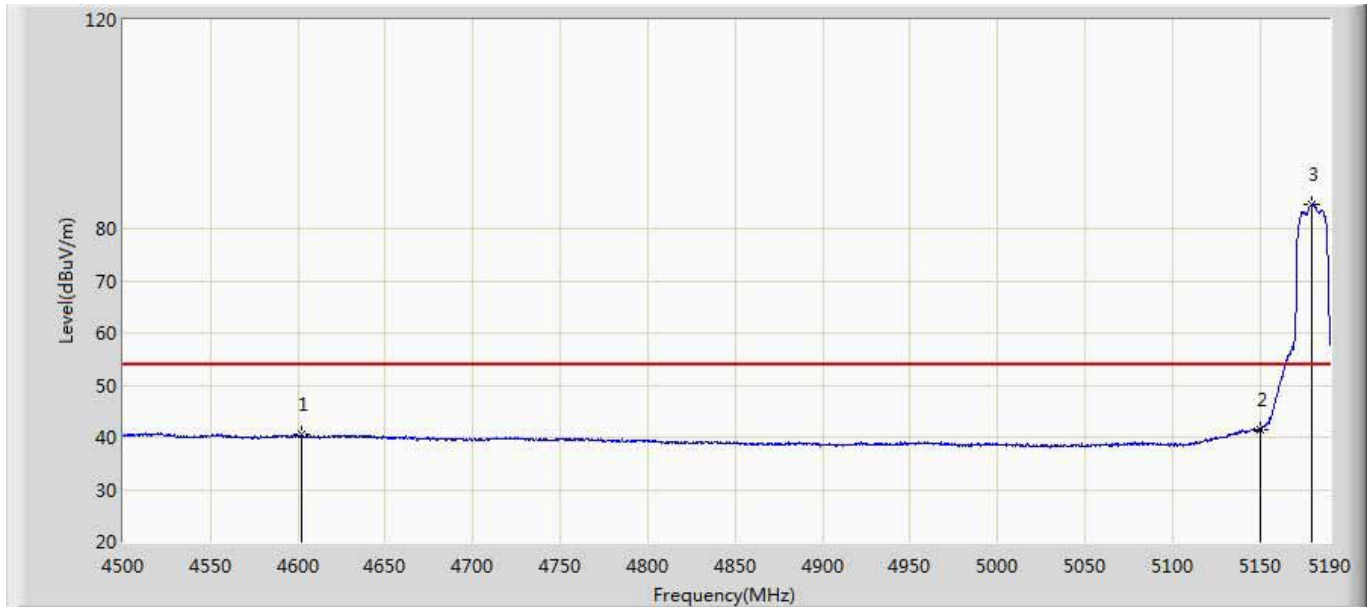

No	Mark	Frequency (MHz)	Measure Level (dBuV/m)	Reading Level (dBuV)	Over Limit (dB)	Limit (dBuV/m)	Factor (dB)	Type
1		4601.775	40.461	-2.172	-13.539	54.000	42.633	AV
2		5150.000	41.556	-1.841	-12.444	54.000	43.397	AV
3	*	5179.305	84.617	41.112	N/A	N/A	43.505	AV

Engineer: Scott	
Site: AC5	Time: 2015/07/19 - 17:31
Limit: FCC_Part15.209_RE(3m)	Margin: 0
Probe: Horn_3117_00165315(1-18GHz)	Polarity: Horizontal
EUT: AB-R1	Power: AC 16V
Note: Mode1: Transmit at CH5320 by 802.11a	

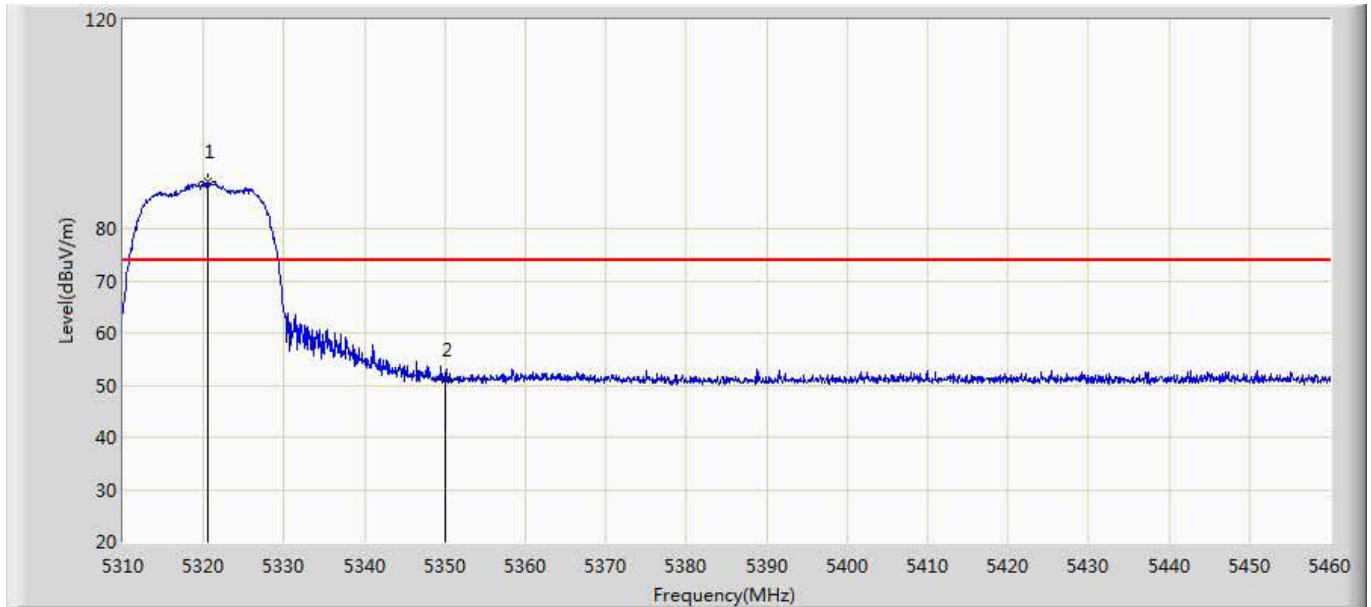

No	Mark	Frequency (MHz)	Measure Level (dBuV/m)	Reading Level (dBuV)	Over Limit (dB)	Limit (dBuV/m)	Factor (dB)	Type
1	*	5320.575	88.924	45.047	N/A	N/A	43.877	PK
2		5350.000	50.909	7.106	-23.091	74.000	43.803	PK

Engineer: Scott	
Site: AC5	Time: 2015/07/19 - 17:33
Limit: FCC_Part15.209_RE(3m)	Margin: 0
Probe: Horn_3117_00165315(1-18GHz)	Polarity: Horizontal
EUT: AB-R1	Power: AC 16V
Note: Mode1: Transmit at CH5320 by 802.11a	

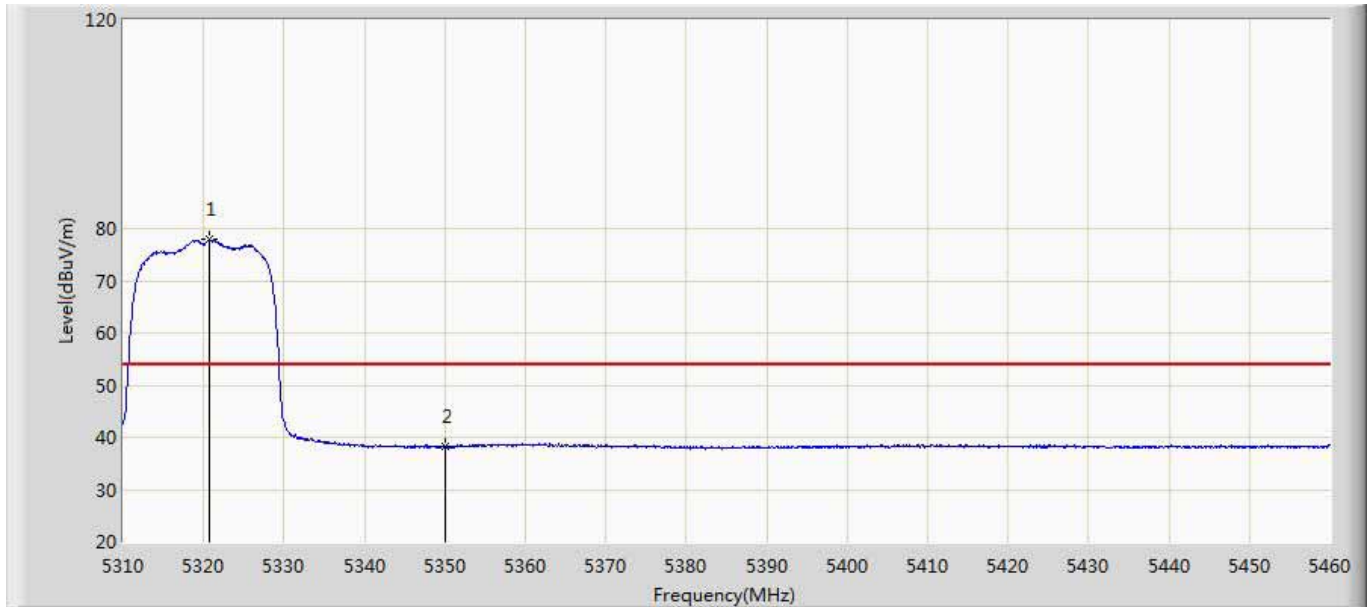

No	Mark	Frequency (MHz)	Measure Level (dBuV/m)	Reading Level (dBuV)	Over Limit (dB)	Limit (dBuV/m)	Factor (dB)	Type
1	*	5320.725	78.090	34.216	N/A	N/A	43.874	AV
2		5350.000	38.208	-5.595	-15.792	54.000	43.803	AV

Engineer: Scott	
Site: AC5	Time: 2015/07/19 - 17:35
Limit: FCC_Part15.209_RE(3m)	Margin: 0
Probe: Horn_3117_00165315(1-18GHz)	Polarity: Vertical
EUT: AB-R1	Power: AC 16V
Note: Mode1: Transmit at CH5320 by 802.11a	

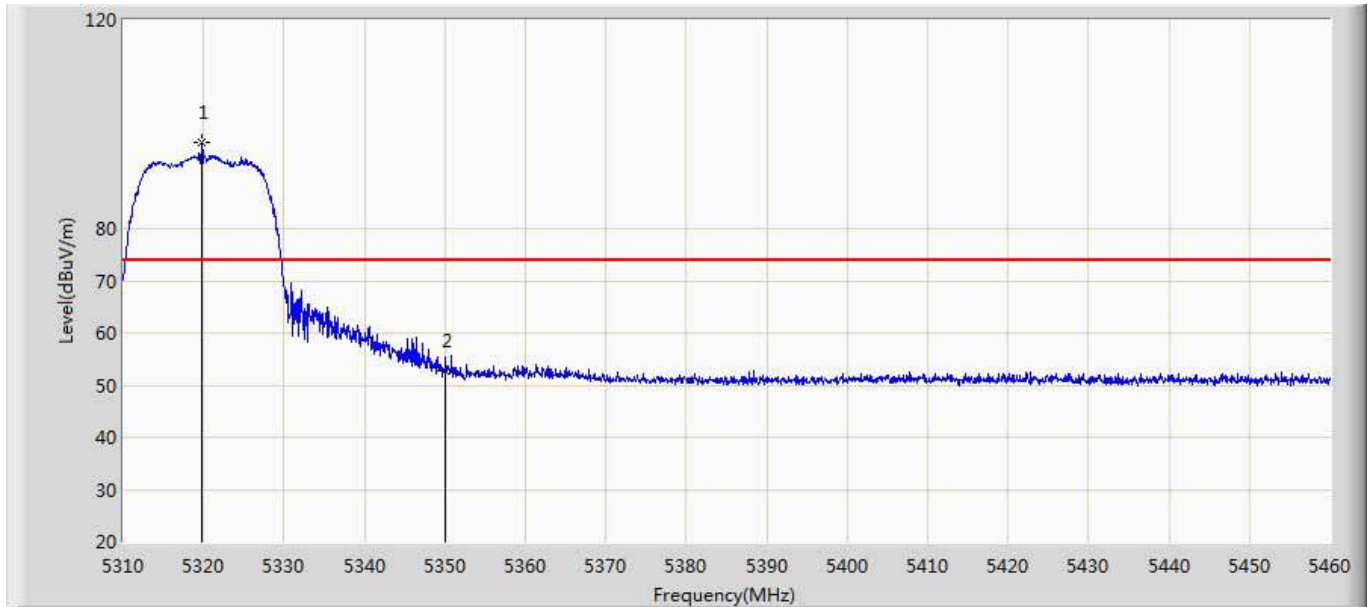

No	Mark	Frequency (MHz)	Measure Level (dBuV/m)	Reading Level (dBuV)	Over Limit (dB)	Limit (dBuV/m)	Factor (dB)	Type
1	*	5319.825	96.623	52.730	N/A	N/A	43.893	PK
2		5350.000	52.680	8.877	-21.320	74.000	43.803	PK



Engineer: Scott	
Site: AC5	Time: 2015/07/19 - 17:36
Limit: FCC_Part15.209_RE(3m)	Margin: 0
Probe: Horn_3117_00165315(1-18GHz)	Polarity: Vertical
EUT: AB-R1	Power: AC 16V
Note: Mode1: Transmit at CH5320 by 802.11a	

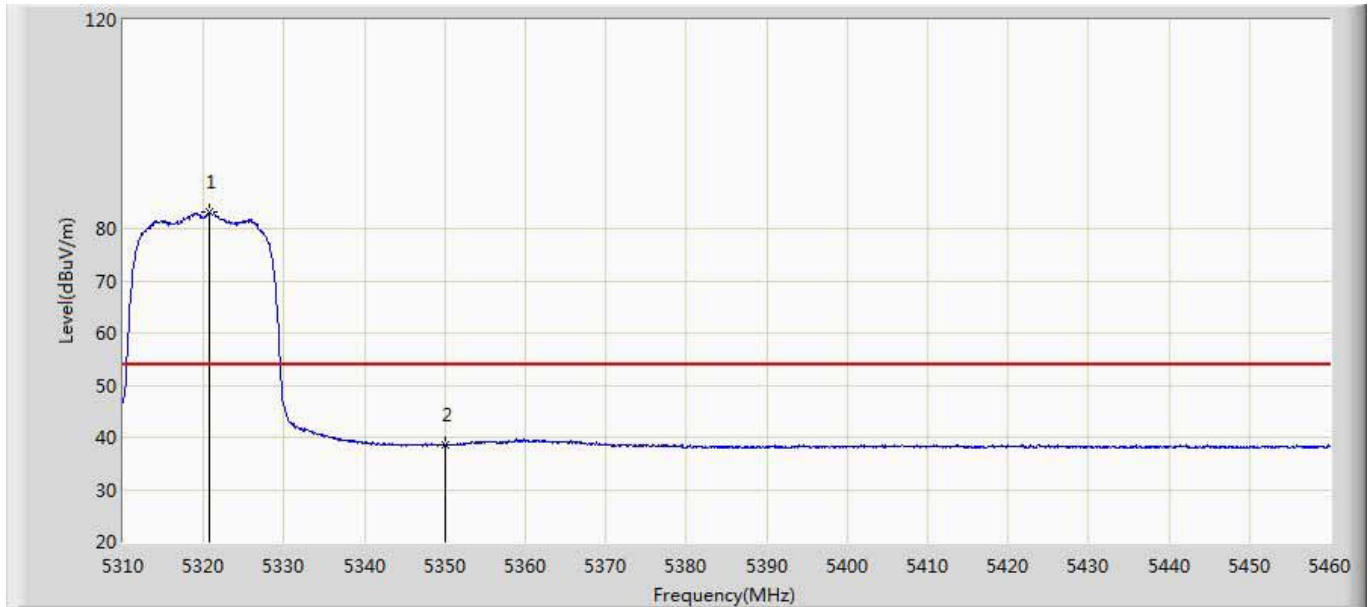

No	Mark	Frequency (MHz)	Measure Level (dBuV/m)	Reading Level (dBuV)	Over Limit (dB)	Limit (dBuV/m)	Factor (dB)	Type
1	*	5320.650	83.211	39.335	N/A	N/A	43.875	AV
2		5350.000	38.543	-5.260	-15.457	54.000	43.803	AV

Engineer: Scott	
Site: AC5	Time: 2015/07/19 - 17:41
Limit: FCC_Part15.209_RE(3m)	Margin: 0
Probe: Horn_3117_00165315(1-18GHz)	Polarity: Horizontal
EUT: AB-R1	Power: AC 16V
Note: Mode1: Transmit at CH5500 by 802.11a	

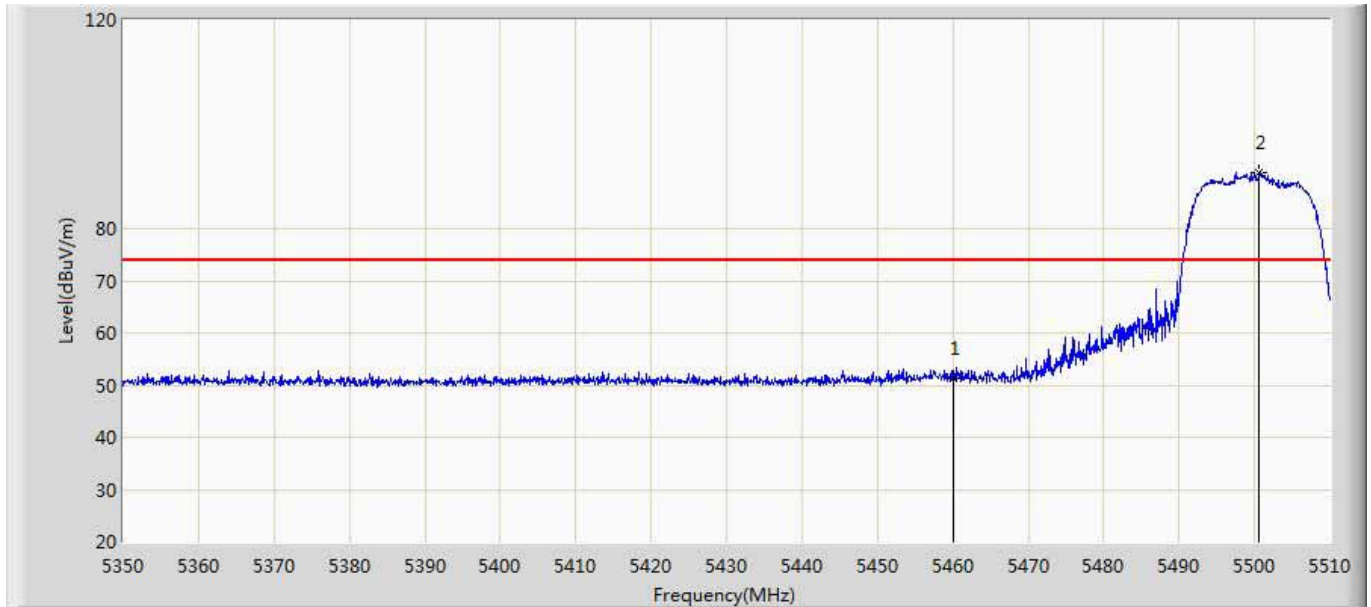

No	Mark	Frequency (MHz)	Measure Level (dBuV/m)	Reading Level (dBuV)	Over Limit (dB)	Limit (dBuV/m)	Factor (dB)	Type
1		5460.000	51.279	7.282	-22.721	74.000	43.997	PK
2	*	5500.640	90.849	46.701	N/A	N/A	44.148	PK

Engineer: Scott	
Site: AC5	Time: 2015/07/19 - 17:43
Limit: FCC_Part15.209_RE(3m)	Margin: 0
Probe: Horn_3117_00165315(1-18GHz)	Polarity: Horizontal
EUT: AB-R1	Power: AC 16V
Note: Mode1: Transmit at CH5500 by 802.11a	

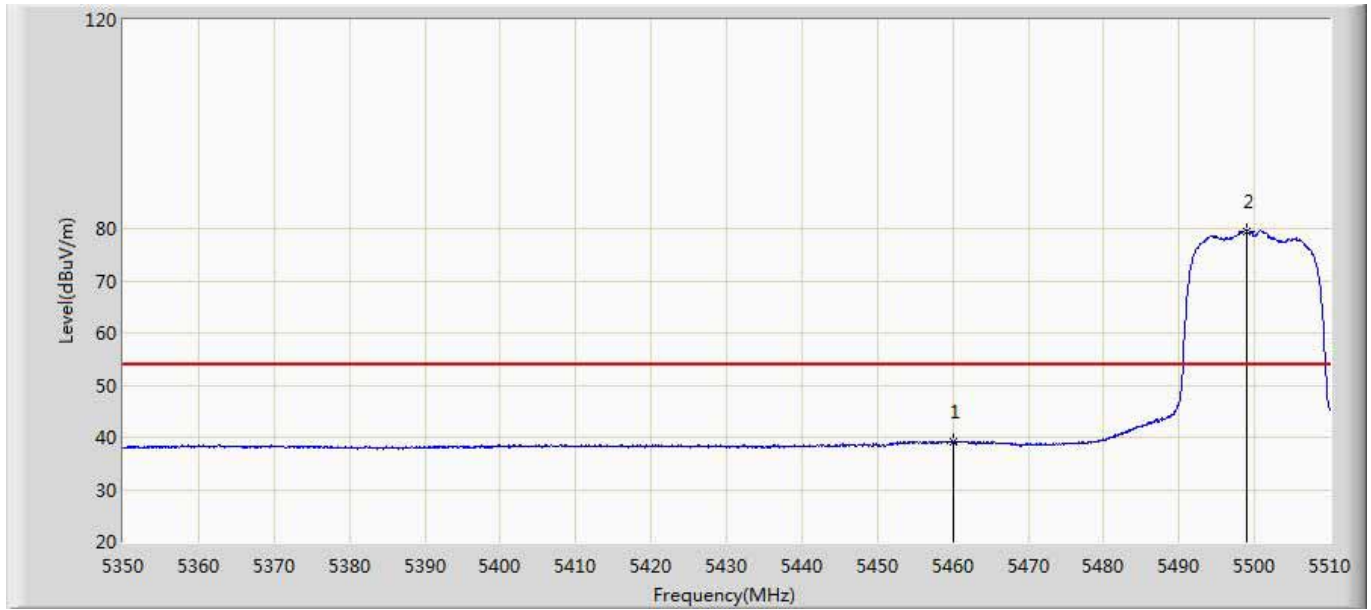

No	Mark	Frequency (MHz)	Measure Level (dBuV/m)	Reading Level (dBuV)	Over Limit (dB)	Limit (dBuV/m)	Factor (dB)	Type
1		5460.000	39.118	-4.879	-14.882	54.000	43.997	AV
2	*	5498.960	79.564	35.415	N/A	N/A	44.149	AV

Engineer: Scott	
Site: AC5	Time: 2015/07/19 - 17:46
Limit: FCC_Part15.209_RE(3m)	Margin: 0
Probe: Horn_3117_00165315(1-18GHz)	Polarity: Vertical
EUT: AB-R1	Power: AC 16V
Note: Mode1: Transmit at CH5500 by 802.11a	

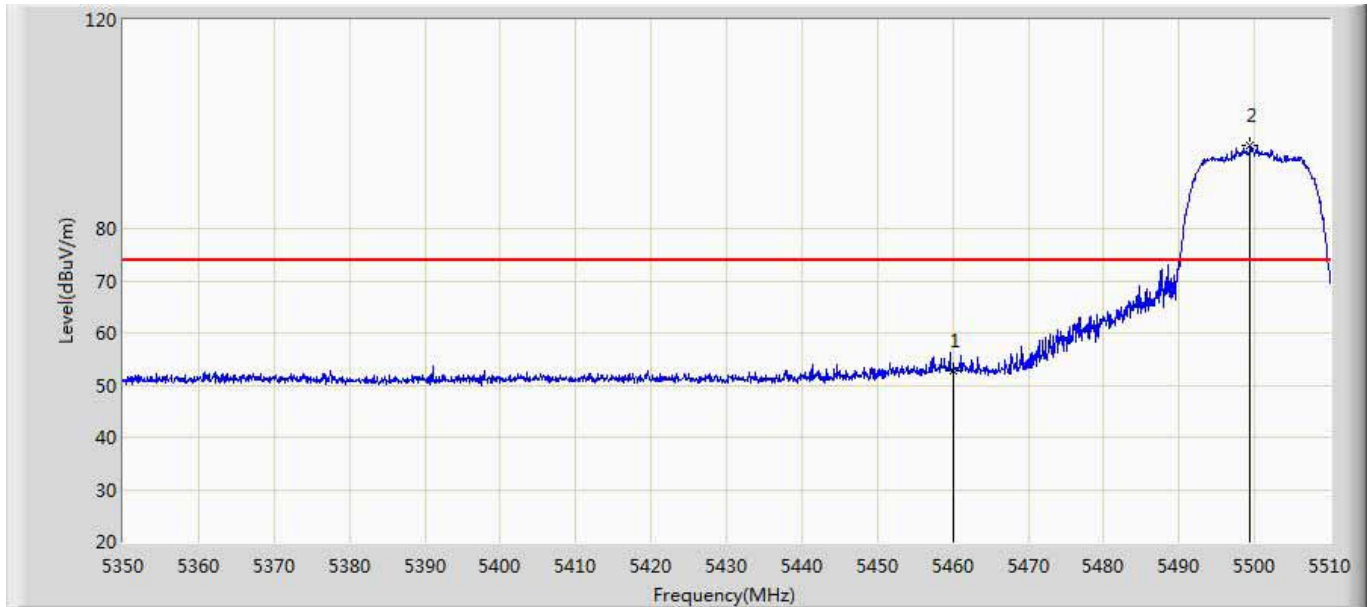

No	Mark	Frequency (MHz)	Measure Level (dBuV/m)	Reading Level (dBuV)	Over Limit (dB)	Limit (dBuV/m)	Factor (dB)	Type
1		5460.000	52.839	8.842	-21.161	74.000	43.997	PK
2	*	5499.440	95.929	51.780	N/A	N/A	44.149	PK

Engineer: Scott	
Site: AC5	Time: 2015/07/19 - 17:48
Limit: FCC_Part15.209_RE(3m)	Margin: 0
Probe: Horn_3117_00165315(1-18GHz)	Polarity: Vertical
EUT: AB-R1	Power: AC 16V
Note: Mode1: Transmit at CH5500 by 802.11a	

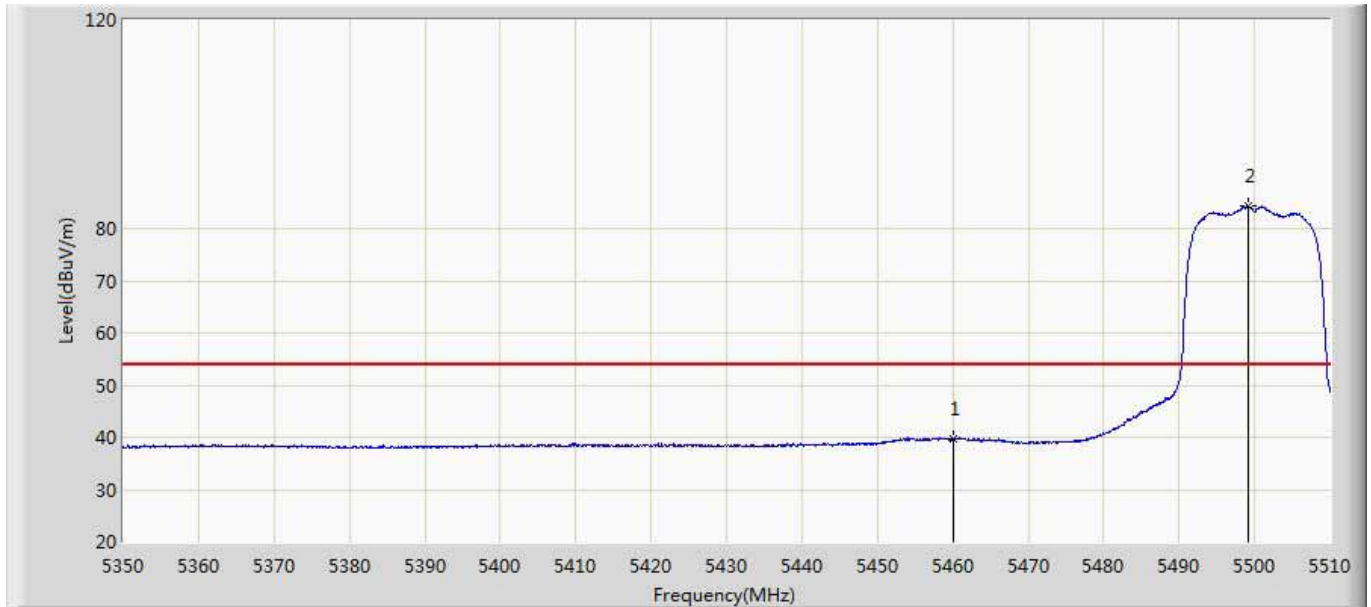

No	Mark	Frequency (MHz)	Measure Level (dBuV/m)	Reading Level (dBuV)	Over Limit (dB)	Limit (dBuV/m)	Factor (dB)	Type
1		5460.000	39.634	-4.363	-14.366	54.000	43.997	AV
2	*	5499.120	84.265	40.116	N/A	N/A	44.149	AV

Engineer: Scott	
Site: AC5	Time: 2015/07/20 - 10:10
Limit: FCC-15.407 new	Margin: 0
Probe: Horn_3117_00165315(1-18GHz)	Polarity: Horizontal
EUT: AB-R1	Power: AC 16V
Note: Mode1: Transmit at CH5745 by 802.11a	

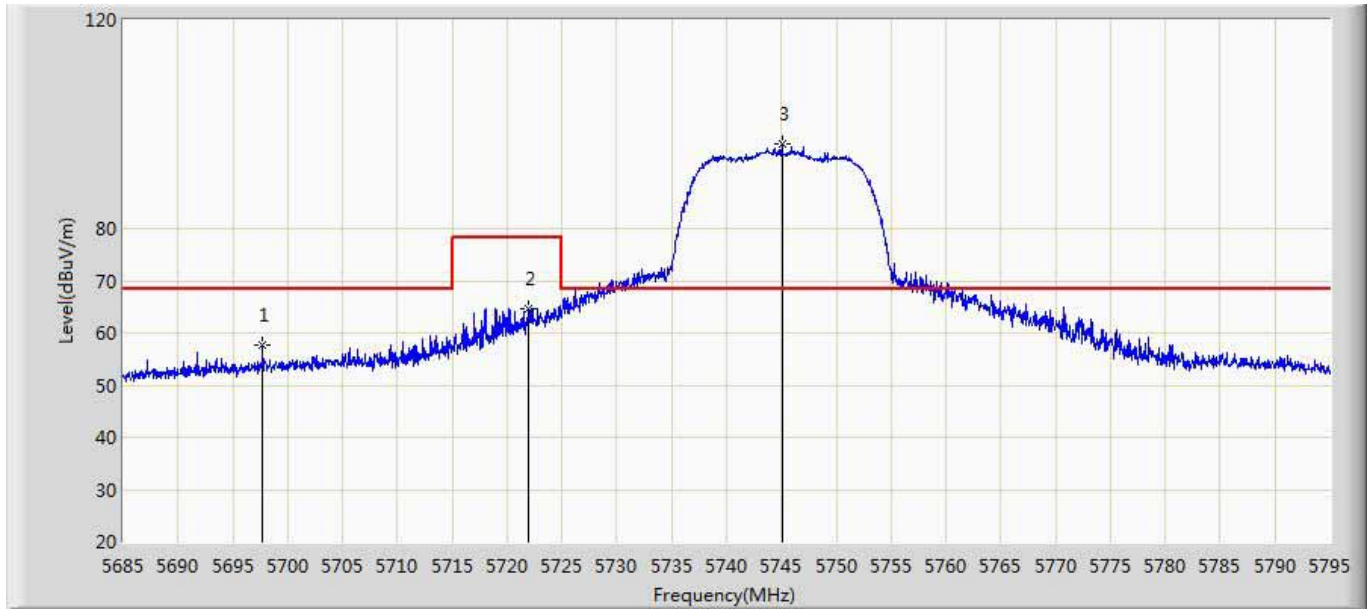

No	Mark	Frequency (MHz)	Measure Level (dBuV/m)	Reading Level (dBuV)	Over Limit (dB)	Limit (dBuV/m)	Factor (dB)	Type
1		5697.705	57.735	12.957	-10.565	68.300	44.778	PK
2		5721.960	64.569	19.756	-13.731	78.300	44.813	PK
3	*	5745.060	96.218	51.281	N/A	N/A	44.937	PK

Engineer: Scott	
Site: AC5	Time: 2015/07/20 - 10:15
Limit: FCC-15.407 new	Margin: 0
Probe: Horn_3117_00165315(1-18GHz)	Polarity: Vertical
EUT: AB-R1	Power: AC 16V
Note: Mode1: Transmit at CH5745 by 802.11a	

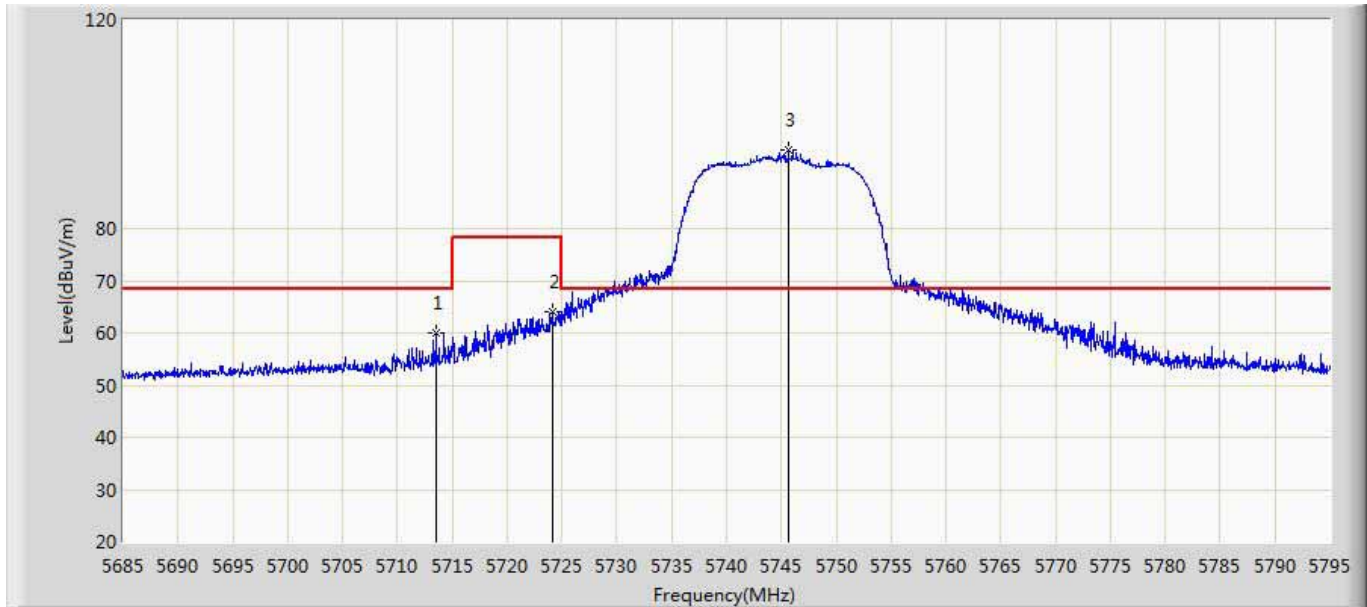

No	Mark	Frequency (MHz)	Measure Level (dBuV/m)	Reading Level (dBuV)	Over Limit (dB)	Limit (dBuV/m)	Factor (dB)	Type
1		5713.545	59.858	15.071	-8.442	68.300	44.787	PK
2		5724.160	64.075	19.255	-14.225	78.300	44.820	PK
3	*	5745.665	94.990	50.061	N/A	N/A	44.930	PK

Engineer: Scott	
Site: AC5	Time: 2015/07/20 - 10:20
Limit: FCC-15.407 new	Margin: 0
Probe: Horn_3117_00165315(1-18GHz)	Polarity: Horizontal
EUT: AB-R1	Power: AC 16V
Note: Mode1: Transmit at CH5825 by 802.11a	

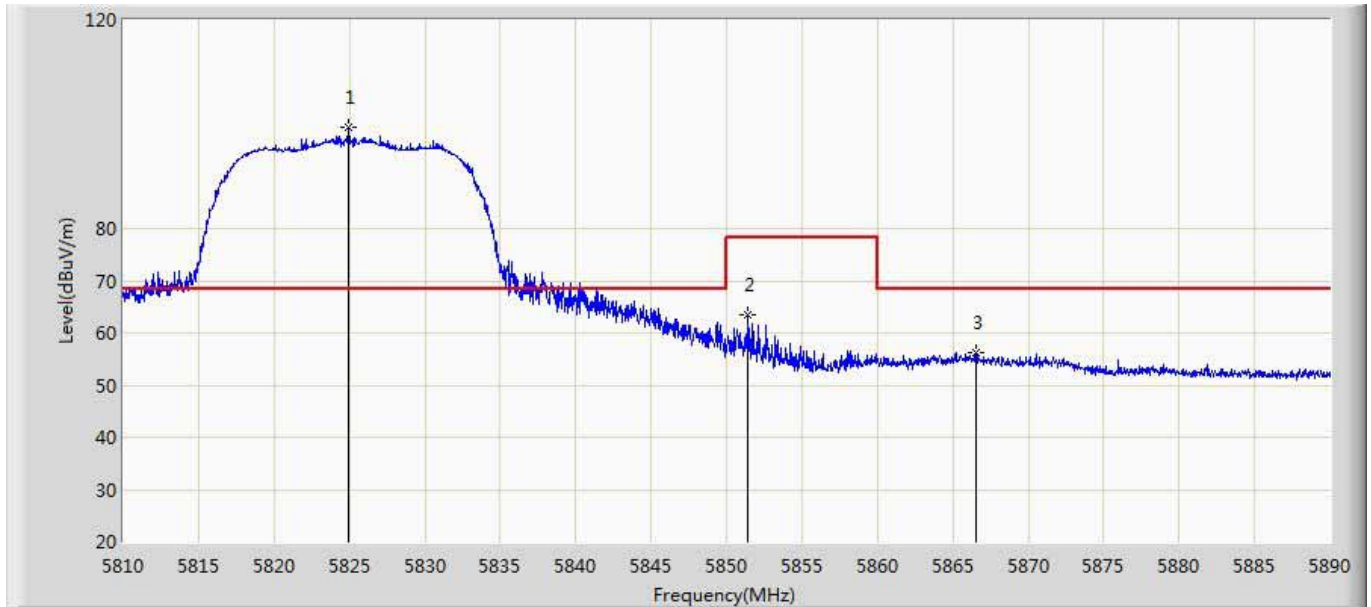

No	Mark	Frequency (MHz)	Measure Level (dBuV/m)	Reading Level (dBuV)	Over Limit (dB)	Limit (dBuV/m)	Factor (dB)	Type
1	*	5824.960	99.313	54.337	N/A	N/A	44.975	PK
2		5851.440	63.339	18.332	-14.961	78.300	45.008	PK
3		5866.560	56.201	11.056	-12.099	68.300	45.145	PK



Engineer: Scott	
Site: AC5	Time: 2015/07/20 - 10:23
Limit: FCC-15.407 new	Margin: 0
Probe: Horn_3117_00165315(1-18GHz)	Polarity: Vertical
EUT: AB-R1	Power: AC 16V
Note: Mode1: Transmit at CH5825 by 802.11a	

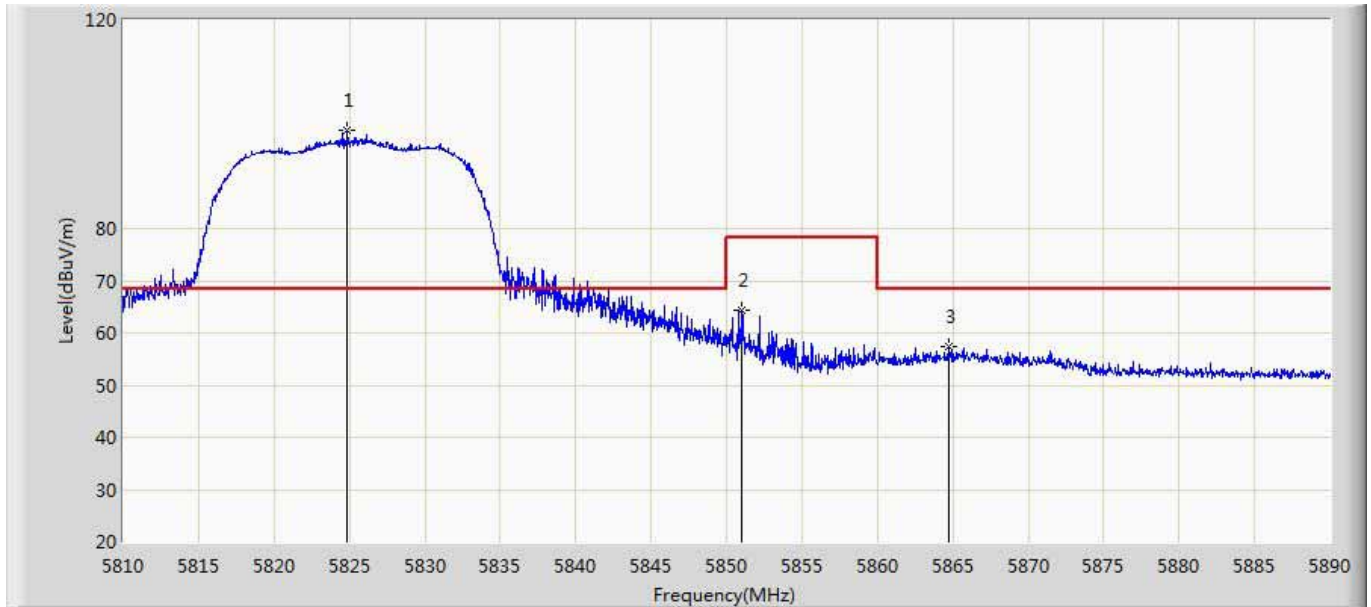

No	Mark	Frequency (MHz)	Measure Level (dBuV/m)	Reading Level (dBuV)	Over Limit (dB)	Limit (dBuV/m)	Factor (dB)	Type
1	*	5824.880	98.851	53.876	N/A	N/A	44.975	PK
2		5851.000	64.482	19.480	-13.818	78.300	45.002	PK
3		5864.760	57.526	12.390	-10.774	68.300	45.136	PK

Engineer: Scott	
Site: AC5	Time: 2015/07/20 - 10:33
Limit: FCC_Part15.209_RE(3m)	Margin: 0
Probe: Horn_3117_00165315(1-18GHz)	Polarity: Horizontal
EUT: AB-R1	Power: AC 16V
Note: Mode1: Transmit at CH5180 by 802.11n(20MHz)	

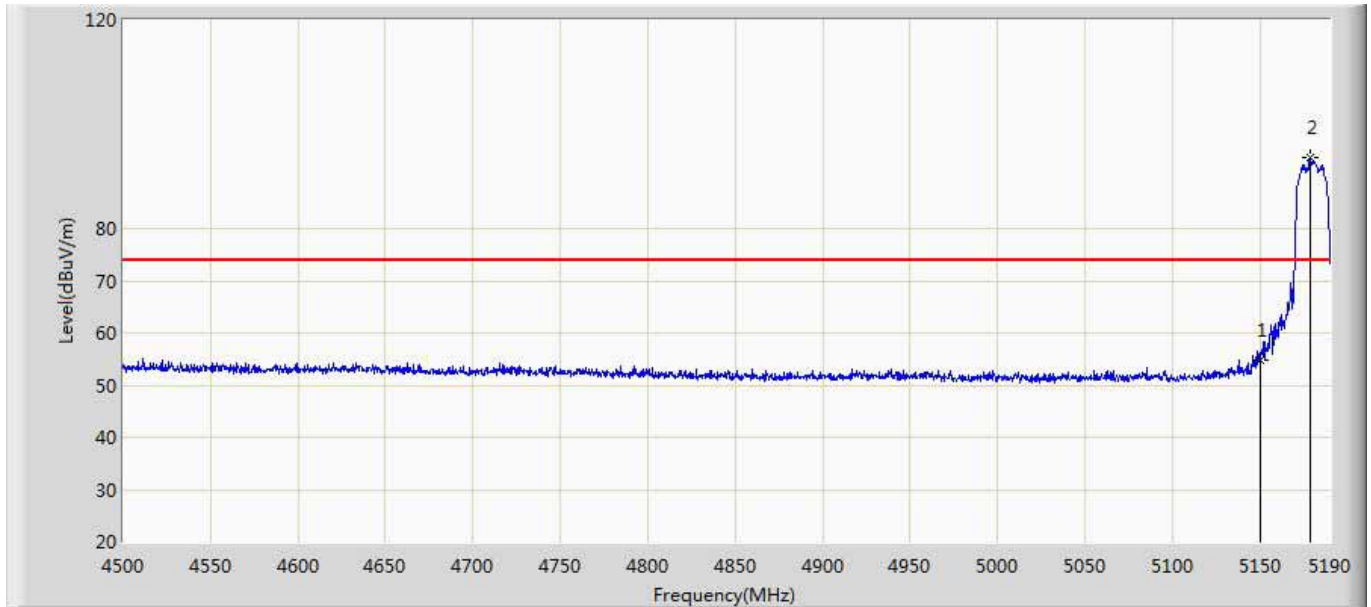

No	Mark	Frequency (MHz)	Measure Level (dBuV/m)	Reading Level (dBuV)	Over Limit (dB)	Limit (dBuV/m)	Factor (dB)	Type
1		5150.000	54.802	11.405	-19.198	74.000	43.397	PK
2	*	5178.960	93.731	50.228	N/A	N/A	43.503	PK

Engineer: Scott	
Site: AC5	Time: 2015/07/20 - 10:40
Limit: FCC_Part15.209_RE(3m)	Margin: 0
Probe: Horn_3117_00165315(1-18GHz)	Polarity: Horizontal
EUT: AB-R1	Power: AC 16V
Note: Mode1: Transmit at CH5180 by 802.11n(20MHz)	

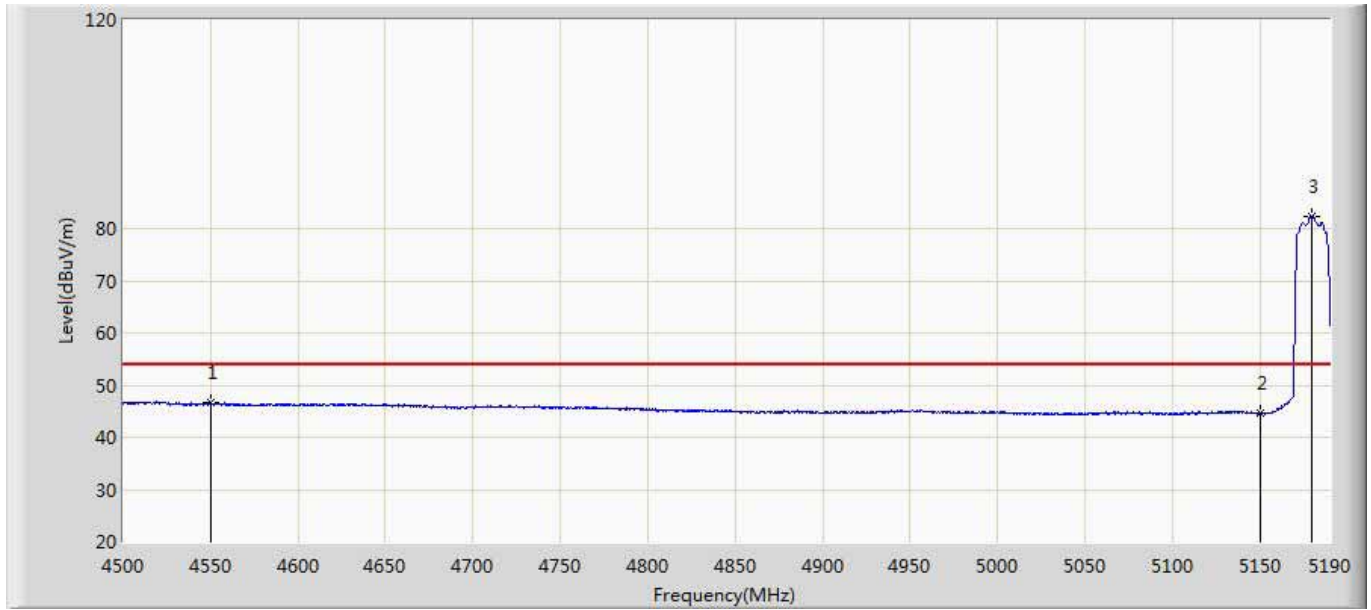

No	Mark	Frequency (MHz)	Measure Level (dBuV/m)	Reading Level (dBuV)	Over Limit (dB)	Limit (dBuV/m)	Factor (dB)	Type
1		4550.370	46.673	3.996	-7.327	54.000	42.677	AV
2		5150.000	44.579	1.182	-9.421	54.000	43.397	AV
3	*	5179.305	82.365	38.860	N/A	N/A	43.505	AV

Engineer: Scott	
Site: AC5	Time: 2015/07/20 - 10:48
Limit: FCC_Part15.209_RE(3m)	Margin: 0
Probe: Horn_3117_00165315(1-18GHz)	Polarity: Vertical
EUT: AB-R1	Power: AC 16V
Note: Mode1: Transmit at CH5180 by 802.11n(20MHz)	

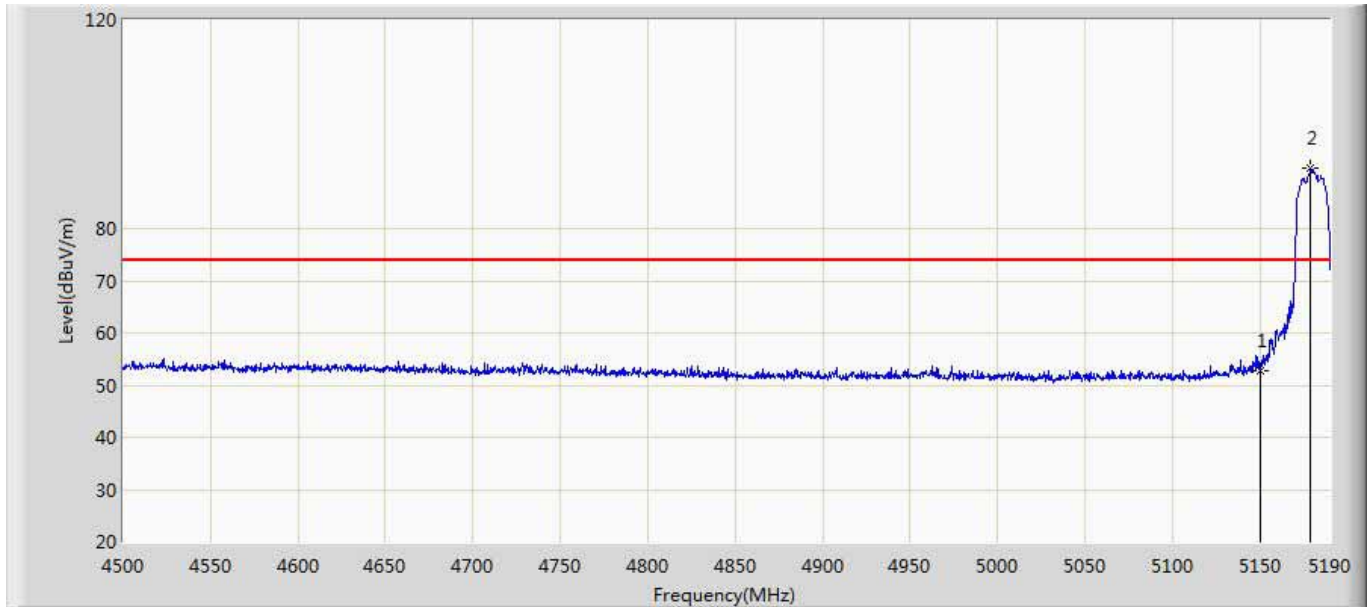

No	Mark	Frequency (MHz)	Measure Level (dBuV/m)	Reading Level (dBuV)	Over Limit (dB)	Limit (dBuV/m)	Factor (dB)	Type
1		5150.000	52.870	9.473	-21.130	74.000	43.397	PK
2	*	5178.960	91.581	48.078	N/A	N/A	43.503	PK

Engineer: Scott	
Site: AC5	Time: 2015/07/20 - 10:52
Limit: FCC_Part15.209_RE(3m)	Margin: 0
Probe: Horn_3117_00165315(1-18GHz)	Polarity: Vertical
EUT: AB-R1	Power: AC 16V
Note: Mode1: Transmit at CH5180 by 802.11n(20MHz)	

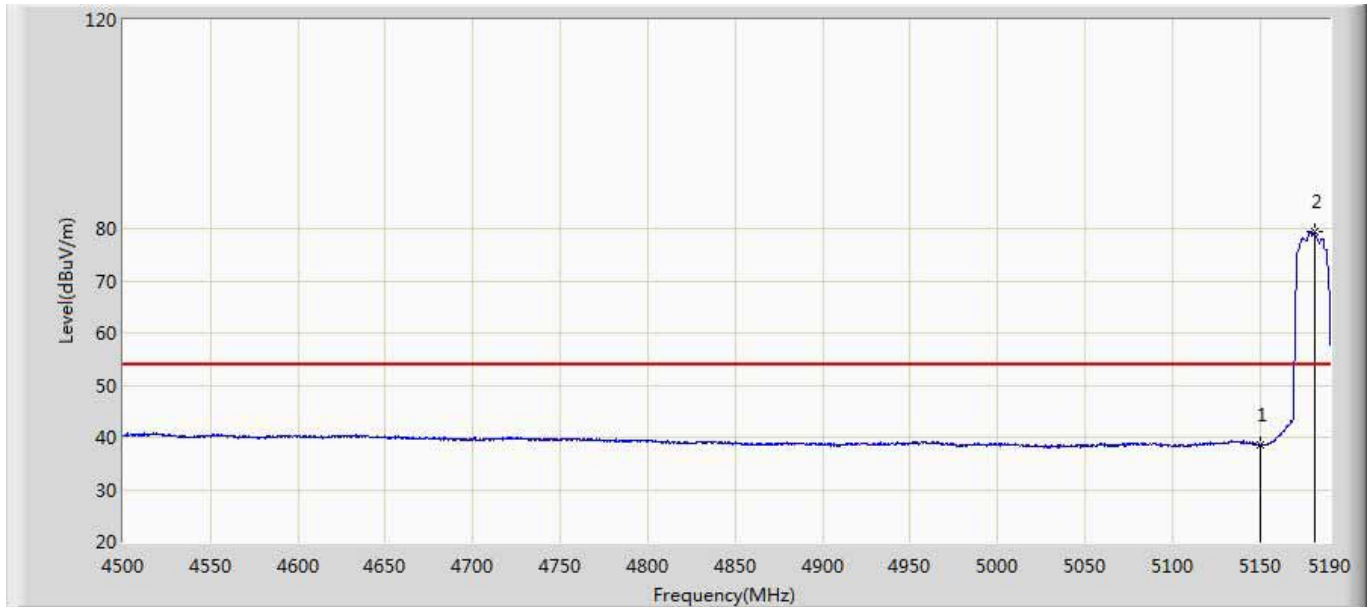

No	Mark	Frequency (MHz)	Measure Level (dBuV/m)	Reading Level (dBuV)	Over Limit (dB)	Limit (dBuV/m)	Factor (dB)	Type
1		5150.000	38.446	-4.951	-15.554	54.000	43.397	AV
2	*	5181.030	79.502	35.986	N/A	N/A	43.516	AV

Engineer: Scott	
Site: AC5	Time: 2015/07/20 - 10:59
Limit: FCC_Part15.209_RE(3m)	Margin: 0
Probe: Horn_3117_00165315(1-18GHz)	Polarity: Horizontal
EUT: AB-R1	Power: AC 16V
Note: Mode1: Transmit at CH5320 by 802.11n(20MHz)	

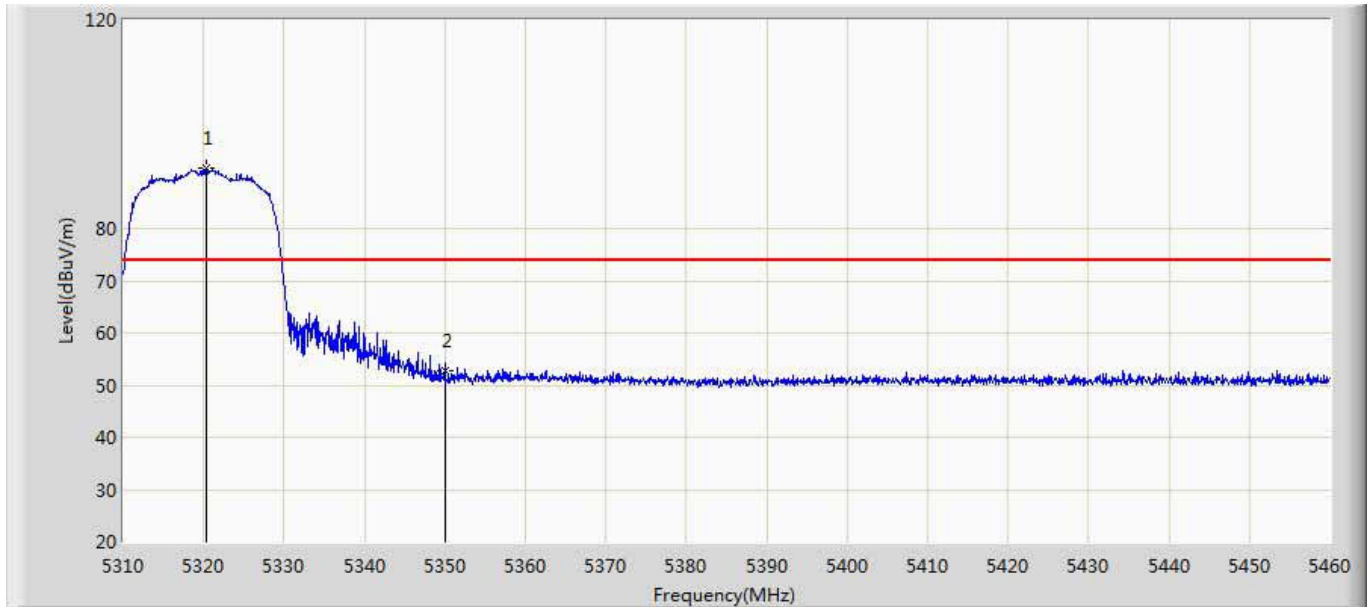

No	Mark	Frequency (MHz)	Measure Level (dBuV/m)	Reading Level (dBuV)	Over Limit (dB)	Limit (dBuV/m)	Factor (dB)	Type
1	*	5320.275	91.672	47.789	N/A	N/A	43.884	PK
2		5350.000	52.864	9.061	-21.136	74.000	43.803	PK

Engineer: Scott	
Site: AC5	Time: 2015/07/20 - 11:01
Limit: FCC_Part15.209_RE(3m)	Margin: 0
Probe: Horn_3117_00165315(1-18GHz)	Polarity: Horizontal
EUT: AB-R1	Power: AC 16V
Note: Mode1: Transmit at CH5320 by 802.11n(20MHz)	

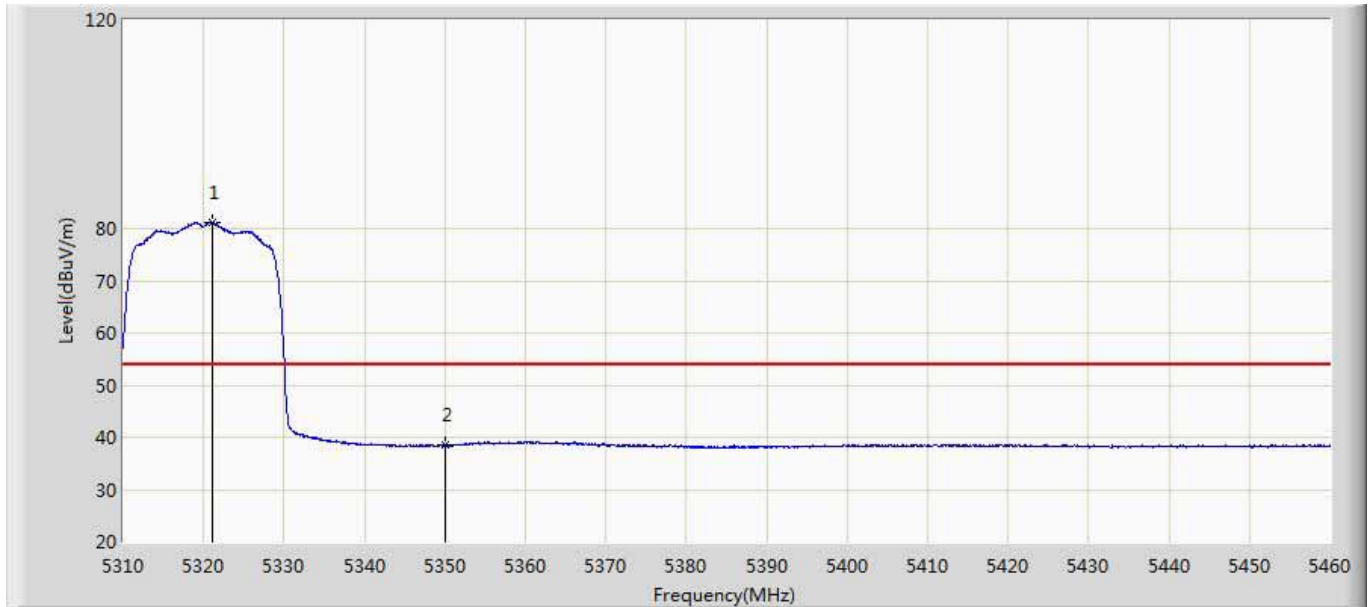

No	Mark	Frequency (MHz)	Measure Level (dBuV/m)	Reading Level (dBuV)	Over Limit (dB)	Limit (dBuV/m)	Factor (dB)	Type
1	*	5321.175	81.047	37.182	N/A	N/A	43.865	AV
2		5350.000	38.470	-5.333	-15.530	54.000	43.803	AV

Engineer: Scott	
Site: AC5	Time: 2015/07/20 - 11:04
Limit: FCC_Part15.209_RE(3m)	Margin: 0
Probe: Horn_3117_00165315(1-18GHz)	Polarity: Vertical
EUT: AB-R1	Power: AC 16V
Note: Mode1: Transmit at CH5320 by 802.11n(20MHz)	

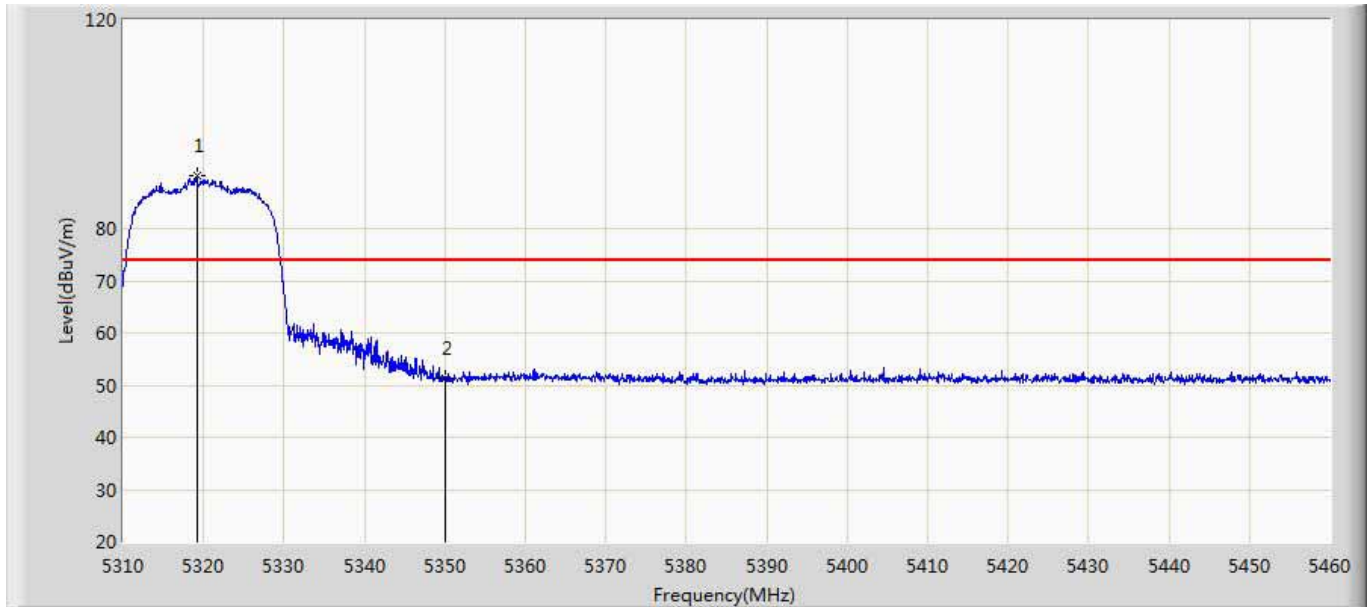

No	Mark	Frequency (MHz)	Measure Level (dBuV/m)	Reading Level (dBuV)	Over Limit (dB)	Limit (dBuV/m)	Factor (dB)	Type
1	*	5319.225	90.049	46.144	N/A	N/A	43.905	PK
2		5350.000	51.335	7.532	-22.665	74.000	43.803	PK



Engineer: Scott	
Site: AC5	Time: 2015/07/20 - 11:07
Limit: FCC_Part15.209_RE(3m)	Margin: 0
Probe: Horn_3117_00165315(1-18GHz)	Polarity: Vertical
EUT: AB-R1	Power: AC 16V
Note: Mode1: Transmit at CH5320 by 802.11n(20MHz)	

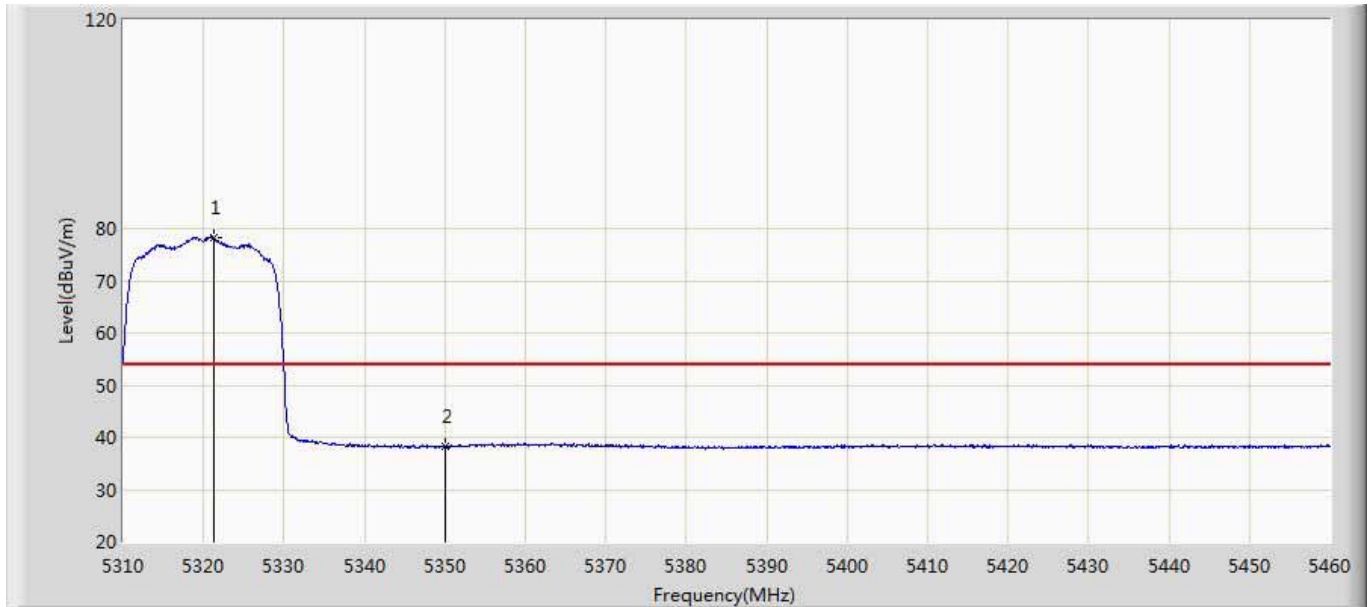

No	Mark	Frequency (MHz)	Measure Level (dBuV/m)	Reading Level (dBuV)	Over Limit (dB)	Limit (dBuV/m)	Factor (dB)	Type
1	*	5321.250	78.300	34.437	N/A	N/A	43.863	AV
2		5350.000	38.299	-5.504	-15.701	54.000	43.803	AV

Engineer: Scott	
Site: AC5	Time: 2015/07/20 - 11:14
Limit: FCC_Part15.209_RE(3m)	Margin: 0
Probe: Horn_3117_00165315(1-18GHz)	Polarity: Horizontal
EUT: AB-R1	Power: AC 16V
Note: Mode1: Transmit at CH5500 by 802.11n(20MHz)	

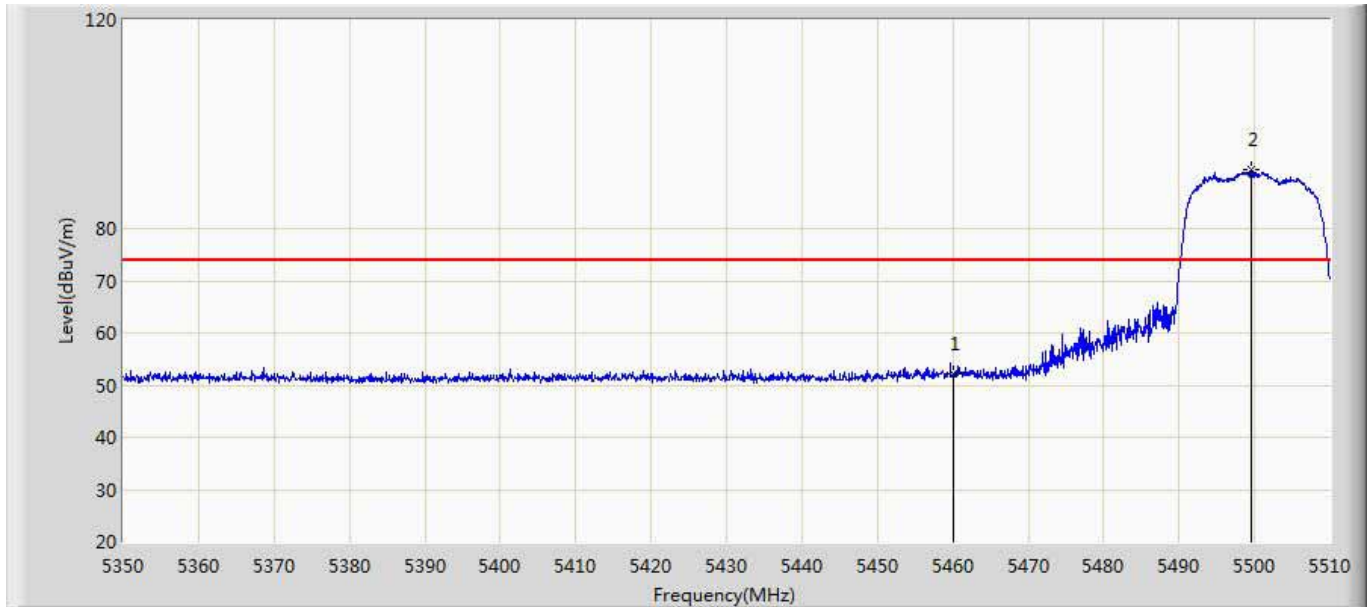

No	Mark	Frequency (MHz)	Measure Level (dBuV/m)	Reading Level (dBuV)	Over Limit (dB)	Limit (dBuV/m)	Factor (dB)	Type
1		5460.000	52.144	8.147	-21.856	74.000	43.997	PK
2	*	5499.600	91.321	47.172	N/A	N/A	44.148	PK

Engineer: Scott	
Site: AC5	Time: 2015/07/20 - 11:19
Limit: FCC_Part15.209_RE(3m)	Margin: 0
Probe: Horn_3117_00165315(1-18GHz)	Polarity: Horizontal
EUT: AB-R1	Power: AC 16V
Note: Mode1: Transmit at CH500 by 802.11n(20MHz)	

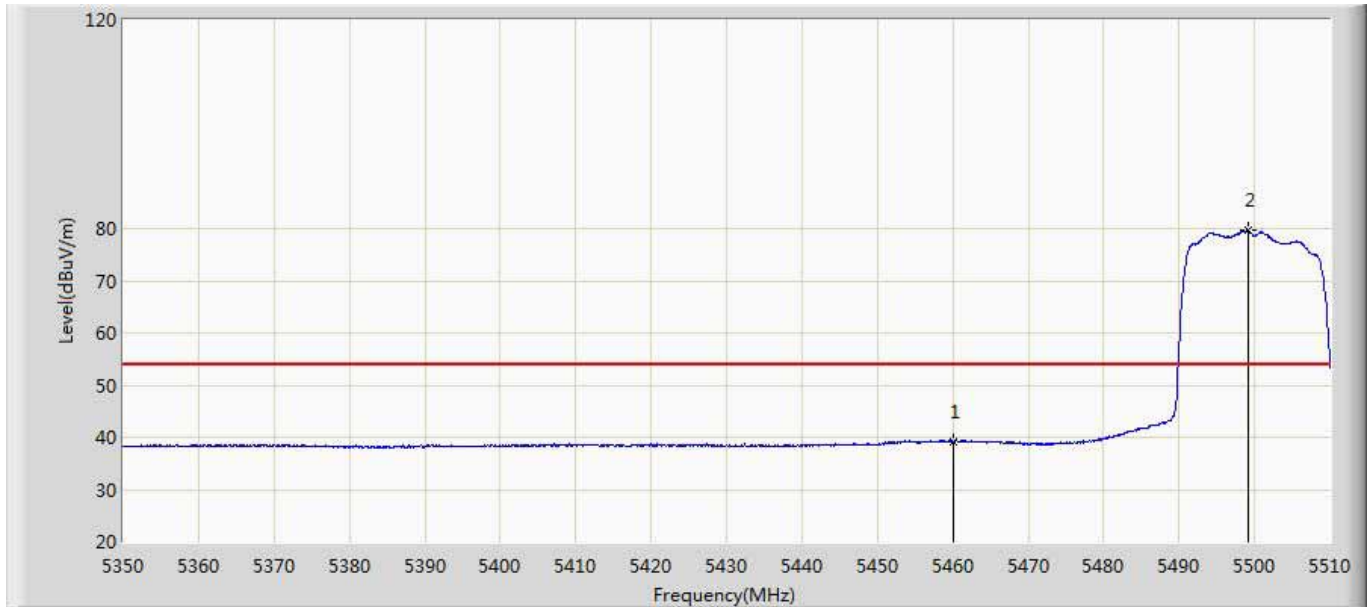

No	Mark	Frequency (MHz)	Measure Level (dBuV/m)	Reading Level (dBuV)	Over Limit (dB)	Limit (dBuV/m)	Factor (dB)	Type
1		5460.000	39.178	-4.819	-14.822	54.000	43.997	AV
2	*	5499.120	79.573	35.424	N/A	N/A	44.149	AV

Engineer: Scott	
Site: AC5	Time: 2015/07/20 - 11:22
Limit: FCC_Part15.209_RE(3m)	Margin: 0
Probe: Horn_3117_00165315(1-18GHz)	Polarity: Vertical
EUT: AB-R1	Power: AC 16V
Note: Mode1: Transmit at CH5500 by 802.11n(20MHz)	

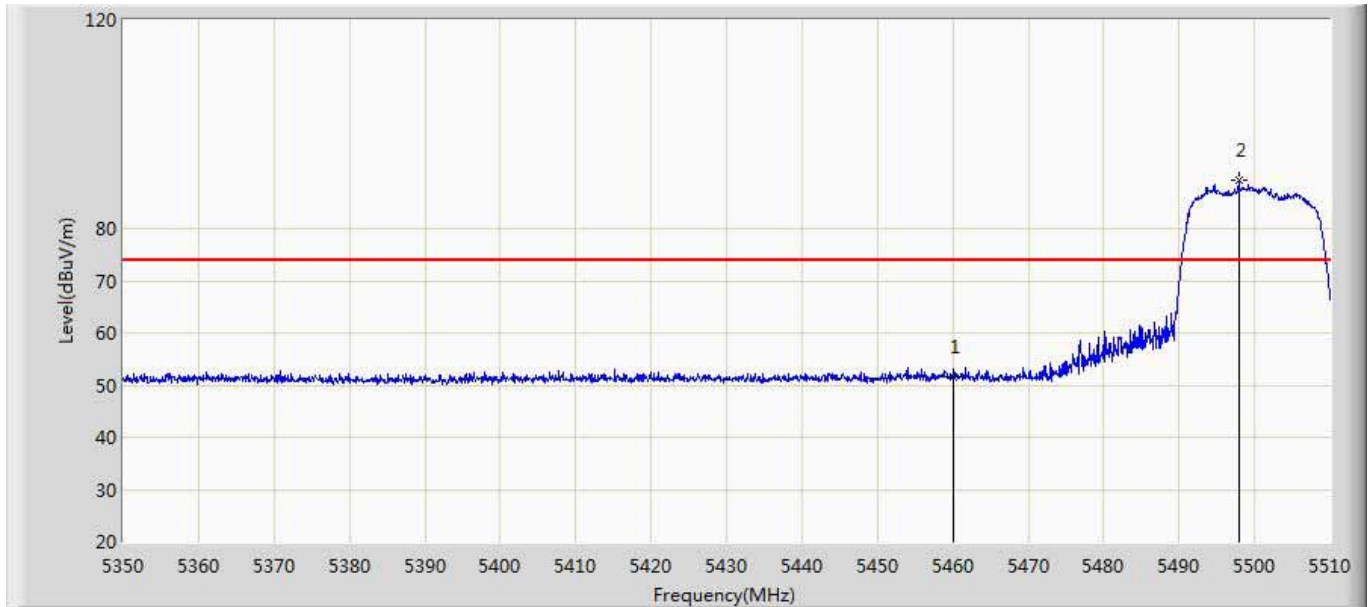

No	Mark	Frequency (MHz)	Measure Level (dBuV/m)	Reading Level (dBuV)	Over Limit (dB)	Limit (dBuV/m)	Factor (dB)	Type
1		5460.000	51.609	7.612	-22.391	74.000	43.997	PK
2	*	5497.920	89.341	45.191	N/A	N/A	44.150	PK

Engineer: Scott	
Site: AC5	Time: 2015/07/20 - 11:26
Limit: FCC_Part15.209_RE(3m)	Margin: 0
Probe: Horn_3117_00165315(1-18GHz)	Polarity: Vertical
EUT: AB-R1	Power: AC 16V
Note: Mode1: Transmit at CH5500 by 802.11n(20MHz)	

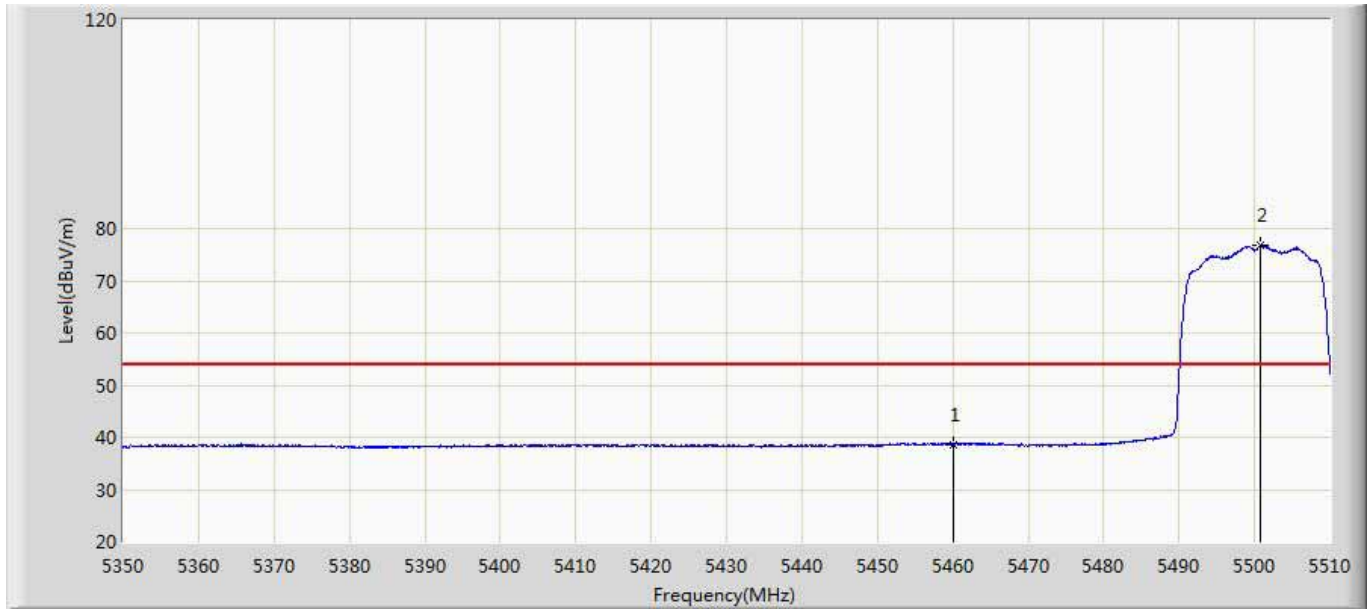

No	Mark	Frequency (MHz)	Measure Level (dBuV/m)	Reading Level (dBuV)	Over Limit (dB)	Limit (dBuV/m)	Factor (dB)	Type
1		5460.000	38.523	-5.474	-15.477	54.000	43.997	AV
2	*	5500.720	76.720	32.572	N/A	N/A	44.148	AV

Engineer: Scott	
Site: AC5	Time: 2015/07/20 - 11:29
Limit: FCC-15.407 new	Margin: 0
Probe: Horn_3117_00165315(1-18GHz)	Polarity: Horizontal
EUT: AB-R1	Power: AC 16V
Note: Mode1: Transmit at CH5745 by 802.11n(20MHz)	

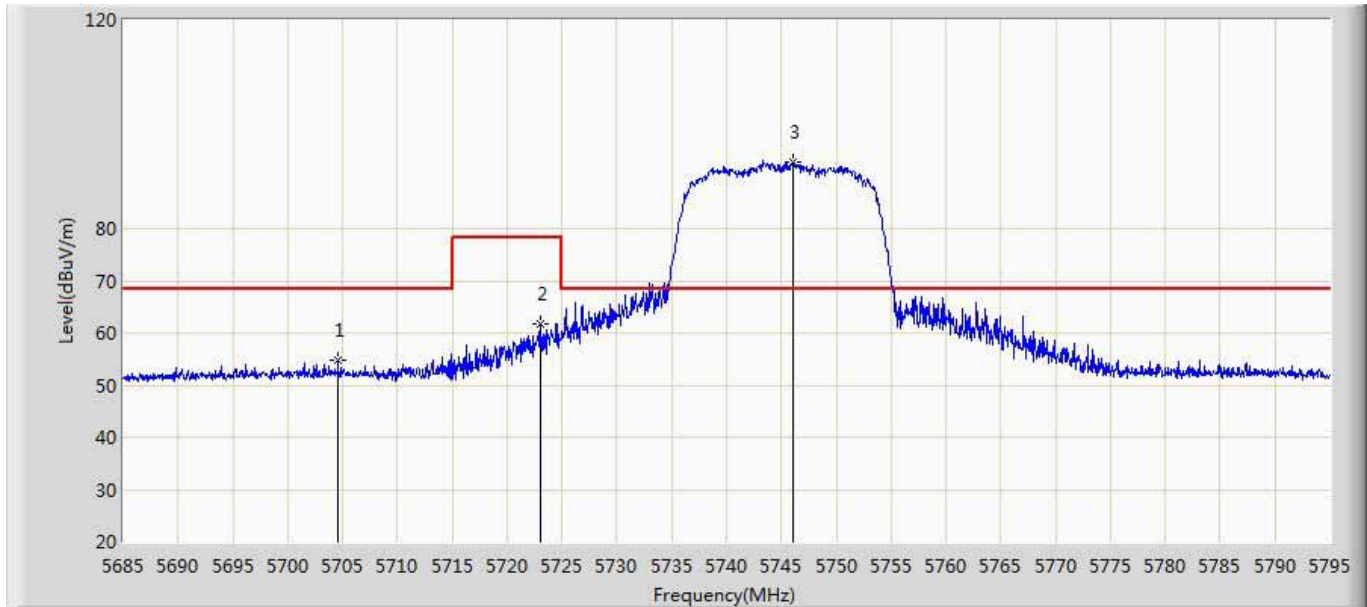

No	Mark	Frequency (MHz)	Measure Level (dBuV/m)	Reading Level (dBuV)	Over Limit (dB)	Limit (dBuV/m)	Factor (dB)	Type
1		5704.580	54.827	10.052	-13.473	68.300	44.775	PK
2		5723.005	61.801	16.984	-16.499	78.300	44.817	PK
3	*	5746.105	92.609	47.685	N/A	N/A	44.923	PK

Engineer: Scott	
Site: AC5	Time: 2015/07/20 - 11:31
Limit: FCC-15.407 new	Margin: 0
Probe: Horn_3117_00165315(1-18GHz)	Polarity: Vertical
EUT: AB-R1	Power: AC 16V
Note: Mode1: Transmit at CH5745 by 802.11n(20MHz)	

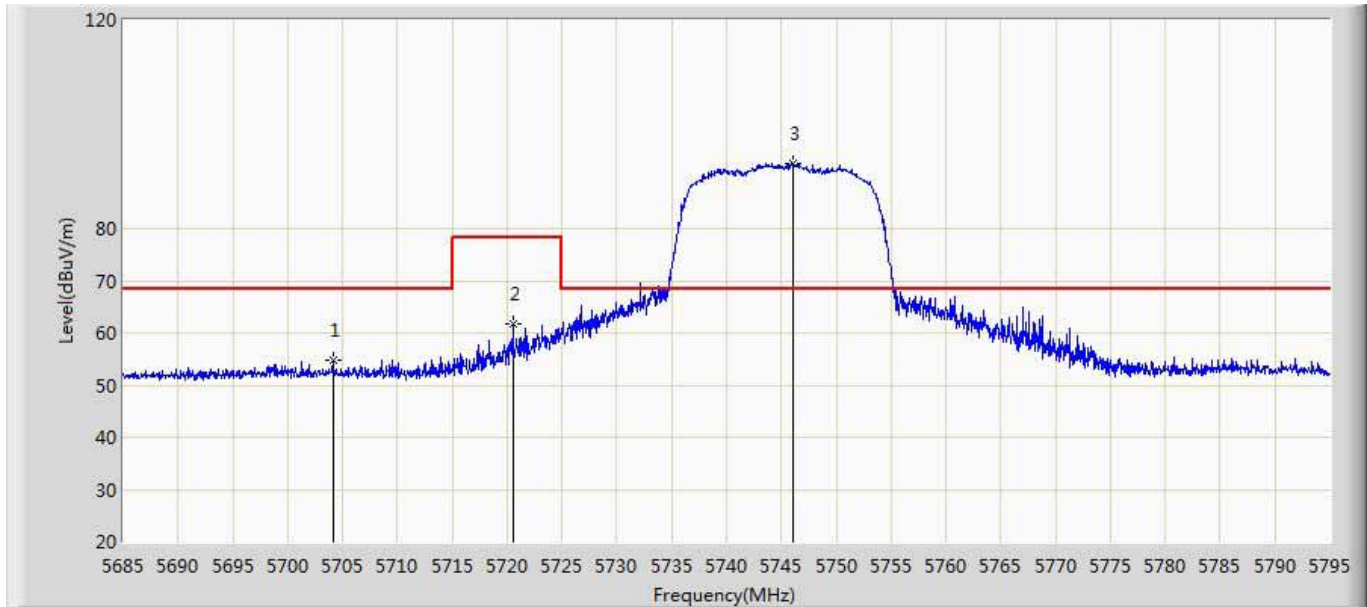

No	Mark	Frequency (MHz)	Measure Level (dBuV/m)	Reading Level (dBuV)	Over Limit (dB)	Limit (dBuV/m)	Factor (dB)	Type
1		5704.140	54.837	10.062	-13.463	68.300	44.775	PK
2		5720.530	61.729	16.920	-16.571	78.300	44.809	PK
3	*	5746.050	92.358	47.434	N/A	N/A	44.924	PK

Engineer: Scott	
Site: AC5	Time: 2015/07/20 - 11:37
Limit: FCC-15.407 new	Margin: 0
Probe: Horn_3117_00165315(1-18GHz)	Polarity: Horizontal
EUT: AB-R1	Power: AC 16V
Note: Mode1: Transmit at CH5825 by 802.11n(20MHz)	

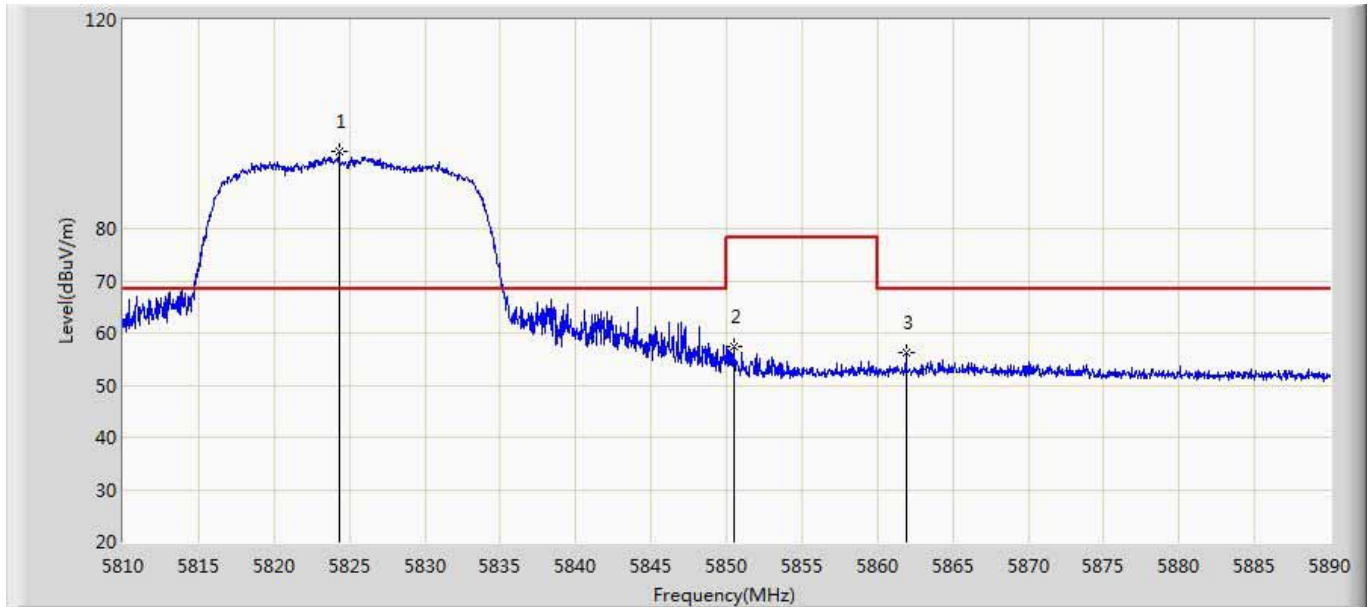

No	Mark	Frequency (MHz)	Measure Level (dBuV/m)	Reading Level (dBuV)	Over Limit (dB)	Limit (dBuV/m)	Factor (dB)	Type
1	*	5824.320	94.644	49.675	N/A	N/A	44.968	PK
2		5850.520	57.494	12.497	-20.806	78.300	44.996	PK
3		5861.880	56.167	11.044	-12.133	68.300	45.123	PK



Engineer: Scott	
Site: AC5	Time: 2015/07/20 - 11:41
Limit: FCC-15.407 new	Margin: 0
Probe: Horn_3117_00165315(1-18GHz)	Polarity: Vertical
EUT: AB-R1	Power: AC 16V
Note: Mode1: Transmit at CH5825 by 802.11n(20MHz)	

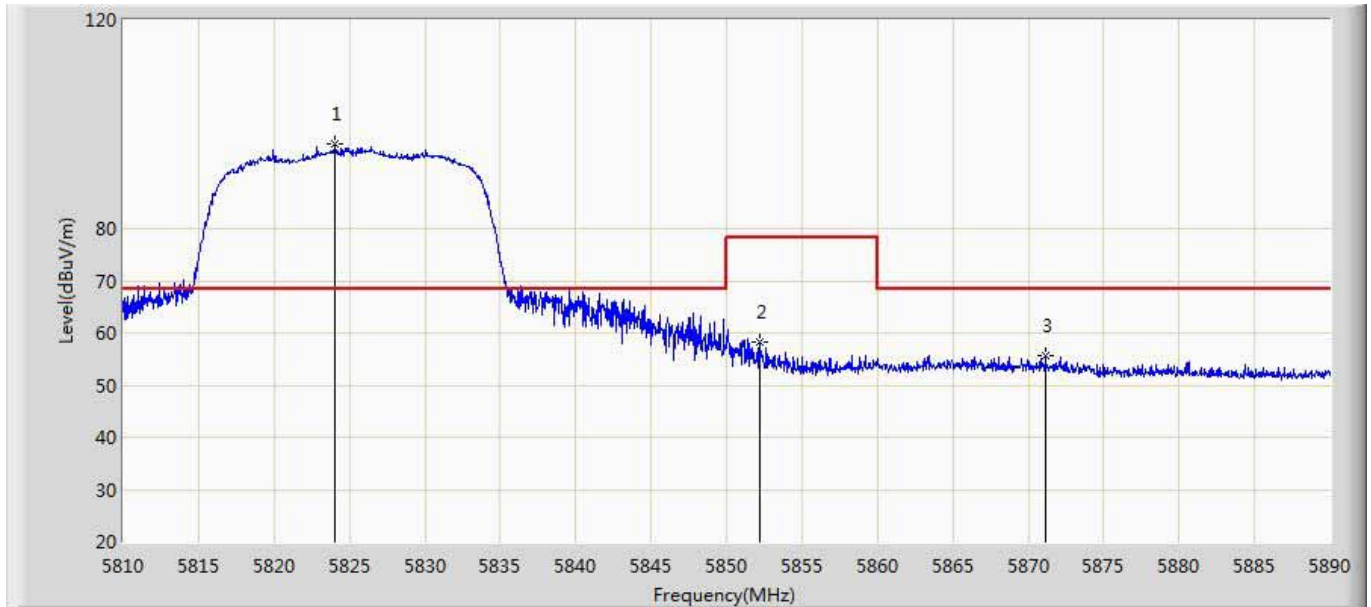

No	Mark	Frequency (MHz)	Measure Level (dBuV/m)	Reading Level (dBuV)	Over Limit (dB)	Limit (dBuV/m)	Factor (dB)	Type
1	*	5824.080	96.331	51.365	N/A	N/A	44.966	PK
2		5852.240	58.129	13.113	-20.171	78.300	45.016	PK
3		5871.160	55.706	10.541	-12.594	68.300	45.165	PK

Engineer: Scott	
Site: AC5	Time: 2015/07/28 - 21:02
Limit: FCC_Part15.209_RE(3m)	Margin: 0
Probe: Horn_3117_00165315(1-18GHz)	Polarity: Horizontal
EUT: AB-R1	Power: AC 16V
Note: Mode1: Transmit at CH5190 by 802.11n(40MHz)	

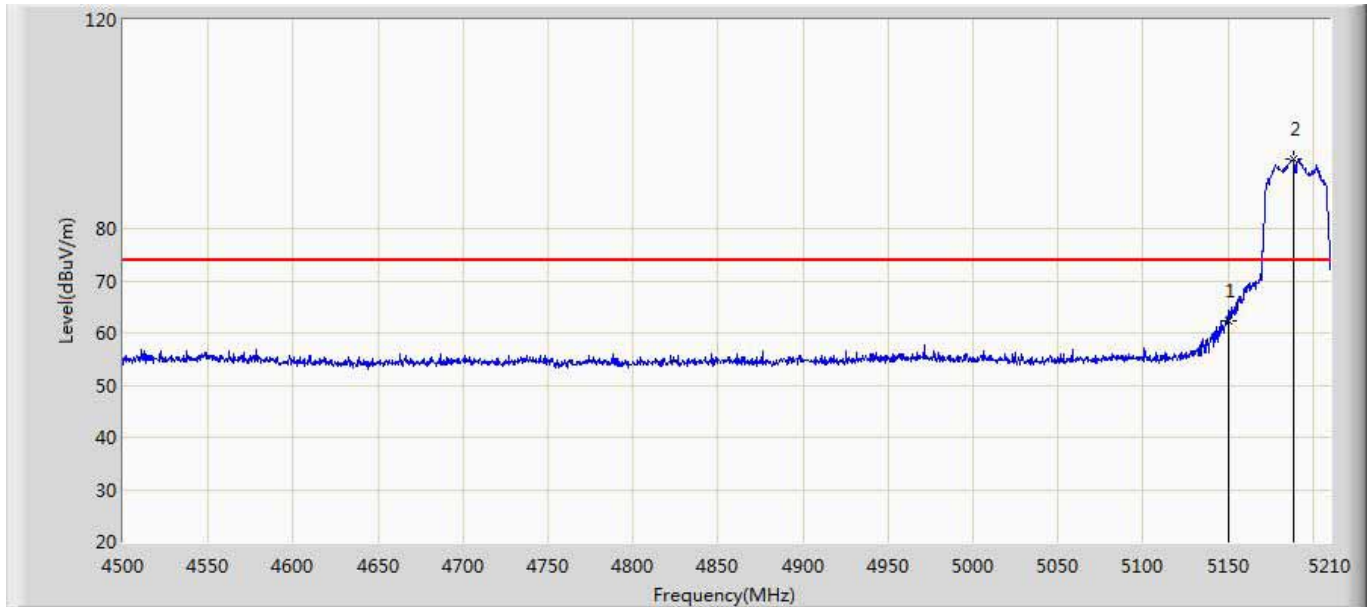

No	Mark	Frequency (MHz)	Measure Level (dBuV/m)	Reading Level (dBuV)	Over Limit (dB)	Limit (dBuV/m)	Factor (dB)	Type
1		5150.000	62.378	18.981	-11.622	74.000	43.397	PK
2	*	5188.345	93.421	49.917	N/A	N/A	43.504	PK

Engineer: Scott	
Site: AC5	Time: 2015/07/28 - 21:03
Limit: FCC_Part15.209_RE(3m)	Margin: 0
Probe: Horn_3117_00165315(1-18GHz)	Polarity: Horizontal
EUT: AB-R1	Power: AC 16V
Note: Mode1: Transmit at CH5190 by 802.11n(40MHz)	

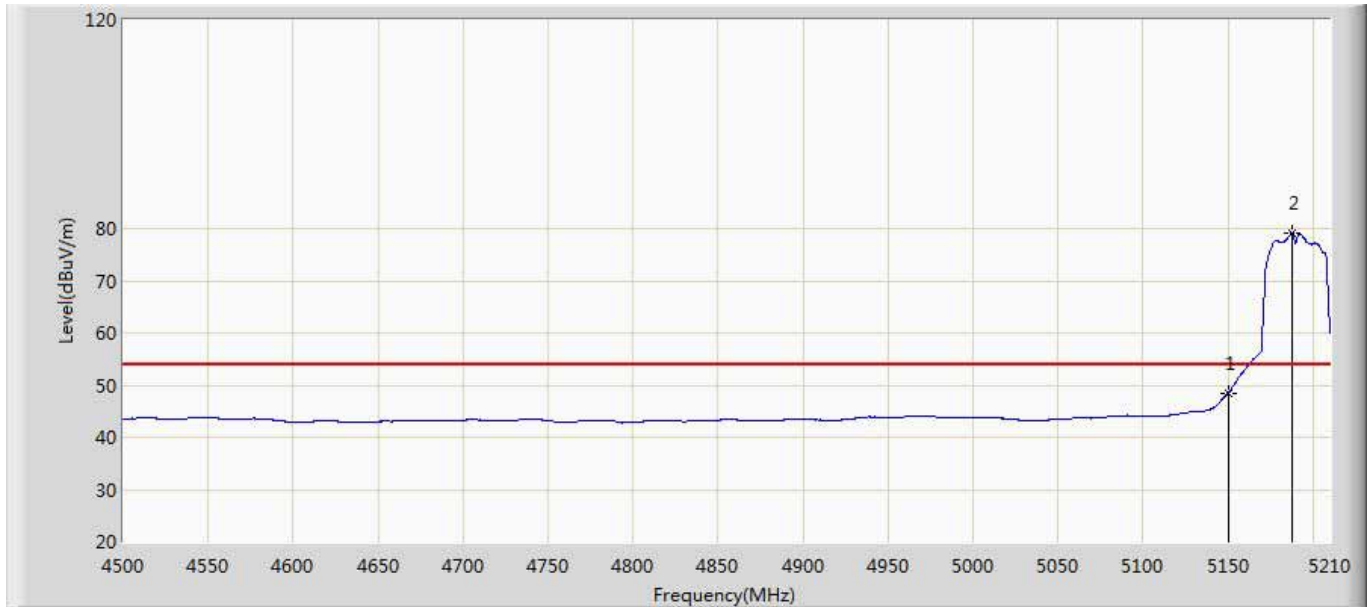

No	Mark	Frequency (MHz)	Measure Level (dBuV/m)	Reading Level (dBuV)	Over Limit (dB)	Limit (dBuV/m)	Factor (dB)	Type
1		5150.000	48.421	5.024	-5.579	54.000	43.397	AV
2	*	5187.635	79.207	35.701	N/A	N/A	43.506	AV

Engineer: Scott	
Site: AC5	Time: 2015/07/28 - 21:07
Limit: FCC_Part15.209_RE(3m)	Margin: 0
Probe: Horn_3117_00165315(1-18GHz)	Polarity: Vertical
EUT: AB-R1	Power: AC 16V
Note: Mode1: Transmit at CH5190 by 802.11n(40MHz)	

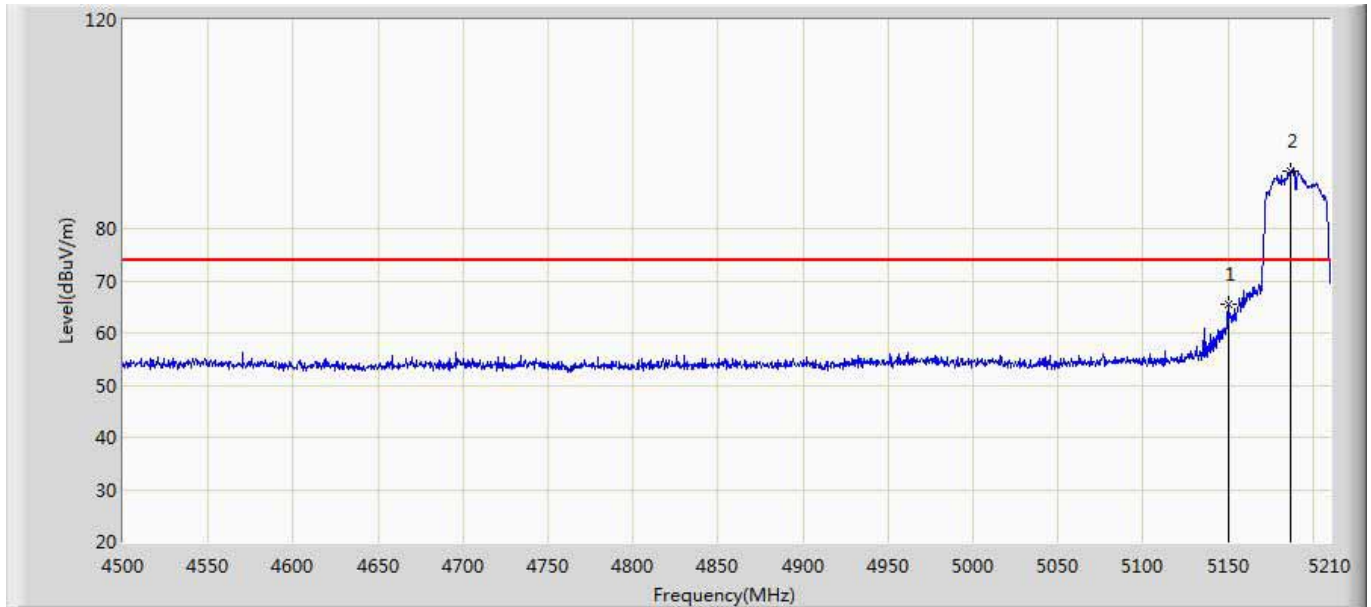

No	Mark	Frequency (MHz)	Measure Level (dBuV/m)	Reading Level (dBuV)	Over Limit (dB)	Limit (dBuV/m)	Factor (dB)	Type
1		5150.000	65.528	22.131	-8.472	74.000	43.397	PK
2	*	5187.280	90.984	47.477	N/A	N/A	43.507	PK

Engineer: Scott	
Site: AC5	Time: 2015/07/28 - 21:08
Limit: FCC_Part15.209_RE(3m)	Margin: 0
Probe: Horn_3117_00165315(1-18GHz)	Polarity: Vertical
EUT: AB-R1	Power: AC 16V
Note: Mode1: Transmit at CH5190 by 802.11(n(40MHz))	

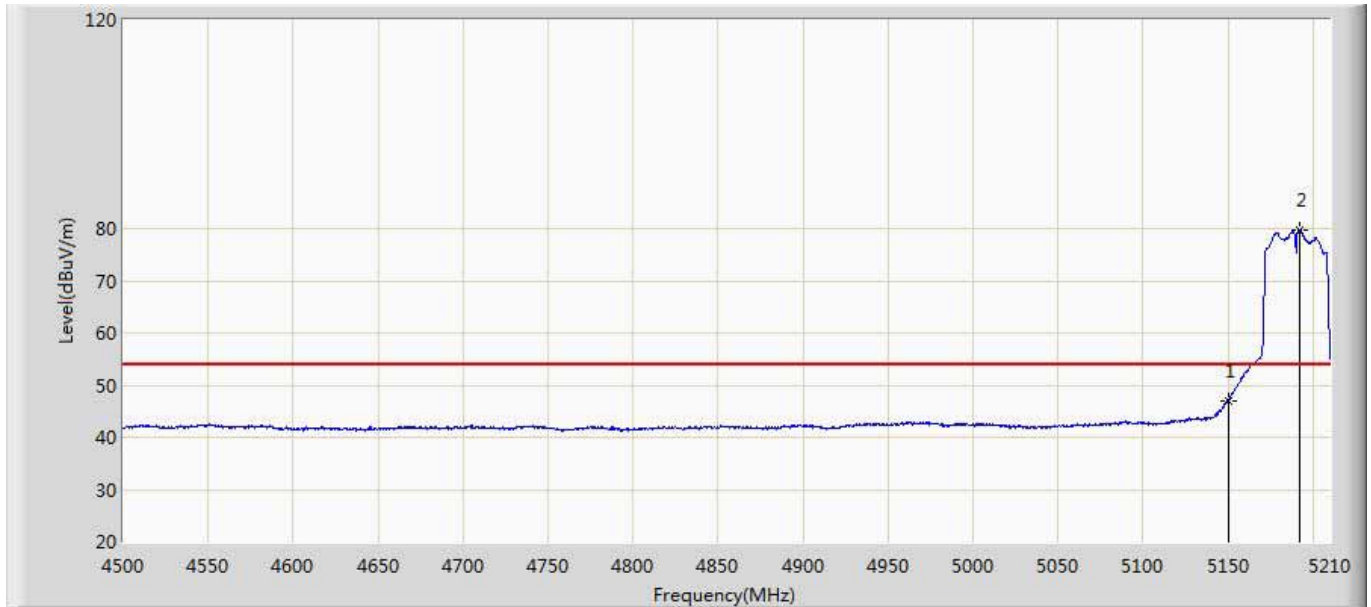

No	Mark	Frequency (MHz)	Measure Level (dBuV/m)	Reading Level (dBuV)	Over Limit (dB)	Limit (dBuV/m)	Factor (dB)	Type
1		5150.000	47.008	3.611	-6.992	54.000	43.397	AV
2	*	5191.895	79.815	36.321	N/A	N/A	43.494	AV

Engineer: Scott	
Site: AC5	Time: 2015/07/28 - 21:13
Limit: FCC_Part15.209_RE(3m)	Margin: 0
Probe: Horn_3117_00165315(1-18GHz)	Polarity: Horizontal
EUT: AB-R1	Power: AC 16V
Note: Mode1: Transmit at CH5310 by 802.11n(40MHz)	

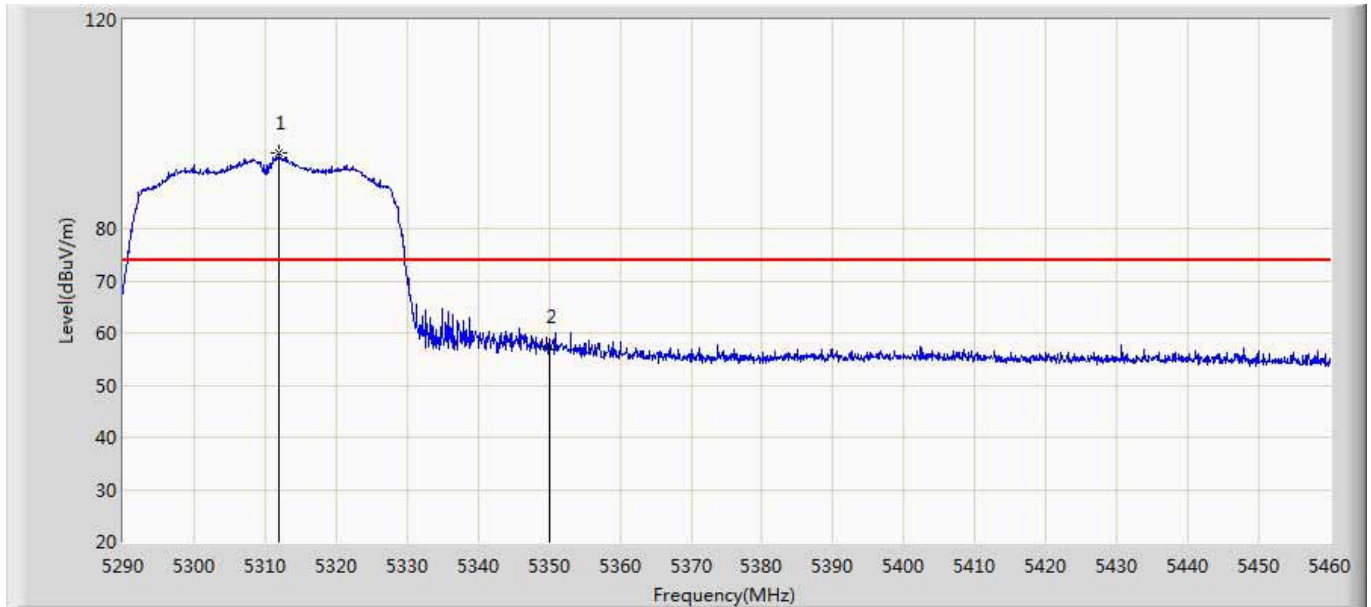

No	Mark	Frequency (MHz)	Measure Level (dBuV/m)	Reading Level (dBuV)	Over Limit (dB)	Limit (dBuV/m)	Factor (dB)	Type
1	*	5312.015	94.407	50.508	N/A	N/A	43.898	PK
2		5350.000	57.425	13.622	-16.575	74.000	43.803	PK

Engineer: Scott	
Site: AC5	Time: 2015/07/28 - 21:14
Limit: FCC_Part15.209_RE(3m)	Margin: 0
Probe: Horn_3117_00165315(1-18GHz)	Polarity: Horizontal
EUT: AB-R1	Power: AC 16V
Note: Mode1: Transmit at CH5310 by 802.11n(40MHz)	

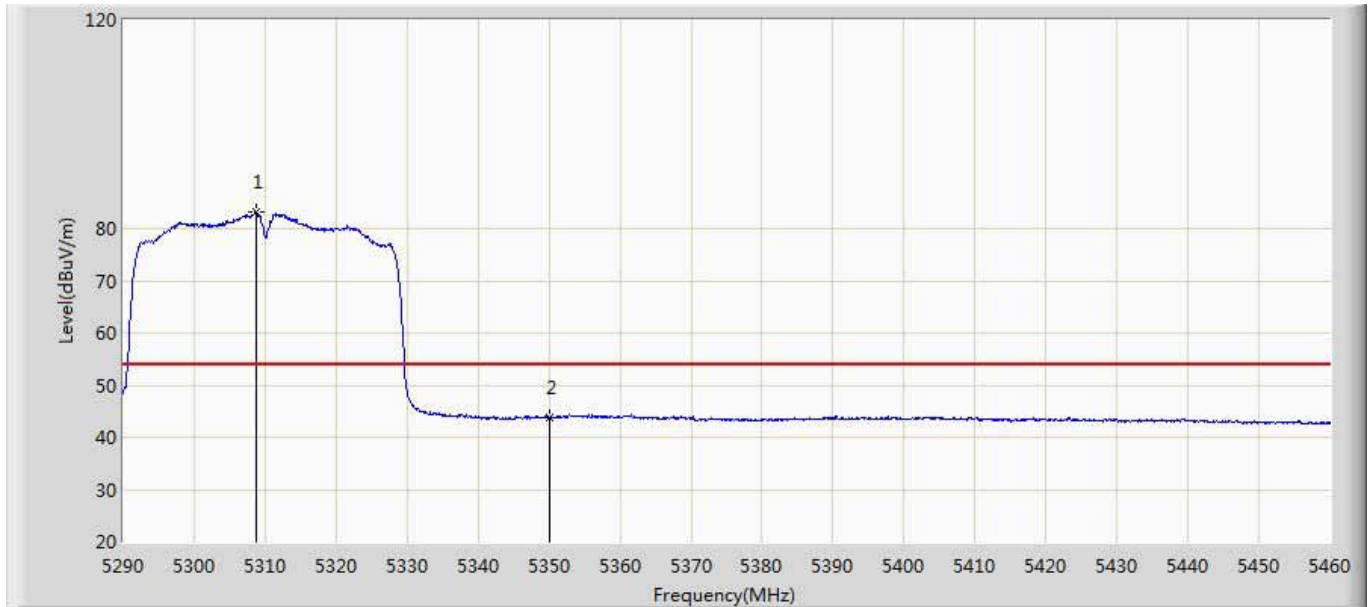

No	Mark	Frequency (MHz)	Measure Level (dBuV/m)	Reading Level (dBuV)	Over Limit (dB)	Limit (dBuV/m)	Factor (dB)	Type
1	*	5308.785	83.246	39.364	N/A	N/A	43.882	AV
2		5350.000	43.839	0.036	-10.161	54.000	43.803	AV

Engineer: Scott	
Site: AC5	Time: 2015/07/28 - 21:17
Limit: FCC_Part15.209_RE(3m)	Margin: 0
Probe: Horn_3117_00165315(1-18GHz)	Polarity: Vertical
EUT: AB-R1	Power: AC 16V
Note: Mode1: Transmit at CH5310 by 802.11n(40MHz)	

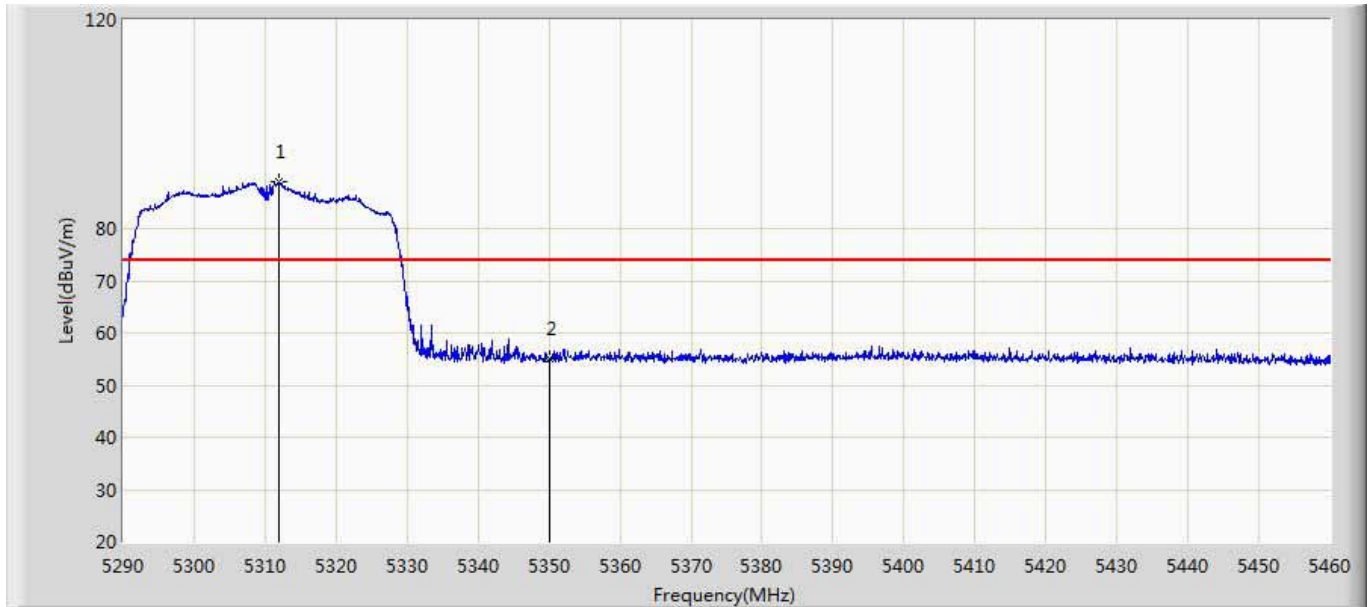

No	Mark	Frequency (MHz)	Measure Level (dBuV/m)	Reading Level (dBuV)	Over Limit (dB)	Limit (dBuV/m)	Factor (dB)	Type
1	*	5311.845	88.846	44.948	N/A	N/A	43.898	PK
2		5350.000	55.030	11.227	-18.970	74.000	43.803	PK



Engineer: Scott	
Site: AC5	Time: 2015/07/28 - 21:17
Limit: FCC_Part15.209_RE(3m)	Margin: 0
Probe: Horn_3117_00165315(1-18GHz)	Polarity: Vertical
EUT: AB-R1	Power: AC 16V
Note: Mode1: Transmit at CH5310 by 802.11n(40MHz)	

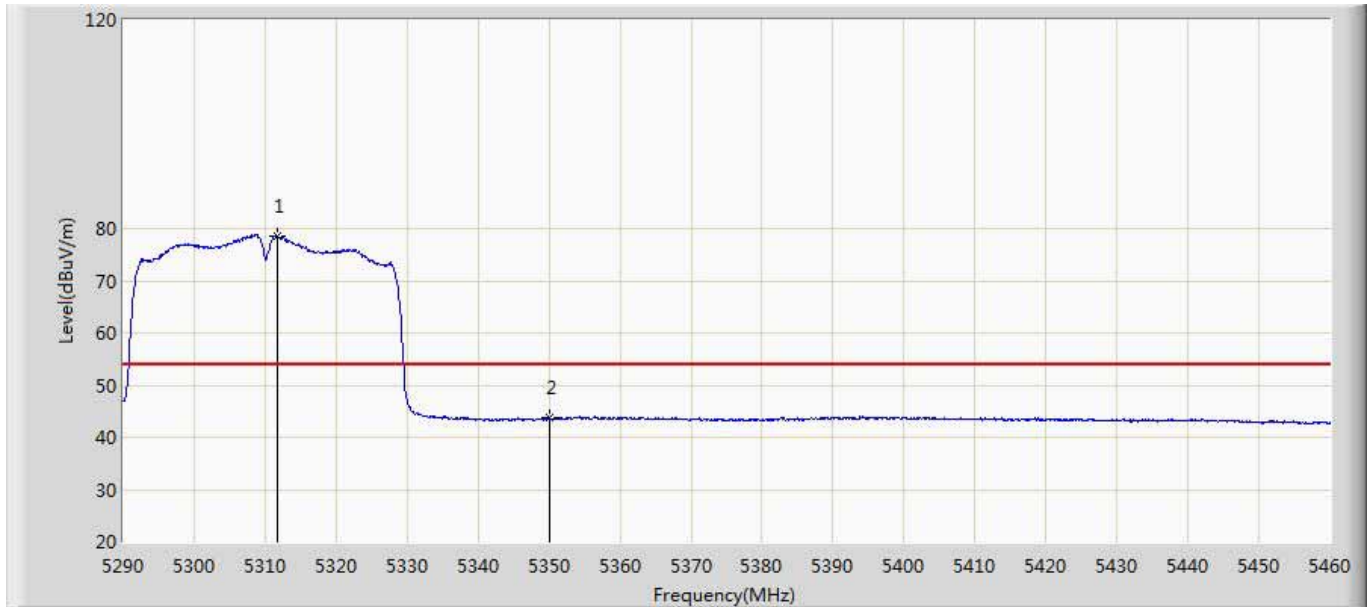

No	Mark	Frequency (MHz)	Measure Level (dBuV/m)	Reading Level (dBuV)	Over Limit (dB)	Limit (dBuV/m)	Factor (dB)	Type
1	*	5311.760	78.573	34.676	N/A	N/A	43.897	AV
2		5350.000	43.724	-0.079	-10.276	54.000	43.803	AV

Engineer: Scott	
Site: AC5	Time: 2015/07/28 - 21:22
Limit: FCC-15.407 new	Margin: 0
Probe: Horn_3117_00165315(1-18GHz)	Polarity: Horizontal
EUT: AB-R1	Power: AC 16V
Note: Mode1: Transmit at CH5755 by 802.11n(40MHz)	

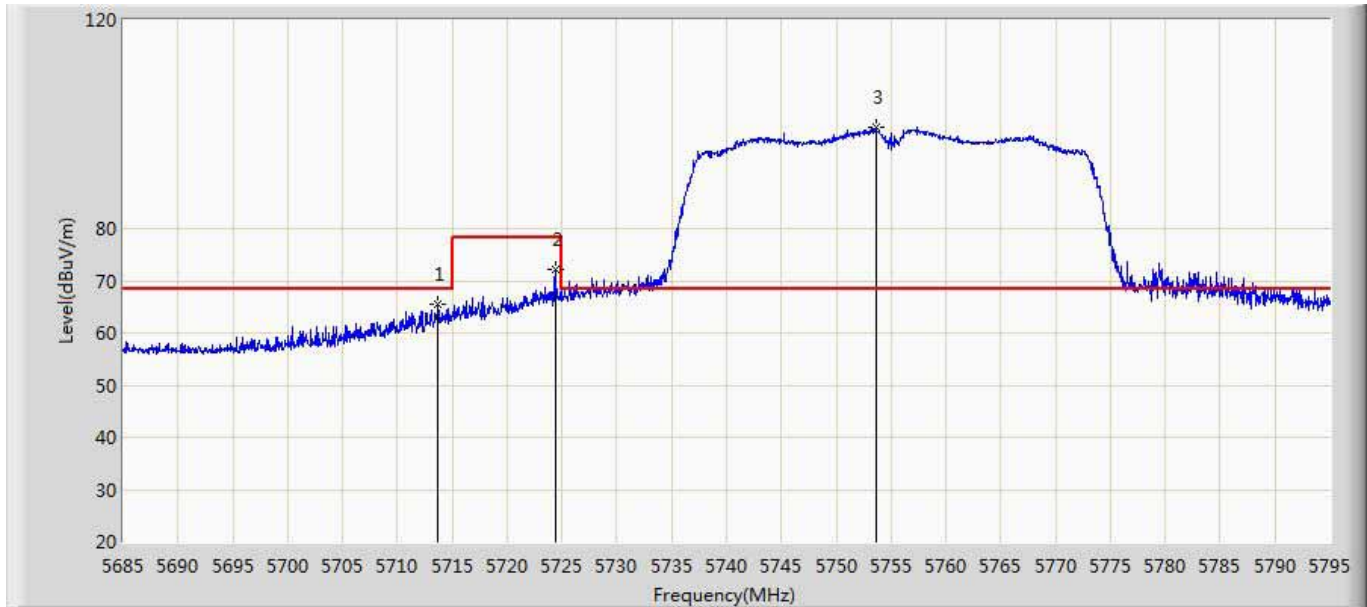

No	Mark	Frequency (MHz)	Measure Level (dBuV/m)	Reading Level (dBuV)	Over Limit (dB)	Limit (dBuV/m)	Factor (dB)	Type
1		5713.710	65.518	20.730	-2.782	68.300	44.788	PK
2		5724.380	72.301	27.480	-5.999	78.300	44.821	PK
3	*	5753.640	99.429	54.604	N/A	N/A	44.825	PK

Engineer: Scott	
Site: AC5	Time: 2015/07/28 - 21:24
Limit: FCC-15.407 new	Margin: 0
Probe: Horn_3117_00165315(1-18GHz)	Polarity: Vertical
EUT: AB-R1	Power: AC 16V
Note: Mode1: Transmit at CH5755 by 802.11n(40MHz)	

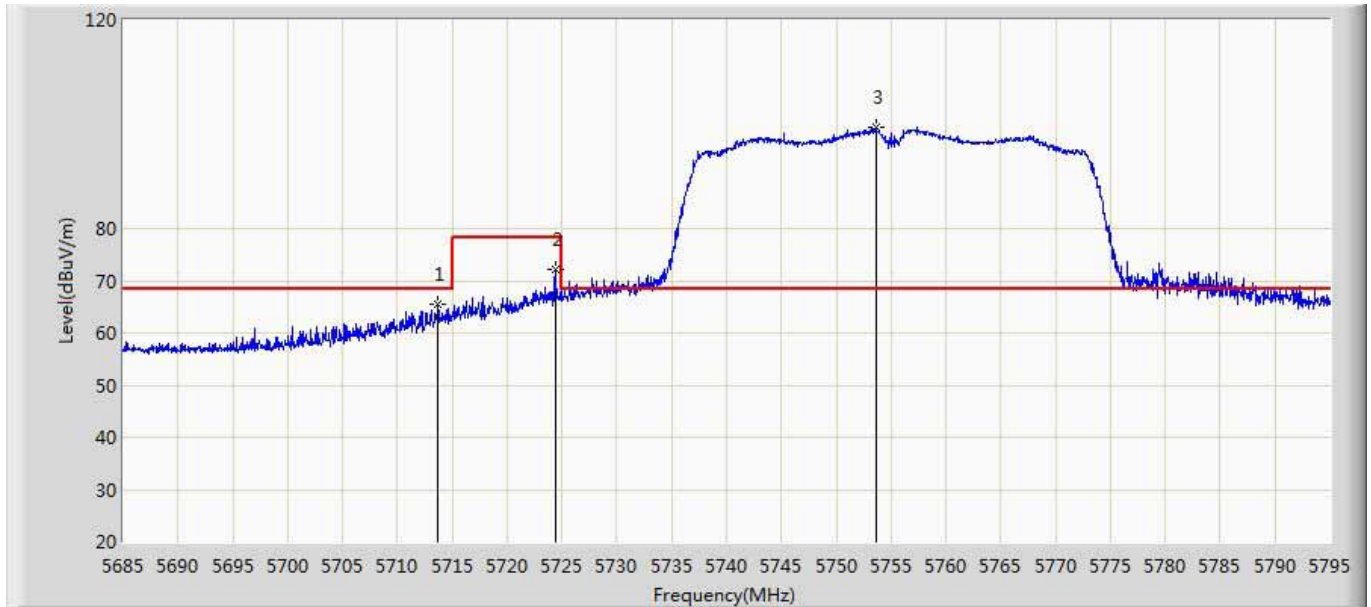

No	Mark	Frequency (MHz)	Measure Level (dBuV/m)	Reading Level (dBuV)	Over Limit (dB)	Limit (dBuV/m)	Factor (dB)	Type
1		5713.710	65.518	20.730	-2.782	68.300	44.788	PK
2		5724.380	72.301	27.480	-5.999	78.300	44.821	PK
3	*	5753.640	99.429	54.604	N/A	N/A	44.825	PK

## 10. Frequency Stability

### 10.1. Test Equipment

Frequency Stability / TR-8

Instrument	Manufacturer	Type No.	Serial No.	Cali. Due Date
Spectrum Analyzer	Agilent	E4446A	MY45300103	2016.01.07
AC Power Supply	IDRC	CF-500TP	979422	2015.09.16
DC Power Supply	IDRC	CD-035-020PR	977272	2015.09.16 </td
Programmable Temperature & Humidity Chamber	Gaoyu	TH-1P-B	WIT-05121302	2016.01.07
Temperature/Humidity Meter	zhicheng	ZC1-2	TR8-TH	2016.04.09

Note: All equipments are calibrated with traceable calibrations. Each calibration is traceable to the national or international standards.

### 10.2. Test Setup

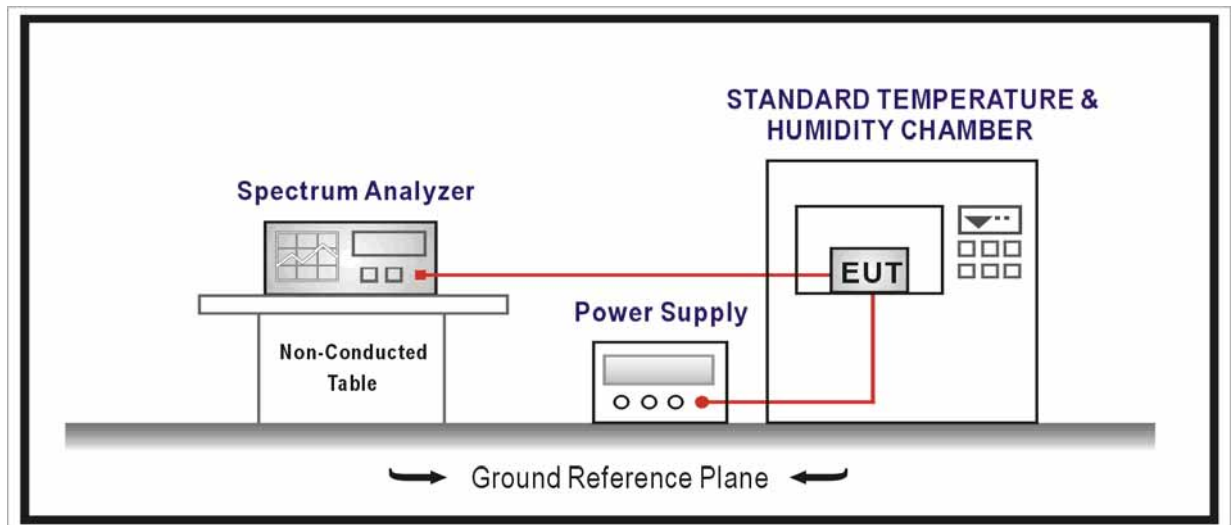

### 10.3. Limit

For FCC&IC

Manufactures of U-NII devices are responsible for ensuring frequency stability such that an emission is maintained within the band of operation under all conditions of normal operation as specified in the user's manual.

## 10.4. Test Procedure

### **Frequency Stability Under Temperature Variations:**

The equipment under test was connected to an external AC or DC power supply and input rated voltage. RF output was connected to a frequency counter or spectrum analyzer via feed through attenuators. The EUT was placed inside the temperature chamber. Set the spectrum analyzer RBW low enough to obtain the desired frequency resolution and measure EUT 20°C operating frequency as reference frequency. Turn EUT off and set the chamber temperature to highest. After the temperature stabilized for approximately 30 minutes recorded the frequency. Repeat step measure with 10°C decreased per stage until the lowest temperature reached.

### **Frequency Stability Under Voltage Variations:**

Set chamber temperature to 20°C. Use a variable AC power supply / DC power source to power the EUT and set the voltage to rated voltage. Set the spectrum analyzer RBW low enough to obtain the desired frequency resolution and recorded the frequency.

Reduce the input voltage to specify extreme voltage variation ( $\pm 15\%$ ) and endpoint, record the maximum frequency change.

## 10.5. Uncertainty

The measurement uncertainty is defined as  $\pm 100$  Hz

**10.6. Test Result**

Product	:	AB-R1
Test Item	:	Frequency Stability
Test Site	:	TR-8
Test Mode	:	Carrier Transmit

Frequency Stability under Temperature

Temperature Interval (°C)	Test Frequency (MHz)	Deviation (Hz)
-30	5200.000	-189
-20	5200.000	179
-10	5200.000	-251
0	5200.000	-321
10	5200.000	148
20	5200.000	-177
30	5200.000	165
40	5200.000	164
50	5200.000	-163

Frequency Stability under Voltage

DC Voltage (V)	Test Frequency (MHz)	Deviation (Hz)
3.3	836.40	154
3.6	836.40	132
4.3	836.40	142

Frequency Stability under Temperature

Temperature Interval (°C)	Test Frequency (MHz)	Deviation (Hz)
-30	5300.000	-144
-20	5300.000	136
-10	5300.000	-145
0	5300.000	-211
10	5300.000	136
20	5300.000	142
30	5300.000	143
40	5300.000	152
50	5300.000	-112

Frequency Stability under Voltage

DC Voltage (V)	Test Frequency (MHz)	Deviation (Hz)
3.3	5300.000	147
3.6	5300.000	-120
4.3	5300.000	98

Frequency Stability under Temperature

Temperature Interval (°C)	Test Frequency (MHz)	Deviation (Hz)
-30	5600.000	-139
-20	5600.000	142
-10	5600.000	-112
0	5600.000	-135
10	5600.000	121
20	5600.000	125
30	5600.000	136
40	5600.000	147
50	5600.000	-113

Frequency Stability under Voltage

DC Voltage (V)	Test Frequency (MHz)	Deviation (Hz)
3.3	5600.000	142
3.6	5600.000	-139
4.3	5600.000	251



Frequency Stability under Temperature

Temperature Interval (°C)	Test Frequency (MHz)	Deviation (Hz)
-30	5805.000	-132
-20	5805.000	135
-10	5805.000	-106
0	5805.000	-128
10	5805.000	115
20	5805.000	119
30	5805.000	129
40	5805.000	140
50	5805.000	-107

Frequency Stability under Voltage

DC Voltage (V)	Test Frequency (MHz)	Deviation (Hz)
3.3	5805.000	98
3.6	5805.000	-109
4.3	5805.000	111

— The End —