



# **FCC RADIO TEST REPORT**

## **FCC ID: 2AB6HPCD-42B**

**Product** : Car audio combine machine

**Trade Name** : Power Acoustik / SOUNDSTREAM

**Model Number** : PCD-42B

**Serial Model** : VCD-32B

**Report No.** : BZT-140422022F

### **Prepared for**

ShenZhen Meicanxin Electronics Technology Co., Ltd.  
4th Floor, Building 3rd, JuHui industrial zone, TianLiao Community, GongMing,  
Guang Ming new district, ShenZhen, China

### **Prepared by**

BZT Testing Technology Co., Ltd.  
1/F, Building E, Fenda Science Park, Sanwei Community, Xixiang Street  
Bao'an District, Shenzhen P.R. China

**TEST RESULT CERTIFICATION**

**Applicant's name** ..... ShenZhen Meicanxin Electronics Technology Co., Ltd.  
Address..... 4th Floor, Building 3rd,JuHui industrial zone, TianLiao Community,  
GongMing, Guang Ming new district, ShenZhen, China

**Manufacture's Name** ..... ShenZhen Meicanxin Electronics Technology Co., Ltd.  
Address..... 4th Floor, Building 3rd,JuHui industrial zone, TianLiao Community,  
GongMing, Guang Ming new district, ShenZhen, China

**Product description**

Product name..... Car audio combine machine

Model and/or type reference ..... PCD-42B

Serial Model : VCD-32B

Ratings DC 12V from battery

**Standards** ..... FCC Part15.247

Test procedure ..... ANSI C63.4-2003

This device described above has been tested by BZT, and the test results show that the equipment under test (EUT) is in compliance with the FCC requirements. And it is applicable only to the tested sample identified in the report.

This report shall not be reproduced except in full, without the written approval of BZT, this document may be altered or revised by BZT, personal only, and shall be noted in the revision of the document.

**Date of Test**.....

Date (s) of performance of tests ..... 21 Mar. 2014 ~28 Mar. 2014

Date of Issue..... 29 Mar. 2014

Test Result ..... **Pass**

Testing Engineer : Apple Huang  
(Apple Huang)

Technical Manager : Tom Zhang  
(Tom Zhang)

Authorized Signatory : Bovey Yang  
(Bovey Yang)

**Table of Contents**

	<b>Page</b>
<b>1 . SUMMARY OF TEST RESULTS</b>	<b>5</b>
1.1 TEST FACILITY	6
1.2 MEASUREMENT UNCERTAINTY	6
<b>2 . GENERAL INFORMATION</b>	<b>7</b>
2.1 GENERAL DESCRIPTION OF EUT	7
2.2 DESCRIPTION OF TEST MODES	9
2.3 TABLE OF PARAMETERS OF TEXT SOFTWARE SETTING	9
2.4 BLOCK DIGRAM SHOWING THE CONFIGURATION OF SYSTEM TESTED	10
2.5 DESCRIPTION OF SUPPORT UNITS(CONDUCTED MODE)	11
2.6 EQUIPMENTS LIST FOR ALL TEST ITEMS	12
<b>3 . EMC EMISSION TEST</b>	<b>13</b>
3.1 CONDUCTED EMISSION MEASUREMENT	13
3.1.1 POWER LINE CONDUCTED EMISSION LIMITS	13
3.1.2 TEST PROCEDURE	14
3.1.3 DEVIATION FROM TEST STANDARD	14
3.1.4 TEST SETUP	14
3.1.5 EUT OPERATING CONDITIONS	14
3.1.6 TEST RESULTS	15
3.2 RADIATED EMISSION MEASUREMENT	16
3.2.1 RADIATED EMISSION LIMITS	16
3.2.2 TEST PROCEDURE	17
3.2.3 DEVIATION FROM TEST STANDARD	17
3.2.4 TEST SETUP	18
3.2.5 EUT OPERATING CONDITIONS	19
3.2.6 TEST RESULTS (BELOW 30 MHZ)	20
3.2.7 TEST RESULTS (BETWEEN 30M – 1000 MHZ)	21
3.2.8 TEST RESULTS (ABOVE 1000 MHZ)	23
3.2.9 TEST RESULTS (RESTRICTED BANDS REQUIREMENTS)	26
<b>4 . NUMBER OF HOPPING CHANNEL</b>	<b>34</b>
4.1 APPLIED PROCEDURES / LIMIT	34
4.1.1 TEST PROCEDURE	34
4.1.2 DEVIATION FROM STANDARD	34
4.1.3 TEST SETUP	34
4.1.4 EUT OPERATION CONDITIONS	34
4.1.5 TEST RESULTS	35
<b>5 . AVERAGE TIME OF OCCUPANCY</b>	<b>36</b>
5.1 APPLIED PROCEDURES / LIMIT	36

**Table of Contents**

	<b>Page</b>
5.1.1 TEST PROCEDURE	36
5.1.2 DEVIATION FROM STANDARD	36
5.1.3 TEST SETUP	36
5.1.4 EUT OPERATION CONDITIONS	36
5.1.5 TEST RESULTS	37
<b>6 . HOPPING CHANNEL SEPARATION MEASUREMENT</b>	<b>38</b>
6.1 APPLIED PROCEDURES / LIMIT	38
6.1.1 TEST PROCEDURE	38
6.1.2 DEVIATION FROM STANDARD	38
6.1.3 TEST SETUP	38
6.1.4 EUT OPERATION CONDITIONS	38
6.1.5 TEST RESULTS	39
<b>7 . BANDWIDTH TEST</b>	<b>41</b>
7.1 APPLIED PROCEDURES / LIMIT	41
7.1.1 TEST PROCEDURE	41
7.1.2 DEVIATION FROM STANDARD	41
7.1.3 TEST SETUP	41
7.1.4 EUT OPERATION CONDITIONS	41
7.1.5 TEST RESULTS	42
<b>8 . PEAK OUTPUT POWER TEST</b>	<b>44</b>
8.1 APPLIED PROCEDURES / LIMIT	44
8.1.1 TEST PROCEDURE	44
8.1.2 DEVIATION FROM STANDARD	44
8.1.3 TEST SETUP	44
8.1.4 EUT OPERATION CONDITIONS	44
8.1.5 TEST RESULTS	45
<b>9 . ANTENNA REQUIREMENT</b>	<b>46</b>
9.1 STANDARD REQUIREMENT	46
9.2 EUT ANTENNA	46
<b>10 . EUT TEST PHOTO</b>	<b>47</b>
<b>APPENDIX-PHOTOGRAPHS OF EUT CONSTRUCTIONAL DETAILS</b>	

### 1. SUMMARY OF TEST RESULTS

Test procedures according to the technical standards:

FCC Part15 (15.247) , Subpart C			
Standard Section	Test Item	Judgment	Remark
15.207	Conducted Emission	N/A	
15.247(a)(1)	Hopping Channel Separation	PASS	
15.247(b)(1)	Peak Output Power	PASS	
15.247(c)	Radiated Spurious Emission	PASS	
15.247(a)(iii)	Number of Hopping Frequency	PASS	
15.247(a)(iii)	Dwell Time	PASS	
15.247(a)(1)	Bandwidth	PASS	
15.205	Band Edge Emission	PASS	
15.203	Antenna Requirement	PASS	

**NOTE:**

(1) "N/A" denotes test is not applicable in this Test Report

## 1.1 TEST FACILITY

BZT Testing Technology Co., Ltd

Add. : 1/F, Building E, Fenda Science Park, Sanwei Community, Xixiang Street, Bao'an District, Shenzhen P.R. China.

FCC Registration No.: 701733

## 1.2 MEASUREMENT UNCERTAINTY

The reported uncertainty of measurement  $y \pm U$ , where expanded uncertainty  $U$  is based on a standard uncertainty multiplied by a coverage factor of  $k=2$ , providing a level of confidence of approximately **95 %**.

No.	Item	Uncertainty
1	Conducted Emission Test	$\pm 1.38\text{dB}$
2	RF power,conducted	$\pm 0.16\text{dB}$
3	Spurious emissions,conducted	$\pm 0.21\text{dB}$
4	All emissions,radiated(<1G)	$\pm 4.68\text{dB}$
5	All emissions,radiated(>1G)	$\pm 4.89\text{dB}$
6	Temperature	$\pm 0.5^\circ\text{C}$
7	Humidity	$\pm 2\%$

## 2. GENERAL INFORMATION

### 2.1 GENERAL DESCRIPTION OF EUT

Equipment	Car audio combine machine	
Trade Name	Power Acoustik / SOUNDSTREAM	
Model Name	PCD-42B	
Serial Model	VCD-32B	
Model Difference	All the model are the same circuit and RF module, except the model name, test mode is PCD-42B.	
Product Description	The EUT is a Car audio combine machine	
	Operation Frequency:	2402~2480 MHz
	Modulation Type:	FHSS
	Bit Rate of Transmitter	GFSK
	Number Of Channel	79 CH
	Antenna Designation:	Please see Note 3.
	Antenna Gain(Peak)	0.5dBi
	Output Power(Conducted):	2.19 dBm (Max.)
	Based on the application, features, or specification exhibited in User's Manual, the EUT is considered as an ITE/Computing Device. More details of EUT technical specification, please refer to the User's Manual.	
Channel List	Please refer to the Note 2.	
Adapter	N/A	
Battery	Rated Voltage: 12V	
Connecting I/O Port(s)	Please refer to the User's Manual	

Note:

1. For a more detailed features description, please refer to the manufacturer's specifications or the User's Manual.

2.

Channel List					
Channel	Frequency (MHz)	Channel	Frequency (MHz)	Channel	Frequency (MHz)
00	2402	27	2429	54	2456
01	2403	28	2430	55	2457
02	2404	29	2431	56	2458
03	2405	30	2432	57	2459
04	2406	31	2433	58	2460
05	2407	32	2434	59	2461
06	2408	33	2435	60	2462
07	2409	34	2436	61	2463
08	2410	35	2437	62	2464
09	2411	36	2438	63	2465
10	2412	37	2439	64	2466
11	2413	38	2440	65	2467
12	2414	39	2441	66	2468
13	2415	40	2442	67	2469
14	2416	41	2443	68	2470
15	2417	42	2444	69	2471
16	2418	43	2445	70	2472
17	2419	44	2446	71	2473
18	2420	45	2447	72	2474
19	2421	46	2448	73	2475
20	2422	47	2449	74	2476
21	2423	48	2450	75	2477
22	2424	49	2451	76	2478
23	2425	50	2452	77	2479
24	2426	51	2453	78	2480
25	2427	52	2454		
26	2428	53	2455		

3.

Table for Filed Antenna

Ant	Brand	Model Name	Antenna Type	Connector	Gain (dBi)	NOTE
1	N/A	N/A	PCB Antenna	NA	0.5	BT Antenna

The EUT antenna is integral Antenna. no antenna other than that furnished by the responsible party shall be used with the device.



## 2.2 DESCRIPTION OF TEST MODES

To investigate the maximum EMI emission characteristics generates from EUT, the test system was pre-scanning tested base on the consideration of following EUT operation mode or test configuration mode which possible have effect on EMI emission level. Each of these EUT operation mode(s) or test configuration mode(s) mentioned above was evaluated respectively.

Pretest Mode	Description
Mode 1	CH00
Mode 2	CH39
Mode 3	CH78

For Conducted Emission	
Final Test Mode	Description
Mode4	Link mode

For Radiated Emission	
Final Test Mode	Description
Mode 1	CH00
Mode 2	CH39
Mode 3	CH78
Mode4	Link mode

Note:

- (1) The measurements are performed at the highest, middle, lowest available channels.

## 2.3 TABLE OF PARAMETERS OF TEXT SOFTWARE SETTING

During testing channel & power controlling software provided by the customer was used to control the operating channel as well as the output power level. The RF output power selection is for the setting of RF output power expected by the customer and is going to be fixed on the firmware of the final end product power parameters of FHSS

Test software Version	Test program: BT903		
Frequency	2402 MHz	2441 MHz	2480 MHz
Parameters(1Mbps)	DEF	DEF	DEF

**2.4 BLOCK DIGRAM SHOWING THE CONFIGURATION OF SYSTEM TESTED**

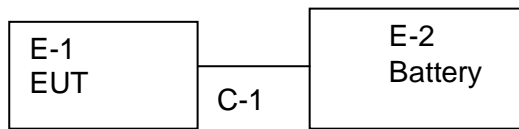

**2.5 DESCRIPTION OF SUPPORT UNITS(CONDUCTED MODE)**

The EUT has been tested as an independent unit together with other necessary accessories or support units. The following support units or accessories were used to form a representative test configuration during the tests.

Item	Equipment	Mfr/Brand	Model/Type No.	Series No.	Note
E-1	Car audio combine machine	N/A	PCD-42B	N/A	EUT
E-2	Battery	N/A	N/A	N/A	

Item	Shielded Type	Ferrite Core	Length	Note
C-1	No	No	0.5M	

**Note:**

- (1) The support equipment was authorized by Declaration of Confirmation.
- (2) For detachable type I/O cable should be specified the length in cm in 『Length』 column.
- (3) “YES” is means “shielded” “with core”; “NO” is means “unshielded” “without core”.

**2.6 EQUIPMENTS LIST FOR ALL TEST ITEMS**
**Radiation Test equipment**

Item	Kind of Equipment	Manufacturer	Type No.	Serial No.	Calibrated until
1	Spectrum Analyzer	Agilent	E4407B	160400005	Jul. 06. 2014
2	Test Receiver	R&S	ESPI	101318	Jul. 06. 2014
3	Bilog Antenna	TESEQ	CBL6111D	31216	Nov.23. 2014
4	50Ω Coaxial Switch	Anritsu	MP59B	6200264416	Jul. 06. 2014
5	Spectrum Analyzer	ADVANTEST	R3132	150900201	Jul. 06. 2014
6	Horn Antenna	EM	EM-AH-10180	2011071402	Nov.23. 2014
7	Horn Ant	Schwarzbeck	BBHA 9170	9170-181	Jul. 06. 2014
8	Amplifier	EM	EM-30180	060538	Jul. 06. 2014
9	Loop Antenna	ARA	PLA-1030/B	1029	Jul. 06. 2014
10	Power Meter	R&S	NRVS	100696	Jul. 06. 2014
11	Power Sensor (Peak)	R&S	NRV-Z31	0396.0101.1 9	Jul. 06. 2014

**Conduction Test equipment**

Item	Kind of Equipment	Manufacturer	Type No.	Serial No.	Calibrated until
1	Test Receiver	R&S	ESCI	101160	Jul. 06. 2014
2	LISN	R&S	ENV216	101313	Jul. 06. 2014
3	LISN	EMCO	3816/2	00042990	Jul. 06. 2014
4	50Ω Coaxial Switch	Anritsu	MP59B	6200264417	Jul. 06. 2014
5	Passive Voltage Probe	R&S	ESH2-Z3	100196	Jul. 06. 2014
6	Absorbing clamp	R&S	MOS-21	100423	Jul. 06. 2014

### 3. EMC EMISSION TEST

#### 3.1 CONDUCTED EMISSION MEASUREMENT

##### 3.1.1 POWER LINE CONDUCTED EMISSION Limits (Frequency Range 150KHz-30MHz)

FREQUENCY (MHz)	Class A (dBuV)		Class B (dBuV)		Standard
	Quasi-peak	Average	Quasi-peak	Average	
0.15 -0.5	79.00	66.00	66 - 56 *	56 - 46 *	CISPR
0.50 -5.0	73.00	60.00	56.00	46.00	CISPR
5.0 -30.0	73.00	60.00	60.00	50.00	CISPR

0.15 -0.5	79.00	66.00	66 - 56 *	56 - 46 *	FCC
0.50 -5.0	73.00	60.00	56.00	46.00	FCC
5.0 -30.0	73.00	60.00	60.00	50.00	FCC

Note:

- (1) The tighter limit applies at the band edges.
- (2) The limit of " \* " marked band means the limitation decreases linearly with the logarithm of the frequency in the range.

The following table is the setting of the receiver

Receiver Parameters	Setting
Attenuation	10 dB
Start Frequency	0.15 MHz
Stop Frequency	30 MHz
IF Bandwidth	9 kHz

**3.1.2 TEST PROCEDURE**

- a. The EUT was placed 0.4 meters from the horizontal ground plane with EUT being connected to the power mains through a line impedance stabilization network (LISN). All other support equipments powered from additional LISN(s). The LISN provide 50 Ohm/ 50uH of coupling impedance for the measuring instrument.
- b. Interconnecting cables that hang closer than 40 cm to the ground plane shall be folded back and forth in the center forming a bundle 30 to 40 cm long.
- c. I/O cables that are not connected to a peripheral shall be bundled in the center. The end of the cable may be terminated, if required, using the correct terminating impedance. The overall length shall not exceed 1 m.
- d. LISN at least 80 cm from nearest part of EUT chassis.
- e. For the actual test configuration, please refer to the related Item –EUT Test Photos.

**3.1.3 DEVIATION FROM TEST STANDARD**

No deviation

**3.1.4 TEST SETUP**

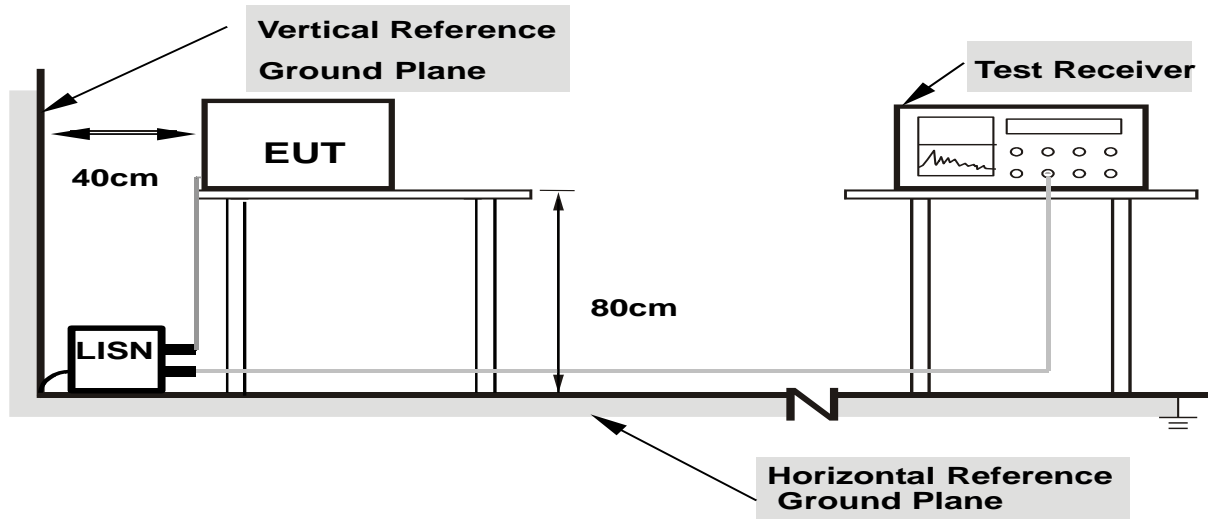

- Note:**
- 1. Support units were connected to second LISN.
  - 2. Both of LISNs (AMN) are 80 cm from EUT and at least 80 from other units and other metal planes

**3.1.5 EUT OPERATING CONDITIONS**

The EUT was configured for testing in a typical fashion (as a customer would normally use it). The EUT has been programmed to continuously transmit during test. This operating condition was tested and used to collect the included data.

**3.1.6 TEST RESULTS**

EUT :	Car audio combine machine	Model Name. :	PCD-42B
Temperature :	26 °C	Relative Humidity :	54%
Pressure :	1010hPa	Phase :	L
Test Voltage :	N/A	Test Mode :	N/A
Note: EUT power supply by battery, so the test not applicable.			

### 3.2 RADIATED EMISSION MEASUREMENT

#### 3.2.1 RADIATED EMISSION LIMITS (Frequency Range 9kHz-1000MHz)

20dBc in any 100 kHz bandwidth outside the operating frequency band. In case the emission fall within the restricted band specified on 15.205(a), then the 15.209(a) limit in the table below has to be followed.

Frequencies (MHz)	Field Strength (micorvolts/meter)	Measurement Distance (meters)
0.009~0.490	2400/F(KHz)	300
0.490~1.705	24000/F(KHz)	30
1.705~30.0	30	30
30~88	100	3
88~216	150	3
216~960	200	3
Above 960	500	3

#### LIMITS OF RADIATED EMISSION MEASUREMENT (Above 1000MHz)

FREQUENCY (MHz)	Class A (dBuV/m) (at 3M)		Class B (dBuV/m) (at 3M)	
	PEAK	AVERAGE	PEAK	AVERAGE
Above 1000	80	60	74	54

Notes:

- (1) The limit for radiated test was performed according to FCC PART 15C.
- (2) The tighter limit applies at the band edges.
- (3) Emission level (dBuV/m)=20log Emission level (uV/m).

#### FREQUENCY RANGE OF RADIATED MEASUREMENT (For unintentional radiators)

Highest frequency generated or Upper frequency of measurement used in the device or on which the device operates or tunes (MHz)	Range (MHz)
Below 1.705	30
1.705 – 108	1000
108 – 500	2000
500 – 1000	5000
Above 1000	5 <sup>th</sup> harmonic of the highest frequency or 40 GHz, whichever is lower



Spectrum Parameter	Setting
Attenuation	Auto
Start Frequency	1000 MHz
Stop Frequency	10th carrier harmonic
RB / VB (emission in restricted band)	1 MHz / 1 MHz for Peak, 1 MHz / 10Hz for Average

Receiver Parameter	Setting
Attenuation	Auto
Start ~ Stop Frequency	9kHz~150kHz / RB 200Hz for QP
Start ~ Stop Frequency	150kHz~30MHz / RB 9kHz for QP
Start ~ Stop Frequency	30MHz~1000MHz / RB 120kHz for QP

**3.2.2 TEST PROCEDURE**

- a. The measuring distance of at 3 m shall be used for measurements at frequency up to 1GHz. For frequencies above 1GHz, any suitable measuring distance may be used.
- b. The EUT was placed on the top of a rotating table 0.8 meters above the ground at a 3 meter open area test site. The table was rotated 360 degrees to determine the position of the highest radiation.
- c. The height of the equipment or of the substitution antenna shall be 0.8 m; the height of the test antenna shall vary between 1 m to 4 m. Both horizontal and vertical polarizations of the antenna are set to make the measurement.
- d. The initial step in collecting conducted emission data is a spectrum analyzer peak detector mode pre-scanning the measurement frequency range. Significant peaks are then marked and then Quasi Peak detector mode re-measured.
- e. If the Peak Mode measured value compliance with and lower than Quasi Peak Mode Limit, the EUT shall be deemed to meet QP Limits and then no additional QP Mode measurement performed.
- f. For the actual test configuration, please refer to the related Item –EUT Test Photos.

Note:

Both horizontal and vertical antenna polarities were tested and performed pretest to three orthogonal axis. The worst case emissions were reported

**3.2.3 DEVIATION FROM TEST STANDARD**

No deviation

### 3.2.4 TEST SETUP

#### (A) Radiated Emission Test-Up Frequency Below 30MHz

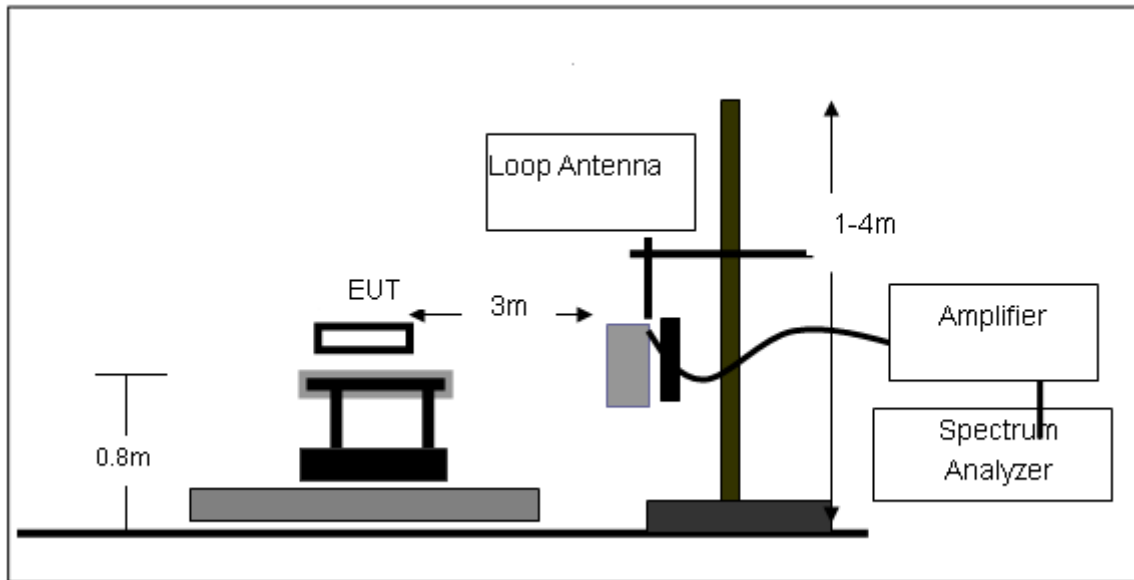

#### (B) Radiated Emission Test-Up Frequency 30MHz~1GHz

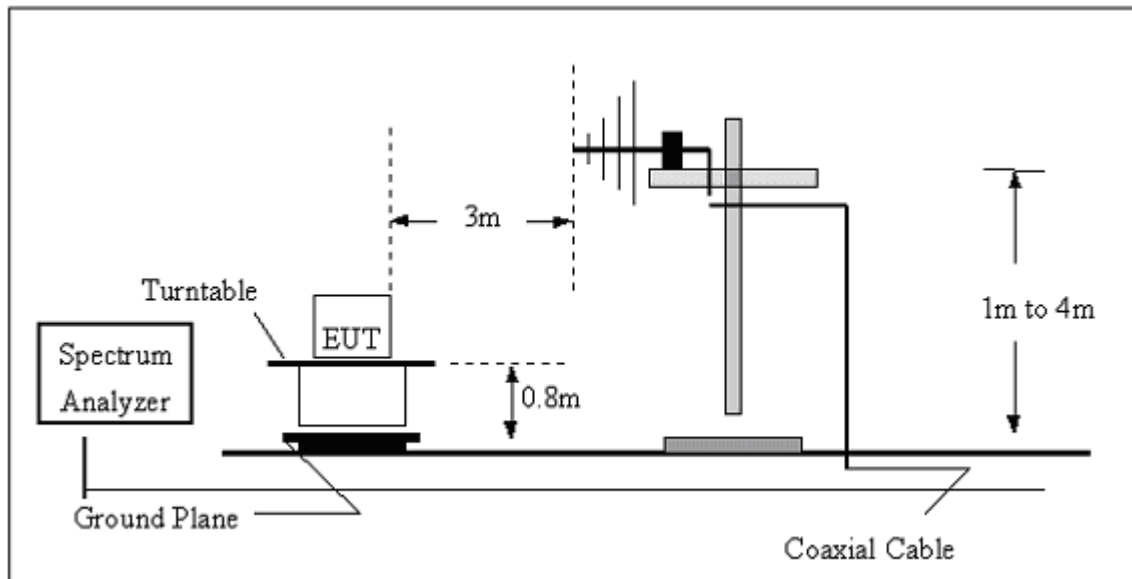

(C) Radiated Emission Test-Up Frequency Above 1GHz

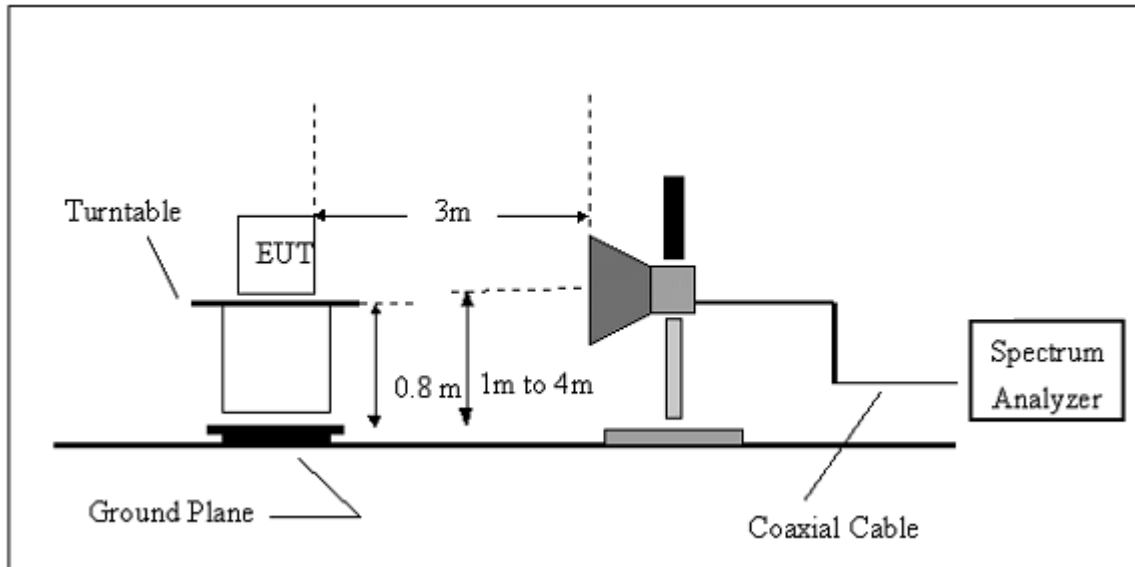

**3.2.5 EUT OPERATING CONDITIONS**

The EUT tested system was configured as the statements of 2.4 Unless otherwise a special operating condition is specified in the follows during the testing.

**3.2.6 TEST RESULTS (BELOW 30 MHZ)**

EUT :	Car audio combine machine	Model Name :	PCD-42B
Temperature :	20 °C	Relative Humidity :	48%
Pressure :	1010 hPa	Polarization :	---
Test Voltage :	DC 12V from battery		
Test Mode :	Link mode		

Freq. (MHz)	Reading (dBuV/m)	Limit (dBuV/m)	Margin (dB)	State P/F
--	--	--	--	PASS
--	--	--	--	PASS

**NOTE:**

The amplitude of spurious emissions which are attenuated by more than 20dB below the permissible value has no need to be reported.

Distance extrapolation factor =  $40 \log (\text{specific distance}/\text{test distance})$ (dB);

Limit line = specific limits(dBuv) + distance extrapolation factor.

**3.2.7 TEST RESULTS (BETWEEN 30M – 1000 MHZ)**

EUT :	Car audio combine machine	Model Name :	PCD-42B
Temperature :	20 °C	Relative Humidity :	48%
Pressure :	1010 hPa	Polarization :	Horizontal
Test Voltage :	DC 12V from battery		
Test Mode :	Link mode		

Frequency (MHz)	Meter Reading (dBμV)	Factor (dB)	Emission Level (dBμV/m)	Limits (dBμV/m)	Margin (dB)	Detector Type
31.0705	16.76	17.86	34.62	40	-5.38	QP
39.8541	20.45	13.46	33.91	40	-6.09	QP
79.8002	30.34	7.76	38.1	40	-1.9	QP
118.6013	19.65	12.05	31.7	43.5	-11.8	QP
302.4812	16.99	14.81	31.8	46	-14.2	QP
750.1082	7.71	26.39	34.1	46	-11.9	QP

Remark:

1. Factor = Antenna Factor + Cable Loss – Pre-amplifier.

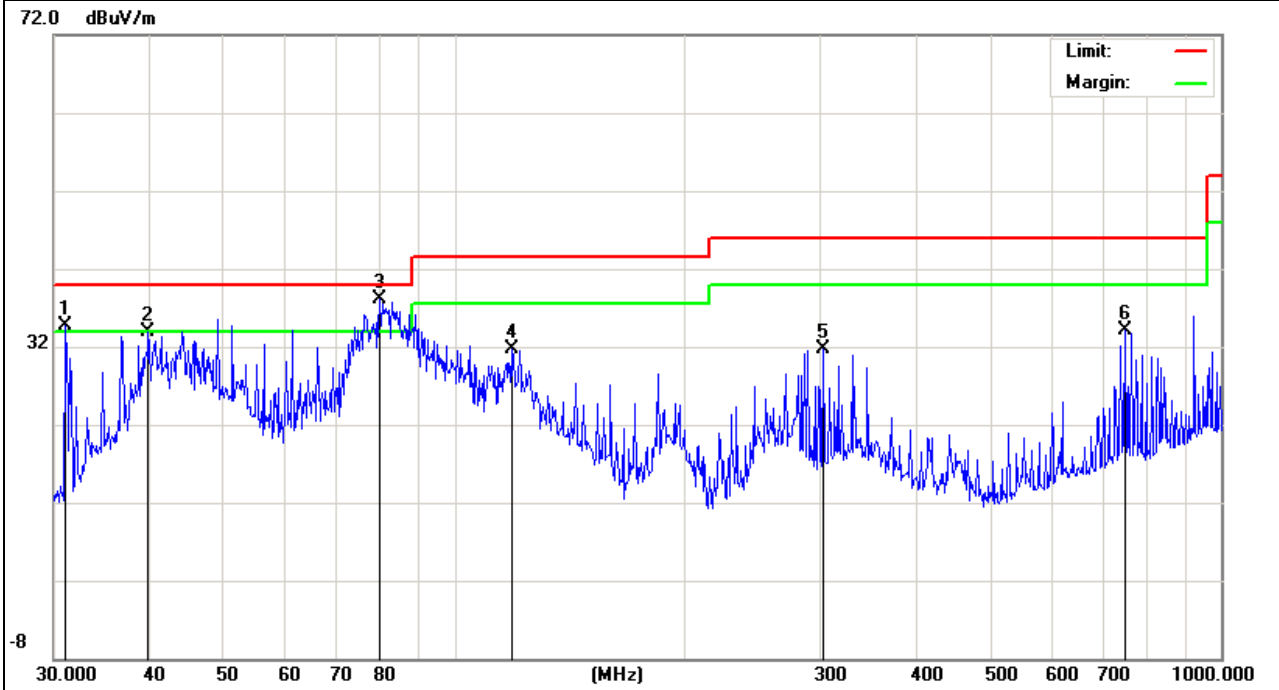

EUT :	Car audio combine machine	Model Name :	PCD-42B
Temperature :	20 °C	Relative Humidity :	48%
Pressure :	1010 hPa	Polarization :	Vertical
Test Voltage :	DC 12V from battery		
Test Mode :	Link mode		

Frequency (MHz)	Meter Reading (dBµV)	Factor (dB)	Emission Level (dBµV/m)	Limits (dBµV/m)	Margin (dB)	Detector Type
44.12	20.13	11.09	31.22	40	-8.78	QP
55.2207	25.86	6.21	32.07	40	-7.93	QP
85.8983	27.83	8.9	36.73	40	-3.27	QP
135.0319	25.46	12.25	37.71	43.5	-5.79	QP
209.3129	27.43	9.65	37.08	43.5	-6.42	QP
319.937	23.82	15.44	39.26	46	-6.74	QP

**Remark:**

1. Factor = Antenna Factor + Cable Loss – Pre-amplifier.

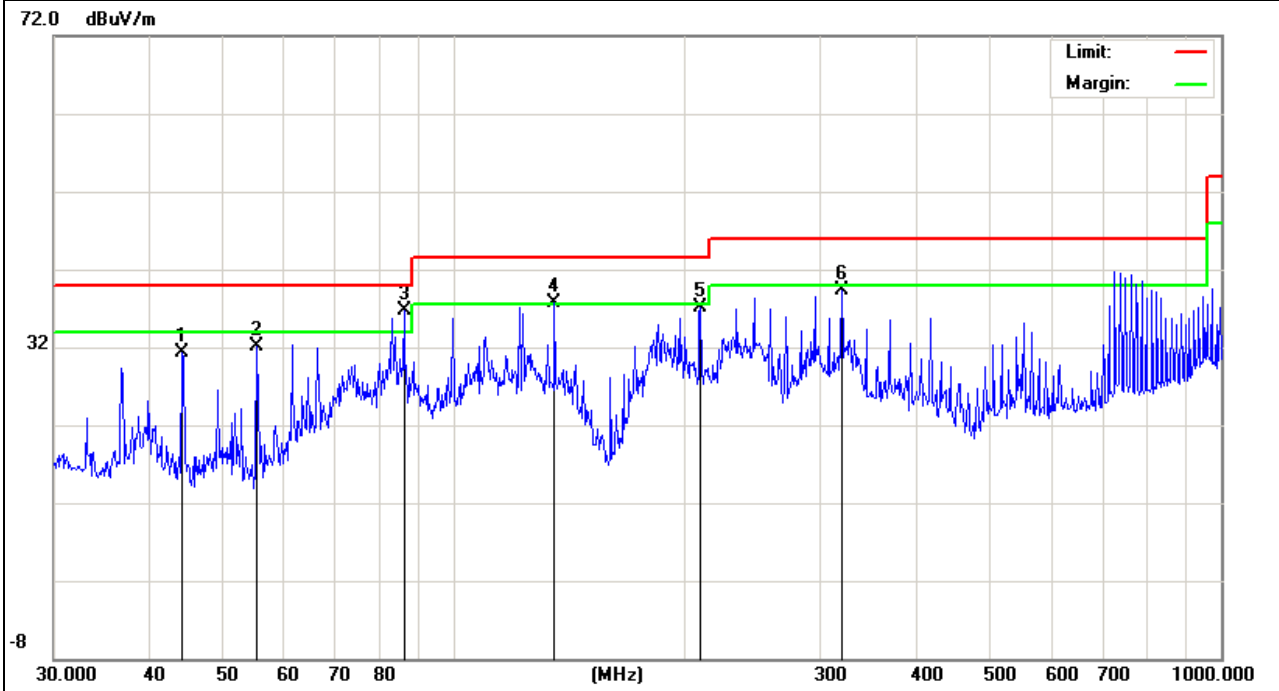

### 3.2.8 TEST RESULTS (ABOVE 1000 MHZ)

EUT :	Car audio combine machine	Model Name :	PCD-42B
Temperature :	20 °C	Relative Humidity :	48%
Pressure :	1010 hPa	Test Voltage :	DC 12V from battery
Test Mode :	TX 2402MHz – CH 00(1Mbps)	Polarization :	Horizontal

Frequency (MHz)	Meter Reading (dB $\mu$ V)	Factor (dB)	Emission Level (dB $\mu$ V/m)	Limits (dB $\mu$ V/m)	Margin (dB)	Detector Type
4804	59.32	-3.64	55.68	74	-18.32	peak
4804	49.22	-3.64	45.58	54	-8.42	AVG
7206	53.96	-0.95	53.01	74	-20.99	peak
7206	46.21	-0.95	45.26	54	-8.74	AVG
9608	46.35	2.15	48.5	74	-25.5	peak
9608	36.68	2.15	38.83	54	-15.17	AVG

Remark:  
Factor = Antenna Factor + Cable Loss – Pre-amplifier.

EUT :	Car audio combine machine	Model Name :	PCD-42B
Temperature :	20 °C	Relative Humidity :	48%
Pressure :	1010 hPa	Test Voltage :	DC 12V from battery
Test Mode :	TX 2402MHz – CH 00(1Mbps)	Polarization :	Vertical

Frequency (MHz)	Meter Reading (dB $\mu$ V)	Factor (dB)	Emission Level (dB $\mu$ V/m)	Limits (dB $\mu$ V/m)	Margin (dB)	Detector Type
4804	52.08	-3.64	48.44	74	-25.56	peak
4804	44.22	-3.64	40.58	54	-13.42	AVG
7206	53.11	-0.95	52.16	74	-21.84	peak
7206	42.13	-0.95	41.18	54	-12.82	AVG
9608	42.95	2.15	45.1	74	-28.9	peak
9608	35.12	2.15	37.27	54	-16.73	AVG

Remark:  
Factor = Antenna Factor + Cable Loss – Pre-amplifier.

EUT :	Car audio combine machine	Model Name :	PCD-42B
Temperature :	20 °C	Relative Humidity :	48%
Pressure :	1010 hPa	Test Voltage :	DC 12V from battery
Test Mode :	TX 2441MHz – CH 39(1Mbps)	Polarization :	Horizontal

Frequency (MHz)	Meter Reading (dBµV)	Factor (dB)	Emission Level (dBµV/m)	Limits (dBµV/m)	Margin (dB)	Detector Type
4882	54.11	-3.68	50.43	74	-23.57	peak
4882	43.21	-3.68	39.53	54	-14.47	AVG
7323	51.26	-0.82	50.44	74	-23.56	peak
7323	43.97	-0.82	43.15	54	-10.85	AVG
9764	51.22	0.81	52.03	74	-21.97	peak
9764	40.21	0.81	41.02	54	-12.98	AVG

Remark:  
Factor = Antenna Factor + Cable Loss – Pre-amplifier.

EUT :	Car audio combine machine	Model Name :	PCD-42B
Temperature :	20 °C	Relative Humidity :	48%
Pressure :	1010 hPa	Test Voltage :	DC 12V from battery
Test Mode :	TX 2441MHz – CH 39(1Mbps)	Polarization :	Vertical

Frequency (MHz)	Meter Reading (dBµV)	Factor (dB)	Emission Level (dBµV/m)	Limits (dBµV/m)	Margin (dB)	Detector Type
4882	51.23	-3.68	47.55	74	-26.45	peak
4882	37.21	-3.68	33.53	54	-20.47	AVG
7323	54.95	-0.82	54.13	74	-19.87	peak
7323	43.71	-0.82	42.89	54	-11.11	AVG
9764	49.29	0.81	50.1	74	-23.9	peak
9764	40.87	0.81	41.68	54	-12.32	AVG

Remark:  
Factor = Antenna Factor + Cable Loss – Pre-amplifier.



EUT :	Car audio combine machine	Model Name :	PCD-42B
Temperature :	20 °C	Relative Humidity :	48%
Pressure :	1010 hPa	Test Voltage :	DC 12V from battery
Test Mode :	TX 2480MHz – CH 78(1Mbps)	Polarization :	Horizontal

Frequency (MHz)	Meter Reading (dBµV)	Factor (dB)	Emission Level (dBµV/m)	Limits (dBµV/m)	Margin (dB)	Detector Type
4960	53.05	-3.59	49.46	74	-24.54	peak
4960	42.09	-3.59	38.5	54	-15.5	AVG
7440	51.27	-0.69	50.58	74	-23.42	peak
7440	42.14	-0.69	41.45	54	-12.55	AVG
9920	42.92	1.14	44.06	74	-29.94	peak
9920	38.81	1.14	39.95	54	-14.05	AVG

Remark:  
Factor = Antenna Factor + Cable Loss – Pre-amplifier.

EUT :	Car audio combine machine	Model Name :	PCD-42B
Temperature :	20 °C	Relative Humidity :	48%
Pressure :	1010 hPa	Test Voltage :	DC 12V from battery
Test Mode :	TX 2480MHz – CH 78(1Mbps)	Polarization :	Vertical

Frequency (MHz)	Meter Reading (dBµV)	Factor (dB)	Emission Level (dBµV/m)	Limits (dBµV/m)	Margin (dB)	Detector Type
4960	53.25	-3.59	49.66	74	-24.34	peak
4960	43.01	-3.59	39.42	54	-14.58	AVG
7440	45.25	-0.69	44.56	74	-29.44	peak
7440	40.91	-0.69	40.22	54	-13.78	AVG
9920	43.13	1.14	44.27	74	-29.73	peak
9920	39.19	1.14	40.33	54	-13.67	AVG

Remark:  
Factor = Antenna Factor + Cable Loss – Pre-amplifier.

**3.2.9 TEST RESULTS (RESTRICTED BANDS REQUIREMENTS)**

EUT :	Car audio combine machine	Model Name :	PCD-42B
Temperature :	25 °C	Relative Humidity :	60%
Pressure :	1012 hPa	Polarization :	Horizontal
Test Voltage :	DC 12V from battery		
Test Mode :	CH00 for GFSK		

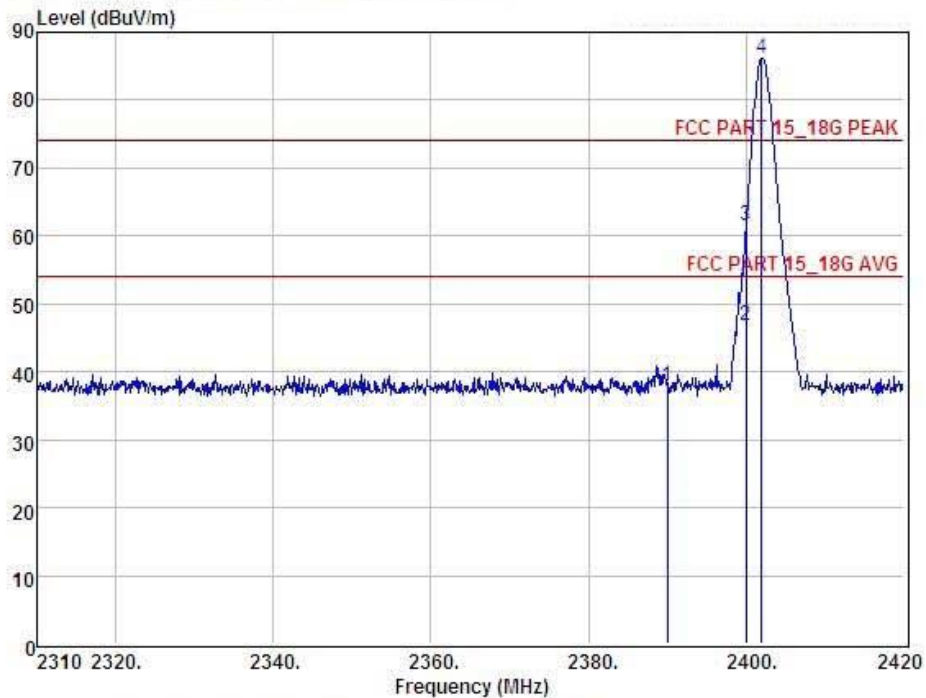

Condition : FCC PART 15_18G PEAK 3m POL: HORIZONTAL									
Item	Freq	Read	Antenna	Preamp	Cable	Level	Limit	Margin	Remark
	MHz	Level	Factor	Factor	Loss	dBuV	dBuV	dBuV	
		dBuV	dB	dB	dB				
1	2390.00	41.22	27.62	34.97	3.92	37.79	74.00	-36.21	Peak
2	2400.00	50.26	27.62	34.97	3.94	46.85	54.00	-7.15	Average
3	2400.00	64.97	27.62	34.97	3.94	61.56	74.00	-12.44	Peak
4	2402.00	89.57	27.62	34.97	3.94	86.16	74.00	12.16	Peak

Remark: Level = Read Level + Antenna Factor - Preamp Factor + Cable Loss

EUT :	Car audio combine machine	Model Name :	PCD-42B
Temperature :	25 °C	Relative Humidity :	60%
Pressure :	1012 hPa	Polarization :	Vertical
Test Voltage :	DC 12V from battery		
Test Mode :	CH00 for GFSK		

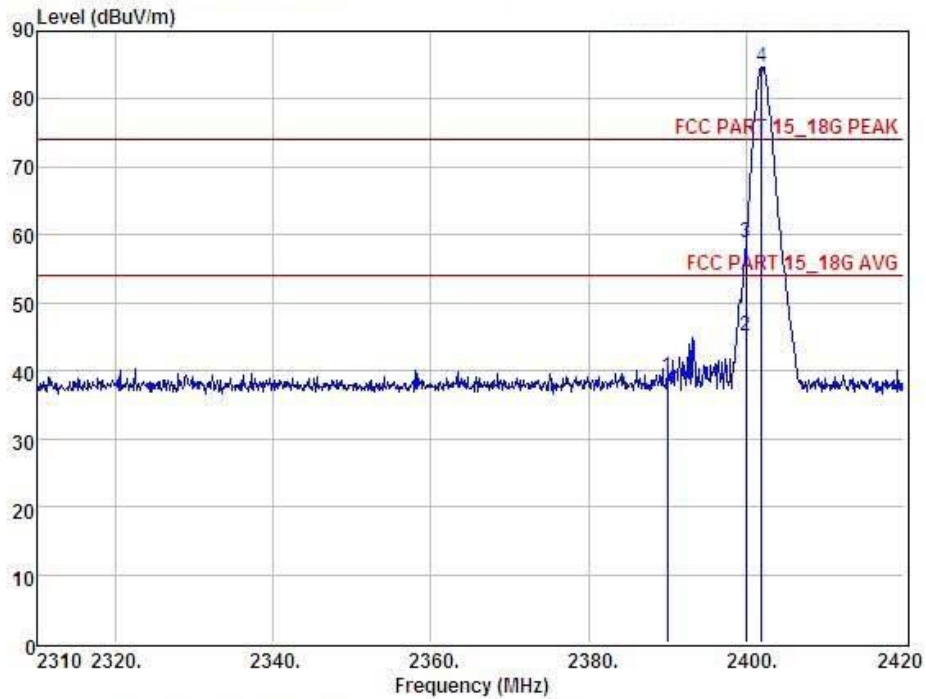

Condition : FCC PART 15_18G PEAK 3m POL: VERTICAL									
Item	Freq	Read Level	Antenna Factor	Preamp Factor	Cable Loss	Level	Limit	Margin	Remark
	MHz	dBuV	dB	dB	dB	dBuV	dBuV	dBuV	
1	2390.00	42.64	27.62	34.97	3.92	39.21	74.00	-34.79	Peak
2	2400.00	48.54	27.62	34.97	3.94	45.13	54.00	-8.87	Average
3	2400.00	62.33	27.62	34.97	3.94	58.92	74.00	-15.08	Peak
4	2402.00	88.19	27.62	34.97	3.94	84.78	74.00	10.78	Peak

Remark: Level = Read Level + Antenna Factor - Preamp Factor + Cable Loss

EUT :	Car audio combine machine	Model Name :	PCD-42B
Temperature :	25 °C	Relative Humidity :	60%
Pressure :	1012 hPa	Polarization :	Horizontal
Test Voltage :	DC 12V from battery		
Test Mode :	CH78 for GFSK		

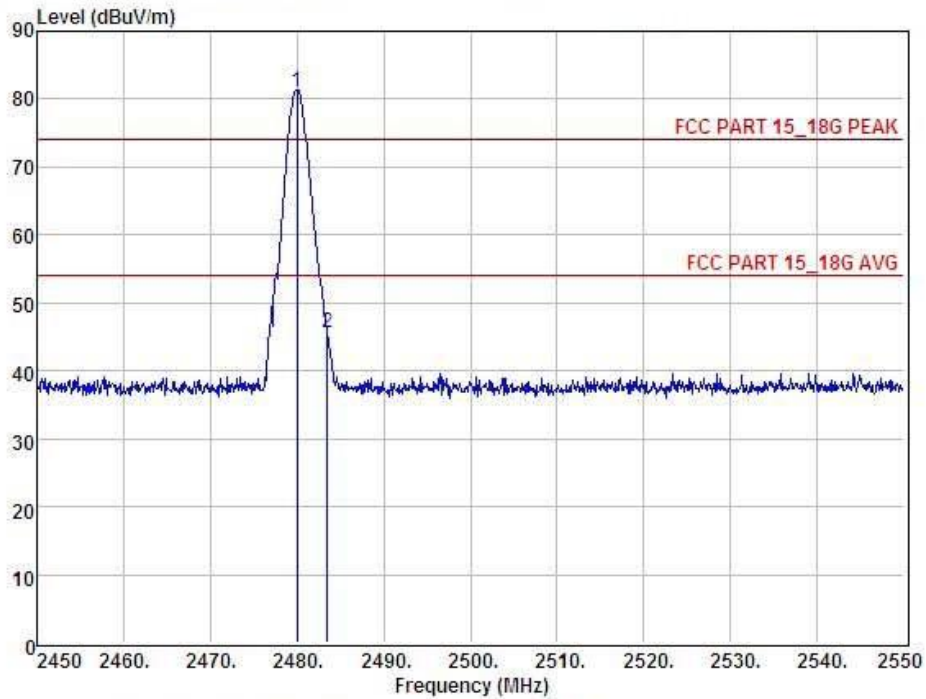

Condition : FCC PART 15_18G PEAK 3m POL: HORIZONTAL									
Item	Freq	Read Level	Antenna Factor	Preamp Factor	Cable Loss	Level	Limit	Margin	Remark
	MHz	dBuV	dB	dB	dB	dBuV	dBuV	dBuV	
1	2480.00	84.55	27.59	34.97	4.00	81.17	74.00	7.17	Peak
2	2483.50	49.05	27.59	34.97	4.00	45.67	74.00	-28.33	Peak

Remark: Level = Read Level + Antenna Factor - Preamp Factor + Cable Loss

EUT :	Car audio combine machine	Model Name :	PCD-42B
Temperature :	25 °C	Relative Humidity :	60%
Pressure :	1012 hPa	Polarization :	Vertical
Test Voltage :	DC 12V from battery		
Test Mode :	CH78 for GFSK		

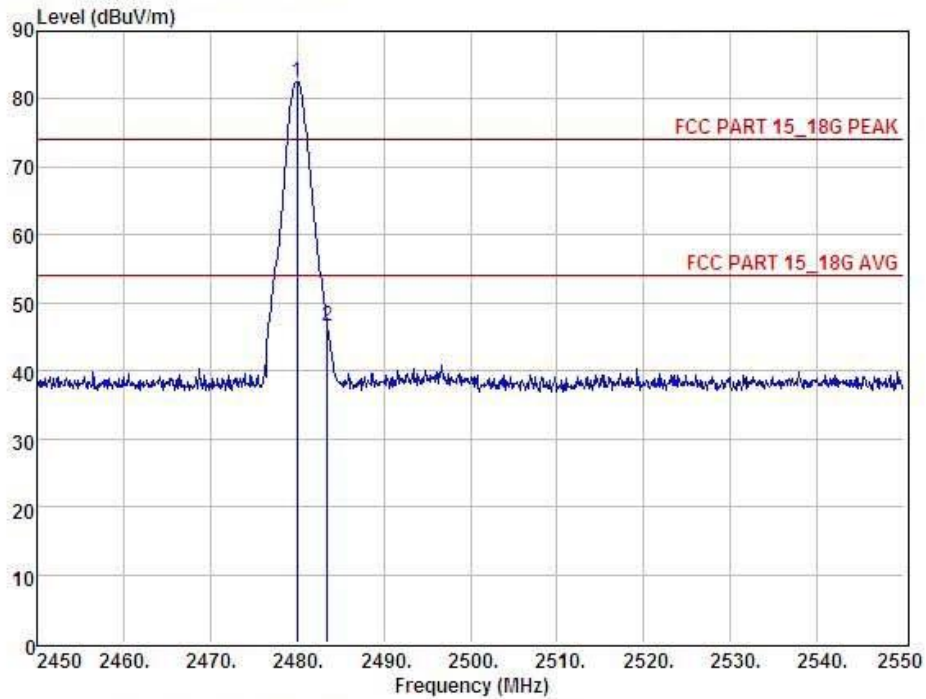

Condition : FCC PART 15\_18G PEAK 3m POL: VERTICAL

Item	Freq MHz	Read Level dBuV	Antenna Factor dB	Preamp Factor dB	Cable Loss dB	Level dBuV	Limit dBuV	Margin dBuV	Remark
1	2480.00	85.84	27.59	34.97	4.00	82.46	74.00	8.46	Peak
2	2483.50	49.90	27.59	34.97	4.00	46.52	74.00	-27.48	Peak

Remark: Level = Read Level + Antenna Factor - Preamp Factor + Cable Loss

EUT :	Car audio combine machine	Model Name :	PCD-42B
Temperature :	25 °C	Relative Humidity :	60%
Pressure :	1012 hPa	Polarization :	Horizontal
Test Voltage :	DC 12V from battery		
Test Mode :	Hopping for GFSK		

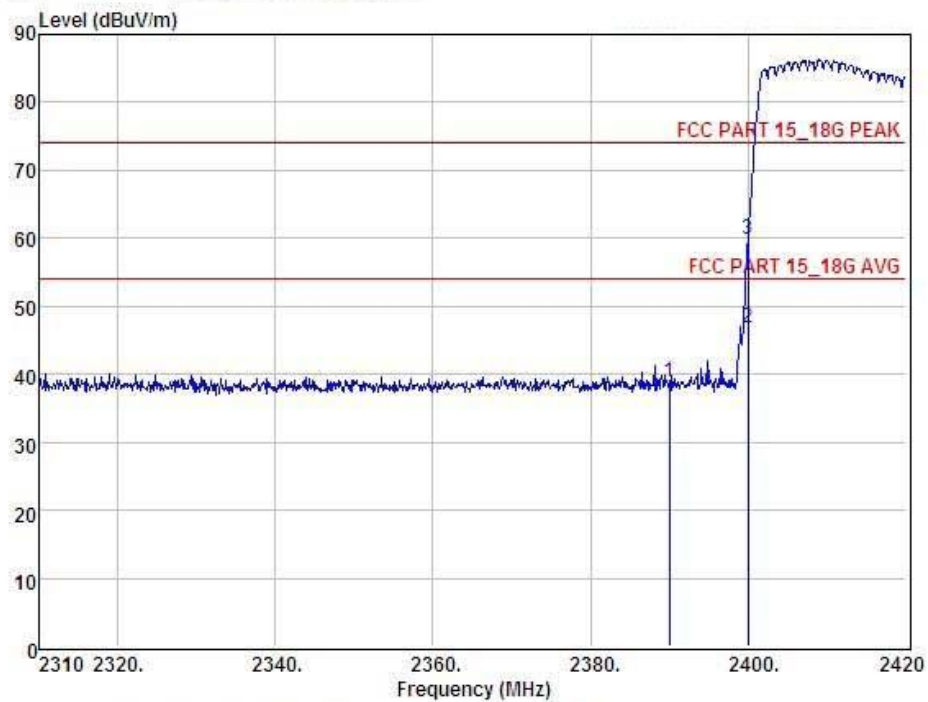

Condition : FCC PART 15\_18G PEAK 3m POL: HORIZONTAL

Item	Freq MHz	Read Level dBuV	Antenna Factor dB	Preamp Factor dB	Cable Loss dB	Level dBuV	Limit dBuV	Margin dBuV	Remark
1	2390.00	42.29	27.62	34.97	3.92	38.86	74.00	-35.14	Peak
2	2400.00	50.32	27.62	34.97	3.94	48.91	54.00	-7.09	Average
3	2400.00	63.32	27.62	34.97	3.94	59.91	74.00	-14.09	Peak

Remark: Level = Read Level + Antenna Factor - Preamp Factor + Cable Loss

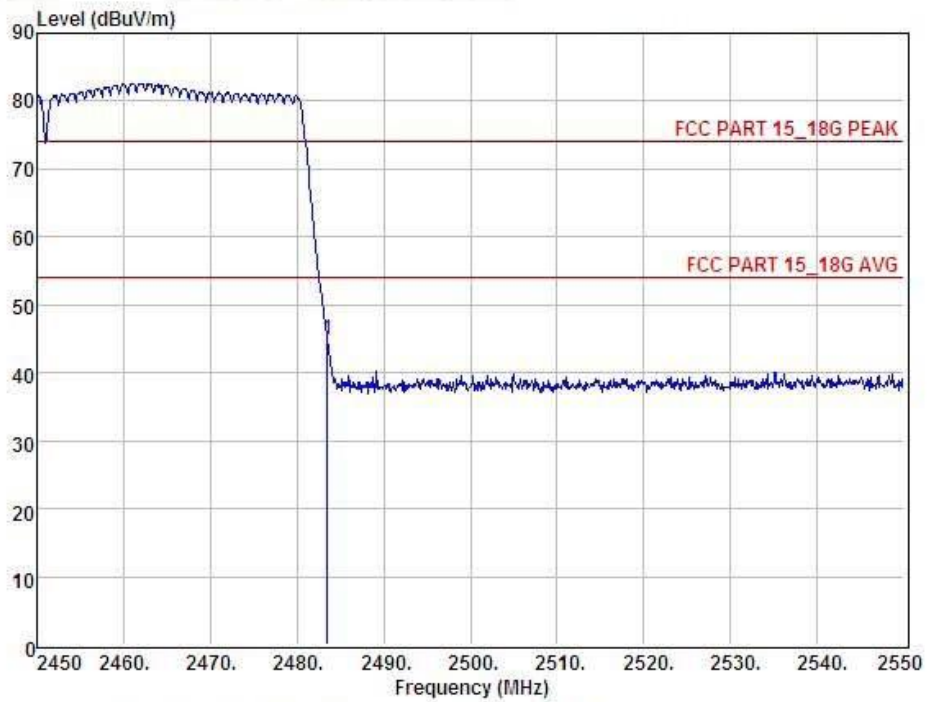

Condition : FCC PART 15\_18G PEAK 3m POL: HORIZONTAL

Item	Freq MHz	Read Level dBuV	Antenna Factor dB	Preamp Factor dB	Cable Loss dB	Level dBuV	Limit dBuV	Margin dBuV	Remark
1	2483.50	48.29	27.59	34.97	4.00	44.91	74.00	-29.09	Peak

Remark: Level = Read Level + Antenna Factor - Preamp Factor + Cable Loss



EUT :	Car audio combine machine	Model Name :	PCD-42B
Temperature :	25 °C	Relative Humidity :	60%
Pressure :	1012 hPa	Polarization :	Vertical
Test Voltage :	DC 12V from battery		
Test Mode :	Hopping for GFSK		

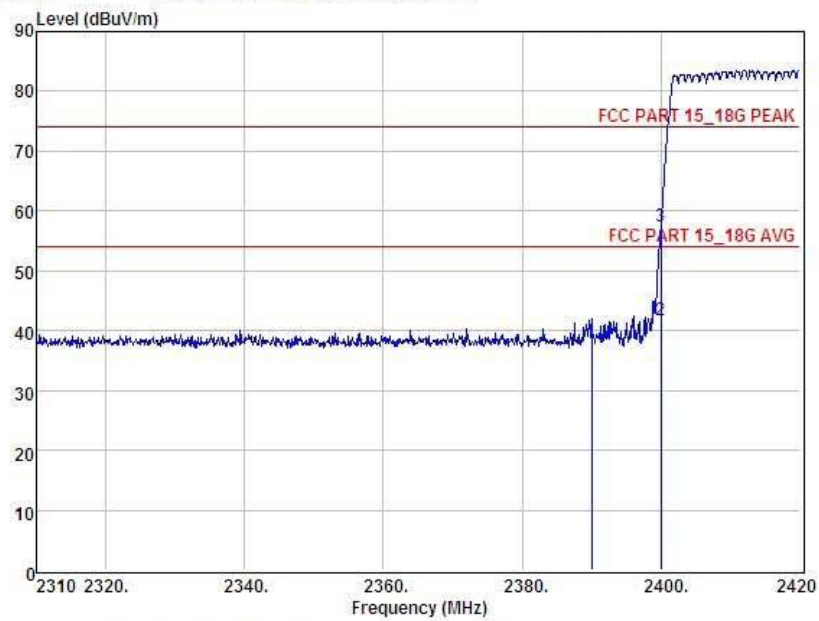

Condition : FCC PART 15_18G PEAK 3m POL: VERTICAL									
Item	Freq	Read	Antenna	Preamp	Cable	Level	Limit	Margin	Remark
	MHz	Level	Factor	Factor	Loss	dBuV	dBuV	dBuV	
		dBuV	dB	dB	dB				
1	2390.00	41.38	27.62	34.97	3.92	37.95	74.00	-36.05	Peak
2	2400.00	45.13	27.62	34.97	3.94	41.72	54.00	-12.28	Average
3	2400.00	60.92	27.62	34.97	3.94	57.51	74.00	-16.49	Peak

Remark: Level = Read Level + Antenna Factor - Preamp Factor + Cable Loss



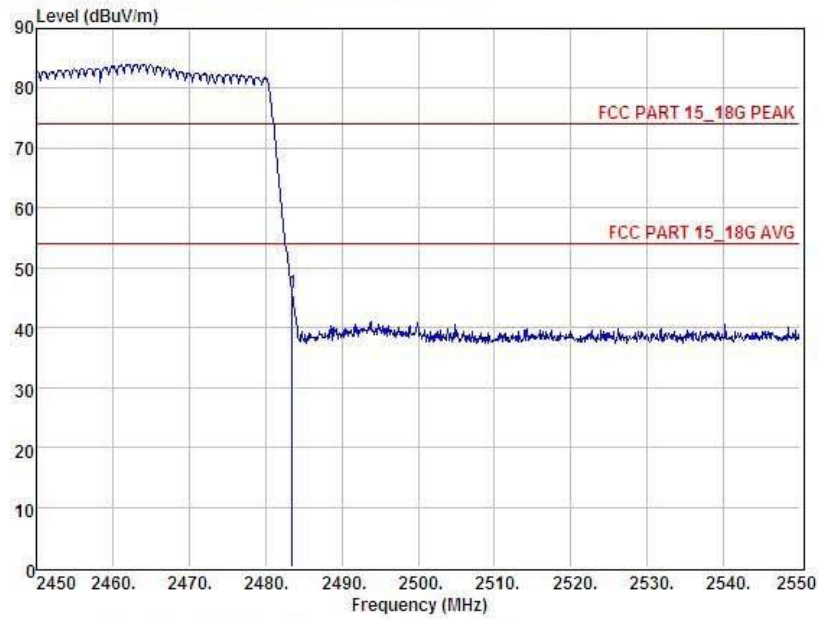

Condition : FCC PART 15_18G PEAK 3m POL: VERTICAL									
Item	Freq	Read	Antenna	Preamp	Cable	Level	Limit	Margin	Remark
	MHz	Level	Factor	Factor	Loss	dBuV	dBuV	dBuV	
		dBuV	dB	dB	dB				
1	2483.50	49.26	27.59	34.97	4.00	45.88	74.00	-28.12	Peak

Remark: Level = Read Level + Antenna Factor - Preamp Factor + Cable Loss

**4. NUMBER OF HOPPING CHANNEL**

**4.1 APPLIED PROCEDURES / LIMIT**

FCC Part15 (15.247) , Subpart C				
Section	Test Item	Limit	Frequency Range (MHz)	Result
15.247 (a)(1)(iii)	Number of Hopping Channel	≥15	2400-2483.5	PASS

Spectrum Parameters	Setting
Attenuation	Auto
Span Frequency	> Operating Frequency Range
RB	100 kHz
VB	100 kHz
Detector	Peak
Trace	Max Hold
Sweep Time	Auto

**4.1.1 TEST PROCEDURE**

- a. The EUT was directly connected to the spectrum analyzer and antenna output port as show in the block diagram below,
- b. Spectrum Setting : RBW= 100KHz, VBW=100KHz, Sweep time = Auto.

**4.1.2 DEVIATION FROM STANDARD**

No deviation.

**4.1.3 TEST SETUP**



**4.1.4 EUT OPERATION CONDITIONS**

The EUT tested system was configured as the statements of 2.4 Unless otherwise a special operating condition is specified in the follows during the testing.

4.1.5 TEST RESULTS

EUT :	Car audio combine machine	Model Name :	PCD-42B
Temperature :	25 °C	Relative Humidity :	60%
Pressure :	1015 hPa	Test Voltage :	DC 12V from battery
Test Mode :	Hopping Mode for GFSK		

Number of Hopping Channel	79
---------------------------	----

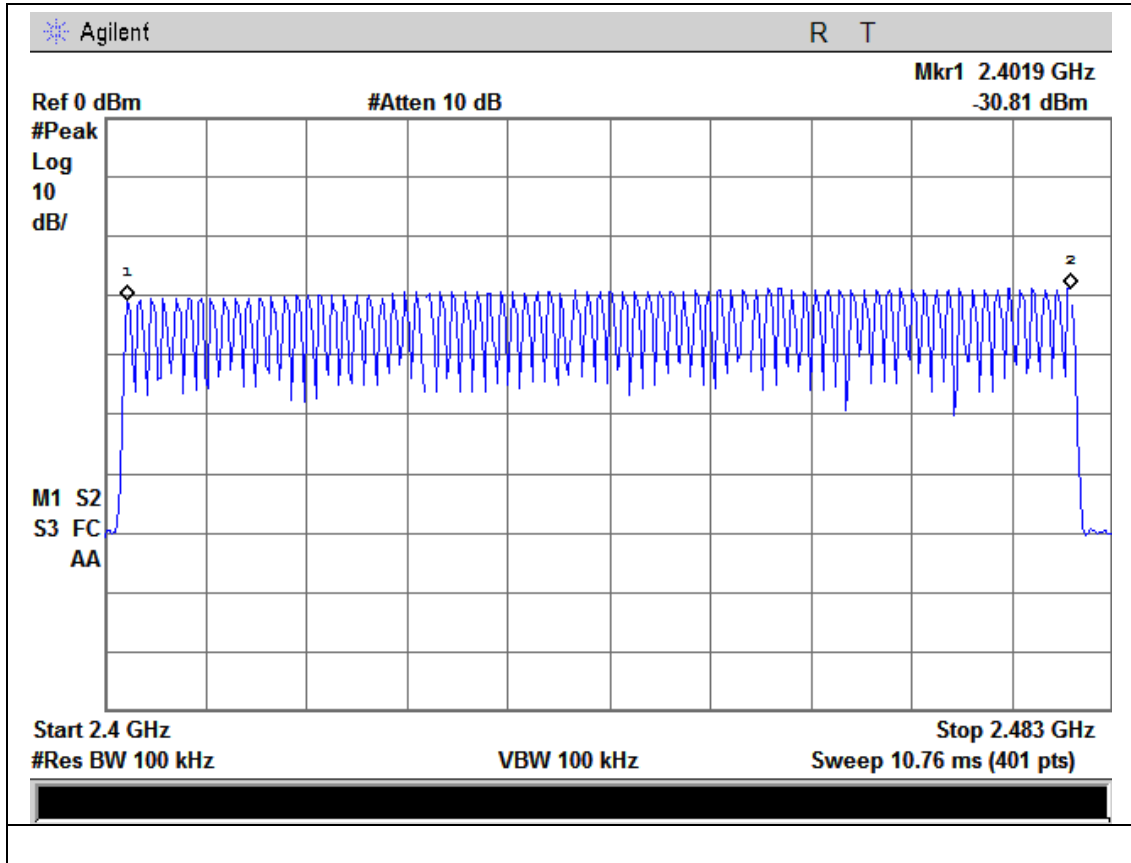

**5. AVERAGE TIME OF OCCUPANCY**

**5.1 APPLIED PROCEDURES / LIMIT**

FCC Part15 (15.247) , Subpart C				
Section	Test Item	Limit	Frequency Range (MHz)	Result
15.247 (a)(1)(iii)	Average Time of Occupancy	0.4sec	2400-2483.5	PASS

**5.1.1 TEST PROCEDURE**

- a. The transmitter output (antenna port) was connected to the spectrum analyzer
- b. Set RBW of spectrum analyzer to 1MHz and VBW to 1MHz.
- c. Use a video trigger with the trigger level set to enable triggering only on full pulses.
- d. Sweep Time is more than once pulse time.
- e. Set the center frequency on any frequency would be measure and set the frequency span to zero span.
- f. Measure the maximum time duration of one single pulse.
- g. Set the EUT for DH5, DH3 and DH1 packet transmitting.
- h. Measure the maximum time duration of one single pulse.
- i. DH5 Packet permit maximum  $1600 / 79 / 6 = 3.37$  hops per second in each channel (5 time slots RX, 1 time slot TX). So, the dwell time is the time duration of the pulse times  $3.37 \times 31.6 = 106.6$  within 31.6 seconds.
- j. DH3 Packet permit maximum  $1600 / 79 / 4 = 5.06$  hops per second in each channel (3 time slots RX, 1 time slot TX). So, the dwell time is the time duration of the pulse times  $5.06 \times 31.6 = 160$  within 31.6 seconds.
- k. DH1 Packet permit maximum  $1600 / 79 / 2 = 10.12$  hops per second in each channel (1 time slot RX, 1 time slot TX). So, the dwell time is the time duration of the pulse times  $10.12 \times 31.6 = 320$  within 31.6 seconds.

**5.1.2 DEVIATION FROM STANDARD**

No deviation.

**5.1.3 TEST SETUP**

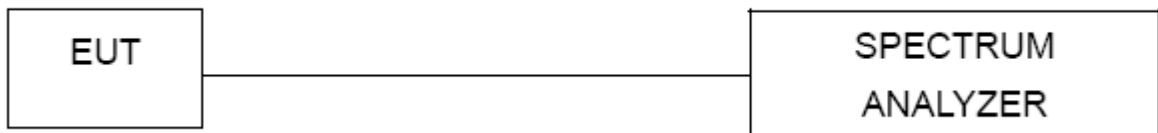

**5.1.4 EUT OPERATION CONDITIONS**

The EUT tested system was configured as the statements of 2.4 Unless otherwise a special operating condition is specified in the follows during the testing.

5.1.5 TEST RESULTS

EUT :	Car audio combine machine	Model Name :	PCD-42B
Temperature :	25 °C	Relative Humidity :	60%
Pressure :	1012 hPa	Test Voltage :	DC 12V from battery
Test Mode :	CH39- DH5		

Data Packet	Pulse Duration (ms)	Dwell Time (s)	Limits (s)
DH5	3.15	0.34	0.4000

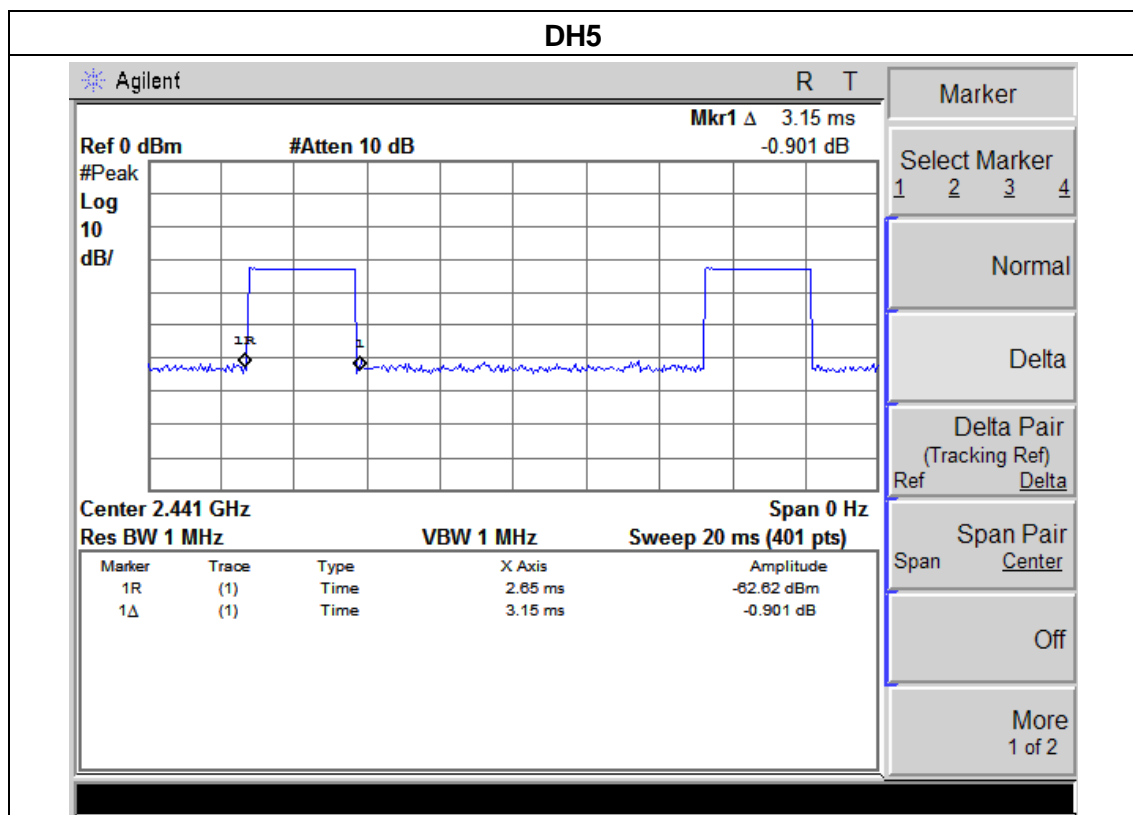

**NOTE:** The dwell time is showed the maximum data of all data (DH1, DH3, DH5), DH5 of mode have the maximum dwell time.

**6. HOPPING CHANNEL SEPARATION MEASUREMENT**

**6.1 APPLIED PROCEDURES / LIMIT**

Frequency hopping systems operating in the 2400-2483.5 MHz band may have hopping channel carrier frequencies that are separated by 25 kHz or two-thirds of the 20 dB bandwidth of the hopping channel, whichever is greater.

Spectrum Parameter	Setting
Attenuation	Auto
Span Frequency	> Measurement Bandwidth or Channel Separation
RB	30 kHz (20dB Bandwidth) / 100 kHz (Channel Separation)
VB	100 kHz (20dB Bandwidth) / 100 kHz (Channel Separation)
Detector	Peak
Trace	Max Hold
Sweep Time	Auto

**6.1.1 TEST PROCEDURE**

- a. The transmitter output (antenna port) was connected to the spectrum analyser in peak hold mode.
- b. The resolution bandwidth of 30 kHz and the video bandwidth of 100 kHz were utilised for 20 dB bandwidth measurement.
- c. The resolution bandwidth of 100 kHz and the video bandwidth of 100 kHz were utilised for channel separation measurement.

**6.1.2 DEVIATION FROM STANDARD**

No deviation.

**6.1.3 TEST SETUP**

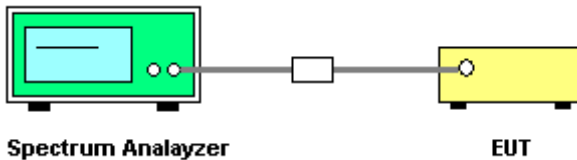

**6.1.4 EUT OPERATION CONDITIONS**

The EUT was programmed to be in continuously transmitting mode.

**6.1.5 TEST RESULTS**

EUT :	Car audio combine machine	Model Name :	PCD-42B
Temperature :	25 °C	Relative Humidity :	60%
Pressure :	1012 hPa	Test Voltage :	DC 12V from battery
Test Mode :	CH00 / CH39 /CH78 (1Mbps Mode)		

Frequency	Ch. Separation (MHz)	Result
2402 MHz	1.020	<b>Complies</b>
2441 MHz	1.010	<b>Complies</b>
2480 MHz	1.000	<b>Complies</b>

For GFSK:

**Ch. Separation Limits: > 20dB bandwidth**

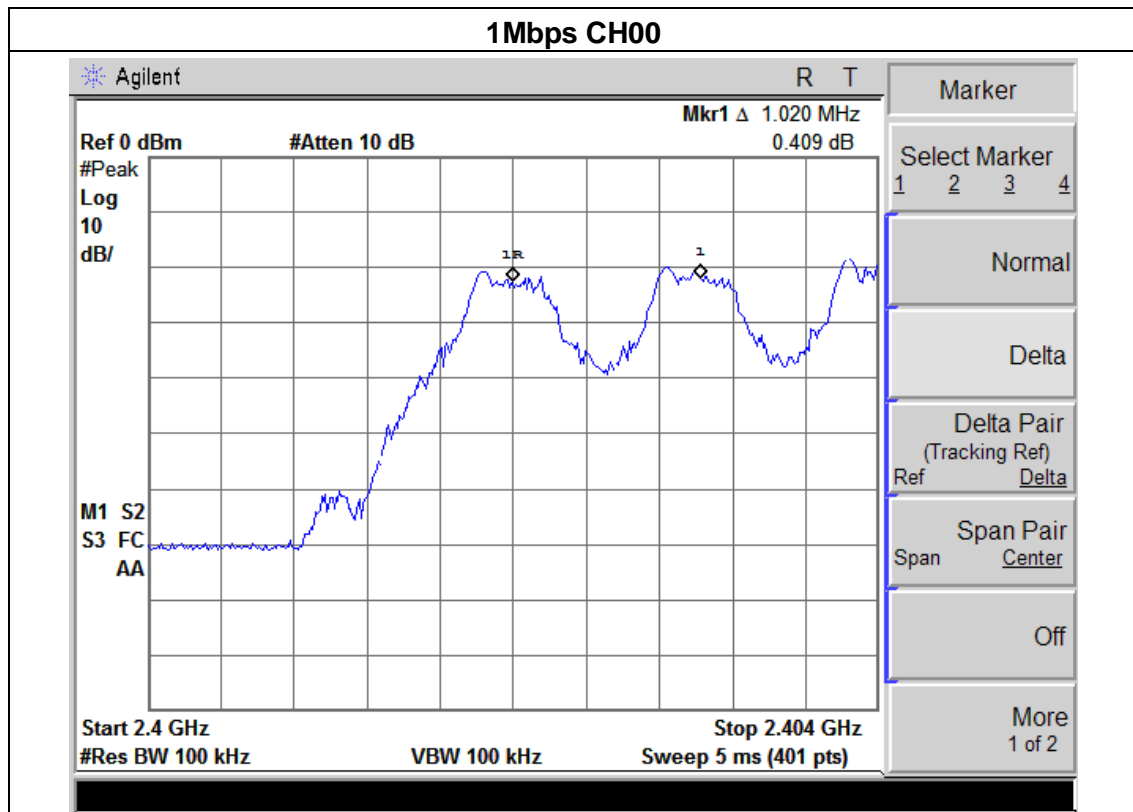

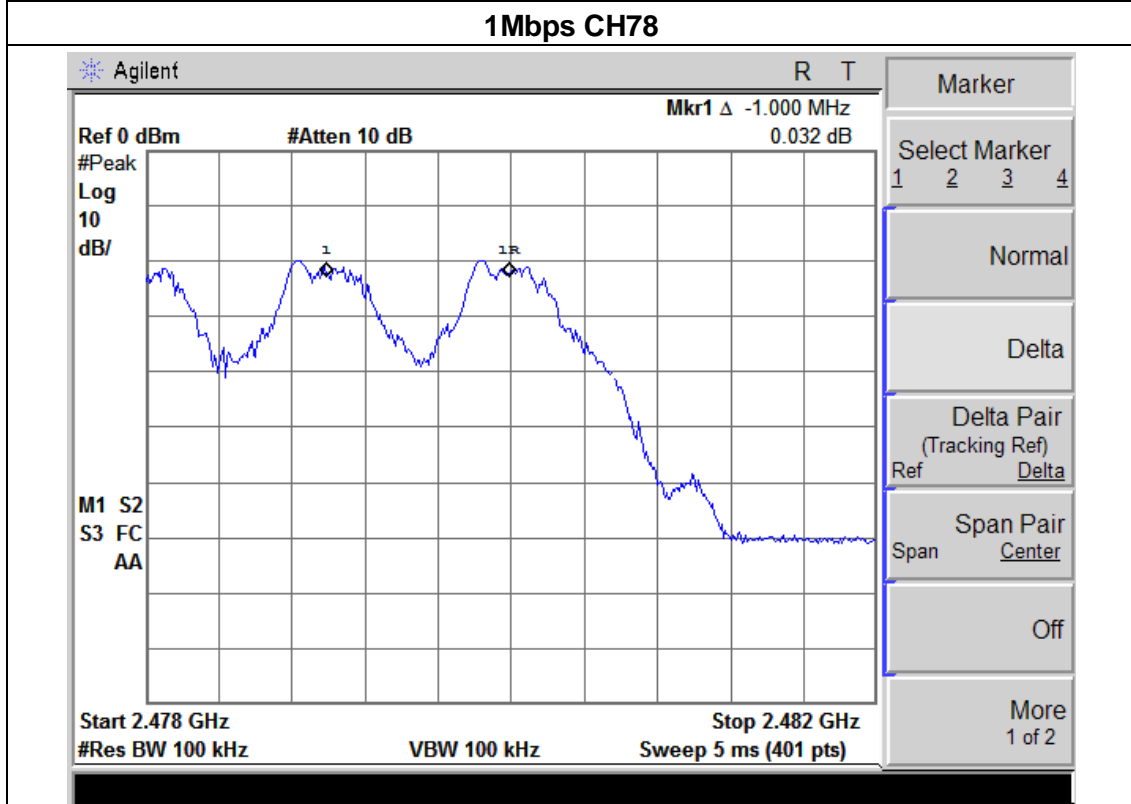
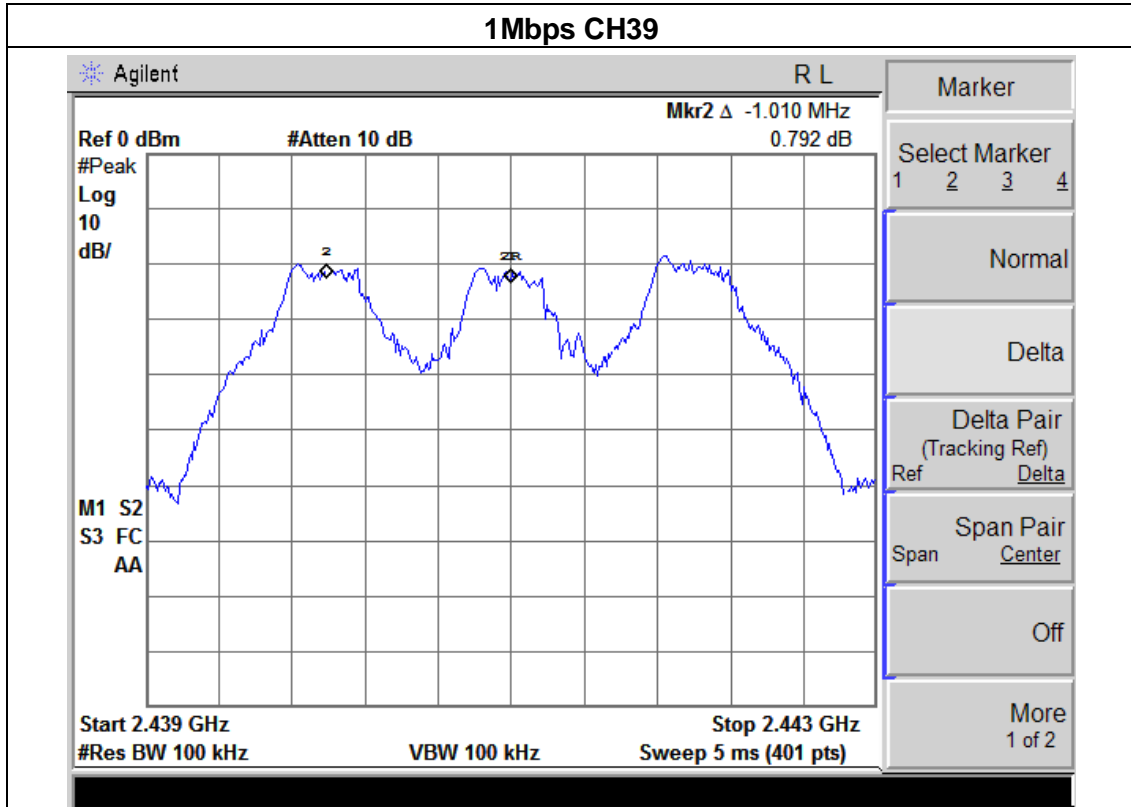



**7. BANDWIDTH TEST**

**7.1 APPLIED PROCEDURES / LIMIT**

FCC Part15 (15.247) , Subpart C				
Section	Test Item	Limit	Frequency Range (MHz)	Result
15.247 (a)(1)	Bandwidth	(20dB bandwidth)	2400-2483.5	PASS

Spectrum Parameter	Setting
Attenuation	Auto
Span Frequency	> Measurement Bandwidth or Channel Separation
RB	30 kHz (20dB Bandwidth) / 30 kHz (Channel Separation)
VB	100 kHz (20dB Bandwidth) / 30 kHz (Channel Separation)
Detector	Peak
Trace	Max Hold
Sweep Time	Auto

**7.1.1 TEST PROCEDURE**

- a. The EUT was directly connected to the spectrum analyzer and antenna output port as show in the block diagram below,
- b. Spectrum Setting : RBW= 30KHz, VBW=100KHz, Sweep time = Auto.

**7.1.2 DEVIATION FROM STANDARD**

No deviation.

**7.1.3 TEST SETUP**



**7.1.4 EUT OPERATION CONDITIONS**

The EUT tested system was configured as the statements of 2.4 Unless otherwise a special operating condition is specified in the follows during the testing.

**7.1.5 TEST RESULTS**

EUT :	Car audio combine machine	Model Name :	PCD-42B
Temperature :	25 °C	Relative Humidity :	60%
Pressure :	1012 hPa	Test Voltage :	DC 12V from battery
Test Mode :	CH00 / CH39 /C78 for GFSK		

Frequency	20dB Bandwidth (kHz)	Result
2402 MHz	811.212	<b>PASS</b>
2441 MHz	821.042	<b>PASS</b>
2480 MHz	826.153	<b>PASS</b>

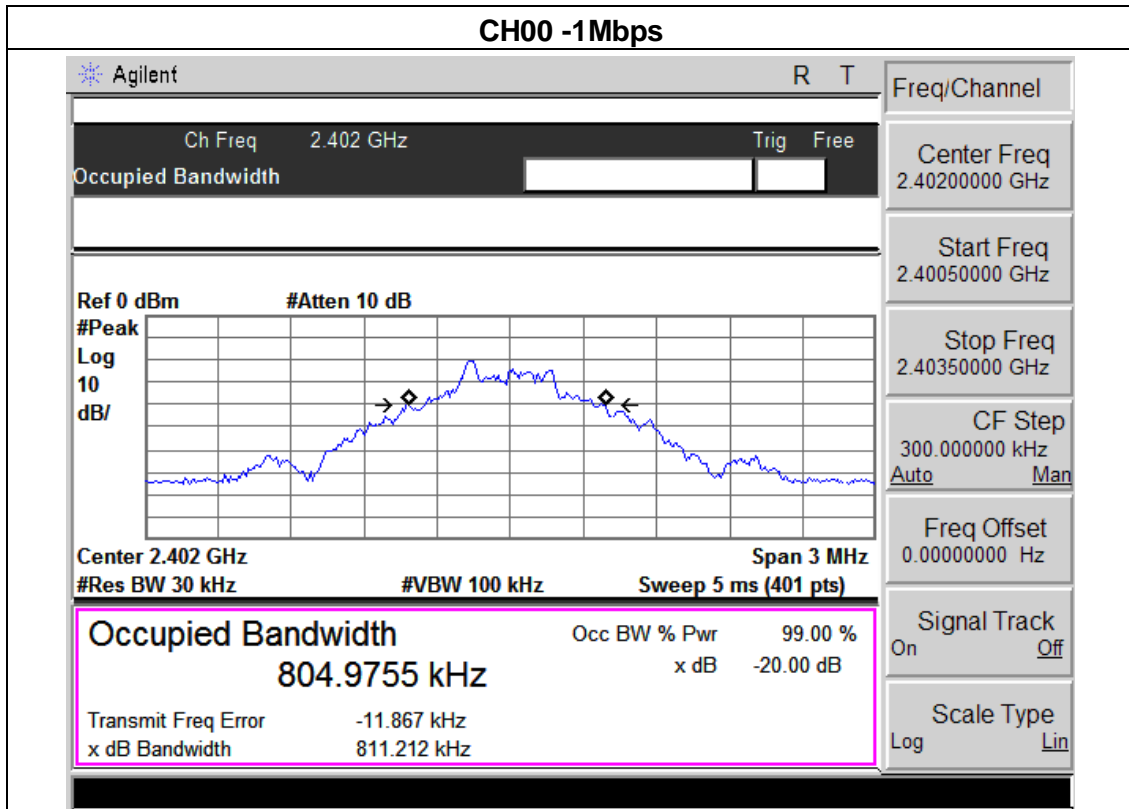

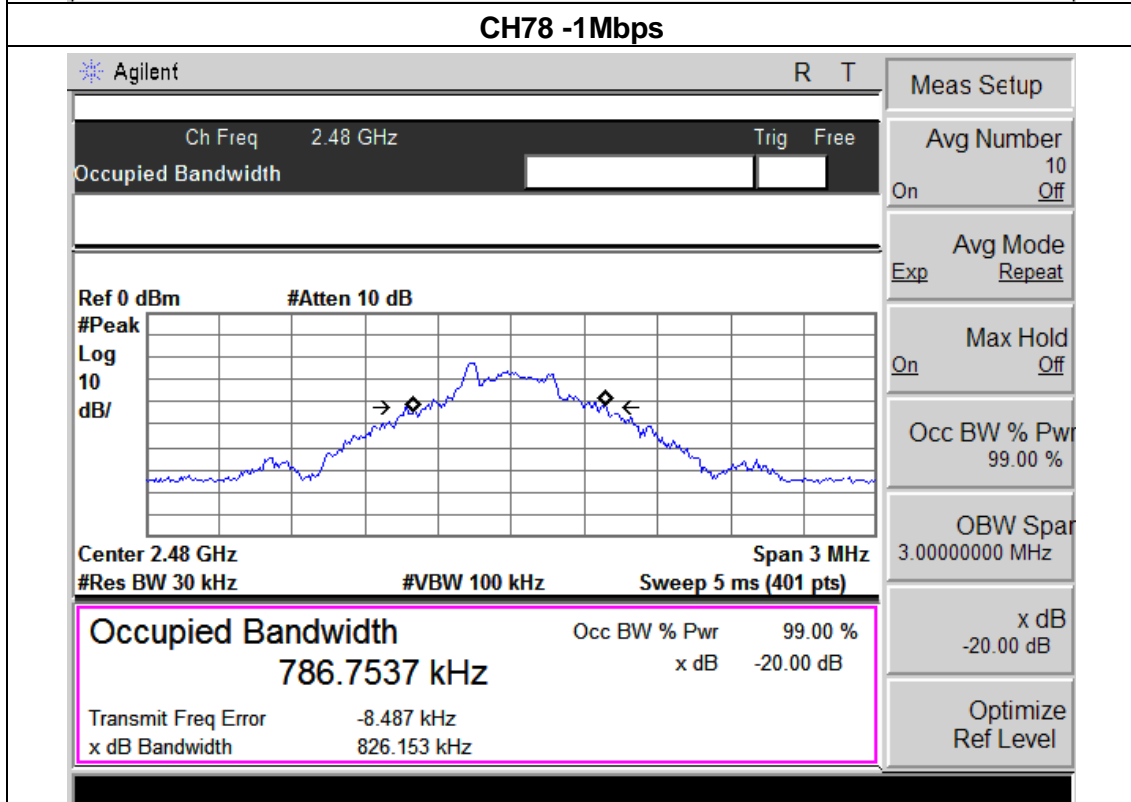
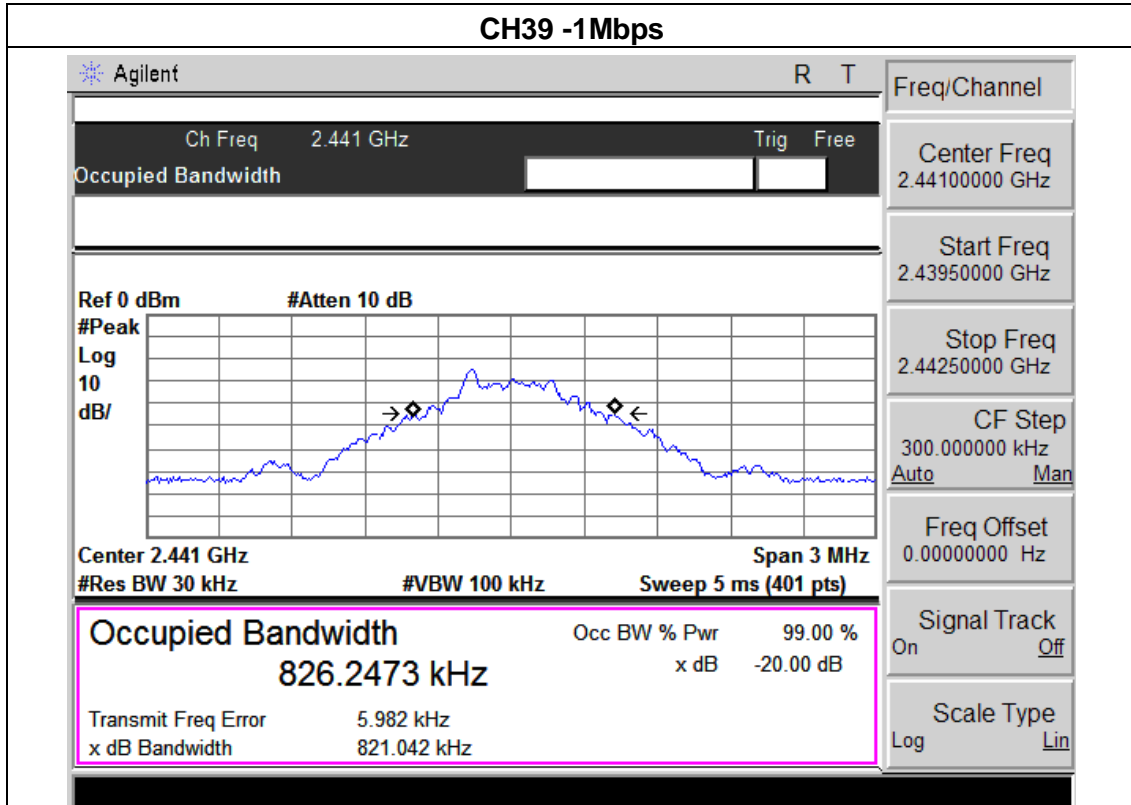

**8. PEAK OUTPUT POWER TEST**

**8.1 APPLIED PROCEDURES / LIMIT**

FCC Part15 (15.247) , Subpart C				
Section	Test Item	Limit	Frequency Range (MHz)	Result
15.247 (b)(i)	Peak Output Power	1 w or 30dBm for GFSK 0.125W or 21dBm for EDR	2400-2483.5	PASS

**8.1.1 TEST PROCEDURE**

- a. The EUT was directly connected to the Power meter

**8.1.2 DEVIATION FROM STANDARD**

No deviation.

**8.1.3 TEST SETUP**



**8.1.4 EUT OPERATION CONDITIONS**

The EUT tested system was configured as the statements of 2.4 Unless otherwise a special operating condition is specified in the follows during the testing.

**8.1.5 TEST RESULTS**

EUT :	Car audio combine machine	Model Name :	PCD-42B
Temperature :	25 °C	Relative Humidity :	60%
Pressure :	1012 hPa	Test Voltage :	DC 12V from battery
Test Mode :	CH00/ CH39 /CH78 (1Mbps Mode) for GFSK		

Test Channel	Frequency (MHz)	Peak Output Power (dBm)	LIMIT (dBm)	Result
CH00	2402	2.19	30	PASS
CH39	2441	2.11	30	PASS
CH78	2480	1.92	30	PASS

## **9. ANTENNA REQUIREMENT**

### **9.1 STANDARD REQUIREMENT**

15.203 requirement: For intentional device, according to 15.203: an intentional radiator shall be designed to ensure that no antenna other than that furnished by the responsible party shall be used with the device.

### **9.2 EUT ANTENNA**

The EUT antenna is integral Antenna. It comply with the standard requirement.

10. EUT TEST PHOTO

Radiated Measurement Photos

