



FCC Test Report

Report No.: AGC00014140302FE08

FCC ID : 2AB5T-HX-P740
APPLICATION PURPOSE : Original Equipment
PRODUCT DESIGNATION : Bluetooth Speaker
BRAND NAME : Jam
MODEL NAME : HX-P740
CLIENT : Shenzhen MeiDong Acoustics Co., LTD
DATE OF ISSUE : Apr.01, 2014
STANDARD(S) : FCC Part 15 Rules
REPORT VERSION : V1.0

Attestation of Global Compliance (Shenzhen) Co., Ltd

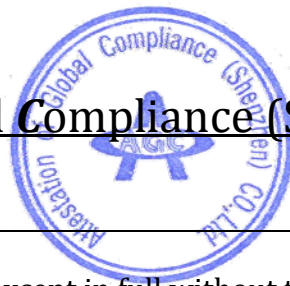

CAUTION:

This report shall not be reproduced except in full without the written permission of the test laboratory and shall not be quoted out of context.

Report Revise Record

Report Version	Revise Time	Issued Date	Valid Version	Notes
V1.0	/	Apr.01, 2014	Valid	Original Report

TABLE OF CONTENTS

1. VERIFICATION OF COMPLIANCE	5
2. GENERAL INFORMATION	6
2.1 PRODUCT DESCRIPTION	6
2.2 RELATED SUBMITTAL(S)/GRANT(S).....	6
2.3 TEST METHODOLOGY	6
2.4 TEST FACILITY.....	6
2.5 SPECIAL ACCESSORIES.....	6
2.6 EQUIPMENT MODIFICATIONS.....	6
2.7 MEASUREMENT UNCERTAINTY	7
3. SYSTEM TEST CONFIGURATION	8
3.1 CONFIGURATION OF TESTED SYSTEM	8
3.2 EQUIPMENT USED IN TESTED SYSTEM	8
4. SUMMARY OF TEST RESULTS	9
5. DESCRIPTION OF TEST MODES	9
6. ANTENNA REQUIREMENT	10
6.1. STANDARD APPLICABLE	10
6.2. TEST RESULT	10
7. RADIATED EMISSION	11
7.1 MEASUREMENT PROCEDURE.....	11
7.2 TEST SETUP.....	12
7.3 TEST EQUIPMENT	13
7.4 LIMITS AND MEASUREMENT RESULT	13
7.5 TEST RESULT	13
8. BAND EDGE EMISSION	26
8.1. MEASUREMENT PROCEDURE.....	26
8.2. TEST SET-UP	26
8.3. TEST RESULT	27
9. 6DB BANDWIDTH	31
9.1. TEST EQUIPMENT LIST AND DETAILS.....	31
9.2. TEST PROCEDURE.....	31
9.3. SUMMARY OF TEST RESULTS/PLOTS	31
10. CONDUCTED OUTPUT POWER	34
10.1. MEASUREMENT PROCEDURE.....	34
10.2. TEST SET-UP (BLOCK DIAGRAM OF CONFIGURATION).....	34
10.3. LIMITS AND MEASUREMENT RESULT	35
11. MAXIMUM CONDUCTED OUTPUT POWER SPECTRAL DENSITY	37

11.1 MEASUREMENT PROCEDURE	37
11.2 TEST SET-UP (BLOCK DIAGRAM OF CONFIGURATION).....	37
11.3 MEASUREMENT EQUIPMENT USED.....	37
11.4 LIMITS AND MEASUREMENT RESULT	37
12. FCC LINE CONDUCTED EMISSION TEST	40
12.1 LIMITS.....	40
12.2 TEST SETUP.....	40
12.3 PRELIMINARY PROCEDURE	41
12.4 FINAL TEST PROCEDURE.....	41
12.5 TEST RESULT OF POWER LINE	42
APPENDIX A: PHOTOGRAPHS OF TEST SETUP	44
APPENDIX B: PHOTOGRAPHS OF EUT	46

1. VERIFICATION OF COMPLIANCE

Applicant	Shenzhen MeiDong Acoustics Co., LTD
Address	Cell B, 3th Floor, Tower B, Hongzhuyongqi Technology Park, Lezhujiao, Xixiang, Baoan, Shenzhen, Guangdong, China
Manufacturer	Shenzhen MeiDong Acoustics Co., LTD
Address	Cell B, 3th Floor, Tower B, Hongzhuyongqi Technology Park, Lezhujiao, Xixiang, Baoan, Shenzhen, Guangdong, China
Product Designation	Bluetooth Speaker
Brand Name	Jam
Test Model	HX-P740
Date of test	Mar.26, 2014 to Mar.28, 2014
Deviation	None
Condition of Test Sample	Normal
Report Template	AGCRT-US-BLE/RF (2013-03-01)

WE HEREBY CERTIFY THAT:

The above equipment was tested by Attestation of Global Compliance (Shenzhen) Co., Ltd. The test data, data evaluation, test procedures, and equipment configurations shown in this report were made in accordance with the procedures given in ANSI C63.4 (2003) and the energy emitted by the sample EUT tested as described in this report is in compliance with requirement of FCC Part 15 Rules requirement.

Prepared By

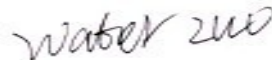

Water Zuo Apr.01, 2014

Checked By



Forrest Lei Apr.01, 2014

Authorized By



Solger Zhang Apr.01, 2014

2.GENERAL INFORMATION

2.1PRODUCT DESCRIPTION

The EUT is designed as a “Bluetooth Speaker ”. It is designed by way of utilizing the FHSS technology to achieve the system operation.

A major technical description of EUT is described as following

Operation Frequency	2.402 GHz to 2.480GHz
Bluetooth Version	V4.0
Modulation	GFSK
Number of channels	40 Channel(37 Hopping Channel,3 advertising Channel)
Antenna Designation	PCB Antenna
Antenna Gain	2.0dBi
Hardware Version	N/A
Software Version	N/A
Power Supply	DC3.7V by Built-in Li-ion Battery

2.2 RELATED SUBMITTAL(S)/GRANT(S)

This submittal(s) (test report) is intended for **FCC ID: 2AB5T-HX-P740** filing to comply with Section 15.247of the FCC Part 15, Subpart C Rules.

2.3TEST METHODOLOGY

All measurements contained in this report were conducted with ANSI C63.4-2003, American National Standard for Methods of Measurement of Radio-Noise Emissions from Low-Voltage Electrical and Electronic Equipment in the range of 9 kHz to 40 GHz.

The equipment under test (EUT) was configured to measure its highest possible emission level. The test modes were adapted accordingly in reference to the Operating Instructions. The EUT was tested in all three orthogonal planes and the worse case was showed.

2.4 TEST FACILITY

All measurement facilities used to collect the measurement data are located at Attestation of Global Compliance (Shenzhen) Co, Ltd

2/F., Building 2, No.1-No.4, Chaxi Sanwei Technical Industrial Park, Gushu, Xixiang, Bao'an District, Shenzhen, Guangdong, China.

FCC register No.: 259865

2.5 SPECIAL ACCESSORIES

Refer to section 2.2.

2.6 EQUIPMENT MODIFICATIONS

Not available for this EUT intended for grant.

2.7 MEASUREMENT UNCERTAINTY

Radiation Emission: +/-3.2

Conduction Emission: +/-2.5

3. SYSTEM TEST CONFIGURATION

3.1 CONFIGURATION OF TESTED SYSTEM

Configuration: Normal Operating

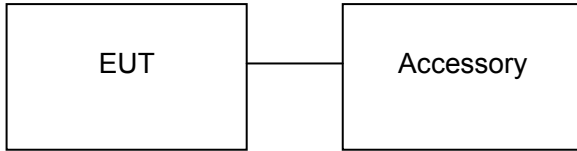

Configuration: Continuous TX

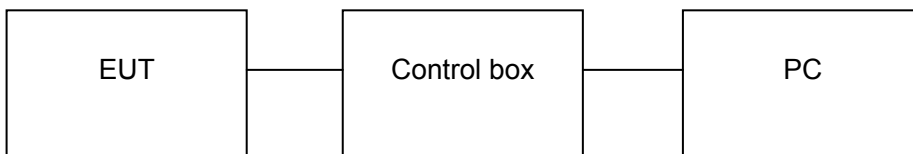

3.2 EQUIPMENT USED IN TESTED SYSTEM

Item	Equipment	Mfr/Brand	Model/Type No.	Remark
1	Bluetooth Speaker	Jam	HX-P740	EUT
2	Battery	N/A	N/A	Accessory
3	PC	Dell	INSPIRON	A.E
4	Control box	N/A	N/A	A.E
5	Adapter	jam	TPKB0095015000	Accessory

4. SUMMARY OF TEST RESULTS

FCC RULES	DESCRIPTION OF TEST	RESULT
§ 15.203	Antenna Requirement	Compliant
§15.209 §15.247(d)	Radiated Emission	Compliant
§15.247(d)	Band Edges	Compliant
§15.247	6 dB Bandwidth	Compliant
§15.247(b)	Conducted Power	Compliant
§15.247(e)	Maximum Conducted Output Power SPECTRAL Density	Compliant
§15.207	Line Conduction Emission	Compliant

5. DESCRIPTION OF TEST MODES

The EUT has been operated in one modulation: GFSK .

NO.	TEST MODE DESCRIPTION
1	Low channel TX
2	Middle channel TX
3	High channel TX
4	Normal Hopping

Note:

- All the test modes can be supply by Built-in Li-ion battery, only the result of the worst case was recorded in the report if no any records.
- For Radiated Emission, 3axis were chosen for testing for each applicable mode.
- Normal Hopping mode include charging condition.

6. ANTENNA REQUIREMENT

6.1. STANDARD APPLICABLE

According to FCC 15.203, An intentional radiator shall be designed to ensure that no antenna other than that furnished by the responsible party shall be used with the device. The use of a permanently attached antenna or of an antenna that uses a unique coupling to the intentional radiator shall be considered sufficient to comply with the provisions of this Section. The manufacturer may design the unit so that a broken antenna can be replaced by the user, but the use of a standard antenna jack or electrical connector is prohibited. This requirement does not apply to carrier current devices or to devices operated under the provisions of Sections 15.211, 15.213, 15.217, 15.219, or 15.221. Further, this requirement does not apply to intentional radiators that must be professionally installed, such as perimeter protection systems and some field disturbance sensors, or to other intentional radiators which, in accordance with Section 15.31(d), must be measured at the installation site. However, the installer shall be responsible for ensuring that the proper antenna is employed so that the limits in this Part are not exceeded.

6.2. TEST RESULT

This product has a permanent antenna, fulfill the requirement of this section.

7. RADIATED EMISSION

7.1 MEASUREMENT PROCEDURE

1. Configure the EUT according to ANSI C63.4. The EUT was placed on the top of the turntable 0.8 meter above ground. The phase center of the receiving antenna mounted on the top of a height-variable antenna tower was placed 3 meters far away from the turntable.
2. Power on the EUT and all the supporting units. The turntable was rotated by 360 degrees to determine the position of the highest radiation.
3. The height of the broadband receiving antenna was varied between one meter and four meters above ground to find the maximum emissions field strength of both horizontal and vertical polarization.
4. For each suspected emissions, the antenna tower was scan (from 1 M to 4 M) and then the turntable was rotated (from 0 degree to 360 degrees) to find the maximum reading.
5. Set the test-receiver system to Peak or CISPR quasi-peak Detect Function with specified bandwidth under Maximum Hold Mode.
6. For emissions above 1GHz, use 1MHz VBW and RBW for peak reading. Then 1MHz RBW and 10Hz VBW for average reading in spectrum analyzer.
7. When the radiated emissions limits are expressed in terms of the average value of the emissions, and pulsed operation is employed, the measurement field strength shall be determined by averaging over one complete pulse train, including blanking intervals, as long as the pulse train does not exceed 0.1 seconds. As an alternative (provided the transmitter operates for longer than 0.1 seconds) or in cases where the pulse train exceeds 0.1 seconds, the measured field strength shall be determined from the average absolute voltage during a 0.1 second interval during which the field strength is at its maximum values.
8. If the emissions level of the EUT in peak mode was 3 dB lower than the average limit specified, then testing will be stopped and peak values of EUT will be reported, otherwise, the emissions which do not have 3 dB margin will be repeated one by one using the quasi-peak method for below 1GHz.
9. For testing above 1GHz, the emissions level of the EUT in peak mode was lower than average limit (that means the emissions level in peak mode also complies with the limit in average mode), then testing will be stopped and peak values of EUT will be reported, otherwise, the emissions will be measured in average mode again and reported.
10. In case the emission is lower than 30MHz, loop antenna has to be used for measurement and the recorded data should be QP measured by receiver. High - Low scan is not required in this case.

7.2 TEST SETUP

RADIATED EMISSION TEST SETUP BELOW 30MHz

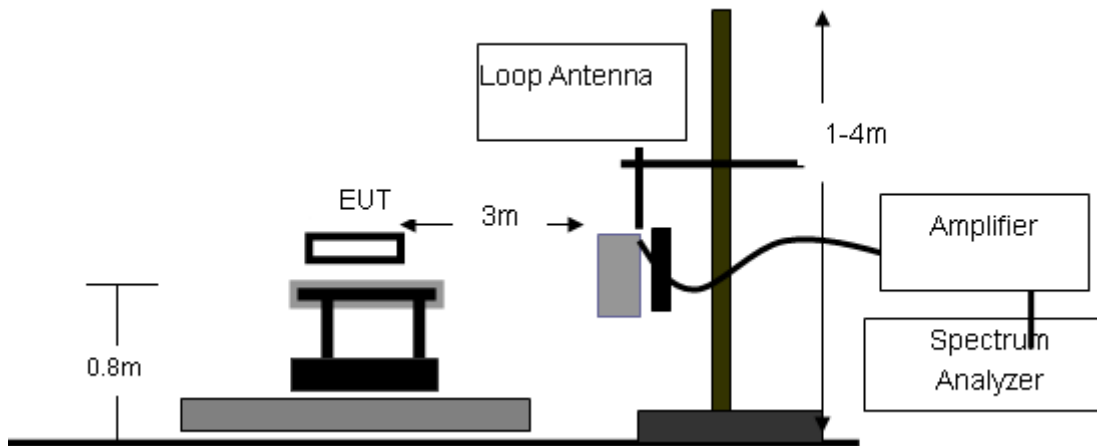

RADIATED EMISSION TEST SETUP 30MHz-1000MHz

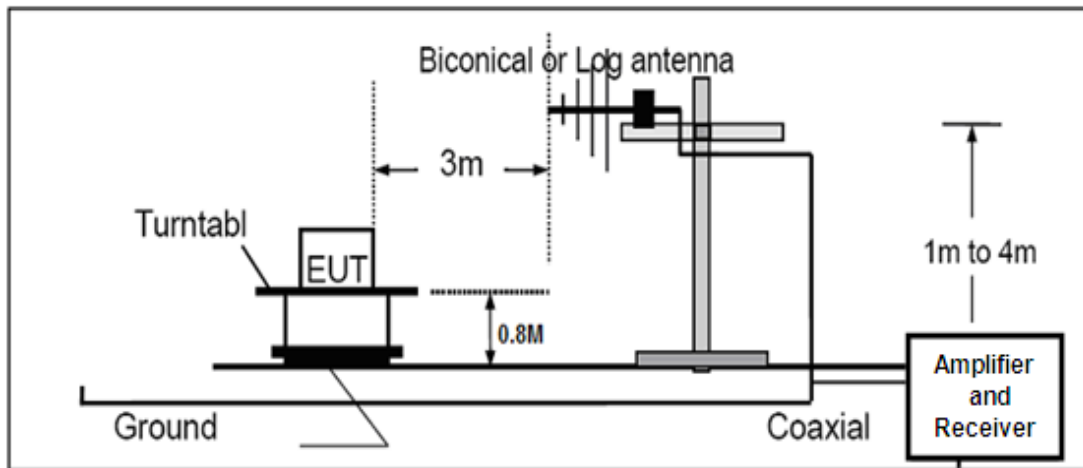

RADIATED EMISSION TEST SETUP ABOVE 1000MHz

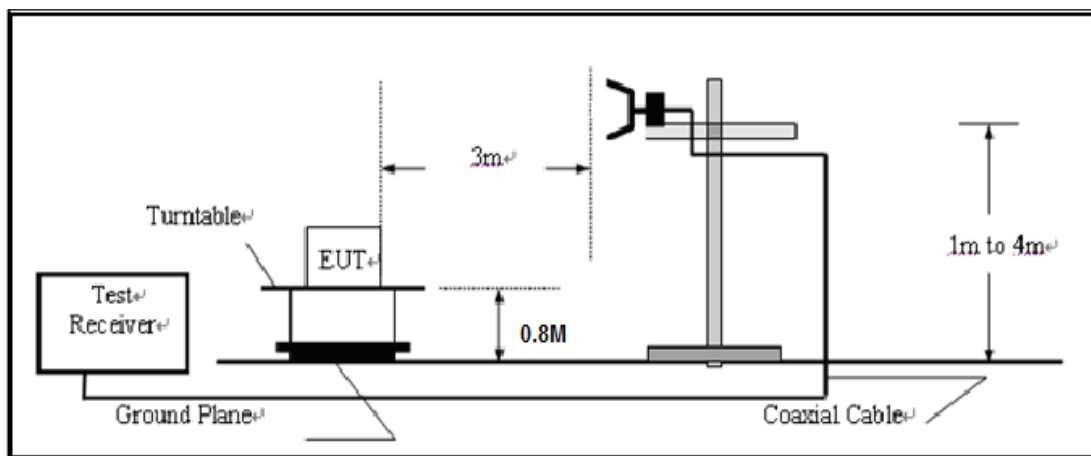

7.3 TEST EQUIPMENT

Description	Manufacturer	Model	S/N	Cal. Date	Cal. Due
Amplifier	EM	EM30180	0607030	02/28/2014	02/27/2015
Horn Antenna	EM	EM-AH-10180	67	04/20/2013	04/19/2014
Horn Antenna	A.H. Systems Inc.	SAS-574	--	07/17/2013	07/16/2014
EMI Test Receiver	Rohde & Schwarz	ESCI	100694	07/17/2013	07/16/2014
Biological Antenna	A.H. Systems Inc.	SAS-521-4	26	06/07/2013	06/06/2014
Loop Antenna	Daze	ZN30900N	SEL0097	07/17/2013	07/16/2014
Isolation Transformer	LETEAC	LTBK	--	07/17/2013	07/16/2014

7.4 LIMITS AND MEASUREMENT RESULT

15.209 Limit in the below table has to be followed

Frequencies (MHz)	Field Strength (micorvolts/meter)	Measurement Distance (meters)
0.009~0.490	2400/F(KHz)	300
0.490~1.705	24000/F(KHz)	30
1.705~30.0	30	30
30~88	100	3
88~216	150	3
216~960	200	3
Above 960	500	3

Note: All modes were tested For restricted band radiated emission, the test records reported below are the worst result compared to other modes.

7.5 TEST RESULT

RADIATED EMISSION BELOW 30MHZ

No emission found between lowest internal used/generated frequencies to 30MHz.

RADIATED EMISSION BELOW 1GHZ
RADIATED EMISSION TEST- (30MHZ-1GHZ)-LOW CHANNEL-HOBRIZONTAL
Radiated Emission Measurement

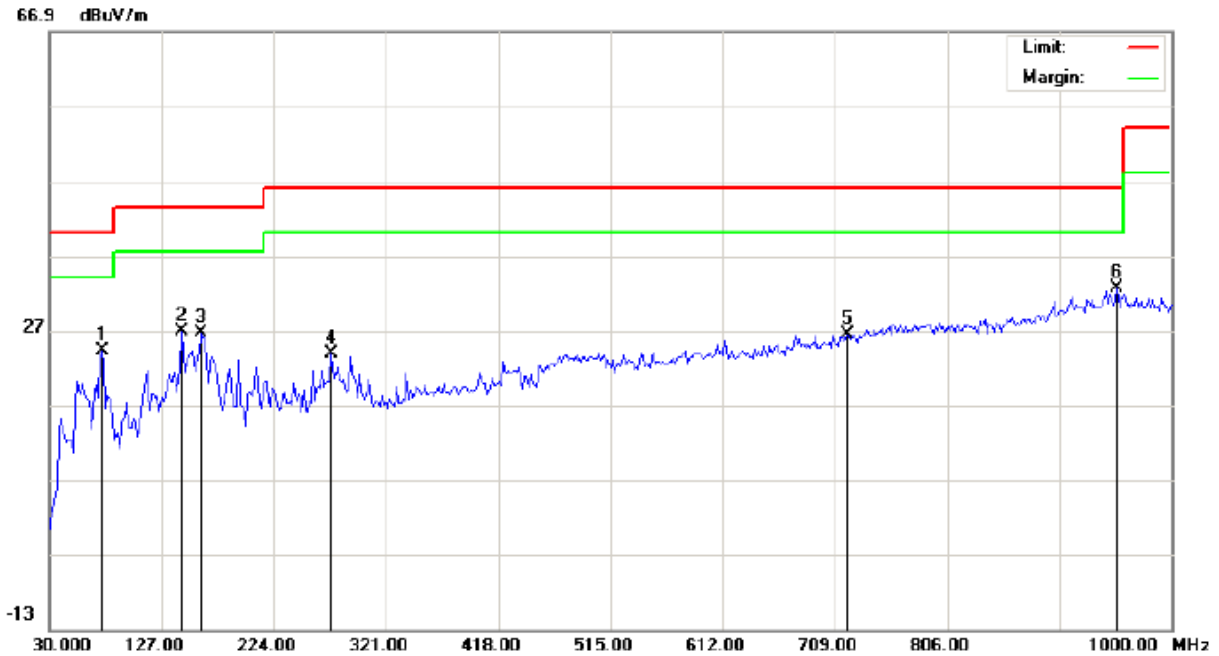

Site: site #1	Polarization: <i>Horizontal</i>	Temperature: 26
Limit: FCC Class B 3M Radiation	Power:	Humidity: 60 %
EUT: Bluetooth Speaker	Distance:	
M/N: HX-P740		
Mode: Low Channel TX		
Note:		

No.	Mk	Freq.	Reading	Factor	Measurement	Limit	Over	Detector	Antenna	Table	Comment
		MHz	dBuV	dB/m	dBuV/m	dBuV/m	dB		Height	Degree	
									cm	degree	
1		75.2667	14.16	10.02	24.18	40.00	-15.82	peak			
2		144.7833	11.52	15.23	26.75	43.50	-16.75	peak			
3		160.9500	11.55	15.13	26.68	43.50	-16.82	peak			
4		274.1167	9.13	14.63	23.76	46.00	-22.24	peak			
5		720.3167	0.57	25.78	26.35	46.00	-19.65	peak			
6	*	953.1167	2.66	29.97	32.63	46.00	-13.37	peak			

RESULT: PASS

RADIATED EMISSION TEST- (30MHZ-1GHZ)-LOW CHANNEL -VERTICAL
Radiated Emission Measurement

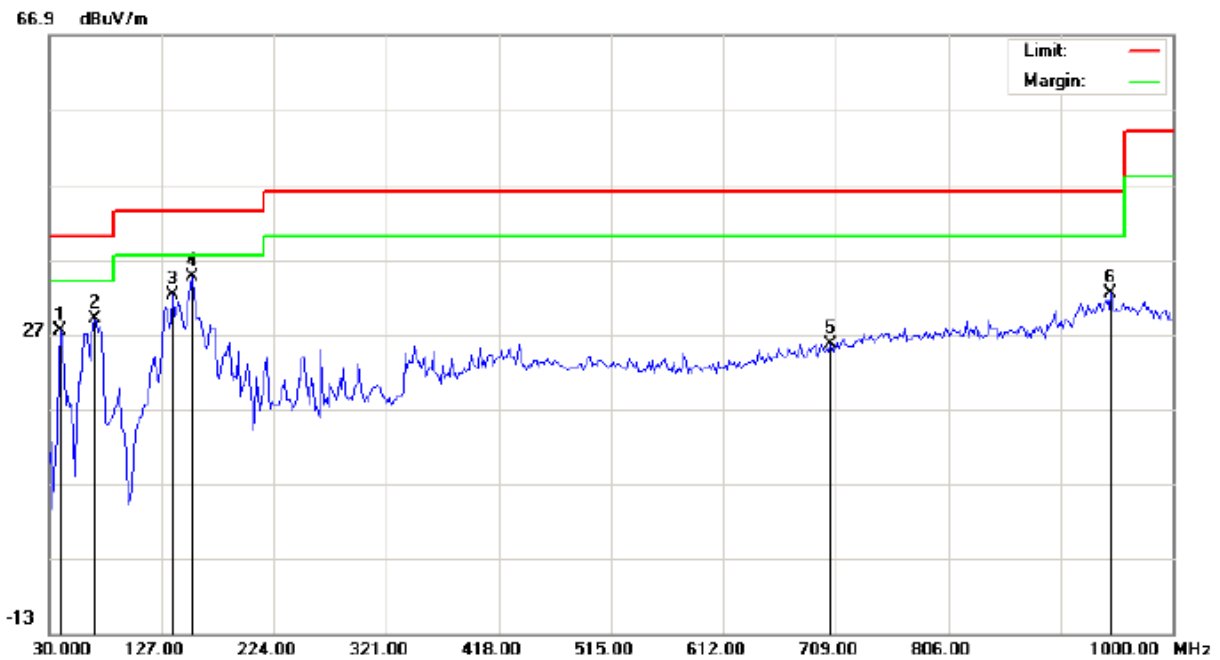

Site: site #1
Limit: FCC Class B 3M Radiation
EUT: Bluetooth Speaker
M/N: HX-P740
Mode: Low channel TX
Note:

Polarization: *Vertical*
Power:
Distance:

Temperature: 26
Humidity: 60 %

No.	Mk	Freq.	Reading	Factor	Measurement	Limit	Over	Detector	Antenna Height	Table Degree	Comment
		MHz	dBuV	dB/m	dBuV/m	dBuV/m	dB		cm	degree	
1		39.7000	18.90	8.51	27.41	40.00	-12.59	peak			
2		68.8000	24.22	4.73	28.95	40.00	-11.05	peak			
3		136.7000	18.41	13.82	32.23	43.50	-11.27	peak			
4	*	152.8667	19.39	15.28	34.67	43.50	-8.83	peak			
5		704.1500	0.26	25.31	25.57	46.00	-20.43	peak			
6		946.6500	2.49	29.91	32.40	46.00	-13.60	peak			

RESULT: PASS

Note: 1. Factor=Antenna Factor + Cable loss, Margin=Measurement-Limit.

2. The "Factor" value can be calculated automatically by software of measurement system.

RADIATED EMISSION TEST- (30MHZ-1GHZ)-MIDDLE CHANNEL-HORIZONTAL

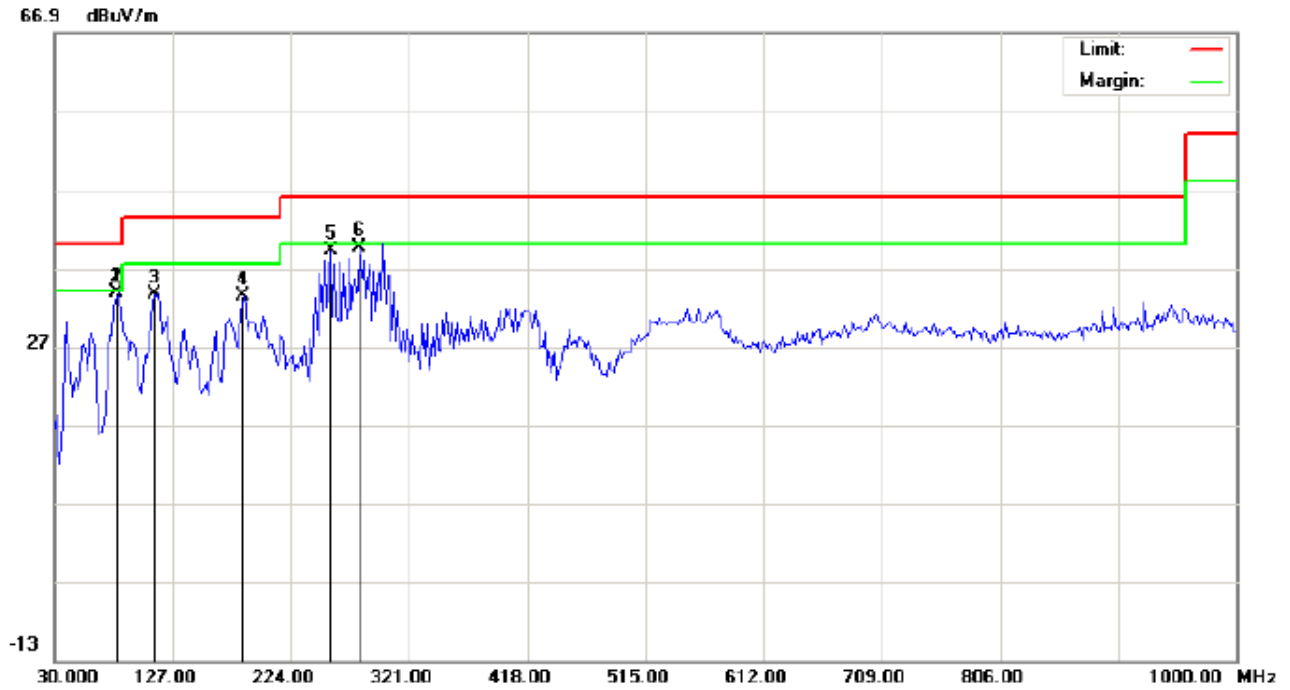

Site: site #1
Limit: FCC Class B 3M Radiation
EUT:Bluetooth Speaker
M/N:HX-P740
Mode: Middle channel TX
Note:

Polarization: *Horizontal*
Power:
Distance:

Temperature: 26
Humidity: 60 %

No.	Mk	Freq.	Reading	Factor	Measurement	Limit	Over	Detector	Antenna Height	Table Degree	Comment
		MHz	dBuV	dB/m	dBuV/m	dBuV/m	dB		cm	degree	
1	*	81.7330	24.16	9.73	33.89	40.00	-6.11	peak			
2	*	81.7330	24.16	9.73	33.89	40.00	-6.11	peak			
3		112.4500	22.21	11.34	33.55	43.50	-9.95	peak			
4		185.1999	22.05	11.31	33.36	43.50	-10.14	peak			
5		256.3333	25.14	14.09	39.23	46.00	-6.77	peak			
6		280.5833	24.78	14.82	39.60	46.00	-6.40	peak			

RESULT: PASS

RADIATED EMISSION TEST- (30MHZ-1GHZ)- MIDDLE CHANNEL -VERTICAL

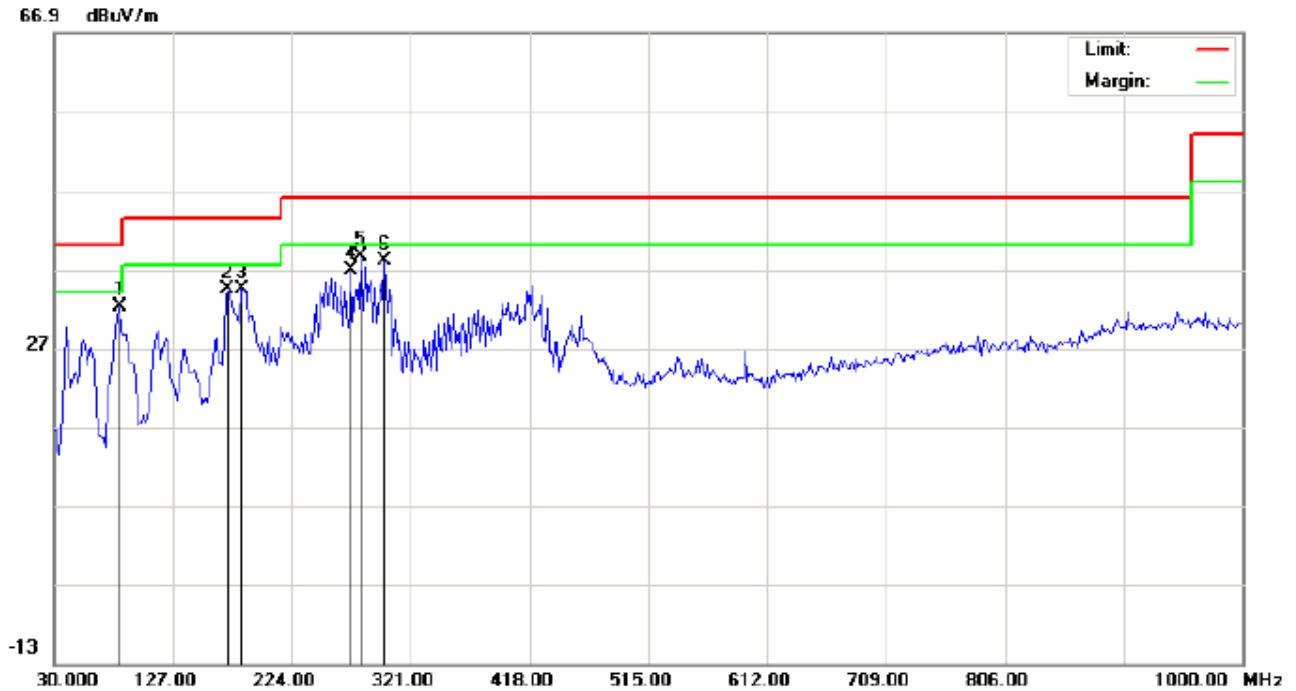

Site: site #1
Limit: FCC Class B 3M Radiation
EUT:Bluetooth Speaker
M/N:HX-P740
Mode: Middle channel TX
Note:

Polarization: *Vertical*
Power:
Distance:

Temperature: 26
Humidity: 60 %

No.	Mk	Freq.	Reading	Factor	Measurement	Limit	Over	Detector	Antenna	Table	Comment
		MHz	dBuV	dB/m	dBuV/m	dBuV/m	dB		Height	Degree	
									cm	degree	
1		83.3499	29.18	3.00	32.18	40.00	-7.82	peak			
2		172.2666	19.77	14.56	34.33	43.50	-9.17	peak			
3		183.5833	21.25	13.16	34.41	43.50	-9.09	peak			
4		272.5000	22.16	14.58	36.74	46.00	-9.26	peak			
5	*	280.5833	23.87	14.82	38.69	46.00	-7.31	peak			
6		299.9832	22.68	15.41	38.09	46.00	-7.91	peak			

RESULT: PASS

Note: 1. Factor=Antenna Factor + Cable loss, Margin=Measurement-Limit.

2. The "Factor" value can be calculated automatically by software of measurement system.

RADIATED EMISSION TEST- (30MHZ-1GHZ)-HIGH CHANNEL-HORIZONTAL

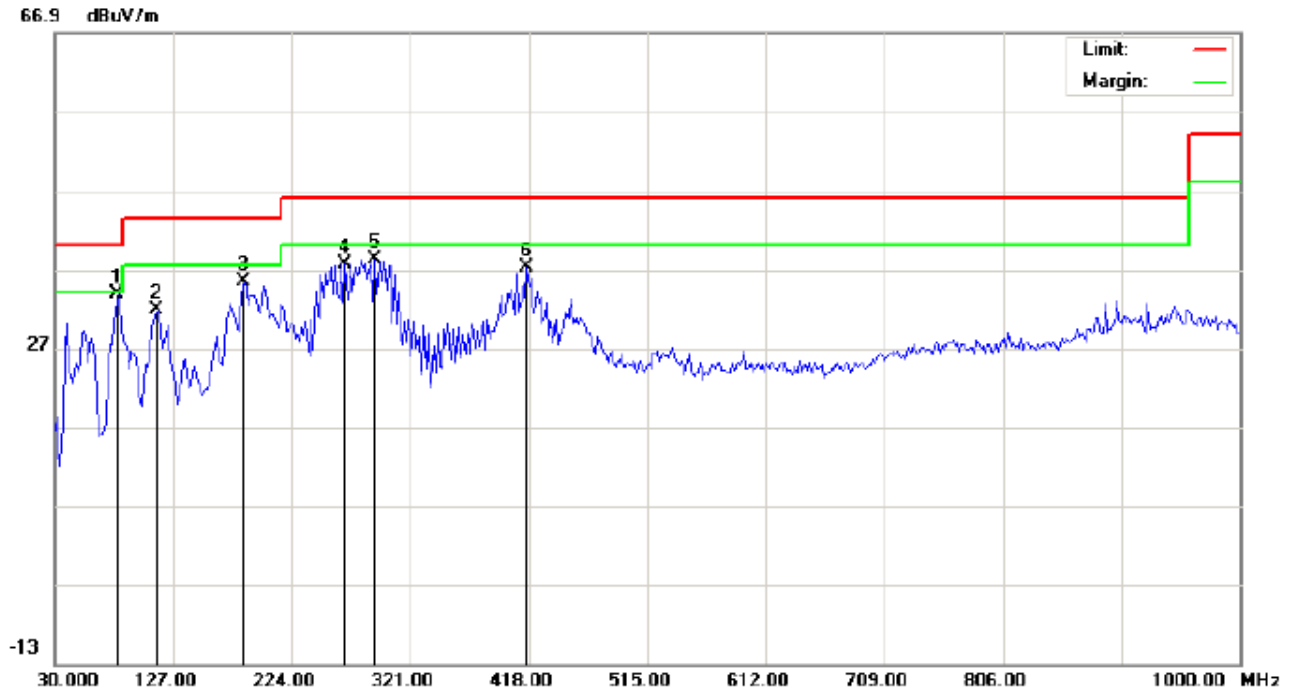

Site: site #1
Limit: FCC Class B 3M Radiation
EUT:Bluetooth Speaker
M/N:HX-P740
Mode: High channel TX
Note:

Polarization: *Horizontal*
Power:
Distance:

Temperature: 26
Humidity: 60 %

No.	Mk	Freq.	Reading	Factor	Measurement	Limit	Over	Detector	Antenna Height	Table Degree	Comment
		MHz	dBuV	dB/m	dBuV/m	dBuV/m	dB		cm	degree	
1	*	81.7330	24.16	9.73	33.89	40.00	-6.11	peak			
2		114.0665	20.27	11.45	31.72	43.50	-11.78	peak			
3		185.1999	24.05	11.31	35.36	43.50	-8.14	peak			
4		267.6499	23.23	14.43	37.66	46.00	-8.34	peak			
5		291.8999	22.96	15.17	38.13	46.00	-7.87	peak			
6		416.3833	17.55	19.57	37.12	46.00	-8.88	peak			

RESULT: PASS

RADIATED EMISSION TEST- (30MHZ-1GHZ)-HIGH CHANNEL -VERTICAL

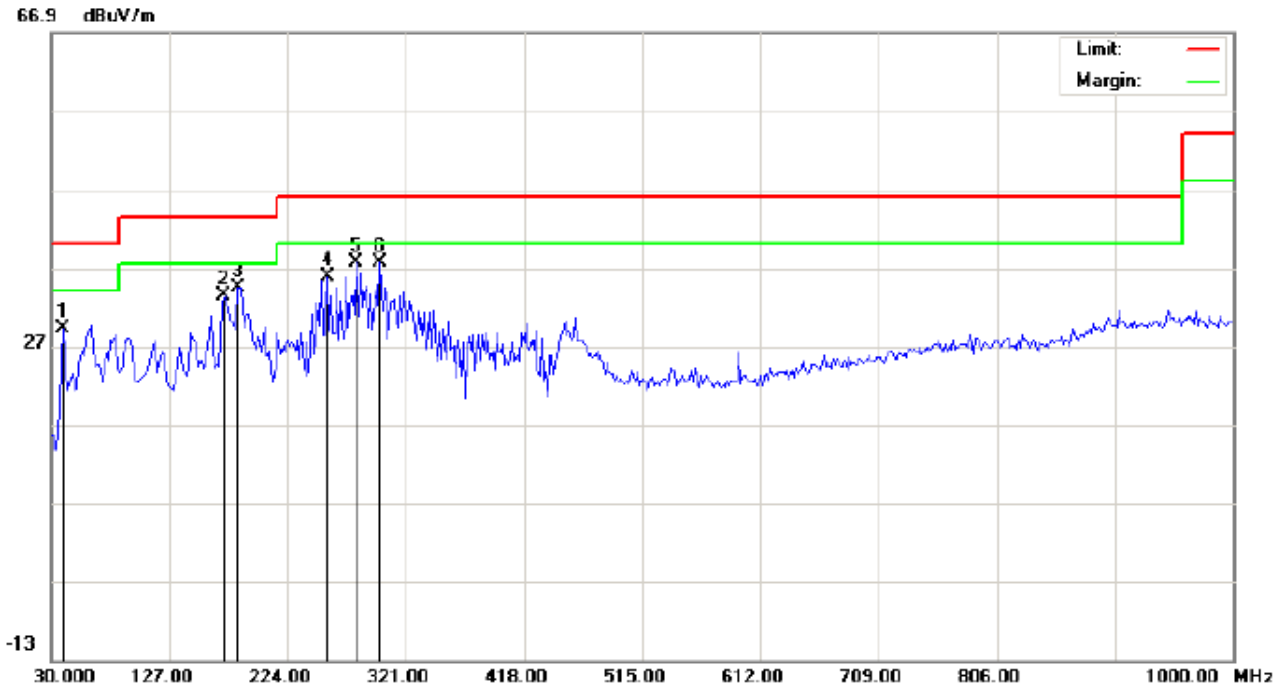

Site: site #1
 Limit: FCC Class B 3M Radiation
 EUT:Bluetooth Speaker
 M/N:HX-P740
 Mode: High channel TX
 Note:

Polarization: *Vertical*
 Power:
 Distance:

Temperature: 26
 Humidity: 60 %

No.	Mk	Freq.	Reading	Factor	Measurement	Limit	Over	Detector	Antenna Height	Table Degree	Comment
		MHz	dBuV	dB/m	dBuV/m	dBuV/m	dB		cm	degree	
1		39.7000	20.64	8.51	29.15	40.00	-10.85	peak			
2		172.2666	18.77	14.56	33.33	43.50	-10.17	peak			
3		183.5833	21.25	13.16	34.41	43.50	-9.09	peak			
4		256.3333	21.72	14.09	35.81	46.00	-10.19	peak			
5	*	280.5833	22.87	14.82	37.69	46.00	-8.31	peak			
6		299.9832	22.18	15.41	37.59	46.00	-8.41	peak			

RESULT: PASS

Note: 1. Factor=Antenna Factor + Cable loss, Margin=Measurement-Limit.

2. The "Factor" value can be calculated automatically by software of measurement system.

RADIATED EMISSION TEST-(ABOVE 1GHZ)-LOW CHANNEL-VERTICAL

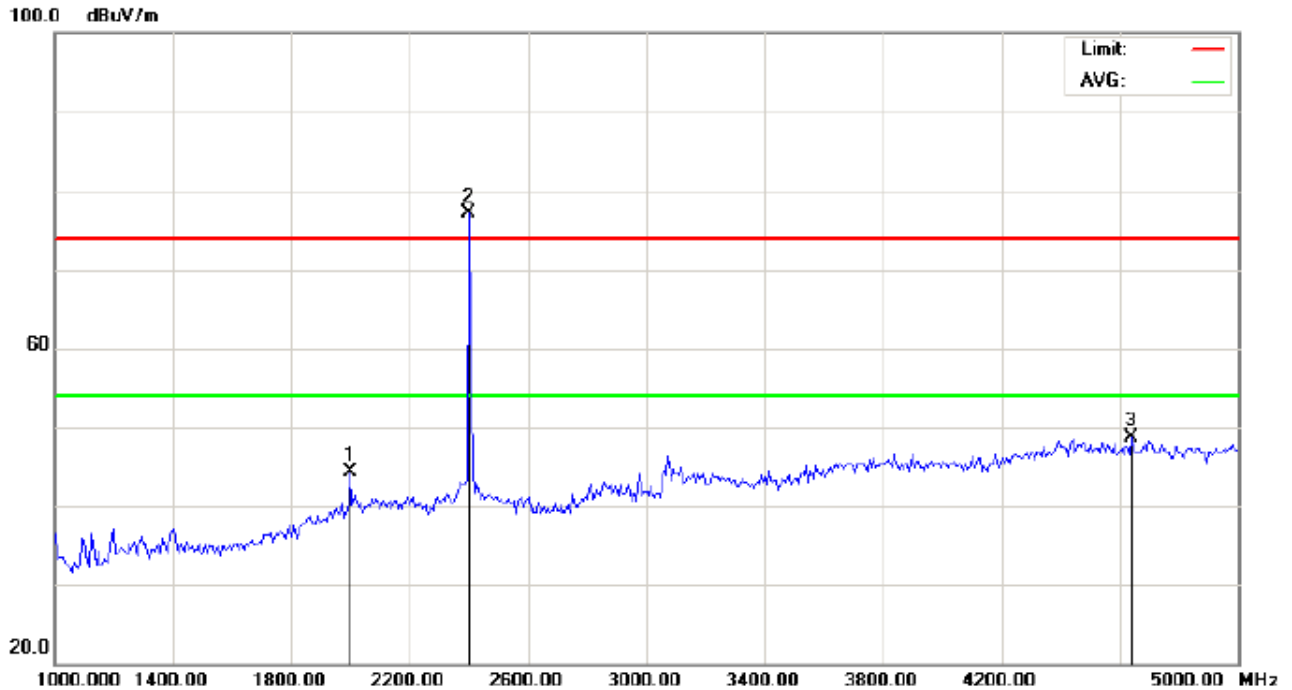

Site: site #1 Polarization: *Vertical* Temperature: 26
Limit: FCC Class B 3M Radiation above 1GHZ(PK) Power: Humidity: 60 %
EUT:Bluetooth Speaker Distance:
M/N:HX-P740
Mode: Low channel TX
Note:

No.	Mk	Freq.	Reading	Factor	Measurement	Limit	Over	Detector	Antenna Height	Table Degree	Comment
		MHz	dBuV	dB/m	dBuV/m	dBuV/m	dB		cm	degree	
1		2000.000	54.49	-10.12	44.37	74.00	-29.63	peak			
2	*	2400.000	86.70	-9.68	77.02	74.00	3.02	peak			
3		4640.000	51.39	-2.74	48.65	74.00	-25.35	peak			

RESULT: PASS

Note: 1. Factor=Antenna Factor + Cable loss, Margin=Measurement-Limit.
2. The "Factor" value can be calculated automatically by software of measurement system.

8. BAND EDGE EMISSION

8.1. MEASUREMENT PROCEDURE

1. Set the EUT Work on the top, the bottom operation frequency individually.
2. Set Span = 2MHz, RBW \geq 100 KHz, VBW \geq 3RBW, Center frequency =Operation frequency
3. The band edges was measured and recorded.

8.2. TEST SET-UP

Radiated same as 7.2

TEST PLOT OF BAND EDGE FOR LOW CHANNEL - Vertical

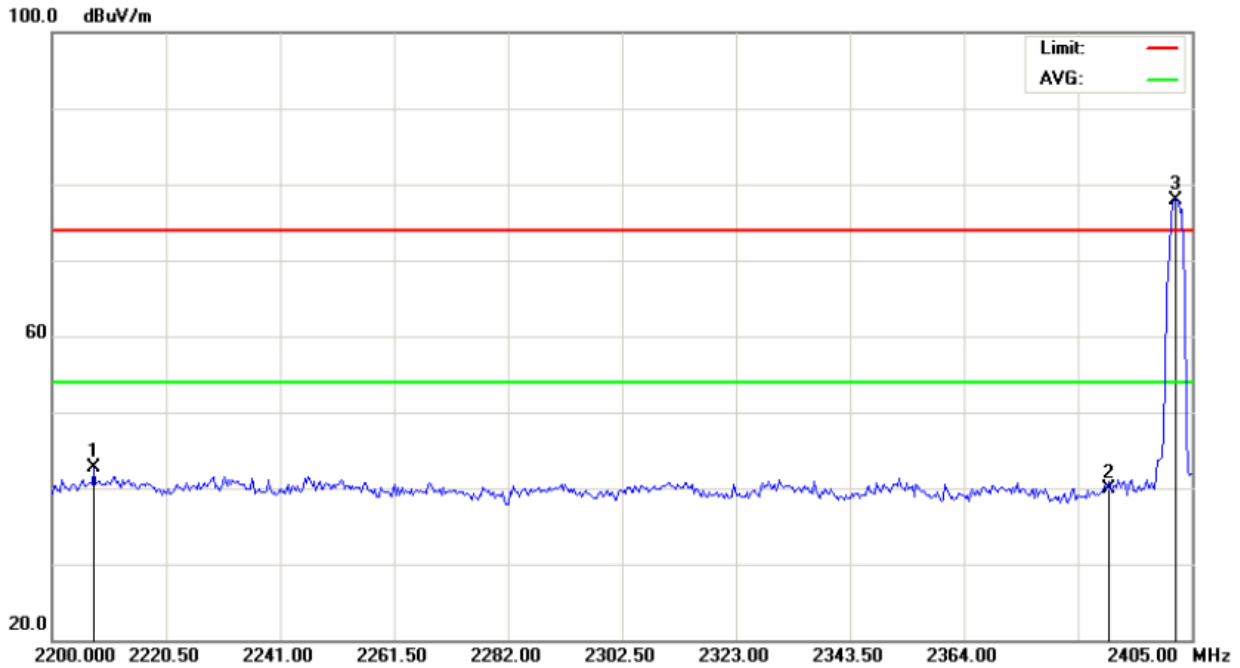

Site: site #1
Limit: FCC Class B 3M Radiation above 1GHZ(PK)
EUT: Bluetooth Speaker
M/N:HX-P740
Mode: Low Channel TX
Note:

Polarization: *Vertical*
Power:
Distance:

Temperature: 26
Humidity: 60 %

No.	Mk	Freq.	Reading	Factor	Measurement	Limit	Over	Detector	Antenna Height	Table Degree	Comment
		MHz	dBuV	dB/m	dBuV/m	dBuV/m	dB		cm	degree	
1		2207.517	52.53	-9.89	42.64	74.00	-31.36	peak			
2		2390.000	49.51	-9.69	39.82	74.00	-34.18	peak			
3	*	2402.000	87.61	-9.68	77.93	74.00	3.93	peak			

RESULT: PASS

TEST PLOT OF BAND EDGE FOR HIGH CHANNEL –Horizontal

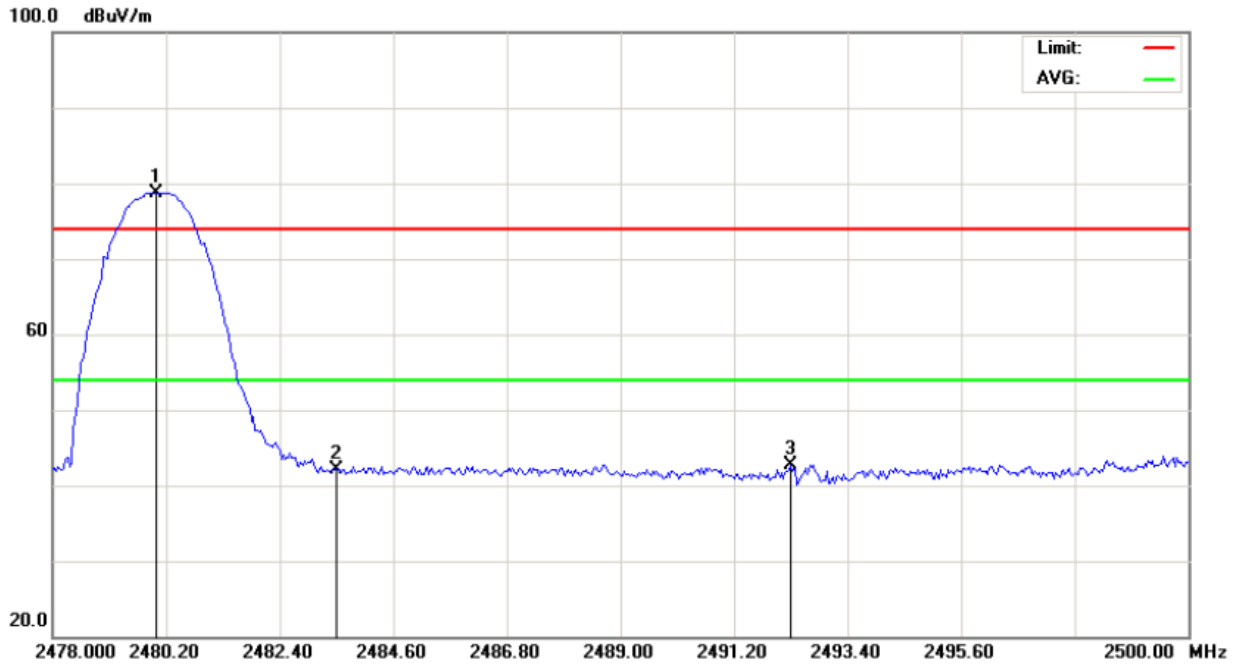

Site: site #1 Polarization: *Horizontal* Temperature: 26
Limit: FCC Class B 3M Radiation above 1GHZ(PK) Power: Humidity: 60 %
EUT:Bluetooth Speaker Distance:
M/N:HX-P740
Mode: High Channel TX
Note:

No.	Mk	Freq.	Reading	Factor	Measurement	Limit	Over	Detector	Antenna Height	Table Degree	Comment
		MHz	dBuV	dB/m	dBuV/m	dBuV/m	dB		cm	degree	
1	*	2480.000	88.34	-9.59	78.75	74.00	4.75	peak			
2		2483.500	51.62	-9.59	42.03	74.00	-31.97	peak			
3		2492.300	52.37	-9.58	42.79	74.00	-31.21	peak			

TEST PLOT OF BAND EDGE FOR HIGH CHANNEL -Vertical

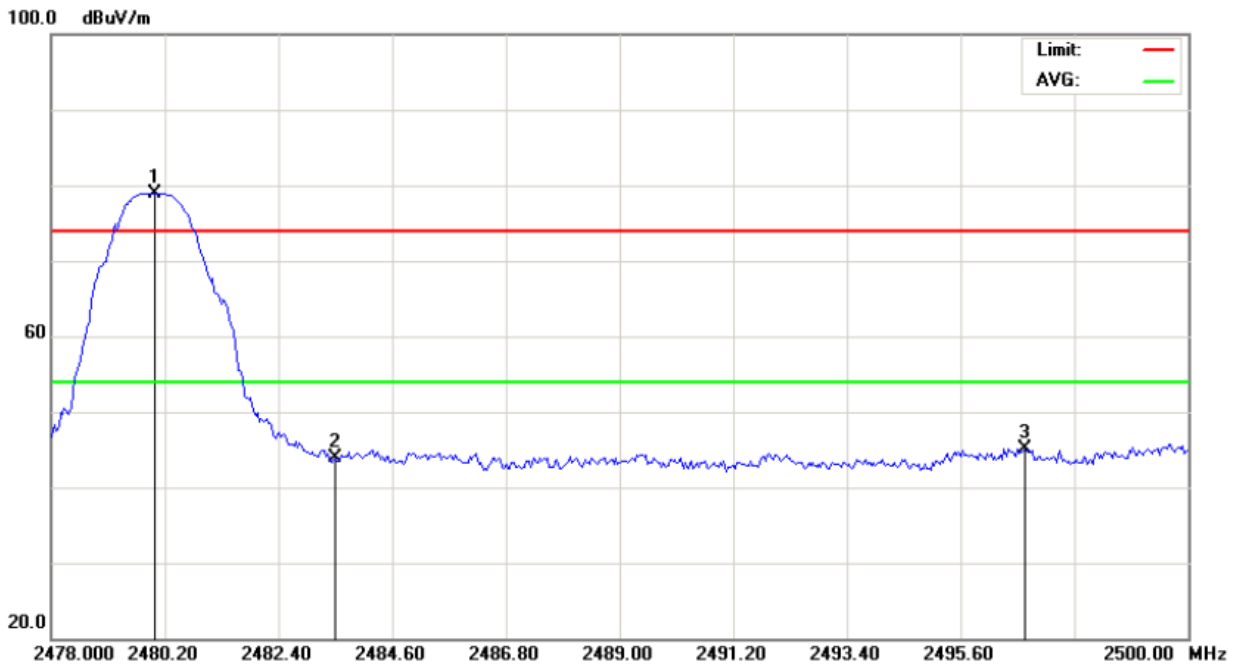

Site: site #1

Polarization: *Vertical*

Temperature: 26

Limit: FCC Class B 3M Radiation above 1GHZ(PK)

Power:

Humidity: 60 %

EUT:Bluetooth Speaker

Distance:

M/N:HX-P740

Mode: High Channel TX

Note:

No.	Mk	Freq.	Reading	Factor	Measurement	Limit	Over	Detector	Antenna Height	Table Degree	Comment
		MHz	dBuV	dB/m	dBuV/m	dBuV/m	dB		cm	degree	
1	*	2480.000	88.48	-9.59	78.89	74.00	4.89	peak			
2		2483.500	53.40	-9.59	43.81	74.00	-30.19	peak			
3		2496.847	54.60	-9.57	45.03	74.00	-28.97	peak			

RESULT: PASS

9. 6DB BANDWIDTH

9.1. TEST EQUIPMENT LIST AND DETAILS

Equipment	Manufacturer	Model	S/N	Cal. Date	Cal. Due
PSA SERIES SPECTRUM ANALYZER	AGILENT	E4440A	US41421290	07/17/2013	07/16/2014
RECEIVER ANTENNA	ETS	2175	57337	07/17/2013	07/16/2014

9.2. TEST PROCEDURE

1. The EUT was placed on a table which is 0.8m above ground plane.
2. Connect EUT RF output port to the Spectrum Analyzer through an RF attenuator
3. Set the EUT Work on the top, the middle and the bottom operation frequency individually.
3. Set SPA Centre Frequency = Operation Frequency, RBW= 100 KHz, VBW \geq 3*RBW.
4. Set SPA Trace 1 Max hold, then View.

9.3. SUMMARY OF TEST RESULTS/PLOTS

Channel	6dB Bandwidth (KHz)	Minimum Limit (KHz)	Pass/Fail
Low	696	500KHz	Pass
Middle	701		Pass
High	688		Pass

TEST PLOT OF BANDWIDTH FOR LOW CHANNEL

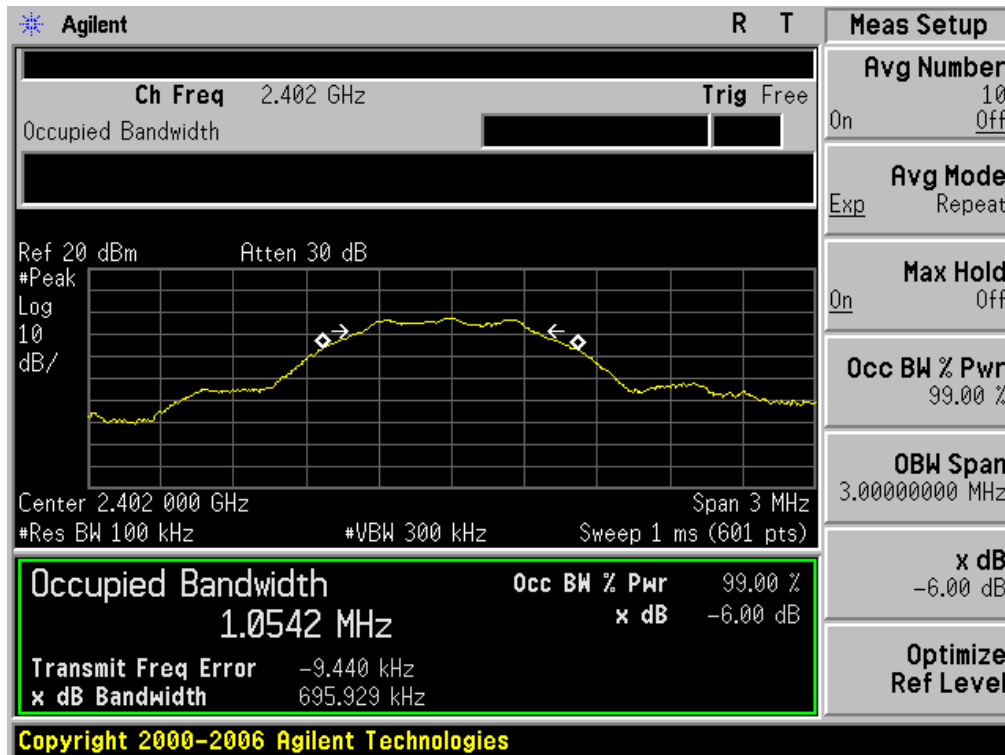

TEST PLOT OF BANDWIDTH FOR MIDDLE CHANNEL

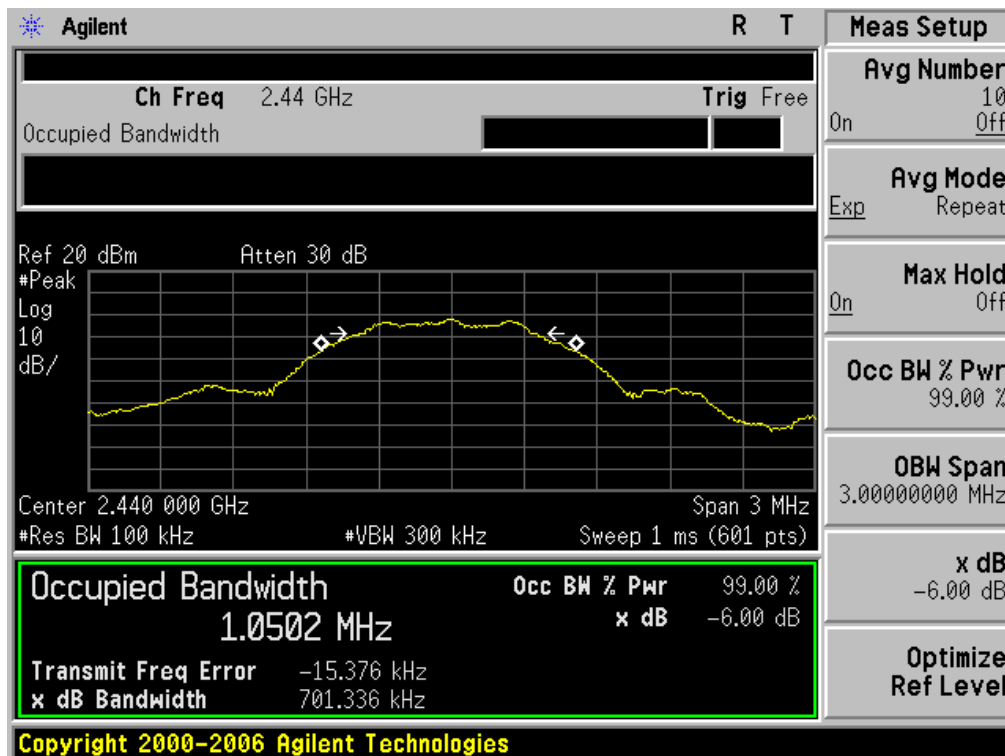

TEST PLOT OF BANDWIDTH FOR HIGH CHANNEL

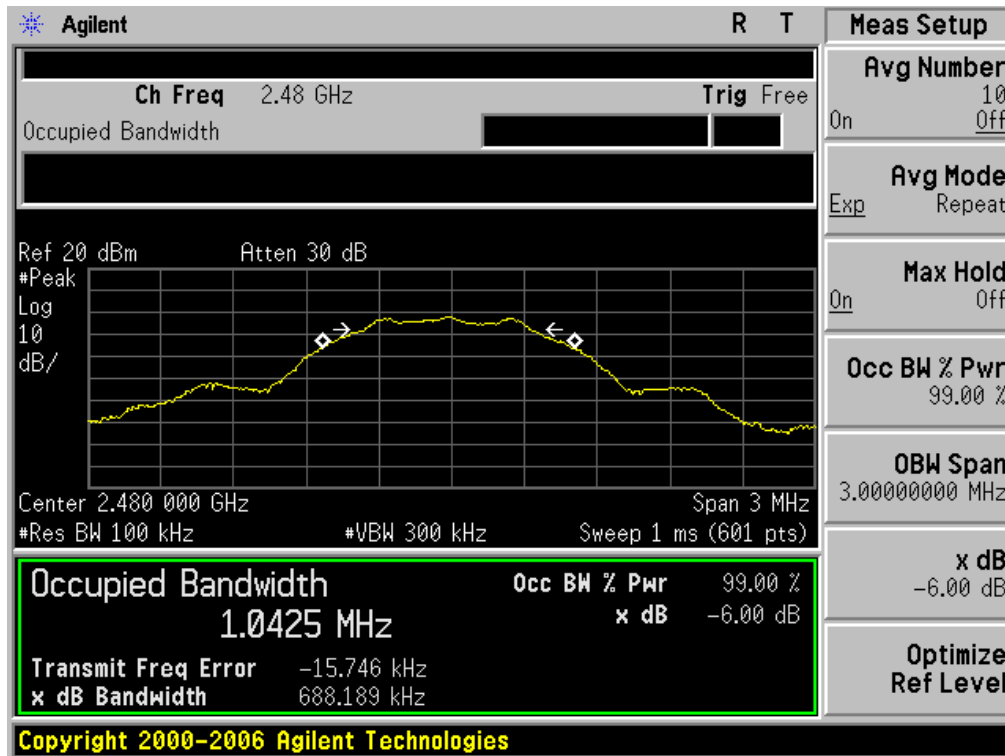

10. CONDUCTED OUTPUT POWER

10.1. MEASUREMENT PROCEDURE

For peak power test:

1. The EUT was placed on a turn table which is 0.8m above ground plane.
2. Connect EUT RF output port to the Spectrum Analyzer through an RF attenuator
3. Set the EUT Work on the top, middle and the bottom operation frequency individually.
4. Use the following spectrum analyzer settings:
 - a) Set the RBW \geq DTS bandwidth.
 - b) Set VBW ≥ 3 RBW.
 - c) Set span $\geq 3 \times$ RBW
 - d) Sweep time = auto couple.
 - e) Detector = peak.
 - f) Trace mode = max hold.
 - g) Allow trace to fully stabilize.
 - h) Use peak marker function to determine the peak amplitude level.
5. Allow the trace to stabilize. Use the instrument's band/channel power measurement function with the band limits set equal to the DTS bandwidth edges.
6. Record the result form the Spectrum Analyzer.

For average power test:

1. The EUT was placed on a table which is 0.8m above ground plane.
2. Connect EUT RF output port to power probe through an RF attenuator.
3. Connect the power probe to the PC.
4. Set the EUT Work on the top, the middle and the bottom operation frequency individually.
5. Record the maximum power from the software.
6. The maximum peak power shall be less 1W (30dBm).

Note: The EUT was tested according to KDB 558074 for compliance to FCC 47CFR 15.247 requirements

10.2. TEST SET-UP (BLOCK DIAGRAM OF CONFIGURATION)

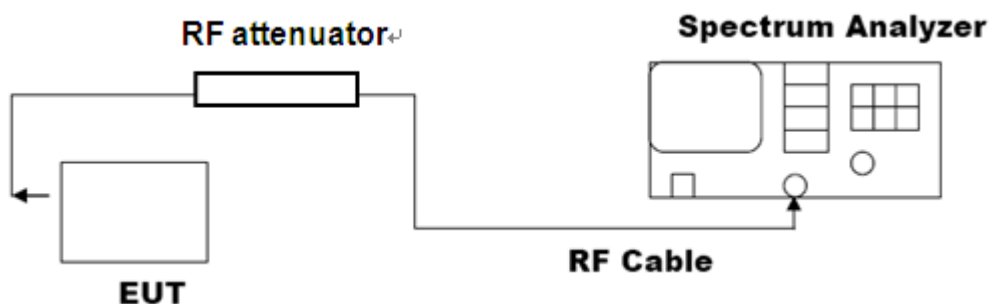

10.3. LIMITS AND MEASUREMENT RESULT

Channel	Average Power (dBm)	Peak Power (dBm)	Applicable Limits (dBm)	Pass/Fail
Low Channel	-2.3	-0.45	30	Pass
Middle Channel	-2.07	-0.18	30	Pass
High Channel	-2.08	-0.17	30	Pass

The Low Channel Result

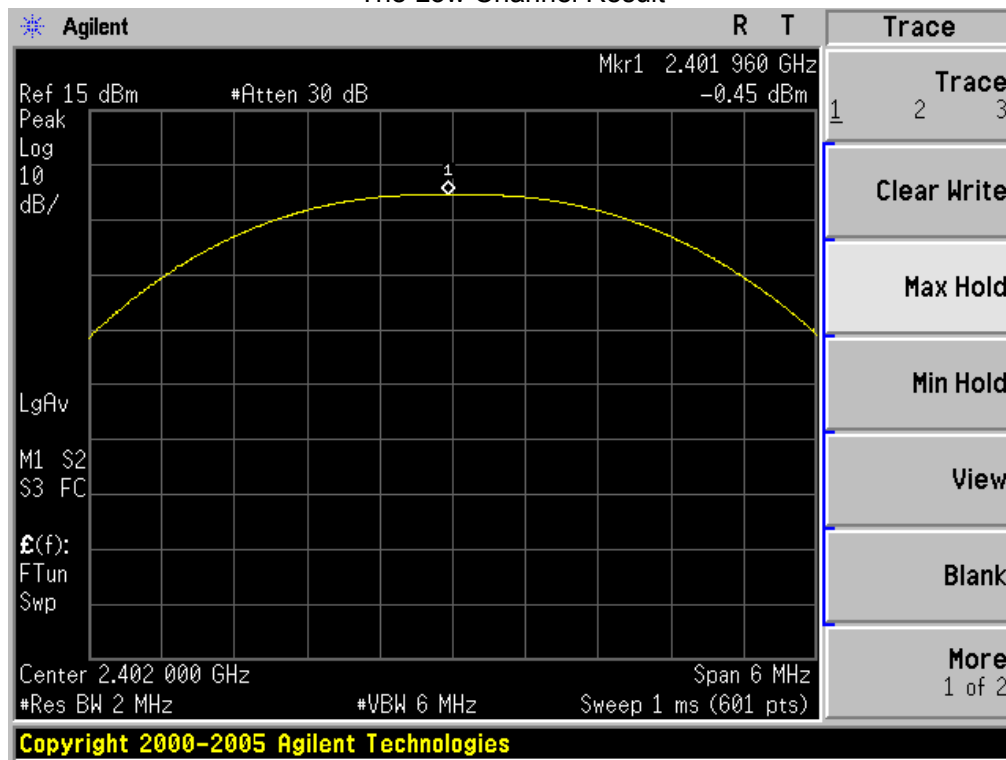

Copyright 2000-2005 Agilent Technologies

The Middle Channel Result

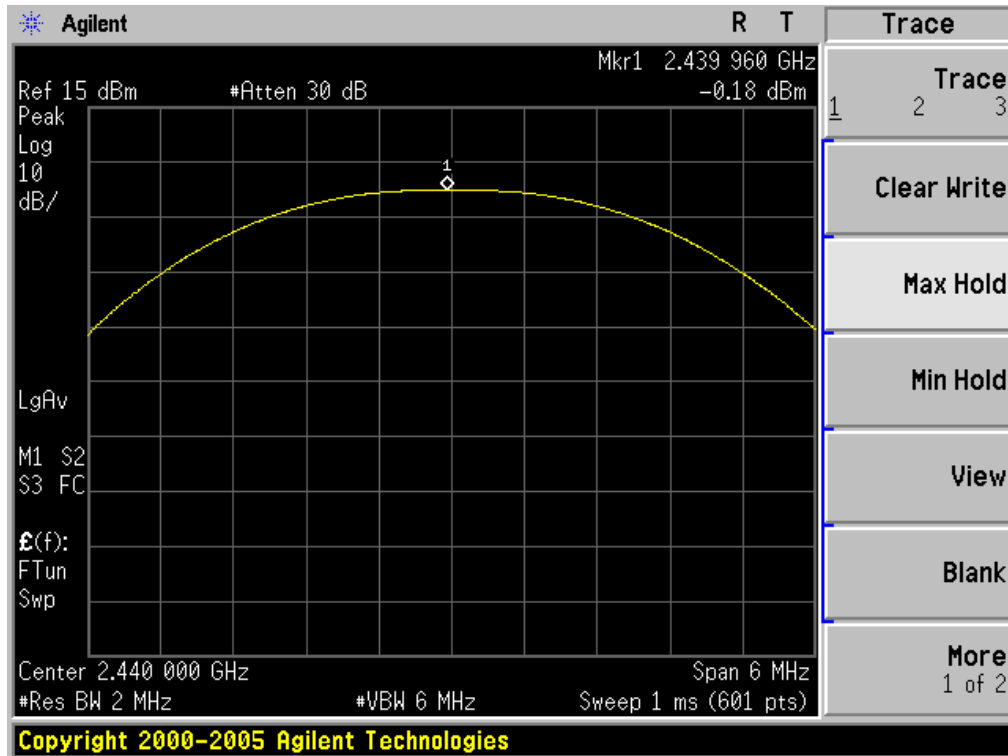

The High Channel Result

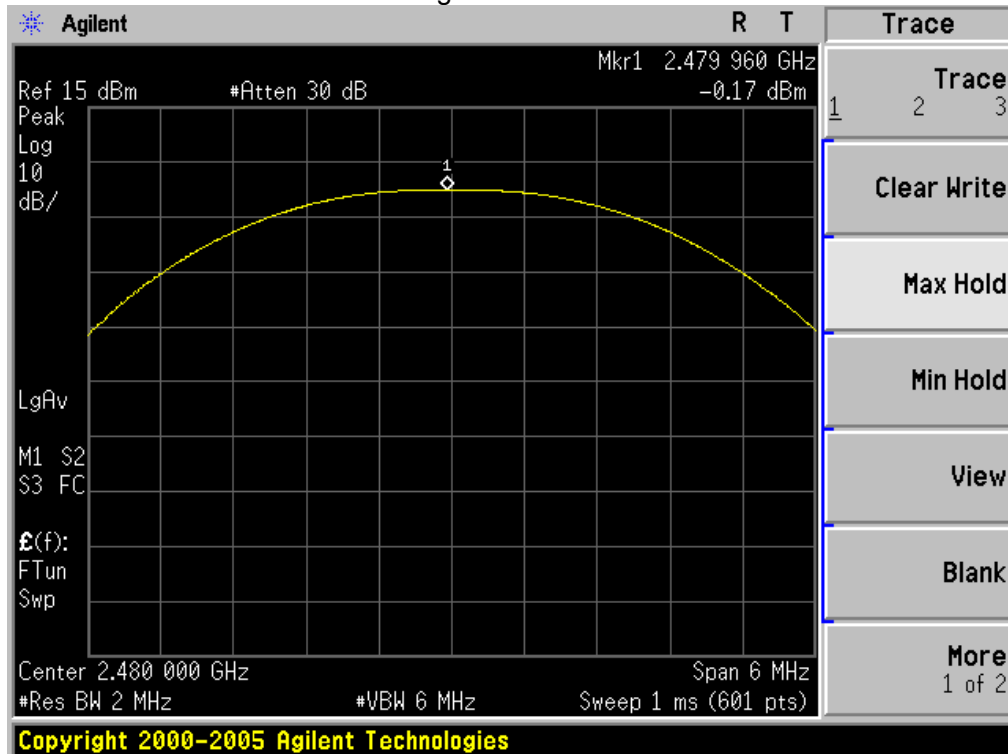

11. MAXIMUM CONDUCTED OUTPUT POWER SPECTRAL DENSITY

11.1 MEASUREMENT PROCEDURE

- (1). The EUT was placed on a turn table which is 0.8m above ground plane.
- (2). Connect EUT RF output port to the Spectrum Analyzer through an RF attenuator
- (3). Set the EUT Work on the top, the middle and the bottom operation frequency individually.
- (4). Set the span to 1.5times the DTS bandwidth, RBW: $3\text{kHz} \leq \text{RBW} \leq 100\text{KHz}$, VBW $> 3 * \text{RBW}$
- (5). Set SPA Trace 1 Max hold, then View.

Note: The EUT was tested according to KDB 558074 for compliance to FCC 47CFR 15.247 requirements.

11.2 TEST SET-UP (BLOCK DIAGRAM OF CONFIGURATION)

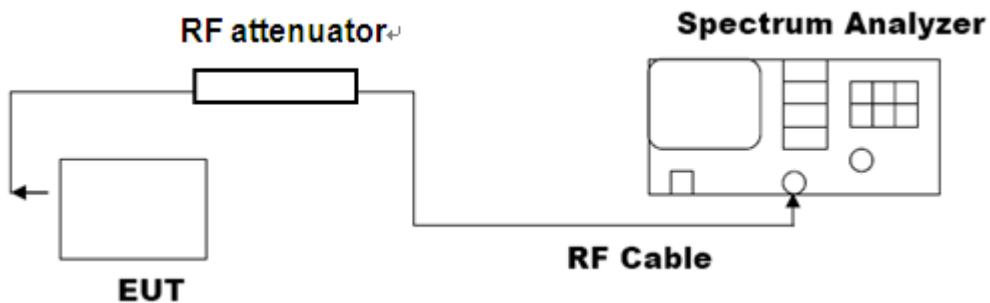

11.3 MEASUREMENT EQUIPMENT USED

Equipment	Manufacturer	Model	S/N	Cal. Date	Cal. Due
PSA SERIES SPECTRUM ANALYZER	AGILENT	E4440A	US41421290	07/17/2013	07/16/2014
RECEIVER ANTENNA	ETS	2175	57337	07/17/2013	07/16/2014

11.4 LIMITS AND MEASUREMENT RESULT

Channel No.	PSD (dBm)	Limit (dBm)	Result
Low Channel	-17.85	8	Pass
Middle Channel	-17.18	8	Pass
High Channel	-17.22	8	Pass

TEST PLOT OF SPECTRAL DENSITY FOR LOW CHANNEL

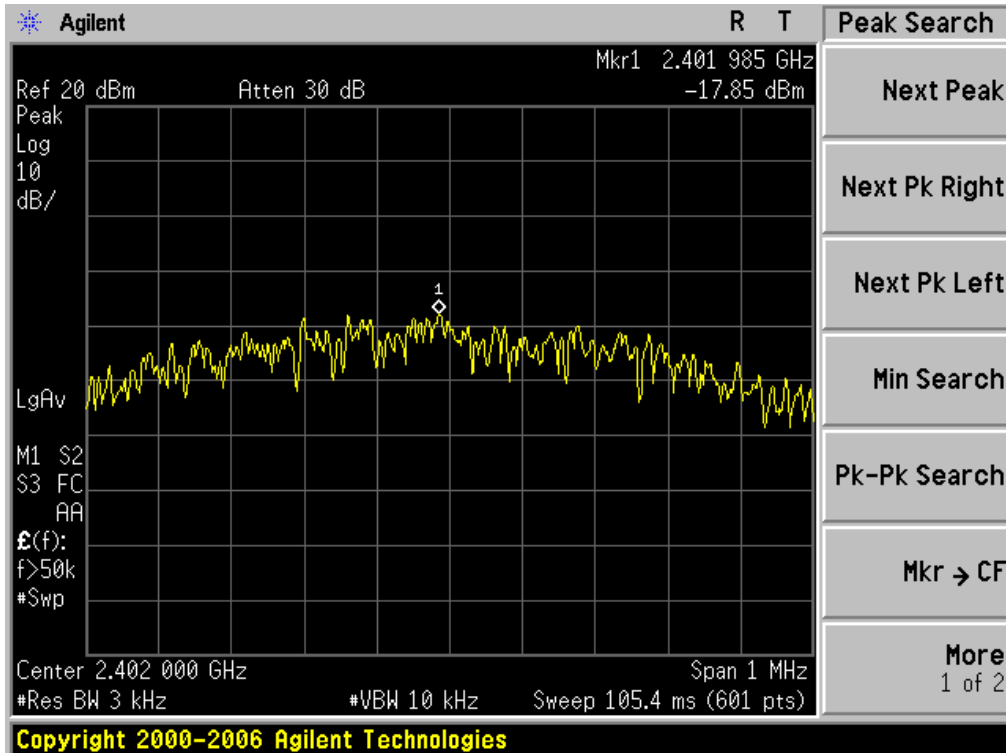

TEST PLOT OF SPECTRAL DENSITY FOR MIDDLE CHANNEL

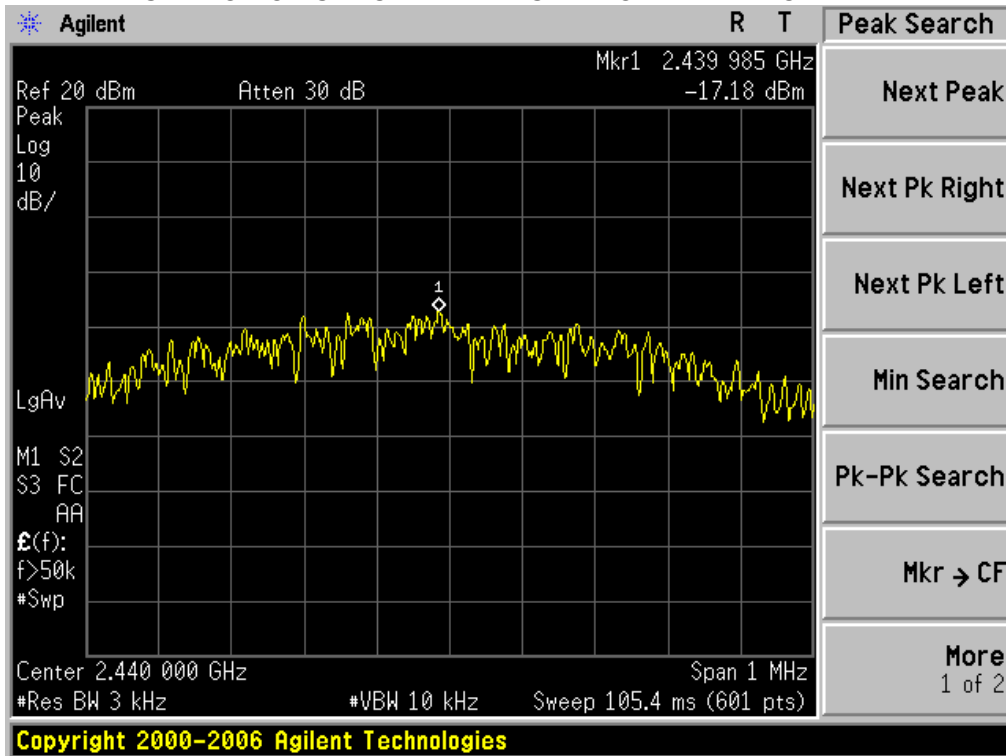

TEST PLOT OF SPECTRAL DENSITY FOR HIGH CHANNEL

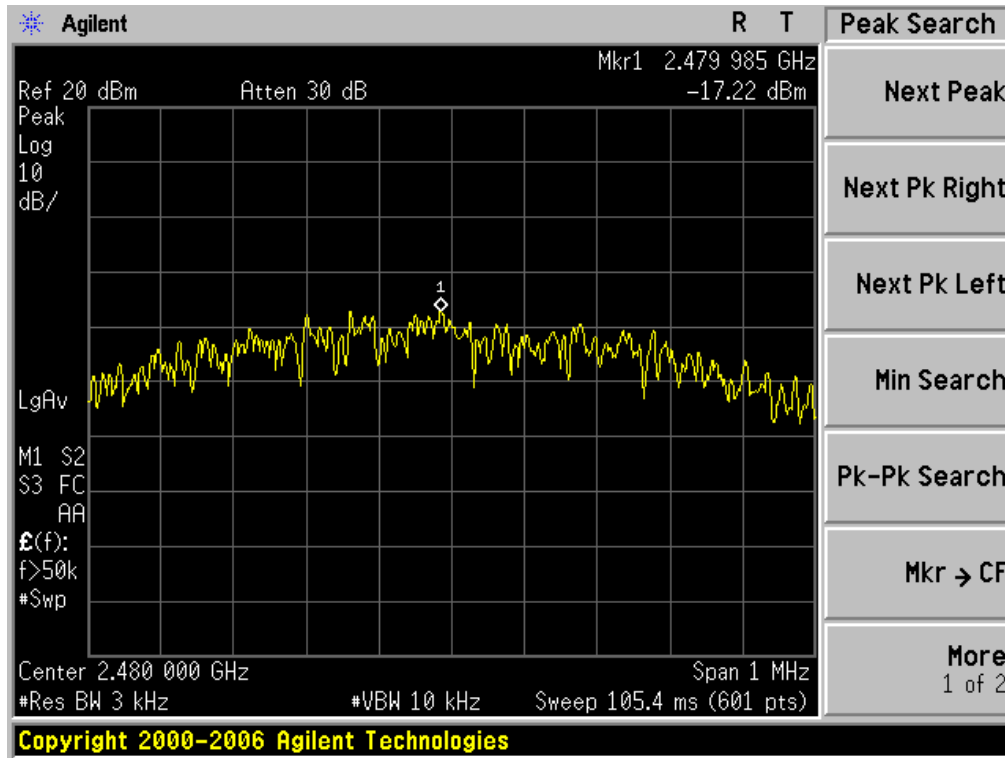

12. FCC LINE CONDUCTED EMISSION TEST

12.1 LIMITS

Frequency	Maximum RF Line Voltage	
	Q.P.(dBuV)	Average(dBuV)
150kHz~500kHz	66-56	56-46
500kHz~5MHz	56	46
5MHz~30MHz	60	50

****Note:** 1. The lower limit shall apply at the transition frequency.
2. The limit decreases linearly with the logarithm of the frequency in the range 0.15 MHz to 0.50 MHz

12.2 TEST SETUP

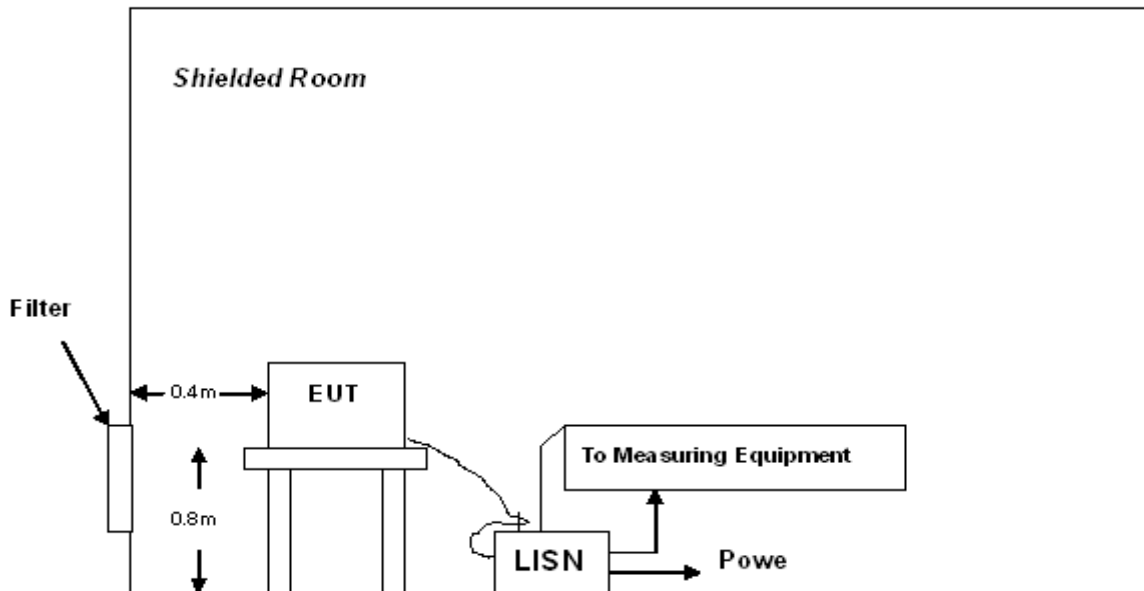

A: Powered through filter

12.3 PRELIMINARY PROCEDURE

- 1) The equipment was set up as per the test configuration to simulate typical actual usage per the user's manual. When the EUT is a tabletop system, a wooden table with a height of 0.8 meters is used and is placed on the ground plane as per ANSI C63.4 (see Test Facility for the dimensions of the ground plane used). When the EUT is a floor-standing equipment, it is placed on the ground plane which has a 3-12 mm non-conductive covering to insulate the EUT from the ground plane.
- 2) Support equipment, if needed, was placed as per ANSI C63.4.
- 3) All I/O cables were positioned to simulate typical actual usage as per ANSI C63.4.
- 4) All support equipments received AC120V/60Hz power from a LISN, if any.
- 5) The EUT received power by adapter which received power by a LISN.
- 6) The test program was started. Emissions were measured on each current carrying line of the EUT using a spectrum Analyzer / Receiver connected to the LISN powering the EUT. The LISN has two monitoring points: Line 1 (Hot Side) and Line 2 (Neutral Side). Two scans were taken: one with Line 1 connected to Analyzer / Receiver and Line 2 connected to a 50 ohm load; the second scan had Line 1 connected to a 50 ohm load and Line 2 connected to the Analyzer / Receiver.
- 7) Analyzer / Receiver scanned from 150 kHz to 30MHz for emissions in each of the test modes.
- 8) During the above scans, the emissions were maximized by cable manipulation.
- 9) The following test mode(s) were scanned during the preliminary test.
Then, the EUT configuration and cable configuration of the above highest emission level were recorded for reference of final testing.

12.4 FINAL TEST PROCEDURE

- 10) EUT and support equipment was set up on the test bench as per step 2 of the preliminary test.
- 11) 2) A scan was taken on both power lines, Line 1 and Line 2, recording at least the six highest emissions. Emission frequency and amplitude were recorded into a computer in which correction factors were used to calculate the emission level and compare reading to the applicable limit. If EUT emission level was less -2dB to the A.V. limit in Peak mode, then the emission signal was re-checked using Q.P and Average detector.
- 12) 3) The test data of the worst case condition(s) was reported on the Summary Data page.

12.5 TEST RESULT OF POWER LINE

Line Conducted Emission Test Line 1-L Conducted Emission Measurement

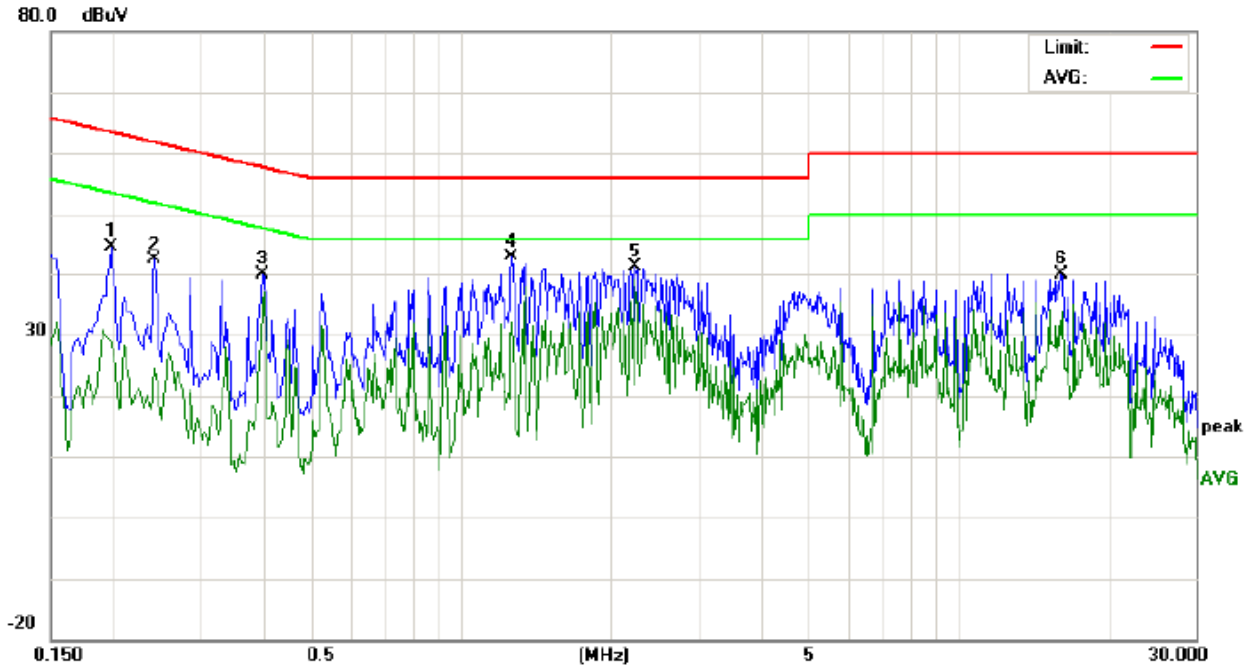

Site: Conduction Phase: **L1** Temperature: 26
Limit: FCC Class B Conduction(QP) Power: Humidity: 60 %
EUT:Bluetooth speaker
M/N: HX-P740
Mode:Normal hopping+Charging
Note:

No.	Freq. (MHz)	Reading_Level (dBuV)			Correct Factor (dB)	Measurement (dBuV)			Limit (dBuV)		Margin (dB)		P/F	Comment
		Peak	QP	AVG		Peak	QP	AVG	QP	AVG	QP	AVG		
1	0.1980	34.38		18.64	10.21	44.59		28.85	63.69	53.69	-19.10	-24.84	P	
2	0.2419	32.08		14.13	10.26	42.34		24.39	62.03	52.03	-19.69	-27.64	P	
3	0.3980	29.59		24.03	10.33	39.92		34.36	57.89	47.89	-17.97	-13.53	P	
4	1.2660	32.53		21.68	10.38	42.91		32.06	56.00	46.00	-13.09	-13.94	P	
5	2.2418	30.91		28.74	10.32	41.23		39.06	56.00	46.00	-14.77	-6.94	P	
6	16.1377	29.83		21.08	10.11	39.94		31.19	60.00	50.00	-20.06	-18.81	P	

Line Conducted Emission Test Line 2-N
Conducted Emission Measurement

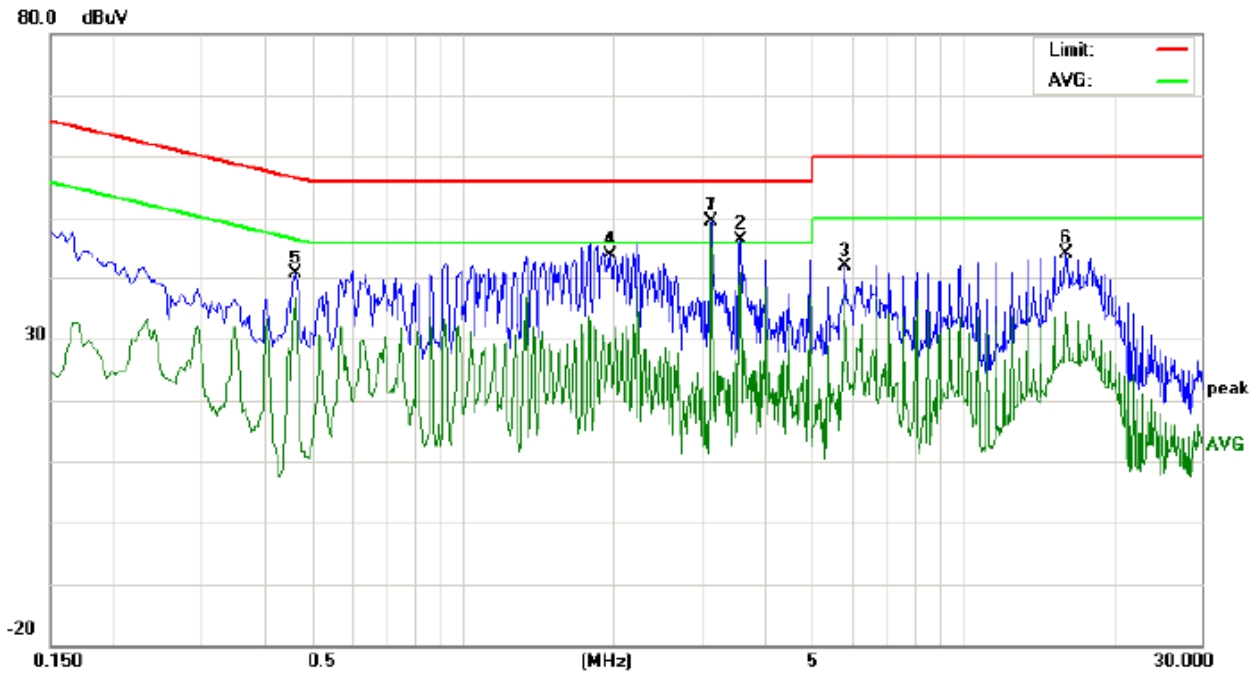

Site: Conduction Phase: *N* Temperature: 26
Limit: FCC Class B Conduction(QP) Power: Humidity: 60 %
EUT:Bluetooth speaker
M/N: HX-P740
Mode: Normal hopping+Charging
Note:

No.	Freq. (MHz)	Reading_Level (dBuV)			Correct Factor (dB)	Measurement (dBuV)			Limit (dBuV)		Margin (dB)		P/F	Comment
		Peak	QP	AVG		Peak	QP	AVG	QP	AVG	QP	AVG		
1	3.1419	38.92		31.16	10.54	49.46		41.70	56.00	46.00	-6.54	-4.30	P	
2	3.5859	37.22		14.21	10.50	47.72		24.71	56.00	46.00	-8.28	-21.29	P	
3	5.8258	31.69		26.80	10.27	41.96		37.07	60.00	50.00	-18.04	-12.93	P	
4	1.9697	37.49		14.48	10.23	47.72		24.71	56.00	46.00	-8.28	-21.29	P	
5	0.4660	30.22		22.70	10.38	40.60		33.08	56.58	46.58	-15.98	-13.50	P	
6	16.1375	33.97		24.21	10.11	44.08		34.32	60.00	50.00	-15.92	-15.68	P	
7	3.1419	38.92		31.16	10.54	49.46		41.70	56.00	46.00	-6.54	-4.30	P	

APPENDIX A: PHOTOGRAPHS OF TEST SETUP

FCC LINE CONDUCTED EMISSION TEST SETUP



FCC RADIATED EMISSION TEST SETUP

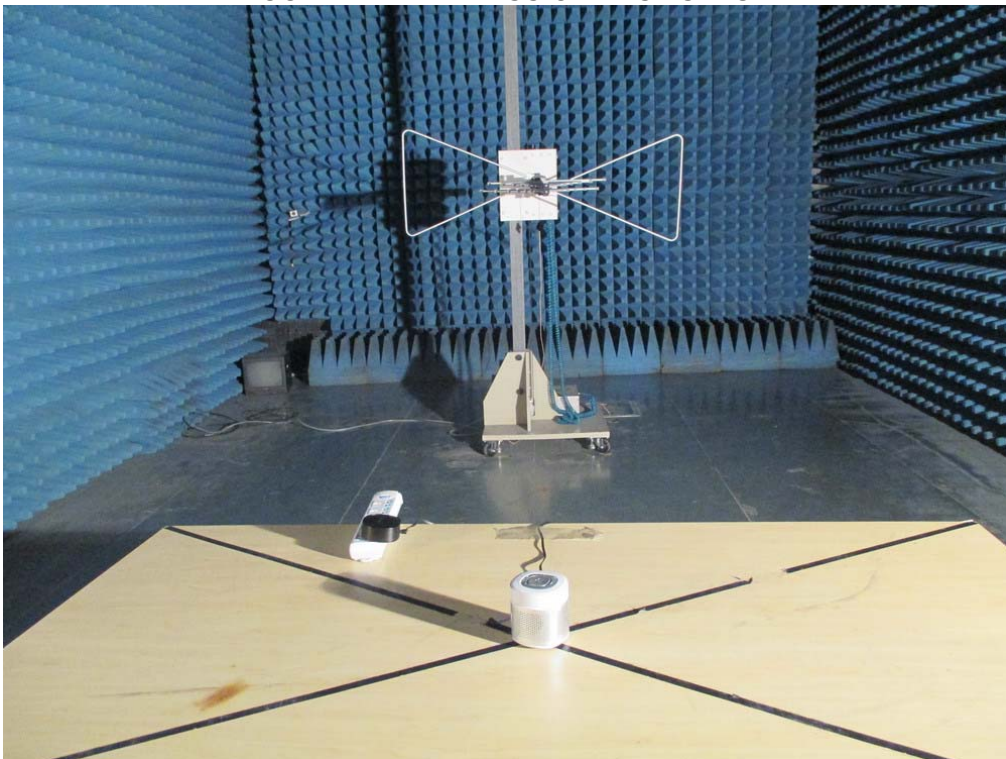

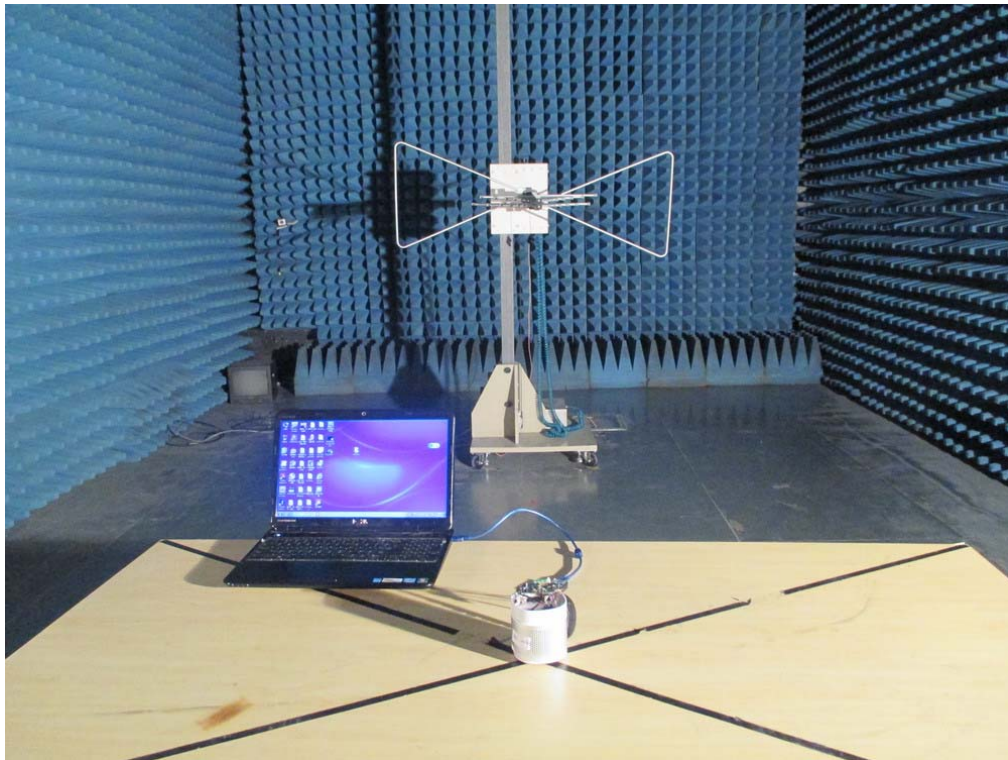

APPENDIX B: PHOTOGRAPHS OF EUT

ALL VIEW OF EUT

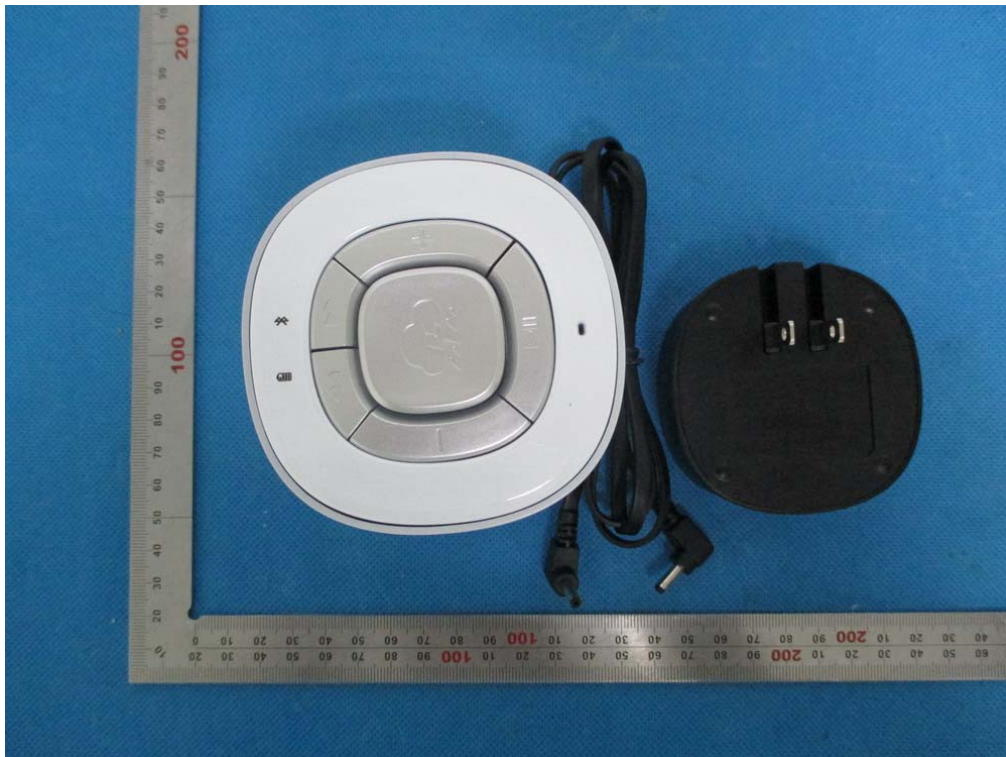

TOP VIEW OF EUT

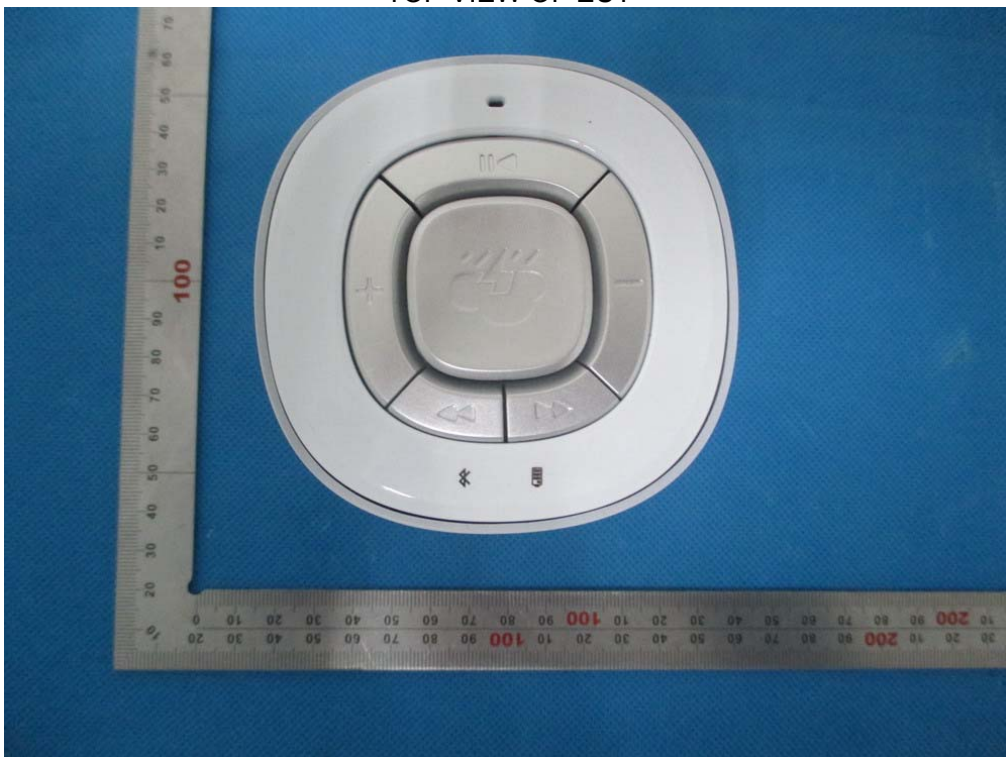

BOTTOM VIEW OF EUT

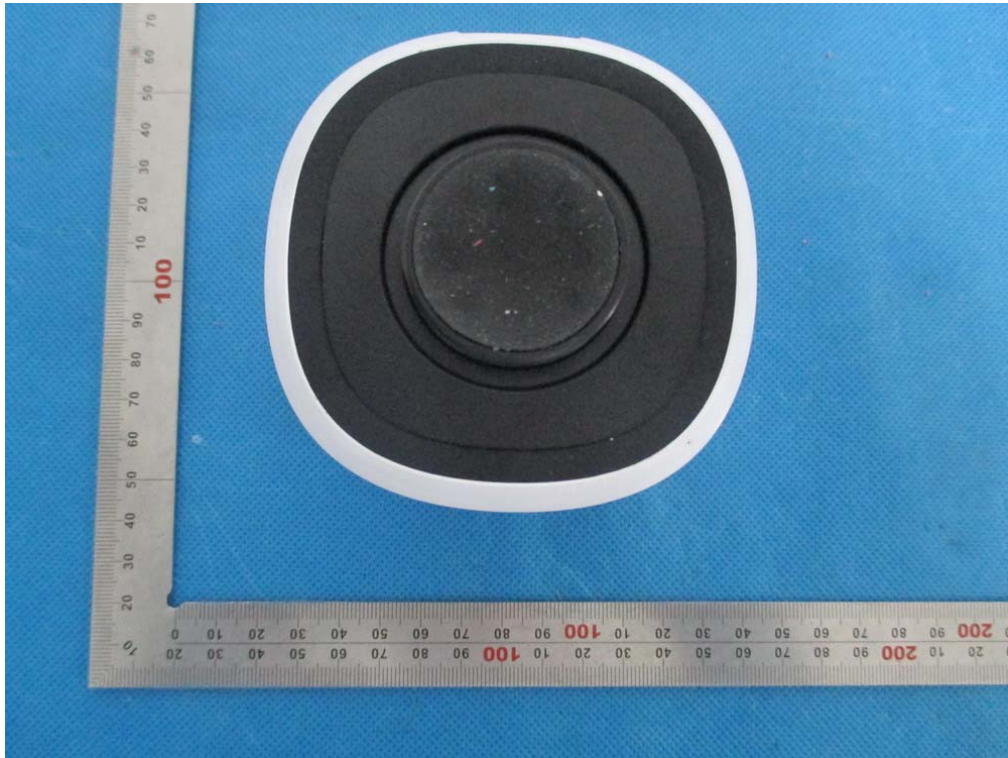

FRONT VIEW OF EUT



BACK VIEW OF EUT



LEFT VIEW OF EUT

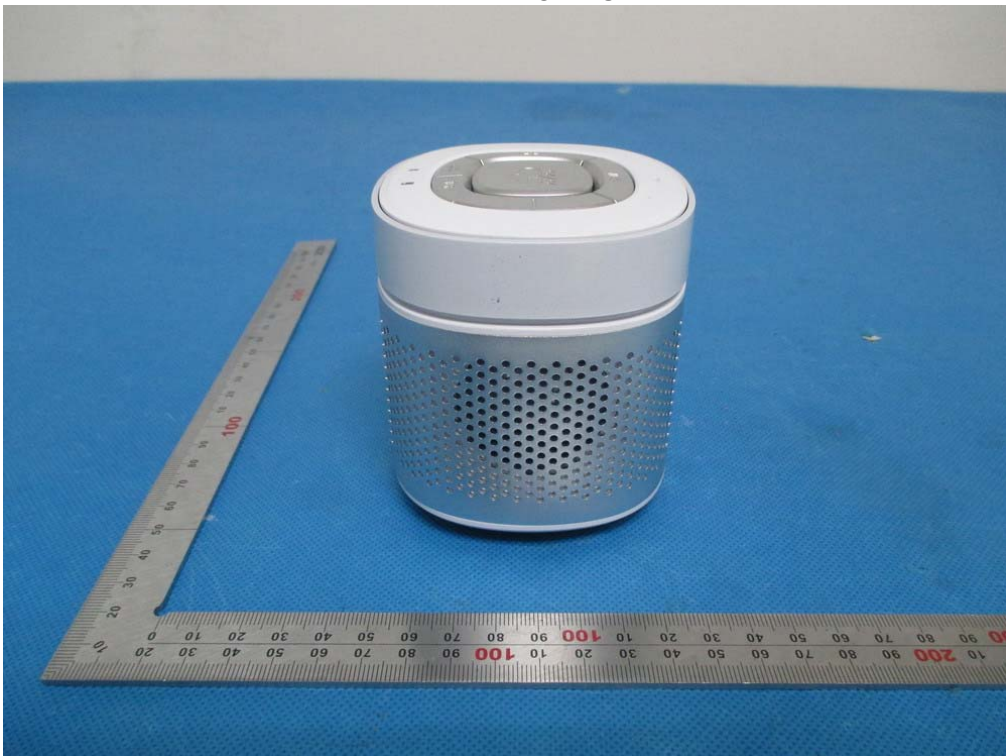

RIGHT VIEW OF EUT



OPEN VIEW OF EUT

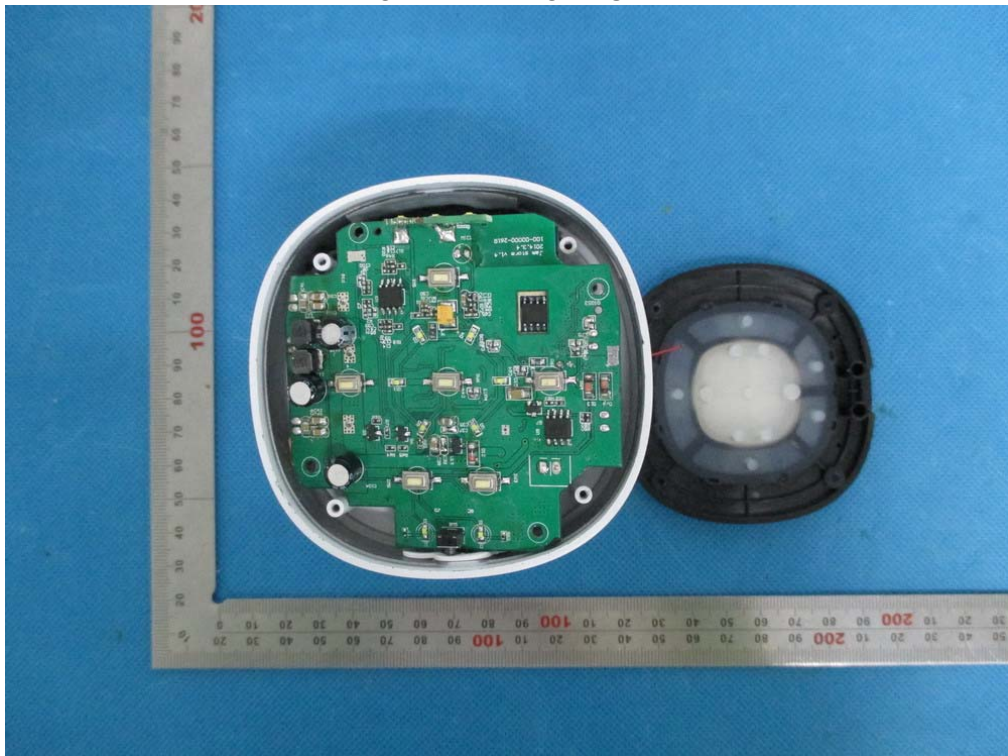

INTERNAL VIEW OF EUT-1

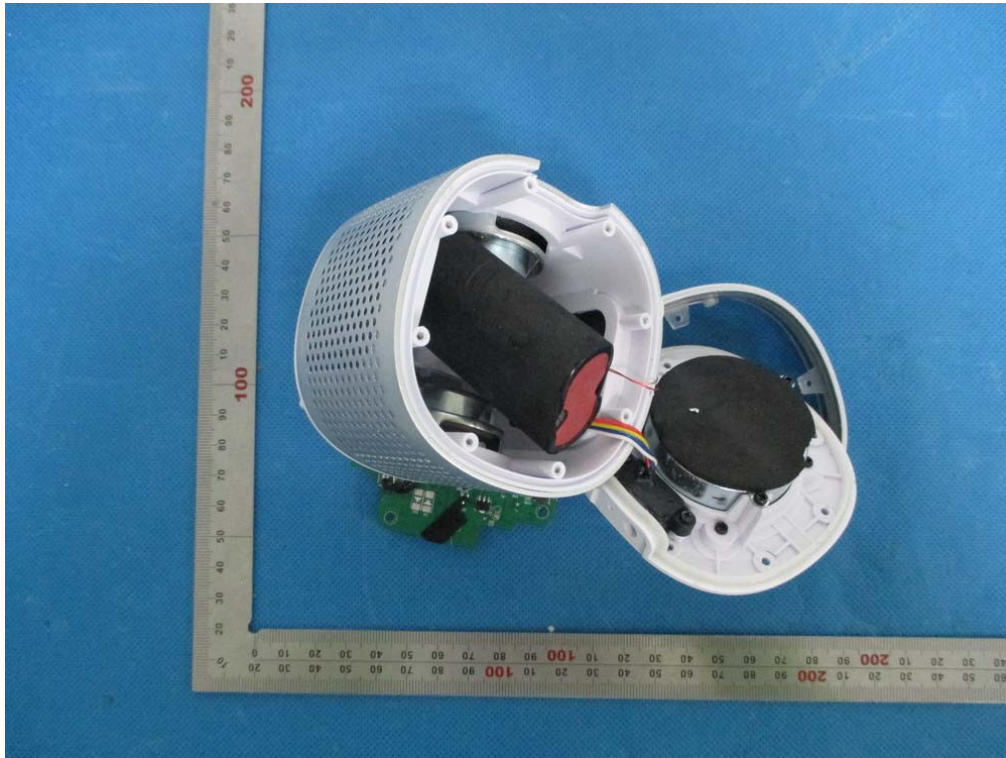

INTERNAL VIEW OF EUT-2

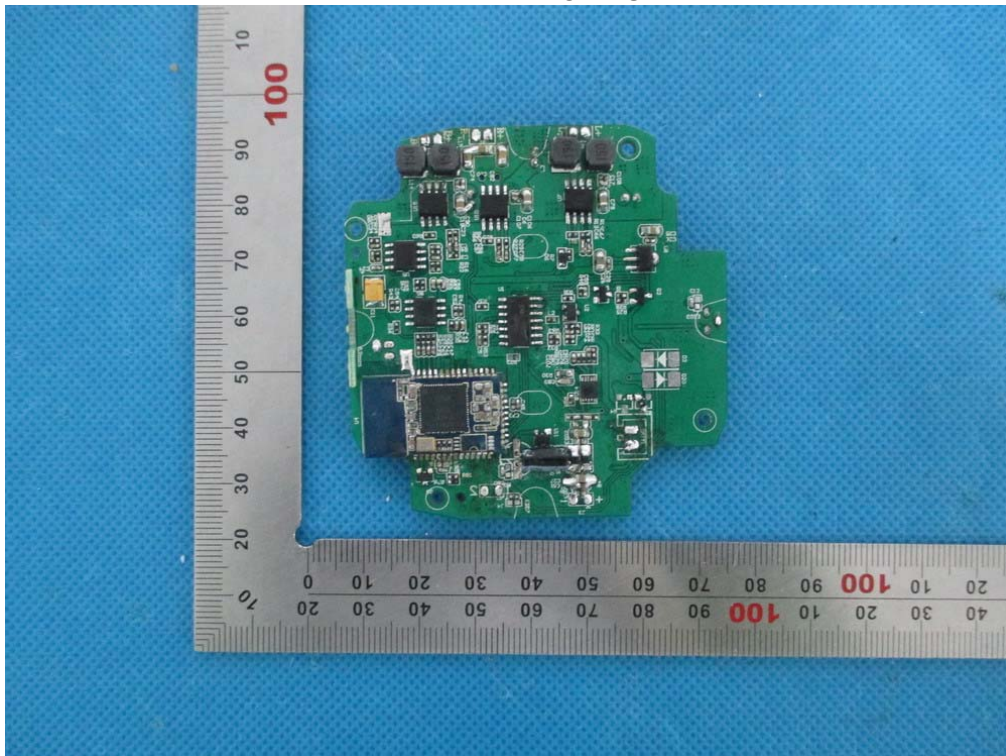

INTERNAL VIEW OF EUT-3

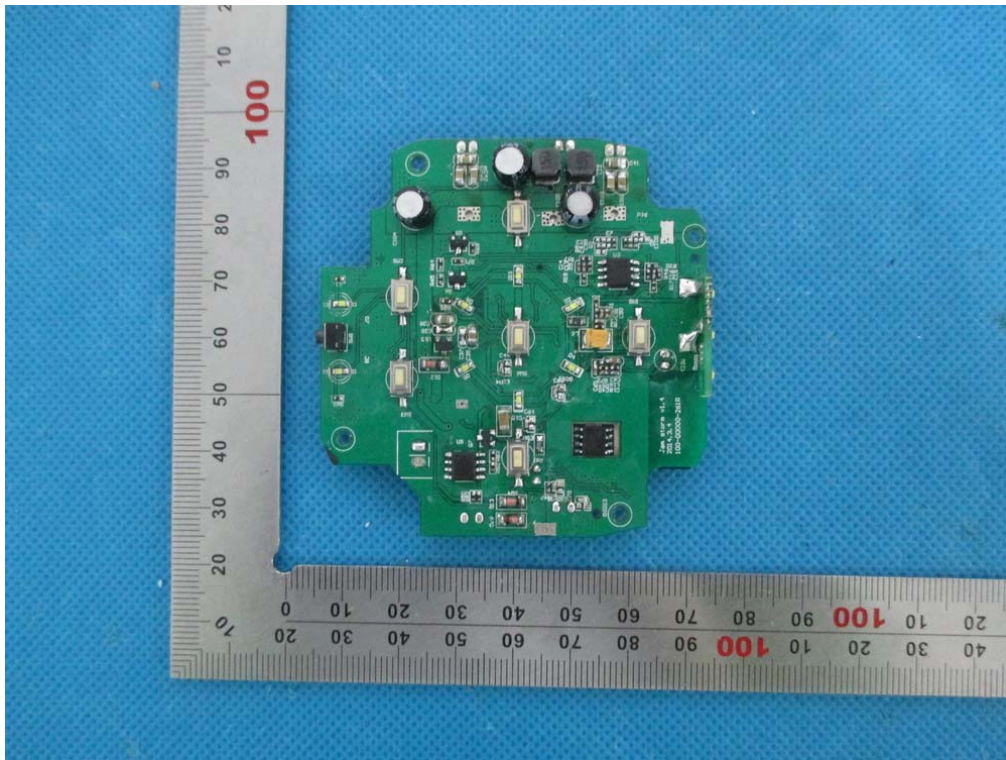

INTERNAL VIEW OF EUT-4

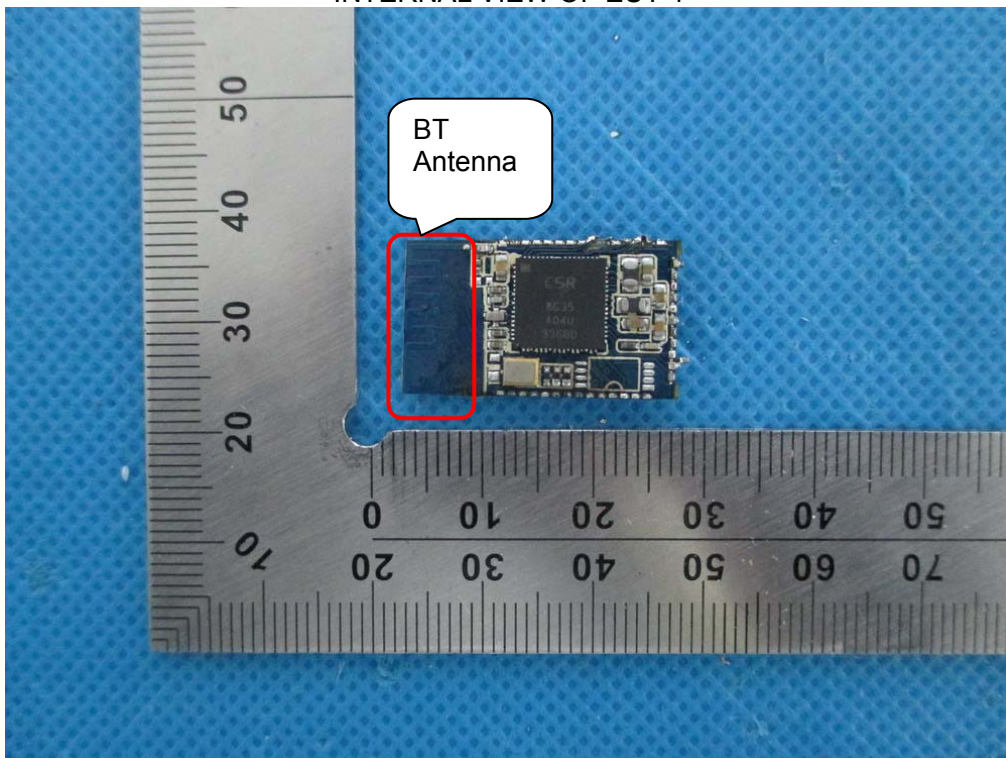

INTERNAL VIEW OF EUT-5

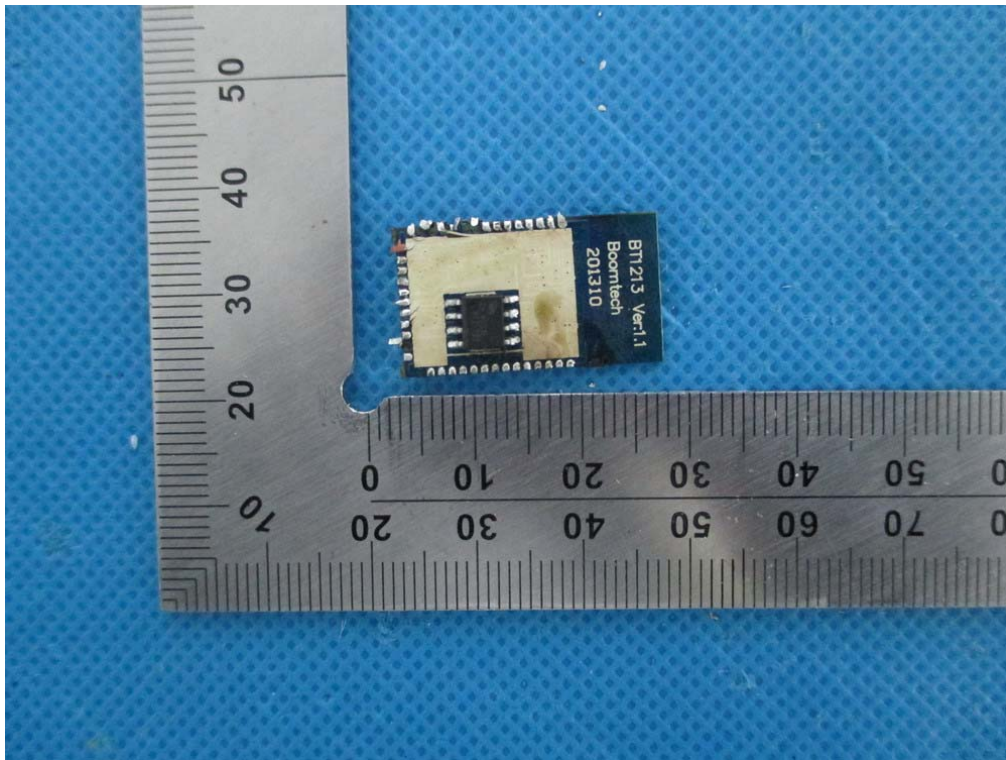

----END OF REPORT----