

---

**Water Resistant AM/FM Bluetooth Shower Clock Radio  
with Digital Tuning**

**MODEL : JWM-160  
USER MANUAL**



**PLEASE READ THIS USER MANUAL COMPLETELY BEFORE OPERATING THIS UNIT**

**AND RETAIN THIS BOOKLET FOR FUTURE REFERENCE**  
**COMPLIANCE WITH FCC REGULATIONS**

**FCC ID: 2AB4R-BT-068**

This device complies with Part 15 of the FCC Rules. Operation is subject to the following two conditions:

- (1) This device may not cause harmful interference, and
- (2) This device must accept any interference received, including interference that may cause undesired operation.

This equipment has been tested and found to comply with the limits for a Class B Digital Device, pursuant to Part 15 of the FCC Rules. These limits are designed to provide reasonable protection against harmful interference in a residential installation. This equipment generates, uses and can radiate radio frequency energy and, if not installed and used in accordance with the instructions, may cause harmful interference to radio communications. However, there is no guarantee that interference will not occur in a particular installation. If this equipment does cause harmful interference to radio or television reception, which can be determined by turning the equipment off and on, the user is encouraged to try to correct the interference by one or more of the following measures:

- Reorient or relocate the receiving antenna.
- Increase the separation between the equipment and receiver.
- Connect the equipment into an outlet on a circuit different from that to which the receiver is connected.
- Consult the dealer or an experienced radio/TV technician for help.

**WARNING**

**Changes or modifications to this unit not expressly approved by the party responsible for compliance could void the user's authority to operate the equipment.**

**COMPLIANCE WITH FCC REGULATIONS**

This device complies with Part 15 of the FCC Rules. Operation is subject to the following two conditions:

- (1) This device may not cause harmful interference, and
- (2) This device must accept any interference received, including interference that may cause undesired operation.

This equipment has been tested and found to comply with the limits for a Class B Digital Device, pursuant to Part 15 of the FCC Rules. These limits are designed to provide reasonable protection against harmful interference in a residential installation. This equipment generates, uses and can radiate radio frequency energy and, if not installed and used in accordance with the instructions, may cause harmful interference to radio communications. However, there is no guarantee that interference will not occur in a particular installation. If this equipment does cause harmful interference to radio or television reception, which can be determined by turning the equipment off and on, the user is encouraged to try to correct the interference by one or more of the following measures:

- Reorient or relocate the receiving antenna.
- Increase the separation between the equipment and receiver.
- Connect the equipment into an outlet on a circuit different from that to which the receiver is connected.
- Consult the dealer or an experienced radio/TV technician for help.

**WARNING**

**Changes or modifications to this unit not expressly approved by the party responsible for compliance could void the user's authority to operate the equipment.**

## **DEAR JENSEN® CUSTOMER**

Selecting fine audio equipment such as the unit you've just purchased is only the start of your musical enjoyment. Now it's time to consider how you can maximize the fun and excitement your equipment offers. This manufacturer and the Electronic Industries Association's Consumer Electronics Group want you to get the most out of your equipment by playing it at a safe level. One that lets the sound come through loud and clear without annoying blaring or distortion and, most importantly, without affecting your sensitive hearing. Sound can be deceiving. Over time your hearing "comfort level" adapts to higher volumes of sound. So what sounds "normal" can actually be loud and harmful to your hearing. Guard against this by setting your equipment at a safe level BEFORE your hearing adapts.

### **To establish a safe level:**

- Start your volume control at a low setting.
- Slowly increase the sound until you can hear it comfortably and clearly, and without distortion.
- Once you have established a comfortable sound level : Set the dial and leave it there. Taking a minute to do this now will help to prevent hearing damage or loss in the future. After all, we want you listening for a lifetime.

### **We Want You Listening For a Lifetime**

Used wisely, your new sound equipment will provide a lifetime of fun and enjoyment. Since hearing damage from loud noise is often undetectable until it is too late, this manufacturer and the Electronic Industries Association's Consumer Electronics Group recommend you avoid prolonged exposure to excessive noise.



### **Customer's Record:**

The serial number of this product is found on its bottom cover. You should note the serial number of this unit in the space provided as a permanent record of your purchase to aid in identification in the event of theft or loss.

**Model Number** : JWM-160

**Serial Number** :

## LOCATION OF CONTROLS

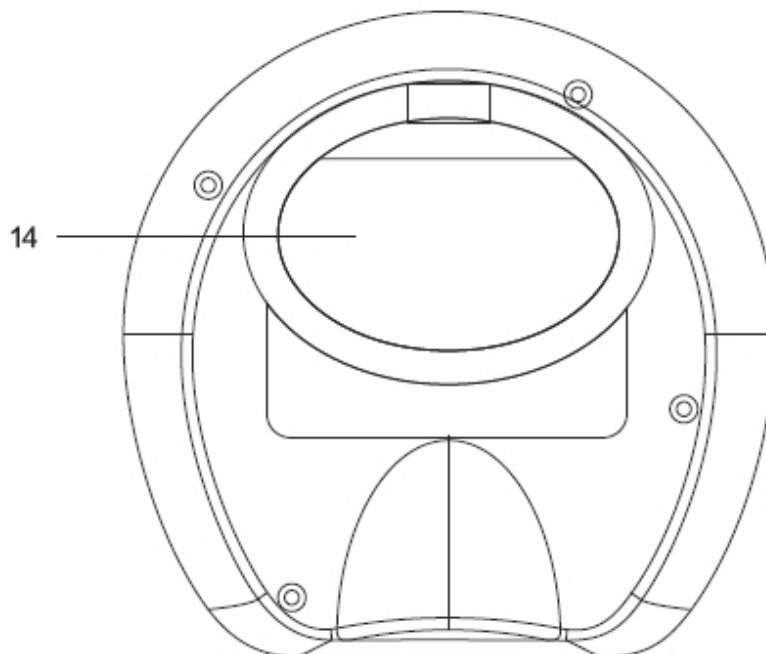
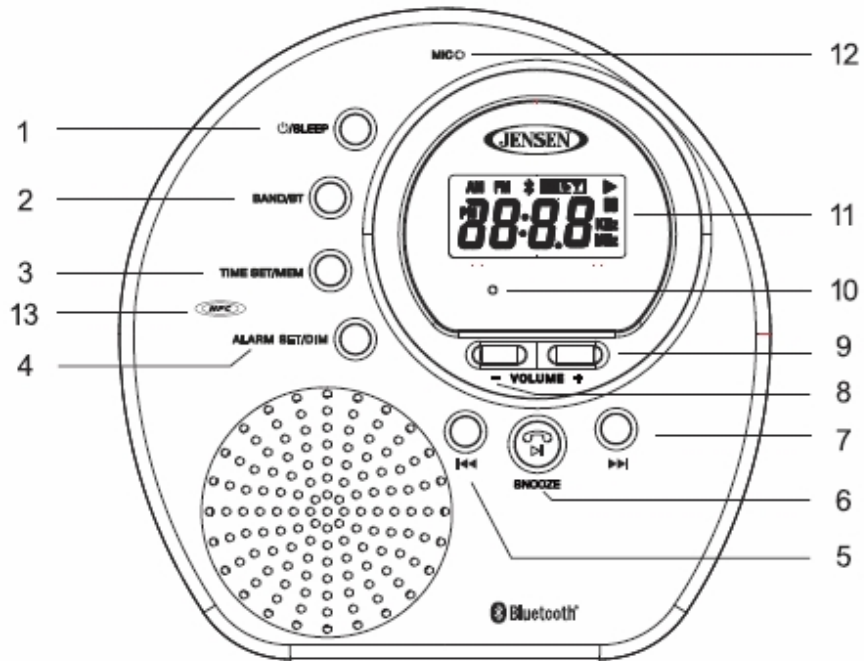



1. /SLEEP
2. BAND/BT

8. VOLUME -
9. VOLUME +

- |                  |                         |
|------------------|-------------------------|
| 3. TIME SET/MEM  | 10. BLUETOOTH INDICATOR |
| 4. ALARM SET/DIM | 11. LCD DISPLAY         |
| 5. ⏪             | 12. MIC                 |
| 6. ▶/SNOOZE      | 13. NFC                 |
| 7. ▶▶            | 14. BATTERY COMPARTMENT |

## POWER SOURCE

The JWM-160 operates on 4 'AA' (UM-3) batteries.

Tap the /SLEEP Button (#1) button to turn on the unit, tap the /SLEEP Button (#1) button again to turn off the unit.

For better performance and longer operating time, we recommend the use of alkaline-type batteries.

1. Remove the Battery Door of BATTERY COMPARTMENT (#14) on the back of the unit..
2. Following the polarity diagram on the back cabinet, insert 4 'AA' (UM-3) batteries (not included) and close the BATTERY DOOR.

## BATTERY WARNING









- Be sure the batteries are installed correctly. Wrong polarity may damage the unit.
- Use only the size and type of batteries specified.
- Do not mix old and new batteries.
- Do not mix alkaline, standard (carbon-zinc) or rechargeable (nickel-cadmium) batteries.
- If the unit is not to be used for an extended period of time, remove the batteries. Old or leaking batteries can cause damage to the unit and may void the warranty.
- Do not try to recharge batteries not intended to be recharged; they can overheat and rupture. (Follow battery manufacturer's directions).
- Do not dispose of batteries in fire, batteries may leak or explode.

## CLOCK SETTING

**Note:** When you turn the unit on for the first time, 12:00 AM will show on the LCD display **and flashing.**

1. In standby mode, press and hold the TIME SET/MEM button (#3), the hour digits will flash.
2. Tap the ⏪ button (#5) or ▶▶ button (#7) to adjust hour. Press and hold the ⏪ button (#5) or ▶▶ button (#7) for fast reverse/advance setting.  
**Note:** Make sure the hour is set so that PM indicator is displayed correctly.
3. Tap the TIME SET/MEM button (#3) to confirm the hour setting, the minute digits will flash to prompt for input.
4. Tap the ⏪ button (#5) or ▶▶ button (#7) to adjust minute. Press and hold the ⏪ button (#5) or ▶▶ button (#7) for fast reverse/advance setting.
5. Tap the TIME SET/MEM button (#3) to complete the setting.

## LISTENING TO THE RADIO



1. Tap the /SLEEP button (#1) to turn on the JWM-160.
2. Tap the BAND/BT button (#2) to select FM or AM mode, the radio frequency will show on LCD Display (#11).
3. Press and hold the  button (#5) or  button (#7) to search for the next / previous available station. If the reception is poor, try Manual Tuning to fine-tune the station.
4. Press the  button (#5) or  button (#7) briefly to manually tune through the frequency band.
5. Adjust the VOLume + button (#9) or VOLume – button (#8) to the desired volume level.
6. If no button is pressed for 5 seconds in radio mode, the display will change to show current time. You can tap the  button (#5) or  button (#7) to check the tuned frequency.
7. Tap the /SLEEP button (#1) to turn the unit into Standby mode after listening.

### TIPS FOR BEST RADIO RECEPTION:

The AM and FM antenna are located inside the cabinet of the unit. If reception is weak, change the position of the unit until the internal antenna picks up the strongest signal.

### Setting the Radio Station Presets

The JWM-160 allows you to store up to 10 FM stations and 10 AM stations for easy recall at any time.

1. Tap the /SLEEP button (#1) to turn on the JWM-160.
2. Tap the BAND/BT button (#2) to select FM or AM mode, the radio frequency will show on LCD Display (#11)..
3. Tune to the radio station you want to store in memory.
4. Press and hold the TIME SET/MEM button (#3). The preset channel number “P01” will be flashing on display.
5. Tap the  button (#5) or  button (#7) to select the preset number (P01-P10).
6. Tap the TIME SET/MEM button (#3) to confirm.
7. To store up to 10 station presets, repeat steps 3 to 6 above.



### RECALLING PRESET MEMORY CHANNELS

To recall a preset station,





1. In radio mode, tap the PRESET TIME SET/MEM button (#3), the preset number will appear on display.
2. Tap the TIME SET/MEM button (#3) repeatedly to select the preset channel.

## BLUETOOTH OPERATION

Pairing a Bluetooth enabled device with the JWM-160.

1. Tap the /SLEEP button (#1) to turn on unit and
2. Tap the BAND/BT button (#2) to select Bluetooth mode, "bt" will show on the LCD Display. The BLUETOOTH INDICATOR (#10) will flash slowly.
3. Turn on the Bluetooth function for the device you want to link to, and enable the search or scan function to find the JWM-160.
4. Select "JWM-160" from the device list when it appears on your device screen. If required, enter the pass code "0000" to pair (link) JWM-160 with your device.
5. If you are pairing (linking) your computer to the speaker using Bluetooth, you may need to set the JWM-160 as your computer's default sound device.
6. After successfully pairing the JWM-160 with your Bluetooth device, The BLUETOOTH INDICATOR (#10) will stop flashing and flash twice per 4 seconds.
7. If you want to pair (link) the JWM-160 with another Bluetooth device, press and hold  Button (#5) a few seconds. The BLUETOOTH INDICATOR (#10) will flash slowly. The JWM-160 will go into Pairing/Discoverable mode. Repeat steps 3 & 4.

Now you can play music from your Bluetooth device wirelessly to the JWM-160.



1. Selecting your favorite song, press the Play  Button on your Bluetooth device or the  Button (#6) on the JWM-160 to play or pause the song from your Bluetooth device.
2. Press  button (#5) or  button (#7) to select the Previous or Next track.
3. Press VOL +/- buttons (#9/8) of your JWM-160 and your Bluetooth device until you reach a comfortable listening level.

Notes :

1. Refer to the manual of your cell phone, tablet PC, computer or other Bluetooth enabled devices for Bluetooth operation since it may vary from model to model.
2. If your Bluetooth enabled device does not support A2DP profile, it will not play the music through the speaker, even if paired (linked).
3. Remember to turn off the JWM-160 when you have finished listening.
4. Don't forget to switch off the power of your external audio device as well.
5. The music playback will automatically be paused when you have an incoming call. When the call is ended the JWM-160 will start playing again.

## USING JWM-160 AS A HANDS-FREE SPEAKERPHONE

To use your Bluetooth speaker as a speakerphone for receiving a phone call from a Bluetooth enabled phone.

1. Follow the "BLUETOOTH OPERATION" section to set up the Bluetooth connection with your smartphone.
2. When a call is received while music is playing, the music will be replaced by a tone. Press the Play/Pause  Button (#6) once to answer the call.
3. Use the VOLUME +/- buttons (#9/#8) to adjust the desired volume level.
4. To ignore an incoming call, simply press and hold the Play/Pause  Button (#6) for about 3 to 4 seconds, a beep sound will be heard and the call was ignored.
5. When the call is completed, press the Play/Pause  Button (#6) once to end the call. If you were playing music from the SMPS-725 before answering the call, the music will automatically resume playing when you hang up.

## CONNECTING YOUR BLUETOOTH DEVICE USING NFC

### ABOUT NFC

NFC (Near Field Communication) is a technology enabling short-range wireless communication between various devices, such as mobile phones and IC tags. Thanks to the NFC function, data communication can be achieved easily just by touching the relevant symbol or designated location on NFC compatible devices.





1. Make sure your Smartphone or Bluetooth device has the NFC feature, and it is turned ON (enabled).
2. Touch the back of your smartphone to the NFC linking point (#25) located on the bottom of the unit. Check the owner's manual of your Bluetooth device to locate the NFC touch point if you are not sure where it is.
3. Turn on the JWM-160 and switch to Bluetooth mode, it will automatically and pair with your smartphone.
4. Some smartphones may ask you to confirm the pairing if they are not paired before.

NOTE: If you have multiple NFC compatible devices to link, just touch the smartphone to a different device to switch the connection to that device. For example, when your smartphone is connected to NFC compatible headphones, just touch the smartphone to the system to change the Bluetooth connection to the system (one touch connection switching).





## ALARM OPERATION

### SETTING THE ALARM TIME

You can set the alarm time and select wake to RADIO  / ALARM  sound.

1. In standby mode, press and hold the ALARM SET/DIM button (#4) until the AL icon and hour digits on the LCD display blink.
2. Tap the  button (#5) or  button (#7) to set the hour.
3. Tap ALARM SET/DIM button (#4) to confirm. The minute digits on the LCD display will blink.
4. Tap ALARM SET/DIM button (#4) to confirm.
5. Tap  button (#5) or  button (#7) repeatedly to select wake to alarm, radio or off.
6. Tap ALARM SET/DIM button (#4) to confirm.
7. Alarm setting completed and LCD display return to show current time.

### SETTING WAKE TO ALARM OR RADIO

1. In standby mode, press and hold the ALARM SET/DIM button (#4) to set alarm.
  - a. Wake to Alarm,  (wake to alarm) will light up.
  - b. Wake to Radio,  (wake to radio) will light up.
  - c. Alarm Off, both  and  light off
2. When alarm sounds, press any buttons once to stop the alarm and it will repeat next day same time.
3. When alarm sounding after one hour, the sound will auto off and repeat next day.



## SNOOZE ALARM





After the radio or alarm sounds, you may press the SNOOZE/SLEEP button (#6) for a few more minutes sleep. The alarm will stop for approximately 9 minutes and then turn on again.

## CHECKING THE ALARM TIME

In ON mode, Press and hold ALARM SET/DIM button (#4) repeatedly to check the Alarm Sound mode, Alarm Time, Volume Level.

## SLEEP OPERATION

The sleep timer allows the unit turn off automatically after a designated time has elapsed.

1. Press and hold the /SLEEP button (#1) to turn on SLEEP function.
2. The time in minutes 120-110-100-90-80-70-60-50-40-30-20-10-1-OFF shifting on the LCD display.
3. Press and hold the /SLEEP button (#1) until the desired time appear on the LCD display.
4. To cancel the sleep timer, press and hold the /SLEEP button (#1) until until the timer shows OFF.
5. To turn the unit "Off" before the selected length of time, tap the /SLEEP button (#1) at any time.

**Note:** To check the remaining sleep time, tap the SLEEP BUTTON (#2) once.

## DIMMER CONTROL

Tap ALARM SET/DIM button (#4) to turn on the backlight. Tape ALARM SET/DIM button (#4) again to turn off the backlight

## RESETTING THE UNIT

In case of malfunction due to electrostatic discharge, press the reset button inside the battery compartment.

Important : After reset, all the settings will be lost. Follow the procedures in the manual to reset the clock, alarm time and radio presets once again.

## CARE AND MAINTENANCE

1. Clean the unit with soft cloth. Solvent or detergent should never be used.
2. Avoid operating your unit under direct sunlight.
3. Keep your unit away from heating appliances and sources of electrical noise such as fluorescent lamps or motors.
4. For better Clock Display clarity, avoid operating the unit under direct sunlight or in strong room illumination.

## TROUBLE SHOOTING GUIDE

If you experience difficulties in the use of this clock radio, please check the following or call 1-800-777-5331 for Customer Service and support

## SPECIFICATION

Power Supply : DC 6V  $\text{---}$  4 x AA (UM3) Batteries (not included)

Frequency : FM 87.5 - 108 MHz  
AM 520 -1710 KHz



At Spectra, environmental and social responsibility is a core value of our business. We are dedicated to continuous implementation of responsible initiatives with an aim to conserve and maintain the environment through responsible recycling.

Please visit us at <http://www.spectraintl.com/green.htm> for more information on Spectra's green initiatives or to find a recycler in your area.

The Bluetooth® word mark and logos are registered trademarks owned by Bluetooth SIG, Inc. and any use of such marks by Spectra Merchandising International, Inc. is under license. Other trademarks and trade names are those of their respective owners.

## 90 DAY LIMITED WARRANTY AND SERVICE VALID IN THE U.S.A. ONLY

SPECTRA MERCHANDISING INTERNATIONAL, INC. warrants this unit to be free from defective materials or factory workmanship for a period of 90 days from the date of original customer purchase and provided the product is utilized within the U.S.A. This warranty is not assignable or transferable. Our obligation under this warranty is the repair or replacement of the defective unit or any part thereof, except batteries, when it is returned to the SPECTRA Service Department, accompanied by proof of the date of original consumer purchase, such as a duplicate copy of a sales receipt.

You must pay all shipping charges required to ship the product to SPECTRA for warranty service. If the product is repaired or replaced under warranty, the return charges will be at SPECTRA's expense. There are no other express warranties other than those stated herein. This warranty is valid only in accordance with the conditions set forth below:

1. The warranty applies to the SPECTRA product only while:
  - a. It remains in the possession of the original purchaser and proof of purchase is demonstrated.

- b. It has not been subjected to accident, misuse, abuse, improper service, usage outside the descriptions and warnings covered within the user manual or non-SPECTRA approved modifications.
  - c. Claims are made within the warranty period.
2. This warranty does not cover damage or equipment failure caused by electrical wiring not in compliance with electrical codes or SPECTRA user manual specifications, or failure to provide reasonable care and necessary maintenance as outlined in the user manual.
  3. Warranty of all SPECTRA products applies to residential use only and is void when products are used in nonresidential environment or installed outside the United States.

This warranty gives you specific legal rights, and you may also have other rights which vary from state to state. TO OBTAIN SERVICE please remove all batteries (if any) and pack the unit carefully and send it freight prepaid to SPECTRA at the address shown below. IF THE UNIT IS RETURNED WITHIN THE WARRANTY PERIOD shown above, please include a proof of purchase (dated cash register receipt) so that we may establish your eligibility for warranty service and repair of the unit without cost. Also include a note with a description explaining how the unit is defective. A customer service representative may need to contact you regarding the status of your repair, so please include your name, address, phone number and email address to expedite the process.

IF THE UNIT IS OUTSIDE THE WARRANTY PERIOD, please include a check for **\$15.00** to cover the cost of repair, handling and return postage. All out of warranty returns must be sent prepaid.

It is recommended that you contact SPECTRA first at 1-800-777-5331 or by email at [custserv@spectraintl.com](mailto:custserv@spectraintl.com) for updated information on the unit requiring service. In some cases the model you have may be discontinued, and SPECTRA reserves the right to offer alternative options for repair or replacement.

SPECTRA MERCHANDISING INTERNATIONAL, INC.  
4230 North Normandy Avenue,  
Chicago, IL60634, USA. 1-800-777-5331

To register your product, visit the link on the website below to enter your information.  
<http://www.spectraintl.com/wform.htm>

0717

Printed in China