

**CRAIG®**

# **PORTABLE SPEAKER**

**with Bluetooth® Wireless Technology**

## *Owner's Manual*

PLEASE READ BEFORE OPERATING THIS EQUIPMENT.

**Model: CMA3692**

Size: 148.5(W) x 210(H)mm (A5)



**FCC NOTICE:**

This equipment has been tested and found to comply with the limits for a Class B digital device, pursuant to Part 15 of the FCC Rules. These limits are designed to provide reasonable protection against harmful interference in a residential installation. This equipment generates, uses and can radiate radio frequency energy and, if not installed and used in accordance with the instructions, may cause harmful interference to radio communications. However, there is no guarantee that interference will not occur in a particular installation. If this equipment does cause harmful interference to radio or television reception, which can be determined by turning the equipment off and on, the user is encouraged to try to correct the interference by one or more of the following measures:

- Reorient or relocate the receiving antenna.
- Increase the separation between the equipment and receiver.
- Connect the equipment into an outlet on a circuit different from that to which the receiver is connected.
- Consult the dealer or an experienced radio/TV technician for help.

**FCC STATEMENT:**

This device complies with part 15 of the FCC Rules. Operation is subject to the following two conditions:

- (1) This device may not cause harmful interference, and
- (2) This device must accept any interference received, including interference that may cause undesired operation.

The device has been evaluated to meet general RF exposure requirement. The device can be used in portable exposure condition without restriction.

**FCC WARNING:**

To assure continued operation, follow the attached installation instructions and use only shield cables when connecting to other devices. Changes or modifications not expressly approved by the party responsible for compliance could void the user's authority to operate the equipment.

## LOCATION OF CONTROLS:

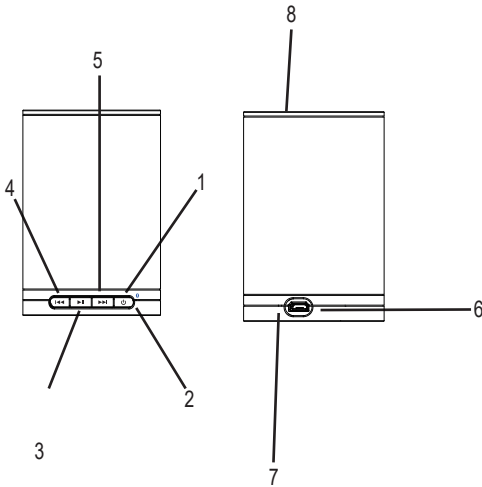

1. Power On / Off Button
2. Blue BT (Bluetooth) Indicator
3. Play/Pause Button
4. Previous Button
5. Next Button
6. DC 5V (Micro USB) Port (For charging only)
7. Red Charging Indicator
8. Speaker

## POWER SOURCE:

The unit has a built-in Li-ion rechargeable battery, recharge it before first time use or when it is drained as follow:

1. Connect the small plug from the supplied USB Connection Cable to the DC 5V (Micro USB) Port on the rear of unit.
2. Connect the full size USB Plug from the supplied USB Connection Cable to the USB Port on the Personal Computer or USB Charger (Personal Computer and USB Charger not included).
3. When charging, the Red Charging Indicator on the rear of unit will illuminate. When charging is complete, it will turn off.

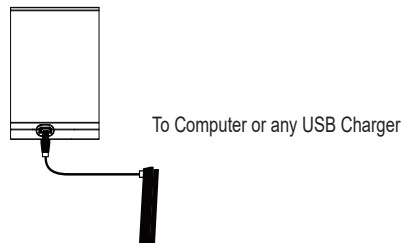

## NOTES:

Your battery will last longer if you following these simple guidelines for caring and storing:







- A. Before first time use, recharge the unit approximately 4 hours until the unit is fully charged.
- B. Charge and store the unit within the temperature range of 5°C - 35°C (40°F - 95°F).
- C. Do not overcharge (longer than 24 hours). Excessive charging or running the unit until battery fully drains will damage battery. Battery life will be extended if you keep the battery fully charged.
- D. Battery life naturally shortens slowly over time.
- E. The rechargeable battery incorporated in this product is not user replaceable.

## OPERATION:

### **BT Mode:**

#### **BT (Bluetooth) pairing:**

First time use or re-pairing the unit to a new BT Device, Pair as follows:

1. Press and hold the  Power On/Off button on the front of unit approximately 0.5 second to power on the unit. The Blue BT (Bluetooth) Indicator on front of the unit will illuminate and blink.
2. Power on the external BT Device and enter to BT searching mode. Start pairing following the on screen instructions from the external BT Device. When paired, the Blue BT Indicator will stop blinking.
3. If pairing is complete you may now play music with your external BT Device.
4. During playback:
  - Press the  Button on the unit to pause, press again to resume normal playback.
  - Press and release the  or  Buttons to adjust volume level as desired.
  - Press and hold the  or  Buttons repeatedly to skip tracks.
5. When finished listening, press the  Power On/Off Button to shut off the unit. The Blue BT Indicator will not light.

#### **Notes:**



- When the external BT Device searched the unit, our model number "CMA3692" will appear on the display of external BT Device.
- If while pairing you are asked for a code please try "0000" or "1234".

#### **Normal operation after pairing:**

1. Power on the external BT Device and enter to BT playback mode.
2. Press and hold the  Power On/Off Button on the front of unit approximately 0.5 second to power on the unit. The Blue BT (Bluetooth) Indicator on front of the unit will illuminate and blink.
3. Wait a few seconds until the unit is automatically paired to the external BT Device. The Blue BT Indicator will stop blinking.
4. After pairing is complete you may now play music with your external BT Device.

## TROUBLE SHOOTING GUIDE

Check the following before requesting service:

SYMPTOM	POSSIBLE CAUSE	POSSIBLE SOLUTION
<b>Can't power on</b>	Buit-in battery drained	Recharge the battery as page 3
	The unit in power off mode	Press and hold the  Power On/Off Button on the front of unit approximately 0.5 second to power on the unit.
<b>No sound or sound weak</b>	Volume of the unit was set to minimum position	Increase the volume level by press and release the  Button repeatedly
	Volume level of paired BT device is in low level	Rise the volume level of the paired BT device
<b>Sound distortion</b>	Volume level too high	Reduce the volume level by press and release the  Button repeatedly
	Volume level of the paired BT device too high	Reduce the volume level of the paired BT device
<b>BT not functioning</b>	The external BT device had not paired to the unit	Pair the external BT device to the unit as page 4
	The external BT device too far from the unit	Place the external BT device close to the unit

## SPECIFICATIONS:

Power Source	Built-in DC $\equiv$ 3.7V, 400 mAh (1.48 WH) rechargeable Li-ion battery; Recharge by DC $\equiv$ 5V through the DC 5V (Mirco USB) Port
Impedance of Speakers	2 W; 3 ohm
Audio Power	1.5 W (RMS)
BT Version	4.1
BT Operation Distance	$\cong$ 32 Feet in open area

## PACKAGE INCLUDES

- 1 x Owner's Manual
- 1 x USB Connection Cable (For charge only)

**SPECIFICATIONS AND ACCESSORIES ARE SUBJECT TO CHANGE WITHOUT NOTICE.**

## LIMITED WARRANTY

Craig warrants this product to be free from manufacturing defects in material and workmanship under normal use for a period of 90 days from date of purchase. If service is required, please return the product to the store where it was purchased for exchange; or, pack the unit in the original packing material with all accessories if applicable, a copy of your sales receipt and a Cashier's check or Money Order for \$3.00 (to cover shipping and handling costs) payable to Craig Electronics Inc. For consumers in Canada, please make sure that the cashier check or money order is redeemable through a U.S. bank. Ship your product freight pre-paid. Your unit will be repaired, replaced or if the unit can not be repaired or replaced, a refund will be forwarded to you within four weeks of receipt of your unit. Please ship your unit to:

Craig Electronics Inc.  
1160 NW 163 Drive  
Miami, FL 33169

This warranty is void if the product has been: a) Used in a commercial application or rental. b) Damaged through misuse, negligence, or abuse. c) Modified or repaired by anyone other than an authorized Craig service center. d) Damaged because it is improperly connected to any other equipment.

Note: This warranty does not cover: a) Ordinary adjustments as outlined in the Owner's Manual which can be performed by the customer. b) Damage to equipment not properly connected to the product. c) Any cost incurred in shipping the product for repair. d) Damage to the product not used in the USA.

This warranty is not transferable and only applies to the original purchase. Any implied warranties, including the warranty of merchantability, are limited in duration to the period of this expressed warranty and no warranty whether expressed or implied shall apply to the product thereafter.

Under no circumstance shall Craig be liable for any loss or consequential damage arising out of the use of this product. This warranty gives specific legal rights. However, you may have other rights which may vary from state to state. Some states do not allow limitations on implied warranties or exclusion of consequential damage. Therefore, these restrictions may not apply to you.

To Obtain Service on your Product  
email: [service@craigelectronics.com](mailto:service@craigelectronics.com)