

FCC 47 CFR PART 15 SUBPART C

CERTIFICATION TEST REPORT

For

Bluetooth Speaker

MODEL No.: MET8043,SP711,SP711XXXX(X can be numbers, letters or spaces)

FCC ID: 2AB4KMETYH8043

Trade Mark: MET, SYLVANIA, CURTIS

REPORT NO:ES180326010W

ISSUE DATE:April 06, 2018

Prepared for

MET INDUSTRIAL LTD

Room 605, 6/F., No. 9 Wing Hong Street, Lai Chi Kok, Kowloon, Hong Kong.

Prepared by

EMTEK(SHENZHEN) CO., LTD.

**Bldg 69, Majialong Industry Zone, NanshanDistrict,Shenzhen,
Guangdong, China**

TEL: 86-755-26954280

FAX: 86-755-26954282

Table of Contents

1	TEST RESULT CERTIFICATION	3
2	EUT TECHNICAL DESCRIPTION	4
3	SUMMARY OF TEST RESULT	5
4	TEST METHODOLOGY	6
4.1	GENERAL DESCRIPTION OF APPLIED STANDARDS	6
4.2	MEASUREMENT EQUIPMENT USED	6
4.3	DESCRIPTION OF TEST MODES	7
5	FACILITIES AND ACCREDITATIONS	8
5.1	FACILITIES	8
5.2	LABORATORY ACCREDITATIONS AND LISTINGS	8
6	TEST SYSTEM UNCERTAINTY	9
7	SETUP OF EQUIPMENT UNDER TEST	10
7.1	RADIO FREQUENCY TEST SETUP 1	10
7.2	RADIO FREQUENCY TEST SETUP 2	10
7.3	CONDUCTED EMISSION TEST SETUP	11
7.4	SUPPORT EQUIPMENT	12
8	FREQUENCY HOPPING SYSTEM REQUIREMENTS	13
8.1	STANDARD APPLICABLE	13
8.2	EUT PSEUDORANDOM FREQUENCY HOPPING SEQUENCE	13
8.3	EQUAL HOPPING FREQUENCY USE	14
8.4	FREQUENCY HOPPING SYSTEM	14
9	TEST REQUIREMENTS	15
9.1	20DB BANDWIDTH	15
9.2	CARRIER FREQUENCY SEPARATION	21
9.3	NUMBER OF HOPPING FREQUENCIES	27
9.4	AVERAGE TIME OF OCCUPANCY (DWELL TIME)	29
9.5	MAXIMUM PEAK CONDUCTED OUTPUT POWER	32
9.6	CONDUCTED SUPRIIOUS EMISSION	38
9.7	RADIATED SPURIOUS EMISSION	45
9.8	CONDUCTED EMISSION TEST	58
9.9	ANTENNA APPLICATION	61

1 TEST RESULT CERTIFICATION

Applicant:	MET INDUSTRIAL LTD Room 605, 6/F., No. 9 Wing Hong Street, Lai Chi Kok, Kowloon, Hong Kong.
Manufacture:	Dongguan City Wangniudun Yinghui Electronics Factory Chijiaoluduan Zhengzhong Road Wangniudun Town Dongguan City, China
Product Description:	Bluetooth Speaker
Model Number:	MET8043,SP711,SP711XXXX(X can be numbers, letters or spaces)
Trade Mark:	MET, SYLVANIA, CURTIS
File Number:	ES180326010W
Date of Test:	March 28, 2018 to April 03, 2018

Measurement Procedure Used:

APPLICABLE STANDARDS	
STANDARD	TEST RESULT
FCC 47 CFR Part 2 2017, Subpart J FCC 47 CFR Part 15 2017, Subpart C	PASS

The above equipment was tested by EMTEK(SHENZHEN) CO., LTD. The test data, data evaluation, test procedures, and equipment configurations shown in this report were made in accordance with the procedures given in ANSI C63.10 (2013) and the energy emitted by the sample EUT tested as described in this report is in compliance with the requirements of FCC Rules Part 2 2017 and Part 15.247 2017

The test results of this report relate only to the tested sample identified in this report.

Date of Test : March 28, 2018 to April 03, 2018

Prepared by:

Yihu

Yihu Xiong/Editor

Reviewer:

Joe Xia

Joe Xia/Supervisor



Approve & Authorized Signer :

Lisa Wang

Lisa Wang/Manager

2 EUT TECHNICAL DESCRIPTION

Characteristics	Description
Device Type	Bluetooth V4.2 with classic mode
Data Rate	1Mbps for GFSK modulation 2Mbps for pi/4-DQPSK modulation 3 Mbps for 8DPSK modulation
Modulation	GFSK modulation (1Mbps) pi/4-DQPSK modulation (2Mbps) 8DPSK modulation (3Mbps)
Operating Frequency Range	2402-2480MHz
Number of Channels	79 channels
Max Transmit Power	0.922 dBm
Antenna Type	PCB Antenna
Gain	0 dbi
Power supply	<input checked="" type="checkbox"/> DC supply: DC 5V
Temperature Range	-10°C ~ +55°C

Note: for more details, please refer to the User's manual of the EUT.

3 SUMMARY OF TEST RESULT

FCC PartClause	Test Parameter	Verdict	Remark
15.247(a)(1)	20 dB Bandwidth	PASS	
15.247(a)(1)	Carrier Frequency Separation	PASS	
15.247(a)(1)	Number of Hopping Frequencies	PASS	
15.247(a)(1)	Average Time of Occupancy (Dwell Time)	PASS	
15.247(b)(1)	Maximum Peak Conducted Output Power	PASS	
15.247(c)	Conducted Spurious Emissions	PASS	
15.247(d) 15.209	Radiated Spurious Emissions	PASS	
15.207	Conducted Emission	PASS	
15.203	Antenna Application	PASS	
NOTE1:N/A (Not Applicable)			

RELATED SUBMITTAL(S) / GRANT(S):

This submittal(s) (test report) is intended for FCC ID: **2AB4KMETYH8043** filing to comply with Section 15.247 of the FCC Part 15, Subpart C.

4 TEST METHODOLOGY

4.1 GENERAL DESCRIPTION OF APPLIED STANDARDS

According to its specifications, the EUT must comply with the requirements of the following standards:
 FCC 47 CFR Part 2, Subpart J
 FCC 47 CFR Part 15, Subpart C
 DA 00-705

4.2 MEASUREMENT EQUIPMENT USED

4.2.1 Conducted Emission Test Equipment

EQUIPMENT TYPE	MFR	MODEL NUMBER	SERIAL NUMBER	LASTCAL.	DUE CAL.
Test Receiver	Rohde & Schwarz	ESCI	26115-010-0027	May 20, 2017	May 19, 2018
L.I.S.N.	Rohde & Schwarz	ENV216	101161	May 20, 2017	May 19, 2018
50ΩCoaxial Switch	Anritsu	MP59B	6100175589	May 21, 2017	May 20, 2018
Voltage Probe	Rohde & Schwarz	ESH2-Z3	100122	May 21, 2017	May 20, 2018
Pulse Limiter	Rohde & Schwarz	ESH3-Z2	100006	May 20, 2017	May 19, 2018
I.S.N	Teseq GmbH	ISN T800	30327	May 21, 2017	May 20, 2018

4.2.2 Radiated Emission Test Equipment

EQUIPMENT TYPE	MFR	MODEL NUMBER	SERIAL NUMBER	LAST CAL.	DUE CAL.
EMI Test Receiver	Rohde & Schwarz	ESU	1302.6005.26	May 21, 2017	May 20, 2018
Pre-Amplifier	HP	8447F	2944A07999	May 20, 2017	May 19, 2018
Bilog Antenna	Schwarzbeck	VULB9163	142	May 20, 2017	May 19, 2018
Loop Antenna	ARA	PLA-1030/B	1029	May 20, 2017	May 19, 2018
Horn Antenna	Schwarzbeck	BBHA 9170	BBHA9170399	May 21, 2017	May 20, 2018
Horn Antenna	Schwarzbeck	BBHA 9120	D143	May 20, 2017	May 19, 2018
Cable	Schwarzbeck	AK9513	ACRX1	May 21, 2017	May 20, 2018
Cable	Rosenberger	N/A	FP2RX2	May 21, 2017	May 20, 2018
Cable	Schwarzbeck	AK9513	CRPX1	May 21, 2017	May 20, 2018
Cable	Schwarzbeck	AK9513	CRRX2	May 21, 2017	May 20, 2018

4.2.3 Radio Frequency Test Equipment

EQUIPMENT TYPE	MFR	MODEL NUMBER	SERIAL NUMBER	LASTCAL.	DUE CAL.
Spectrum Analyzer	Agilent	E4407B	88156318	May 21, 2017	May 20, 2018
Signal Analyzer	Agilent	N9010A	My53470879	May 21, 2017	May 20, 2018
Power meter	Anritsu	ML2495A	0824006	May 21, 2017	May 20, 2018
Power sensor	Anritsu	MA2411B	0738172	May 21, 2017	May 20, 2018

Remark: Each piece of equipment is scheduled for calibration once a year.

4.3 DESCRIPTION OF TEST MODES

The EUT has been tested under its typical operating condition.

The EUT configuration for testing is installed on RF field strength measurement to meet the Commissions requirement and operating in a manner which intends to maximize its emission characteristics in a continuous normal application.

The Transmitter was operated in the normal operating mode. The TX frequency was fixed which was for the purpose of the measurements.

Test of channel included the lowest and middle and highest frequency to perform the test, then record on this report.

Those data rates (1Mbps for Bluetooth GFSK modulation; 2Mbps for Bluetooth pi/4-DQPSK modulation; 3Mbps for Bluetooth 8DPSK modulation) were used for all test.

Pre-defined engineering program for regulatory testing used to control the EUT for staying in continuous transmitting and receiving mode is programmed.

Frequency and Channel list for Bluetooth V4.2 with classic mode

Channel	Frequency (MHz)	Channel	Frequency (MHz)	Channel	Frequency (MHz)
0	2402	39	2441
1	2403	40	2442	76	2478
2	2404	41	2443	77	2479
...	78	2480

Note: $f_c = 2402\text{MHz} + (k-1) \times 1\text{MHz}$ $k=1$ to 79

Test Frequency and channel for Bluetooth V4.2 with classic mode

Lowest Frequency		Middle Frequency		Highest Frequency	
Channel	Frequency (MHz)	Channel	Frequency (MHz)	Channel	Frequency (MHz)
0	2402	39	2441	78	2480

5 FACILITIES AND ACCREDITATIONS

5.1 FACILITIES

All measurement facilities used to collect the measurement data are located at

Bldg 69, Majialong Industry Zone District, Nanshan District, Shenzhen, China

The sites are constructed in conformance with the requirements of ANSI C63.7, ANSI C63.10 and CISPR Publication 22.

5.2 LABORATORY ACCREDITATIONS AND LISTINGS

Site Description

- EMC Lab.
- : Accredited by CNAS, 2016.10.24
The certificate is valid until 2022.10.28
The Laboratory has been assessed and proved to be in compliance with CNAS-CL01: 2006(identical to ISO/IEC17025: 2005)
The Certificate Registration Number is L2291

 - : Accredited by TUV Rheinland Shenzhen, 2016.5.19
The Laboratory has been assessed according to the requirements ISO/IEC 17025.

 - :
Accredited by FCC, August 03, 2017
Designation Number: CN1204
Test Firm Registration Number: 882943

 - Accredited by A2LA, July 31, 2017
The Certificate Registration Number is 4321.01.

 - : Accredited by Industry Canada, November 24, 2015
The Certificate Registration Number is 4480A

6 TEST SYSTEM UNCERTAINTY

The following measurement uncertainty levels have been estimated for tests performed on the apparatus:

Parameter	Uncertainty
Radio Frequency	$\pm 1 \times 10^{-5}$
Maximum Peak Output Power Test	$\pm 1.0\text{dB}$
Conducted Emissions Test	$\pm 2.0\text{dB}$
Radiated Emission Test	$\pm 2.0\text{dB}$
Occupied Bandwidth Test	$\pm 1.0\text{dB}$
Band Edge Test	$\pm 3\text{dB}$
All emission, radiated	$\pm 3\text{dB}$
Antenna Port Emission	$\pm 3\text{dB}$
Temperature	$\pm 0.5^{\circ}\text{C}$
Humidity	$\pm 3\%$

Measurement Uncertainty for a level of Confidence of 95%

7 SETUP OF EQUIPMENT UNDER TEST

7.1 RADIO FREQUENCY TEST SETUP 1

The Bluetooth component's antenna ports(s) of the EUT are connected to the measurement instrument per an appropriate attenuator. The EUT is controlled by PC/software to emit the specified signals for the purpose of measurements.

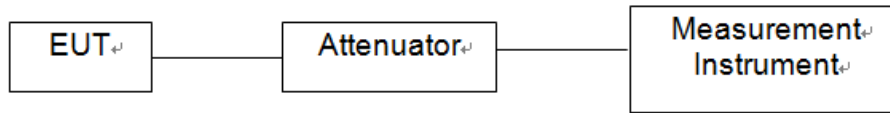

7.2 RADIO FREQUENCY TEST SETUP 2

The test site semi-anechoic chamber has met the requirement of NSA tolerance 4 dB according to the standards: ANSI C63.10. The test distance is 3m. The setup is according to the requirements in Section 13.1.4.1 of ANSI C63.10-2013 and CAN/CSA-CEI/IEC CISPR 22.

Below 30MHz:

The EUT is placed on a turntable 0.8 meters above the ground in the chamber, 3 meter away from the antenna (loop antenna). The Antenna should be positioned with its plane vertical at the specified distance from the EUT and rotated about its vertical axis for maximum response at each azimuth about the EUT. The center of the loop shall be 1 m above the ground. For certain applications, the loop antenna plane may also need to be positioned horizontally at the specified distance from the EUT.

30MHz-1GHz:

The EUT is placed on a turntable 0.8 meters above the ground in the chamber, 3 meter away from the antenna. The maximal emission value is acquired by adjusting the antenna height, polarisation and turntable azimuth. Normally, the height range of antenna is 1 m to 4 m, the azimuth range of turntable is 0° to 360°, and the receive antenna has two polarizations Vertical (V) and Horizontal (H).

Above 1GHz:

The EUT is placed on a turntable 1.5 meters above the ground in the chamber, 3 meter away from the antenna. The maximal emission value is acquired by adjusting the antenna height, polarisation and turntable azimuth. Normally, the height range of antenna is 1 m to 4 m, the azimuth range of turntable is 0° to 360°, and the receive antenna has two polarizations Vertical (V) and Horizontal (H).

(a) Radiated Emission Test Set-Up, Frequency Below 30MHz

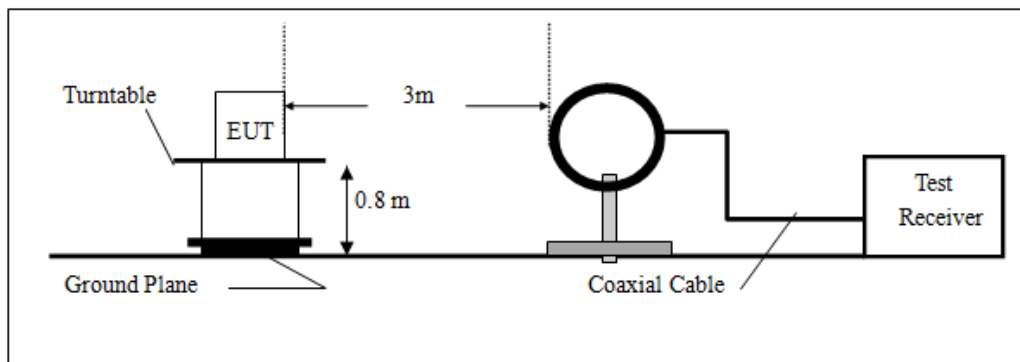

(b) Radiated Emission Test Set-Up, Frequency Below 1000MHz

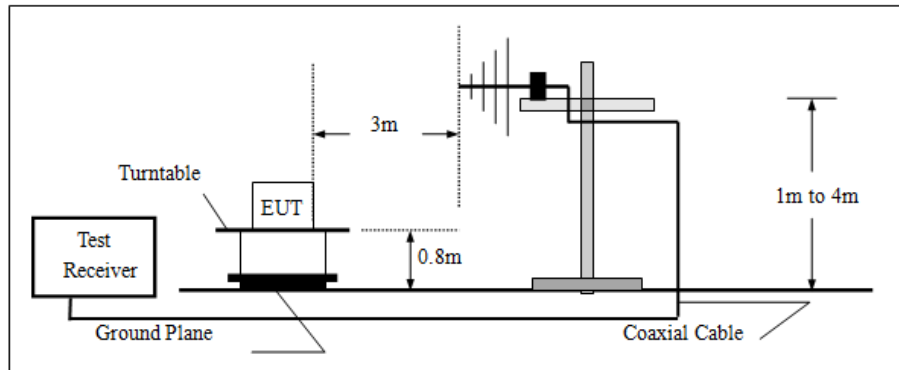

(c) Radiated Emission Test Set-Up, Frequency above 1000MHz

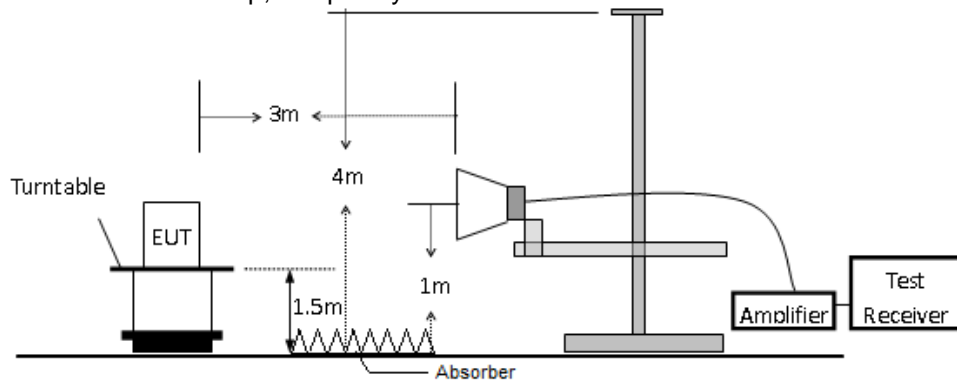

7.3 CONDUCTED EMISSION TEST SETUP

The mains cable of the EUT (Game fitness board) must be connected to LISN. The LISN shall be placed 0.8 m from the boundary of EUT and bonded to a ground reference plane for LISN mounted on top of the ground reference plane. This distance is between the closest points of the LISN and the EUT. All other units of the EUT and associated equipment shall be at least 0.8m from the LISN.

Ground connections, where required for safety purposes, shall be connected to the reference ground point of the LISN and, where not otherwise provided or specified by the manufacturer, shall be of same length as the mains cable and run parallel to the mains connection at a separation distance of not more than 0.1 m.

According to the requirements in Section 13.1.4.1 of ANSI C63.10-2013 Conducted emissions from the EUT measured in the frequency range between 0.15 MHz and 30 MHz using CISPR Quasi-Peak and average detector mode.

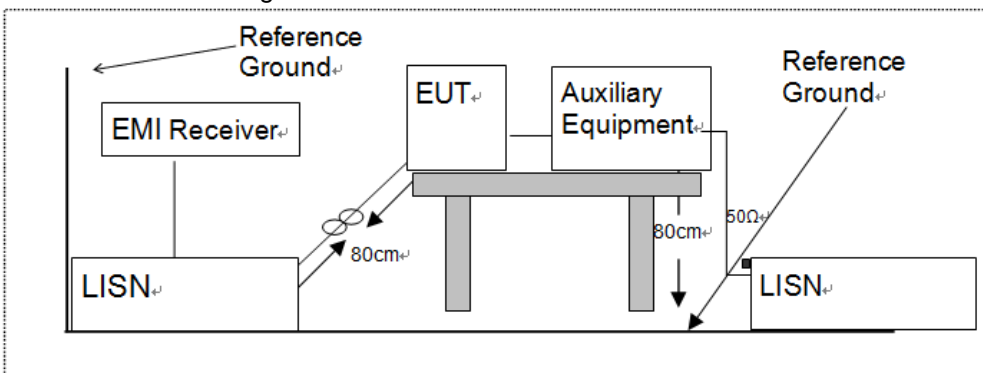

7.4 SUPPORT EQUIPMENT

EUT Cable List and Details			
Cable Description	Length (m)	Shielded/Unshielded	With / Without Ferrite
/	/	/	/

Auxiliary Cable List and Details			
Cable Description	Length (m)	Shielded/Unshielded	With / Without Ferrite
AUX IN	/	/	/

Auxiliary Equipment List and Details			
Description	Manufacturer	Model	Serial Number
Adapter	/	/	/
iPhone	Apple	iPhone 5C/A1526	N/A

Notes:

1. All the equipment/cables were placed in the worst-case configuration to maximize the emission during the test.
2. Grounding was established in accordance with the manufacturer's requirements and conditions for the intended use.

8 FREQUENCY HOPPING SYSTEM REQUIREMENTS

8.1 Standard Applicable

According to FCC Part 15.247(a)(1), The system shall hop to channel frequencies that are selected at the system hopping rate from a pseudo randomly ordered list of hopping frequencies. Each frequency must be used equally on the average by each transmitter. The system receivers shall have input bandwidths that match the hopping channel bandwidths of their corresponding transmitters and shall shift frequencies in synchronization with the transmitted signals.

(g) Frequency hopping spread spectrum systems are not required to employ all available hopping channels during each transmission. However, the system, consisting of both the transmitter and the receiver, must be designed to comply with all of the regulations in this section should the transmitter be presented with a continuous data (or information) stream. In addition, a system employing short transmission bursts must comply with the definition of a frequency hopping system and must distribute its transmissions over the minimum number of hopping channels specified in this section.

(h) The incorporation of intelligence within a frequency hopping spread spectrum system that permits the system to recognize other users within the spectrum band so that it individually and independently chooses and adapts its hopsets to avoid hopping on occupied channels is permitted. The coordination of frequency hopping systems in any other manner for the express purpose of avoiding the simultaneous occupancy of individual hopping frequencies by multiple transmitters is not permitted.

8.2 EUT Pseudorandom Frequency Hopping Sequence

The channel is represented by a pseudo-random hopping sequence hopping through the 79 RF channels. The hopping sequence is unique for the piconet and is determined by the Bluetooth device address of the master; the phase in the hopping sequence is determined by the Bluetooth clock of the master. The channel is divided into time slots where each slot corresponds to an RF hop frequency. Consecutive hops correspond to different RF hop frequencies. The normal hop is 1 600 hops/s.

The pseudorandom sequence may be generated in a nine-stage shift register whose 5th and 9th stage outputs are added in a modulo-two addition stage, and the result is fed back to the input of the first stage. The sequence begins with the first ONE of 9 consecutive ONES; i.e. the shift register is initialized with nine ones. Number of shift register stages: 9
Length of pseudo-random sequence: $2^9 - 1 = 511$ bits
Longest sequence of zeros: 8 (non-inverted signal)

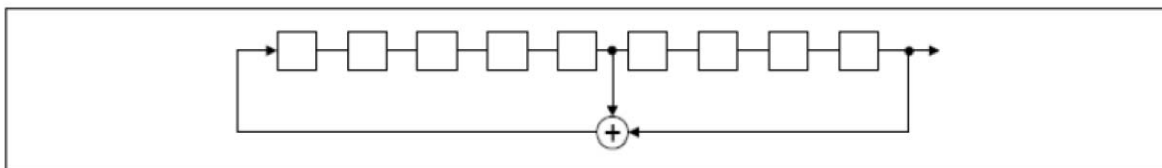

Linear Feedback Shift Register for Generation of the PRBS sequence

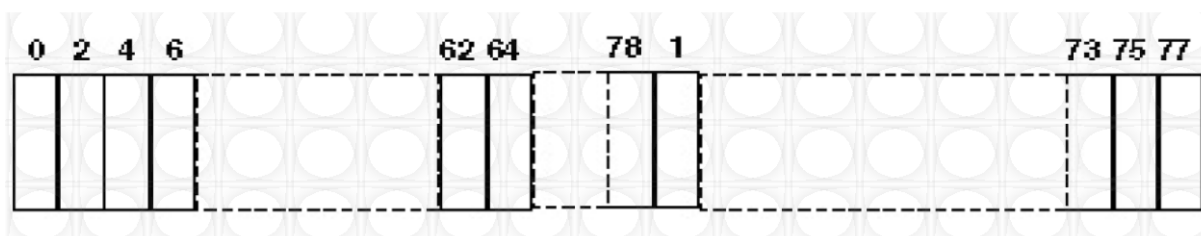

Each frequency used equally on the average by each transmitter.
The system receiver have input bandwidths that match the hopping channel bandwidths of their corresponding transmitters and shift frequencies in synchronization with the transmitted signals.

8.3 Equal Hopping Frequency Use

All Bluetooth units participating in the piconet are time and hop-synchronized to the channel.

Example of a 79 hopping sequence in data mode:

35, 27, 6, 44, 14, 61, 74, 32, 1, 11, 23, 2, 55, 65, 29, 3, 9, 52, 78, 58, 40, 25, 0, 7, 18, 26, 76, 60, 47, 50, 2, 5, 16, 37, 70, 63, 66, 54, 20, 13, 4, 8, 15, 21, 26, 10, 73, 77, 67, 69, 43, 24, 57, 39, 46, 72, 48, 33, 17, 31, 75, 19, 41, 62, 68, 28, 51, 66, 30, 56, 34, 59, 71, 22, 49, 64, 38, 45, 36, 42, 53

Each Frequency used equally on the average by each transmitter

8.4 Frequency Hopping System

This transmitter device is frequency hopping device, and complies with FCC part 15.247 rule.

This device uses Bluetooth radio which operates in 2400-2483.5 MHz band. Bluetooth uses a radio technology called frequency-hopping spread spectrum, which chops up the data being sent and transmits chunks of it on up to 79 bands (1 MHz each; centred from 2402 to 2480 MHz) in the range 2,400-2,483.5 MHz. The transmitter switches hop frequencies 1,600 times per second to assure a high degree of data security. All Bluetooth devices participating in a given piconet are synchronized to the frequency-hopping channel for the piconet. The frequency hopping sequence is determined by the master's device address and the phase of the hopping sequence (the frequency to hop at a specific time) is determined by the master's internal clock. Therefore, all slaves in a piconet must know the master's device address and must synchronize their clocks with the master's clock.

Adaptive Frequency Hopping (AFH) was introduced in the Bluetooth specification to provide an effective way for a Bluetooth radio to counteract normal interference. AFH identifies "bad" channels, where either other wireless devices are interfering with the Bluetooth signal or the Bluetooth signal is interfering with another device. The AFH-enabled Bluetooth device will then communicate with other devices within its piconet to share details of any identified bad channels. The devices will then switch to alternative available "good" channels, away from the areas of interference, thus having no impact on the bandwidth used.

9 TEST REQUIREMENTS

9.1 20DB BANDWIDTH

9.1.1 Applicable Standard

According to FCC Part 15.247(a)(1) and DA 00-705

9.1.2 Conformance Limit

No limit requirement.

9.1.3 Test Configuration

Test according to clause 7.1 radio frequency test setup 1

9.1.4 Test Procedure

The EUT was operating in Bluetooth v4.2 with classic mode and controlled its channel. Printed out the test result from the spectrum by hard copy function.

The RF output of EUT was connected to the spectrum analyzer by RF cable and attenuator. The path loss was compensated to the results for each measurement.

Set to the maximum power setting and enable the EUT transmit continuously

Set RBW = 30 kHz.

Set the video bandwidth (VBW) =100kHz.

Set Span= approximately 2 to 3 times the 20 dB bandwidth

Set Detector = Peak.

Set Trace mode = max hold.

Set Sweep = auto couple.

The EUT should be transmitting at its maximum data rate. Allow the trace to stabilize. Use the marker-to-peak function to set the marker to the peak of the emission. Use the marker-delta function to measure 20 dB down one side of the emission. Reset the marker-delta function, and move the marker to the other side of the emission, until it is (as close as possible to) even with the reference marker level. The marker-delta reading at this point is the 20 dB bandwidth of the emission.

If this value varies with different modes of operation (e.g., data rate, modulation format, etc.), repeat this test for each variation.

Measure and record the results in the test report.

Test Results

Temperature:	24°C	Test Date:	March 29, 2018
Humidity:	53 %	Test By:	KK

Modulation Mode	Channel Number	Channel Frequency (MHz)	20dB Bandwidth (kHz)
GFSK	0	2402	1042
	39	2441	1041
	78	2480	1037
pi/4-DQPSK	0	2402	1120
	39	2441	1114
	78	2480	1115
8DPSK	0	2402	1195
	39	2441	1197
	78	2480	1200

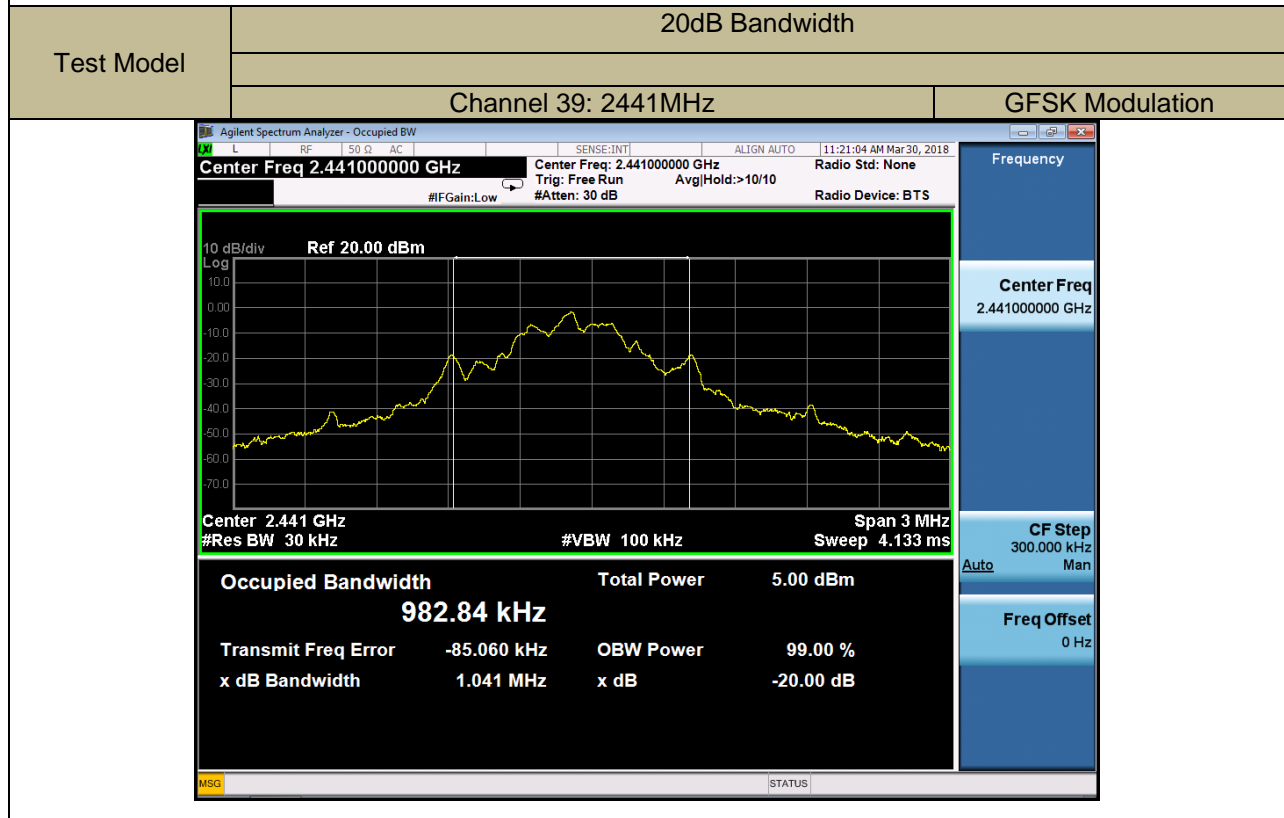
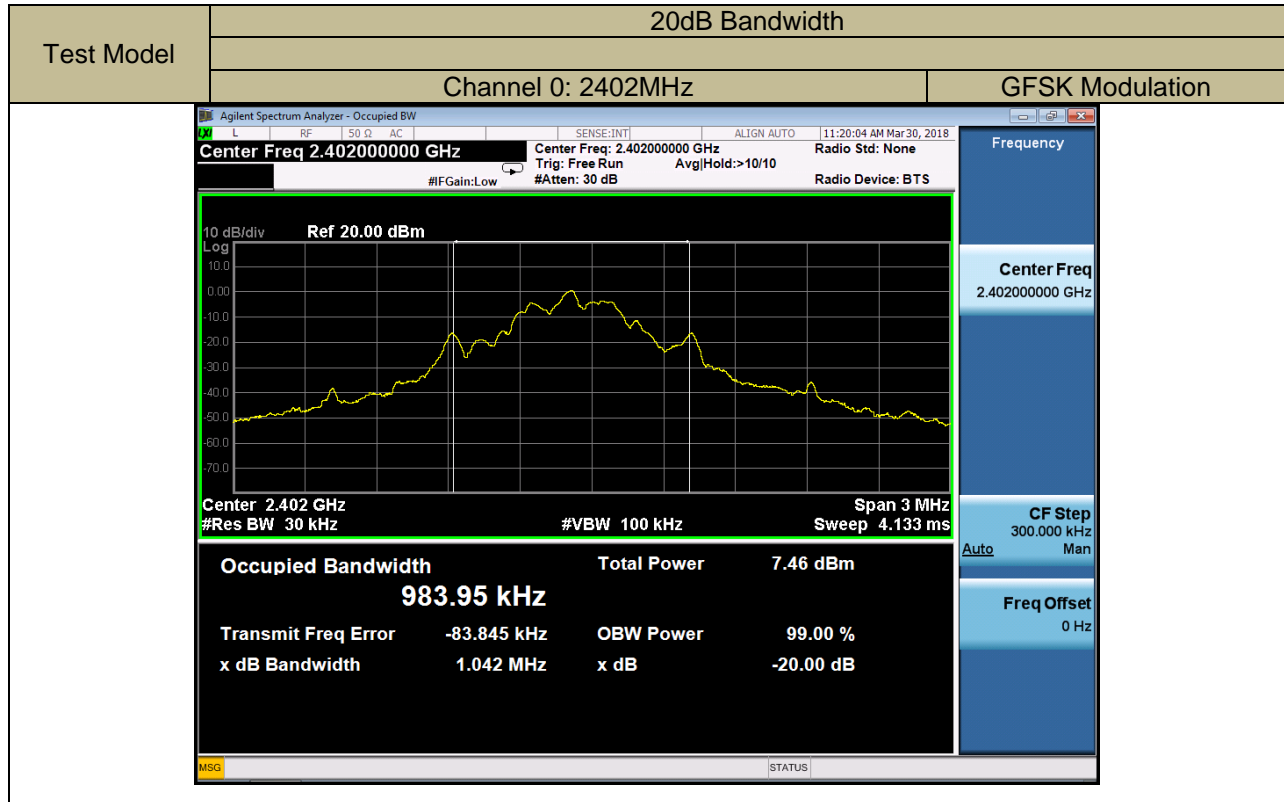

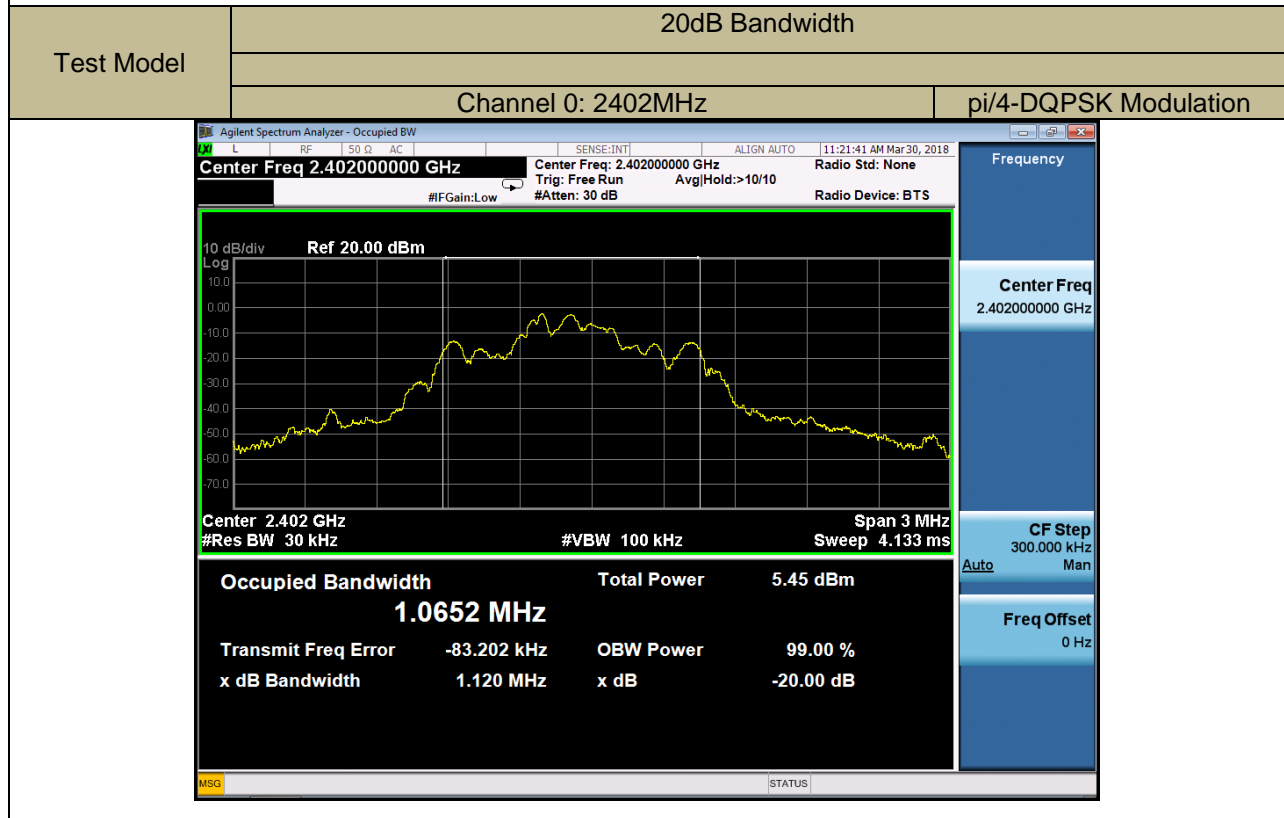
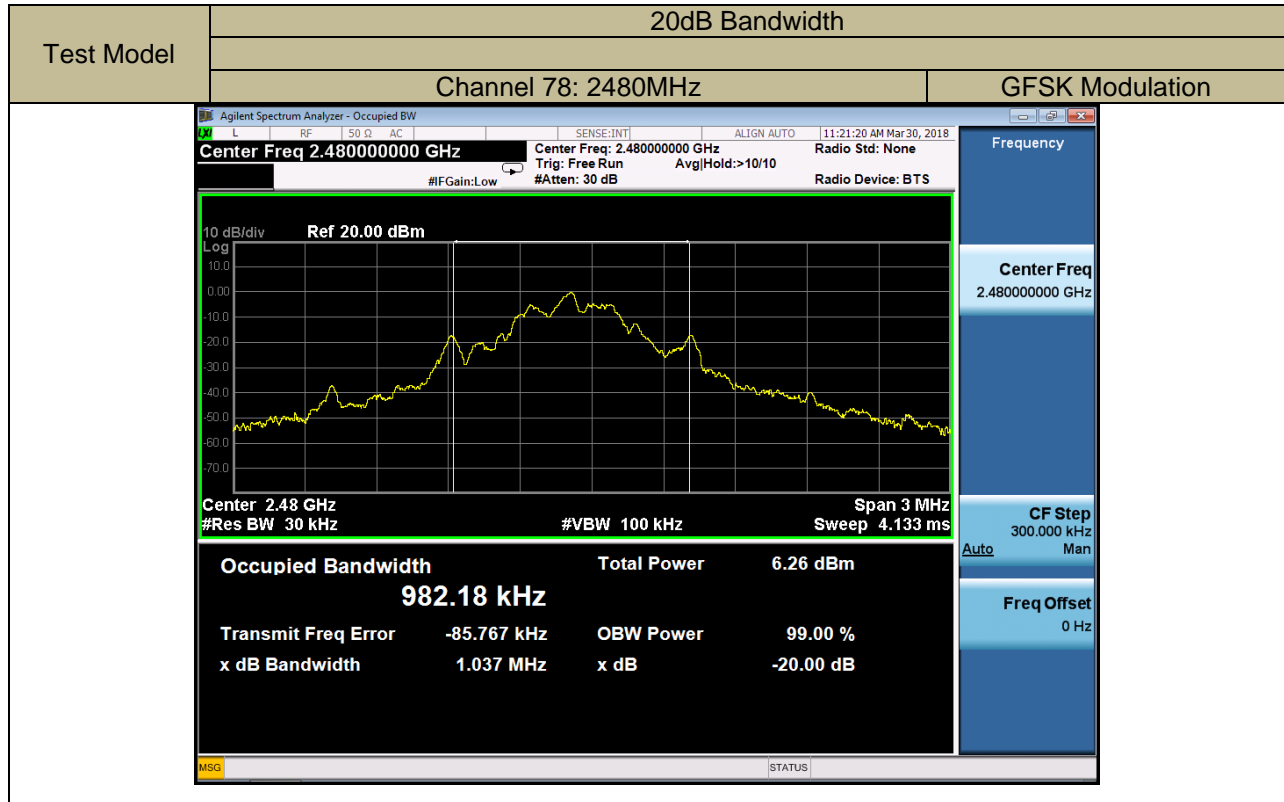

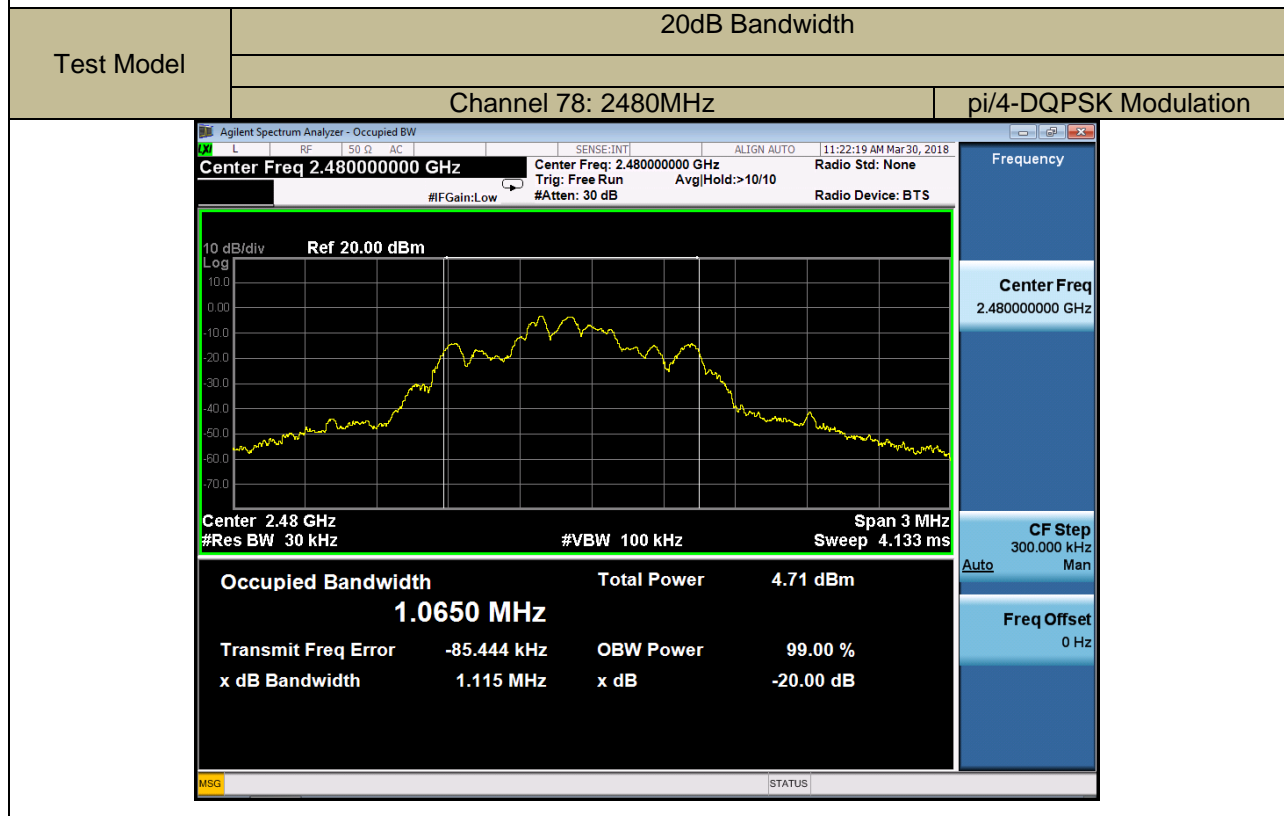
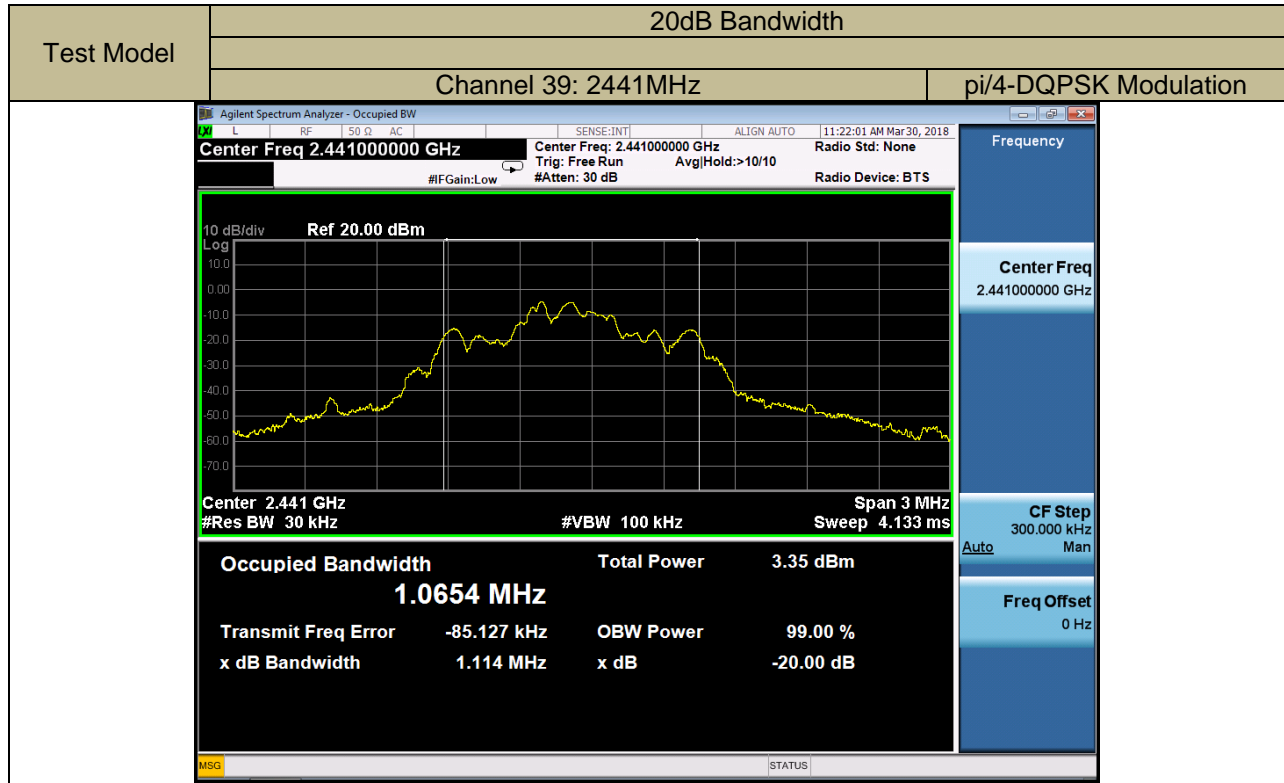

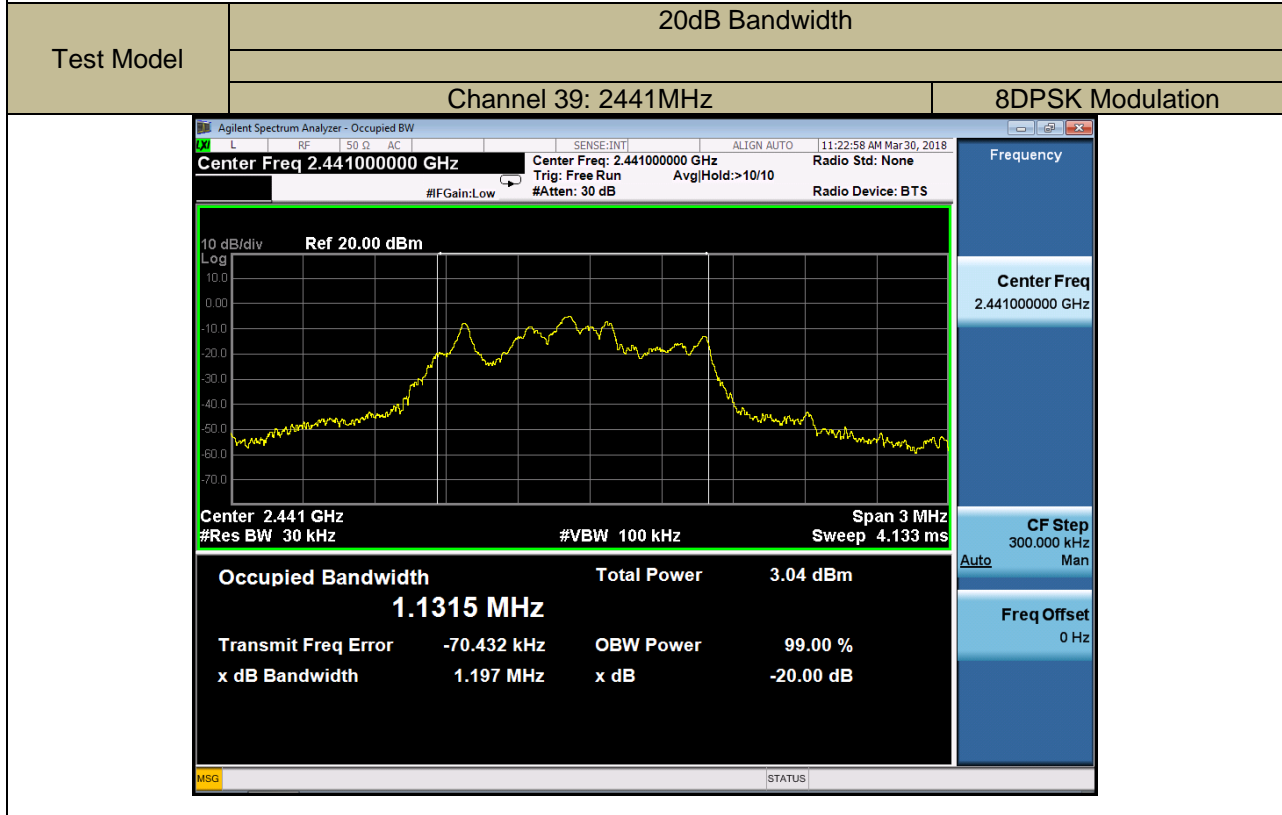
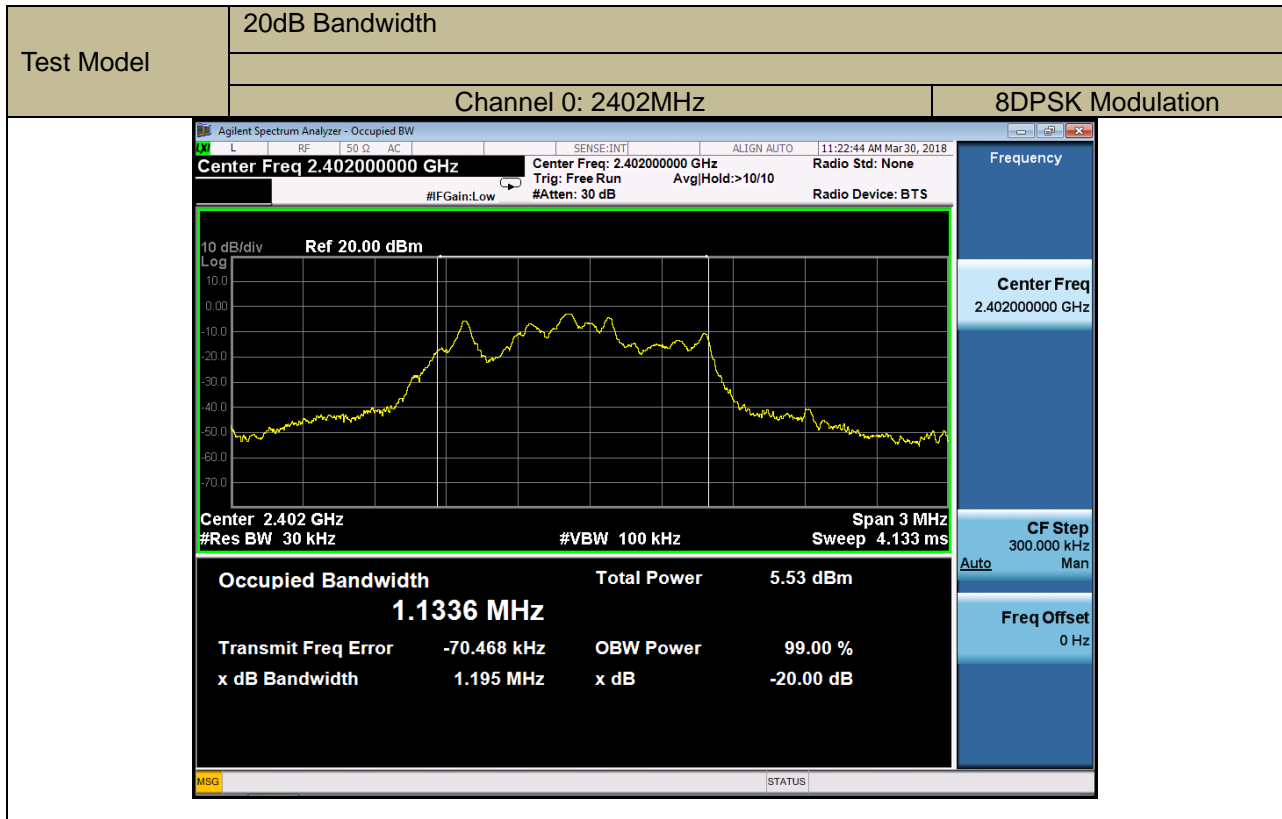

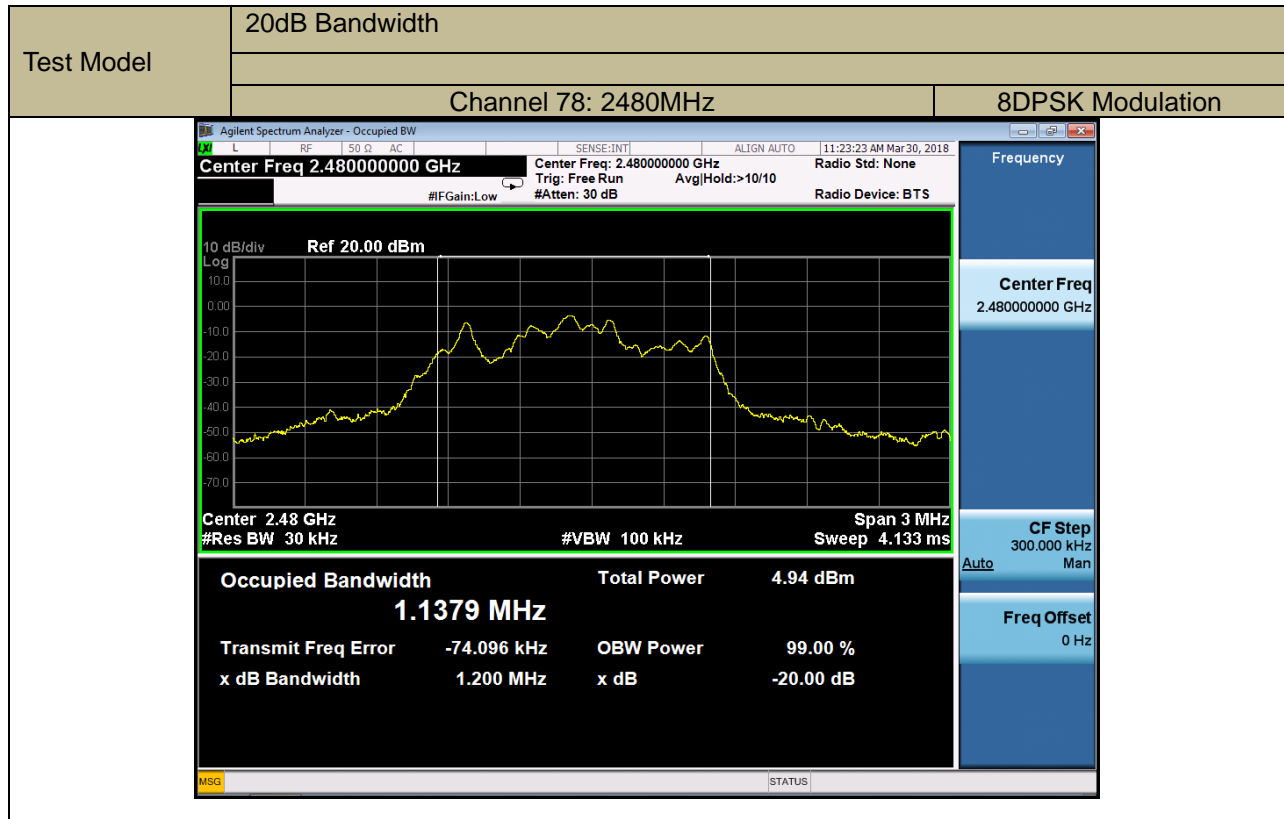

9.2 CARRIER FREQUENCY SEPARATION

9.2.1 Applicable Standard

According to FCC Part 15.247(a)(1) and DA 00-705

9.2.2 Conformance Limit

Frequency hopping systems operating in the 2400-2483.5MHz band shall have hopping channel carrier frequencies separated by a minimum of 25kHz or the 20dB bandwidth of the hopping channel, whichever is greater.

In case of an output power less than 125mW, the frequency hopping system may have channels separated by a minimum of 25kHz or two-thirds of the 20dB bandwidth of the hopping channel, whichever is greater.

9.2.3 Test Configuration

Test according to clause 7.1 radio frequency test setup 1

9.2.4 Test Procedure

■ According to FCC Part 15.247(a)(1)

The EUT must have its hopping function enabled. Use the following spectrum analyzer settings:

Set the RBW = 100kHz. Set VBW = 300kHz.

Set the span = wide enough to capture the peaks of two adjacent channels

Set Sweep time = auto couple.

Set Detector = peak. Set Trace mode = max hold.

Allow the trace to stabilize. Use the marker-delta function to determine the separation between the peaks of the adjacent channels. The limit is specified in one of the subparagraphs of this Section. Submit this plot.

Test Results

Temperature: 24°C
Humidity: 53 %

Test Date: March 29, 2018
Test By: KK

Modulation Mode	Channel Number	Channel Frequency (MHz)	Measurement Bandwidth (kHz)	Limit (kHz)	Verdict
GFSK	0	2402	1002	>694.67	PASS
	39	2441	999	>694.00	PASS
	78	2480	1002	>691.33	PASS
pi/4-DQPSK	0	2402	1008	>746.67	PASS
	39	2441	1008	>742.67	PASS
	78	2480	1011	>742.00	PASS
8DPSK	0	2402	1002	>796.67	PASS
	39	2441	1005	>798.00	PASS
	78	2480	1008	>800.00	PASS

Note: Limit = 20dB bandwidth * 2/3, if it is greater than 25kHz and the output power is less than 125mW (21dBm).

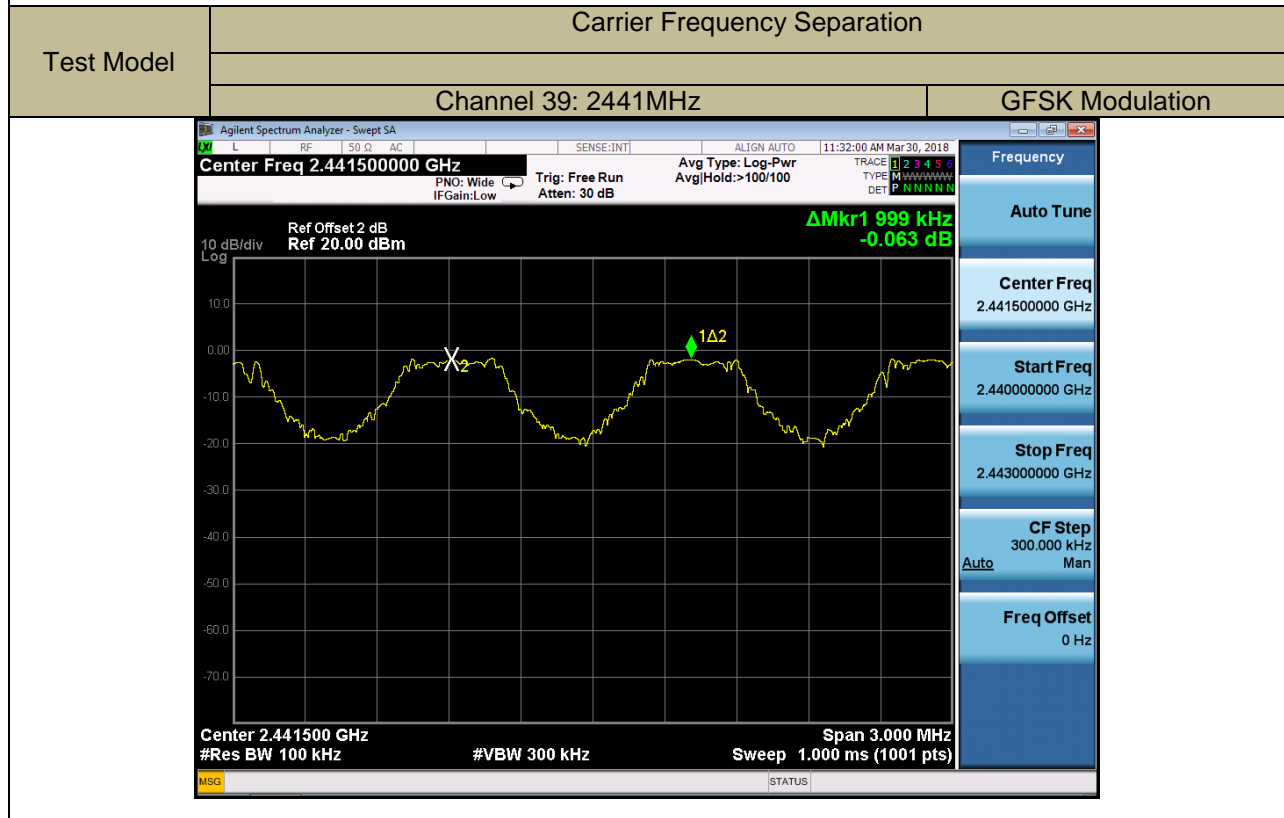
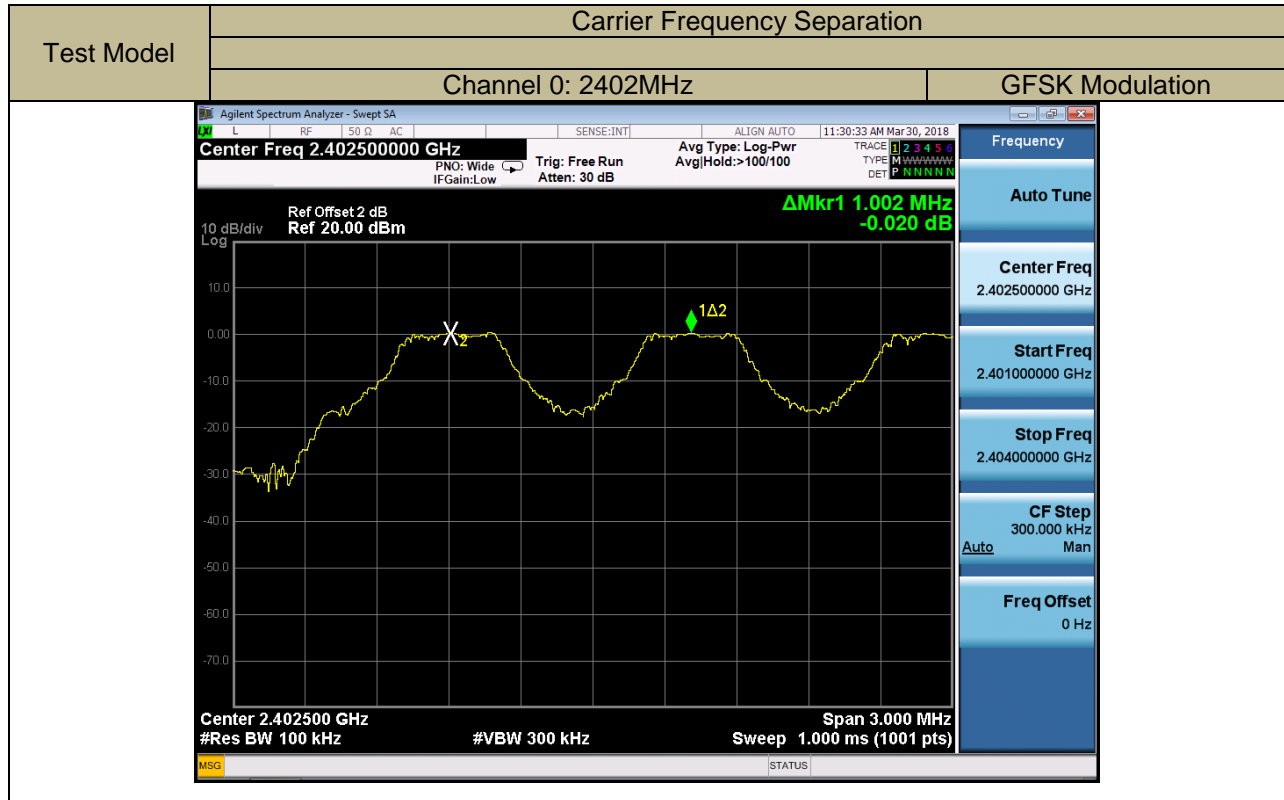

Test Model	Carrier Frequency Separation	
	Channel 78: 2480MHz	GFSK Modulation

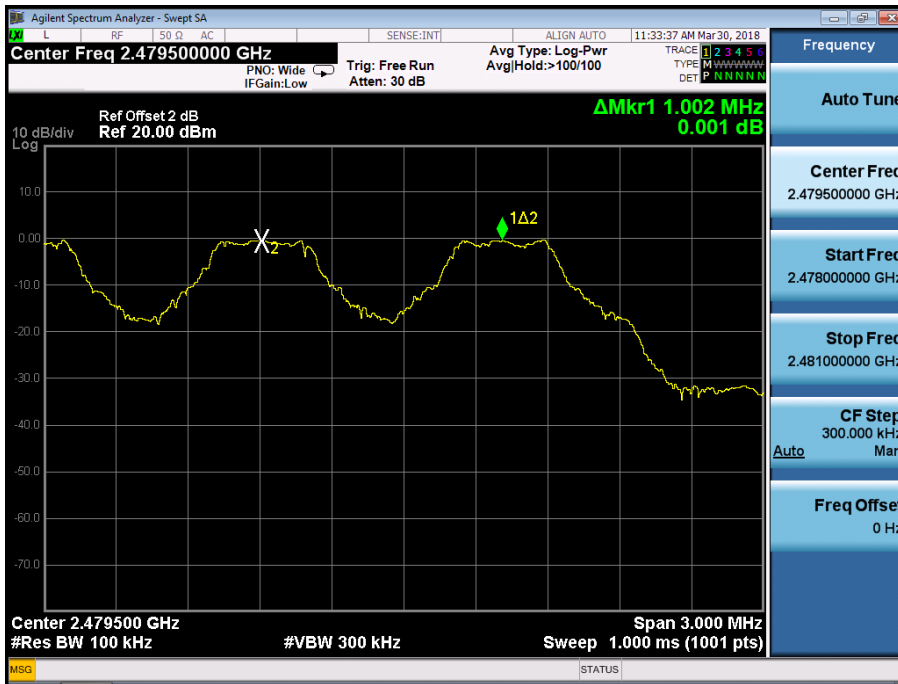

Test Model	Carrier Frequency Separation	
	Channel 0: 2402MHz	pi/4-DQPSK Modulation

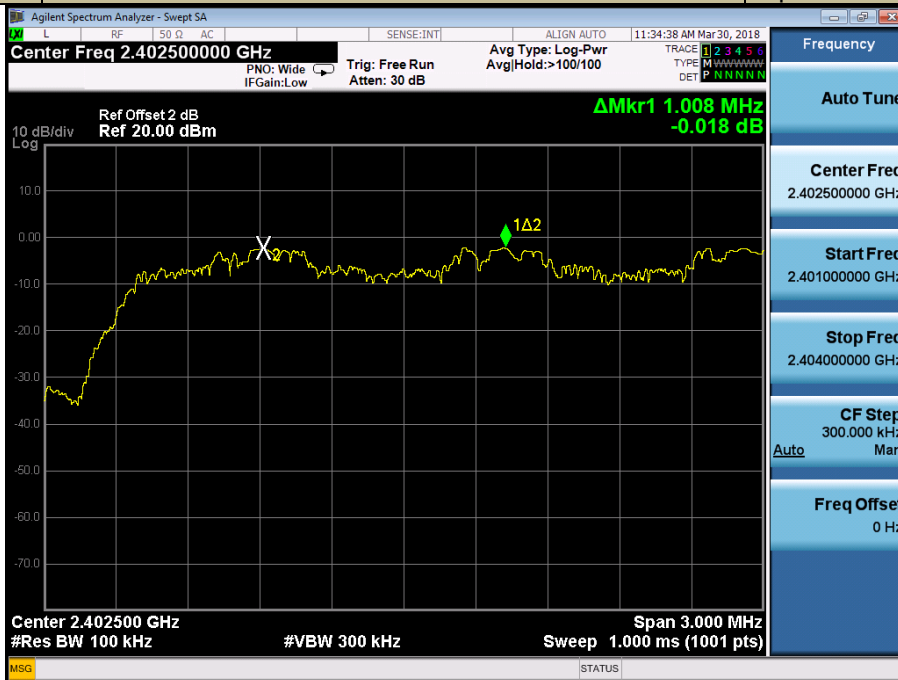

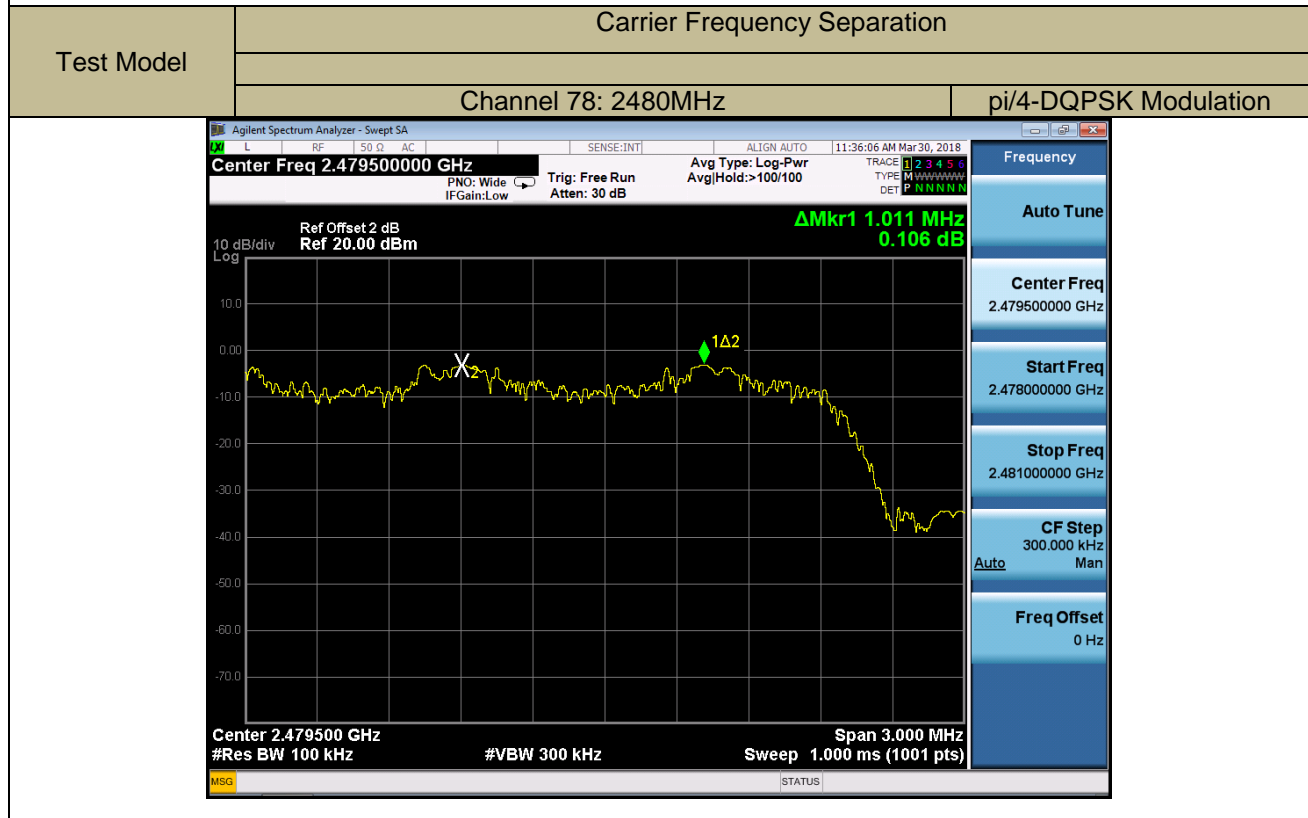
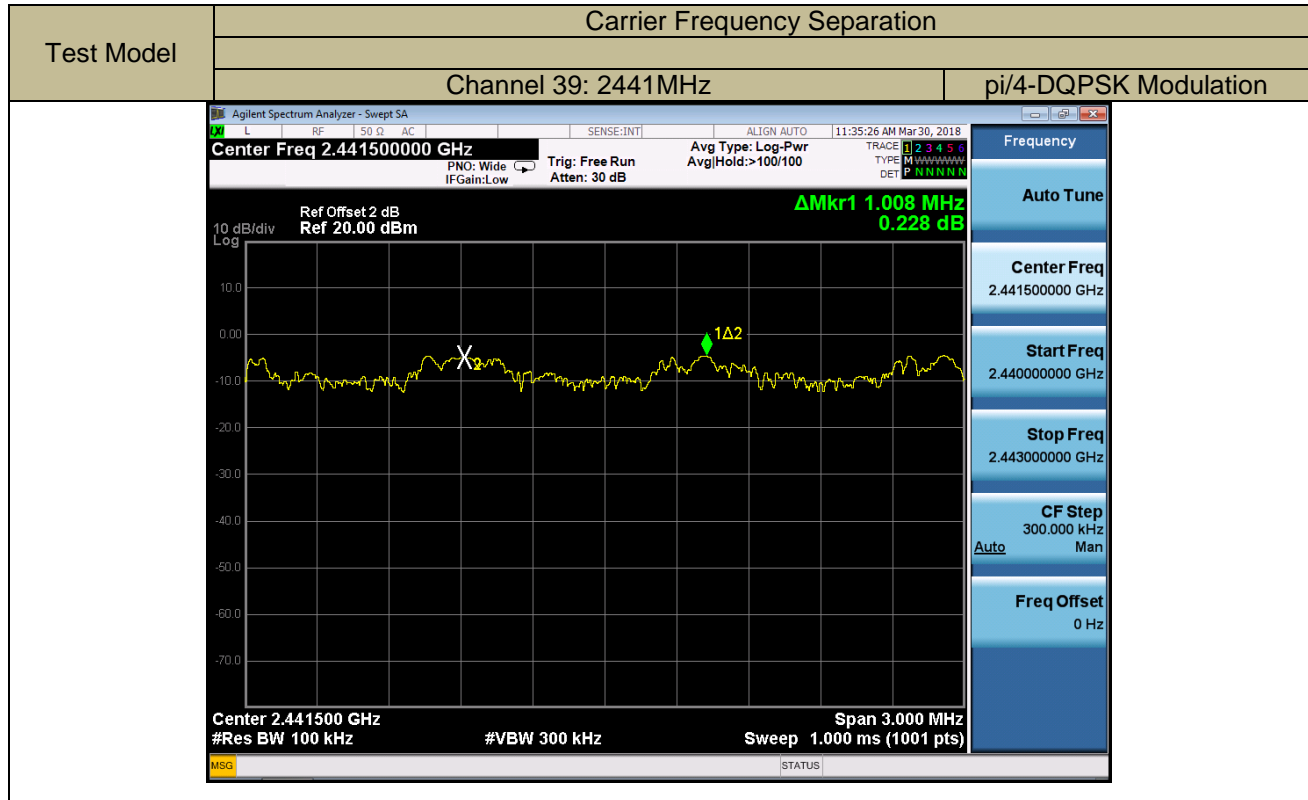

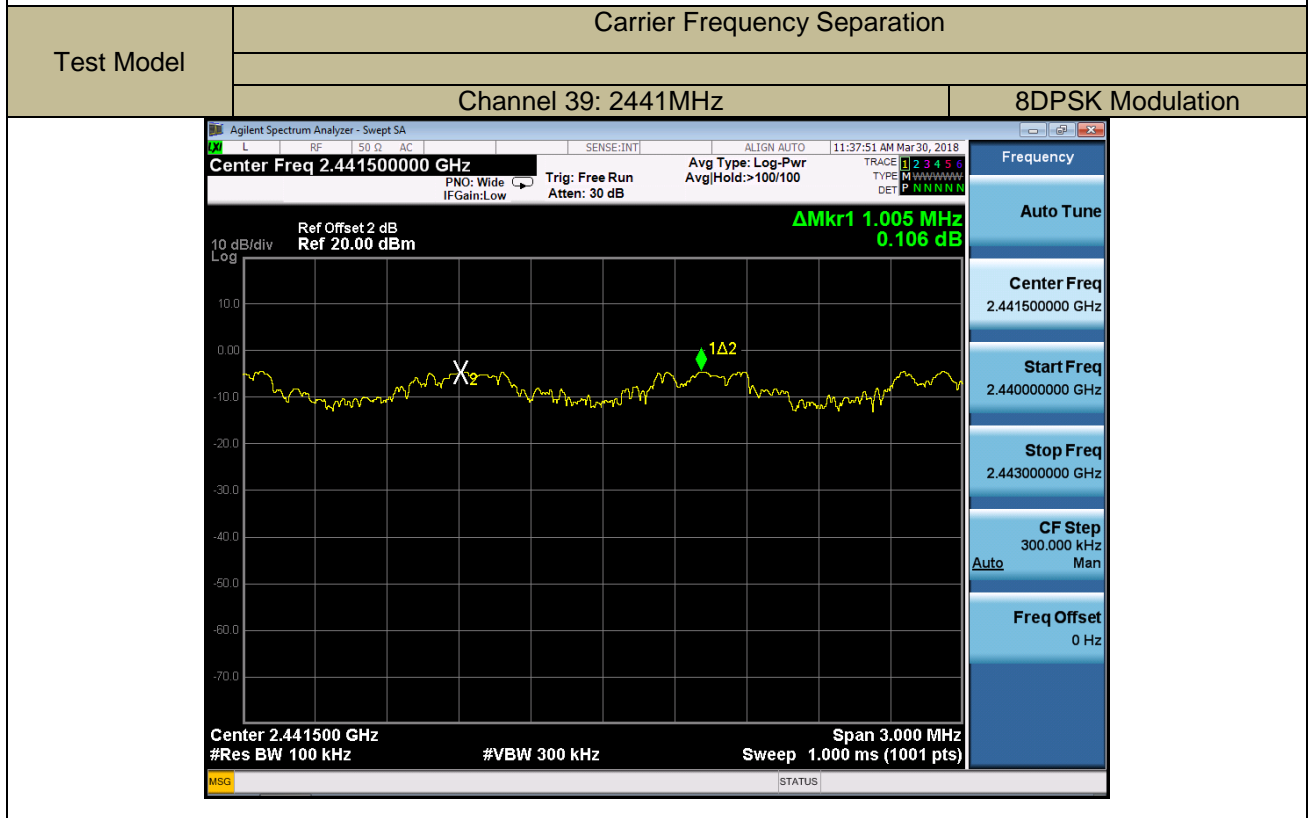
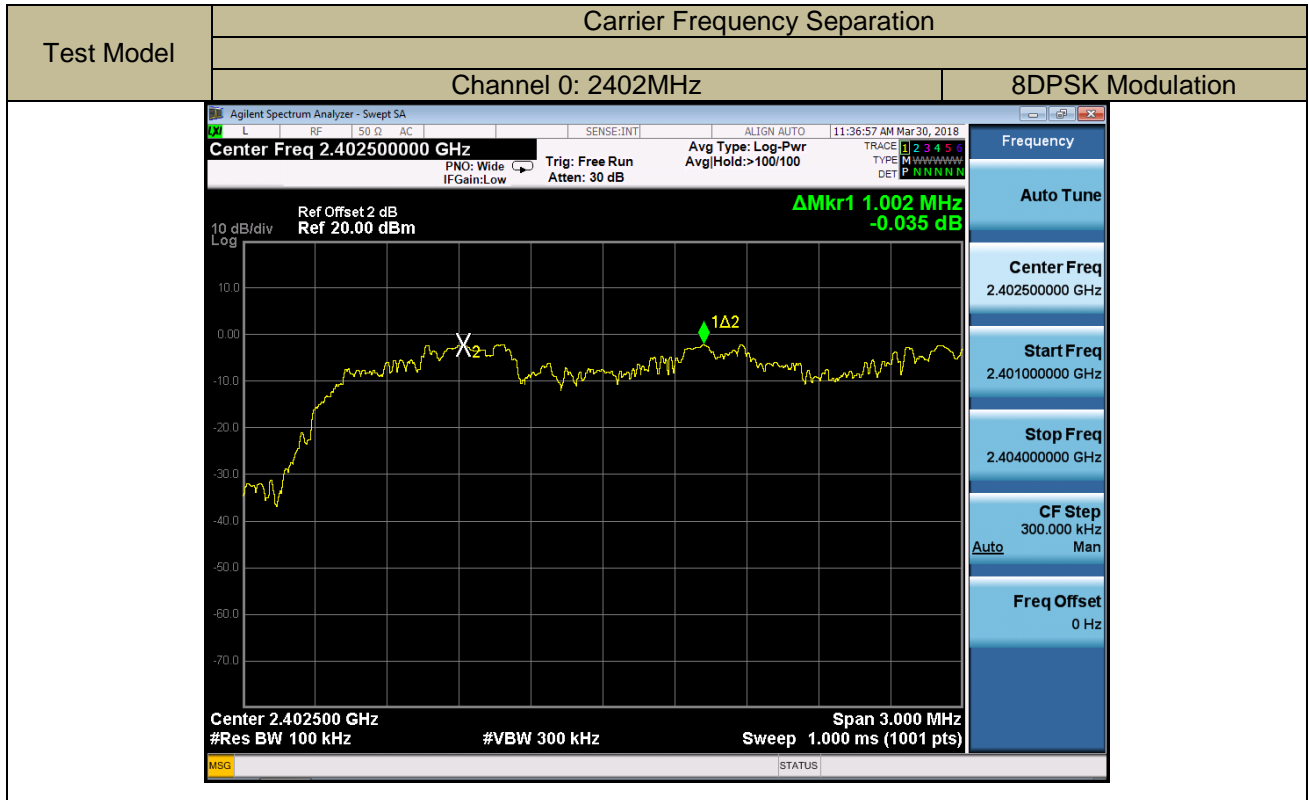

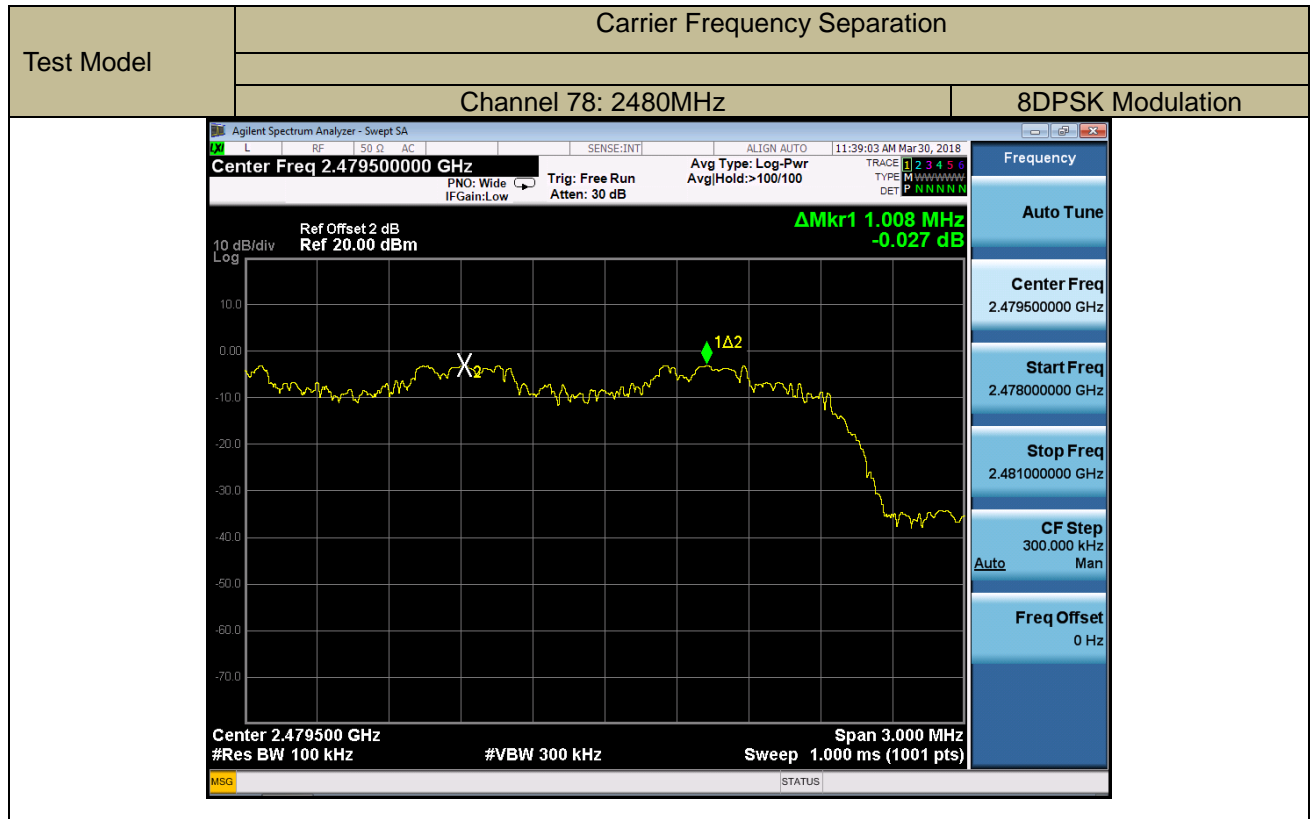

9.3 NUMBER OF HOPPING FREQUENCIES

9.3.1 Applicable Standard

According to FCC Part 15.247(a)(1) (iii) and DA 00-705

9.3.2 Conformance Limit

Frequency hopping systems operating in the 2400-2483.5MHz band shall use at least 15 channels.

9.3.3 Test Configuration

Test according to clause 7.1 radio frequency test setup 1

9.3.4 Test Procedure

- According to FCC Part 15.247(a)(1)(iii)

The EUT must have its hopping function enabled. Use the following spectrum analyzer settings:

Span = the frequency band of operation

RBW = 100kHz

VBW ≥ RBW

Sweep = auto

Detector function = peak

Trace = max hold

Allow the trace to stabilize. It may prove necessary to break the span up to sections, in order to clearly show all of the hopping frequencies.

Test Results

Temperature: 24°C
Humidity: 53 %

Test Date: March 29, 2018
Test By: KK

Hopping Channel Frequency Range	Quantity of Hopping Channel	Quantity of Hopping Channel limit
2402-2480 (GFSK)	79	> 15
Note: Both EDR & EDR mode has been evaluated, and the worst result recorded was report.		

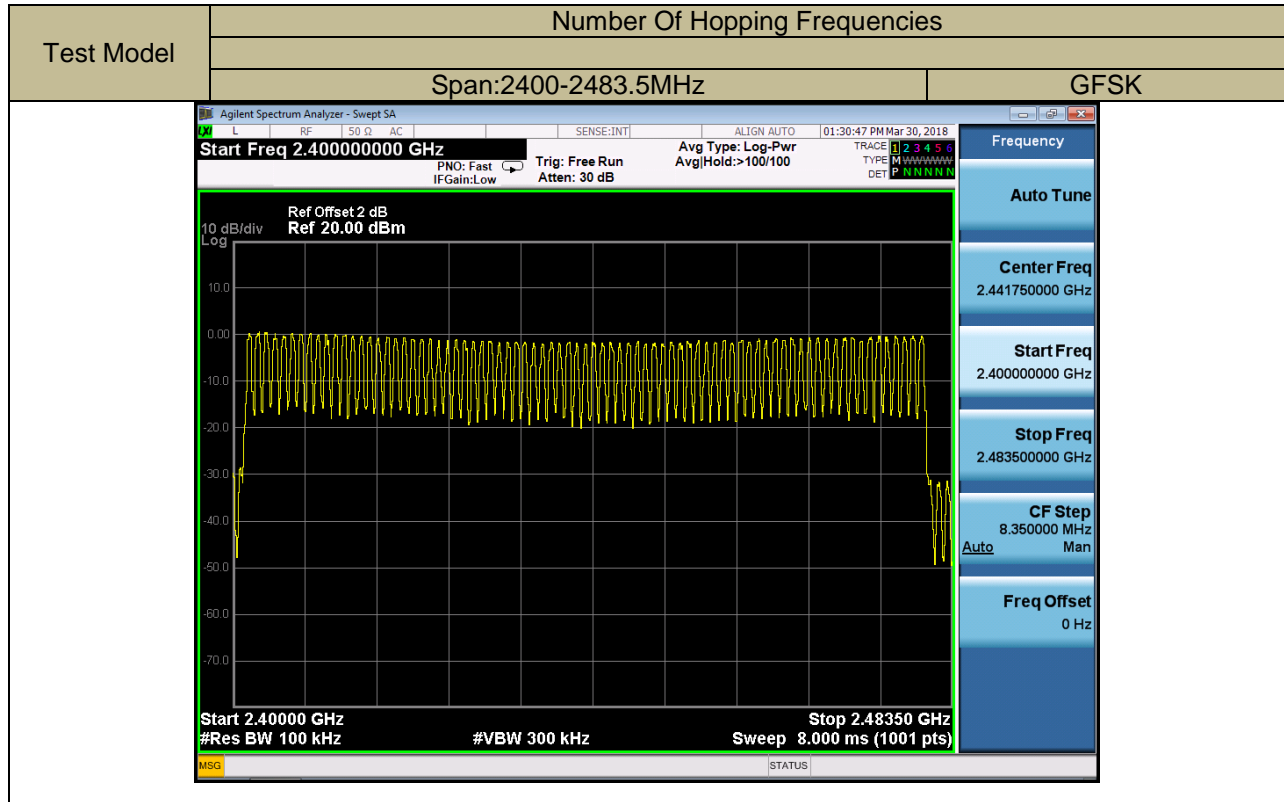

9.4 AVERAGE TIME OF OCCUPANCY (DWEELL TIME)

9.4.1 Applicable Standard

According to FCC Part 15.247(a)(1)(iii) and DA 00-705

9.4.2 Conformance Limit

For frequency hopping systems operating in the 2400-2483.5MHz band, the averagetime of occupancy on any channel shall not be greater than 0.4s within a period of 0.4smultiplied by the number of hopping channels employed.

9.4.3 Test Configuration

Test according to clause 7.1 radio frequency test setup 1

9.4.4 Test Procedure

- According to FCC Part15.247(a)(1)(iii)

The EUT must have its hopping function enabled. Use the following spectrum analyzersettings:

Span = zero span, centered on a hopping channel

RBW = 1 MHz

VBW ≥ RBW

Sweep = as necessary to capture the entire dwell time per hopping channel

Detector function = peak

Trace = max hold

If possible, use the marker-delta function to determine the dwell time. If this value varies with different modes of operation (e.g., data rate, modulation format, etc.), repeat this test for each variation. The limit is specified in one of the subparagraphsof this Section.

9.4.5 Test Results

Temperature: 24°C

Test Date: March 29, 2018

Humidity: 53 %

Test By: KK

Modulation Mode	Channel Number	Packet type	Pluse width (ms)	DwellTime (ms)	Limit (ms)	Verdict
GFSK	0	DH1	0.500	160.00	<400	PASS
	0	DH3	1.764	282.24	<400	PASS
	0	DH5	3.020	322.13	<400	PASS
Note1: $DwellTime(DH1)=PW*(1600/2/79)*31.6$ $DwellTime(DH3)=PW*(1600/4/79)*31.6$ $DwellTime(DH5)=PW*(1600/6/79)*31.6$ Note2: Bluetooth (GFSK, pi/4-DQPSK, 8DPSK) mode have been tested, and the worst results has been recorded on the follow page.						

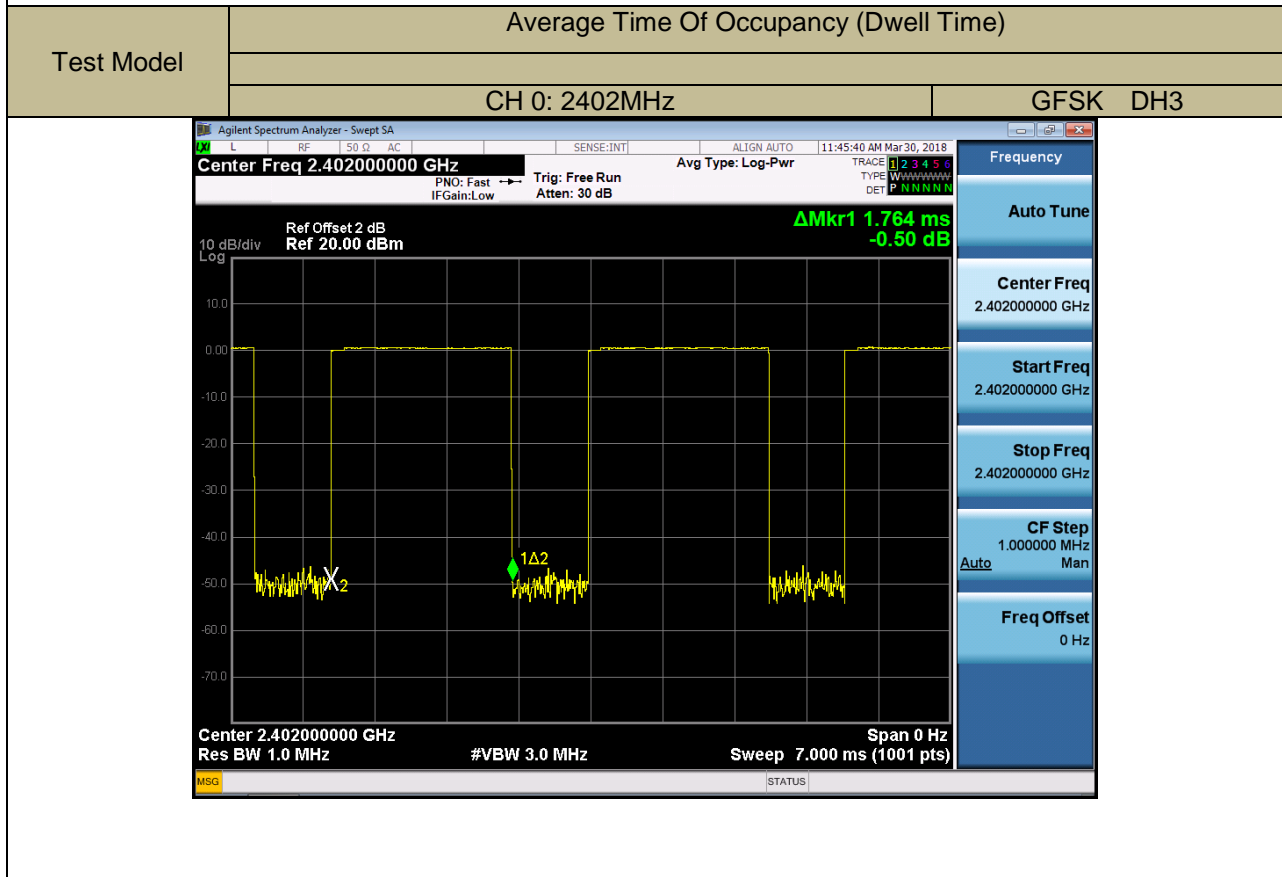
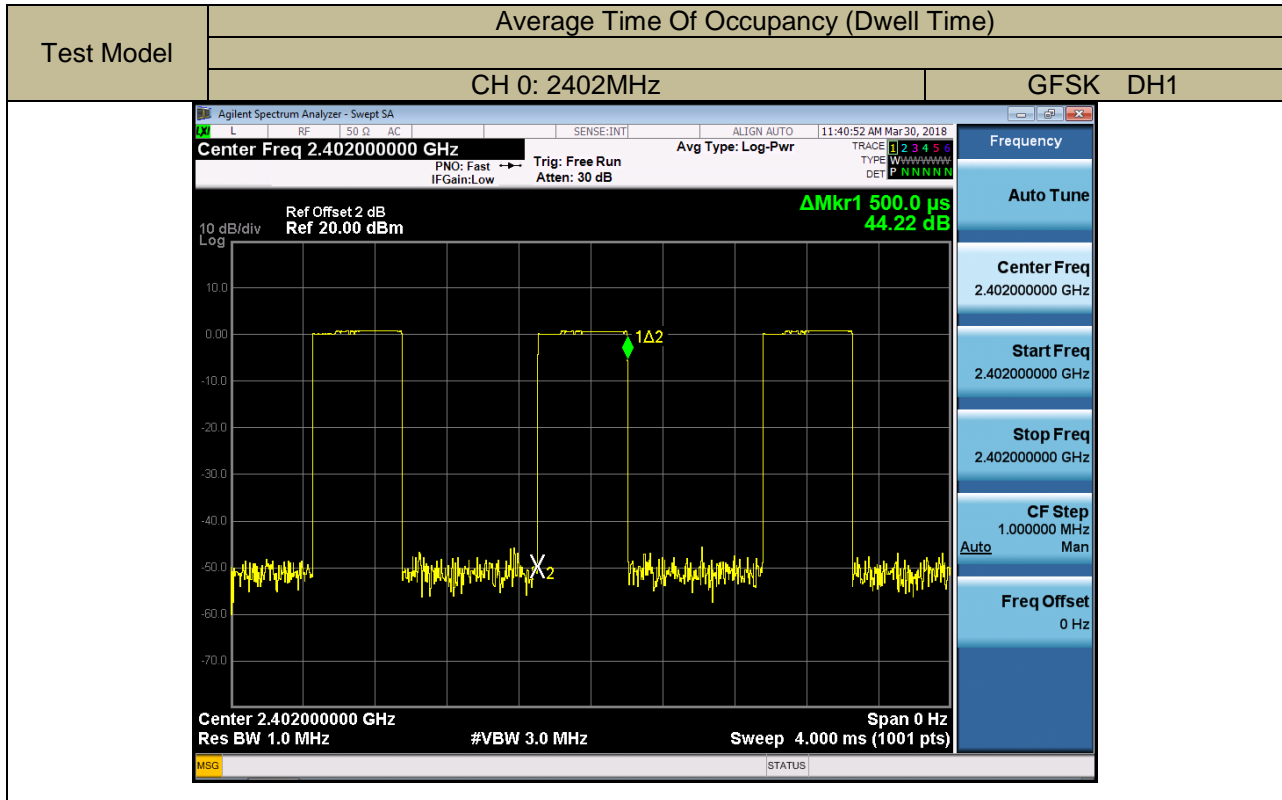

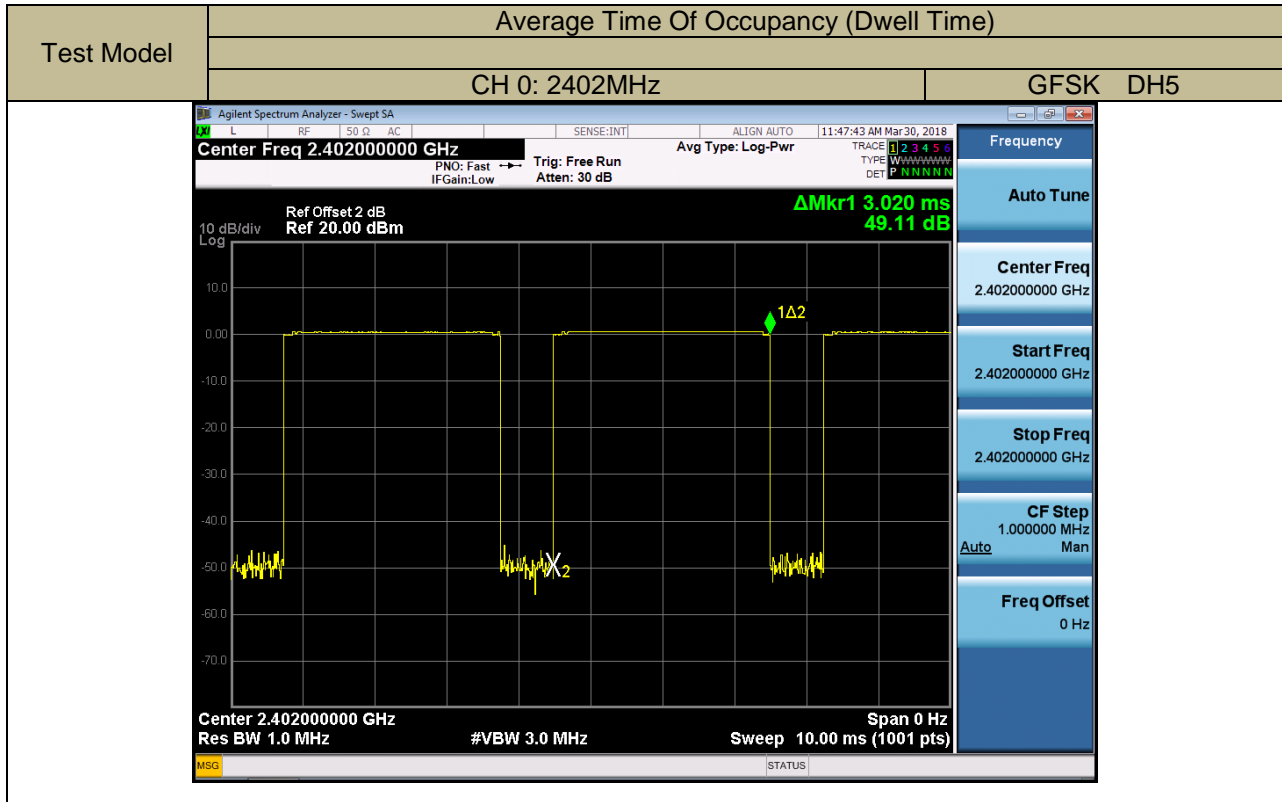

9.5 MAXIMUM PEAK CONDUCTED OUTPUT POWER

9.5.1 Applicable Standard

According to FCC Part 15.247(b)(1) and DA 00-705

9.5.2 Conformance Limit

The max For frequency hopping systems operating in the 2400-2483.5 MHz band employing at least 75 non-overlapping hopping channels: 1 watt. For all other frequency hopping systems in the 2400-2483.5 MHz band: 0.125 watts.

9.5.3 Test Configuration

Test according to clause 7.1 radio frequency test setup 1

9.5.4 Test Procedure

■ According to FCC Part15.247(b)(1)

As an alternative to a peak power measurement, compliance with the limit can be based on a measurement of the maximum conducted output power.

Use the following spectrum analyzer settings:

Set Span = approximately 5 times the 20 dB bandwidth, centered on a hopping channel(about 10MHz)

Set RBW > the 20 dB bandwidth of the emission being measured(about 3MHz)

Set VBW ≥ RBW

Set Sweep = auto

Set Detector function = peak

Set Trace = max hold

Allow the trace to stabilize. Use the marker-to-peak function to set the marker to the peak of the emission to determine the peak amplitude level.

Test Results

Temperature: 24°C
Humidity: 53 %

Test Date: March 29, 2018
Test By: KK

Operation Mode	Channel Number	Channel Frequency (MHz)	Measurement Level (dBm)	Limit (dBm)	Verdict
GFSK	0	2402	0.922	21	PASS
	39	2441	-1.267	21	PASS
	78	2480	0.180	21	PASS
pi/4-DQPSK	0	2402	-0.277	21	PASS
	39	2441	-2.508	21	PASS
	78	2480	-1.073	21	PASS
8DPSK	0	2402	-0.165	21	PASS
	39	2441	-2.420	21	PASS
	78	2480	-0.986	21	PASS
Note:N/A					

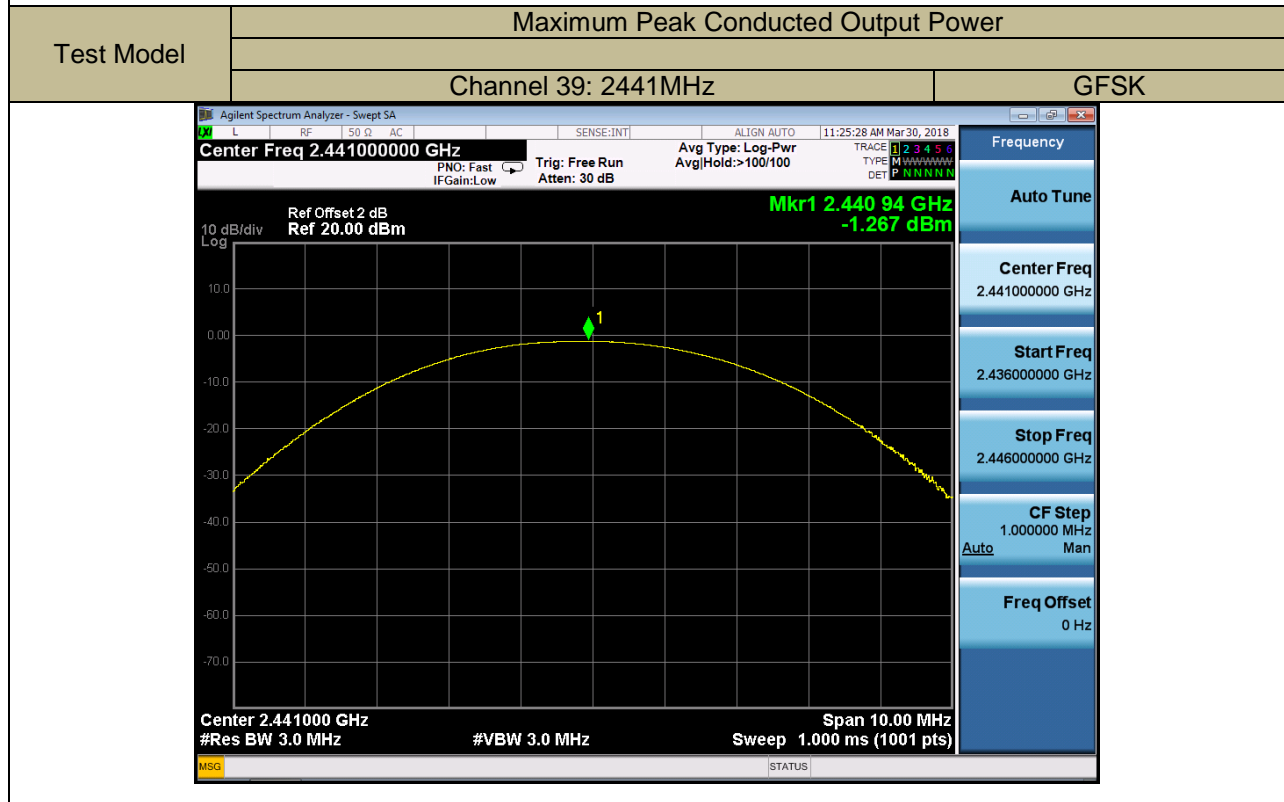
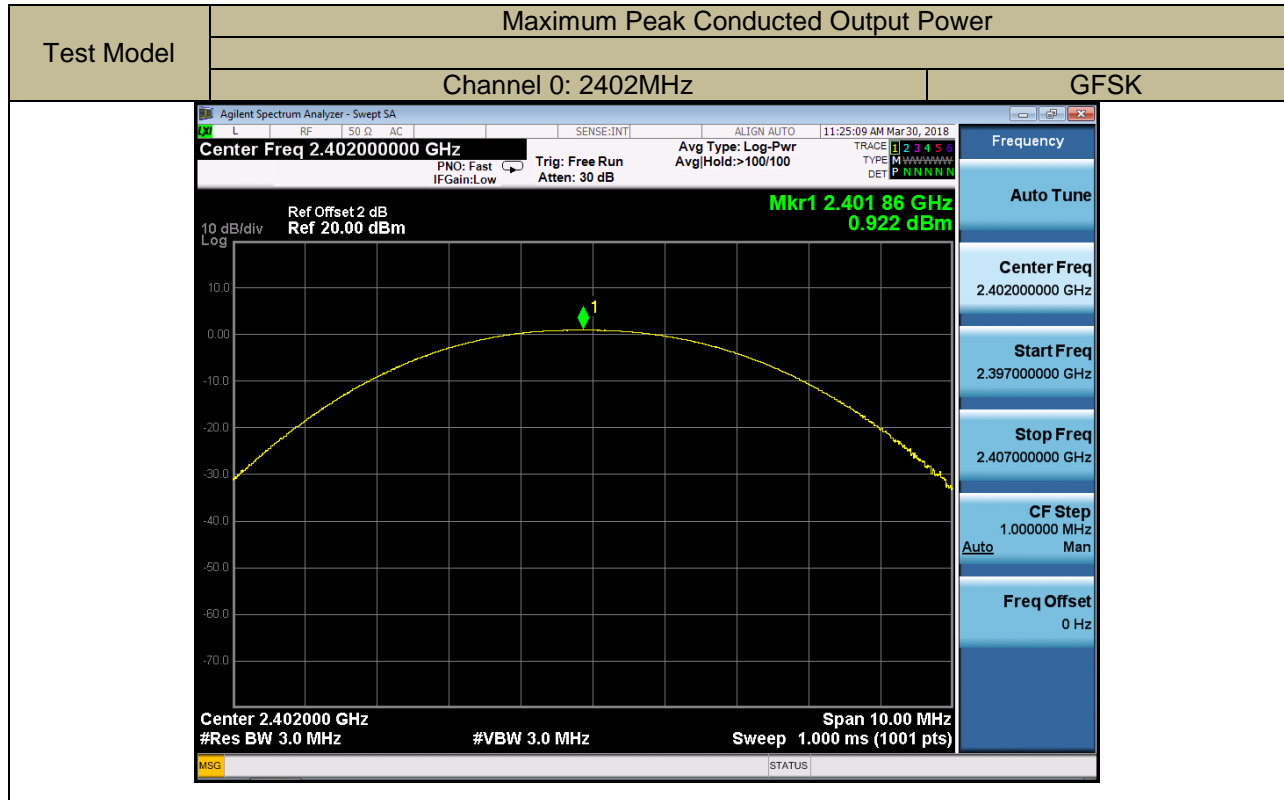

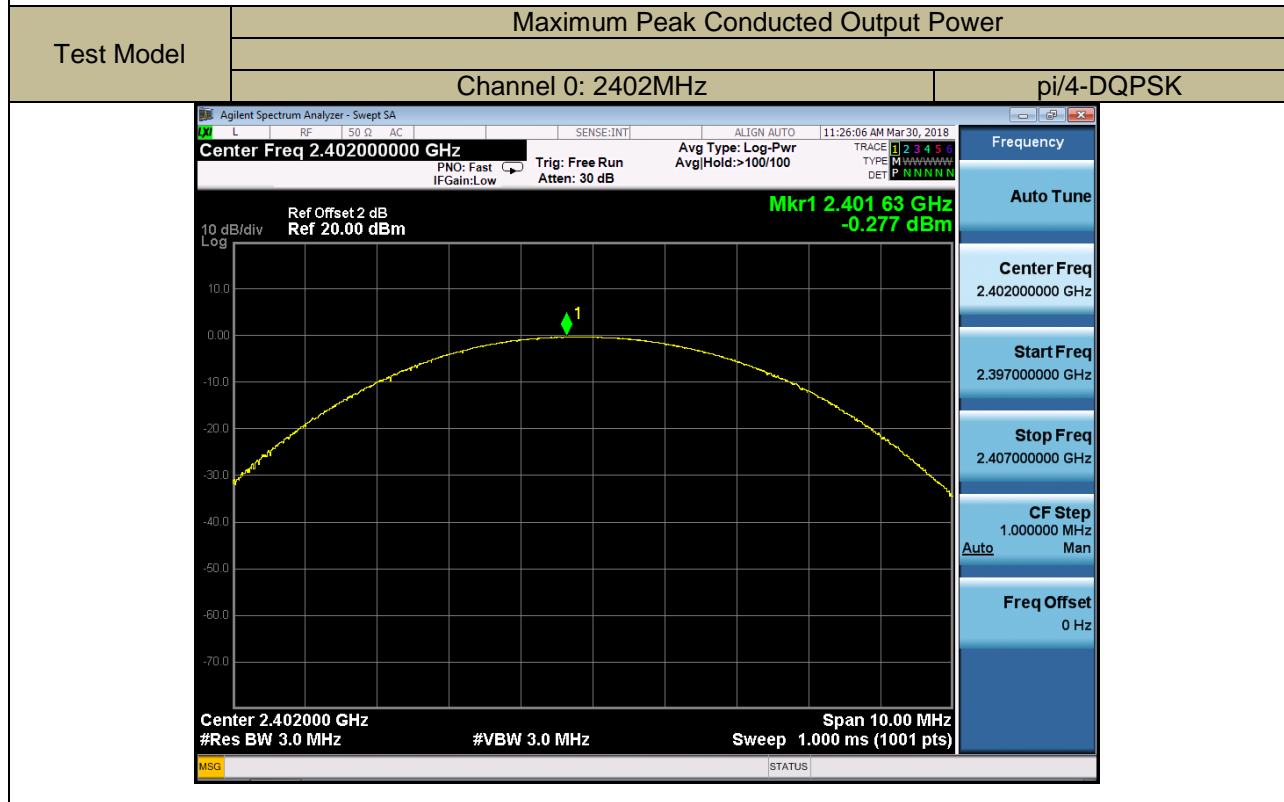
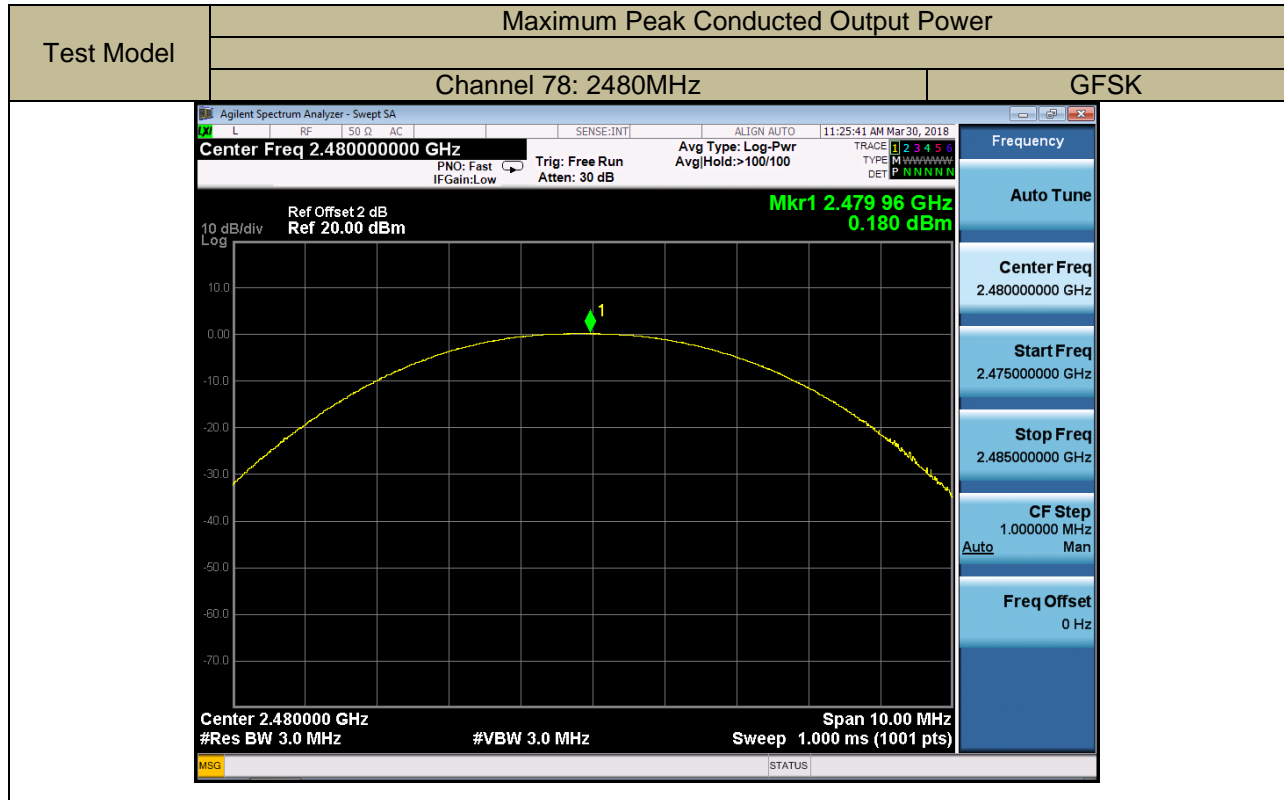

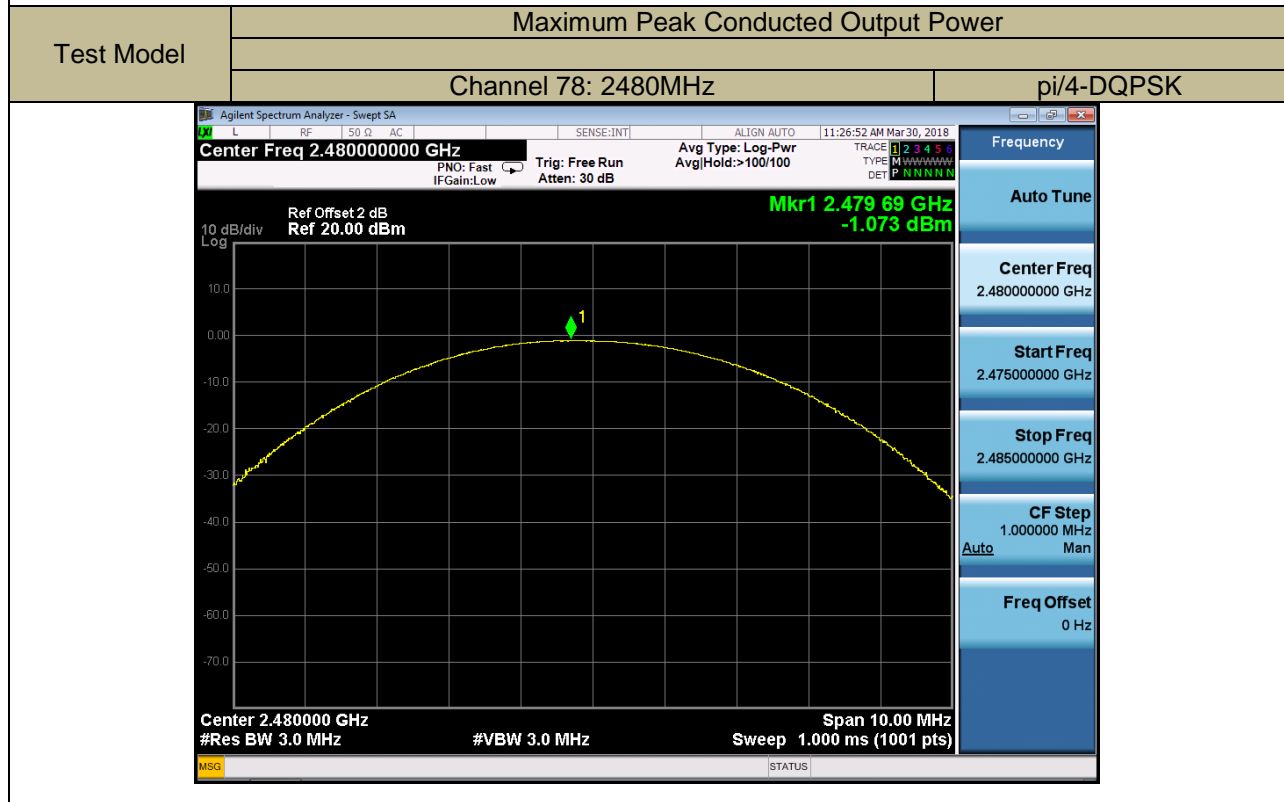
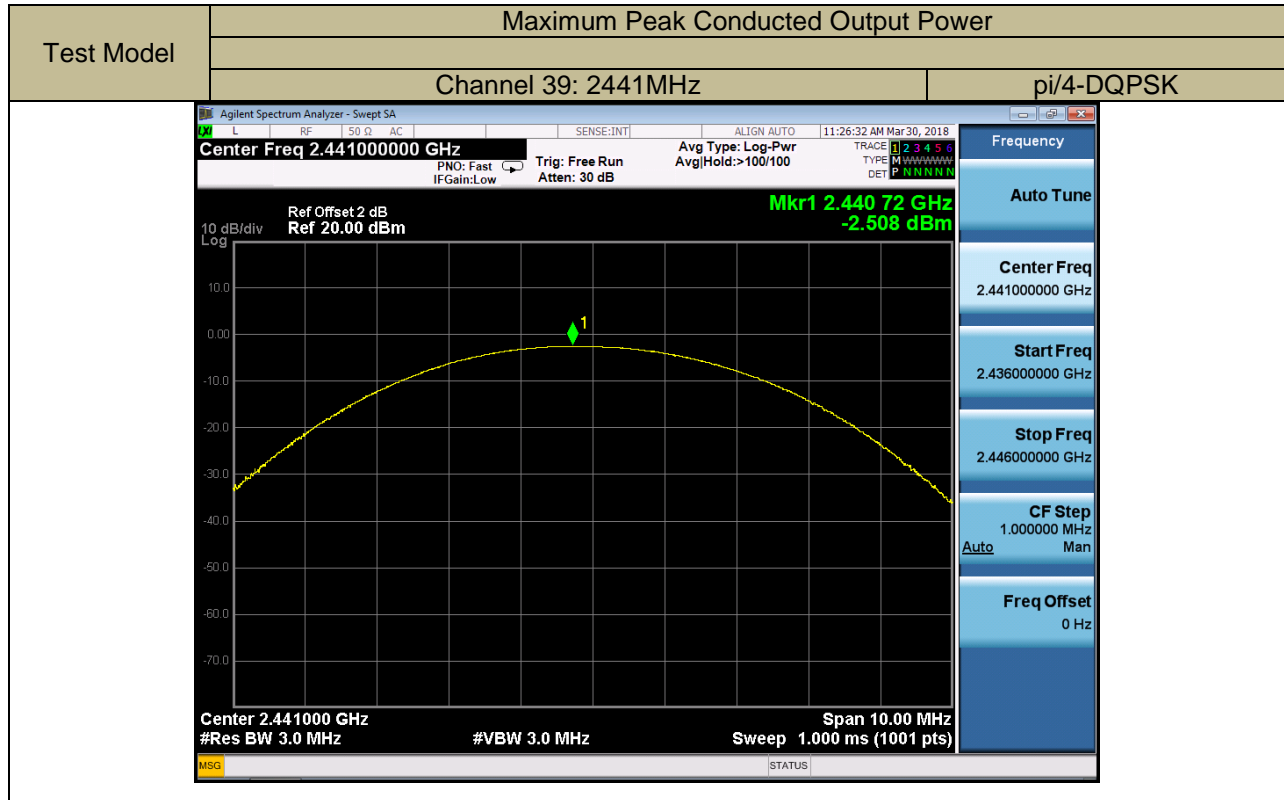

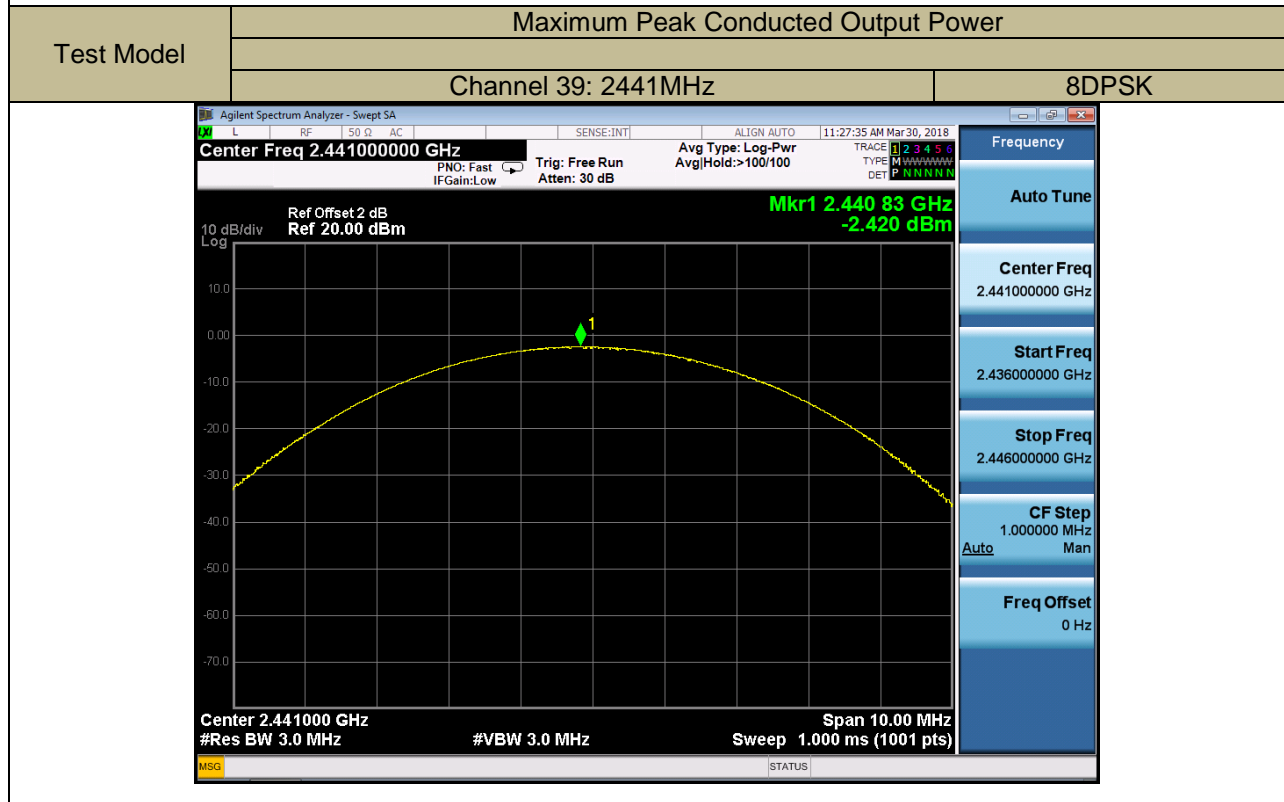
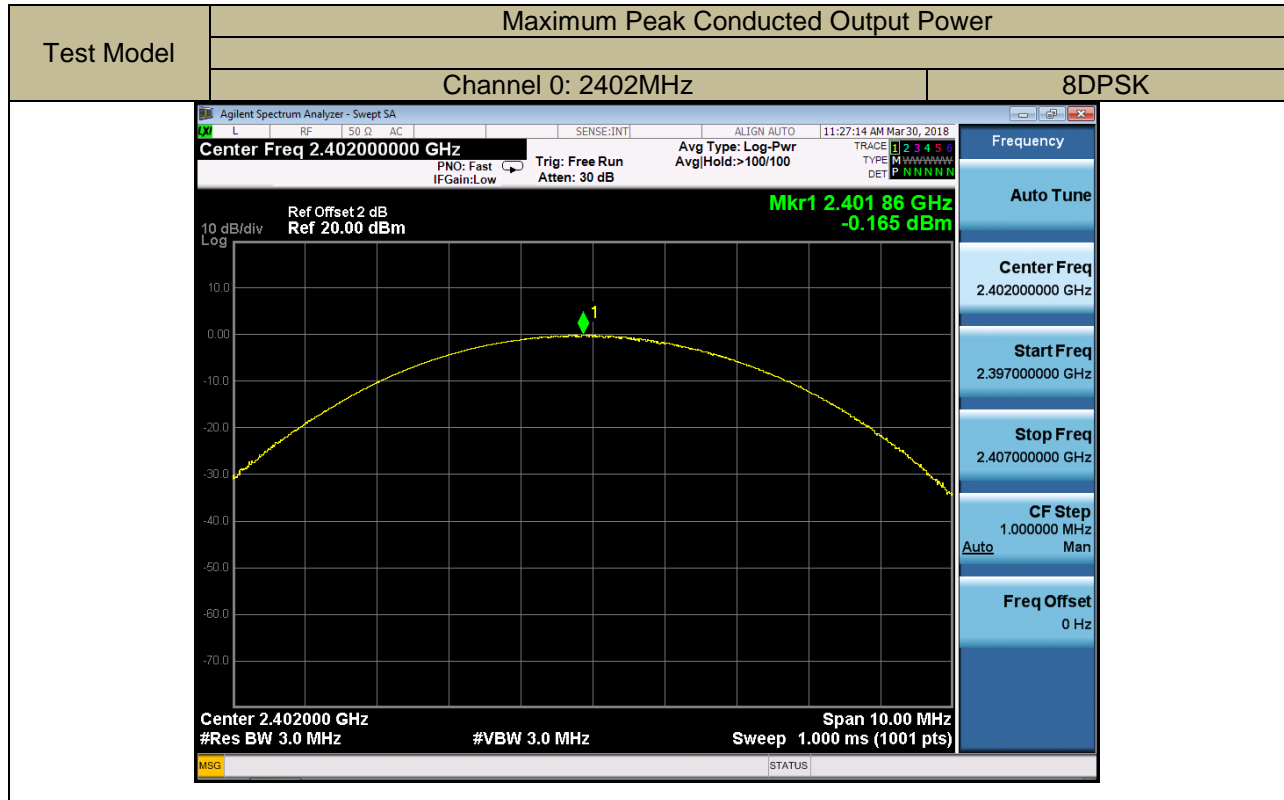

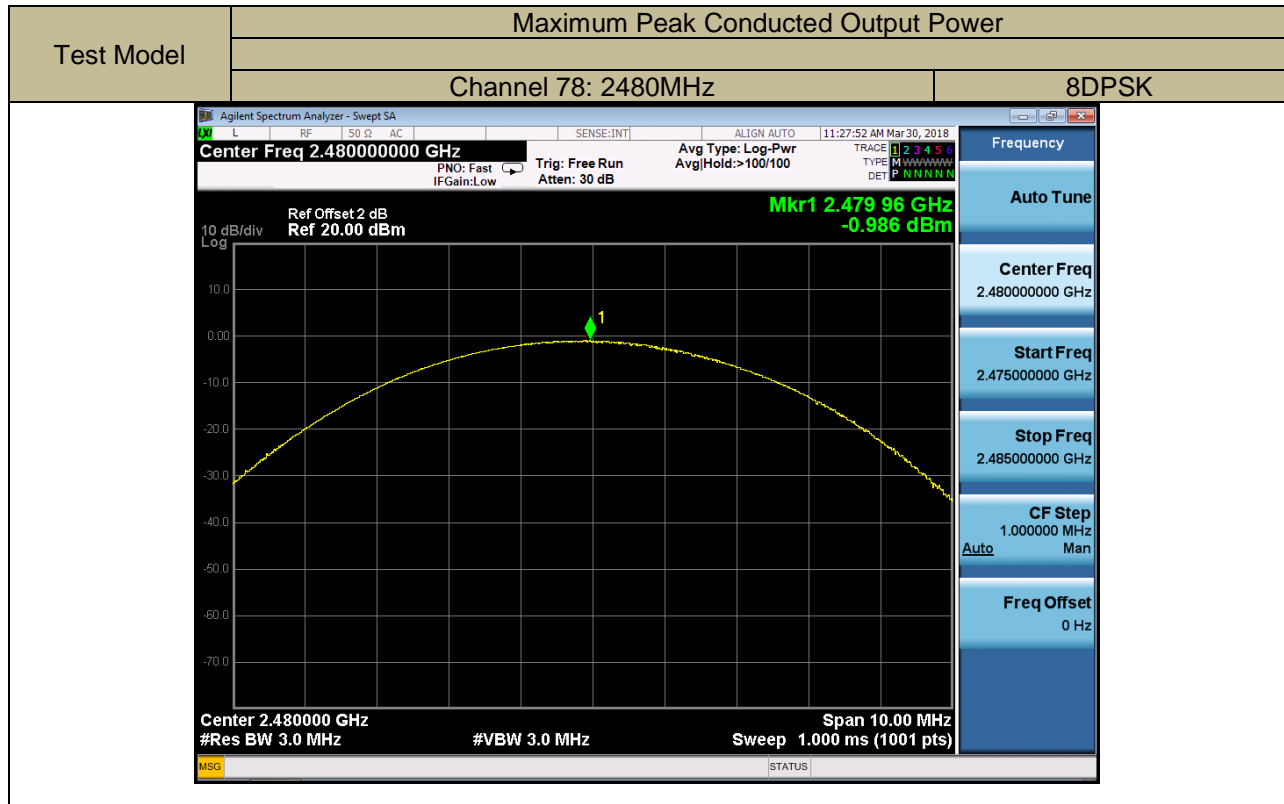

9.6 CONDUCTED SUPRIIOUS EMISSION

9.6.1 Applicable Standard

According to FCC Part 15.247(d) and DA 00-705

9.6.2 Conformance Limit

According to FCC Part 15.247(d):

In any 100 kHz bandwidth outside the frequency band in which the spread spectrum intentional radiator is operating, the radio frequency power that is produced by the intentional radiator shall be at least 20 dB below that in the 100 kHz bandwidth within the band that contains the highest level of the desired power, based on either an RF conducted, provided the transmitter demonstrates compliance with the peak conducted power limits.

9.6.3 Test Configuration

Test according to clause 7.1 radio frequency test setup 1

9.6.4 Test Procedure

The transmitter output (antenna port) was connected to the spectrum analyzer

■ Reference level measurement

Establish a reference level by using the following procedure:

Set instrument center frequency to DSS channel center frequency.

Set Span = approximately 5 times the 20 dB bandwidth, centered on a hopping channel.

Set the RBW = 100 kHz. Set the VBW $\geq 3 \times$ RBW.

Set Detector = peak. Set Sweep time = auto couple.

Set Trace mode = max hold. Allow trace to fully stabilize.

Use the peak marker function to determine the maximum Maximumconducedlevel.

Note that the channel found to contain the maximum conduced level can be used to establish the reference level.

■ Band-edge Compliance of RF Conducted Emissions

Use the following spectrum analyzer settings:

Span = wide enough to capture the peak level of the emission operating on the channel closest to the band-edge, as well as any modulation products which fall outside of the authorized band of operation

Set RBW $\geq 1\%$ of the span=100kHzSet VBW \geq RBW

Set Sweep = autoSetDetector function = peakSetTrace = max hold

Allow the trace to stabilize. Set the marker on the emission at the bandedge, or on the highest modulation product outside of the band, if this level is greater than that at the bandedge. Enable the marker-delta function, then use the marker-to-peak function to move the marker to the peak of the in-band emission.

The marker-delta value now displayed must comply with the limit specified in this Section.

Now, using the same instrument settings, enable the hopping function of the EUT. Allow the trace to stabilize. Follow the same procedure listed above to determine if any spurious emissions caused by the hopping function also comply with the specified limit.

■ Conduced Spurious RF Conducted Emission

Use the following spectrum analyzer settings:

Span = wide enough to capture the peak level of the in-band emission and all spurious emissions (e.g., harmonics) from the lowest frequency generated in the EUT up through the 10th harmonic.(30MHz to 25GHz).Set RBW = 100 kHzSetVBW \geq RBW

Set Sweep = autoSetDetector function = peakSetTrace = max hold

Allow the trace to stabilize. Set the marker on the peak of any spurious emission recorded. The level displayed must comply with the limit specified in this Section.

9.6.5 Test Results

Bluetooth (GFSK, pi/4-DQPSK, 8DPSK) mode have been tested, and the worst result(GFSK)was report as below:

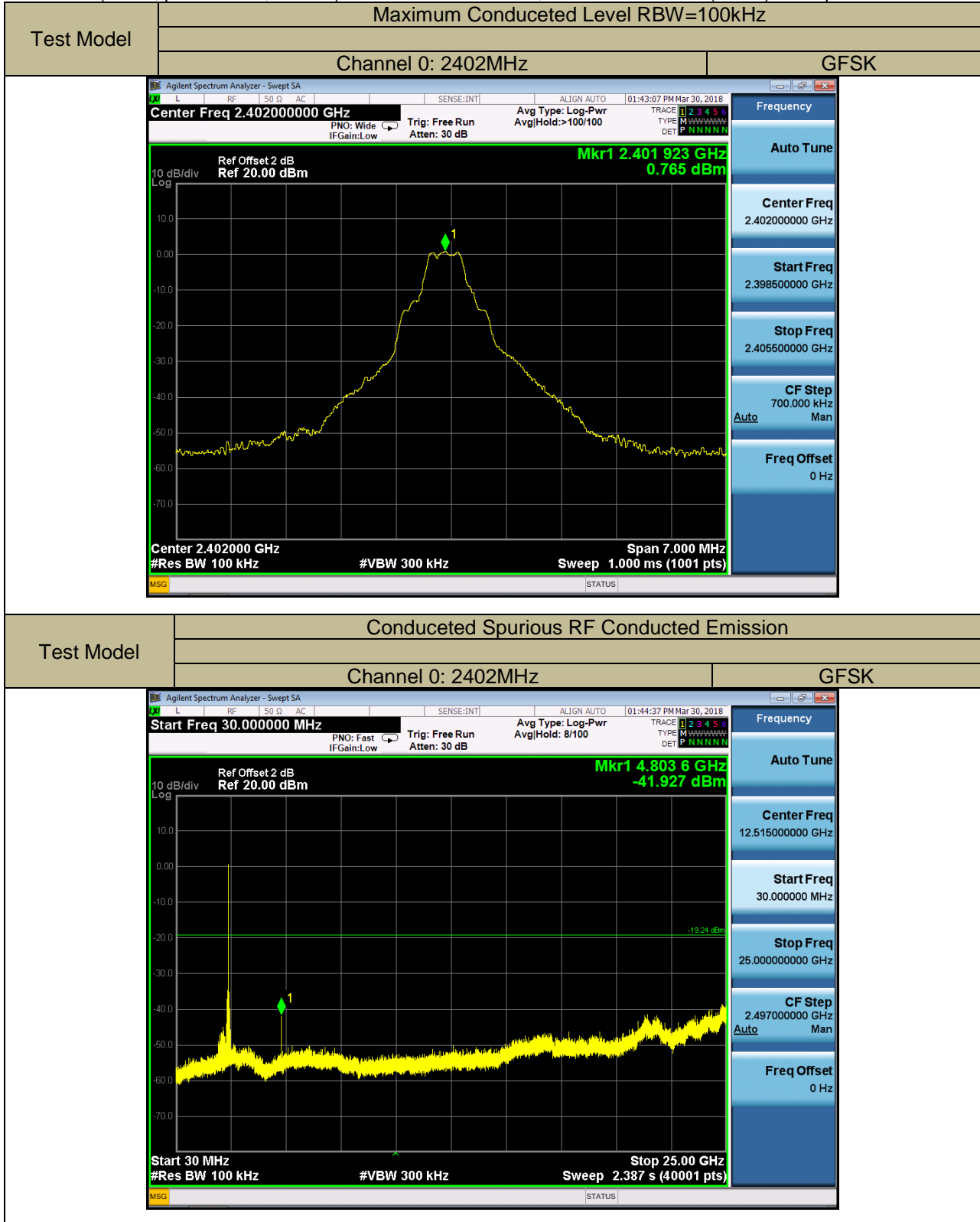

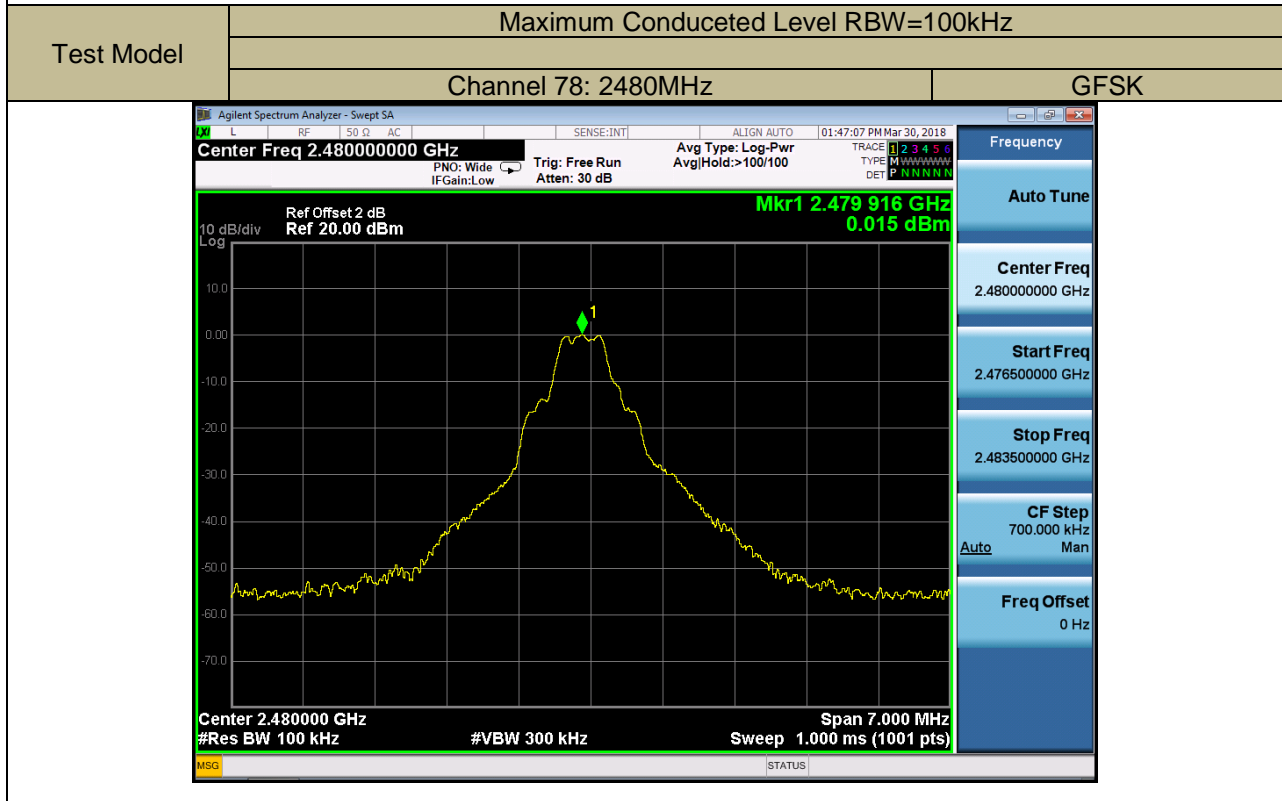
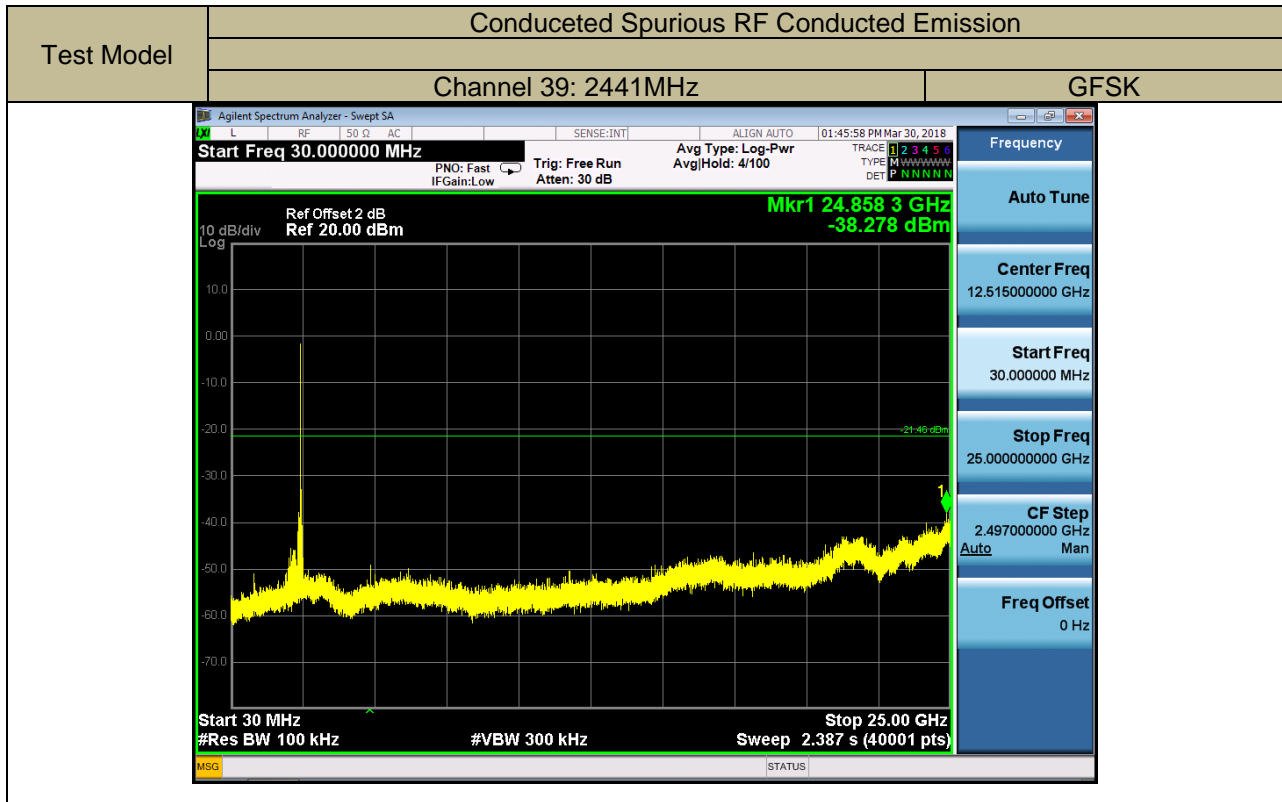

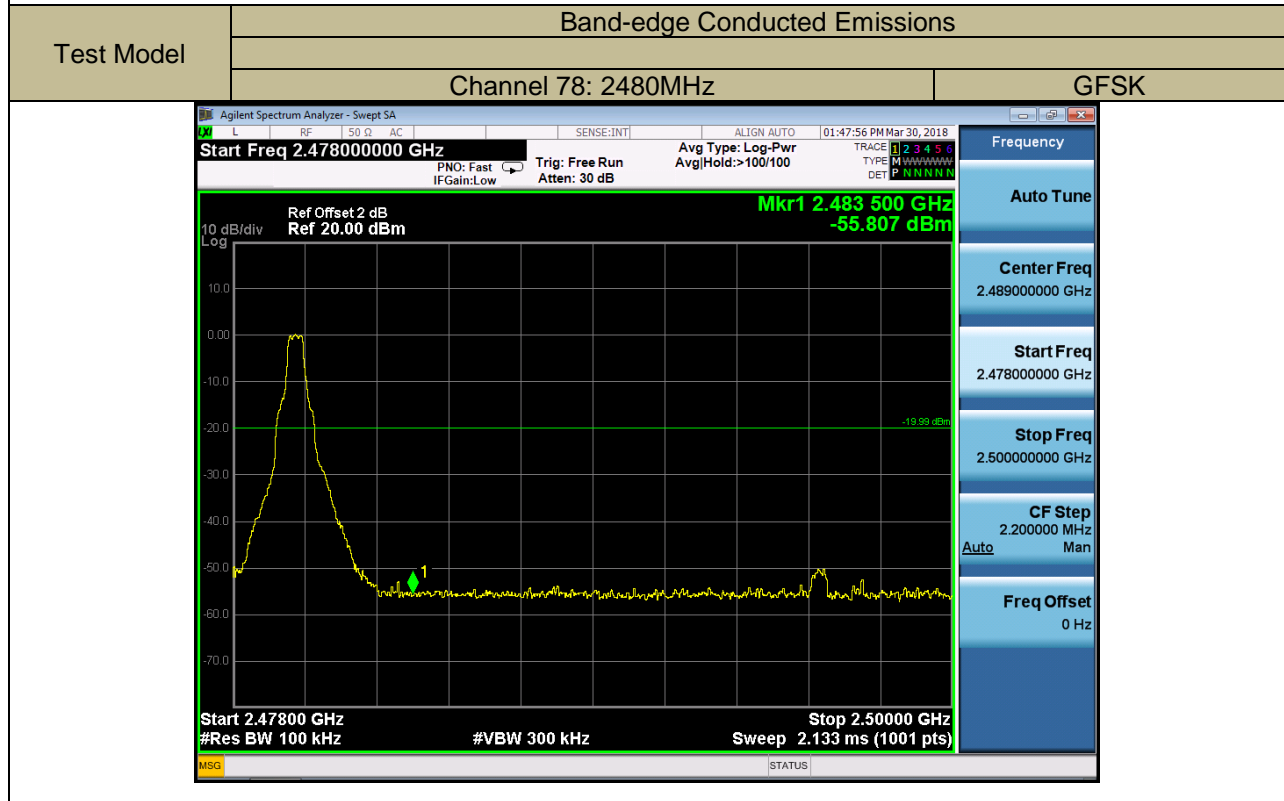
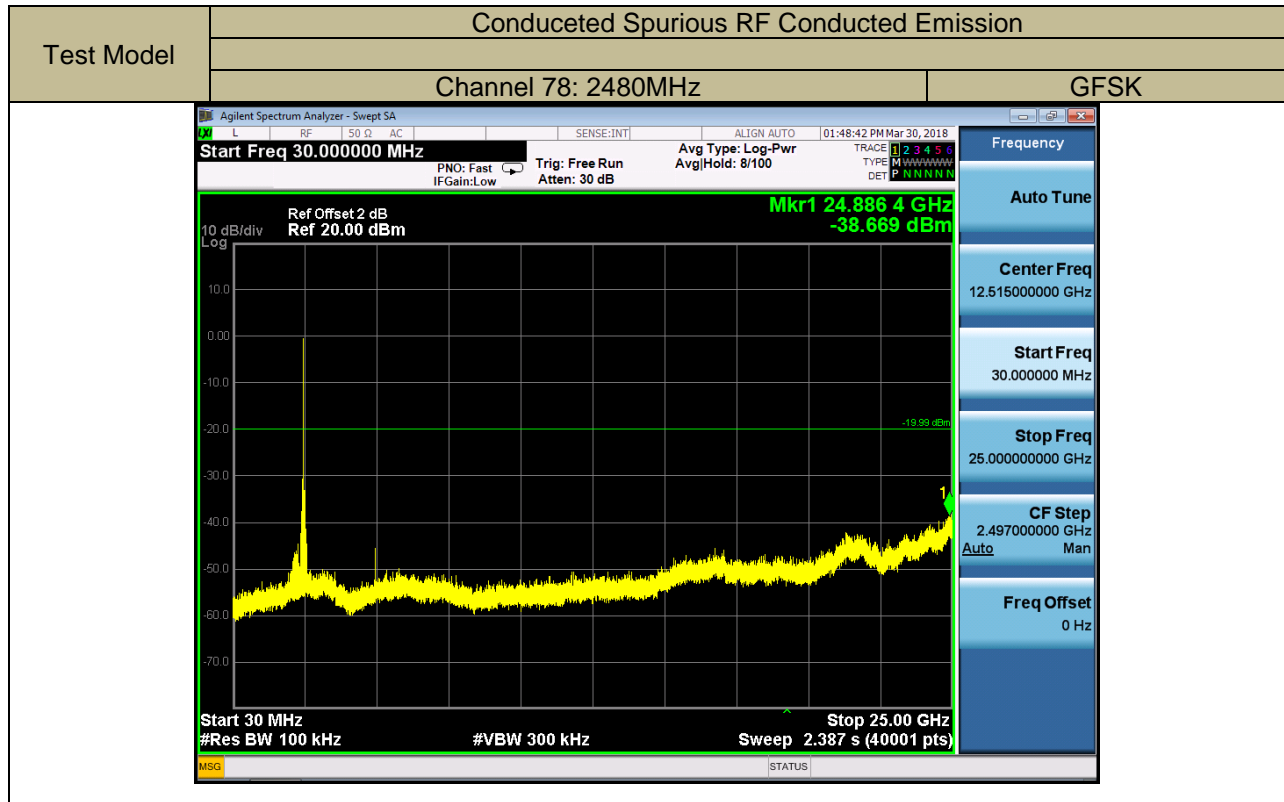

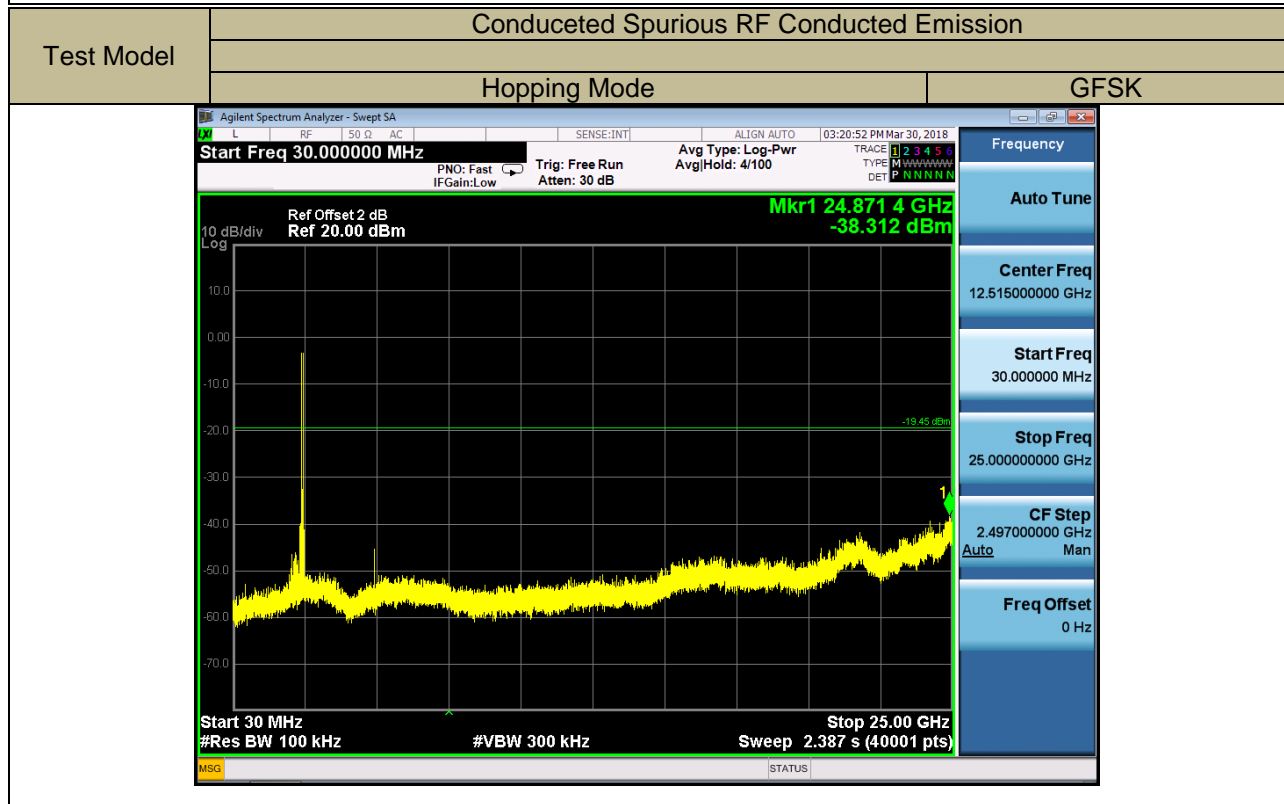
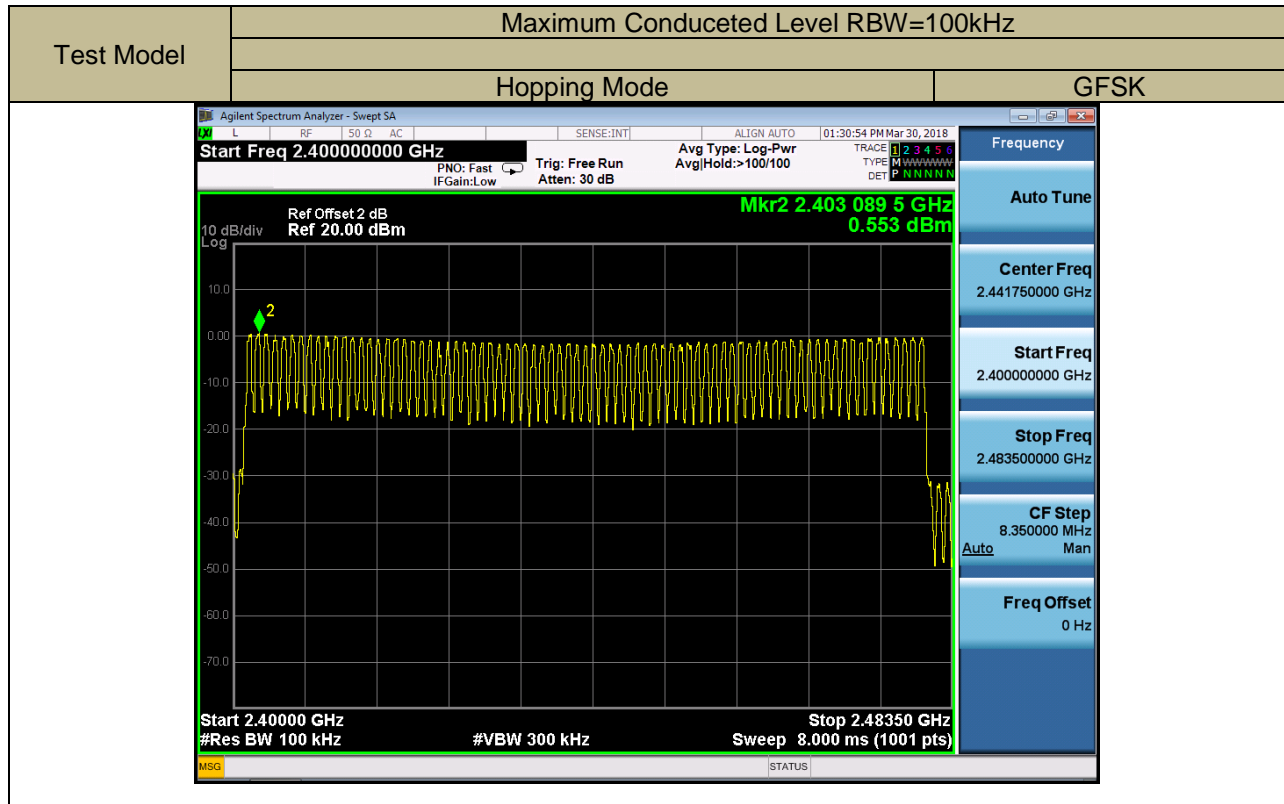

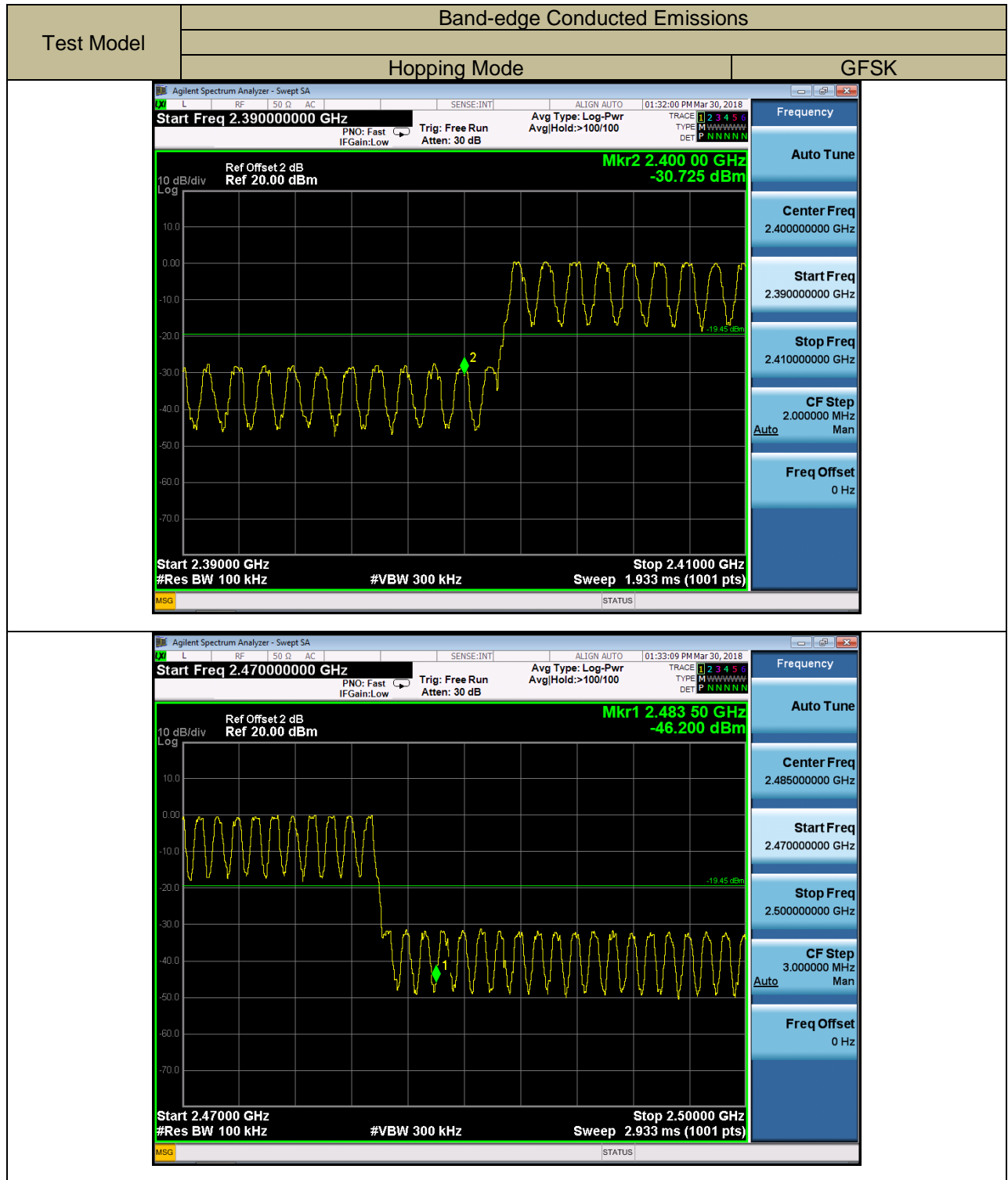

9.7 RADIATED SPURIOUS EMISSION

9.7.1 Applicable Standard

According to FCC Part 15.247(d) and 15.209 and DA 00-705

9.7.2 Conformance Limit

According to FCC Part 15.247(d): radiated emissions which fall in the restricted bands, as defined in §15.205(a), must also comply with the radiated emission limits specified in §15.209(a) (see §15.205(c)).
According to FCC Part 15.205, Restricted bands

MHz	MHz	MHz	GHz
0.090-0.110	16.42-16.423	399.9-410	4.5-5.15
10.495-0.505	16.69475-16.69525	608-614	5.35-5.46
2.1735-2.1905	16.80425-16.80475	960-1240	7.25-7.75
4.125-4.128	25.5-25.67	1300-1427	8.025-8.5
4.17725-4.17775	37.5-38.25	1435-1626.5	9.0-9.2
4.20725-4.20775	73-74.6	1645.5-1646.5	9.3-9.5
6.215-6.218	74.8-75.2	1660-1710	10.6-12.7
6.26775-6.26825	123-138	2200-2300	14.47-14.5
8.291-8.294	149.9-150.05	2310-2390	15.35-16.2
8.362-8.366	156.52475-156.52525	2483.5-2500	17.7-21.4
8.37625-8.38675	156.7-156.9	2690-2900	22.01-23.12
8.41425-8.41475	162.0125-167.17	3260-3267	23.6-24.0
12.29-12.293	167.72-173.2	3332-3339	31.2-31.8
12.51975-12.52025	240-285	3345.8-3358	36.43-36.5
12.57675-12.57725	322-335.4	3600-4400	(2)
13.36-13.41			

According to FCC Part 15.205, the level of any transmitter spurious emission in Restricted bands shall not exceed the level of the emission specified in the following table

Restricted Frequency(MHz)	Field Strength ($\mu\text{V/m}$)	Field Strength ($\text{dB}\mu\text{V/m}$)	Measurement Distance
0.009-0.490	2400/F(KHz)	20 log ($\mu\text{V/m}$)	300
0.490-1.705	2400/F(KHz)	20 log ($\mu\text{V/m}$)	30
1.705-30	30	29.5	30
30-88	100	40	3
88-216	150	43.5	3
216-960	200	46	3
Above 960	500	54	3

9.7.3 Test Configuration

Test according to clause 7.2 radio frequency test setup 2

9.7.4 Test Procedure

This test is required for any spurious emission that falls in a Restricted Band, as defined in Section 15.205. It must be performed with the highest gain of each type of antenna proposed for use with the EUT. Use the following spectrum analyzer settings:

The EUT was placed on a turn table which is 0.8m above ground plane.

Maximum procedure was performed on the highest emissions to ensure EUT compliance.

Span = wide enough to fully capture the emission being measured

RBW = 1 MHz for $f \geq 1$ GHz (1GHz to 25GHz), 100 kHz for $f < 1$ GHz (30MHz to 1GHz)

VBW \geq RBW

Sweep = auto

Detector function = peak

Trace = max hold

Follow the guidelines in ANSI C63.10-2013 respect to maximizing the emission by rotating the EUT, measuring the emission while the EUT is situated in three orthogonal planes (if appropriate), adjusting the measurement antenna height and polarization, etc. A pre-amp and a high pass filter are required for this test, in order to provide the measuring system with sufficient sensitivity. Allow the trace to stabilize. The peak reading of the emission, after being corrected by the antenna factor, cable loss, pre-amp gain, etc., is the peak field strength, which must comply with the limit specified in Section 15.35(b). Submit this data. Now set the VBW to 10 Hz, while maintaining all of the other instrument settings. This peak level, once corrected, must comply with the limit specified in Section 15.209. If the dwell time per channel of the hopping signal is less than 100 ms, then the reading obtained with the 10 Hz VBW may be further adjusted by a “duty cycle correction factor”, derived from $20\log(\text{dwell time}/100 \text{ ms})$, in an effort to demonstrate compliance with the 15.209 limit. Submit this data.

Repeat above procedures until all frequency measured was complete.

9.7.5 Test Results

■ Spurious Emission below 30MHz(9KHz to 30MHz)

Temperature:	24°C	Test Date:	March 29, 2018
Humidity:	53 %	Test By:	KK
Test mode:	TX Mode		

Freq. (MHz)	Ant. Pol. H/V	Emission Level(dBuV/m)		Limit 3m(dBuV/m)		Over(dB)	
		PK	AV	PK	AV	PK	AV
--	--	--	--	--	--	--	--

Note: the amplitude of spurious emission that is attenuated by more than 20dB below the permissible limit has no need to be reported.

Distance extrapolation factor = $40\log(\text{Specific distance}/ \text{test distance})(\text{dB})$;

Limit line=Specific limits(dBuV) + distance extrapolation factor

■ Spurious Emission Above 1GHz(1GHz to 25GHz)

Bluetooth (GFSK, pi/4-DQPSK, 8DPSK, Hopping) mode have been tested, and the worst result(GFSK)was report as below:

Temperature:	24°C	Test Date:	March 29, 2018
Humidity:	53 %	Test By:	KK
Test mode:	GFSK	Frequency:	Channel 0: 2402MHz

Freq. (MHz)	Ant. Pol. H/V	Emission Level(dBuV/m)		Limit 3m(dBuV/m)		Over(dB)	
		PK	AV	PK	AV	PK	AV
5089	V	57.10	43.73	74	54	-16.90	-10.27
7491	V	51.89	39.33	74	54	-22.11	-14.67
9893	V	51.58	36.24	74	54	-22.42	-17.76
5089	H	57.00	43.57	74	54	-17.00	-10.43
7491	H	54.95	40.58	74	54	-19.05	-13.42
9893	H	50.94	36.24	74	54	-23.06	-17.76

Temperature: 24°C
 Humidity: 53 %
 Test mode: GFSK

Test Date: March 29, 2018
 Test By: KK
 Frequency: Channel 39: 2441MHz

Freq. (MHz)	Ant.Pol. H/V	Emission Level(dBuV/m)		Limit 3m(dBuV/m)		Over(dB)	
		PK	AV	PK	AV	PK	AV
5076	V	59.71	45.15	74	54	-14.29	-8.85
7517	V	51.86	42.19	74	54	-22.14	-11.81
9958	V	49.6	36.76	74	54	-24.40	-17.24
5076	H	56.63	44.82	74	54	-17.37	-9.18
7517	H	54.06	40.02	74	54	-19.94	-13.98
9958	H	48.33	39.08	74	54	-25.67	-14.92

Temperature: 24°C
 Humidity: 53 %
 Test mode: GFSK

Test Date: March 29, 2018
 Test By: KK
 Frequency: Channel 78: 2480MHz

Freq. (MHz)	Ant.Pol. H/V	Emission Level(dBuV/m)		Limit 3m(dBuV/m)		Over(dB)	
		PK	AV	PK	AV	PK	AV
5123	V	59.98	44.22	74	54	-14.02	-9.78
7564	V	54.68	41.62	74	54	-19.32	-12.38
10005	V	49.57	36.00	74	54	-24.43	-18.00
5123	H	60.09	42.90	74	54	-13.91	-11.10
7564	H	51.21	40.01	74	54	-22.79	-13.99
10005	H	49.14	36.15	74	54	-24.86	-17.85

- Note:**
- (1) All Readings are Peak Value (VBW=3MHz) and Average Value (VBW=10Hz).
 - (2) Emission Level= Reading Level+Probe Factor +Cable Loss.
 - (3) Data of measurement within this frequency range shown “ -- ” in the table above means the reading of emissions are attenuated more than 20dB below the permissible limits or the field strength is too small to be measured.

Test Model	Spurious Emission in Restricted Band 2310-2390MHz		
	Channel 0: 2402MHz	GFSK	H

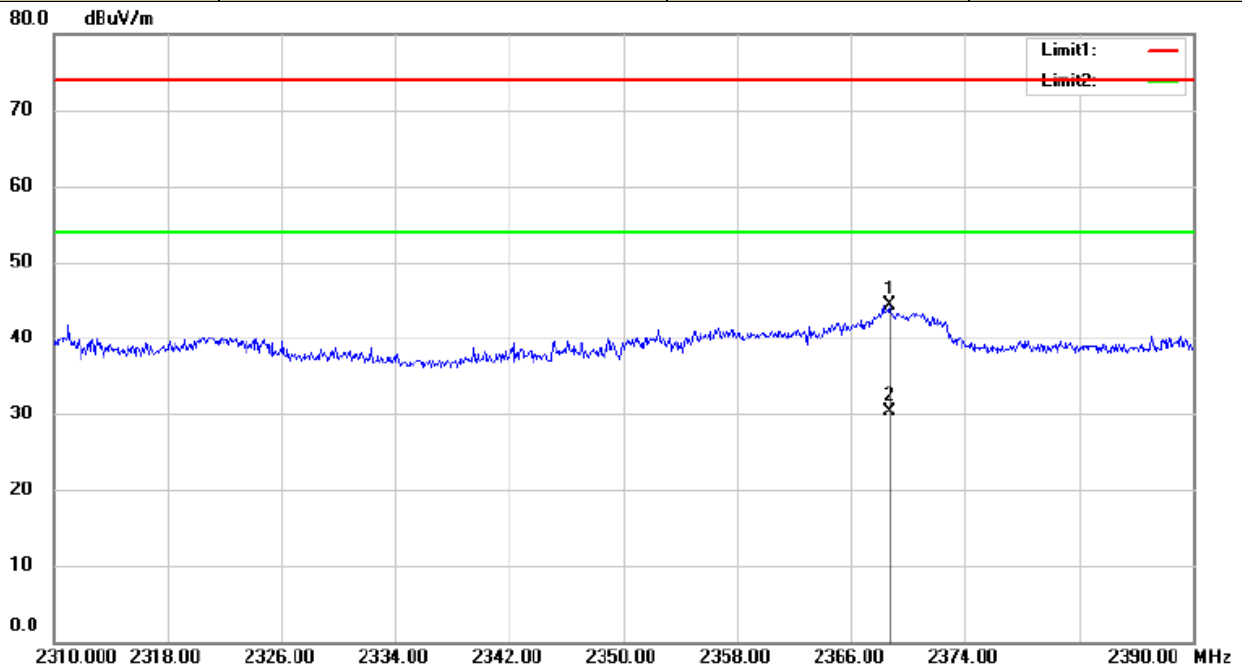

Test Model	Spurious Emission in Restricted Band 2310-2390MHz		
	Channel 0: 2402MHz	GFSK	V

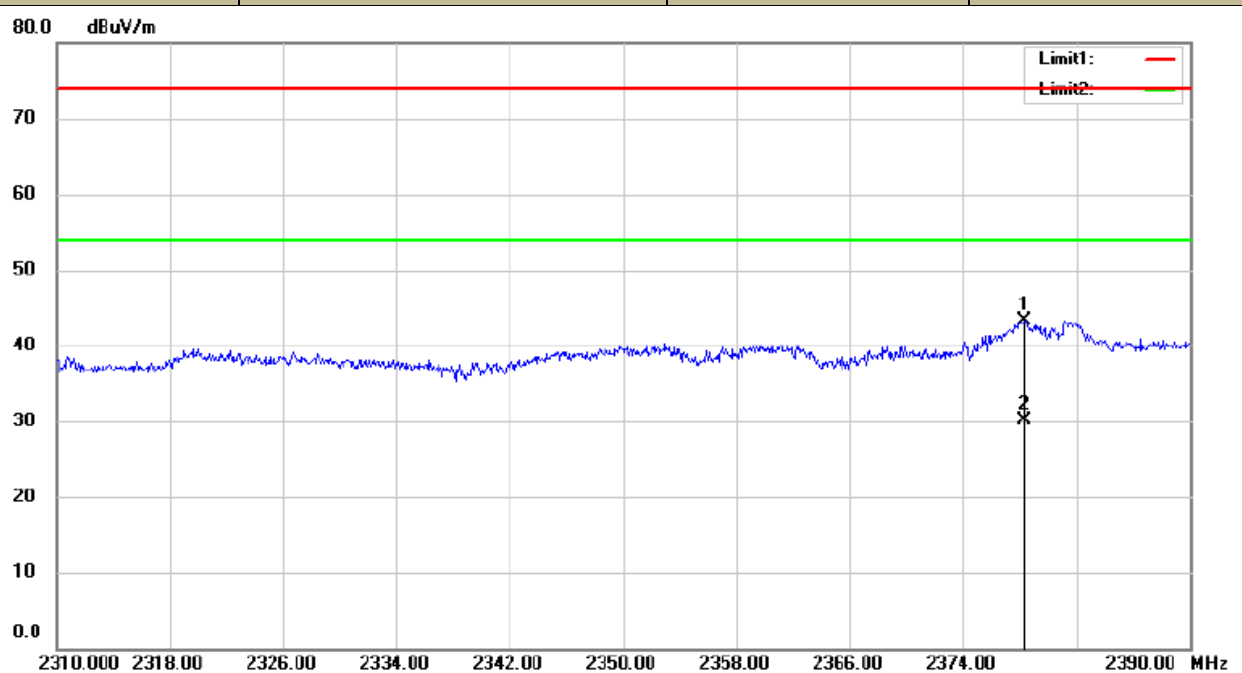

Test Model	Spurious Emission in Restricted Band 2483.5-2500MHz		
	Channel 78: 2480MHz	GFSK	H

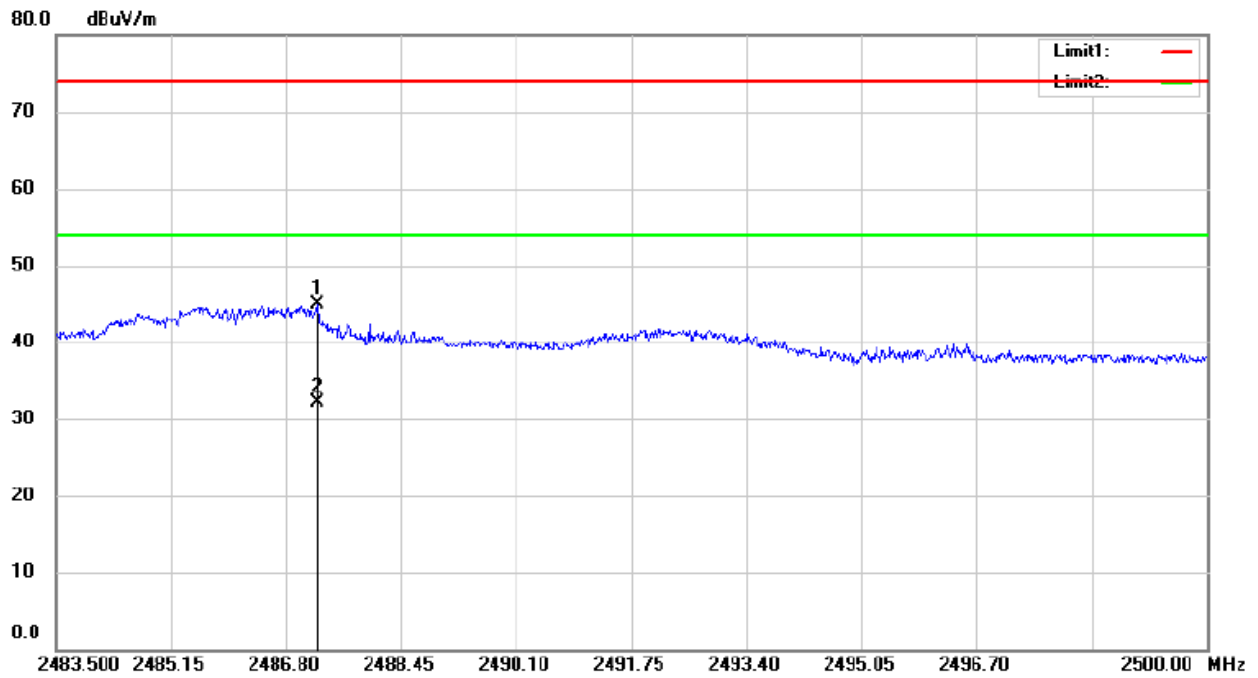

Test Model	Spurious Emission in Restricted Band 2483.5-2500MHz		
	Channel 78: 2480MHz	GFSK	V

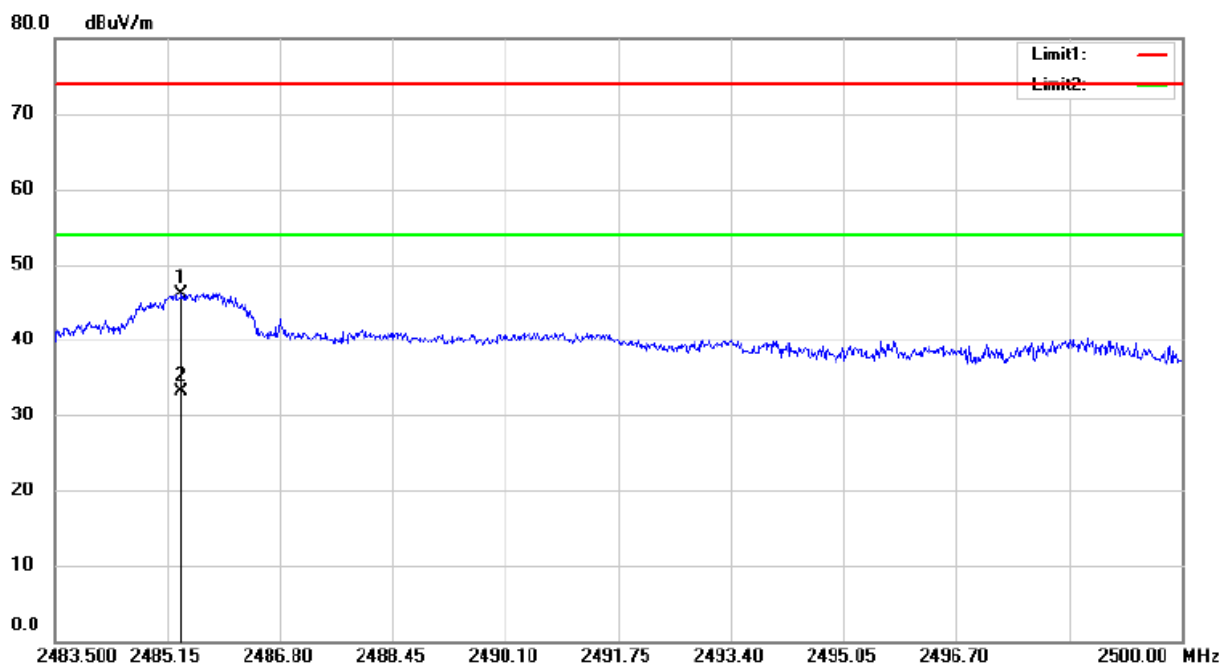

Test Model	Spurious Emission in Restricted Band 2310-2390&2483.5-2500MHz		
	Hopping	GFSK	H

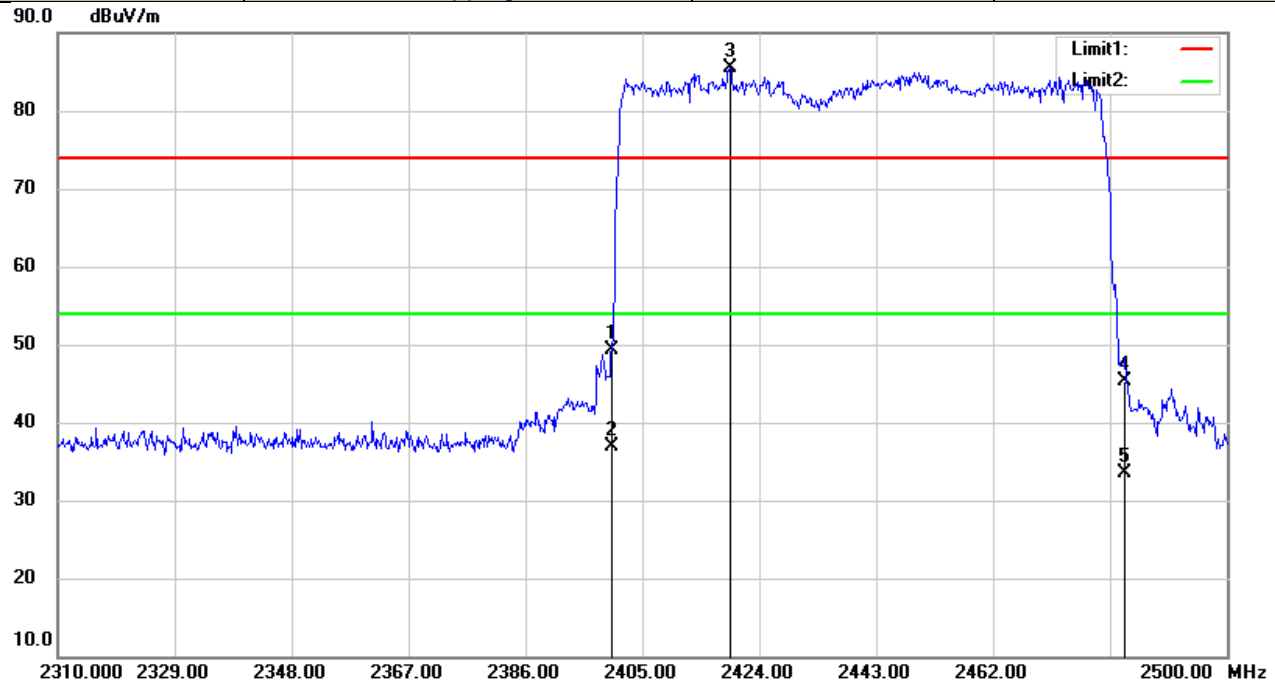

Test Model	Spurious Emission in Restricted Band 2310-2390&2483.5-2500MHz		
	Hopping	GFSK	V

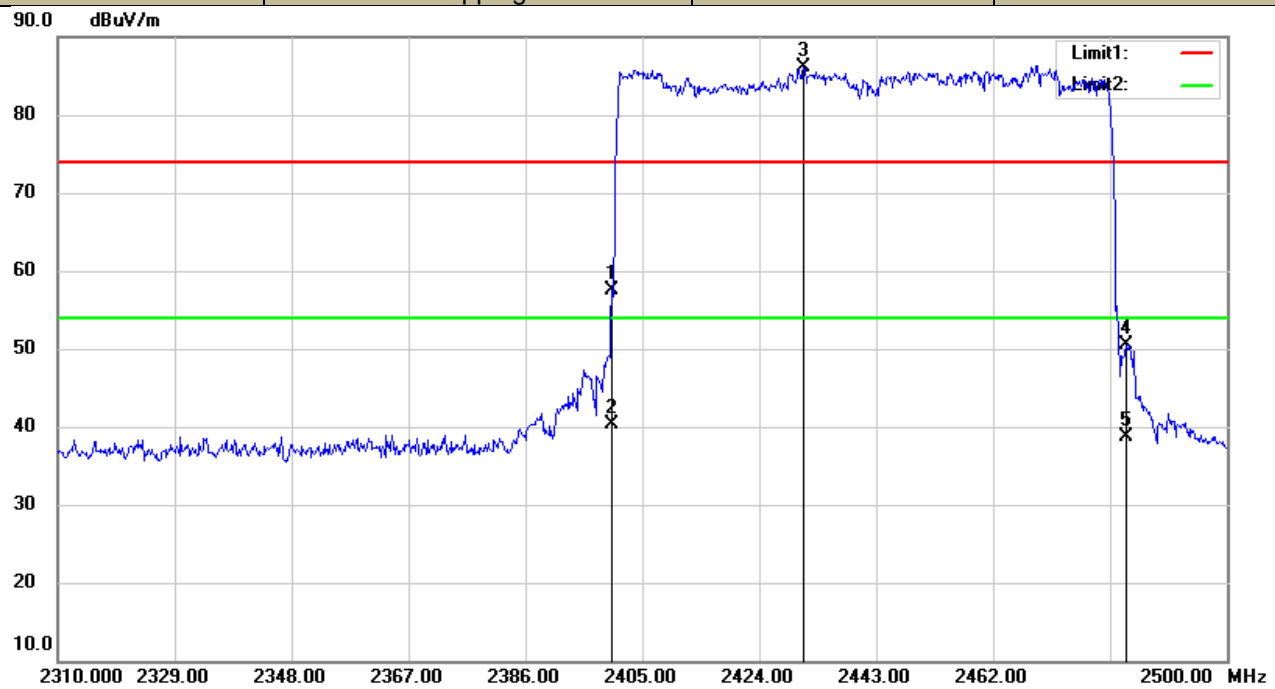

■ Spurious Emission below 1GHz(30MHz to 1GHz)

Bluetooth (GFSK, pi/4-DQPSK, 8DPSK)modehave been tested, and the worst result recorded was report as below:

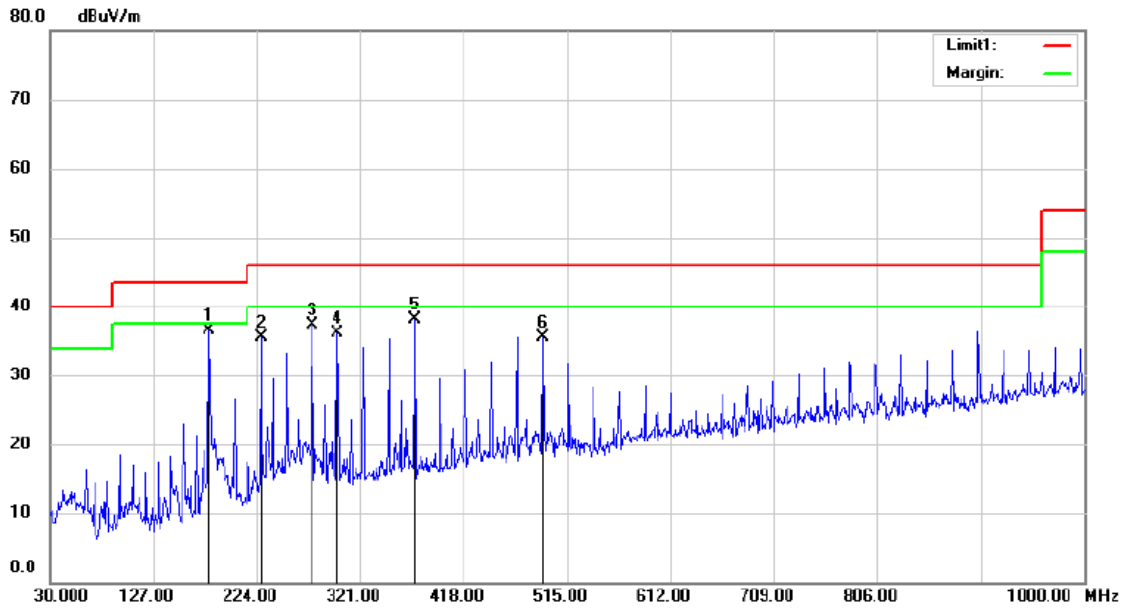

Site 3m Chamber 3# Polarization: *Horizontal* Temperature: 24 C
 Limit: (RE)FCC PART 15C Power: AC 120V/60Hz Humidity: 53 %
 Mode: BT TX 2402
 Note:

No.	Mk.	Freq. MHz	Reading Level dBuV	Correct Factor dB	Measure- ment dBuV/m	Limit dBuV/m	Over dB	Antenna Height cm	Table Degree	Detector	Comment
1	*	179.3800	53.92	-17.34	36.58	43.50	-6.92			QP	
2		227.8800	50.06	-14.54	35.52	46.00	-10.48			QP	
3		276.3800	50.19	-12.93	37.26	46.00	-8.74			QP	
4		299.6600	48.56	-12.44	36.12	46.00	-9.88			QP	
5		372.4100	48.58	-10.51	38.07	46.00	-7.93			QP	
6		491.7200	43.14	-7.55	35.59	46.00	-10.41			QP	

*:Maximum data x:Over limit l:over margin

Operator: KK

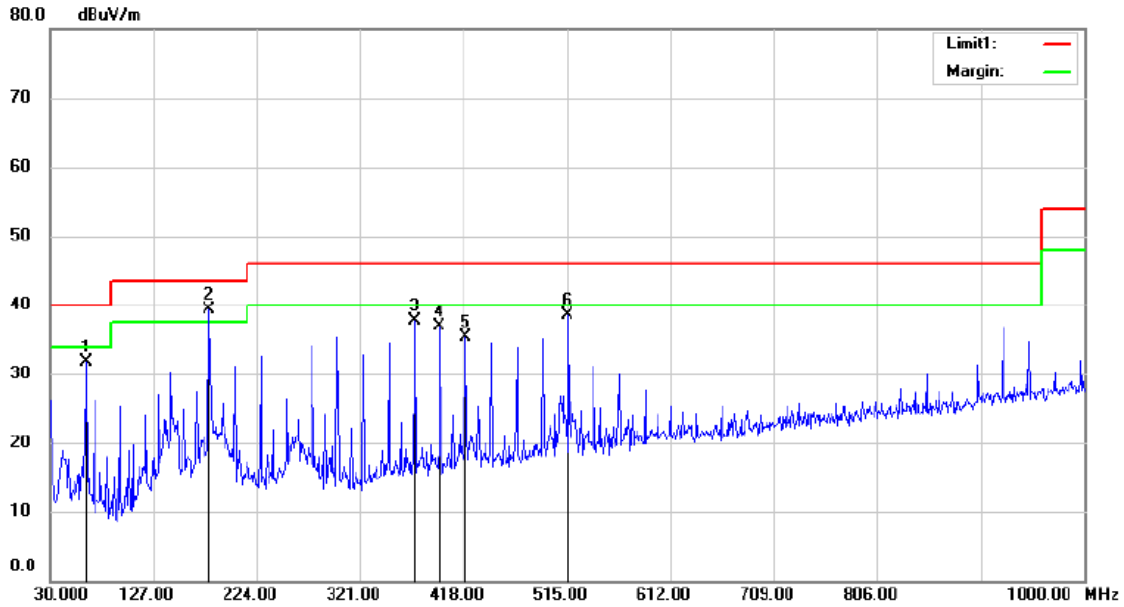

Site: 3m Chamber 3# Polarization: **Vertical** Temperature: 24 C
 Limit: (RE)FCC PART 15C Power: AC 120V/60Hz Humidity: 53 %
 Mode: BT TX 2402
 Note:

No.	Mk.	Freq. MHz	Reading Level dBuV	Correct Factor dB	Measure- ment dBuV/m	Limit dBuV/m	Over dB	Antenna Height cm	Table Degree degree	Detector	Comment
1		63.9500	47.69	-16.08	31.61	40.00	-8.39			QP	
2	*	179.3800	56.57	-17.34	39.23	43.50	-4.27			QP	
3		372.4100	48.26	-10.51	37.75	46.00	-8.25			QP	
4		395.6900	46.62	-9.79	36.83	46.00	-9.17			QP	
5		419.9400	44.12	-8.85	35.27	46.00	-10.73			QP	
6		515.9700	45.74	-7.23	38.51	46.00	-7.49			QP	

*:Maximum data x:Over limit !:over margin

Operator: KK

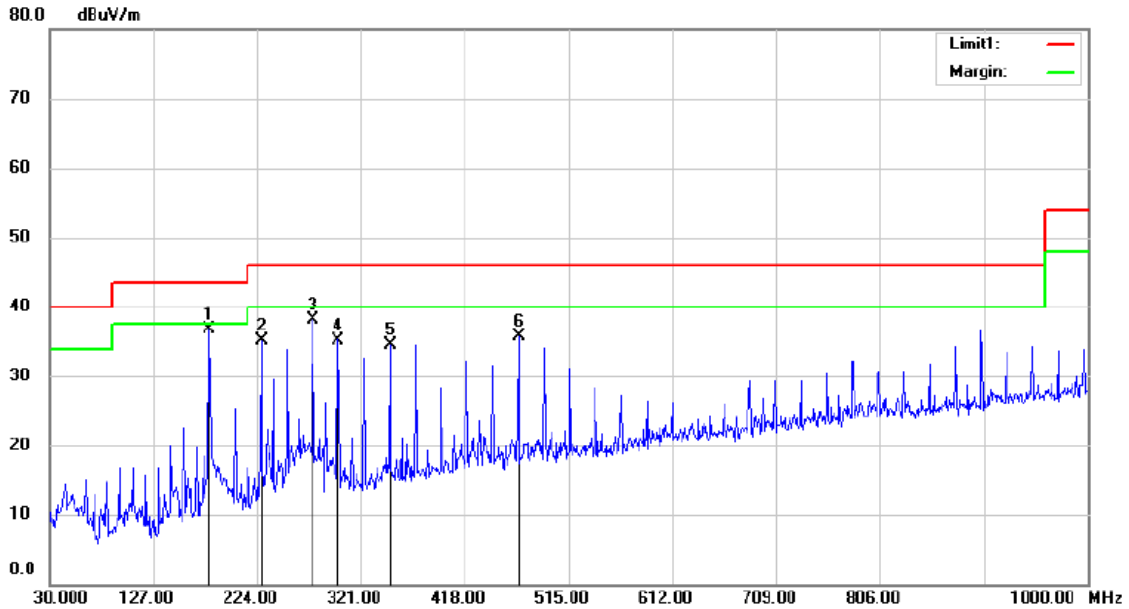

Site: 3m Chamber 3# Polarization: *Horizontal* Temperature: 24 C
 Limit: (RE)FCC PART 15C Power: AC 120V/60Hz Humidity: 53 %
 Mode: BT TX 2441
 Note:

No.	Mk.	Freq.	Reading Level	Correct Factor	Measurement	Limit	Over	Antenna Height	Table Degree	Detector	Comment
		MHz	dBuV	dB	dBuV/m	dBuV/m	dB	cm	degree		
1	*	179.3800	54.02	-17.34	36.68	43.50	-6.82			QP	
2		227.8800	49.67	-14.54	35.13	46.00	-10.87			QP	
3		276.3800	51.12	-12.93	38.19	46.00	-7.81			QP	
4		299.6600	47.64	-12.44	35.20	46.00	-10.80			QP	
5		348.1600	45.22	-10.63	34.59	46.00	-11.41			QP	
6		468.4400	43.94	-8.33	35.61	46.00	-10.39			QP	

*:Maximum data x:Over limit l:over margin

Operator: KK

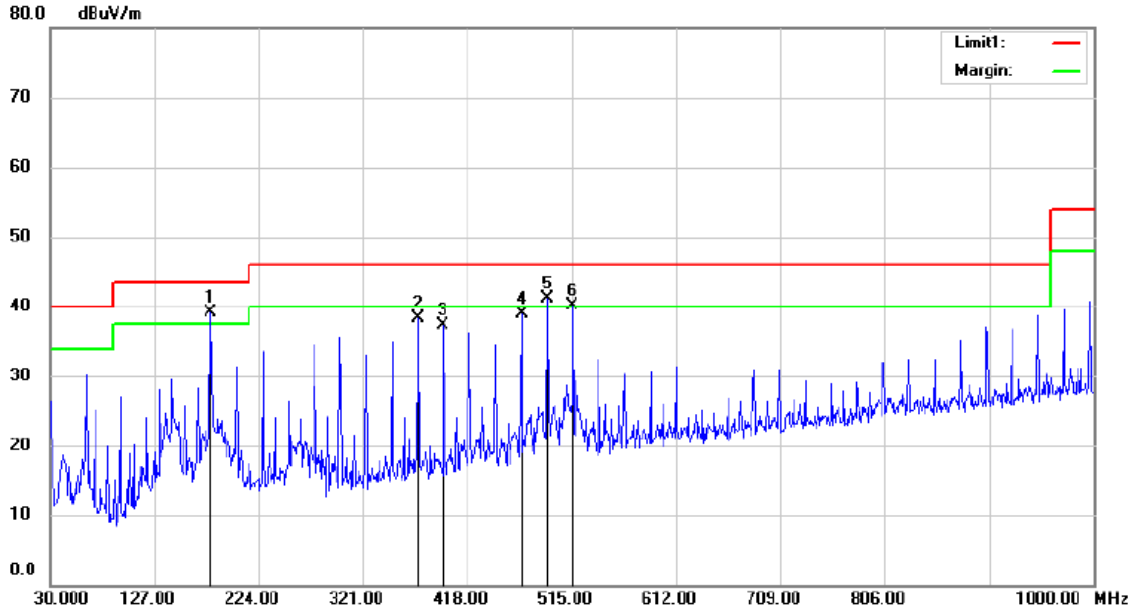

Site 3m Chamber 3# Polarization: **Vertical** Temperature: 24 C
 Limit: (RE)FCC PART 15C Power: AC 120V/60Hz Humidity: 53 %
 Mode:BT TX 2441
 Note:

No.	Mk.	Freq.	Reading Level	Correct Factor	Measurement	Limit	Over	Antenna Height	Table Degree	Comment
		MHz	dBuV	dB	dBuV/m	dBuV/m	dB	cm	degree	
1	*	179.3800	56.36	-17.34	39.02	43.50	-4.48	QP		
2		372.4100	48.87	-10.51	38.36	46.00	-7.64	QP		
3		395.6900	47.12	-9.79	37.33	46.00	-8.67	QP		
4		468.4400	47.25	-8.33	38.92	46.00	-7.08	QP		
5	!	491.7200	48.60	-7.55	41.05	46.00	-4.95	QP		
6	!	515.9700	47.36	-7.23	40.13	46.00	-5.87	QP		

*:Maximum data x:Over limit !:over margin

Operator: KK

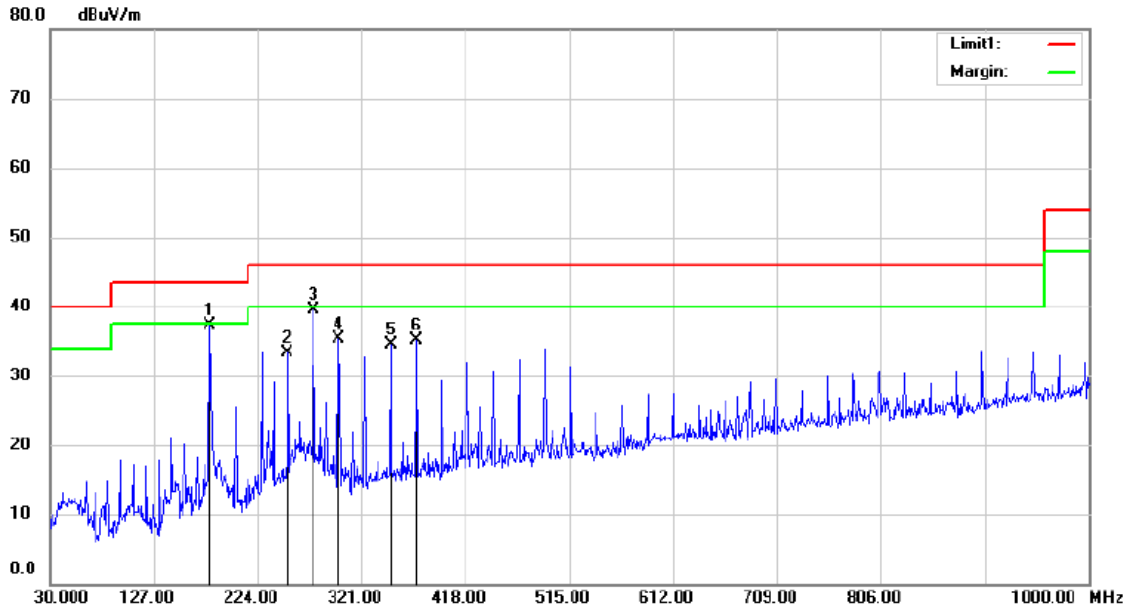

Site 3m Chamber 3# Polarization: *Horizontal* Temperature: 24 C
 Limit: (RE)FCC PART 15C Power: AC 120V/60Hz Humidity: 53 %
 Mode: BT TX 2480
 Note:

No.	Mk.	Freq. MHz	Reading Level dBuV	Correct Factor dB	Measure- ment dBuV/m	Limit dBuV/m	Over dB	Antenna Height cm	Table Degree degree	Detector	Comment
1	*	179.3800	54.61	-17.34	37.27	43.50	-6.23			QP	
2		252.1300	46.94	-13.64	33.30	46.00	-12.70			QP	
3		276.3800	52.43	-12.93	39.50	46.00	-6.50			QP	
4		299.6600	47.80	-12.44	35.36	46.00	-10.64			QP	
5		348.1600	45.04	-10.63	34.41	46.00	-11.59			QP	
6		372.4100	45.69	-10.51	35.18	46.00	-10.82			QP	

*:Maximum data x:Over limit l:over margin

Operator: KK

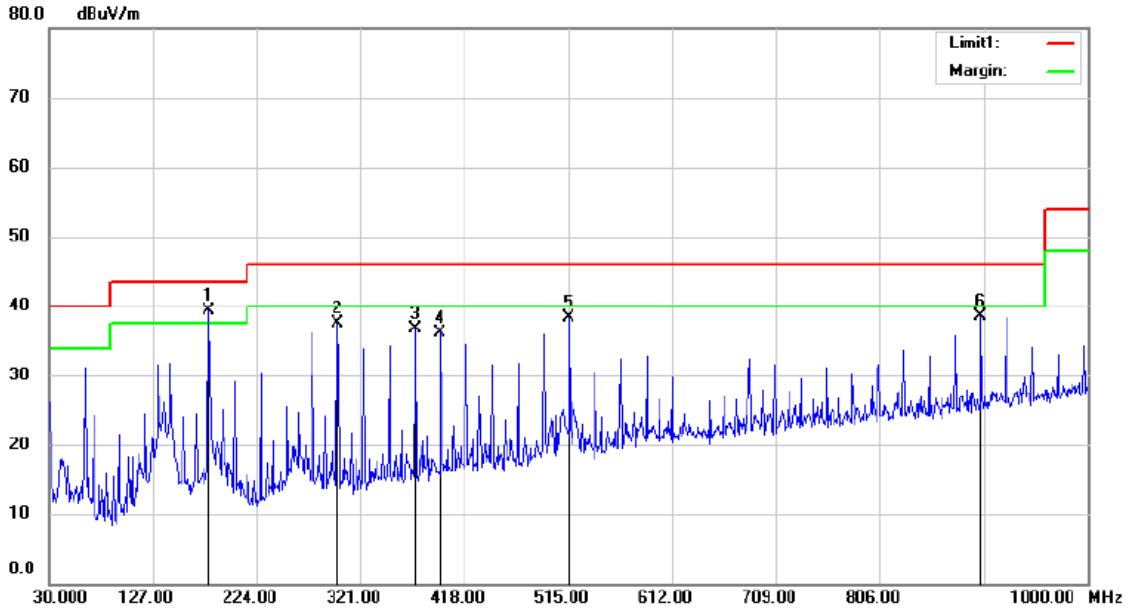

Site: 3m Chamber 3# Polarization: **Vertical** Temperature: 24 C
 Limit: (RE)FCC PART 15C Power: AC 120V60Hz Humidity: 53 %
 Mode: BT TX 2480
 Note:

No.	Mk.	Freq. MHz	Reading Level dBuV	Correct Factor dB	Measure- ment dBuV/m	Limit dBuV/m	Over dB	Antenna Height cm	Table Degree	Detector	Comment
1	*	179.3800	56.65	-17.34	39.31	43.50	-4.19			QP	
2		299.6600	49.95	-12.44	37.51	46.00	-8.49			QP	
3		372.4100	47.26	-10.51	36.75	46.00	-9.25			QP	
4		395.6900	45.99	-9.79	36.20	46.00	-9.80			QP	
5		515.9700	45.52	-7.23	38.29	46.00	-7.71			QP	
6		900.0900	38.83	-0.35	38.48	46.00	-7.52			QP	

*:Maximum data x:Over limit !:over margin

Operator: KK

9.8 CONDUCTED EMISSION TEST

9.8.1 Applicable Standard

According to FCC Part 15.207(a)

9.8.2 Conformance Limit

Frequency(MHz)	Conducted Emission Limit	
	Quasi-peak	Average
0.15-0.5	66-56	56-46
0.5-5.0	56	46
5.0-30.0	60	50

Note: 1. The lower limit shall apply at the transition frequencies
2. The limit decreases in line with the logarithm of the frequency in the range of 0.15 to 0.50MHz.

9.8.3 Test Configuration

Test according to clause 7.3 conducted emission test setup

9.8.4 Test Procedure

The EUT was placed on a table which is 0.8m above ground plane.
Maximum procedure was performed on the highest emissions to ensure EUT compliance.
Repeat above procedures until all frequency measured were complete.

9.8.5 Test Results

The 120V &240V voltage have been tested, and the worst result recorded was report as below:

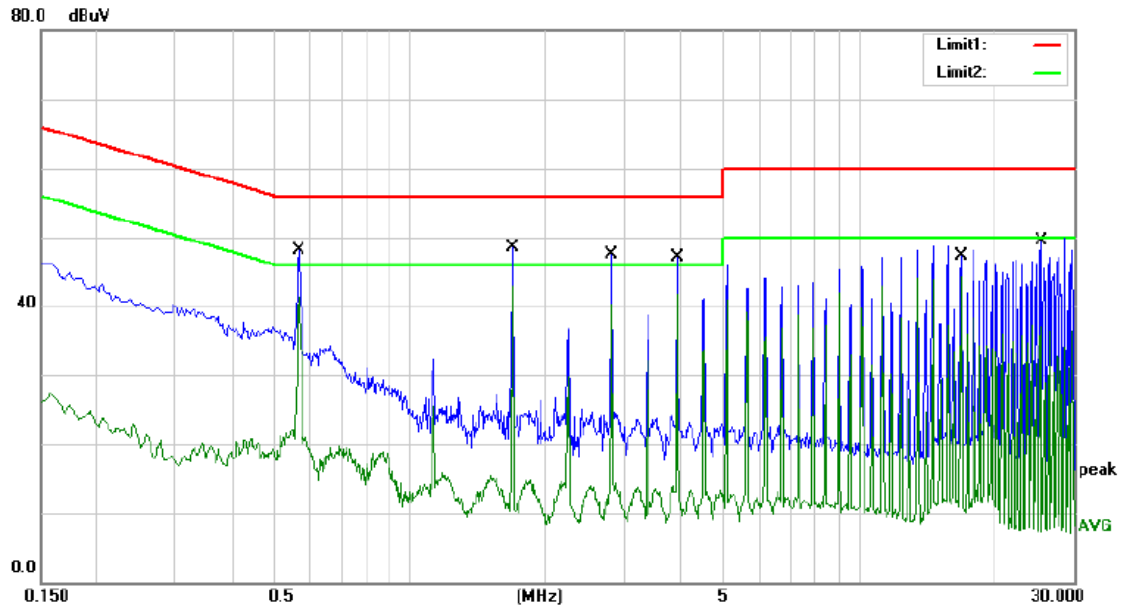

Site Conduction #1 Phase: **L1** Temperature: 24.9
 Limit: (CE)FCC PART 15 class B_QP Power: AC 120V/60Hz Humidity: 54 %
 Mode: Charging+BT ON
 Note:

No. Mk.	Freq. MHz	Reading Level dBuV	Correct Factor dB	Measurement dBuV	Limit dBuV	Over dB	Detector	Comment
1	0.5660	38.32	9.70	48.02	56.00	-7.98	QP	
2	0.5660	32.66	9.70	42.36	46.00	-3.64	AVG	
3	1.6900	38.76	9.77	48.53	56.00	-7.47	QP	
4 *	1.6900	33.12	9.77	42.89	46.00	-3.11	AVG	
5	2.8140	37.78	9.80	47.58	56.00	-8.42	QP	
6	2.8140	30.58	9.80	40.38	46.00	-5.62	AVG	
7	3.9380	37.35	9.80	47.15	56.00	-8.85	QP	
8	3.9380	31.98	9.80	41.78	46.00	-4.22	AVG	
9	16.8620	37.00	10.31	47.31	60.00	-12.69	QP	
10	16.8620	33.96	10.31	44.27	50.00	-5.73	AVG	
11	25.3260	38.95	10.50	49.45	60.00	-10.55	QP	
12	25.3260	26.69	10.50	37.19	50.00	-12.81	AVG	

*:Maximum data x:Over limit l:over margin Comment: Factor build in receiver. Operator: CSL

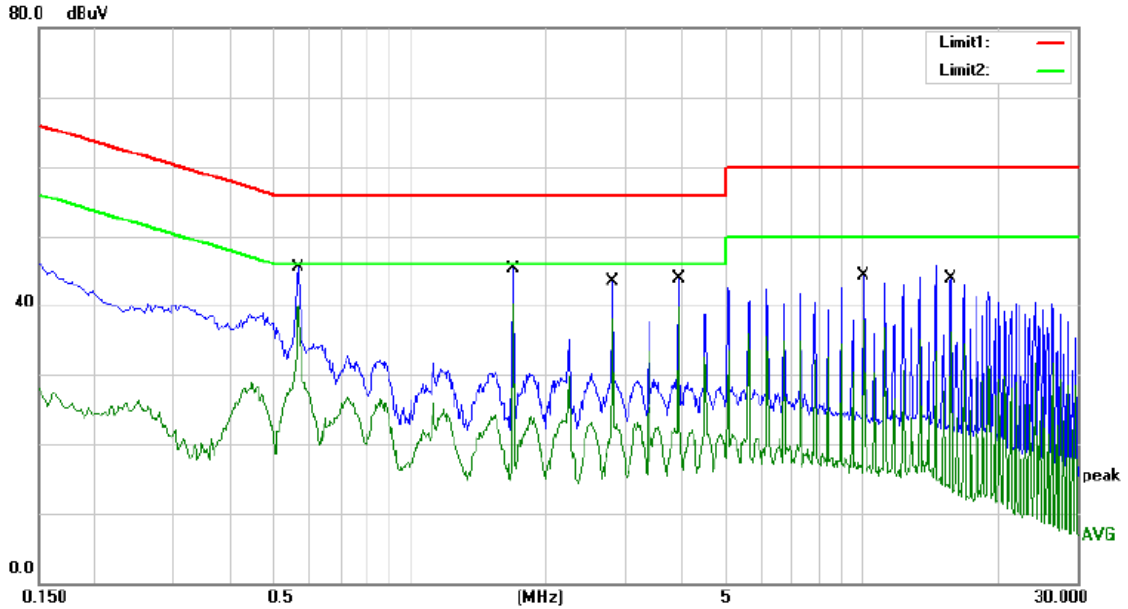

Site Conduction #1
 Limit: (CE)FCC PART 15 class B_QP
 Mode: Charging+BT ON
 Note:

Phase: **N** Temperature: 24.9
 Power: AC 120V/60Hz Humidity: 54 %

No.	Mk.	Freq. MHz	Reading Level dBuV	Correct Factor dB	Measure- ment dBuV	Limit dBuV	Over dB	Detector	Comment
1		0.5660	35.74	9.70	45.44	56.00	-10.56	QP	
2		0.5660	30.15	9.70	39.85	46.00	-6.15	AVG	
3		1.6900	35.59	9.77	45.36	56.00	-10.64	QP	
4	*	1.6900	30.46	9.77	40.23	46.00	-5.77	AVG	
5		2.8100	33.76	9.80	43.56	56.00	-12.44	QP	
6		2.8100	28.31	9.80	38.11	46.00	-7.89	AVG	
7		3.9380	34.10	9.80	43.90	56.00	-12.10	QP	
8		3.9380	29.81	9.80	39.61	46.00	-6.39	AVG	
9		10.1180	34.38	9.91	44.29	60.00	-15.71	QP	
10		10.1180	27.91	9.91	37.82	50.00	-12.18	AVG	
11		15.7500	35.44	10.25	45.69	60.00	-14.31	QP	
12		15.7500	25.76	10.25	36.01	50.00	-13.99	AVG	

*:Maximum data x:Over limit l:over margin Comment: Factor build in receiver. Operator: CSL

9.9 ANTENNA APPLICATION

9.9.1 Antenna Requirement

Standard	Requirement
FCC CRF Part15.203	An intentional radiator shall be designed to ensure that no antenna other than that furnished by the responsible party shall be used with the device. The use of a permanently attached antenna or of an antenna that uses a unique coupling to the intentional radiator shall be considered sufficient to comply with the provisions of this section. The manufacturer may design the unit so that a broken antenna can be replaced by the user, but the use of a standard antenna jack or electrical connector is prohibited. This requirement does not apply to carrier current devices or to devices operated under the provisions of §15.211, §15.213, §15.217, §15.219, or §15.221. Further, this requirement does not apply to intentional radiators that must be professionally installed, such as perimeter protection systems and some field disturbance sensors, or to other intentional radiators which, in accordance with §15.31(d), must be measured at the installation site. However, the installer shall be responsible for ensuring that the proper antenna is employed so that the limits in this part are not exceeded.

For intentional device, according to FCC 47 CFR Section 15.203, an intentional radiator shall be designed to ensure that no antenna other than that furnished by the responsible party shall be used with the device. And according to FCC 47 CFR Section 15.247 (b), if transmitting antennas of directional gain greater than 6dBi are used, the power shall be reduced by the amount in dB that the directional gain of the antenna exceeds 6dBi.

9.9.2 Result

The EUT'S antenna is PCB antenna. The antenna's gain is 0 dBi, and the antenna can't be replaced by the user which in accordance to section 15.203, please refer to the photos.