

SAR EVALUATION REPORT

For

Fujian Juston Electronic Equipment Co., Ltd.

No.115, Yuantai 3rd Road, Jiangnan, Hi-tech Park, Licheng District,
Quanzhou, China

FCC ID: 2AB4FD60U

Report Type: Original Report	Product Type: DMR Handheld Two Way Radio
Prepared by: Terry XiaHou	<i>Terry XiaHou</i>
Report Number: RSZ160728001-20	
Report Date: 2016-09-18	
Reviewed By: Wilson Chen	<i>Wilson Chen</i>
Prepared By: Bay Area Compliance Laboratories Corp. (Shenzhen) 6/F, the 3rd Phase of WanLi Industrial Building, ShiHua Road, FuTian Free Trade Zone Shenzhen, Guangdong, China Tel: +86-755-33320018 Fax: +86-755-33320008 www.baclcorp.com.cn	

Attestation of Test Results				
EUT Information		Company Name		Fujian Juston Electronic Equipment Co., Ltd.
		EUT Description		DMR Handheld Two Way Radio
		FCC ID		2AB4FD60U
		Model Number		Tested Model: HYDX-D60 Multiple Models: HYDX-D62, HYDX-D66, HYDX-D88
		Test Date		2016-08-22
Frequency (MHz)	Modulation	Max. SAR Level(s) Reported (1g)		Limit (W/Kg)
400-480	Digital	12.5kHz	Face up: 1.380 W/kg(corrected by Multiplying 50%) Body-Back: 1.952 W/kg(corrected by Multiplying 50%)	8.0
	Analog	12.5kHz	Face up: 2.843 W/kg (<i>corrected by Multiplying 50%.</i>) Body-Back: 3.466 W/kg (<i>corrected by Multiplying 50%.</i>)	
Applicable Standards		ANSI / IEEE C95.1: 2005 IEEE Standard for Safety Levels with Respect to Human Exposure to Radio Frequency Electromagnetic Fields,3 kHz to 300 GHz.		
		ANSI / IEEE C95.3: 2002 IEEE Recommended Practice for Measurements and Computations of Radio Frequency Electromagnetic Fields With Respect to Human Exposure to Such Fields,100 kHz—300 GHz.		
		IEC62209-2:2010 Human exposure to radio frequency fields from hand-held and body-mounted wireless communication devices – Human models, instrumentation, and procedures – Part 2: Procedure to determine the specific absorption rate (SAR) for wireless communication devices used in close proximity to the human body.		
		IEEE1528:2013 IEEE Recommended Practice for Determining the Peak Spatial-Average Specific Absorption Rate (SAR) in the Human Head from Wireless Communications Devices: Measurement Techniques		
		KDB procedures KDB 447498 D01 v06: Mobile and Portable Devices RF Exposure Procedures and Equipment Authorization Policies. KDB 865664 D01v01r04: SAR measurement 100 MHz to 6 GHz v01. KDB 643646D01 v01r03: SAR test Reduction Considerations for Occupational PTT Radios. KDB Inquiry: Tracking Number 316436 for SAR VHF system validation.		
<p>Note: This wireless device has been shown to be capable of compliance for localized specific absorption rate SAR for Occupational /Controlled Exposure Environment limits specified in ANSI/IEEE Standards and has been tested in accordance with the measurement procedures specified in IEEE 1528-2013 and RF exposure KDB procedures.</p> <p>The results and statements contained in this report pertain only to the device(s) evaluated.</p>				

TABLE OF CONTENTS

DOCUMENT REVISION HISTORY	4
EUT DESCRIPTION	5
TECHNICAL SPECIFICATION	5
REFERENCE, STANDARDS, AND GUIDELINES	6
SAR LIMITS	7
FACILITIES.....	8
DESCRIPTION OF TEST SYSTEM	9
EQUIPMENT LIST AND CALIBRATION	16
EQUIPMENTS LIST & CALIBRATION INFORMATION	16
SAR MEASUREMENT SYSTEM VERIFICATION	17
LIQUID VERIFICATION	17
SYSTEM ACCURACY VERIFICATION	18
SAR SYSTEM VALIDATION DATA	19
EUT TEST STRATEGY AND METHODOLOGY	23
CONDUCTED OUTPUT POWER MEASUREMENT	25
PROVISION APPLICABLE	25
TEST PROCEDURE	25
MAXIMUM OUTPUT POWER AMONG PRODUCTION UNITS	25
TEST RESULTS:	26
SAR MEASUREMENT RESULTS.....	27
SAR TEST DATA	27
TEST RESULT:	27
SAR PLOTS (SUMMARY OF THE HIGHEST SAR VALUES)	29
APPENDIX A – MEASUREMENT UNCERTAINTY	33
APPENDIX B – PROBE CALIBRATION CERTIFICATES.....	35
APPENDIX C – DIPOLE CALIBRATION CERTIFICATES.....	45
APPENDIX D – EUT TEST POSITION PHOTOS	54
LIQUID DEPTH \geq 15CM	54
FACE-UP 2.5 CM SEPARATION TO FLAT PHANTOM	54
BODY-BACK 0.0 CM SEPARATION TO FLAT PHANTOM.....	55
APPENDIX E – EUT PHOTOS	56
EUT – FRONT VIEW	56
EUT – BACK VIEW	56
EUT–LEFT VIEW	57
EUT–RIGHT VIEW	57
EUT–TOP VIEW.....	58
EUT–BOTTOM VIEW	58
EUT-UNCOVER VIEW.....	59
EUT–BATTERY.....	59
EUT–ANTENNA.....	60
EUT–BELT-CLIP	60
APPENDIX E – INFORMATIVE REFERENCES.....	61

DOCUMENT REVISION HISTORY

Revision Number	Report Number	Description of Revision	Date of Revision
0	RSZ160728001-20	Original Report	2016-09-18

EUT DESCRIPTION

This report has been prepared on behalf of Fujian Juston Electronic Equipment Co., Ltd. and their product and their product, FCC ID: 2AB4FD60U , Model: HYDX-D60 or the EUT (Equipment Under Test) as referred to in the rest of this report. The EUT is a DMR Handheld Two Way Radio.

Note:

1. This series products model: HYDX-D62, HYDX-D66, HYDX-D88 and HYDX-D60, we select model: HYDX-D60 to test, there is no electrical change has been made to the equipment, please refer to the product similarity letter.

Technical Specification

Product Type	Portable
Exposure Category:	Occupational/Controlled Exposure
Antenna Type(s):	External Antenna
Body-Worn Accessories:	Belt Clip and Headset Cable
Face-Head Accessories:	None
Modulation Type:	FM/4FSK
Frequency Band:	FM/4FSK :400MHz-480MHz
Conducted RF Power:	FM/4FSK :36.45 dBm
EUT Dimensions (L*W*H):	132 mm (L)×62 mm (W)×38 mm (H)
Power Source:	7.4V Rechargeable Li-ION Battery
Normal Operation:	Face Up and Body-worn

REFERENCE, STANDARDS, AND GUIDELINES

FCC:

The Report and Order requires routine SAR evaluation prior to equipment authorization of portable transmitter devices, including portable telephones. For consumer products, the applicable limit is 1.6 mW/g as recommended by the ANSI/IEEE standard C95.1-1992 [6] for an uncontrolled environment (Paragraph 65). According to the Supplement C of OET Bulletin 65 "Evaluating Compliance with FCC Guide-lines for Human Exposure to Radio frequency Electromagnetic Fields", released on Jun 29, 2001 by the FCC, the device should be evaluated at maximum output power (radiated from the antenna) under "worst-case" conditions for normal or intended use, incorporating normal antenna operating positions, device peak performance frequencies and positions for maximum RF energy coupling.

This report describes the methodology and results of experiments performed on wireless data terminal. The objective was to determine if there is RF radiation and if radiation is found, what is the extent of radiation with respect to safety limits. SAR (Specific Absorption Rate) is the measure of RF exposure determined by the amount of RF energy absorbed by human body (or its parts) – to determine how the RF energy couples to the body or head which is a primary health concern for body worn devices. The limit below which the exposure to RF is considered safe by regulatory bodies in North America is 1.6 mW/g average over 1 gram of tissue mass.

CE:

The order requires routine SAR evaluation prior to equipment authorization of portable transmitter devices, including portable telephones. For consumer products, the applicable limit is 2 mW/g as recommended by EN62209-1 for an uncontrolled environment. According to the Standard, the device should be evaluated at maximum output power (radiated from the antenna) under "worst-case" conditions for normal or intended use, incorporating normal antenna operating positions, device peak performance frequencies and positions for maximum RF energy coupling.

This report describes the methodology and results of experiments performed on wireless data terminal. The objective was to determine if there is RF radiation and if radiation is found, what is the extent of radiation with respect to safety limits. SAR (Specific Absorption Rate) is the measure of RF exposure determined by the amount of RF energy absorbed by human body (or its parts) – to determine how the RF energy couples to the body or head which is a primary health concern for body worn devices. The limit below which the exposure to RF is considered safe by regulatory bodies in Europe is 2 mW/g average over 10 gram of tissue mass.

The test configurations were laid out on a specially designed test fixture to ensure the reproducibility of measurements. Each configuration was scanned for SAR. Analysis of each scan was carried out to characterize the above effects in the device.

SAR Limits

FCC Limit (1g Tissue)

EXPOSURE LIMITS	SAR (W/kg)	
	(General Population / Uncontrolled Exposure Environment)	(Occupational / Controlled Exposure Environment)
Spatial Average (averaged over the whole body)	0.08	0.4
Spatial Peak (averaged over any 1 g of tissue)	1.60	8.0
Spatial Peak (hands/wrists/feet/ankles averaged over 10 g)	4.0	20.0

CE Limit (10g Tissue)

EXPOSURE LIMITS	SAR (W/kg)	
	(General Population / Uncontrolled Exposure Environment)	(Occupational / Controlled Exposure Environment)
Spatial Average (averaged over the whole body)	0.08	0.4
Spatial Peak (averaged over any 10 g of tissue)	2.0	10
Spatial Peak (hands/wrists/feet/ankles averaged over 10 g)	4.0	20.0

Population/Uncontrolled Environments are defined as locations where there is the exposure of individual who have no knowledge or control of their exposure.

Occupational/Controlled Environments are defined as locations where there is exposure that may be incurred by people who are aware of the potential for exposure (i.e. as a result of employment or occupation).

Occupational/Controlled environments Spatial Peak limit 8.0W/kg (FCC/IC) & 10 W/kg (CE) applied to the EUT.

FACILITIES

The test site used by Bay Area Compliance Laboratories Corp. (Shenzhen) to collect data is located at 6/F, the 3rd Phase of WanLi Industrial Building, Shi Hua Road, Fu Tian Free Trade Zone, Shenzhen, Guangdong, P.R. of China

DESCRIPTION OF TEST SYSTEM

These measurements were performed with ALSAS 10 Universal Integrated SAR Measurement system from APREL Laboratories.

ALSAS-10U System Description

ALSAS-10-U is fully compliant with the technical and scientific requirements of IEEE 1528, IEC 62209, CENELEC, ARIB, ACA, and the Federal Communications Commission. The system comprises of a six axes articulated robot which utilizes a dedicated controller.

ALSAS-10U uses the latest methodologies. And FDTD modeling to provide a platform which is repeatable with minimum uncertainty.

Applications

Predefined measurement procedures compliant with the guidelines of CENELEC, IEEE, IEC, FCC, etc are utilized during the assessment for the device. Automatic detection for all SAR maxima are embedded within the core architecture for the system, ensuring that peak locations used for centering the zoom scan are within a 1mm resolution and a 0.05mm repeatable position. System operation range currently available up-to 6 GHz in simulated tissue.

Area Scans

Area scans are defined prior to the measurement process being executed with a user defined variable spacing between each measurement point (integral) allowing low uncertainty measurements to be conducted. Scans defined for FCC applications utilize a 10mm² step integral, with 1mm interpolation used to locate the peak SAR area used for zoom scan assessments.

Where the system identifies multiple SAR peaks (which are within 25% of peak value) the system will provide the user with the option of assessing each peak location individually for zoom scan averaging.

Zoom Scan (Cube Scan Averaging)

The averaging zoom scan volume utilized in the ALSAS-10U software is in the shape of a cube and the side dimension of a 1 g or 10 g mass is dependent on the density of the liquid representing the simulated tissue. A density of 1000 kg/m³ is used to represent the head and body tissue density and not the phantom liquid density, in order to be consistent with the definition of the liquid dielectric properties, i.e. the side length of the 1 g cube is 10mm, with the side length of the 10 g cube 21,5mm.

When the cube intersects with the surface of the phantom, it is oriented so that 3 vertices touch the surface of the shell or the center of a face is tangent to the surface. The face of the cube closest to the surface is modified in order to conform to the tangent surface.

The zoom scan integer steps can be user defined so as to reduce uncertainty, but normal practice for typical test applications (including FCC) utilize a physical step of 5x5x8 (8mmx8mmx5mm) providing a volume of 32mm³ in the X & Y axis, and 35mm in the Z axis.



ALSAS-10U Interpolation and Extrapolation Uncertainty

The overall uncertainty for the methodology and algorithms the used during the SAR calculation was evaluated using the data from IEEE 1528 based on the example f3 algorithm:

$$f_3(x, y, z) = A \frac{a^2}{\frac{a^2}{4} + x'^2 + y'^2} \cdot \left(e^{-\frac{2z}{a}} + \frac{a^2}{2(a + 2z)^2} \right)$$

Isotropic E-Field Probe

The isotropic E-Field probe has been fully calibrated and assessed for isotropicity, and boundary effect within a controlled environment. Depending on the frequency for which the probe is calibrated the method utilized for calibration will change.

The E-Field probe utilizes a triangular sensor arrangement as detailed in the diagram below:

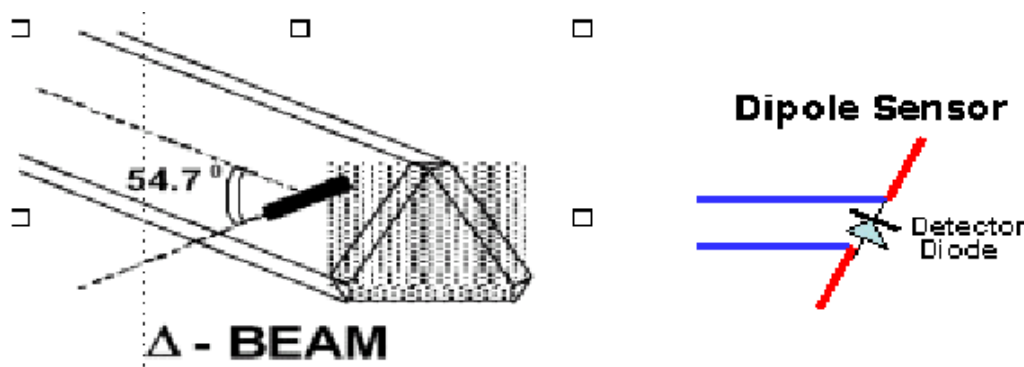

SAR is assessed with a calibrated probe which moves at a default height of 5mm from the center of the diode, which is mounted to the sensor, to the phantom surface (in the Z Axis). The 5mm offset height has been selected so as to minimize any resultant boundary effect due to the probe being in close proximity to the phantom surface.

The following algorithm is an example of the function used by the system for linearization of the output from the probe when measuring complex modulation schemes.

$$V_i = U_i + U_i^2 \cdot \frac{cf}{dcp_i}$$

Isotropic E-Field Probe Specification

Calibration Method	Frequency Dependent Below 1 GHz Calibration in air performed in a TEM Cell Above 1 GHz Calibration in air performed in waveguide
Sensitivity	0.70 $\mu\text{V}/(\text{V}/\text{m})^2$ to 0.85 $\mu\text{V}/(\text{V}/\text{m})^2$
Dynamic Range	0.0005 W/kg to 100 W/kg
Isotropic Response	Better than 0.1 dB
Diode Compression Point (DCP)	Calibration for Specific Frequency
Probe Tip Diameter	< 2.9 mm
Sensor Offset	1.56 (+/- 0.02 mm)
Probe Length	289 mm
Video Bandwidth	@ 500 Hz: 1 dB @ 1.02 kHz: 3 dB
Boundary Effect	Less than 2.1% for distance greater than 0.58 mm
Spatial Resolution	The spatial resolution uncertainty is less than 1.5% for 4.9mm diameter probe. The spatial resolution uncertainty is less than 1.0% for 2.5mm diameter probe

Boundary Detection Unit and Probe Mounting Device

ALSAS-10U incorporates a boundary detection unit with a sensitivity of 0.05mm for detecting all types of surfaces. The robust design allows for detection during probe tilt (probe normalize) exercises, and utilizes a second stage emergency stop. The signal electronics are fed directly into the robot controller for high accuracy surface detection in lateral and axial detection modes (X, Y, & Z).

The probe is mounted directly onto the Boundary Detection unit for accurate tooling and displacement calculations controlled by the robot kinematics. The probe is connect to an isolated probe interconnect where the output stage of the probe is fed directly into the amplifier stage of the Daq-Paq.

Daq-Paq (Analog to Digital Electronics)

ALSAS-10U incorporates a fully calibrated Daq-Paq (analog to digital conversion system) which has a 4 channel input stage, sent via a 2 stage auto-set amplifier module. The input signal is amplified accordingly so as to offer a dynamic range from 5 μV to 800mV. Integration of the fields measured is carried out at board level utilizing a Co-Processor which then sends the measured fields down into the main computational module in digitized form via an RS232 communications port. Probe linearity and duty cycle compensation is carried out within the main Daq-Paq module.

ADC	12 Bit
Amplifier Range	20 mV to 200 mV and 150 mV to 800 mV
Field Integration	Local Co-Processor utilizing proprietary integration algorithms
Number of Input Channels	4 in total 3 dedicated and 1 spare
Communication	Packet data via RS232

Axis Articulated Robot

ALSAS-10U utilizes a six axis articulated robot, which is controlled using a Pentium based real-time movement controller. The movement kinematics engine utilizes proprietary (Thermo CRS) interpolation and extrapolation algorithms, which allow full freedom of movement for each of the six joints within the working envelope. Utilization of joint 6 allows for full probe rotation with a tolerance better than 0.05mm around the central axis.



Robot/Controller Manufacturer	Thermo CRS
Number of Axis	Six independently controlled axis
Positioning Repeatability	0.05 mm
Controller Type	Single phase Pentium based C500C
Robot Reach	710 mm
Communication	RS232 and LAN compatible

ALSAS Universal Workstation

ALSAS Universal workstation allows for repeatability and fast adaptability. It allows users to do calibration, testing and measurements using different types of phantoms with one set up, which significantly speeds up the measurement process.

Universal Device Positioner

The universal device positioner allows complete freedom of movement of the EUT. Developed to hold a EUT in a free-space scenario any additional loading attributable to the material used in the construction of the positioner has been eliminated. Repeatability has been enhanced through the linear scales which form the design used to indicate positioning for any given test scenario in all major axes. A 15° tilt indicator is included for the of aid cheek to tilt movements for head SAR analysis. Overall uncertainty for measurements have been reduced due to the design of the Universal device positioner, which allows positioning of a device in as near to a free-space scenario as possible, and by providing the means for complete repeatability.



Phantom Types

The ALSAS-10U allows the integration of multiple phantom types. SAM Phantoms fully compliant with IEEE 1528, Universal Phantom, and Universal Flat.

APREL SAM Phantoms

The SAM phantoms developed using the IEEE SAM CAD file. They are fully compliant with the requirements for both IEEE 1528 and FCC Supplement C. Both the left and right SAM phantoms are interchangeable, transparent and include the IEEE 1528 grid with visible NF and MB lines.

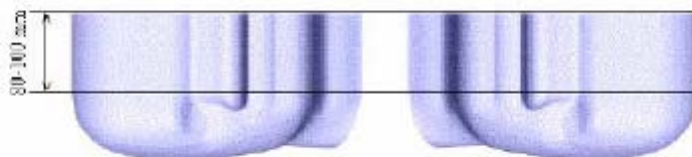

APREL Laboratories Universal Phantom

The Universal Phantom is used on the ALSAS-10U as a system validation phantom. The Universal Phantom has been fully validated both experimentally from 30MHz to 6GHz and numerically using XFDTD numerical software.

The shell thickness is 2mm overall, with a 4mm spacer located at the NF/MB intersection providing an overall thickness of 6mm in line with the requirements of IEEE-1528.

The design allows for fast and accurate measurements, of handsets, by allowing the conservative SAR to be evaluated at on frequency for both left and right head experiments in one measurement.



Tissue Dielectric Parameters for Head and Body Phantoms

The head tissue dielectric parameters recommended by the IEEE SCC-34/SC-2 in P1528 have been incorporated in the following table. These head parameters are derived from planar layer models simulating the highest expected SAR for the dielectric properties and tissue thickness variations in a human head. Other head and body tissue parameters that have not been specified in P1528 are derived from the tissue dielectric parameters computed from the 4-Cole-Cole equations described in Reference [12] and extrapolated according to the head parameters specified in P1528.

Ingredients (% by weight)	Frequency (MHz)									
	450		835		915		1900		2450	
Tissue Type	Head	Body	Head	Body	Head	Body	Head	Body	Head	Body
Water	38.56	51.16	41.45	52.4	41.05	56.0	54.9	40.4	62.7	73.2
Salt (Nacl)	3.95	1.49	1.45	1.4	1.35	0.76	0.18	0.5	0.5	0.04
Sugar	56.32	46.78	56.0	45.0	56.5	41.76	0.0	58.0	0.0	0.0
HEC	0.98	0.52	1.0	1.0	1.0	1.21	0.0	1.0	0.0	0.0
Bactericide	0.19	0.05	0.1	0.1	0.1	0.27	0.0	0.1	0.0	0.0
Triton x-100	0.0	0.0	0.0	0.0	0.0	0.0	0.0	0.0	36.8	0.0
DGBE	0.0	0.0	0.0	0.0	0.0	0.0	44.92	0.0	0.0	26.7
Dielectric Constant	43.42	58.0	42.54	56.1	42.0	56.8	39.9	54.0	39.8	52.5
Conductivity (s/m)	0.85	0.83	0.91	0.95	1.0	1.07	1.42	1.45	1.88	1.78

Recommended Tissue Dielectric Parameters for Head and Body

Frequency (MHz)	Head Tissue		Body Tissue	
	ϵ_r	σ (S/m)	ϵ_r	σ (S/m)
150	52.3	0.76	61.9	0.80
300	45.3	0.87	58.2	0.92
450	43.5	0.87	56.7	0.94
835	41.5	0.90	55.2	0.97
900	41.5	0.97	55.0	1.05
915	41.5	0.98	55.0	1.06
1450	40.5	1.20	54.0	1.30
1610	40.3	1.29	53.8	1.40
1800-2000	40.0	1.40	53.3	1.52
2450	39.2	1.80	52.7	1.95
3000	38.5	2.40	52.0	2.73
5800	35.3	5.27	48.2	6.00

EQUIPMENT LIST AND CALIBRATION

Equipments List & Calibration Information

Equipment	Model	Calibration Date	Calibration Due Date	S/N
CRS F3 robot	ALS-F3	N/A	N/A	RAF0805352
CRS F3 Software	ALS-F3-SW	N/A	N/A	N/A
CRS C500C controller	ALS-C500	N/A	N/A	RCF0805379
Probe mounting device & Boundary Detection Sensor System	ALS-PMDPS-3	N/A	N/A	120-00270
Universal Work Station	ALS-UWS	N/A	N/A	100-00157
Data Acquisition Package	ALS-DAQ-PAQ-3	2015-12-14	2016-12-14	110-00212
Miniature E-Field Probe	ALS-E-020	2015-12-14	2016-12-14	500-00283
Dipole, 450 MHz	ALS-D-450-S-2	2013-10-08	2016-10-08	175-00503
Device holder/Positioner	ALS-H-E-SET-2	N/A	N/A	170-00510
Left ear SAM phantom	ALS-P-SAM-L	N/A	N/A	130-00311
Right ear SAM phantom	ALS-P-SAM-R	N/A	N/A	140-00359
UniPhantom	ALS-UM-FLAT	N/A	N/A	153-00104
Simulated Tissue 450 MHz Head	ALS-TS-450-H	Each Time	Each Time	260-01106
Simulated Tissue 450 MHz Body	ALS-TS-450-B	Each Time	Each Time	260-02108
Power Amplifier	5S1G4	N/A	N/A	71377
Attenuator	3dB	N/A	N/A	5402
Dielectric probe kit	HP85070B	2016-06-13	2017-06-13	US33020324
Network analyzer	8752C	2016-06-03	2017-06-03	3410A02356
Synthesized Sweeper	HP 8341B	2016-06-03	2017-06-03	2624A00116
Directional couple	DC6180A	2016-06-13	2017-06-13	0325849
EMI Test Receiver	ESCI	2016-06-13	2017-06-13	101746

SAR MEASUREMENT SYSTEM VERIFICATION

Liquid Verification

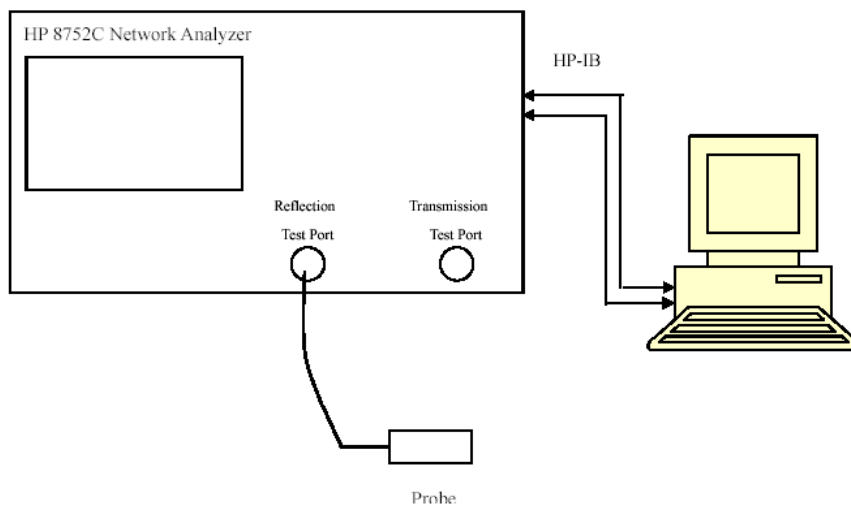

Liquid Verification Setup Block Diagram

Liquid Verification Results

Frequency (MHz)	Liquid Type	Liquid Parameter		Target Value		Delta (%)		Tolerance (%)
		ϵ_r	σ (S/m)	ϵ_r	σ (S/m)	$\Delta\epsilon_r$	$\Delta\sigma$ (S/m)	
400.0125	Head	43.33	0.88	43.50	0.87	-0.391	1.149	±5
	Body	56.55	0.95	56.70	0.94	-0.265	1.064	±5
416.0000	Head	43.42	0.87	43.50	0.87	-0.184	0.000	±5
	Body	56.62	0.93	56.70	0.94	-0.141	-1.064	±5
432.0000	Head	43.47	0.89	43.50	0.87	-0.069	2.299	±5
	Body	56.68	0.96	56.70	0.94	-0.035	2.128	±5
448.0000	Head	43.53	0.89	43.50	0.87	0.069	2.299	±5
	Body	56.73	0.95	56.70	0.94	0.053	1.064	±5
464.0000	Head	43.67	0.9	43.50	0.87	0.391	3.448	±5
	Body	56.78	0.94	56.70	0.94	0.141	0.000	±5
479.9875	Head	43.59	0.9	43.50	0.87	0.207	3.448	±5
	Body	56.87	0.95	56.70	0.94	0.300	1.064	±5

*Liquid Verification was performed on 2016-08-22

System Accuracy Verification

Prior to the assessment, the system validation kit was used to test whether the system was operating within its specifications of $\pm 10\%$. The validation results are tabulated below. And also the corresponding SAR plot is attached as well in the SAR plots files.

System Verification Setup Block Diagram

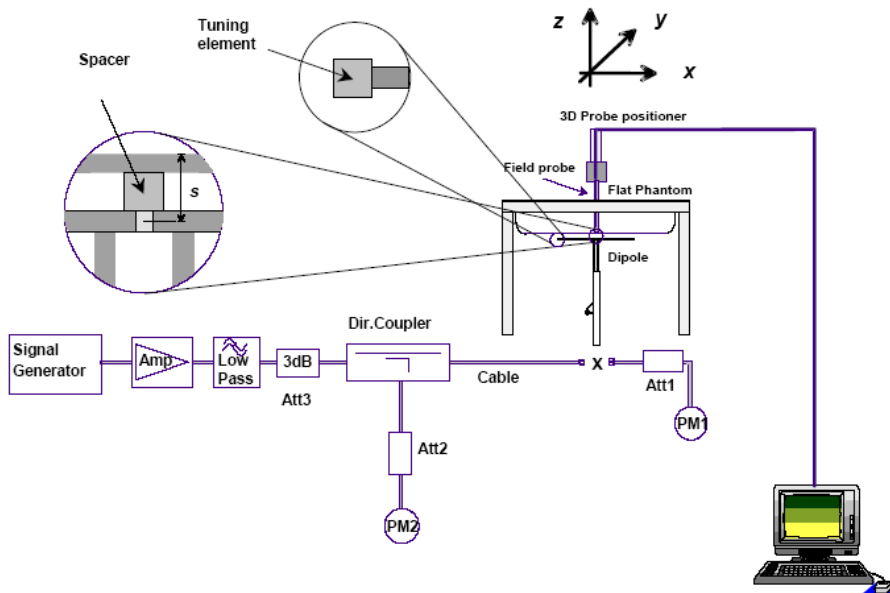

System Accuracy Check Results

Date	Frequency (MHz)	Liquid Type	Measured SAR (W/Kg)	Target Value (W/Kg)	Delta (%)	Tolerance (%)	
2016-08-22	450	Head	1g	4.729	4.572	3.434	± 10
		Body	1g	4.952	4.508	9.849	± 10

*All SAR values are normalized to 1 Watt forward power.

SAR SYSTEM VALIDATION DATA**Test Laboratory: Bay Area Compliance Lab Corp. (Shenzhen)****System Performance Check 450 MHz Liquid****Dipole 450 MHz; Type: ALS-D-450-S-2; S/N: 175-00503**

Product Data

Device Name : Dipole 450 MHz
Serial No. : 175-00503
Type : Dipole
Model : ALS-D-450-S-2
Frequency Band : 450
Max. Transmit Pwr : 1 W
Drift Time : 3 min(s)
Power Drift-Start : 4.112 W/kg
Power Drift-Finish : 4.189 W/kg
Power Drift (%) : 1.873

Phantom Data

Name : APREL-Uni
Type : Uni-Phantom
Serial No. : System Default
Location : Center
Description : Default
Phantom Data

Tissue Data

Type : Head
Serial No. : 260-01106
Frequency : 450.00MHz
Last Calib. Date : 22-Aug-2016
Temperature : 20.00 °C
Ambient Temp. : 21.00 °C
Humidity : 56.00 RH%
Epsilon : 44.35 F/m
Sigma : 0.88 S/m
Density : 1000.00 kg/cu. m

Probe Data

Name : E-Field
Model : E-020
Type : E-Field Triangle
Serial No. : 500-00283
Last Calib. Date : 14-Dec-2015
Frequency Band : 450
Duty Cycle Factor : 1
Conversion Factor : 5.7
Probe Sensitivity : 1.20 1.20 1.20 $\mu\text{V}/(\text{V}/\text{m})^2$
Compression Point : 95.00 mV
Offset : 1.56 mm

Measurement Data

Crest Factor : 1
Scan Type : Complete
Tissue Temp. : 21.00 °C
Ambient Temp. : 21.00 °C
Area Scan : 9x15x1 : Measurement x=10mm, y=10mm, z=4mm
Zoom Scan : 7x7x7 : Measurement x=5mm, y=5mm, z=5mm

1 gram SAR value : 4.729 W/kg
10 gram SAR value : 3.139 W/kg
Area Scan Peak SAR : 4.915 W/kg
Zoom Scan Peak SAR : 8.583 W/kg

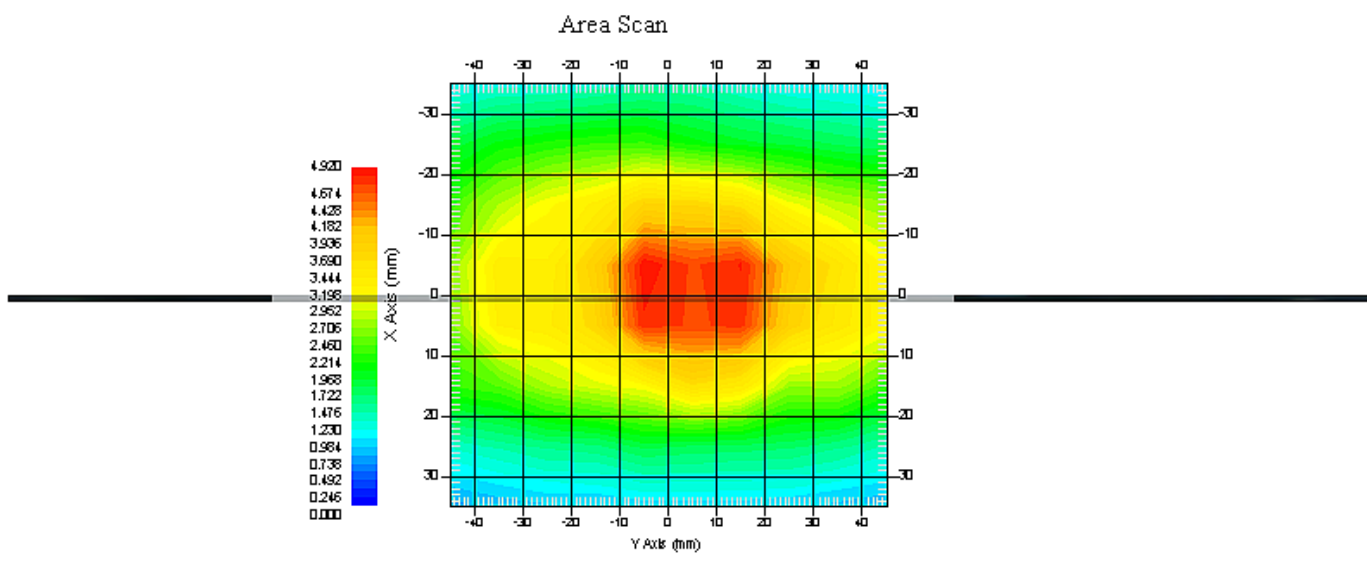

450 MHz System Verification with Head Tissue

Test Laboratory: Bay Area Compliance Lab Corp. (Shenzhen)**System Performance Check 450 MHz Liquid****Dipole 450 MHz; Type: ALS-D-450-S-2; S/N: 175-00503**

Product Data

Device Name : Dipole 450 MHz
Serial No. : 175-00503
Type : Dipole
Model : ALS-D-450-S-2
Frequency Band : 450
Max. Transmit Pwr : 1 W
Drift Time : 3 min(s)
Power Drift-Start : 4.705 W/kg
Power Drift-Finish : 4.689 W/kg
Power Drift (%) : -0.340

Phantom Data

Name : APREL-Uni
Type : Uni-Phantom
Serial No. : System Default
Location : Center
Description : Default
Phantom Data

Tissue Data

Type : Body
Serial No. : 260-01106
Frequency : 450.00MHz
Last Calib. Date : 22-Aug-2016
Temperature : 20.00 °C
Ambient Temp. : 21.00 °C
Humidity : 56.00 RH%
Epsilon : 57.45 F/m
Sigma : 0.95 S/m
Density : 1000.00 kg/cu. m

Probe Data

Name : E-Field
Model : E-020
Type : E-Field Triangle
Serial No. : 500-00283
Last Calib. Date : 14-Dec-2015
Frequency Band : 450
Duty Cycle Factor : 1
Conversion Factor : 5.8
Probe Sensitivity : 1.20 1.20 1.20 $\mu\text{V}/(\text{V}/\text{m})^2$
Compression Point : 95.00 mV
Offset : 1.56 mm

Measurement Data

Crest Factor : 1
Scan Type : Complete
Tissue Temp. : 21.00 °C
Ambient Temp. : 21.00 °C
Area Scan : 9x15x1 : Measurement x=10mm, y=10mm, z=4mm
Zoom Scan : 7x7x7 : Measurement x=5mm, y=5mm, z=5mm

1 gram SAR value : 4.952 W/kg
10 gram SAR value : 3.328 W/kg
Area Scan Peak SAR : 5.240 W/kg
Zoom Scan Peak SAR : 7.973 W/kg

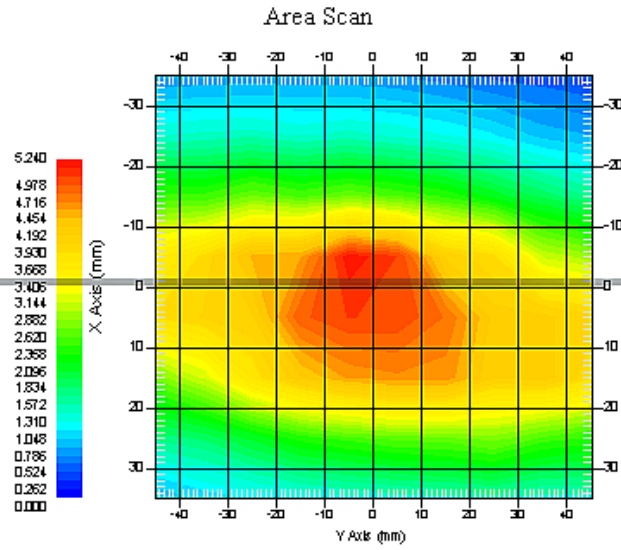

450 MHz System Verification with Body Tissue

EUT TEST STRATEGY AND METHODOLOGY

Test Positions for front-of-face configurations

A typical example of a front-of-face device is a two-way radio that is held at a distance from the face of the user when transmitting. In these cases the device under test shall be positioned at the distance to the phantom surface that corresponds to the intended use as specified by the manufacturer in the user instructions. If the intended use is not specified, a separation distance of 25 mm between the phantom surface and the device shall be used.

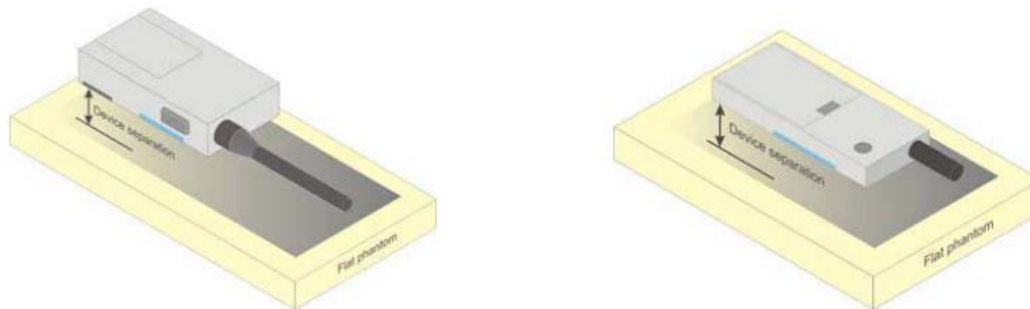

Test positions for body-worn and other configurations

Body-worn operating configurations should be tested with the belt-clips and holsters attached to the device and positioned against a flat phantom in normal use configurations. Devices with a headset output should be tested with a headset connected to the device. When multiple accessories that do not contain metallic components are supplied with the device, the device may be tested with only the accessory that dictates the closest spacing to the body. When multiple accessories that contain metallic components are supplied with the device, the device must be tested with each accessory that contains a unique metallic component. If multiple accessories share an identical metallic component (e.g., the same metallic belt-clip used with different holsters with no other metallic components), only the accessory that dictates the closest spacing to the body must be tested.

Body-worn accessories may not always be supplied or available as options for some devices that are intended to be authorized for body-worn use. A separation distance of 1.5 cm between the back of the device and a flat phantom is recommended for testing body-worn SAR compliance under such circumstances. Other separation distances may be used, but they should not exceed 2.5 cm. In these cases, the device may use body-worn accessories that provide a separation distance greater than that tested for the device provided however that the accessory contains no metallic components.

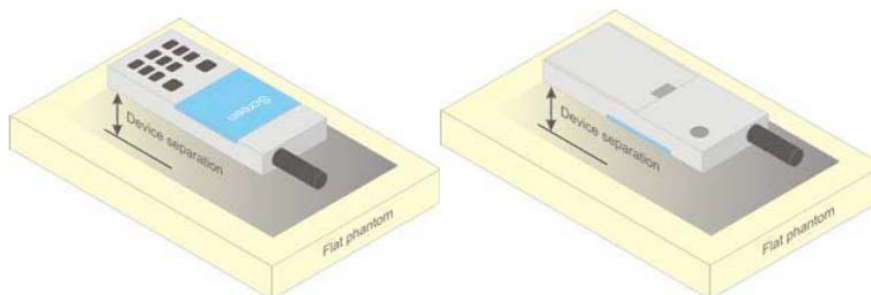

Figure 5 – Test positions for body-worn devices

For EUT Positioning Procedures

The EUT is a portable device operational at the body and face. The intended operating positions are "at the face" with the EUT at least 2.5cm from the mouth, and "at the body" by means of the offered body worn accessories. Body worn audio and PTT operation is accomplished by means of optional remote accessories that are connected to the radio.

Body

The EUT was positioned in normal use configuration against the phantom with the offered body worn accessory with the offered audio accessories as applicable

Head

Not applicable

Face

The EUT was positioned with its' front side separated 2.5cm from the phantom

SAR Evaluation Procedure

The evaluation was performed with the following procedure:

Step 1: Measurement of the SAR value at a fixed location above the ear point or central position was used as a reference value for assessing the power drop. The SAR at this point is measured at the start of the test and then again at the end of the testing.

Step 2: The SAR distribution at the exposed side of the head was measured at a distance of 4 mm from the inner surface of the shell. The area covered the entire dimension of the head or EUT and the horizontal grid spacing was 10 mm x 10 mm. Based on these data, the area of the maximum absorption was determined by spline interpolation. The first Area Scan covers the entire dimension of the EUT to ensure that the hotspot was correctly identified.

Step 3: Around this point, a volume of 30 mm x 30 mm x 30 mm was assessed by measuring 7x 7 x 7 points. On the basis of this data set, the spatial peak SAR value was evaluated under the following procedure:

- 1) The data at the surface were extrapolated, since the center of the dipoles is 1.2 mm away from the tip of the probe and the distance between the surface and the lowest measuring point is 1.3 mm. The extrapolation was based on a least square algorithm. A polynomial of the fourth order was calculated through the points in z-axes. This polynomial was then used to evaluate the points between the surface and the probe tip.
- 2) The maximum interpolated value was searched with a straightforward algorithm. Around this maximum the SAR values averaged over the spatial volumes (1 g or 10 g) were computed by the 3D-Spline interpolation algorithm. The 3D-Spline is composed of three one dimensional splines with the "Not a knot"-condition (in x, y and z-directions). The volume was integrated with the trapezoidal-algorithm. One thousand points (10 x 10 x 10) were interpolated to calculate the averages.

All neighboring volumes were evaluated until no neighboring volume with a higher average value was found.

Step 4: Re-measurement of the SAR value at the same location as in Step 1. If the value changed by more than 5%, the evaluation was repeated.

Test methodology

IEC62209-2:2010
IEEE1528:2013
KDB 447498 D01 v06
KDB 865664 D01 v01r04
KDB 643646 D01 v01r03

CONDUCTED OUTPUT POWER MEASUREMENT

Provision Applicable

The measured peak output power should be greater and within 5% than EMI measurement.

Test Procedure

The RF output of the transmitter was connected to the input of the Signal Analyzer through sufficient attenuation.

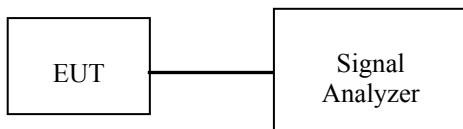

Maximum Output Power among production units

Max. tune-up tolerance power limit for Production Unit (dBm)	
PTT/Mode	Frequency(400-480MHz)
Digital-12.5K	36.99
Analog-12.5K	

Test Results:

Mode	Frequency Spacing (kHz)	Frequency (MHz)	Output(dBm)	Output Power(W)	Power level
Digital	12.5	400.0125	36.42	4.385	High
		416.0000	36.22	4.188	High
		432.0000	36.28	4.246	High
		448.0000	36.34	4.305	High
		464.0000	36.25	4.217	High
		479.9875	36.45	4.416	High
Analog	12.5	400.0125	36.36	4.325	High
		416.0000	36.15	4.121	High
		432.0000	36.27	4.236	High
		448.0000	36.14	4.111	High
		464.0000	36.21	4.178	High
		479.9875	36.42	4.385	High

SAR MEASUREMENT RESULTS

This page summarizes the results of the performed dosimetric evaluation.

SAR Test Data

Environmental Conditions

Temperature:	21 °C
Relative Humidity:	50%
ATM Pressure:	1002 mbar

* Testing was performed by Hans zhao and Sanjay wang on 2016-08-22.

Test Result:

Digital (Modulation 4FSK; Channel Spacing 12.5 kHz):

Frequency (MHz)	Antenna	Power Drift (%)	Max. Meas. Power (dBm)	Max. Rated Power (dBm)	1 g SAR Value(W/Kg)				
					Scaled Factor	Meas. SAR	Scaled SAR	50%	Plot
Face up (2.5cm)									
400.0125	400-480MHz	-1.337	36.42	36.99	1.140	1.995	2.275	1.137	/
416.0000	400-480MHz	-3.610	36.22	36.99	1.194	1.895	2.263	1.131	/
432.0000	400-480MHz	0.808	36.28	36.99	1.178	1.957	2.305	1.152	/
448.0000	400-480MHz	-1.625	36.34	36.99	1.161	2.012	2.337	1.168	/
464.0000	400-480MHz	-3.641	36.25	36.99	1.186	2.001	2.373	1.186	/
479.9875	400-480MHz	-0.909	36.45	36.99	1.132	2.438	2.761	1.380	1#
Body-Back with Belt Clip(0.0cm)									
400.0125	400-480MHz	4.297	36.42	36.99	1.140	2.952	3.366	1.683	/
416.0000	400-480MHz	4.839	36.22	36.99	1.194	2.998	3.580	1.790	/
432.0000	400-480MHz	4.413	36.28	36.99	1.178	2.897	3.412	1.706	/
448.0000	400-480MHz	3.255	36.34	36.99	1.161	3.011	3.497	1.749	/
464.0000	400-480MHz	3.327	36.25	36.99	1.186	3.025	3.587	1.793	/
479.9875	400-480MHz	-1.203	36.45	36.99	1.132	3.448	3.905	1.952	2#

Analog (Modulation FM; Channel Spacing 12.5 kHz):

Frequency (MHz)	Antenna	Power Drift (%)	Max. Meas. Power (dBm)	Max. Rated Power (dBm)	1 g SAR Value(W/Kg)				
					Scaled Factor	Meas. SAR	Scaled SAR	50%	Plot
Face up (2.5cm)									
400.0125	400-480MHz	-2.570	36.36	36.99	1.156	4.275	4.942	2.471	/
416.0000	400-480MHz	0.044	36.15	36.99	1.213	4.357	5.287	2.643	/
432.0000	400-480MHz	-0.848	36.27	36.99	1.180	4.158	4.908	2.454	/
448.0000	400-480MHz	-4.639	36.14	36.99	1.216	4.258	5.179	2.589	/
464.0000	400-480MHz	-1.952	36.21	36.99	1.197	4.223	5.054	2.527	/
479.9875	400-480MHz	1.776	36.42	36.99	1.140	4.987	5.686	2.843	3#
Body-Back with Belt Clip(0.0cm)									
400.0125	400-480MHz	-4.629	36.36	36.99	1.156	5.079	5.872	2.936	/
416.0000	400-480MHz	-0.814	36.15	36.99	1.213	5.239	6.357	3.178	/
432.0000	400-480MHz	1.721	36.27	36.99	1.180	5.159	6.089	3.045	/
448.0000	400-480MHz	3.254	36.14	36.99	1.216	5.223	6.352	3.176	/
464.0000	400-480MHz	-1.680	36.21	36.99	1.197	5.589	6.689	3.344	/
479.9875	400-480MHz	-1.932	36.42	36.99	1.140	6.080	6.933	3.466	4#

Note:

1. When the 1-g SAR tested using the default battery and default accessories is $\leq 3.5W/Kg$ (corrected by Multiplying 50% for FM mode), testing for other channels are optional.
2. For a analog PTT, only simplex communication technology was supported, so the SAR value need to be corrected by Multiplying 50%.
3. The frequencies points result in highest SAR value were selected to test.
4. Passive body-worn and audio accessories generally do not apply to the head SAR of PTT radios.
5. The whole antenna and radiating structures that may contribute to the measured SAR or influence the SAR distribution has been included in the area scan.
6. There are four types of audio accessory belong the PTT. One of them was selected as default audio accessory for SAR test. The default audio accessory fully support all the test configurations required.

SAR Plots (Summary of the Highest SAR Values)

Test Laboratory: Bay Area Compliance Lab Corp. (Shenzhen)

Face-Up 2.5cm (Digital 12.5k-479.9875 MHz)

Measurement Data

Modulation mode : 4FSK
 Crest Factor : 2
 Scan Type : Complete
 Area Scan : 11x9x1: Measurement x=10mm, y=10mm, z=4mm
 Zoom Scan : 7x7x7: Measurement x=5mm, y=5mm, z=5mm
 Power Drift-Start : 2.442 W/kg
 Power Drift-Finish : 2.403 W/kg
 Power Drift (%) : -0.909

Tissue Data

Type : Head
 Frequency : 479.9875 MHz
 Epsilon : 43.59 F/m
 Sigma : 0.90 S/m
 Density : 1000.00 kg/cu. m

Probe Data

Serial No. : 500-00283
 Frequency Band : 450
 Duty Cycle Factor : 2
 Conversion Factor : 5.7
 Probe Sensitivity : 1.20 1.20 1.20 $\mu\text{V}/(\text{V}/\text{m})^2$
 Compression Point : 95.00 mV
 Offset : 1.56 mm

1 gram SAR value : 2.438 W/kg
 10 gram SAR value : 1.552 W/kg
 Area Scan Peak SAR : 2.840 W/kg
 Zoom Scan Peak SAR : 3.316 W/kg

Plot 1#

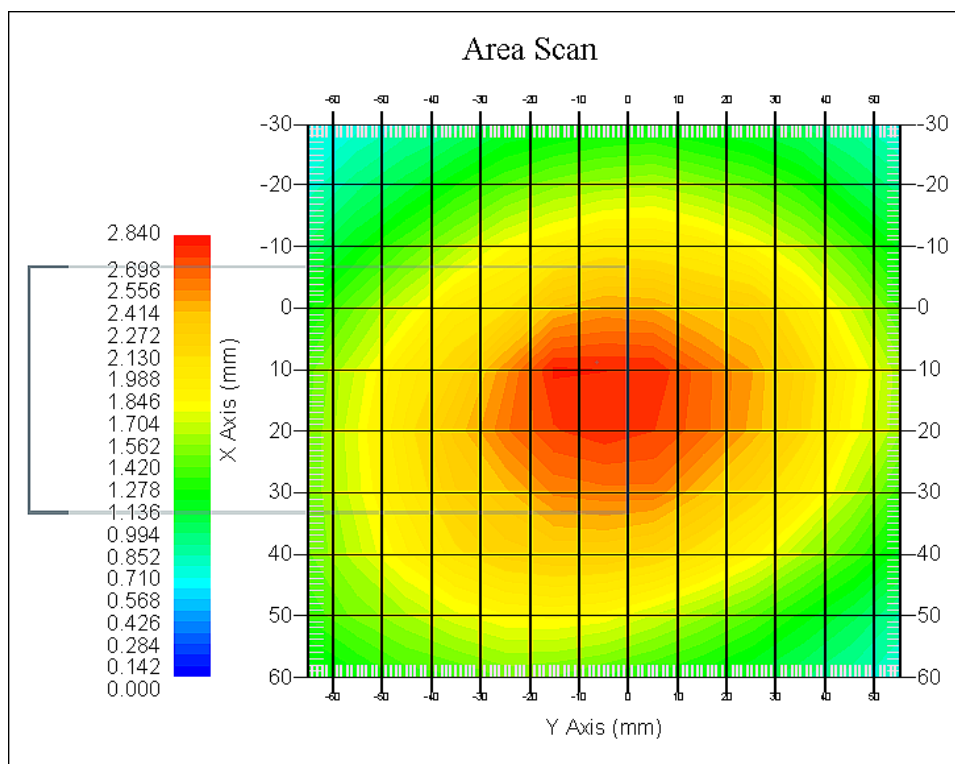

Test Laboratory: Bay Area Compliance Lab Corp. (Shenzhen)

Back-Worn 0.0cm (Digital 12.5k-479.9875 MHz)

Measurement Data

Modulation mode : 4FSK
 Crest Factor : 2
 Scan Type : Complete
 Area Scan : 11x9x1: Measurement x=10mm, y=10mm, z=4mm
 Zoom Scan : 7x7x7: Measurement x=5mm, y=5mm, z=5mm
 Power Drift-Start : 2.993 W/kg
 Power Drift-Finish : 2.957 W/kg
 Power Drift (%) : -1.203

Tissue Data

Type : Body
 Frequency : 479.9875 MHz
 Epsilon : 56.87 F/m
 Sigma : 0.95 S/m
 Density : 1000.00 kg/cu. m

Probe Data

Serial No. : 500-00283
 Frequency Band : 450
 Duty Cycle Factor : 2
 Conversion Factor : 5.8
 Probe Sensitivity : 1.20 1.20 1.20 $\mu\text{V}/(\text{V}/\text{m})^2$
 Compression Point : 95.00 mV
 Offset : 1.56 mm

1 gram SAR value : 3.448 W/kg
 10 gram SAR value : 1.897 W/kg
 Area Scan Peak SAR : 3.560 W/kg
 Zoom Scan Peak SAR : 5.227 W/kg

Plot 2#

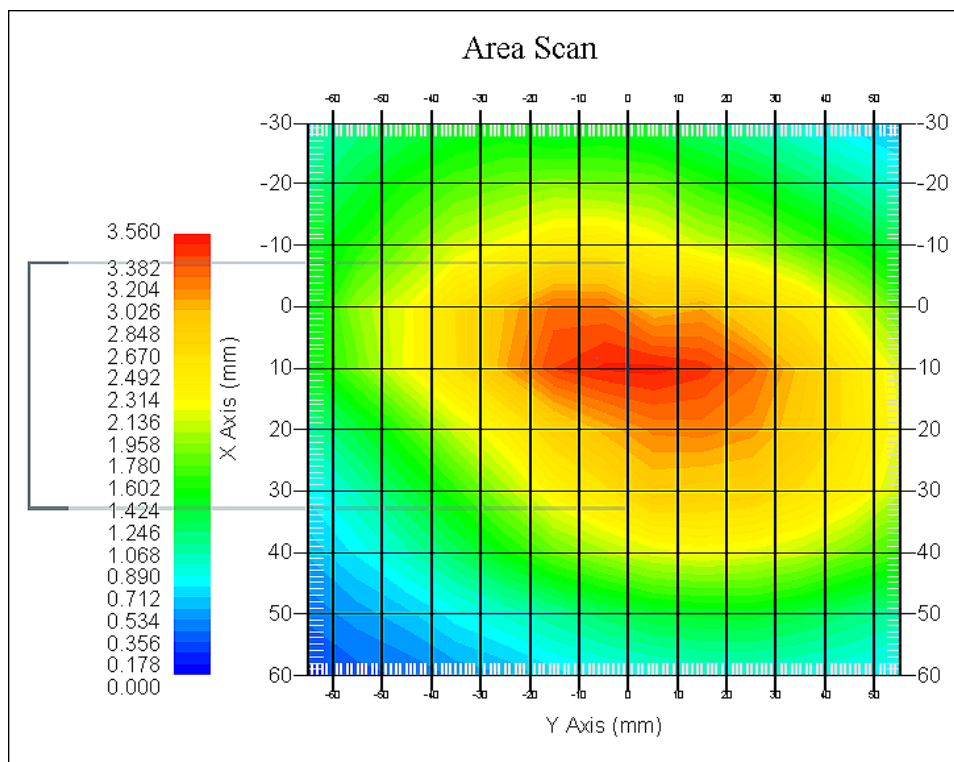

Test Laboratory: Bay Area Compliance Lab Corp. (Shenzhen)

Face-Up 2.5cm (Analog 12.5k-479.9875 MHz)

Measurement Data

Modulation mode : FM
 Crest Factor : 1
 Scan Type : Complete
 Area Scan : 11x9x1: Measurement x=10mm, y=10mm, z=4mm
 Zoom Scan : 7x7x7: Measurement x=5mm, y=5mm, z=5mm
 Power Drift-Start : 4.448 W/kg
 Power Drift-Finish : 4.527 W/kg
 Power Drift (%) : 1.776

Tissue Data

Type : Head
 Frequency : 479.9875 MHz
 Epsilon : 43.59 F/m
 Sigma : 0.90 S/m
 Density : 1000.00 kg/cu. m

Probe Data

Serial No. : 500-00283
 Frequency Band : 450
 Duty Cycle Factor : 1
 Conversion Factor : 5.7
 Probe Sensitivity : 1.20 1.20 1.20 $\mu\text{V}/(\text{V}/\text{m})^2$
 Compression Point : 95.00 mV
 Offset : 1.56 mm

1 gram SAR value : 4.987 W/kg
 10 gram SAR value : 2.851 W/kg
 Area Scan Peak SAR : 5.200 W/kg
 Zoom Scan Peak SAR : 7.518 W/kg

Plot 3#

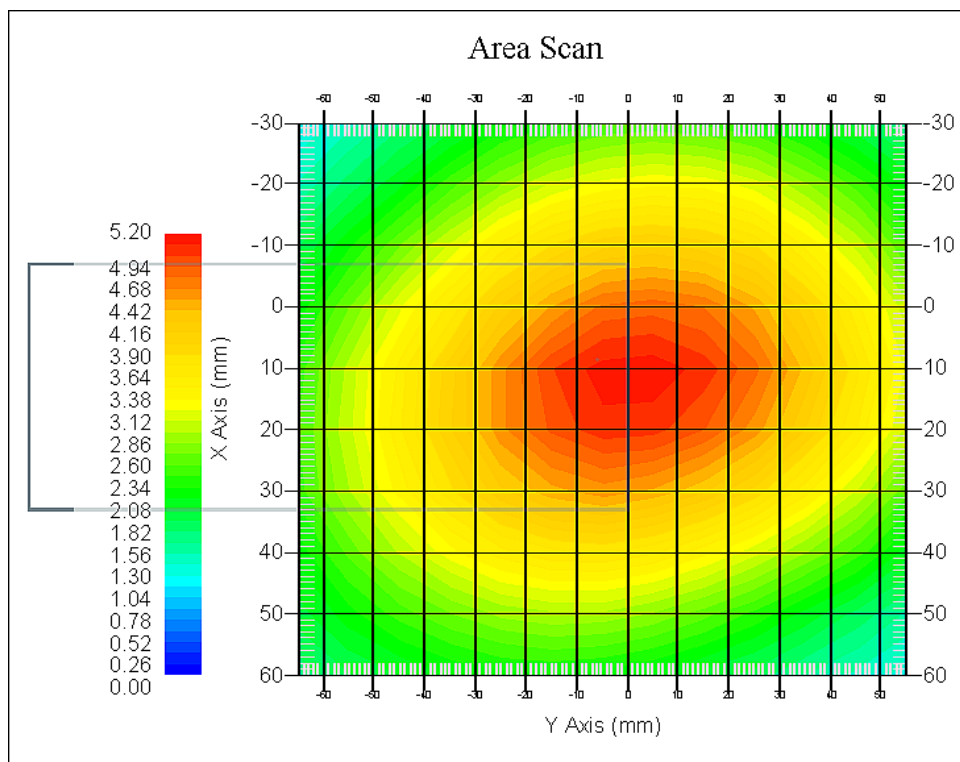

Test Laboratory: Bay Area Compliance Lab Corp. (Shenzhen)

Back-Worn 0.0cm (Analog 12.5k-479.9875 MHz)

Measurement Data

Modulation mode : FM
 Crest Factor : 1
 Scan Type : Complete
 Area Scan : 11x9x1: Measurement x=10mm, y=10mm, z=4mm
 Zoom Scan : 7x7x7: Measurement x=5mm, y=5mm, z=5mm
 Power Drift-Start : 5.331 W/kg
 Power Drift-Finish : 5.228 W/kg
 Power Drift (%) : -1.932

Tissue Data

Type : Body
 Frequency : 479.9875 MHz
 Epsilon : 56.87 F/m
 Sigma : 0.95 S/m
 Density : 1000.00 kg/cu. m

Probe Data

Serial No. : 500-00283
 Frequency Band : 450
 Duty Cycle Factor : 1
 Conversion Factor : 5.8
 Probe Sensitivity : 1.20 1.20 1.20 $\mu\text{V}/(\text{V}/\text{m})^2$
 Compression Point : 95.00 mV
 Offset : 1.56 mm

1 gram SAR value : 6.080 W/kg
 10 gram SAR value : 3.267 W/kg
 Area Scan Peak SAR : 6.240 W/kg
 Zoom Scan Peak SAR : 8.911 W/kg

Plot 4#

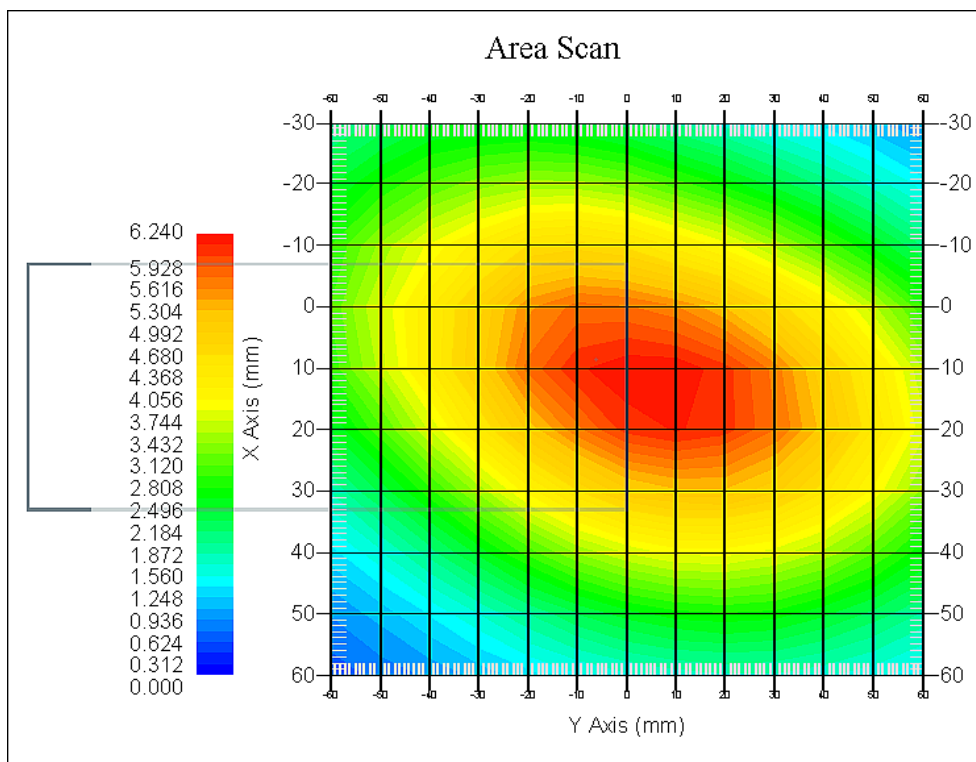

APPENDIX A – MEASUREMENT UNCERTAINTY

According to **IEEE1528:2013**, the uncertainty budget has been determined for the Head SAR measurement system and is given in the following Table.

Source of Uncertainty	Tolerance Value	Probability Distribution	Divisor	c_i^1 (1-g)	c_i^1 (10-g)	Standard Uncertainty (1-g) %	Standard Uncertainty (10-g) %
Measurement System							
Probe Calibration	3.5	normal	1	1	1	3.5	3.5
Axial Isotropy	3.7	rectangular	$\sqrt{3}$	$(1-cp)^{1/2}$	$(\frac{1-cp}{2})^1$	1.5	1.5
Hemispherical Isotropy	10.9	rectangular	$\sqrt{3}$	\sqrt{cp}	\sqrt{cp}	4.4	4.4
Boundary Effect	1.0	rectangular	$\sqrt{3}$	1	1	0.6	0.6
Linearity	4.7	rectangular	$\sqrt{3}$	1	1	2.7	2.7
Detection Limit	1.0	rectangular	$\sqrt{3}$	1	1	0.6	0.6
Readout Electronics	1.0	normal	1	1	1	1.0	1.0
Response Time	0.8	rectangular	$\sqrt{3}$	1	1	0.5	0.5
Integration Time	1.7	rectangular	$\sqrt{3}$	1	1	1.0	1.0
RF Ambient Condition -Noise	0.6	rectangular	$\sqrt{3}$	1	1	0.3	0.3
RF Ambient Condition - Reflections	3.0	rectangular	$\sqrt{3}$	1	1	1.7	1.7
Probe Positioner Mech. Restrictions	0.4	rectangular	$\sqrt{3}$	1	1	0.2	0.2
Probe Positioning with respect to Phantom Shell	2.9	rectangular	$\sqrt{3}$	1	1	1.7	1.7
Extrapolation and Integration	3.7	rectangular	$\sqrt{3}$	1	1	2.1	2.1
Test sample related							
Test sample positioning	2.0	normal	1	1	1	2.0	2.0
Device Holder Uncertainty	4.0	normal	1	1	1	6.215	6.215
Drift of Output Power	5.0	rectangular	$\sqrt{3}$	1	1	2.67	2.67
Phantom and Setup							
Phantom Uncertainty	3.4	rectangular	$\sqrt{3}$	1	1	2.0	2.0
SAR correction in permittivity and conductivity	1.2	normal	1	1	0.85	1.2	1.0
Liquid conductivity measurement	5.0	normal	1	0.78	0.71	3.9	3.6
Liquid permittivity measurement	5.0	normal	1	0.25	0.29	1.3	1.5
conductivity—temperature	1.1	rectangular	$\sqrt{3}$	0.78	0.71	0.5	0.5
permittivity—temperature	1.3	rectangular	$\sqrt{3}$	0.23	0.23	0.2	0.2
Combined Uncertainty		RSS				10.78	10.55
Expanded uncertainty (coverage factor=2)		Normal(k=2)				21.56	21.10

According to **IEC62209-2:2010**, the uncertainty budget has been determined for the Body SAR measurement system and is given in the following Table.

Source of Uncertainty	Tolerance Value	Probability Distribution	Divisor	c_i^1 (1-g)	c_i^1 (10-g)	Standard Uncertainty (1-g) %	Standard Uncertainty (10-g) %
Measurement System							
Probe Calibration	3.5	normal	1	1	1	3.5	3.5
Axial Isotropy	3.7	rectangular	$\sqrt{3}$	1	1	1.5	1.5
Boundary Effect	1.0	rectangular	$\sqrt{3}$	1	1	0.6	0.6
Linearity	4.7	rectangular	$\sqrt{3}$	1	1	2.7	2.7
Detection Limit	1.0	rectangular	$\sqrt{3}$	1	1	0.6	0.6
Readout Electronics	1.0	normal	1	1	1	1.0	1.0
Response Time	0.8	rectangular	$\sqrt{3}$	1	1	0.5	0.5
Integration Time	1.7	rectangular	$\sqrt{3}$	1	1	1.0	1.0
RF Ambient Condition -Noise	0.6	rectangular	$\sqrt{3}$	1	1	0.3	0.3
RF Ambient Condition - Reflections	3.0	rectangular	$\sqrt{3}$	1	1	1.7	1.7
Probe Positioner Mech. Restrictions	0.4	rectangular	$\sqrt{3}$	1	1	0.2	0.2
Probe Positioning with respect to Phantom Shell	2.9	rectangular	$\sqrt{3}$	1	1	1.7	1.7
Extrapolation and Integration	3.7	rectangular	$\sqrt{3}$	1	1	2.1	2.1
Test sample related							
Test sample positioning	2.0	normal	1	1	1	2.0	2.0
Device Holder Uncertainty	4.0	normal	1	1	1	6.215	6.215
Drift of Output Power	5.0	rectangular	$\sqrt{3}$	1	1	2.67	2.67
Phantom and Setup							
Phantom Uncertainty	3.4	rectangular	$\sqrt{3}$	1	1	2.0	2.0
SAR correction in permittivity and conductivity	1.2	normal	1	1	0.84	1.2	1.0
Liquid conductivity measurement	5.0	normal	1	0.78	0.71	3.9	3.6
Liquid permittivity measurement	5.0	normal	1	0.23	0.26	1.3	1.5
conductivity—temperature	1.1	rectangular	$\sqrt{3}$	0.78	0.71	0.5	0.5
permittivity—temperature	1.3	rectangular	$\sqrt{3}$	0.23	0.26	0.2	0.2
Combined Uncertainty		RSS				9.58	9.49
Expanded uncertainty (coverage factor=2)		Normal(k=2)				19.16	18.98

APPENDIX B – PROBE CALIBRATION CERTIFICATES

NCL CALIBRATION LABORATORIES

Calibration File No.: PC-1654

Task No: BACL-5805

CERTIFICATE OF CALIBRATION

It is certified that the equipment identified below has been calibrated in the **NCL CALIBRATION LABORATORIES** by qualified personnel following recognized procedures and using transfer standards traceable to NRC/NIST.

Equipment: Miniature Isotropic RF Probe

Record of Calibration

Head and Body

Manufacturer: APREL Inc.

Model No.: ALS-E020

Serial No.: 500-00283

Calibration Procedure: D01-032-E020-V2, D22-012-Tissue, D28-002-Dipole
Project No: BACL-5805

Calibrated: 12th December 2015
Released on: 14th December 2015

This Calibration Certificate is Incomplete Unless Accompanied with the Calibration Results Summary

Released By: _____



Art Brennan, Quality Manager

NCL CALIBRATION LABORATORIES

Suite 102, 303 Terry Fox Dr,
OTTAWA, ONTARIO
CANADA K2K 3J1

Division of APREL Lab.
TEL: (613) 435-8300
FAX: (613) 435-8306

NCL Calibration Laboratories

Division of APREL, Inc.

Introduction

This Calibration Report reproduces the results of the calibration performed in line with the references listed below. Calibration is performed using accepted methodologies as per the references listed below. Probes are calibrated for air, and tissue and the values reported are the results from the physical quantification.

Calibration Method

Probes are calibrated using the following methods.

<800 MHz

TEM Cell for sensitivity in air

Standard phantom using temperature transfer method for sensitivity in tissue

>800 MHz

Waveguide* method to determine sensitivity in air and tissue

*Waveguide is numerically (simulation) assessed to determine the field distribution and power

The boundary effect for the probe is assessed using a standard flat phantom where the probe output is compared against a numerically simulated series of data points

References

- IEEE Standard 1528:2013
IEEE Recommended Practice for Determining the Peak Spatial-Average Specific Absorption Rate (SAR) in the Human Head from Wireless Communications Devices: Measurement Techniques
- IEC 62209-1:2006
Human Exposure to RF Fields from hand-held and body-mounted wireless communication devices - Human models, instrumentation, and procedures - Part 1: Procedure to measure the Specific Absorption Rate (SAR) for hand-held mobile wireless devices
- IEC 62209-2:2010
Human exposure to RF fields from hand-held and body-mounted wireless devices - Human models, instrumentation, and procedures - Part 2: specific absorption rate (SAR) for wireless communication devices (30 MHz - 6 GHz)
- TP-D01-032-E020-V2 E-Field probe calibration procedure
- D22-012-Tissue dielectric tissue calibration procedure
- D28-002-Dipole procedure for validation of SAR system using a dipole
- IEEE 1309 Standard for Calibration of Electromagnetic Field Sensors and Probes, Excluding Antennas, from 9kHz to 40GHz

NCL Calibration Laboratories

Division of APREL Inc.

Conditions

Probe 500-00283 was a recalibration.

Ambient Temperature of the Laboratory: 20 °C +/- 1.5°C
Temperature of the Tissue: 21 °C +/- 1.5°C
Relative Humidity: < 60%

Primary Measurement Standards

Instrument	Serial Number	Cal due date
Power Meter Tektronix USB	11C940	Apr 2, 2017
Signal Generator Agilent E4438C	MY45094463	Dec 11, 2017

Secondary Measurement Standards

Network Analyzer Anritsu 37347C	002106	Feb. 4, 2017
---------------------------------	--------	--------------

Attestation

The below named signatories have conducted the calibration and review of the data which is presented in this calibration report.

We the undersigned attest that to the best of our knowledge the calibration of this subject has been accurately conducted and that all information contained within the results pages have been reviewed for accuracy.



Art Brennan, Quality Manager



Dan Brooks, Test Engineer

NCL Calibration Laboratories

Division of APREL, Inc.

Probe Summary

Probe Type: E-Field Probe E-020
Serial Number: 500-00283
Frequency: As presented on page 5
Sensor Offset: 1.56
Sensor Length: 2.5
Tip Enclosure: Composite*
Tip Diameter: < 2.9 mm
Tip Length: 55 mm
Total Length: 289 mm
Diode Compression Point: 95 mV

Sensitivity in Air

Frequency Range	Channel X, μV/(V/m) ²	Channel Y, μV/(V/m) ²	Channel Z, μV/(V/m) ²	Tolerance, μV/(V/m) ²
450 MHz	1.212	1.205	1.199	±0.004
750 MHz, 835 MHz 900 MHz	1.212	1.21	1.209	±0.004
1 GHz – 4 GHz	1.21	1.21	1.207	±0.004
5 GHz – 6 GHz	1.2	1.192	1.19	±0.005

*Resistive to recommended tissue recipes per IEEE-1528

NCL Calibration Laboratories

Division of APREL, Inc.

Calibration for Tissue (Head H, Body B)

Frequency	Tissue Type	Measured Epsilon	Measured Sigma	Standard Uncertainty (%)	Calibration Frequency Range (MHz)	Conversion Factor
450 H	Head	43.5	0.84	3.5	±50	5.7
450 B	Body	56.77	0.93	3.5	±50	5.8
750 H	Head	42.92	0.92	3.5	±50	6.0
750 B	Body	55.57	0.93	3.5	±50	5.9
835 H	Head	43.44	0.94	3.5	±50	5.9
835 B	Body	54.91	1.00	3.5	±50	5.9
900 H	Head	41.05	1.01	3.5	±50	6.0
900 B	Body	54.86	1.04	3.5	±50	5.9
1450 H	Head	X	X	X	X	X
1450 B	Body	X	X	X	X	X
1500 H	Head	X	X	X	X	X
1500 B	Body	X	X	X	X	X
1640 H	Head	X	X	X	X	X
1640 B	Body	X	X	X	X	X
1750 H	Head	38.58	1.36	3.5	±75	5.4
1750 B	Body	51.5	1.52	3.5	±75	5.3
1800 H	Head	X	X	X	X	X
1800 B	Body	X	X	X	X	X
1900 H	Head	40.72	1.37	3.5	±75	4.8
1900 B	Body	52.29	1.58	3.5	±75	4.8
2000 H	Head	X	X	X	X	X
2000 B	Body	X	X	X	X	X
2100 H	Head	X	X	X	X	X
2100 B	Body	X	X	X	X	X
2300 H	Head	X	X	X	X	X
2300 B	Body	X	X	X	X	X
2450 H	Head	37.35	1.85	3.5	±75	4.8
2450 B	Body	53.26	1.96	3.5	±75	4.3
3000 H	Head	X	X	X	X	X
3000 B	Body	X	X	X	X	X
3600 H	Head	37.24	3.14	3.5	±100	4.4
3600 B	Body	50.23	3.81	3.5	±100	4.1
5250 H	Head	35.05	4.65	3.5	±100	3.1
5250 B	Body	46.24	5.11	3.5	±100	2.9
5600 H	Head	34.95	5.06	3.5	±100	3.0
5600 B	Body	45.95	5.73	3.5	±100	2.4
5800 H	Head	34.57	5.27	3.5	±100	3.1
5800 B	Body	46.01	6.10	3.5	±100	2.6

NCL Calibration Laboratories

Division of APREL, Inc.

Boundary Effect:

Uncertainty resulting from the boundary effect is less than 2.1% for the distance between the tip of the probe and the tissue boundary, when less than 0.58mm.

Spatial Resolution:

The spatial resolution uncertainty is less than 1.5% for 4.9mm diameter probe.
 The spatial resolution uncertainty is less than 1.0% for 2.5mm diameter probe.

DAQ-PAQ Contribution

To minimize the uncertainty calculation all tissue sensitivity values were calculated using a load impedance of 5 MΩ.

Probe Calibration Uncertainty

Uncertainty component	Tolerance (± %)	Probability distribution	Divisor	Standard uncertainty (± %)
Incident or forward power	2.5	R	√3	1.44
Reflected power	2	R	√3	1.15
Liquid conductivity measurement	1	R	√3	0.58
Liquid permittivity measurement	1	R	√3	0.58
Liquid conductivity deviation	1.5	R	√3	0.87
Liquid permittivity deviation	1.5	R	√3	0.87
Frequency deviation	2.25	R	√3	1.30
Field homogeneity	2.5	R	√3	1.44
Field-probe positioning	2.5	R	√3	1.44
Field-probe linearity	1.55	R	√3	0.89
Combined standard uncertainty		RSS		3.50

NCL Calibration Laboratories

Division of APREL, Inc.

Receiving Pattern Air

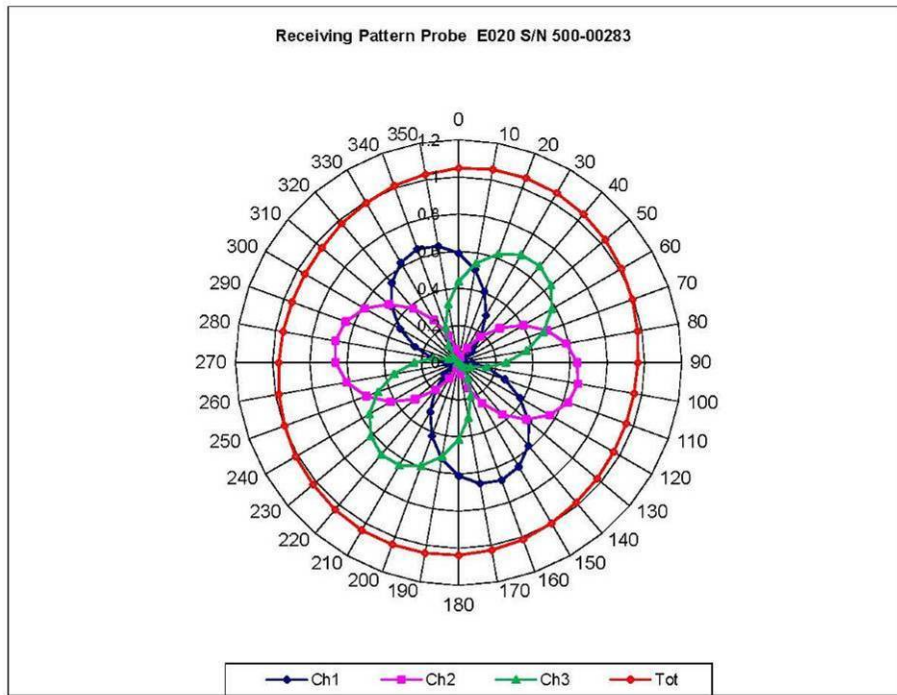

NCL Calibration Laboratories

Division of APREL, Inc.

Isotropy Error Air

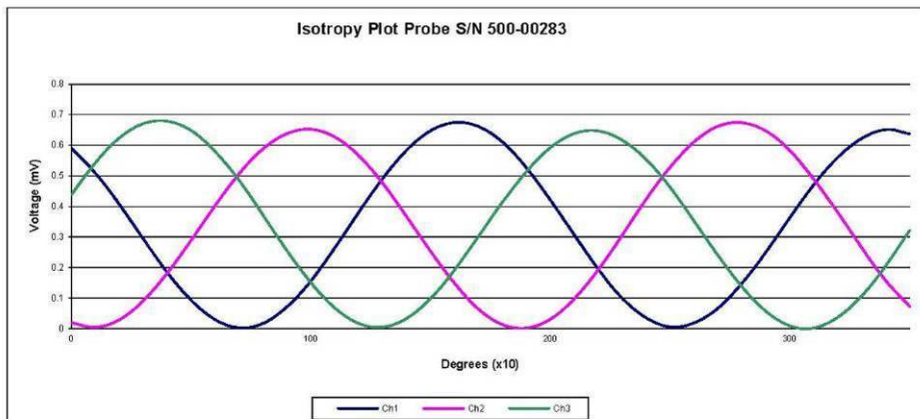
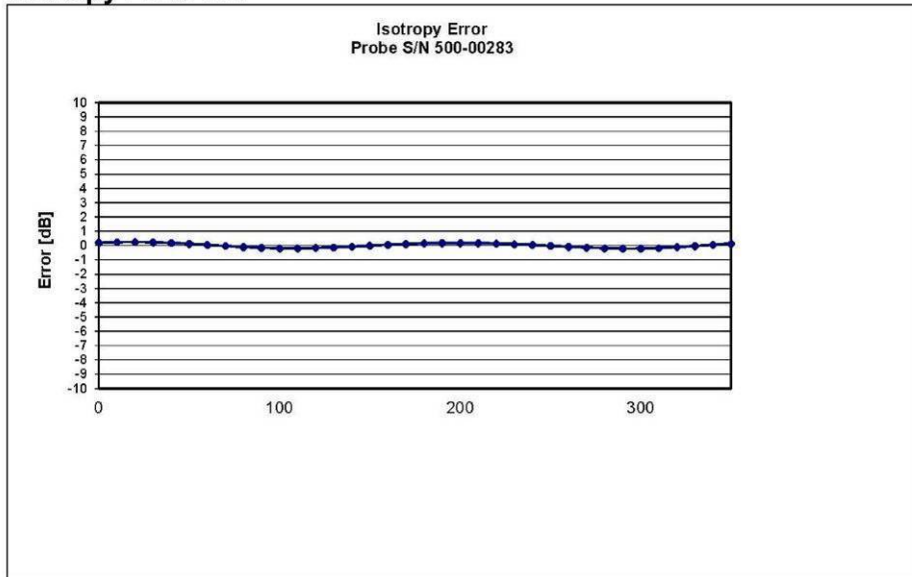

NCL Calibration Laboratories

Division of APREL, Inc.

Dynamic Range

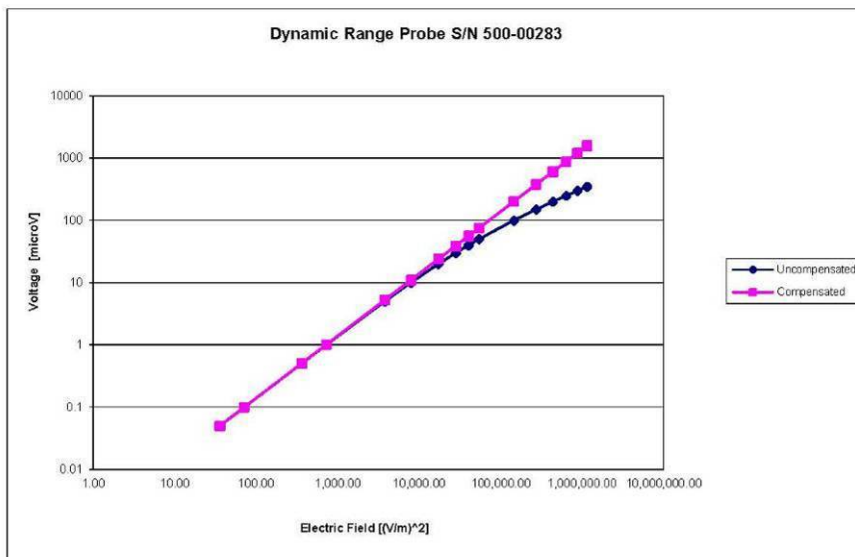

Video Bandwidth

Probe Frequency Characteristics

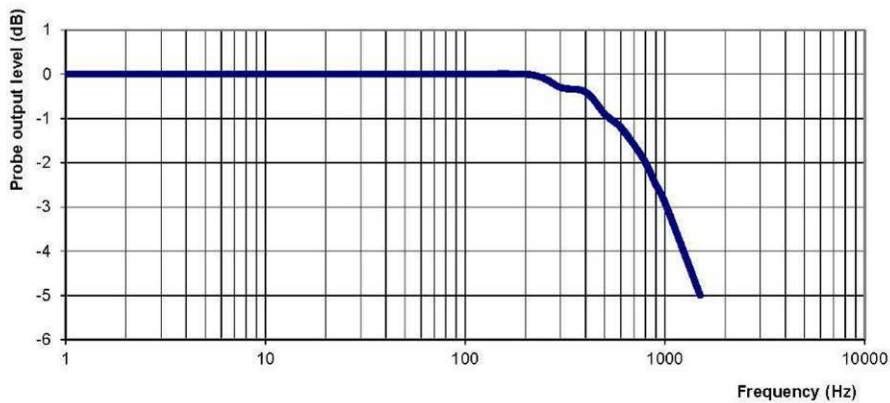

Video Bandwidth at 500 Hz 1 dB
Video Bandwidth at 1.02 KHz: 3 dB

Page 9 of 10
 This page has been reviewed for content and attested to on Page 2 of this document.

Probe S/N 500-00283

ANNEX

PROBE ALS-E020 S/N 500-00283 CALIBRATION

Conditions

Ambient Temperature of the laboratory: 20 °C +/- 1.5°C
 Temperature of the Tissue: 21 °C +/- 1.5°C
 Relative Humidity: < 55%

Frequency	Tissue Type	Measured Epsilon	Measured Sigma	Standard Uncertainty (%)	Calibration Frequency Range (MHz)	Conversion Factor
150 H	Head	50.6	0.78	3.5	±50	6.0
150 B	Body	60.8	0.82	3.5	±50	6.0

Probe Calibration Uncertainty

Uncertainty component	Tolerance (± %)	Probability distribution	Divisor	Standard uncertainty (± %)
Incident or forward power	2.5	R	√3	1.44
Reflected power	2	R	√3	1.15
Liquid conductivity measurement	1	R	√3	0.58
Liquid permittivity measurement	1	R	√3	0.58
Liquid conductivity deviation	1.5	R	√3	0.87
Liquid permittivity deviation	1.5	R	√3	0.87
Frequency deviation	2.25	R	√3	1.30
Field homogeneity	2.5	R	√3	1.44
Field-probe positioning	2.5	R	√3	1.44
Field-probe linearity	1.55	R	√3	0.89
Combined standard uncertainty		RSS		3.50

APPENDIX C – DIPOLE CALIBRATION CERTIFICATES

NCL CALIBRATION LABORATORIES

Calibration File No: DC-1534
Project Number: BACL-5745

CERTIFICATE OF CALIBRATION

It is certified that the equipment identified below has been calibrated in the
NCL CALIBRATION LABORATORIES by qualified personnel following recognized
procedures and using transfer standards traceable to NRC/NIST.

Validation Dipole

Manufacturer: APREL Laboratories
Part number: ALS-D-450-S-2
Frequency: 450 MHz
Serial No: **175-00503**

Customer: Bay Area Compliance
Head and Body Calibration

Calibrated: 8th October 2013
Released on: 8th October 2013

This Calibration Certificate is Incomplete Unless Accompanied with the Calibration Results Summary

Released By: _____



Art Brennan, Quality Manager

NCL CALIBRATION LABORATORIES

303 Terry Fox Drive, Suite 102
Kanata, Ontario
CANADA K2K 3J1

Division of APREL
TEL: (613) 435-8300
FAX: (613) 435-8306

NCL Calibration Laboratories

Division of APREL Laboratories.

Conditions

Dipole 175-00503 was taken from stock for an original calibration..

Ambient Temperature of the Laboratory: 22 °C +/- 0.5°C

Temperature of the Tissue: 21 °C +/- 0.5°C

We the undersigned attest that to the best of our knowledge the calibration of this subject has been accurately conducted and that all information contained within the results pages have been reviewed for accuracy.



Art Brennan, Quality Manager



Dan Brooks, Test Engineer

Calibration Results Summary

The following results relate the Calibrated Dipole and should be used as a quick reference for the user.

Mechanical Dimensions

Length: 270.0 mm

Height: 166.7 mm

Electrical Specification

	Head	Body
Return Loss	-30.726 dB	-33.258 dB
SWR	1.061 U	1.049 U
Impedance	50.600 Ω	48.155 Ω

This page has been reviewed for content and attested to by signature within this document.

NCL Calibration Laboratories

Division of APREL Laboratories.

System Validation Results Head

Frequency	1 Gram	10 Gram	Peak
450 MHz	4.572	2.952	6.746

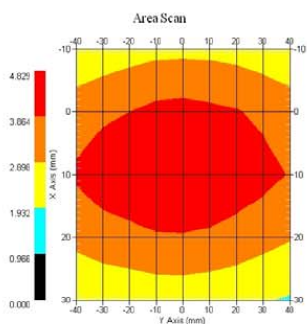

System Validation Results Body

Frequency	1 Gram	10 Gram	Peak
450 MHz	4.508	2.959	6.656

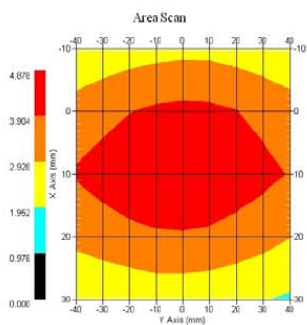

This page has been reviewed for content and attested to by signature within this document.

NCL Calibration Laboratories

Division of APREL Laboratories.

Introduction

This Calibration Report has been produced in line with the SSI Dipole Calibration Procedure SSI-TP-018-ALSAS. The results contained within this report are for Validation Dipole RFE-362. The calibration routine consisted of a three-step process. Step 1 was a mechanical verification of the dipole to ensure that it meets the mechanical specifications. Step 2 was an Electrical Calibration for the Validation Dipole, where the SWR, Impedance, and the Return loss were assessed. Step 3 involved a System Validation using the ALSAS-10U, along with APREL E-020 130 MHz to 26 GHz E-Field Probe Serial Number 212.

References

SSI-TP-018-ALSAS Dipole Calibration Procedure
SSI-TP-016 Tissue Calibration Procedure
IEEE 1528 "Recommended Practice for Determining the Peak Spatial-Average Specific Absorption Rate (SAR) in the Human Body Due to Wireless Communications Devices: Experimental Techniques"

Conditions

Original calibration.

Ambient Temperature of the Laboratory: 22 °C +/- 0.5°C
Temperature of the Tissue: 20 °C +/- 0.5°C

This page has been reviewed for content and attested to by signature within this document.

4

NCL Calibration Laboratories

Division of APREL Laboratories.

Dipole Calibration Results

Mechanical Verification

APREL Length	APREL Height	Measured Length	Measured Height
280.0 mm	166.7 mm	280.0 mm	166.0 mm

Tissue Validation

Body Tissue 450MHz	Measured Head	Measured Body
Dielectric constant, ϵ_r	43.98	57.07
Conductivity, σ [S/m]	0.9	0.92

Dipole Calibration uncertainty

The calibration uncertainty for the dipole is made up of various parameters presented below.

Mechanical	1%
Positioning Error	1.22%
Electrical	1.7%
Tissue	2.2%
Dipole Validation	2.2%
TOTAL	8.32% (16.64% K=2)

This page has been reviewed for content and attested to by signature within this document.

NCL Calibration Laboratories

Division of APREL Laboratories.

Electrical Calibration

Test	Result Head	Result Body
S11 R/L	-30.726 dB	-33.258 dB
SWR	1.061 U	1.049 U
Impedance	50.600 Ω	48.155 Ω

The Following Graphs are the results as displayed on the Vector Network Analyzer.

S11 Parameter Return Loss

HEAD

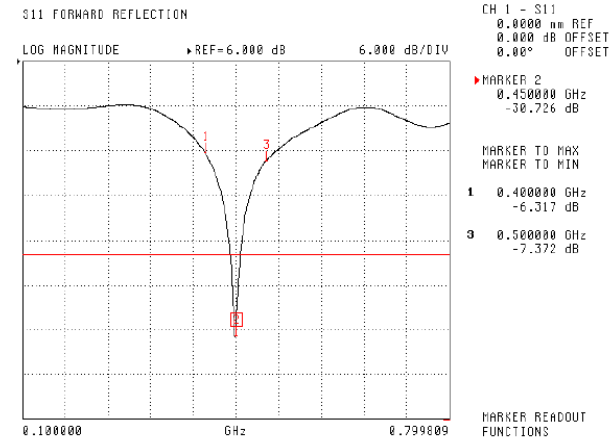

BODY

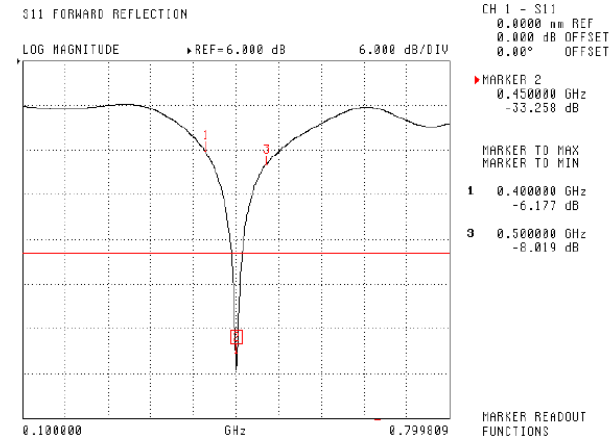

This page has been reviewed for content and attested to by signature within this document.

NCL Calibration Laboratories

Division of APREL Laboratories.

SWR

HEAD

S11 FORWARD REFLECTION

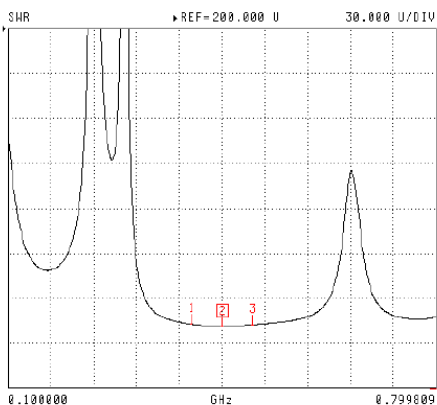

CH 1 - S11
0.0000 nm REF
0.000 dB OFFSET
0.00° OFFSET

MARKER 2
0.450000 GHz
1.051 U

MARKER TO MAX
MARKER TO MIN

- 1 0.400000 GHz
2.872 U
- 3 0.500000 GHz
2.497 U

MARKER READOUT
FUNCTIONS

BODY

S11 FORWARD REFLECTION

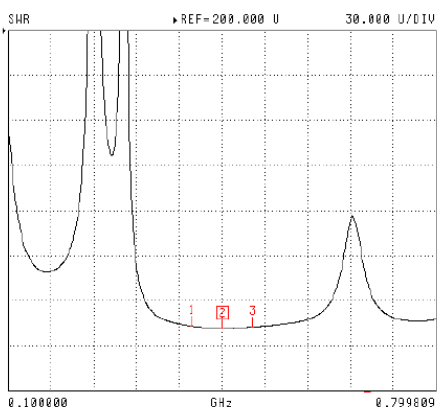

CH 1 - S11
0.0000 nm REF
0.000 dB OFFSET
0.00° OFFSET

MARKER 2
0.450000 GHz
1.049 U

MARKER TO MAX
MARKER TO MIN

- 1 0.400000 GHz
2.931 U
- 3 0.500000 GHz
2.319 U

MARKER READOUT
FUNCTIONS

This page has been reviewed for content and attested to by signature within this document.

NCL Calibration Laboratories

Division of APREL Laboratories.

Smith Chart Dipole Impedance

HEAD

S11 FORWARD REFLECTION
IMPEDANCE

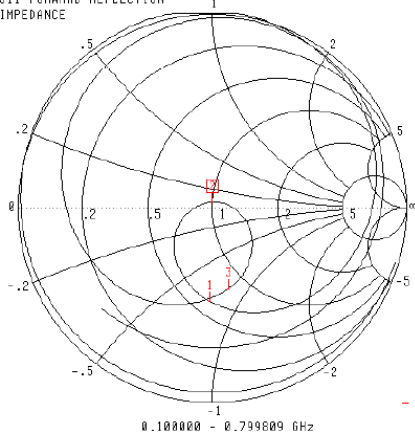

CH 1 - S11
0.0000 nm REF
0.000 dB OFFSET
0.00° OFFSET

▶ MARKER 2
0.450000 GHz
50.600 Ω
2.584 jΩ

MARKER TO MAX
MARKER TO MIN

- 1 0.400000 GHz
30.689 Ω
-38.618 jΩ
- 3 0.500000 GHz
40.424 Ω
-41.402 jΩ

MARKER READOUT
FUNCTIONS

BODY

S11 FORWARD REFLECTION
IMPEDANCE

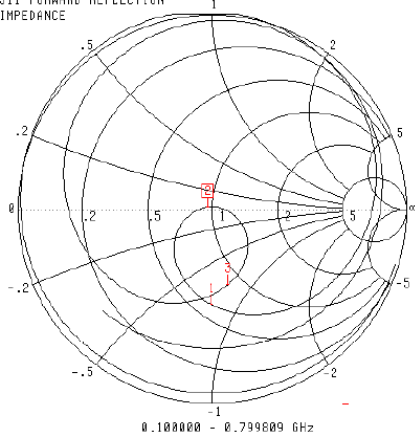

CH 1 - S11
0.0000 nm REF
0.000 dB OFFSET
0.00° OFFSET

▶ MARKER 2
0.450000 GHz
48.155 Ω
995.105 jΩ

MARKER TO MAX
MARKER TO MIN

- 1 0.400000 GHz
30.680 Ω
-39.631 jΩ
- 3 0.500000 GHz
42.524 Ω
-39.206 jΩ

MARKER READOUT
FUNCTIONS

This page has been reviewed for content and attested to by signature within this document.

NCL Calibration Laboratories

Division of APREL Laboratories.

Test Equipment

The test equipment used during Probe Calibration, manufacturer, model number and, current calibration status are listed and located on the main APREL server R:\NCL\Calibration Equipment\Instrument List May 2012.

This page has been reviewed for content and attested to by signature within this document.

9

APPENDIX D – EUT TEST POSITION PHOTOS

Liquid depth $\geq 15\text{cm}$

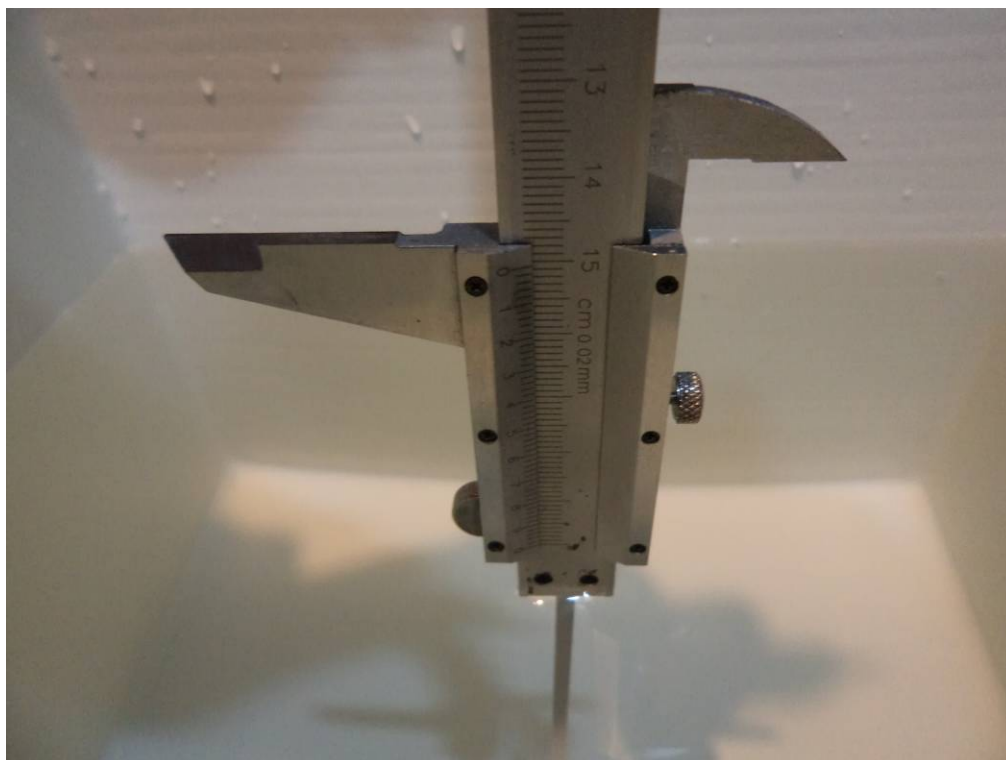

Face-Up 2.5 cm Separation to Flat Phantom

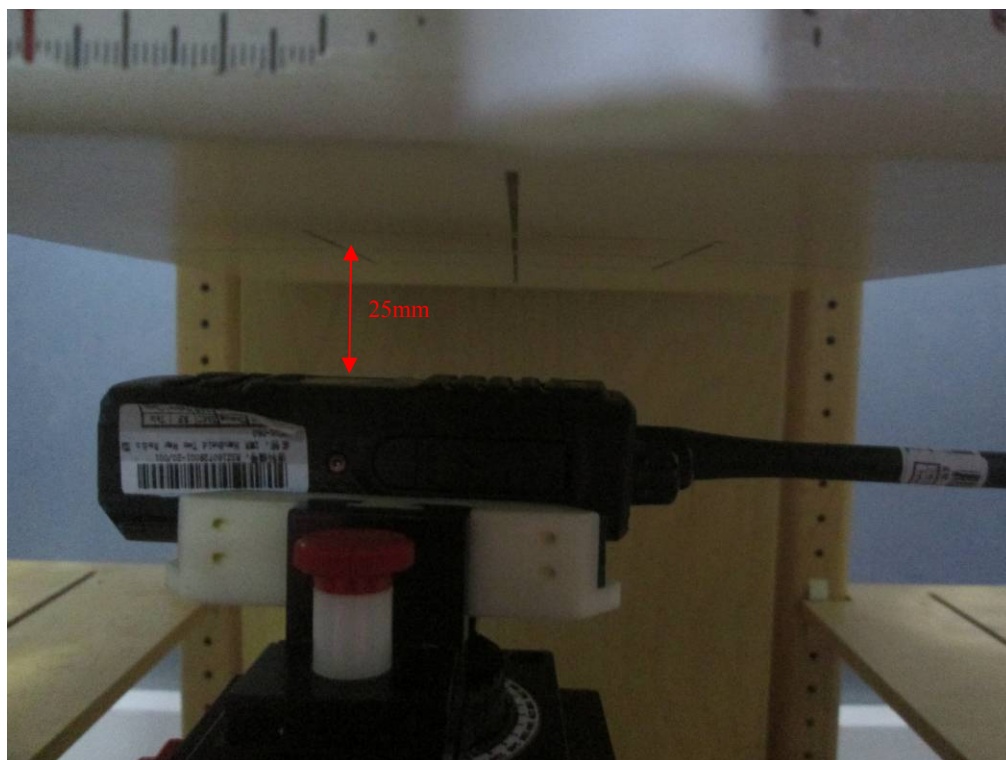

Body-Back 0.0 cm Separation to Flat Phantom



APPENDIX E – EUT PHOTOS

EUT – Front View



EUT – Back View



EUT-Left View



EUT-Right View



EUT-Top View



EUT-Bottom View



EUT-Uncover View



EUT-Battery



EUT-Antenna

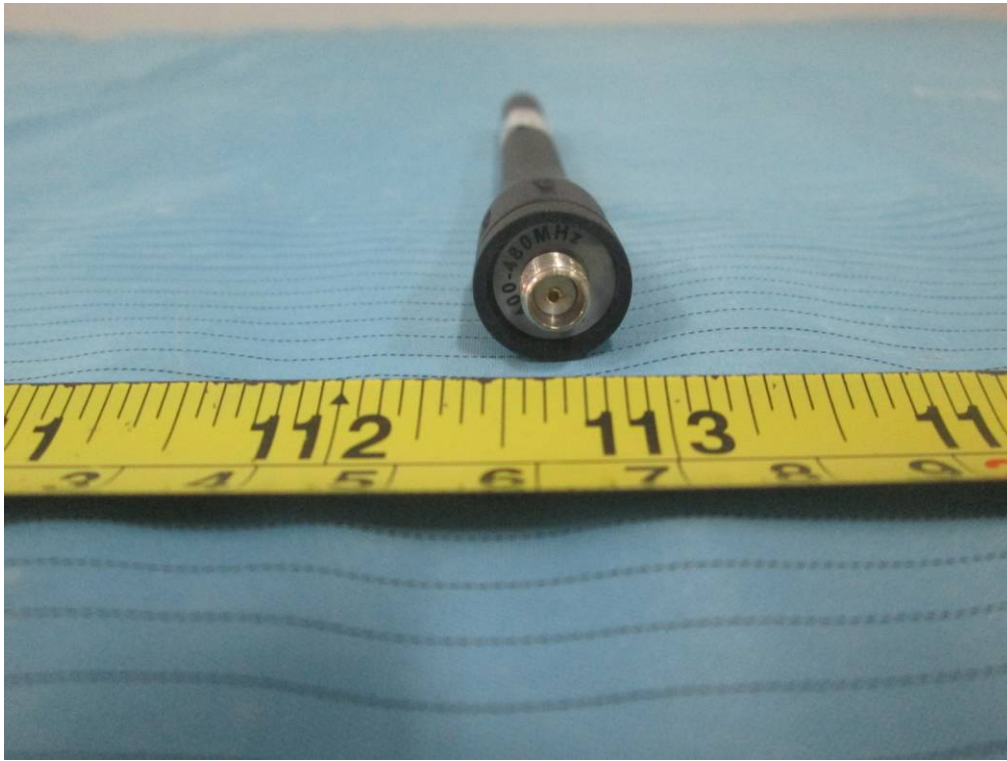

EUT-Belt-clip



APPENDIX E – INFORMATIVE REFERENCES

- [1] Federal Communications Commission, "Report and order: Guidelines for evaluating the environmental effects of radiofrequency radiation", Tech. Rep. FCC 96-326, FCC, Washington, D.C. 20554, 1996.
- [2] David L. Means Kwok Chan, Robert F. Cleveland, "Evaluating compliance with FCC guidelines for human exposure to radiofrequency electromagnetic fields", Tech. Rep., Federal Communication Commission, Office of Engineering & Technology, Washington, DC, 1997.
- [3] Thomas Schmid, Oliver Egger, and Niels Kuster, "Automated E-field scanning system for dosimetric assessments", IEEE Transactions on Microwave Theory and Techniques, vol. 44, pp. 105-113, Jan. 1996.
- [4] Niels Kuster, Ralph Kastle, and Thomas Schmid, "Dosimetric evaluation of mobile communications equipment with known precision", IEEE Transactions on Communications, vol. E80-B, no. 5, pp. 645-652, May 1997.
- [5] CENELEC, "Considerations for evaluating of human exposure to electromagnetic fields (EMFs) from mobile telecommunication equipment (MTE) in the frequency range 30MHz - 6GHz", Tech. Rep., CENELEC, European Committee for Electrotechnical Standardization, Brussels, 1997.
- [6] ANSI, ANSI/IEEE C95.1-1992: IEEE Standard for Safety Levels with Respect to Human Exposure to Radio Frequency Electromagnetic Fields, 3 kHz to 300 GHz, The Institute of Electrical and Electronics Engineers, Inc., New York, NY 10017, 1992.
- [7] Katja Pokovic, Thomas Schmid, and Niels Kuster, "Robust setup for precise calibration of E-field probes in tissue simulating liquids at mobile communications frequencies", in ICECOM '97, Dubrovnik, October 15-17, 1997, pp. 120-24.
- [8] Katja Pokovic, Thomas Schmid, and Niels Kuster, "E-field probe with improved isotropy in brain simulating liquids", in Proceedings of the ELMAR, Zadar, Croatia, 23-25 June, 1996, pp. 172-175.
- [9] Volker Hombach, Klaus Meier, Michael Burkhardt, Eberhard Kuhn, and Niels Kuster, "The dependence of EM energy absorption upon human head modeling at 900 MHz", IEEE Transactions on Microwave Theory and Techniques, vol. 44, no. 10, pp. 1865-1873, Oct. 1996.
- [10] Klaus Meier, Ralf Kastle, Volker Hombach, Roger Tay, and Niels Kuster, "The dependence of EM energy absorption upon human head modeling at 1800 MHz", IEEE Transactions on Microwave Theory and Techniques, Oct. 1997, in press.
- [11] W. Gander, Computermathematik, Birkhaeuser, Basel, 1992.
- [12] W. H. Press, S. A. Teukolsky, W. T. Vetterling, and B. P. Flannery, Numerical Recipes in C, The Art of Scientific Computing, Second Edition, Cambridge University Press, 1992. Dosimetric Evaluation of Sample device, month 1998 9
- [13] NIS81 NAMAS, "The treatment of uncertainty in EMC measurement", Tech. Rep., NAMAS Executive, National Physical Laboratory, Teddington, Middlesex, England, 1994.
- [14] Barry N. Taylor and Christ E. Kuyatt, "Guidelines for evaluating and expressing the uncertainty of NIST measurement results", Tech. Rep., National Institute of Standards and Technology, 1994. Dosimetric Evaluation of Sample device, month 1998 10.
- [15] FCC OET KDB643646 SAR Test Reduction Considerations for Occupational PTT Radios.

***** END OF REPORT *****