

MODEL

HT-SB38

SOUND BAR HOME THEATER SYSTEM

OPERATION MANUAL

Thank you for purchasing this SHARP product. To obtain the best performance from this product, please read this manual carefully. It will guide you in operating your SHARP product.

HT-SB38 Sound Bar Home Theater system consisting of HT-SB38 (sound bar system) and CP-SW38 (active subwoofer system).

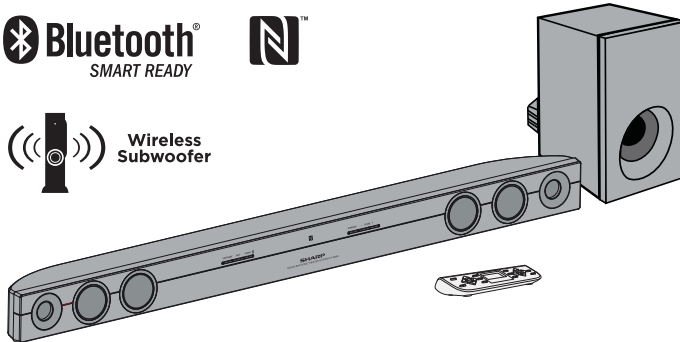







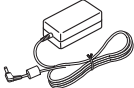

Note:

This product is recommended for flat panel TV (LED, LCD and Plasma).

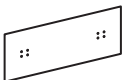
Accessories

The following accessories are included.

 <p>Remote Control (RRMCGA388AW01)</p>	 <p>HDMI Cable x 1 (QCNWGA078AWPZ)</p>	 <p>AC/DC adaptor x 2 (RADPAA100AWZZ)</p>	 <p>AC power cord x 2 (QACCCA005AWZZ)</p>	 <p>Pattern Paper (TCAUHA034AWZZ)</p>
 <p>NFC tag x 1 (GCASP9349AW01)</p>	 <p>Velcro tape (hook type) x 1 (PSHEZA373AW01)</p>	 <p>Velcro tape (loop type) x 2 (PSHEZA372AW01)</p>		



TINSEAE505AWZZ

SHARP CORPORATION

Printed in Malaysia
16C R MW ①

Special Notes

For users in U.S.



CAUTION
RISK OF ELECTRIC SHOCK DO NOT OPEN



CAUTION: TO REDUCE THE RISK OF ELECTRIC SHOCK, DO NOT REMOVE COVER (OR BACK). NO USER-SERVICEABLE PARTS INSIDE. REFER SERVICING TO QUALIFIED SERVICE PERSONNEL.

Explanation of Graphical Symbols:



The lightning flash with arrowhead symbol, within an equilateral triangle, is intended to alert the user to the presence of uninsulated "dangerous voltage" within the product's enclosure that may be of sufficient magnitude to constitute a risk of electric shock to persons.



The exclamation point within an equilateral triangle is intended to alert the user to the presence of important operating and maintenance (servicing) instructions in the literature accompanying the appliance.

WARNING: TO REDUCE THE RISK OF FIRE OR ELECTRIC SHOCK, DO NOT EXPOSE THIS APPLIANCE TO RAIN OR MOISTURE.

NOTE

This equipment has been tested and found to comply with the limits for a Class B digital device, pursuant to Part 15 of the FCC Rules. These limits are designed to provide reasonable protection against harmful interference in a residential installation. This equipment generates, uses, and can radiate radio frequency energy and, if not installed and used in accordance with the instructions, may cause harmful interference to radio communications. However, there is no guarantee that interference will not occur in a particular installation. If this equipment does cause harmful interference to radio or television reception, which can be determined by turning the equipment off and on, the user is encouraged to try to correct the interference by one or more of the following measures:

- Reorient or relocate the receiving antenna.
- Increase the separation between the equipment and receiver.
- Connect the equipment into an outlet on a circuit different from that to which the receiver is connected.
- Consult the dealer or an experienced radio/TV technician for help.

Warning: Changes or modifications to this unit not expressly approved by the party responsible for compliance could void the user's authority to operate the equipment.

FCC Radiation Exposure Statement

This device complies with the limits for a Class B digital device, pursuant to Part 15 of the FCC Rules. It must not be co-located or operating in conjunction with any other antenna or transmitter.

Operation is subject to the following two conditions:

1. This device may not cause harmful interference, and
2. This device must accept any interference received, including interference that may cause undesired operation.

This equipment should be installed and operated with a minimum distance of 20 cm between the radiator and person's body.

Note to CATV system installer:

This reminder is provided to call the CATV system installer's attention to Article 820 of the National Electrical Code that provides guidelines for proper grounding and, in particular, specifies that the cable ground shall be connected to the grounding system of the building, as close to the point of cable entry as practical.

FOR YOUR RECORDS

For your assistance in reporting this unit in case of loss or theft, please record below the model number and serial number which are located on the rear of the unit. Please retain this information.

Model number

Serial number

Date of purchase

Place of purchase

Manufactured under license from Dolby Laboratories. Dolby, Dolby Audio, Pro Logic, and the double-D symbol are trademarks of Dolby Laboratories.

The terms HDMI and HDMI High-Definition Multimedia Interface, and the HDMI Logo are trademarks or registered trademarks of HDMI Licensing LLC in the United States and other countries.

The *Bluetooth*® word mark and logos are registered trademarks owned by *Bluetooth* SIG, Inc. and any use of such marks by SHARP is under license. Other trademarks and trade names are those of their respective owners.

The N Mark is a trademark or registered trademark of NFC Forum, Inc. in the United States and in other countries.

Important Safety Instructions

Electricity is used to perform many useful functions, but it can also cause personal injuries and property damage if improperly handled. This product has been engineered and manufactured with the highest priority on safety. However, improper use can result in electric shock and/or fire. In order to prevent potential danger, please observe the following instructions when installing, operating and cleaning the product. To ensure your safety and prolong the service life of this product, please read the following precautions carefully before use.

- 1) Read these instructions.
- 2) Keep these instructions.
- 3) Heed all warnings.
- 4) Follow all instructions.
- 5) Do not use this apparatus near water.
- 6) Clean only with dry cloth.
- 7) Do not block any ventilation openings. Install in accordance with the manufacturer's instructions.
- 8) Do not install near any heat sources such as radiators, heat registers, stoves, or other apparatus (including amplifiers) that produce heat.
- 9) Do not defeat the safety purpose of the polarized or grounding-type plug. A polarized plug has two blades with one wider than the other. A grounding type plug has two blades and a third grounding prong. The wide blade or the third prong are provided for your safety. If the provided plug does not fit into your outlet, consult an electrician for replacement of the obsolete outlet.
- 10) Protect the power cord from being walked on or pinched particularly at plugs, convenience receptacles, and the point where they exit from the apparatus.
- 11) Only use attachments/accessories specified by the manufacturer.
- 12) Use only with the cart, stand, tripod, bracket, or table specified by the manufacturer, or sold with the apparatus. When a cart is used, use caution when moving the cart/apparatus combination to avoid injury from tip-over.
- 13) Unplug this apparatus during lightning storms or when unused for long periods of time.
- 14) Refer all servicing to qualified service personnel. Servicing is required when the apparatus has been damaged in any way, such as power-supply cord or plug is damaged, liquid has been spilled or objects have fallen into the apparatus, the apparatus has been exposed to rain or moisture, does not operate normally, or has been dropped.

Additional Safety Information

- 15) Power Sources - This product should be operated only from the type of power source indicated on the marking label. If you are not sure of the type of power supply to your home, consult your product dealer or local power company. For product intended to operate from battery power, or other sources, refer to the operating instructions.
- 16) Overloading - Do not overload wall outlets, extension cords, or integral convenience receptacles as this can result in a risk of fire or electric shock.
- 17) Object and Liquid Entry - Never push objects of any kind into this product through openings as they may touch dangerous voltage points or short-out parts that could result in a fire or electric shock.

To prevent fire or shock hazard, do not expose this appliance to dripping or splashing. No objects filled with liquids,

such as vases, shall be placed on the apparatus.

- 18) Damage Requiring Service - Unplug this product from the wall outlet and refer servicing to qualified service personnel under the following conditions:
 - a. When the AC cord or plug is damaged,
 - b. If liquid has been spilled, or objects have fallen into the product,
 - c. If the product has been exposed to rain or water,
 - d. If the product does not operate normally by following the operating instructions. Adjust only those controls that are covered by the operating instructions as an improper adjustment of other controls may result in damage and will often require extensive work by a qualified technician to restore the product to its normal operation,
 - e. If the product has been dropped or damaged in any way, and
 - f. When the product exhibits a distinct change in performance - this indicates a need for service.
- 19) Replacement Parts - When replacement parts are required, be sure the service technician has used replacement parts specified by the manufacturer or have the same characteristics as the original part. Unauthorized substitutions may result in fire, electric shock, or other hazards.
- 20) Safety Check - Upon completion of any service or repairs to this product, ask the service technician to perform safety checks to determine that the product is in proper operating condition.
- 21) Wall or ceiling mounting - When mounting the product on a wall or ceiling, be sure to install the product according to the method recommended by the manufacturer.
- 22) Power Lines - An outside antenna system should not be located in the vicinity of overhead power lines or other electric light or power circuits, or where it can fall into such power lines or circuits. When installing an outside antenna system, extreme care should be taken to keep from touching such power lines or circuits as contact with them might be fatal.
- 23) Protective Attachment Plug - The product is equipped with an attachment plug having overload protection. This is a safety feature. See Instruction Manual for replacement or resetting of protective device. If replacement of the plug is required, be sure the service technician has used a replacement plug specified by the manufacturer that has the same overload protection as the original plug.
- 24) Stand - Do not place the product on an unstable cart, stand, tripod or table. Placing the product on an unstable base can cause the product to fall, resulting in serious personal injuries as well as damage to the product. Use only a cart, stand, tripod, bracket or table recommended by the manufacturer or sold with the product. When mounting the product on a wall, be sure to follow the manufacturer's instructions. Use only the mounting hardware recommended by the manufacturer.

CONSUMER LIMITED WARRANTY

SHARP ELECTRONICS CORPORATION warrants to the first consumer purchaser that this Sharp brand product (the "Product"), when ship in its original container, will be free from defective workmanship and materials, and agrees that it will, at its option, either repair the defect or replace the defective Product or part thereof with a new or remanufactured equivalent at no charge to the purchaser for parts or labor for the period(s) set forth below.

This warranty does not apply to any appearance items of the Product nor to the additional excluded item(s) set forth below nor to any Product the exterior of which has been damaged or defaced, which has been subjected to improper voltage or other misuse, abnormal service or handling, or which has been altered or modified in design or construction.

In order to enforce the rights under this limited warranty, the purchaser should follow the steps set forth below and provide proof of purchase to the servicer.

The limited warranty described herein is in addition to whatever implied warranties may be granted to purchasers by law. ALL IMPLIED WARRANTIES INCLUDING THE WARRANTIES OF MERCHANTABILITY AND FITNESS FOR USE ARE LIMITED TO THE PERIOD(S) FROM THE DATE OF PURCHASE SET FORTH BELOW. Some states do not allow limitations on how long an implied warranty lasts, so the above limitation may not apply to you.

Neither the sales personnel of the seller nor any other person is authorized to make any warranties other than those described herein, or to extend the duration of any warranties beyond the time period described herein on behalf of Sharp.

The warranties described herein shall be the sole and exclusive warranties granted by Sharp and shall be the sole and exclusive remedy available to the purchaser. Correction of defects, in the manner and for the period of time described herein, shall constitute complete fulfillment of all liabilities and responsibilities of Sharp to the purchaser with respect to the Product, and shall constitute full satisfaction of all claims, whether based on contract, negligence, strict liability or otherwise. In no event shall Sharp be liable, or in any way responsible, for any damages or defects in the Product which were caused by repairs or attempted repairs performed by anyone other than an authorized servicer. Nor shall Sharp be liable or in any way responsible for any incidental or consequential economic or property damage. Some states do not allow the exclusion of incidental or consequential damages, so the above exclusion may not apply to you.

THIS LIMITED WARRANTY IS VALID ONLY IN THE FIFTY(50) UNITED STATES, THE DISTRICT OF COLUMBIA AND PUERTO RICO.

Model Specific Section

Your Product Model Number & Description:

HT-SB38 Sound Bar Home Theater System

(Be sure to have this information available when you need service for your Product.)

Warranty Period for this Product:

One (1) year parts and labor from the date of purchase.

Additional Item(s) Excluded from Warranty Coverage (if any):

Non-functional accessories, supplies, and consumable items.

Where to Obtain Service:

At a Sharp Authorized Servicer located in the United States. To find a location of the nearest Sharp Authorized Servicer, call Sharp toll free at 1-800-BE-SHARP.

What to do to Obtain Service:

Ship prepaid or carry in your Product to a Sharp Authorized Servicer. Be sure to have **Proof of Purchase** available. If you ship the Product, be sure it is insured and packaged securely.

TO OBTAIN SUPPLY, ACCESSORY OR PRODUCT INFORMATION, CALL **1-800-BE-SHARP**

SHARP ELECTRONICS CORPORATION

1 Sharp Plaza, Suite 1, Mahwah, NJ 07495-1123

Precautions

■ General

- Keep your equipment at least 4" (10 cm) of free space along the sides, top and back for proper ventilation.

Table/floor

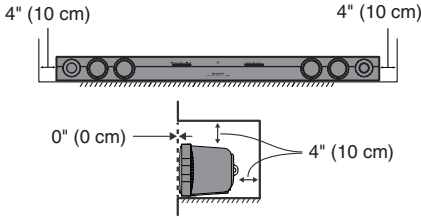

Wall mount

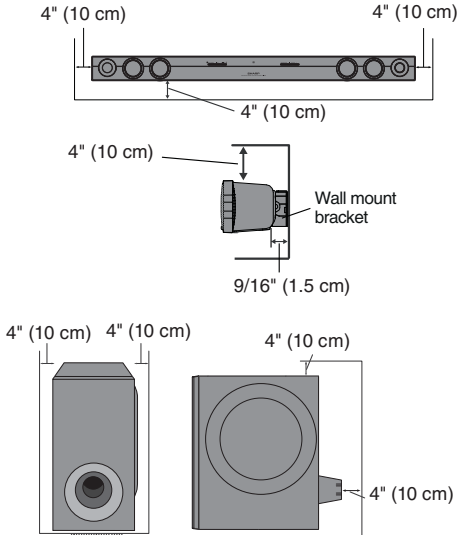

- Use the unit on a firm, level surface free from vibration.
- Keep the unit away from direct sunlight, strong magnetic fields, excessive dust, humidity and electronic/electrical equipment (home computers, facsimiles, etc.) which generate electrical noise.
- Do not place anything on top of the unit.
- Do not expose the unit to moisture, to temperatures higher than 140°F (60°C) or to extremely low temperatures.
- If the unit does not work properly, unplug and plug it in again. Then turn on the unit.
- In case of an electrical storm, unplug the unit for safety.

- Hold the AC power plug by the head when removing it from the AC outlet, as pulling the cord can damage internal wires.
- The AC power plug is used as a disconnect device and shall always remain readily operable.
- **Do not remove the outer cover, as this may result in electric shock. Refer internal service to your local SHARP service facility.**
- This unit should only be used within the range of 41°F - 95°F (5°C - 35°C).
- SHARP is not responsible for damage due to improper use. Refer all servicing to a SHARP authorised service center.

Warnings:

- The supplied AC/DC adaptor contains no user serviceable parts. Never remove covers unless qualified to do so. It contains dangerous voltages, always remove mains plug from the main outlet jack before any service operation or when not in use for a long period.
- The AC/DC adaptor supplied with the HT-SB38 must not be used with other equipment.
- Never use an AC/DC adaptor other than the one specified. Otherwise, problem or serious hazards may be created.
- The voltage used must be the same as that specified on this unit. Using a higher voltage is dangerous and may result in a fire or other type of accident causing damage. SHARP will not be held responsible for any damage resulting from such usage.
- In case of repairing, please bring the entire system set to the service center.

■ Volume control

The sound level at a given volume setting depends on speaker efficiency, location and various other factors. It is advisable to avoid exposure to high volume levels, which occurs while turning the unit on with the volume control setting up high, or while continually listening at high volumes.

Controls and indicators

■ Sound Bar Front Panel

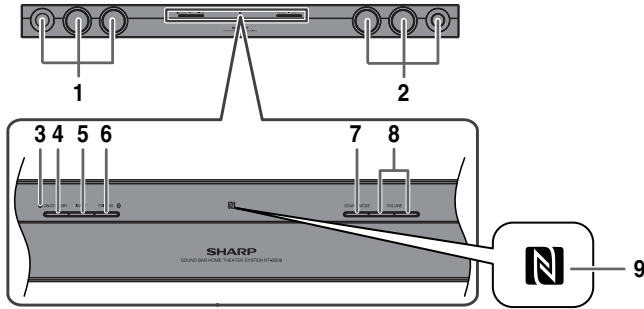

1. Left Channel Speakers
2. Right Channel Speakers
3. On/Standby/Input/ Bluetooth Pairing Indicator
4. On/Standby Button
5. Input Button
6. Pairing Button

7. Sound Mode Button
8. Volume Down / Up Button
9. NFC detection area

■ Subwoofer

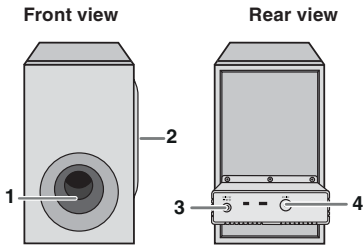

1. Bass Reflex Duct
2. Woofer
3. DC In Jack
4. SW LINK (Subwoofer Link) button

■ Sound Bar Rear Panel

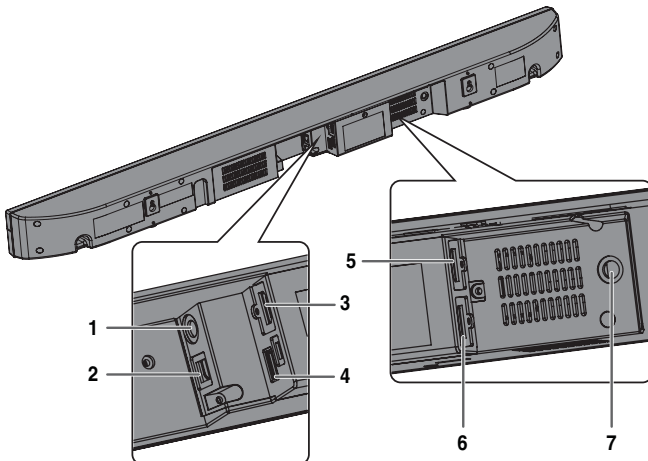

1. Audio IN Terminal
2. Optical IN Jack
3. HDMI OUT (TV ARC) Jack
4. USB Terminal
5. HDMI IN 2 Jack
6. HDMI IN 1 Jack
7. DC IN Jack

Controls and indicators (continued)

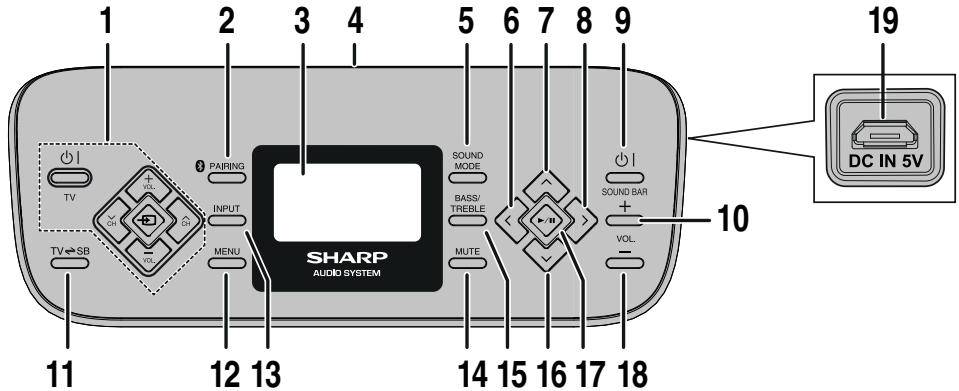

■ Remote Control

1. TV Operation Button
2. *Bluetooth* Pairing Button
3. Display
4. Remote Control Transmitter
5. Sound Mode Button
6. Cursor Left/Fast Reverse/Skip Down button
7. Cursor Up/Play Mode Button
8. Cursor Right/Fast Forward/Skip Up Button
9. ON/STANDBY Button
10. Volume Up Button
11. TV ⇌ SB Speaker Select Button
12. Menu Button
13. Input Select Button
14. Mute Button
15. Bass/Treble Button
16. Cursor Down Button
17. Play/Pause Button
18. Volume Down Button
19. DC IN Terminal

■ Display remote control

To control the sound bar

HT-SB38 comes with a wireless display remote control which uses *Bluetooth* to communicate instead of infra red which requires direct line of sight. You can control the sound bar from any direction or angle within 32 feet (10 meters).

To control SHARP TV

This remote control still uses infra red to control SHARP TV. Point the remote control at the TV remote sensor to operate the TV.

NOTE:

- In case the remote control is lost or needs repairing, bring the entire system set to the service center.

■ Connecting the remote control

The remote control and sound bar will link automatically (wirelessly) as it is already pre-linked at the factory.





If the link cannot be established, please set the connection by the following method.

1. Select PAIRING from the remote control menu. (Refer to select a menu on the remote control on page 14.)
2. 'CONNECTED' will appear on the display when pairing is successful.

■ TV code selection

The default TV code for the remote control is TV CODE 1. In case SHARP TV is not responding to TV operation button, change the code by selecting TV CODE from the remote control menu (Refer 'To select a menu on the remote control on page 14).

TV Operation Buttons (Only SHARP TV):

On/Standby Button  TV	Sets the TV power to "ON" or "STANDBY".	Input Select Button (TV) 	Press the button to switch the input source.
Channel Up and Down Buttons 	Switch up/down the TV channels.	Volume Up and Down Buttons 	Turn up/down the TV volume.

Note:

Some models of SHARP TV may not be operable.

Sound bar preparation

Make sure to unplug the AC power cord before installing the sound bar or changing the position.

To mount the sound bar on the wall

Caution:

- Be very careful to prevent the sound bar [5.1 lbs. (2.3 kg)] from falling when mounting on the wall.
- Before mounting, check the wall strength. (Do not put on the veneer plaster or whitewashed wall. The sound bar may fall.) If unsure, consult a qualified service technician.
- Mounting screws are not supplied. Use appropriate ones.
- Check all wall mount angle screws for looseness.
- Select a good location. If not, accidents may occur or the sound bar may get damaged.
- **SHARP is not responsible for accidents resulting from improper installation.**

■ Driving screws

SHARP designed the sound bar so you may hang it on the wall. Use proper screws (not supplied). See below for size and type.

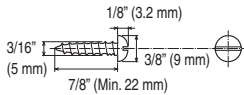

■ Installing the sound bar

- 1 Fix the pattern paper to the wall in horizontal position as below.

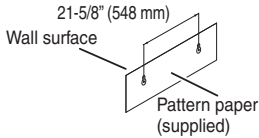

- 2 Make a hole on the wall following the screw point marks on the pattern paper by using a drill.

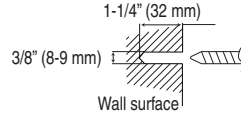

- 3 Fix a wall mount plug into the hole using a hammer, until it is flush with the wall surface.

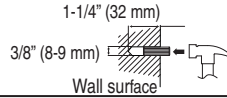

- 4 Fasten the screws to the wall as shown below. (Total screw is 2 pieces)

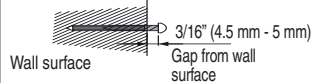
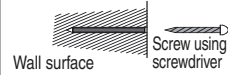

- 5 Hang the sound bar onto the screws.

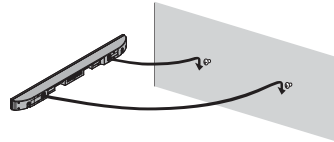

Falling prevention

- Safety wires (not supplied) are useful to prevent the sound bar from falling.

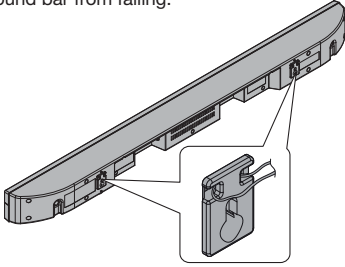

■ When mounting on the wall

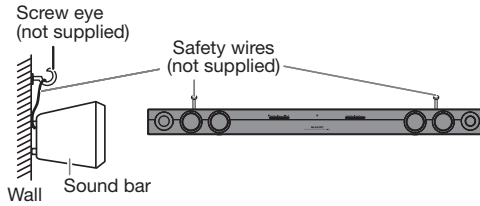

■ When placing on the shelf/table

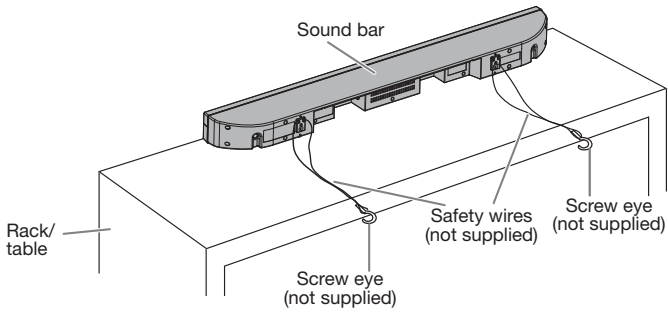

Placing the system

Installation image:

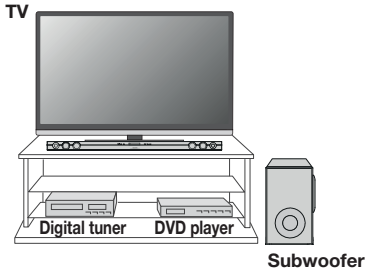

Notes:

- The front panel of the sound bar is not removable.

Caution:

- Do not change the installation direction when the sound bar is turned on.
- Do not stand or sit on the sound bar or subwoofer as you may be injured.
- Do not allow any objects to fall into or to be placed in the bass reflex duct.

System connection

After checking all the connections have been made correctly, connect the AC power cord to the AC power input jack, then to the AC outlet.

■ Using with the AC/DC adaptor

- ① Plug the AC power cord into the AC/DC adaptor.
- ② Plug the AC/DC adaptor cable into the DC INPUT jack on the sound bar and subwoofer.
- ③ Plug the AC power cord into an AC outlet.

Notes:

- Unplug the AC/DC adaptor from the AC outlet if the system will not be used for a prolonged period of time.
- Use only the supplied AC/DC adaptor. Using other AC/DC adaptor may cause an electric shock or fire.

Make sure to unplug the AC power cord before making any connections.

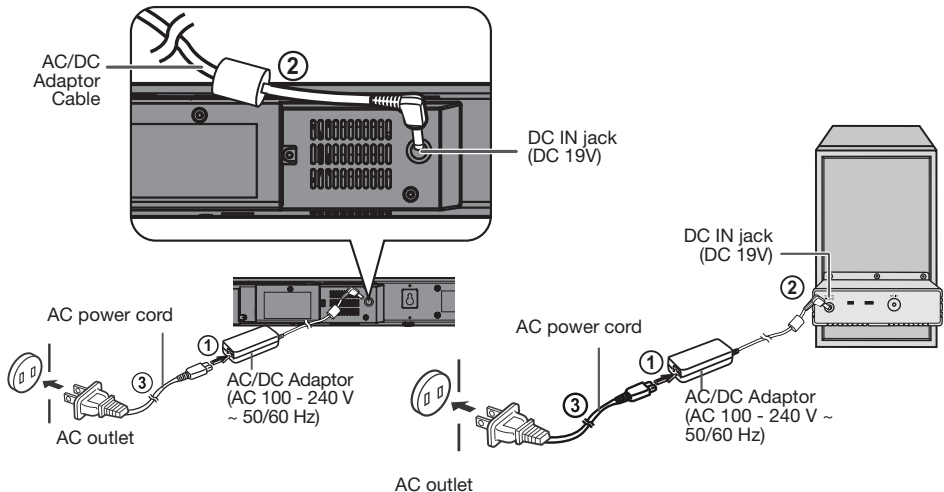

CAUTION:
TO PREVENT
ELECTRIC SHOCK,
MATCH WIDE BLADE
OF PLUG TO WIDE
SLOT, FULLY INSERT.

System connections (continued)

HDMI Connection

Caution:

Turn off all other equipment before making this connection.

The illustration below shows the flows of the signals.

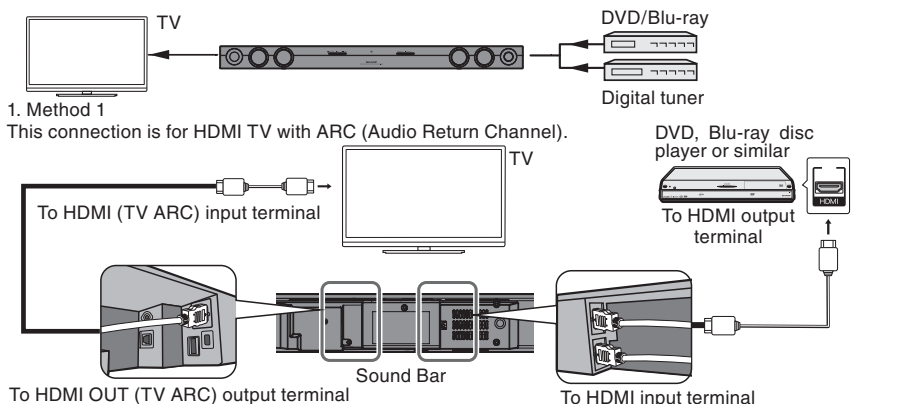

2. Method 2

This connection is for HDMI TV without ARC (Audio Return Channel).

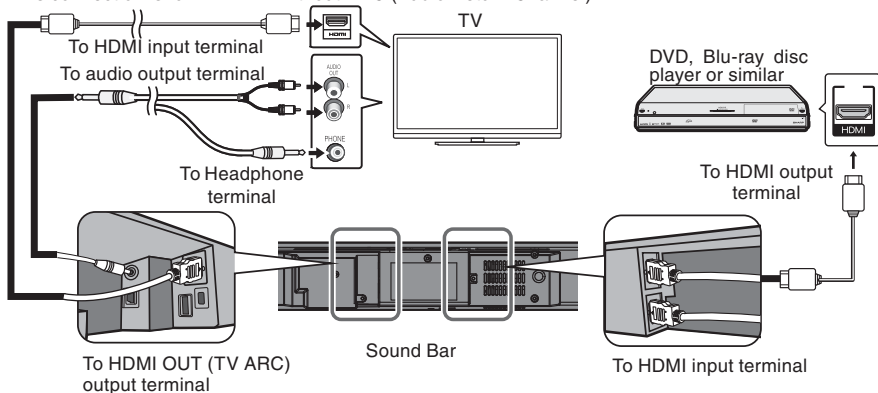

To select HDMI 1, 2 or TV ARC function (Source):

Press INPUT button repeatedly on the sound bar or remote control until "HDMI 1", "HDMI 2" or "TV ARC" appears on the display.

Notes:

- This sound bar supports HDMI which enables ARC (Audio Return Channel).
- To enable ARC make sure to use High Speed HDMI™ cable (with ARC).
- This ARC feature requires TV that supports ARC. Refer the operation manual of the TV to determine which terminal supports ARC.
- To listen to the sound from a non-ARC-compatible TV, connect the audio output from TV to this system's. (refer this page)
- This sound bar can be operated (power on/off or volume up/down) via a TV or similar component which supports HDMI CEC (Consumer Electronics Control). If this does not work, it does not mean this system is faulty. Refer to the operation manual of the respective component on how to activate the CEC.
Example: Go to the Menu of the component to search and enable the CEC. Different brands may have different naming for the CEC. For SHARP LCD TV, it is named as AQUOS LINK.
- **The system will automatically power off if TV or similar component which supports HDMI CEC, is turned off.**
- CEC is not available during Low power consumption mode.
- **To listen to the sound from this system, you will need to select TV ⇌ SB menu (refer page 14) or adjust the speaker output settings within the TV menu.**
For details, refer to the operation manual of the TV.
- **If you are unable to select external speaker setting from the TV menu (E.g. For SHARP LCD TV, it is named as AQUOS AUDIO SP), turn the CEC OFF and ON again.**
- To enjoy 3D images or 4K content, this system must be connected to a 3D-compatible TV and components (3D BD player, etc.) via High Speed HDMI cables. Put on the 3D glasses, otherwise 3D images or 4K content may not be viewed properly.
- If you want to use HDMI IN 1 jack, please use the supplied HDMI cable.

Audio connections to TVs, DVD players, VCRs, etc.

Other connection (without HDMI)

The illustration below shows the flows of audio and video signals.

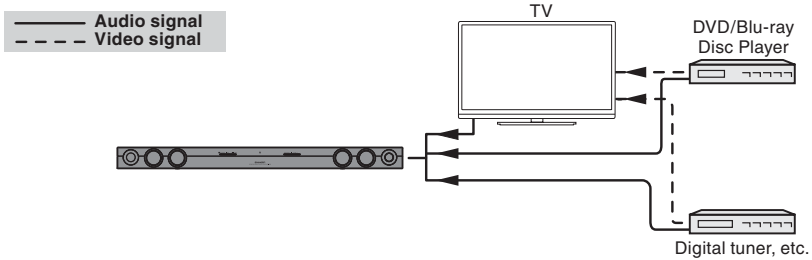

Notes:

- Refer to the operation manual of the equipment to be connected.
- Fully insert the plugs to avoid fuzzy pictures or noises.
- Connecting via this method may disable TV internal speakers.
- In some cases, a small background noise could emit from the sound bar, when you use the RCA audio output terminal connection from a TV-Set/DVD/Blu-ray Disc Player. In such case, please change the connection to the HDMI/ARC or headphone terminal connection. This effect depends on the used TV/DVD/Blu-ray Disc Player-Brand, model and age, and it is not a quality matter from the sound bar.

Connecting a TV, or DVD player, etc.

Connect to the TV using an optical digital cable or an audio cable.

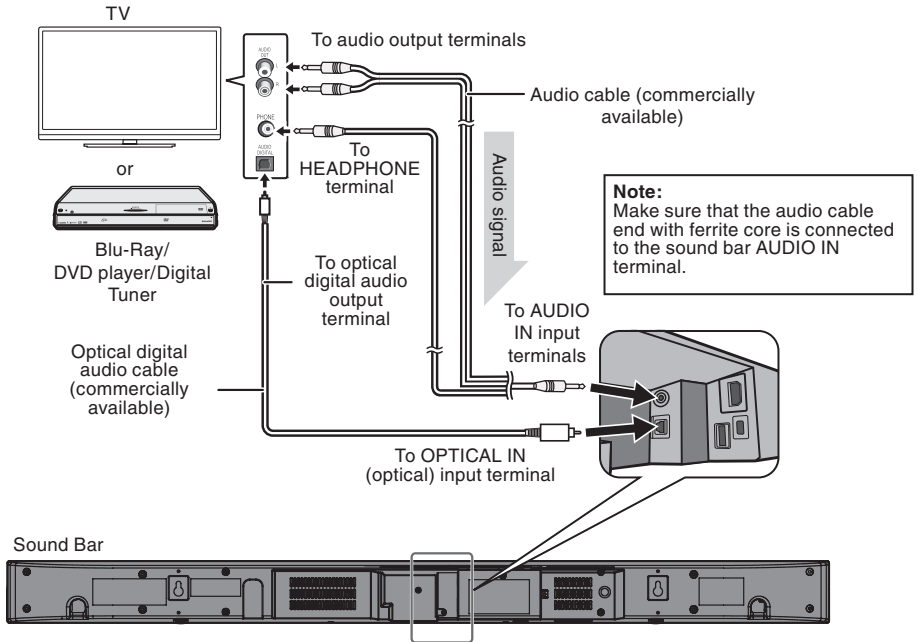

To select OPTICAL function:

Press the INPUT button repeatedly on the sound bar or remote control to select "OPTICAL".

To select AUDIO IN function:

Press the INPUT button repeatedly on the sound bar or remote control to select "AUDIO IN".

Remote control

■ Battery installation

Use 2 “AA” size battery (UM/SUM-3, R6, HP-7 or similar).
Batteries are not included.

- 1 Open the battery cover.
- 2 Insert the batteries according to the direction indicated in the battery compartment.
When inserting or removing the battery, push them toward the ⊖ battery terminals.
- 3 Close the battery cover.

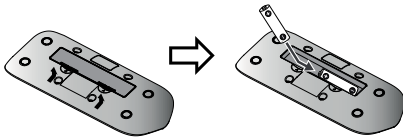

Caution:

- Remove the battery if the sound bar will not be used for a long period of time. This will prevent potential damage due to battery leakage.
- Do not use rechargeable battery (nickel-cadmium battery, etc.).
- Installing the battery incorrectly may cause the sound bar to malfunction.
- Batteries (battery pack or battery installed) shall not be exposed to excessive heat such as sunshine, fire or the like.

Notes concerning use:

- Replace the battery if the operating distance is reduced or if the operation becomes erratic.
- Periodically clean the transmitter on the remote control and the sensor on the sound bar with a soft cloth.
- Exposing the sensor on the sound bar to strong light may interfere with operation. Change the lighting or the direction of the sound bar.
- Keep the remote control away from moisture, heat, shock, and vibrations.

■ Checking the remaining amount of battery level

The battery level is shown by the battery indicator during operation.

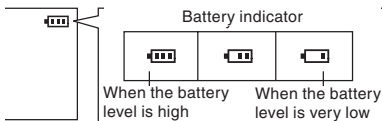

- When the battery level is very low, “Battery low” will appear on the display.
- Replace the battery with a new one.
- When “Battery low” appears on the display, the power will be disconnected automatically.

Notes:

- The battery indicator will not correctly display the remaining capacity for approximately 10 seconds after the power has been turned on.
- The number of bars shown in the battery indicator may increase or decrease, depending on the operation being performed. This is normal.
- The battery life and the operating time may be shortened by usage conditions, long periods of disuse, etc.

■ Test of the remote control

Point the remote control directly at the remote sensor on the sound bar.

The remote control can be used within the range shown below:

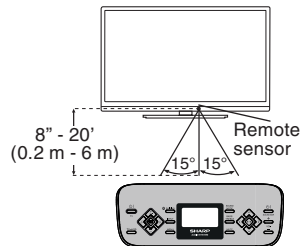

■ USB connection

To operate the remote control without battery power, connect a Micro USB cable (not supplied) to the remote control power terminal.

- Connection of the USB cable to the remote control disconnect the batteries.

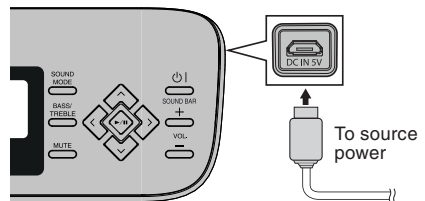

Caution:

The USB connection cannot be used to charge the remote control or as a media playback.

General control

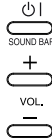
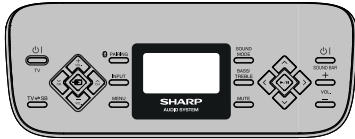
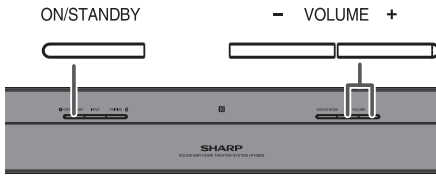

Make sure to enable the HDMI CEC when making HDMI connection. For details, refer to the operation manual of the TV.

■ To turn the power on

Press the ON/STANDBY button on the sound bar or the  button on the remote control.

- The power turns on and the sound bar on/standby/pairing/input indicator lights up according to the input source. If the power does not turn on, check whether the AC power cord is plugged in properly.

Input source	Indicator
Bluetooth	Blue.
Others	Violet.

- The system will automatically power on if TV or similar component which supports HDMI CEC, is turned on.

To set the sound bar to standby mode:

Press the ON/STANDBY button on the sound bar or the  button on the remote control. The the sound bar on/standby/pairing/input indicator turns red.

Notes:

- A slight audio delay after TV is turned ON does not mean that the system is faulty. This is normal.
- "AQUOS speaker is enabled" message will be displayed if SHARP LCD TV does not detect HT-SB38 during power on. However the message "AQUOS audio with AQUOS LINK is enabled" will be displayed soon as HT-SB38 is detected. These messages may vary for other TV model.

■ Eco mode

- The first time the unit is plugged in, it will enter standby mode (ECO mode off). Sound bar indicator turns red.
- To cancel the standby mode, perform the following method.

Remote Control:

1. Select ECO MODE ON from remote control menu (Refer "To select a menu on the remote control on page 14). The next time the unit is turned off it will enter the low power consumption mode (Sound bar indicator turns off).
2. To return to the standby mode, select ECO MODE OFF. The next time the unit is turned off it will enter standby mode.

Sound Bar:

1. Press and hold the ON/STANDBY button during power on until the sound bar is turned off. The next time the unit is turned on and off again it will enter the low power consumption mode (Sound bar indicator turns off).
 2. To return to the standby mode, perform step 1 above. The next time the unit is turned on and off again it will enter standby mode.
- During standby mode, NFC function is activated once your device touches the supplied NFC tag when there is no HDMI connection.

■ Pairing with the Subwoofer

The sound bar and subwoofer will link automatically (wirelessly) when turned on as it is already pre-linked at the factory.

Indication during power on

Indicator on the sound bar lights up in violet or blue (according to the input source)

If the link cannot be established, please set the connection by the following method.

During sound bar standby and subwoofer power off mode (AC power cord unplugged):

1. Press and hold the PAIRING button on the sound bar or on the remote control for more than 3 seconds.
 2. Within 3 minutes, plug in the AC power cord of the subwoofer and turn the power on.
- In case the link is still not established (Sound bar indicator blink), press and hold the SW LINK button at the back of the subwoofer until sound bar light up.

Indication during pairing process

Process	Indicator
During pairing	Indicator will blink in violet
Successful pairing	Indicator turns red

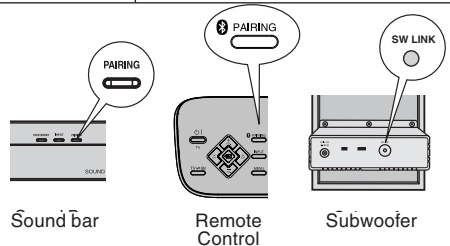

Notes:

- If a device such as microwave oven, wireless LAN card, Bluetooth device or any other device that uses the same 2.4GHz frequency near the system, some sound interruption may be heard due to interference.
- The transmission distance of the wireless signal between the subwoofer and sound bar is about 32 feet (10 meters), but may vary depending on your operating environment. If a steel-concrete or metallic wall is between the subwoofer and the sound bar, the system may not operate at all, because the wireless signal cannot penetrate metal.

Caution:

- Keep the subwoofer away from water and moisture.
- To get the optimum listening performance, make sure the area around the sound bar and subwoofer is clear of any obstacles.

General control (continued)

To select a menu on the remote control

1. Press MENU button.
2. To select a menu, press \wedge or \vee button, then press \rightarrow button.
3. Press \wedge or \vee button to select an option in the desired menu.
4. To select another menu, press \leftarrow button and repeat steps 2 to 3 above.

Menu/Function	Level/Mode
3D AUDIO	3D AUDIO 0 \leftrightarrow 1 \leftrightarrow 2
AV SYNC	AV SYNC 0 \leftrightarrow 1 \leftrightarrow 2 \leftrightarrow 3
APC	5 MIN \leftrightarrow 10 MIN \leftrightarrow 15 MIN \leftrightarrow 20 MIN
SW LEVEL	-5 \leftrightarrow -4 0 \leftrightarrow +4 \leftrightarrow +5
ECO MODE	ECO MODE ON \leftrightarrow OFF
PAIRING	To link the remote control and sound bar manually.
TV CODE	TV CODE 1 \leftrightarrow 2
VERSION	Displays remote control and software version

Volume auto fade-in

If you turn off and on the sound bar with the volume set to 20 or higher, the volume starts at lower level and fades in to the last set level.

Volume control

Sound bar operation:

Press the VOLUME + button to increase the volume and the VOLUME - button for decreasing.

VOLUME 4

MIN \leftrightarrow 1 \leftrightarrow 2 \leftrightarrow 99 \leftrightarrow MAX

Remote control operation:

Press the VOL. + button to increase the volume and the VOL. - button to decrease the volume.

Muting

The volume is muted temporarily when pressing the MUTE button on the remote control. Press again to restore the volume.

Note:

When the sound bar is turned off and back on again, muting is cancelled.

Sound Mode

To change to a different mode, press the SOUND MODE button repeatedly on the sound bar or remote control until the desired sound mode is displayed.

CINEMA	(for cinema sound effect)
MUSIC	(for standard sound effect)
GAME	(for game sound effect)
SPORT	(for sport broadcasting)
NEWS	(for news)
NIGHT	(for night)
BYPASS	(for flat sound effect)

Bass and Treble Control (remote control)

Bass Control

1. Press the BASS/TREBLE button to select bass.
2. Within 5 seconds, press the VOL. (+ or -) or \wedge / \vee button to adjust the bass.

Treble Control

1. Press the BASS/TREBLE button repeatedly to select treble.
2. Within 5 seconds, press the VOL (+ or -) or \wedge / \vee button to adjust the treble.

Subwoofer level control (remote control)

To increase or decrease the Subwoofer level, select SW LEVEL from the remote control menu.

SW LEVEL +2
-5 \leftrightarrow -4 \leftrightarrow +4 \leftrightarrow +5

Notes:

- When sound from the speaker is distorted, decrease the subwoofer level.
- When changing the subwoofer level, the output level of the subwoofer is also changed.

AV SYNC level control (remote control)

To increase or decrease the AV sync level, select AV SYNC from the remote control menu.

AV SYNC +2
0 \leftrightarrow +1 \leftrightarrow +3

Speaker output selection (HDMI connection) (remote control)

Press TV \leftrightarrow SB button on the remote control until "TV SPEAKER" or "SOUND BAR SPEAKER" appears on the display to toggle sound output between this sound bar or TV.

Function

HDMI 1 \rightarrow HDMI 2 \rightarrow TV ARC \rightarrow OPTICAL
 \uparrow BLUETOOTH \leftarrow AUDIO IN \leftarrow

Press the INPUT button repeatedly on the sound bar or remote control to select the desired input source.

Note:

The backup function will protect the memorized function mode for a few hours should there be a power failure or the AC power cord becomes disconnected.

General control (continued)

■ APC (Auto Power Off Control) (remote control)

This sound bar can be set to turn off automatically if no signal or connection is detected. (During Audio In, HDMI, Optical In or USB function)

1. Select APC from the remote control menu to adjust the time.
2. The sound bar will enter the power standby mode automatically if no signal is detected after the preset time has elapsed.

■ Auto power on

During the stand by mode, the unit will automatically power on if it detects audio signal from AUDIO IN, OPTICAL IN or when the *BLUETOOTH* connection has been set up between the sound bar and your device. They will remain connected if there is no HDMI connection.

Note:

This function is not applicable during demonstration mode off.

■ Auto power off function

The unit will enter eco mode on/off if:

Bluetooth:

- No connection for 1 minute.
- In the pause or stop mode and no incoming signal from device after approximately 15 minutes.

■ Audio Return Channel (ARC) (Audio Return Channel submenu)

The audio return channel (ARC) function enables an HDMI ARC-capable TV to send the audio stream to the HDMI OUT jack of the receiver. To use this function, you must select the TV ARC input and your TV must support the ARC.

■ 3D sound mode

3D creates 3D sound through speakers regardless of the type of sound source, whether it is stereo or multichannel. It simulates sound transmission characteristics using digital signal processing to create a widening effect on the sound in the ambient space around the sound source.

By using this technology, multichannel surround sound can be produced from 2.1ch source.

Select the desired 3D sound from the menu

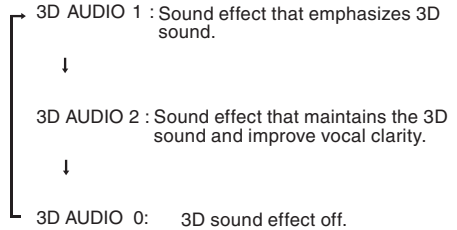

This product incorporates decoders supporting the Dolby Audio system.

Dolby Audio	One of the digital audio systems for theatrical use. You can also enjoy the stereophonic effect in the home theater system. Lights up when detecting Dolby Audio signal.
PCM (Pulse Code Modulation)	This is a general term for digitally encoded audio signals on a CD or DVD. This sound bar lets you enjoy playback of digital signals from sources such as CD or DVD.

Bluetooth one touch connection via NFC

About NFC technology

Near Field Communication (NFC) is a set of standards for devices (smartphones/tablets) to establish radio communication with each other by touching/tapping them together or bringing them into close proximity.

Using NFC in this product simplifies the pairing method of Bluetooth connectivity.

- This audio system supports NFC-enabled device with Android 4.1, Jelly Bean and higher.
- For device with a lower Android version, refer the operation manual of the device for recommended app (application).

Unlike other wireless technology, NFC requires no discovery or pairing.

Simply tap the source device to the NFC detection area on the sound bar to instantly enjoy seamless connectivity between your smart device and the audio system.

NFC detection area

NFC detection area location may vary depending on the device (smartphone / tablet). Refer operation manual of the device for detail.

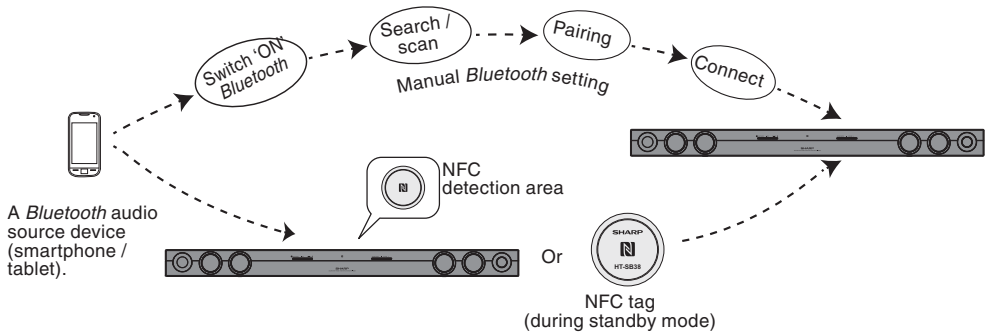

NFC tag setup

The NFC tags can be placed anywhere convenient to you. The velcro tapes supplied will help to secure the tags onto the desired location.

Caution :

- Make sure that the NFC tag is placed on a flat and level surface.
- If you choose not to use the velcro tape, do not place the NFC tag near metal surface to avoid connection interference during tagging.

Important:

- NFC tag provided has unique ID for each sound bar.
- SHARP will not be held liable for the damages caused by rewriting the tags.

Keep all small parts away from children as they may be accidentally swallowed.

- 2 Peel the separator off the velcro tape (hook type) and stick it to the rear of the NFC tag. Then place the tag onto the desired location.

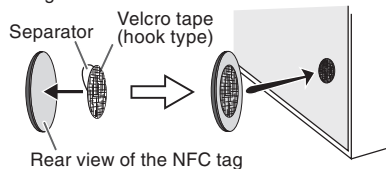

- 1 Peel the separator off the velcro tape (loop type) and stick it on a desired surface.

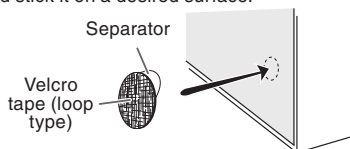

Bluetooth one touch connection via NFC (continued)

NFC connection for audio playback

Check that:

- Your device (smartphone / tablet) has an NFC function.
- NFC function on your device is turned on.
- Screen lock function of the device is off.
- This unit is not in Eco mode.

- 1 Touch your device to the NFC detection area on the sound bar or supplied NFC tag.

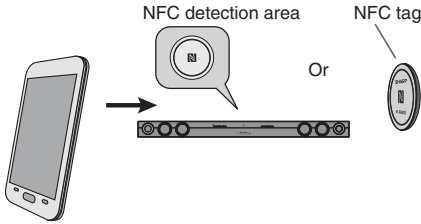

- 2 A pop-up window asking whether to proceed with the *Bluetooth* connection appears on the device. Select <YES>.
- The 'connected' message appears when the connection is complete.

- 3 Playback will start automatically. Otherwise, press play (on remote control or source device).

- Sound will be heard from the speakers of this unit via audio streaming.
- Your device must be within 32 feet (10 meters) from the sound bar.

Bluetooth operation buttons (remote control only)

	Press to play or pause.
	Press to skip up. Press and hold to fast forward.
	Press once to restart the current track. Press twice to skip down. Press and hold to fast reverse.

Notes:

- To disconnect, simply touch your device to the NFC detection area on the subwoofer or NFC tag again.
- To listen to audio via *Bluetooth* connectivity without NFC tag - refer "Pairing with other *Bluetooth* source devices" on page 18.
- It takes about 6-8 seconds for a *Bluetooth* enabled device (eg. smartphone) to establish *Bluetooth* connection with this unit via NFC or manual connection.

Listening to Bluetooth enabled devices

Bluetooth

Bluetooth wireless technology is a short-range radio technology that enables wireless communication between various types of digital devices, such as mobile phone or computer. It operates within a range of about 32 feet (10 meters) without the hassle of having to use cables to connect these devices.

This unit supports the following:

Communication System: *Bluetooth* Specification version 2.1 *Bluetooth* + Enhanced Data Rate (EDR).

Support Profile : A2DP (Advanced Audio Distribution Profile) and AVRCP (Audio/Video Remote Control Profile)

Notes when using unit with a mobile phone

- This unit cannot be used to talk over the telephone even when there is a *Bluetooth* connection made to a mobile phone.
- Please refer to the operating manual supplied with the mobile phone for details on operation of your mobile phone while transmitting the sound using a *Bluetooth* connection.

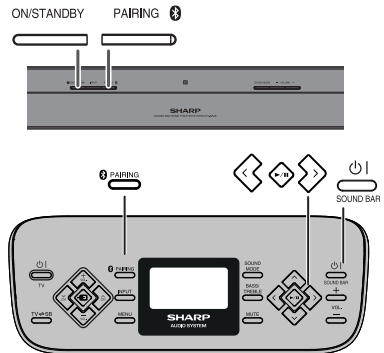

Pairing Bluetooth devices

Bluetooth devices need to be initially paired first before they can exchange data. Once paired, it is not necessary to pair them again unless:

- Pairing is made with more than 20 devices. Pairing can only be made one device at a time. This unit can be paired to a maximum of 20 devices. If subsequent device is paired, the oldest device paired, will be deleted and replaced with the new one.
- This unit is reset. All pairing information is deleted when unit is reset.
- Pairing information is deleted while re-pairing, etc.

Listening to *Bluetooth* enabled devices (continued)

Indicators on the sound bar display:

Indicator (blue)	<i>Bluetooth</i> status
Blinks	In waiting or pairing mode
Lights up	Connected
No indication	Unconnected

However, the indication status is not displayed during standby mode or in other function.

■ Pairing with other *Bluetooth* source devices

- 1 Press the ON/STANDBY button on the sound bar or the  button on the remote control.
- 2 Select the *Bluetooth* function (on the sound bar or remote control). "BLUETOOTH" appears on the display.
- 3 Press PAIRING button on the sound bar or remote control.

Notes:

- Place the devices to be paired within 3 feet (1 meter) of each other when pairing.
 - Some source devices are unable to display lists of detected devices. To pair this unit with the source device, refer to the source device operating manual for details.
- 4 Select "HT-SB38 SHARP" from the source list. If Passcode* is required, enter "0000".
* Passcode may be called PIN Code, Passkey, PIN number or Password.
 - 5 Pairing indicator will light up in blue once the unit is successfully paired with the source device. (Pairing information is now memorized in the unit.) Some audio source devices may connect with the unit automatically after pairing is completed, otherwise follow the instructions in the source device operating manual to start connection.
 - 6 Start *Bluetooth* streaming playback.

Notes:

- If a device such as microwave oven, wireless LAN card, *Bluetooth* device or any other device that uses the same 2.4 GHz frequency near the system some sound interruption may be heard.
- The transmission distance of the wireless signal between the device and the sound bar is about 32 feet (10 meters), but may vary depending on your operating environment. If a steel concrete or metallic wall is between the device and the sound bar, the system may not operate at all, because the wireless signal cannot penetrate metal.
- If this unit or the source device is turned off before *Bluetooth* connection is completed, pairing will not be completed and the pairing information will not be memorized. Repeat step 1 onwards to start pairing again.
- To pair with other devices, repeat steps 1 - 5 for each device. This unit can be paired to a maximum of 20 devices. If subsequent device is paired, the oldest device paired, will be deleted and replaced with the new one.
- Once a device is ousted or deleted from the pairing list, the pairing information for the device is also deleted. To listen to the sound from the device again, it needs to be re-paired. Perform steps 1 - 5 to pair the device again.

■ Listening to the sound

Check that:

- The source device *Bluetooth* functionality is ON.
- Pairing of this unit and the source device is completed.
- Unit is in connected mode.

- 1 Press the ON/STANDBY button on the sound bar or the  button on the remote control.
- 2 Select the *Bluetooth* function (on the sound bar or remote control).
- 3 Start the *Bluetooth* connection from the *Bluetooth* stereo audio source device.
- 4 Start *Bluetooth* streaming playback.

Notes:

- For various *Bluetooth* operations, refer "NFC connection for audio playback" on page 17.
- If the source device has an extra bass function or equalizer function, set them to off to avoid sound distortion.

Note:

- Make the *Bluetooth* connection again if the source device is not turned on, or its *Bluetooth* functionality is off or is in sleep mode.

■ To disconnect the *Bluetooth* device

Perform any of the followings.

- Disconnect the *Bluetooth* connection on the audio source device. Refer the operating manual supplied with the device.
- Turn off the *Bluetooth* stereo audio source device.
- Turn off this unit.

Note:

The volume of this unit may not be controlled as intended depending on the device.

Listening to USB mass storage device/MP3 player

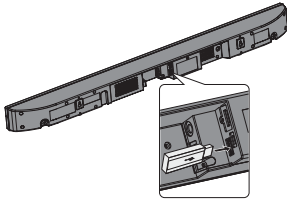

Note:

This product is not compatible with MTP and AAC file systems from USB mass storage device or MP3 player.

To play back USB/MP3 player

- 1 Select the USB function (on the sound bar or remote control. "USB" appears on the display).
 - 2 Playback will start automatically. Otherwise press ►/II.
 - 3 Select desired file to be played back by pressing the < or > button.
- Title, Artist and Album name are displayed if they are recorded in the USB memory device.
 - Display content can be changed by pressing the ∨ button.

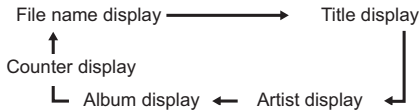

Note:

To pause playback:
Press the ►/II button.

Various USB functions

Function	Remote control	Operation
Track up/down		Press in the playback or pause mode. If you press the button in the pause mode, press the ►/II button to start the desire track.
Fast forward/reverse		Press and hold down in the playback mode. Release the button to resume playback.

Note:

Fast forward/reverse is invalid when playing back a variable bitrate file.

To remove USB memory device

- 1 Press the ►/II button to pause playback.
- 2 Unplug USB memory device from the USB terminal.

Notes:

- SHARP will not be held liable for the loss of data while the USB memory device is connected to the audio system.
- Files compressed in MP3 and/or WMA format can be played back when connected to the USB terminal.
- This USB memory's format supports FAT 16 or FAT 32.

- SHARP cannot guarantee that all USB memory devices will work on this audio system.
- USB cable is not recommended for use in this audio system to connect to USB memory device. Use of the USB cable will affect the performance of this audio system.
- This USB memory cannot be operated via USB hub.
- The USB terminal in this unit is not intended for a PC connection but is used for music streaming with a USB memory device.
- External HDD-storage cannot be played back via USB terminal.
- If the data inside the USB memory is large, it may take longer time for the data to be read.
- This product can play WMA and MP3 files. It will automatically detect the file type being played. If unplayable file is played on this product, the file will be automatically skipped. This will take a few seconds.
- This product relates to USB mass storage devices and MP3 players. It may however face some irregularities due to various unforeseen reasons from some devices. Should this happen, turn off the unit and then turn it on again.
- This unit only supports "MPEG-1 Audio Layer-3" format. (Sampling Frequency is 32, 44.1, 48kHz)
- Playback order for MP3 files may differ depending on the writing software used during file download.
- Bitrate which is supported by MP3 is 32~320 kbps, WMA is 64~160 kbps.
- For MP3/WMA files, please put ".MP3" ".WMA" extension. Files cannot be played back if there is no MP3/WMA extension.
- Copyright protected WMA files cannot be played back.
- Maximum total number supported for MP3/WMA files is 999. However, it is advisable to playback a media with a small amount of MP3/WMA files to maximize playability.

Repeat play

Repeat play can play one track or all tracks.

To repeat one track:

Press the ^ button repeatedly to select "REPEAT ONE".

To repeat all tracks:

Press the ^ button repeatedly to select "REPEAT ALL".

To cancel repeat play:

Press the ^ button to select "NORMAL" and "☐" disappears.

Caution:

After performing repeat play, be sure to press the ►/II button. Otherwise, the device will play continuously.

Random play

The tracks on the device can be played in random order automatically.

To random play all tracks:

Press the ^ button repeatedly to select "RANDOM".

To cancel random play:

Press the ^ button to select "NORMAL".

Notes:

- If you press the > button during random play, you can move to the track selected next by the random operation. On the other hand, the < button does not allow you to move to the previous track. The beginning of the track being played will be located.
- In random play, the unit will select and play tracks automatically. (You cannot select the order of the tracks.)

Troubleshooting chart

Many potential problems can be resolved by the owner without calling a service technician.

If something is wrong with this product, check the following before calling your authorized SHARP dealer or service center.

■ General

Symptom	Possible cause
<ul style="list-style-type: none"> No sound is heard. 	<ul style="list-style-type: none"> Is the input signal (selection) set properly? Is the volume level set to "MIN"? Is muting activated? Is HDMI compliant equipment being used? Is the HDMI cable connected correctly? Connect the HDMI cable correctly and then perform the reset procedure. (refer page 20) Do not connect or disconnect an HDMI cable while power is on. This may lead to operation problems.
<ul style="list-style-type: none"> The sound from subwoofer is not well balanced. 	<ul style="list-style-type: none"> Is the subwoofer level set to the minimum or maximum level?
<ul style="list-style-type: none"> Power turns off suddenly. 	<ul style="list-style-type: none"> Is the HDMI cable connected correctly? Connect the HDMI cable correctly and then perform the reset procedure.
<ul style="list-style-type: none"> Noise is heard during playback. 	<ul style="list-style-type: none"> Move the speaker away from any computers or mobile phones.
<ul style="list-style-type: none"> When a button is pressed, the sound bar does not respond. 	<ul style="list-style-type: none"> Set the sound bar to the standby mode and then turn it back on.
<ul style="list-style-type: none"> The power is not turned on. 	<ul style="list-style-type: none"> Is the sound bar unplugged? The protection circuit may be activated. Unplug and plug in the power cord again after 5 minutes or more.
<ul style="list-style-type: none"> 3D images and 4K content not displayed on the TV. 	<ul style="list-style-type: none"> Depending on the TV and Video component, 3D images and 4K content may not be displayed. Check the operation manual of the respective component. HDMI cable not support 3D images and 4K content.
<ul style="list-style-type: none"> Background noise appears when connecting with RCA audio output terminal connection from a TV-set/ DVD/Blu-ray Disc Player. 	<ul style="list-style-type: none"> Please change to HDMI/ARC or headphone terminal from TV-Set/ DVD/Blu-ray Disc Player. This effect may occur depending on TV/DVD/Blu-ray Disc Player-Brand, model and age, and it is not the sound bar problem.
<ul style="list-style-type: none"> Wireless connection cannot be established. 	<ul style="list-style-type: none"> Check the distance between the sound bar and subwoofer (less than 32 feet (10 meters)). Make sure there is no other wireless devices near the unit.

Symptom	Possible cause
<ul style="list-style-type: none"> Wireless connection cannot be established. 	<ul style="list-style-type: none"> Make sure there is no obstacles (especially metal) blocking between the sound bar and subwoofer. Manually re-link the sound bar and subwoofer (refer page 13).

■ NFC / Bluetooth

Symptom	Possible cause
<ul style="list-style-type: none"> No sound is heard. 	<ul style="list-style-type: none"> The unit is too far from the <i>Bluetooth</i> stereo audio source device. The unit is not paired with the <i>Bluetooth</i> stereo audio source device.
<ul style="list-style-type: none"> <i>Bluetooth</i> sound is interrupted or distorted. 	<ul style="list-style-type: none"> The unit is too near to a device that generates electromagnetic radiation. There is an obstacle between the unit and the <i>Bluetooth</i> stereo audio source device.
<ul style="list-style-type: none"> NFC-enabled device cannot connect to <i>Bluetooth</i> via NFC tag. 	<ul style="list-style-type: none"> Sound bar is not in <i>Bluetooth</i> pairing mode. Perform "NFC connection for audio playback". (Refer page 17.)

■ Remote control

Symptom	Possible cause
<ul style="list-style-type: none"> The remote control does not operate properly. 	<ul style="list-style-type: none"> Is the battery polarity correct? Is the battery dead? Is the distance or angle incorrect? Are there any obstructions in front of the sound bar? Is there a strong light shining on the remote sensor? Is the remote control for another equipment used simultaneously? The remote control is not connected with the sound bar.
<ul style="list-style-type: none"> The sound bar cannot be turned on with the remote control. 	<ul style="list-style-type: none"> Is the AC power cord of the sound bar plugged in? Is the battery inserted? The remote control is not connected with the sound bar.

■ USB

Symptom	Possible cause
<ul style="list-style-type: none"> Device cannot be detected. Playback does not start. 	<ul style="list-style-type: none"> There is no MP3/WMA file inside the device. The device is not properly plugged in. A MTP device is plugged in. The device contains AAC file only. A copyright-protected WMA or false MP3 file is being played back.

Troubleshooting chart (continued)

■ Condensation

Sudden temperature changes, storage or operation in an extremely humid environment may cause condensation inside the cabinet or on the transmitter on the remote control. Condensation can cause the sound bar to malfunction. If this happens, leave the power on until normal playback is possible (about 1 hour). Wipe off any condensation on the transmitter with a soft cloth before operating the sound bar.

■ If problem occurs during operation

When this product is subject to strong external interference (mechanical shock, excessive static electricity, abnormal supply voltage due to lightning, etc.) or if it is operated incorrectly, it may malfunction.

If such a problem occurs, do the following:

1. Set the sound bar to the standby mode and turn the power on again.
2. If the sound bar is not restored in the previous operation, unplug and plug in the sound bar again, and then turn the power on.

■ Factory reset, clearing all memory

Make sure to disconnect all output and input cables attached to the sound bar before performing the factory reset.

1. Press the ON/STANDBY button on the sound bar to enter the power standby mode.
2. While pressing the SOUND MODE button, press and hold the ON/STANDBY button until "RESET" appears.
3. Press the ON/STANDBY button again. (PAIRING indicator will turn red)

Caution:

This operation will erase all data stored in memory.

Maintenance

■ Cleaning the cabinet

Periodically wipe the cabinet with a soft cloth.

Caution:

- Do not use chemicals for cleaning (gasoline, paint thinner, etc.). It may damage the cabinet finish.
- Do not apply oil to the inside of each component. It may cause malfunctions.

Error indicators and warnings

When you fail to perform operations properly, the following messages are displayed on the sound bar.

Display	Meaning
 Error indicator (blinks red)	● When the protection circuit is activated.

(*): Should the same message appear even if the speaker is unplugged and plugged in, or is set to the standby mode and on again, contact your local dealer where you purchased the sound bar.

Specifications

As part of our policy of continuous improvement, SHARP reserves the right to make design and specification changes for product improvement without prior notice. The performance specification figures indicated are nominal values of production unit. There maybe some deviations from these values in individual unit.

■ Sound Bar

Power source	DC IN 19V $\overleftrightarrow{}$ 3.42A: AC/DC adaptor (AC 100 - 240V ~ 50/60Hz)
Power consumption	20 W
Dimension	Width: 54 - 9/16" (1386 mm) Height: 2 - 15/16" (74 mm) Depth: 2 - 11/16" (68 mm)
Weight	7.9 lbs. (3.7 kg)
Output power	RMS: Total 60 watts RMS: Front Left/Right: 30 watts per channel into 6 ohms at 1 kHz, 10% total harmonic distortion FTC: Front: (Left/Right): Minimum 20 watts per channel into 6 ohms at 120 Hz to 20 kHz, 1% total harmonic distortion
Output terminal	HDMI™ output: (audio/video support up to 4K) x 2
Input terminal	500 mV / 47 kΩ Optical digital input (OPTICAL): Square type x 1 HDMI input: (audio/video support up to 4K) x 1
Type	2 Way speaker system 2 - 1/4" (5.7 cm) woofer 1" (2.5 cm) Soft Dome
Bluetooth Frequency band	2.400GHz - 2.480GHz
Compatible Bluetooth Profile	A2DP (Advanced Audio Distribution Profile), AVRCP (Audio/Video Remote Control Profile) BLUETOOTH 4.0 BLE (REMOTE CONTROL) <i>Bluetooth 2.1 +EDR</i>
Maximum input power	60 W
Rated input power	30 W
Impedance	6 Ω

■ USB (MP3 / WMA)

USB host interface	<ul style="list-style-type: none"> ● Complies with USB 1.1 (Full Speed)/2.0 Mass Storage Class. ● Support Bulk only and CBI protocol.
Support file	<ul style="list-style-type: none"> ● MPEG 1 Layer 3 ● WMA (Non DRM)
Bitrate support	<ul style="list-style-type: none"> ● MP3 (32 ~ 320 kbps) ● WMA (64 ~ 160 kbps)
Other	<ul style="list-style-type: none"> ● Maximum total number of MP3/WMA files is 999.
File system support	<ul style="list-style-type: none"> ● Support USB devices with FAT 16/ FAT 32.

■ Subwoofer

Power source	DC IN 19V $\overleftrightarrow{}$ 3.42A: AC/DC adaptor (AC 100 - 240V ~ 50/60Hz)
Power consumption	10 W
Output power	RMS: Total 60 Watts 30 Watts per channel into 6 ohms at 1 kHz, 10% total harmonic distortion FTC: Minimum 23 watts per channel into 6 ohms at 100 Hz to 20 kHz, 1% total harmonic distortion
Type	Subwoofer system 5 - 1/8" (13 cm) woofer
Dimensions	Width: 7 - 3/8" (188 cm) Height: 11 - 1/8" (282 cm) Depth: 11 - 3/4" (299 cm)
Weight	6.6 lbs. (3.0 kg)