

# SHARP®

ENGLISH

MODEL

## GX-BT9

### PORTABLE *BLUETOOTH* BOOMBOX

## OPERATION MANUAL

Thank you for purchasing this SHARP product. To obtain the best performance from this product, please read this manual carefully. It will guide you in operating your SHARP product.

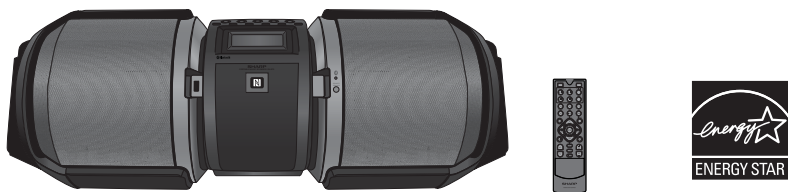

Made for  
 iPod iPhone

iPhone, iPod, iPod nano and iPod touch are trademarks of Apple Inc., registered in the U.S. and other countries. Lightning is a trademark of Apple Inc.



#### Notes for Android device

- This audio system supports NFC-enabled device with Android 4.1, Jelly Bean and higher.
- For device with a lower Android version, refer the operation manual of the device for recommended app (application).

### Accessories

The following accessories are included.

AC power cord x 1 (QACCD0025AWZZ)	Remote control x 1 (RRMCGA370AWSA)	Carrying Strap x 1 (JHNDZA001AWZZ)



TINSEA485AWZZ

Printed in Malaysia  
SHARP CORPORATION  
14M R KI ①

## Special notes

For users in U.S.



**CAUTION**  
RISK OF ELECTRIC SHOCK DO NOT OPEN



**CAUTION: TO REDUCE THE RISK OF ELECTRIC SHOCK, DO NOT REMOVE COVER (OR BACK).**

**NO USER-SERVICEABLE PARTS INSIDE. REFER SERVICING TO QUALIFIED SERVICE PERSONNEL.**

### Explanation of Graphical Symbols:



The lightning flash with arrowhead symbol, within an equilateral triangle, is intended to alert the user to the presence of uninsulated "dangerous voltage" within the product's enclosure that may be of sufficient magnitude to constitute a risk of electric shock to persons.



The exclamation point within an equilateral triangle is intended to alert the user to the presence of important operating and maintenance (servicing) instructions in the literature accompanying the appliance.

**WARNING: TO REDUCE THE RISK OF FIRE OR ELECTRIC SHOCK, DO NOT EXPOSE THIS APPLIANCE TO RAIN OR MOISTURE.**

### NOTE

This equipment has been tested and found to comply with the limits for a Class B digital device, pursuant to Part 15 of the FCC Rules. These limits are designed to provide reasonable protection against harmful interference in a residential installation. This equipment generates, uses, and can radiate radio frequency energy and, if not installed and used in accordance with the instructions, may cause harmful interference to radio communications. However, there is no guarantee that interference will not occur in a particular installation. If this equipment does cause harmful interference to radio or television reception, which can be determined by turning the equipment off and on, the user is encouraged to try to correct the interference by one or more of the following measures:

- Reorient or relocate the receiving antenna.
- Increase the separation between the equipment and receiver.
- Connect the equipment into an outlet on a circuit different from that to which the receiver is connected.
- Consult the dealer or an experienced radio/TV technician for help.

**Warning:** Changes or modifications to this unit not expressly approved by the party responsible for compliance could void the user's authority to operate the equipment.

### FCC Radiation Exposure Statement

This device complies with the limits for a Class B digital device, pursuant to Part 15 of the FCC Rules. It must not be co-located or operating in conjunction with any other antenna or transmitter.

Operation is subject to the following two conditions:

1. This device may not cause harmful interference, and
2. This device must accept any interference received, including interference that may cause undesired operation.

### IC Radiation Exposure Statement (For Users In Canada)

This Class B digital apparatus complies with the Canadian ICES-003 Class B specifications.

This device complies with Industry Canada license-exempt RSS standard(s).

Operation is subject to the following two conditions:

1. this device may not cause interference, and
2. this device must accept any interference, including interference that may cause undesired operation of the device.

### Note to CATV system installer:

This reminder is provided to call the CATV system installer's attention to Article 820 of the National Electrical Code that provides guidelines for proper grounding and, in particular, specifies that the cable ground shall be connected to the grounding system of the building, as close to the point of cable entry as practical.

## ENERGY STAR® Program Information



Products that have earned the **ENERGY STAR®** are designed to protect the environment through superior energy efficiency.

**ENERGY STAR® is a U.S. registered mark.**

### FOR YOUR RECORDS

For your assistance in reporting this unit in case of loss or theft, please record below the model number and serial number which are located on the rear of the unit. Please retain this information.

**Model number** .....

**Serial number** .....

**Date of purchase** .....

**Place of purchase** .....

## Important Safety Instructions

Electricity is used to perform many useful functions, but it can also cause personal injuries and property damage if improperly handled. This product has been engineered and manufactured with the highest priority on safety. However, improper use can result in electric shock and/or fire. In order to prevent potential danger, please observe the following instructions when installing, operating and cleaning the product. To ensure your safety and prolong the service life of this product, please read the following precautions carefully before use.

- 1) Read these instructions.
- 2) Keep these instructions.
- 3) Heed all warnings.
- 4) Follow all instructions.
- 5) Do not use this apparatus near water.
- 6) Clean only with dry cloth.
- 7) Do not block any ventilation openings. Install in accordance with the manufacturer's instructions.
- 8) Do not install near any heat sources such as radiators, heat registers, stoves, or other apparatus (including amplifiers) that produce heat.
- 9) Do not defeat the safety purpose of the polarized or grounding-type plug. A polarized plug has two blades with one wider than the other. A grounding type plug has two blades and a third grounding prong. The wide blade or the third prong are provided for your safety. If the provided plug does not fit into your outlet, consult an electrician for replacement of the obsolete outlet.
- 10) Protect the power cord from being walked on or pinched particularly at plugs, convenience receptacles, and the point where they exit from the apparatus.
- 11) Only use attachments/accessories specified by the manufacturer.
- 12) Use only with the cart, stand, tripod, bracket, or table specified by the manufacturer, or sold with the apparatus. When a cart is used, use caution when moving the cart/apparatus combination to avoid injury from tip-over.
- 13) Unplug this apparatus during lightning storms or when unused for long periods of time.
- 14) Refer all servicing to qualified service personnel. Servicing is required when the apparatus has been damaged in any way, such as power-supply cord or plug is damaged, liquid has been spilled or objects have fallen into the apparatus, the apparatus has been exposed to rain or moisture, does not operate normally, or has been dropped.



### Additional Safety Information

- 15) Power Sources - This product should be operated only from the type of power source indicated on the marking label. If you are not sure of the type of power supply to your home, consult your product dealer or local power company. For product intended to operate from battery power, or other sources, refer to the operating instructions.
- 16) Overloading - Do not overload wall outlets, extension cords, or integral convenience receptacles as this can result in a risk of fire or electric shock.
- 17) Object and Liquid Entry - Never push objects of any kind into this product through openings as they may touch dangerous voltage points or short-out parts that could result in a fire or electric shock.

To prevent fire or shock hazard, do not expose this appliance to dripping or splashing. No objects filled with liquids, such as vases, shall be placed on the apparatus.

- 18) Damage Requiring Service - Unplug this product from the wall outlet and refer servicing to qualified service personnel under the following conditions:
  - a. When the AC cord or plug is damaged,
  - b. If liquid has been spilled, or objects have fallen into the product,
  - c. If the product has been exposed to rain or water,
  - d. If the product does not operate normally by following the operating instructions. Adjust only those controls that are covered by the operating instructions as an improper adjustment of other controls may result in damage and will often require extensive work by a qualified technician to restore the product to its normal operation,
  - e. If the product has been dropped or damaged in any way, and
  - f. When the product exhibits a distinct change in performance - this indicates a need for service.
- 19) Replacement Parts - When replacement parts are required, be sure the service technician has used replacement parts specified by the manufacturer or have the same characteristics as the original part. Unauthorized substitutions may result in fire, electric shock, or other hazards.
- 20) Safety Check - Upon completion of any service or repairs to this product, ask the service technician to perform safety checks to determine that the product is in proper operating condition.
- 21) Wall or ceiling mounting - When mounting the product on a wall or ceiling, be sure to install the product according to the method recommended by the manufacturer.
- 22) Power Lines - An outside antenna system should not be located in the vicinity of overhead power lines or other electric light or power circuits, or where it can fall into such power lines or circuits. When installing an outside antenna system, extreme care should be taken to keep from touching such power lines or circuits as contact with them might be fatal.
- 23) Protective Attachment Plug - The product is equipped with an attachment plug having overload protection. This is a safety feature. See Instruction Manual for replacement or resetting of protective device. If replacement of the plug is required, be sure the service technician has used a replacement plug specified by the manufacturer that has the same overload protection as the original plug.
- 24) Stand - Do not place the product on an unstable cart, stand, tripod or table. Placing the product on an unstable base can cause the product to fall, resulting in serious personal injuries as well as damage to the product. Use only a cart, stand, tripod, bracket or table recommended by the manufacturer or sold with the product. When mounting the product on a wall, be sure to follow the manufacturer's instructions. Use only the mounting hardware recommended by the manufacturer.

## CONSUMER LIMITED WARRANTY

SHARP ELECTRONICS CORPORATION warrants to the first consumer purchaser that this Sharp brand product (the "Product"), when ship in its original container, will be free from defective workmanship and materials, and agrees that it will, at its option, either repair the defect or replace the defective Product or part thereof with a new or remanufactured equivalent at no charge to the purchaser for parts or labor for the period(s) set forth below.

This warranty does not apply to any appearance items of the Product nor to the additional excluded item(s) set forth below nor to any Product the exterior of which has been damaged or defaced, which has been subjected to improper voltage or other misuse, abnormal service or handling, or which has been altered or modified in design or construction.

In order to enforce the rights under this limited warranty, the purchaser should follow the steps set forth below and provide proof of purchase to the servicer.

The limited warranty described herein is in addition to whatever implied warranties may be granted to purchasers by law. ALL IMPLIED WARRANTIES INCLUDING THE WARRANTIES OF MERCHANTABILITY AND FITNESS FOR USE ARE LIMITED TO THE PERIOD(S) FROM THE DATE OF PURCHASE SET FORTH BELOW. Some states do not allow limitations on how long an implied warranty lasts, so the above limitation may not apply to you.

Neither the sales personnel of the seller nor any other person is authorized to make any warranties other than those described herein, or to extend the duration of any warranties beyond the time period described herein on behalf of Sharp.

The warranties described herein shall be the sole and exclusive warranties granted by Sharp and shall be the sole and exclusive remedy available to the purchaser. Correction of defects, in the manner and for the period of time described herein, shall constitute complete fulfillment of all liabilities and responsibilities of Sharp to the purchaser with respect to the Product, and shall constitute full satisfaction of all claims, whether based on contract, negligence, strict liability or otherwise. In no event shall Sharp be liable, or in any way responsible, for any damages or defects in the Product which were caused by repairs or attempted repairs performed by anyone other than an authorized servicer. Nor shall Sharp be liable or in any way responsible for any incidental or consequential economic or property damage. Some states do not allow the exclusion of incidental or consequential damages, so the above exclusion may not apply to you.

THIS LIMITED WARRANTY IS VALID ONLY IN THE FIFTY (50) UNITED STATES, THE DISTRICT OF COLUMBIA AND PUERTO RICO.

### Model Specific Section

**Your Product Model Number & Description:**

**GX-BT9**

**PORTABLE BLUETOOTH BOOMBOX**

(Be sure to have this information available when you need service for your Product.)

**Warranty Period for this Product:**

One (1) year parts and labor from the date of purchase.

**Additional Item(s) Excluded from Warranty Coverage (if any):**

Non-functional accessories, supplies, and consumable items.

**Where to Obtain Service:**

At a Sharp Authorized Servicer located in the United States. To find a location of the nearest Sharp Authorized Servicer, call Sharp toll free at 1-800-BE-SHARP.

**What to do to Obtain Service:**

Ship prepaid or carry in your Product to a Sharp Authorized Servicer. Be sure to have **Proof of Purchase** available. If you ship the Product, be sure it is insured and packaged securely.

TO OBTAIN SUPPLY, ACCESSORY OR PRODUCT INFORMATION, CALL **1-800-BE-SHARP**

**SHARP ELECTRONICS CORPORATION**

1 Sharp Plaza, Suite 1, Mahwah, NJ 07495-1123

## Special Notes

The *Bluetooth*<sup>®</sup> word mark and logos are registered trademarks owned by Bluetooth SIG, Inc. and any use of such marks by SHARP is under license. Other trademarks and trade names are those of their respective owners.

The N Mark is a trademark or registered trademark of NFC Forum, Inc. in the United States and in other countries.

Supply of this product does not convey a license nor imply any right to distribute content created with this product in revenue-generating broadcast systems (terrestrial, satellite, cable and/or other distribution channels), revenue-generating streaming applications (via Internet, intranets and/or other networks), other revenue-generating content distribution systems (pay-audio or audio-on-demand applications and the like) or on revenue-generating physical media (compact discs, digital versatile discs, semiconductor chips, hard drives, memory cards and the like). An independent license for such use is required. For details, please visit <http://mp3licensing.com>

MPEG Layer-3 audio coding technology licensed from Fraunhofer IIS and Thomson.

"Made for iPod" and "Made for iPhone" mean that an electronic accessory has been designed to connect specifically to iPod or iPhone respectively, and has been certified by the developer to meet Apple performance standards. Apple is not responsible for the operation of this device or its compliance with safety and regulatory standards. Please note that the use of this accessory with iPod or iPhone may affect wireless performance.

## Precautions

### ■ General

- Please ensure that the equipment is positioned in a well ventilated area and ensure that there is at least 4" (10 cm) of free space along the sides, top and back of the equipment.

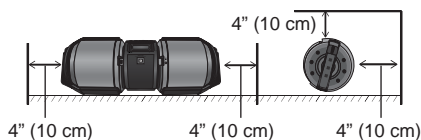

- Use the unit on a firm, level surface free from vibration.
- Place the unit at least 12" (30 cm) away from any CRT TV to avoid color variations across the TV screen. If the variations persist, move the unit further away from the TV. LCD TV is not prone to such variation.
- Keep the unit away from direct sunlight, strong magnetic fields, excessive dust, humidity and electronic/electrical equipment (home computers, facsimiles, etc.) which generate electrical noise.
- Do not place anything on top of the unit.
- Do not expose the unit to moisture, to temperatures higher than 140°F (60°C) or to extremely low temperatures.
- If your system does not work properly, disconnect the AC power cord from the AC outlet. Plug the AC power cord back in, and then turn on your system.
- In case of an electrical storm, unplug the unit for safety.
- Hold the AC power plug by the head when removing it from the AC outlet, as pulling the cord can damage internal wires.
- The AC power plug is used as a disconnect device and shall always remain readily operable.
- **Do not remove the outer cover, as this may result in electric shock. Refer internal service to your local SHARP service facility.**

- This unit should only be used within the range of 41°F - 95°F (5°C - 35°C).
- Do not lift the unit by holding left or right side panel, it may cause speaker diaphragm or unit damage and broken.

### Warning:

The voltage used must be the same as that specified on this unit. Using this product with a higher voltage other than that which is specified is dangerous and may result in a fire or other type of accident causing damage. SHARP will not be held responsible for any damage resulting from use of this unit with a voltage other than that which is specified.

### ■ Volume control

The sound level at a given volume setting depends on speaker efficiency, location, and various other factors. It is advisable to avoid exposure to high volume levels, which occurs while turning the unit on with the volume control setting up high, or while continually listening at high volumes. Excessive sound pressure from earphones and headphones can cause hearing loss.

## Controls and indicators

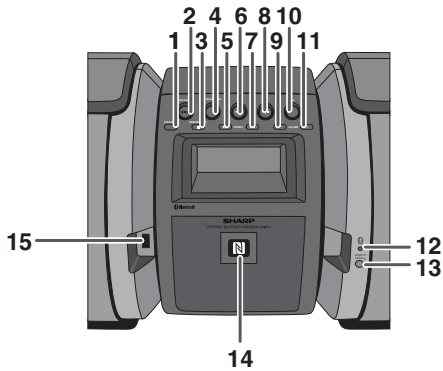

### ■ Front panel

1. Equalizer Button
2. On/Standby Button
3. Demo/ECO/Stop Button
4. Tuner/Audio In Button
5. Tuner Preset Down, *Bluetooth*/USB Track Down, Skip down, Auto Tuning Down
6. USB Play/Pause Button
7. Tuner Preset Up, *Bluetooth*/USB Track Up, Auto Tuning up
8. *Bluetooth* Play/Pause Button
9. Volume Down Button
10. X-Bass Button
11. Volume Up Button
12. *Bluetooth* pairing indicator
13. Remote sensor
14. NFC detection area
15. USB Terminal

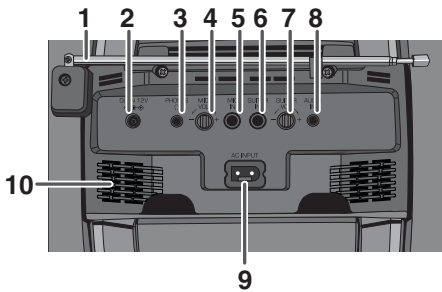

### ■ Rear panel

1. FM Antenna
2. DC 12 V input jack
3. Headphone jack
4. Microphone volume knob
5. Microphone input jack
6. Guitar input jack
7. Guitar volume knob
8. Audio input jack
9. AC input jack
10. Cable holder

## Controls and indicators (continued)

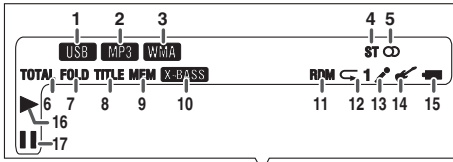

### Speakers

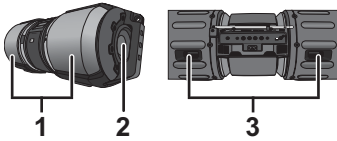

1. Front speaker
2. Subwoofer
3. Bass Reflex Duct

### Display

1. USB Indicator
2. MP3 Indicator
3. WMA Indicator
4. FM Stereo Mode Indicator
5. Stereo Station Indicator
6. Total Indicator
7. Folder Indicator
8. Title Indicator
9. MEM (Memory) Indicator
10. X-bass Indicator
11. RDM (Random) Indicator
12. Repeat Indicator
13. Microphone Indicator
14. Guitar Indicator
15. Battery Level Indicator
16. Play Indicator
17. Pause Indicator

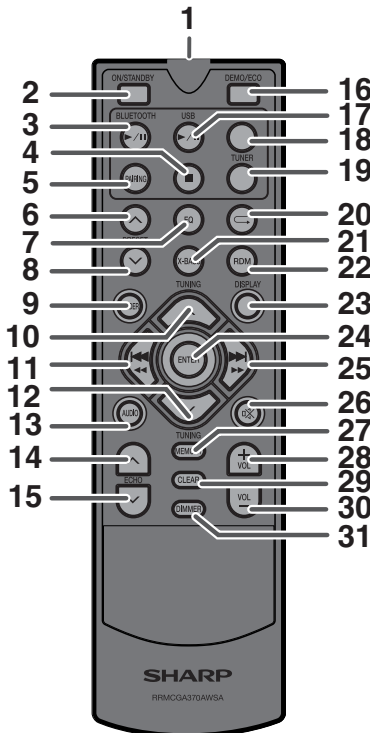

### Remote control

1. Remote Control Transmitter
2. On/Standby Button
3. Bluetooth Play/Pause Button
4. Stop Button
5. Pairing Button
6. Tuner Preset Up Button
7. Equalizer Button
8. Tuner Preset Down Button
9. Folder button
10. Tuning Up, Folder Up Button
11. Skip Down, Fast Reverse Button
12. Tuning Down, Folder Down Button
13. Audio Button
14. Echo Up Button
15. Echo Down Button
16. Demo/Eco Button
17. USB Play/Pause Button
18. Audio In Button
19. Tuner Button
20. Repeat Button
21. X-Bass Button
22. Random Button
23. Display Button
24. Enter Button
25. Skip Up, Fast Forward Button
26. Mute Button
27. Memory Button
28. Volume Up Button
29. Clear Button
30. Volume Down Button
31. Dimmer Button

## System connections

Do not connect the DC and AC power to the unit at the same time.

AC outlet  
AC 110 - 240 V  
~ 50/60 Hz

To AC INPUT jack

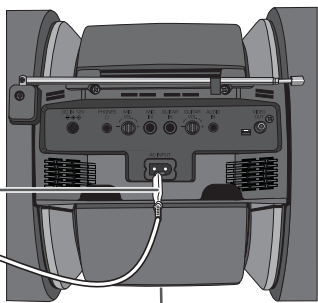

**CAUTION:**  
TO PREVENT ELECTRIC SHOCK,  
MATCH WIDE BLADE OF PLUG  
TO WIDE SLOT, FULLY INSERT.

The safety marking and statement label (\*)



(\*) Label is located at the bottom of the unit.

### ■ AC power connection

After checking all the connections have been made correctly, plug the AC power cord of this unit into the AC outlet.

#### Notes:

- Remove all batteries when using AC power.
- Unplug the AC power cord from the AC outlet if the unit will not be in use for a prolonged period of time.

### ■ DC power connection

Recommended plug type

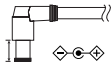

3/8" (9.5mm)

1/8" (3.5mm) 7/32" (5.5mm)

#### Caution:

- During battery/DC operation, the unit will be set to Demonstration mode off with display and subwoofer light in MODE 2 to reduce the battery power consumption.
- When using battery/DC power, the remote control cannot be used to turn on the unit.
- Unplug the AC power cord from the unit before using the DC power. Otherwise the unit will not work.
- When the unit is not in use for an extended period, remove the DC cord from the DC IN 12 V jack.

### ■ Operation with batteries

Fully charge an external device with AC power before using GX-BT9 battery operation.

#### 1 Disconnect the AC and DC power cord, and remove the battery compartment cover.

- Remove all connection before installing batteries to avoid possible damage.
- Connection of the AC or DC power cord to the unit disconnects the batteries.

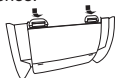

#### 2 Insert 10 "D" size batteries (UM/SUM-1, R20, HP-2 or similar) into the battery compartment according to the sequence indicated on the rear panel.

- When inserting or removing the batteries (5) and (10), push them toward the (-) battery terminals.
- Installing the batteries incorrectly may cause the unit to malfunction.
- Batteries are not included.

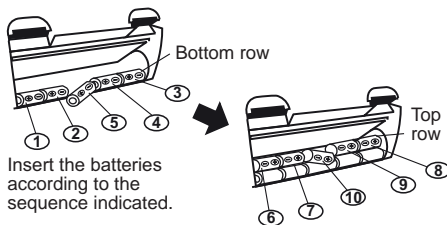

Insert the batteries according to the sequence indicated.

### 3 Replace the battery compartment cover.

#### Precautions for battery use:

- Insert the batteries according to the direction indicated on the rear panel.
- Remove the batteries if they are weak or if the unit will not be used for long periods of time. This will prevent potential damage due to battery leakage.
- Replace all old batteries with new ones at the same time.
- Do not mix old and new batteries.

#### Battery replacement:

- When batteries are low, battery indicator "■" will blink to show that the batteries need to be replaced. sound may become distorted and unit may automatically turn off or mute during high volume level. Reduce the volume level or replace the batteries.
- When replacing the batteries, place the unit on a cushion or soft cloth to avoid damage.

#### Cautions:

- Do not use rechargeable battery (nickel-cadmium battery, etc.).
- Immediately remove the discharged batteries. If the chemical leak into the unit, clean it.
- Batteries (battery pack or batteries installed) shall not be exposed to excessive heat such as sunshine, fire or the like.

### ■ Bluetooth standby mode

The first time the unit is plugged in with AC power, the unit will enter the Bluetooth standby mode 1.

Press the DEMO/[ECO] button on the main unit or DEMO/ECO button on the remote control to change the mode.

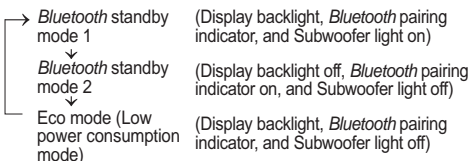

#### Note:

During Bluetooth standby mode, NFC function is activated once your device touches the NFC detection area.



## Remote control

### Battery installation

- 1 Open the battery cover.
- 2 Insert the supplied battery according to the terminal indicated in the battery compartment.  
When inserting or removing the battery, push it toward the (-) battery terminals.
- 3 Close the cover.

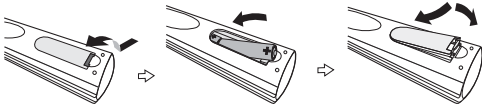

#### Caution:

- Remove the battery if the unit will not be used for a long period of time. This will prevent potential damage due to battery leakage.
- Do not use rechargeable battery (nickel-cadmium battery, etc.).
- Installing the battery incorrectly may cause the unit to malfunction.
- Batteries (battery pack or batteries installed) shall not be exposed to excessive heat such as sunshine, fire or the like.

#### Notes concerning use:

- Replace the battery if the operating distance is reduced or if the operation becomes erratic. Purchase 2 "AAA" size battery. (UM/SUM4, R3, HP-16 or similar)
- Periodically clean the transmitter on the remote control and the sensor on the unit with a soft cloth.
- Exposing the sensor on the unit to strong light may interfere with operation. Change the lighting or the direction of the unit if this occurs.
- Keep the remote control away from moisture, heat, shock, and vibrations.

### Test of the remote control

Check the remote control after checking all the connections. Point the remote control directly at the remote sensor on the unit. The remote control can be used within the range shown below:

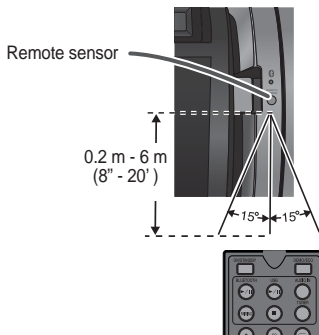

#### Note:

Exposing the infrared remote control to direct sunlight may cause the remote control to be inoperable.

## Carrying the unit

#### Caution:

Before transporting the unit, remove all connection from the unit. Then, set the unit to the power standby mode. Transporting the unit with any device left connected might damage the unit.

### Using the carrying strap

This unit can be carried by using a supplied carrying strap. Insert the carrying strap carabiner (hook) to each end of the unit as shown below.

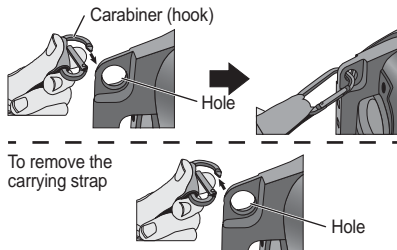

#### Cautions:

- Before carrying the unit, make sure the carabiner (hook) is properly secured and closed, otherwise it will cause damage and injury.
- Carry this unit with FM antenna close to you and the display facing outward to avoid scratches on the display.

## Placing the unit

This unit can be placed in 2 positions as shown below.

#### Caution:

- Make sure that the unit is placed on a flat and level surface.
- Make sure to turn the unit carefully when adjusting the position.
- Do not place the unit other than these 2 positions to avoid damage and injury.

To get the best display viewing angle, place the unit as below.

#### Position 1:

On the shelf/table.

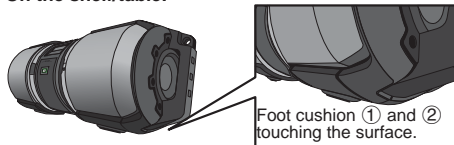

#### Position 2:

On the floor/ground

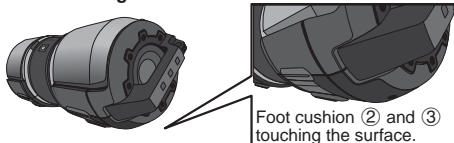

## General control

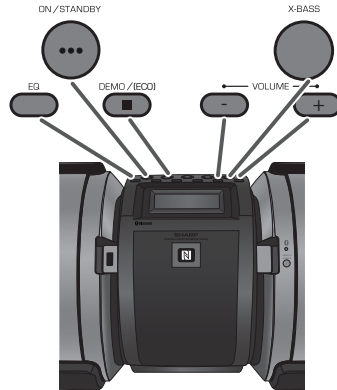
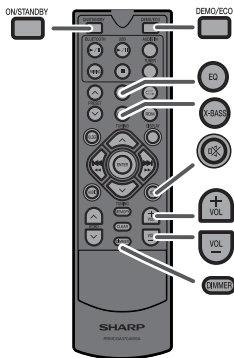

### ■ To turn the power on

Press the ON/STANDBY button to turn the power on.

#### After use:

Press the ON/STANDBY button to enter the power standby mode.

### ■ Display and Subwoofer light up control

The display and subwoofer light can be changed. Press the DIMMER button on the remote control to change the mode.

- MODE 1 (Display backlight on and Subwoofer light off)
- ↓
- MODE 2 (Display backlight off and Subwoofer light off)
- ←
- MODE Off (Display backlight on and Subwoofer light on)

#### Notes:

- During battery/DC operation, the unit will be set to MODE 2 to reduce the battery power consumption.
- During MODE 2, press any button to light up the display backlight for a few seconds.

### ■ Volume auto fade-in

If you turn off and on the main unit with the volume set to 16 or higher, the volume starts at 15 and fades in to the last set level.

### ■ Volume control

Press VOLUME +/- buttons (on main unit) or VOL +/- (on remote control) to increase or decrease the volume.

### ■ Direct key power on function

When you press any of the following buttons, the unit turns on.

- BLUETOOTH ►/|| or USB ►/|| on the main unit or the remote control: selected function is activated.
- TUNER/AUDIO IN on the main unit: last tuner or audio function is activated.
- TUNER or AUDIO IN on the remote control: the unit turns on with the selected function activated.

### ■ Auto power off function

The main unit will enter the standby mode (when iPod, iPhone, guitar or microphone is not connected) after 15 minutes of inactivity during:

Audio In: No detection of input signal.

USB: In the stop mode or no media.

Bluetooth: In the pause or stop mode and no incoming signal from a source device.

### ■ Auto resume function

The auto resume function will resume the last functions should there be a power failure or the AC power cord becomes disconnected. However, program and random mode are not memorized.

### ■ Equalizer

When the EQ button is pressed, the current mode setting will be displayed. To change to a different mode, press the EQ button repeatedly until the desired sound mode appears.

- FLAT No equalization.
- ↓
- ROCK For rock music.
- ↓
- VOCAL Vocals are enhanced.
- ↓
- HIP HOP For hip hop music.
- ↓
- SALSA For salsa music.
- ↓
- REGGAE For reggae music.

### ■ Muting

The volume is muted temporarily when pressing the  button on the remote control. Press again to restore the volume.

### ■ X-Bass control

When the power is first turned on, the unit will enter the extra bass mode which emphasises the bass frequencies, and "X-BASS" will appear. To cancel the extra bass mode, press the X-BASS button. The last equaliser mode will turn on. To turn on the X-Bass mode again, press the X-BASS button.

# Bluetooth one touch connection via NFC

## About NFC technology

Near Field Communication (NFC) is a set of standards for devices (smartphones/tablets) to establish radio communication with each other by touching/tapping them together or bringing them into close proximity.

Using NFC in this product simplifies the pairing method of *Bluetooth* connectivity.

### Notes for Android Device.

- This audio system supports NFC-enabled device with Android 4.1, Jelly Bean and higher.
- For device with a lower Android version, refer the operation manual of the device for recommended app (application).

Unlike other wireless technology, **NFC requires no discovery or pairing.**

**Simply tap the source device to the NFC detection area to instantly enjoy seamless connectivity between your smart device and the audio system.**

## NFC detection area

NFC detection area location may vary depending on the device (smartphone/tablet). Refer operation manual of the device for detail.

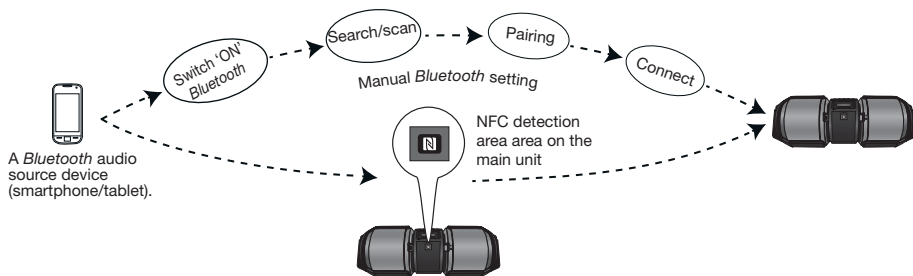

## NFC connection for audio playback

### Check that:

- Your device (smartphone/tablet) has an NFC function.
- NFC function on your device is enabled.
- Screen lock function of the device is off.
- This unit is not in low power consumption (ECO) mode.
- Your device must be within 10 meters from the unit.

- 1 Touch your device to the NFC detection area on the main unit.

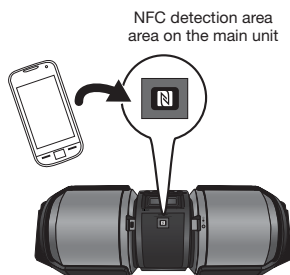

- 2 A pop-up window asking whether to proceed with the *Bluetooth* connection appears on the device. Select <YES>.

- The 'connected' message appears when the connection is complete.

- 3 Playback will start automatically, otherwise press play (on remote control or source device).

- Sound will be heard from the speakers of this unit via audio streaming.
- Your device must be within 10 meters from the unit.

### Various *Bluetooth* operation buttons (remote control only)

BLUETOOTH	
	Press the button to play or pause.
	Press the button to skip up. Press and hold to fast forward.
	Press the button to skip down. Press and hold to fast reverse.

### Notes:

- To disconnect, simply touch your device to the NFC detection area on the main unit again.
- This product switches to *Bluetooth* function automatically when NFC tagging was done by your device.
- If your device does not support NFC, or if you wish to listen to audio via *Bluetooth* connectivity without NFC; refer "**Pairing with other *Bluetooth* source devices**" on the next page.
- Some *Bluetooth* devices will connect to this product automatically when the device or its *Bluetooth* mode was turned on. In such case, it will also change the function selection of this product. If you do not want it to connect automatically, please disable *Bluetooth* on your device.
- It takes about 6-8 seconds for a *Bluetooth* enabled device (eg. smartphone) to establish *Bluetooth* connection with this unit via NFC or manual connection.
- If "Empty tag" or similar message appears on your device, touch the device again to the NFC detection area on the main unit.

# Listening to Bluetooth enabled devices

## Bluetooth

Bluetooth wireless technology is a short-range radio technology that enables wireless communication between various types of digital devices, such as mobile phone or computer. It operates within a range of about 10 meters (32 feet) without the hassle of having to use cables to connect these devices.

### This unit supports the following:

Communication System: Bluetooth Specification version 2.1 Bluetooth + Enhanced Data Rate (EDR).  
Support Profile: A2DP (Advanced Audio Distribution Profile) and AVRCP (Audio/Video Remote Control Profile)

### Notes when using unit with a mobile phone

- This unit cannot be used to talk over the telephone even when there is a Bluetooth connection made to a mobile phone.
- Please refer to the operating manual supplied with the mobile phone for details on operation of your mobile phone while transmitting the sound using a Bluetooth connection.

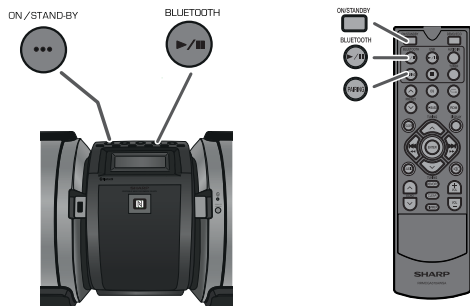

## Pairing Bluetooth devices

Bluetooth devices need to be initially paired first before they can exchange data. Once paired, it is not necessary to pair them again unless:

- pairing is made with more than 99 devices. Pairing can only be made one device at a time. This unit can be paired to a maximum of 99 devices. If subsequent device is paired, the oldest device paired, will be deleted and replaced with the new one.
- pairing information is deleted while repairing, etc.

### Indicators:

Status	PAIRING indicator (blue)
Unconnected	Blinks
Connected	Lights up

However, the indicator status is not displayed during Bluetooth standby mode.

## Pairing with other Bluetooth source devices

- 1 Press the ON/STANDBY button to turn the power on.
- 2 Press the **BLUETOOTH** button on the main unit or on the remote control to select Bluetooth function. (Pairing indicator blinks.)
- 3 Perform pairing procedure on the source device to detect this unit. "GX-BT9 SHARP" will appear in the detected devices list (if available) in the source device. (Refer the source device operating manual for details).

### Notes:

- Place the devices to be paired within 1 meter (3 feet) of each other when pairing.
  - Some source devices are unable to display lists of detected devices. To pair this unit with the source device, refer to the source device operating manual for details.
- 4 Select "GX-BT9 SHARP" from the source list. If Passcode\* is required, enter "0000".  
\* Passcode may be called PIN Code, Passkey, PIN number or Password.
  - 5 Pairing indicator (blue) will stop blinking once the unit is successfully paired with the source device. (Pairing information is now memorized in the unit.)  
Some audio source devices may connect with the unit automatically after pairing is completed, otherwise follow the instructions in the source device operating manual to start connection.
  - 6 Press **BLUETOOTH** button on remote control or source device to start Bluetooth streaming playback.

### Notes:

- If a device such as microwave oven, wireless LAN card, Bluetooth device or any other device that uses the same 2.4 GHz frequency near the system some sound interruption may be heard.
- The transmission distance of the wireless signal between the device and the main unit is about 10 m (32 feet), but may vary depending on your operating environment. If a steel concrete or metallic wall is between the device and the main unit, the system may not operate at all, because the wireless signal cannot penetrate metal.
- If this unit or the source device is turned off before Bluetooth connection is completed, pairing will not be completed and the pairing information will not be memorized. Repeat step 1 onward to start pairing again.
- To pair with other devices, repeat steps 1 - 4 for each device. This unit can be paired to a maximum of 99 devices. If subsequent device is paired, the oldest device paired, will be deleted and replaced with the new one.
- Once a device is ousted or deleted from the pairing list, the pairing information for the device is also deleted. To listen to the sound from the device again, it needs to be re-paired. Perform steps 1 - 4 to pair the device again.
- GX-BT9 supports Bluetooth profile AVRCP 1.4. If your device supports the same profile (refer to device manufacturer's specification), GX-BT9 is able to control the volume of the device.

### Note:

Some music applications do not support this feature, hence there will be no volume synchronisation between your device and the unit even if your Bluetooth device supports such profile.

## Listening to *Bluetooth* enabled devices (continued)

### ■ Listening to the sound

Check that:

- The source device *Bluetooth* functionality is ON.
- Pairing of this unit and the source device is completed.
- Unit is in connected mode (pairing indicator (BLUE) lights up.)

- 1 Press the ON/STANDBY button to turn the power on.
- 2 Press the *BLUETOOTH* button on the main unit or on the remote control to select *Bluetooth* function.
- 3 Start the *Bluetooth* connection from the *Bluetooth* stereo audio source device.
- 4 Playback will start automatically, otherwise press play (on remote control or source device).

#### Notes:

- For various *Bluetooth* operations, refer "NFC connection for audio playback" on page 11.
- If the source device has an extra bass function or equalizer function, set them to off. If these functions are on, sound may be distorted.

#### Notes:

- Make the *Bluetooth* connection again if the source device is not turned on, or its *Bluetooth* functionality is off or is in sleep mode.
- The volume of this unit may not be controlled as intended depending on the device.

### ■ To disconnect the *Bluetooth* device

Perform any of the followings.

- Disconnect the *Bluetooth* connection on the audio source device.  
Refer the operating manual supplied with the device.
- Turn off the *Bluetooth* stereo audio source device.
- Turn off this unit.
- Press the PAIRING button on the remote control.

### ■ Auto power on

During *Bluetooth* standby mode, the unit will automatically power on when the *Bluetooth* connection has been set up between the main unit and your device.

#### Note:

This function is not applicable during low power consumption (ECO) mode.

# Listening on Android™ devices

## ■ Introduction : Open Accessory

Open Accessory support allows external USB hardware (an Android USB accessory) to interact with an Android-powered device in a special accessory mode. When an Android-powered device is in accessory mode, the connected accessory acts as the USB host (powers the bus and enumerates devices) and the Android-powered device acts in the USB accessory role. Android USB accessories are specifically designed to attach to Android-powered devices and adhere to the Open Accessory Protocol, that allows them to detect Android-powered devices that support accessory mode.

## ■ Android device connection (USB)

### 1 Insert the connector to the Android device.

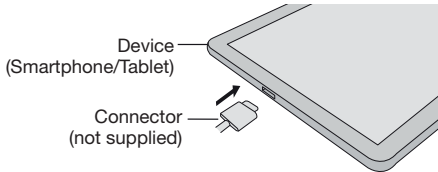

### 2 Plug in the Android device to the unit via USB connector.

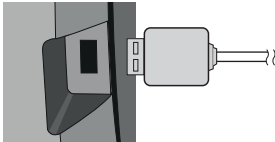

## ■ Android device playback

- 1 Press the ON/STANDBY button to turn the power on.
- 2 Press the USB ►/|| button on the main unit or the remote control to select USB function.
- 3 Connect the device (Smartphone/Tablet) to the unit.
- 4 Press play (on remote control or source device).

### Notes:

- If the source device has an extra bass or equalizer function, set them to off. If these functions are on, sound may be distorted.
- Incoming calls will pause the playback/application.
- Once the calls are answered, the conversation can only be heard through the built-in speaker of the cellular device. Turn on the device speaker or disconnect the device to start conversation.

## ■ To disconnect the Android device

- 1 Pause the playback or quit the application (app).
- 2 Disconnect the device from the USB terminal.

## ■ Various functions

Function	Remote control	Operation
Track up/down		Press in the playback or stop mode. If you press the button in the stop mode, press the ►/   button to start the desired track.
Fast forward/reverse		Press and hold down in the playback mode. Release the button to resume playback.

### Notes:

- If non-compatible device is detected "NOT SUPT" will be displayed.
- Controls (play/pause/skip up/skip down) will function based on actual application (app) controls used on Android devices.
- Stop button (■) is invalid during Android device playback.

Android is a trademark of Google Inc.

# Listening to the iPod or iPhone

## Made for:

- iPhone 6 Plus
- iPhone 6
- iPhone 5s
- iPhone 5c
- iPhone 5
- iPhone 4s
- iPhone 4
- iPhone 3GS
- iPhone 3G
- iPhone
- iPod touch (5th generation)
- iPod touch (4th generation)
- iPod touch (3rd generation)
- iPod touch (2nd generation)
- iPod touch (1st generation)
- iPod nano (7th generation)
- iPod nano (6th generation)
- iPod nano (5th generation)
- iPod nano (4th generation)
- iPod nano (3rd generation)
- iPod nano (2nd generation)

## Caution:

Please update your iPod and iPhone unit to the latest software version before using it. Please visit Apple's homepage to download the latest version for your iPod and iPhone.

## Notes:

- Once the iPod or iPhone is plugged in it will begin charging.
- Fully charge the iPod or iPhone with AC power before using GX-BT9 battery operation.
- The message "This accessory is not made to work with iPhone" or similar, may appear on the iPhone screen when:
  - battery is low.
  - the iPhone is not properly plugged in.
 If this occurs, remove and re-connect the iPhone.

## ■ iPod and iPhone connection

1 Insert the connector to the iPod or iPhone.

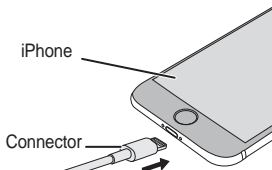

2 Connect the iPod or iPhone to the unit via USB connector.

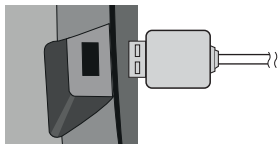

## ■ iPod or iPhone playback

- 1 Press the ON/STANDBY button to turn the power on.
- 2 Press the USB ►/|| button on the remote control or the main unit to select USB function.
- 3 Connect iPod or iPhone to the unit. "USB" will appear.

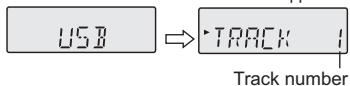

4 Press the USB ►/|| button to start playback.

## Note:

Stop button (■) is invalid during iPod or iPhone playback.

## ■ iPhone playback

- Sound will only switch from iPhone to the main unit after authentication process is completed in approximately 10 seconds.
- Incoming calls will pause the playback.
- Once the calls are answered, the conversation can only be heard through the built-in iPhone speaker. Turn on the iPhone speaker or disconnect the iPhone to start conversation.

## ■ To disconnect iPod or iPhone

It is safe to disconnect iPod or iPhone even during playback.

## ■ Various iPod and iPhone functions

Function	Main unit	Remote control	Operation
Play	USB 	USB 	Press in the pause mode.
Pause	USB 	USB 	Press in the playback mode.
Track up/down			Press in the playback or pause mode. If you press the button in the pause mode, press the ►/   button to start the desired track.
Fast forward/reverse			Press and hold down in the playback mode. Release the button to resume playback.
Display	—	DISPLAY 	Press to toggle display content.
Repeat	—		Press to toggle repeat mode.
Shuffle	—	RDM 	Press to toggle shuffle mode.

# Listening to USB mass storage device/MP3 player

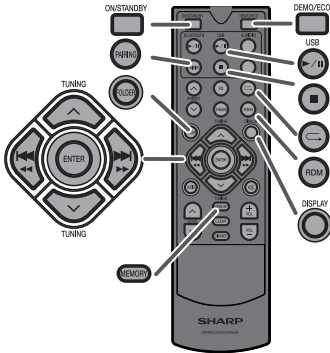
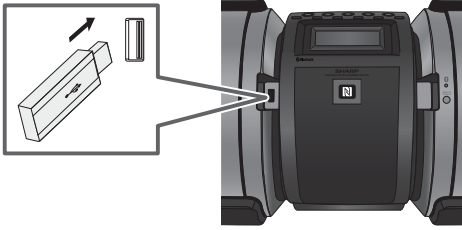

**Note:**  
This product is not compatible with MTP and AAC file systems from USB mass storage device or MP3 player.

## ■ To play back USB/MP3 player with folder mode off

- 1 Press the USB ►/II button on the remote control or the main unit to select USB function. Connect the USB memory device that has MP3/WMA format files on the unit. When the USB memory is connected to the main unit, the device information will be displayed.
- 2 Select desired file to be played back by pressing the ◀◀◀ or ▶▶▶ button.
- 3 Press the USB ►/II button. Playback will start and the file name will be displayed.
  - Title, Artist and Album name are displayed if they are recorded in the USB memory device.
  - Display content can be changed by pressing the DISPLAY button.

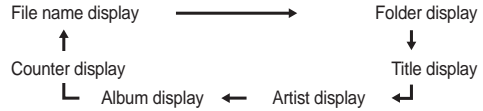

**Note:**  
To pause playback:  
Press the USB ►/II button.

## ■ To play back USB/MP3 player with folder mode on

- 1 Press the USB ►/II button on the remote control or the main unit to select USB function. Connect the USB memory device that has MP3/WMA format files on the unit. When the USB memory is connected to the main unit, the device information will be displayed.

- 2 Press the FOLDER button, and press the TUNING (▼ or ▲) button to select desired playback folder. To start playback with folder mode on, go to step 4. To change the playback folder, press the TUNING (▼ or ▲) button to select another folder.
- 3 Select desired file to be played back by pressing the ◀◀◀ or ▶▶▶ button.
- 4 Press the USB ►/II or ENTER button. Playback will start and the file name will be displayed.
  - Title, Artist and Album name are displayed if they are recorded in the USB memory device.
  - Display content can be changed by pressing the DISPLAY button.

## ■ To remove USB memory device

- 1 Press the DEMO/[ECO]/[M] button to stop playback.
- 2 Disconnect USB memory device from the USB terminal.

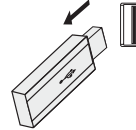

### Notes:

- SHARP will not be held liable for the loss of data while the USB memory device is connected to the audio system.
- Files compressed in MP3 and/or WMA format can be played back when connected to the USB terminal.
- This USB memory's format supports FAT 16 or FAT 32.
- SHARP cannot guarantee that all USB memory devices will work on this audio system.
- USB cable is not recommended for use in this audio system to connect to USB memory device. Use of the USB cable will affect the performance of this audio system. iPod and iPhone is not prone to this condition.
- This USB memory cannot be operated via USB hub.
- The USB terminal in this unit is not intended for a PC connection but is used for music streaming with a USB memory device.
- External HDD-storage cannot be played back via USB terminal.
- If the data inside the USB memory is large, it may take longer time for the data to be read.
- This product can play WMA and MP3 files. It will automatically detect the file type being played. If unplayable file is played on this product, "NOT SUPT" is indicated and the file will be automatically skipped. This will take a few seconds. If abnormal indications appear on the display due to the unspecified file, turn off the unit and then turn it on again.
- This product relates to USB mass storage devices and MP3 players. It may however face some irregularities due to various unforeseen reasons from some devices. Should this happen, turn off the unit and then turn it on again.
- MP3 player will not be charging in other than USB function. However, charging ability depends on type of MP3 player used.





# Advanced USB playback



## Repeat play

Repeat play can play one track, all tracks or a programmed sequence continuously.



### To repeat one track:

Press the  button repeatedly until "REP ONE" appears. Press the USB  button.

### To repeat all tracks:

Press the  button repeatedly until "REP ALL" appears. Press the USB  button.



### To repeat one folder (during folder mode on):

Press the  button repeatedly until "FOLD REP" appears. Press the USB  button.

### To repeat desired tracks:

Perform steps 1 - 5 in "Programmed play" section and then press the  button repeatedly until "REP ALL" appears.

### To cancel repeat play:

Press the  button repeatedly until "NORMAL" appears and "

 disappears.

### Caution:

After performing repeat play, be sure to press the DEMO/[ECO]/ button. Otherwise, the device will play continuously.

## Random play

The tracks on the device can be played in random order automatically.



### To random play all tracks:

Press RDM button on the remote control until "RANDOM" appears. Press the USB  button.







### To cancel random play:

Press the RDM button again. "RDM" indicator will disappear.

### Notes:

- If you press the  button during random play, you can move to the track selected next by the random operation. On the other hand, the  button does not allow you to move to the previous track. The beginning of the track being played will be located.
- In random play, the unit will select and play tracks automatically. (You cannot select the order of the tracks.)
- In folder mode on, only tracks in selected folder will be played randomly.

## Programmed play (MP3/WMA)

- 1 While in the stop mode, press the MEMORY button to enter the programming save mode.
- 2 Press the TUNING ( or ) button on the remote control to select the desired folder.  
Then press the   or  button on the remote control to select the desired tracks.
- 3 Press the MEMORY button to save the folder and track number.
- 4 Repeat steps 2 - 3 for other folder/tracks. Up to 32 tracks can be programmed.
- 5 Press the USB  or ENTER button to start playback.

### To cancel the programmed play mode:

During programmed stop mode, press the DEMO/[ECO]/ button. The display will show "MEMCLEAR" and all the programmed contents will be cleared.









### Adding tracks to the program:

If a program has been previously stored, the "MEM" indicator will be displayed. Press the MEMORY button. Then follow steps 2 - 3 to add tracks.

### Notes:

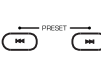
- During the program operation, random play is not possible.
- If you press the ON/STANDBY button to enter the *Bluetooth* standby mode or change the function from the USB to another, the programmed selections will be cleared.

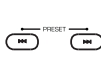
## Various USB functions

Function	Main unit	Remote control	Operation
Play	USB 	USB 	Press in the pause mode.
Pause	USB 	USB 	Press in the playback mode.
Track up/down			Press in the playback or pause mode. If you press the button in the pause mode, press the  button to start the desired track.
Fast forward/reverse			Press and hold down in the playback mode. Release the button to resume playback.

### Notes:

- If USB memory device is not connected, "NO MEDIA" will be shown on the display.
- Fast forward/reverse is invalid when playing back a variable bitrate file.

### Notes:

- This unit only supports "MPEG-1 Audio Layer-3" format. (Sampling Frequency is 32, 44.1, 48kHz)
- Playback order for MP3 files may differ depending on the writing software used during file download.
- Bitrate which is supported by MP3 is 32-320 kbps, WMA is 64-160 kbps.
- For MP3/WMA files, please put ".MP3" or ".WMA" extension. Files cannot be played back if there is no MP3/WMA extension.
- Playlists are not supported on this unit.
- This unit can display Folder Name or File Name up to 32 characters.
- Maximum total number of MP3/WMA files is 65025.
- Total number of folders read is 999 including folder with non-playable file. However, the display shows only folder with MP3 files.
- The display playback time may not be displayed correctly when playing back a variable bitrate file.
- The ID3TAG information supported are TITLE, ARTIST and ALBUM only. Title name, artist name and album name can be displayed by pressing the DISPLAY button during file playback or pause mode.
- WMA meta tag also supports title, artist and album name which are recorded in WMA files. Copyright protected WMA files cannot be played back.

# Listening to the radio

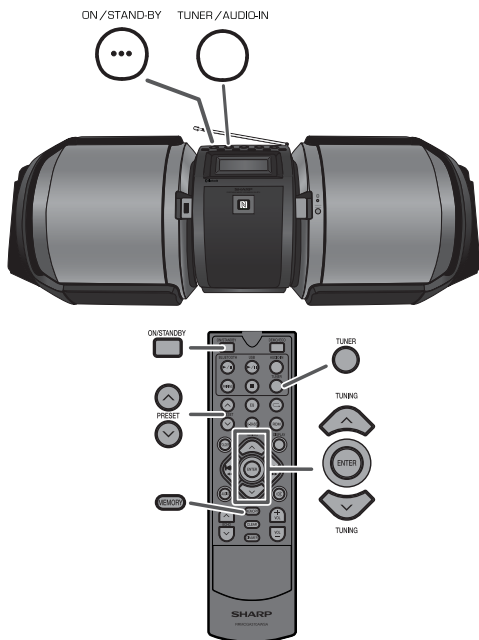

## ■ Tuning

- 1 Press the ON/STANDBY button to turn the power on.
- 2 Press the TUNER button on the remote control or TUNER/AUDIO IN button on the main unit repeatedly to select FM Stereo or FM Mono.
- 3 Press the TUNING (✓ or ∧) button on the remote control to tune in to the desired station.
  - **Manual tuning:**  
Press the TUNING (✓ or ∧) button repeatedly to tune in to the desired station.
  - **Auto tuning:**  
When the TUNING (✓ or ∧) button is pressed for more than 0.5 seconds, scanning will start automatically and the tuner will stop at the first receivable broadcast station.

### Notes:

- When radio interference occurs, auto scan tuning may stop automatically at that point.
- Auto scan tuning will skip weak signal stations.
- To stop the auto tuning, press the TUNING (✓ or ∧) button again.

### To receive an FM stereo transmission:

- Press the TUNER button to select stereo mode and "ST" indicator will be displayed. "OD" will appear when an FM broadcast is in stereo.
- If the FM reception is weak, press the TUNER button to extinguish the "ST" indicator. The reception changes to monaural, and the sound becomes clearer.

## ■ Memorizing a station

You can store 40 FM stations in memory and recall them at the push of a button. (Preset tuning)

- 1 Perform steps 1 - 3 in "Tuning".
- 2 Press the MEMORY button.
- 3 Within 30 seconds, press the PRESET (✓ or ∧) button to select the preset channel number. Store the stations in memory, in order, starting with preset channel 1.
- 4 Within 30 seconds, press the MEMORY button to store that station in memory. If the "MEM" indicator and preset number disappear before the station is memorized, repeat the operation from step 2.
- 5 Repeat steps 1 - 4 to set other stations, or to change a preset station. When a new station is stored in the memory, the station previously memorized for that preset channel number will be erased.

### Note:

The backup function protects the memorized stations for a few days should there be a power failure or the AC power cord become disconnected.

## ■ To recall a memorized station

- 1 Press the PRESET (✓ or ∧) button for less than 0.5 seconds to select the desired station.

## ■ To scan the preset stations

The stations saved in the memory can be scanned automatically. (Preset memory scan)

- 1 Press the PRESET (✓ or ∧) button for more than 0.5 seconds. The preset number will flash and the programmed stations will be tuned in sequentially, for 5 seconds each.
- 2 Press the PRESET (✓ or ∧) button again when the desired station is located.

## ■ To erase entire preset memory

- 1 Press the ON/STANDBY button to enter the power on.
- 2 Press TUNER button on the remote control or TUNER/AUDIO IN button on the main unit to select TUNER function.
- 3 Press and hold CLEAR button on the remote control until "TUNCLEAR" appears.



## Connecting other equipment

The connection cord is not included. Purchase a commercially available cord as shown below.

### ■ Connecting a guitar / microphone

#### Caution:

Be careful not to connect a bass guitar as it might damage this unit.

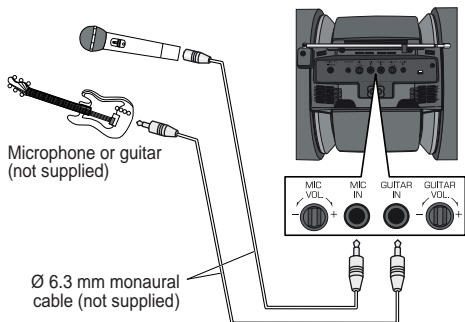

- 1 Set the guitar/microphone volume (GAIN) knob to the minimum level.
- 2 Connect a guitar/microphone to the correct input jack.
  - Use a microphone with a 6.3 mm (1/4") diameter plug.
  - Use a standard plug adaptor when using a microphone with a 3.5 mm (1/8") diameter plug.
- 3 Arrange the guitar/microphone cables into the grooves of the cable holder on the left or the right side of the unit. Then, thread the cable through the bottom of the unit.

**Do not let the cables be on top of the unit when using guitar/microphone as it may cause the unit to roll over causing damage and injury.**

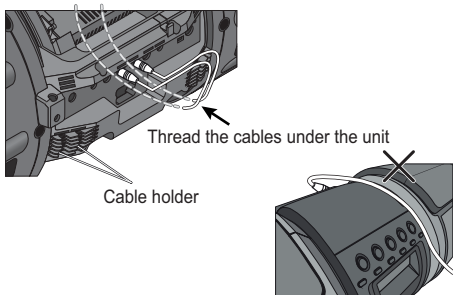

- 4 Connect the cables to a guitar/microphone.
- 5 Select a source.
  - To mix a guitar or microphone sound with a source sound, select the playback source (*Bluetooth*/USB/Audio In/Tuner).
  - To play a guitar or using the microphone only, select 'AUDIO IN' function. Make sure there is no playback from Audio In connection.
- 6 Adjust the volume (GAIN) knob on the connected equipment.
  - To enjoy a guitar distortion effect, turn the guitar volume (GAIN) knob to almost maximum level.

#### Caution:

- When not using the guitar/microphone, remove it from the jack.
- Before disconnecting the guitar/microphone, set the guitar/microphone volume (GAIN) knob to the minimum level.

### ■ Echo control (Karaoke)

Toggle the echo level with ECHO  $\wedge$  or ECHO  $\vee$  button.

ECHO OFF ..... ECHO 08

#### Notes:

- The sound is produced in 2-channel stereo automatically while playing karaoke.
- When you sing too loud through the microphone, your voice may be distorted depending on the devices connected. If this happens, lower the microphone volume.
- If an extremely sensitive microphone is used, howling may be generated.
- Unidirectional microphone is more appropriate for vocal use.
- When you connect or disconnect a microphone, the sound is muted for few seconds.
- Karaoke is not supported at Tuner function.

#### If squealing occurs:

- Reduce the microphone volume.
- Change the direction of the microphone.
- Reduce the volume of the main unit.
- Move the microphone away from the speakers.

### ■ To change the audio mode

Press the AUDIO button on the remote control until the desired audio mode is displayed. Each time the AUDIO button is pressed, the mode will change as follows:

<b>STEREO</b>	Sounds on the left and right channels are played.
<b>L+L</b>	Sounds on the left channel only are played.
<b>R+R</b>	Sounds on the right channel only are played.
<b>V CANCEL</b>	Vocal is canceled.

STEREO → L+L → R+R → V CANCEL

#### Notes:

- The default audio mode setting is "STEREO".
- When playing a sound on which a vocal and music have been separately recorded, select the audio mode as desired.
- Use sources recorded in stereo. The function will not work with mono sources.
- With some sources the original vocals may still be heard.

#### Notes on sound multiplexed:

- Sound multiplexed sources are sources on which the main vocal and the BGM (Background music) have been recorded on one of the two channels and only the BGM on the other.
- The function will not work properly with sources which do not belong to this group.
- Music on which vocal has been recorded on the left channel and music on the right may not play properly.

## Connecting other equipment (continued)

### ■ Listening to the playback sounds of portable audio player, etc.

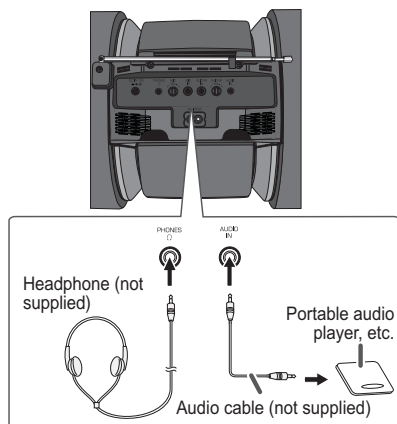

- 1 Use a connection cord to connect the portable audio player etc. to the AUDIO IN jack. When using video equipment, connect the audio output to this unit and the video output to a television.
- 2 Press the ON/STANDBY button to turn the power on.
- 3 Press the AUDIO IN button on the remote control or TUNER/AUDIO IN button repeatedly on the main unit to select AUDIO IN function.
- 4 Play the connected equipment. If volume level of the connected device is too high, sound distortion may occur. Should this happen, lower the volume of the connected device. If volume level is too low, increase the volume of the connected device.

#### Note:

To prevent noise interference, place the unit away from the television.

### ■ Headphones

- Do not turn the volume on to full at switch on and listen to music at moderate levels. Excessive sound pressure from earphones and headphones can cause hearing loss.
- Before plugging in or unplugging the headphone, reduce the volume.
- Be sure your headphone has a 3.5 mm (1/8") diameter plug and impedance between 16 and 50 ohms. The recommended impedance is 32 ohms.
- Plugging in the headphone disconnects the speakers automatically. Adjust the volume using the VOLUME control.

## Troubleshooting chart

Many potential problems can be resolved by the owner without calling a service technician.

If something is wrong with this product, check the following before calling your authorised SHARP dealer or service center.

### ■ General

Symptom	Possible cause
<ul style="list-style-type: none"> <li>● When a button is pressed, the unit does not respond.</li> </ul>	<ul style="list-style-type: none"> <li>● Set the unit to the power standby mode and then turn it back on.</li> <li>● If the unit still malfunctions, reset it. (Refer "Factory reset, clearing all memory".)</li> </ul>
<ul style="list-style-type: none"> <li>● No sound is heard.</li> </ul>	<ul style="list-style-type: none"> <li>● The volume level is set to "MIN".</li> <li>● The headphones are connected.</li> </ul>
<ul style="list-style-type: none"> <li>● Sound too low or distorted.</li> <li>● Power suddenly shuts down.</li> </ul>	<ul style="list-style-type: none"> <li>● The batteries are depleted. Change the batteries.</li> </ul>

### ■ Remote control

Symptom	Possible cause
<ul style="list-style-type: none"> <li>● The remote control does not operate.</li> </ul>	<ul style="list-style-type: none"> <li>● The AC power cord of the unit is not plugged in.</li> <li>● Wrong battery polarity.</li> <li>● The batteries are exhausted.</li> <li>● The distance or angle is incorrect.</li> <li>● The remote control sensor receives strong light or sunlight.</li> </ul>

### ■ NFC / Bluetooth

Symptom	Possible cause
<ul style="list-style-type: none"> <li>● No sound is heard.</li> </ul>	<ul style="list-style-type: none"> <li>● The unit is too far from the Bluetooth stereo audio source device.</li> <li>● The unit is not paired with the Bluetooth stereo audio source device.</li> </ul>
<ul style="list-style-type: none"> <li>● Bluetooth sound is interrupted or distorted.</li> </ul>	<ul style="list-style-type: none"> <li>● The unit is too near to a device that generates electromagnetic radiation.</li> <li>● There is an obstacle between the unit and the Bluetooth stereo audio source device.</li> </ul>
<ul style="list-style-type: none"> <li>● NFC-enabled device cannot connect to Bluetooth via NFC tag.</li> </ul>	<ul style="list-style-type: none"> <li>● Main unit is not in Bluetooth pairing mode. Perform "NFC connection for audio playback". (Refer page 11.)</li> </ul>

## Troubleshooting chart (continued)

### ■ Open Accessory

Symptom	Possible cause
● No sound is produced.	<ul style="list-style-type: none"> <li>● The device is not playing.</li> <li>● The device is not properly plugged in to the unit.</li> <li>● The AC power cord of the unit is not plugged in.</li> </ul>
● Device will not charge.	<ul style="list-style-type: none"> <li>● The device is not making full contact with the USB terminal.</li> </ul>

### ■ Tuner

Symptom	Possible cause
● The radio makes unusual noises continuously.	<ul style="list-style-type: none"> <li>● The unit is placed near the TV or computer.</li> <li>● The FM antenna is not properly extended or positioned.</li> </ul>

### ■ USB

Symptom	Possible cause
● Device cannot be detected.	<ul style="list-style-type: none"> <li>● There is no MP3/WMA file inside the device.</li> <li>● The device is not properly connected.</li> <li>● A MTP device is connected.</li> <li>● The device contains AAC file only.</li> </ul>
● Playback does not start.	<ul style="list-style-type: none"> <li>● A copyright-protected WMA or false MP3 file is being played back.</li> </ul>
<ul style="list-style-type: none"> <li>● Wrong time display.</li> <li>● Wrong file name display.</li> </ul>	<ul style="list-style-type: none"> <li>● A Variable Bitrate files are being played back.</li> <li>● The File Name was written in other than English characters.</li> </ul>

### ■ iPod or iPhone

Symptom	Possible cause
● No sound is produced.	<ul style="list-style-type: none"> <li>● The iPod or iPhone is not playing.</li> <li>● The iPod or iPhone is not properly connected to the unit.</li> <li>● The AC power cord of the unit is not plugged in.</li> </ul>
● iPod or iPhone will not charge.	<ul style="list-style-type: none"> <li>● The iPod or iPhone is not making full contact with the connector.</li> <li>● Using iPod (3rd generation).</li> <li>● The iPod or iPhone is not supported. Refer to page 15 for compatible models.</li> </ul>
● "This accessory is not made to work with iPhone" or "This accessory is not supported by iPhone" appears on iPhone screen.	<ul style="list-style-type: none"> <li>● The iPhone battery is low. Please charge the iPhone.</li> </ul>

### ■ Condensation

Sudden temperature changes, storage or operation in an extremely humid environment may cause condensation inside the cabinet or on the transmitter on the remote control. Condensation can cause the unit to malfunction. If this happens, leave the power on until normal playback is possible (about 1 hour). Wipe off any condensation on the transmitter with a soft cloth before operating the unit.

### ■ If problem occurs

When this product is subjected to strong external interference (mechanical shock, excessive static electricity, abnormal supply voltage due to lightning, etc.) or if it is operated incorrectly, it may malfunction.

**If such a problem occurs, do the following:**

- 1 Set the unit to the standby mode and turn the power on again.
- 2 If the unit is not restored in the previous operation, unplug and plug in the unit again, and then turn the power on.

**Note:**

If neither operation above restores the unit, clear all the memory by resetting it.

### ■ Factory reset, clearing all memory

- 1 Press the ON/STANDBY button to turn the power on.
- 2 Press the AUDIO IN button on the remote control or TUNER/AUDIO IN button on the main unit repeatedly to select AUDIO IN function.
- 3 Press ◀◀ button on the main unit once.
- 4 Press and hold USB ▶▶ button on the main unit until reset appears.



**Caution:**

This operation will erase all data stored in memory including tuner preset.

## Maintenance

### ■ Cleaning the cabinet

Periodically wipe the cabinet with a soft cloth and a diluted soap solution, then with a dry cloth.

#### Caution:

- Do not use chemicals for cleaning (gasoline, paint thinner, etc.). It may damage the cabinet.
- Do not apply oil to the inside of the unit. It may cause malfunctions.

## Specifications

As part of our policy of continuous improvement, SHARP reserves the right to make design and specification changes for product improvement without prior notice. The performance specification figures indicated are nominal values of production units. There may be some deviations from these values in individual units.

### ■ General

<b>Power source</b>	AC 110 - 240 V ~ 50/60 Hz 15 V --- (UM/SUM-1, R20) x 10 DC IN 12 V ---
<b>Power consumption</b>	AC: Power on: 30 W DC 12 V: 4.5 A
<b>Dimensions</b>	Width: 30 - 5/16" (750 mm) Height: 10 - 13/16" (275 mm) Depth: 11 - 1/16" (280 mm)
<b>Weight (without batteries and accessories)</b>	14.6 lbs. (6.6 kg)
<b>Weight (with batteries)</b>	Approximately 18.1 lbs (8.2 kg)

### ■ Amplifier

<b>Output power</b>	Front speaker: RMS: Total 34 watt (17 W per channel into 3 ohms at 1 kHz, 10% T.H.D.) FTC: 12.5 watt minimum RMS per channel into 3 ohms from 200 Hz to 20 kHz, 10% T.H.D.  Subwoofer: RMS: Total 66 watt into 3 ohms at 100 Hz, 10% T.H.D. FTC: 50 watt minimum RMS into 3 ohms from 70 Hz to 200 Hz, 10% T.H.D.
<b>Output terminals</b>	Headphones: 16 Ω - 50 Ω (recommended: 32 Ω)
<b>Input terminals</b>	Audio In (audio signal): 500 mV/47 k ohms Mic Input: 200 Ω - 2 kΩ Ø 6.3 mm Guitar: 100 kΩ - 1 MΩ Ø 6.3 mm

### ■ Bluetooth interface

<b>Bluetooth Frequency Band</b>	2.400GHz - 2.480GHz
<b>Compatible Bluetooth Profile</b>	A2DP (Advanced Audio Distribution Profile), AVRCP (Audio/Video Remote Control Profile) Bluetooth 2.1 +EDR

## Specifications (continued)

### ■ USB (MP3 / WMA)

<b>USB host interface</b>	<ul style="list-style-type: none"> <li>● Complies with USB 1.1 (Full Speed)/2.0 Mass Storage Class.</li> <li>● Support Bulk only and CBI protocol.</li> </ul>
<b>Support file</b>	<ul style="list-style-type: none"> <li>● MPEG 1 Layer 3</li> <li>● WMA (Non DRM)</li> </ul>
<b>Bitrate support</b>	<ul style="list-style-type: none"> <li>● MP3 (32 ~ 320 kbps)</li> <li>● WMA (64 ~ 160 kbps)</li> </ul>
<b>Other</b>	<ul style="list-style-type: none"> <li>● Maximum total number of MP3/WMA files is 65025.</li> <li>● Maximum total number of folders is 999 INCLUSIVE of root directory.</li> <li>● The ID3TAG information supported are TITLE, ARTIST and ALBUM only.</li> <li>● Supports ID3TAG version 1 and version 2.</li> </ul>
<b>File system support</b>	<ul style="list-style-type: none"> <li>● Support USB devices with FAT 16/ FAT 32.</li> </ul>

### ■ Tuner

<b>Frequency range</b>	FM: 87.5 - 108.0 MHz
<b>Preset</b>	40 (FM station)

### ■ Speaker

<b>Type</b>	2-way type speaker system Front Speakers: 3-1/8" (8 cm) - 3 Ω - Full Range Subwoofer: 5-1/8" (13 cm) - 6 Ω - Woofer (light-up)
<b>Maximum input power</b>	Front Speakers: 34W / Channel Subwoofer: 66W / Channel
<b>Rated input power</b>	Front Speakers: 17W / Channel Subwoofer: 33W / Channel