



TEST REPORT

FCC ID: 2AB3E-IUL8 IC: 10541A-IUL8

Applicant : ION AUDIO,LLC
Address : 200 Scenic View Drive, Cumberland, RI 02864, U.S.A

Equipment under Test (EUT):

Name	:	Smart Badge
Model	:	iUL8
Trademark	:	ION

Standards: FCC PART 15, SUBPART C : 2015 (Section 15.247)
ANSI C63.4:2014 and ANSI C63.10:2013

Report No : T1851503 08
Date of Test : October 16- October 28, 2015
Date of Issue : November 03, 2015

Test Result : PASS

In the configuration tested, the EUT complied with the standards specified above
Authorized Signature

(Mark Zhu)
Manager

The manufacture should ensure that all the products in series production are in conformity with the product sample detailed in this report. If the product in this report is used in any configuration other than that detailed in the report, the manufacturer must ensure the new system complies with all relevant standards. Any mention of Shenzhen Alpha Product Testing Co., Ltd. Or test done by Shenzhen Alpha Product Testing Co., Ltd. Approvals in connection with, distribution or use of the product described in this report must be approved by Shenzhen Alpha Product Testing Co., Ltd. Approvals in writing.

TABLE OF CONTENT

Description	Page
1 General Information -----	5
1.1 Description of Device (EUT)-----	5
1.2 Description of Test Facility-----	6
2 EMC Equipment List -----	6
3 Test Procedure -----	7
4 Summary of Measurement -----	8
4.1 Summary of test result-----	8
4.2 Test connection-----	8
4.3 Assistant equipment used for test-----	9
4.4 Test mode-----	9
4.5 Test Conditions-----	10
4.6 Measurement Uncertainty (95% confidence levels, k=2)-----	10
5 Spurious Emission -----	11
5.1 Radiation Emission-----	11
5.1.1 Radiation Emission Limits(15.209)-----	11
5.1.2 Test Setup-----	11
5.1.3 Test Procedure-----	13
5.1.4 Test Equipment Setting For emission test Result-----	13
5.1.5 Test Condition-----	14
5.1.6 Test Result-----	14
6 POWER LINE CONDUCTED EMISSION -----	20
6.1 Conducted Emission Limits(15.207)-----	20
6.2 Test Setup-----	20
6.3 Test Procedure-----	21
6.4 Test Results-----	21
7 Conducted Maximum Output Power -----	24
7.1 Test limit-----	24
7.2 Test Procedure-----	24
7.3 Test Setup-----	24
7.4 Test Results-----	24
8 PEAK POWER SPECTRAL DENSITY -----	26
8.1 Test limit-----	26
8.2 Method of measurement-----	26
8.3 Test Setup-----	26
8.4 Test Results-----	27
9 Bandwidth -----	30
9.1 Test limit-----	30
9.2 Method of measurement-----	30
9.3 Test Setup-----	30
9.4 Test Results-----	30
10 Band Edge Check -----	34
10.1 Test limit-----	34
10.2 Test Procedure-----	34
10.3 Test Setup-----	34
10.4 Test Result-----	34

11	Antenna Requirement	38
11.1	Standard Requirement	38
11.2	Antenna Connected Construction	38
11.3	Result	38
12	Test setup photo	39
12.1	Photos of Radiated emission	39
12.2	Photos of Conducted Emission test	40
12	Photographs of EUT	41

TEST REPORT VERIFICATION

Applicant : ION AUDIO,LLC
 Manufacturer : ION AUDIO,LLC
 EUT Description : **Smart Badge**

(A) Model No. : **iUL8**
 (B) Trademark : **ION**
 (C) Ratings Supply : **DC 3.7V from Battery or DC 5V from USB port**
 (D) Test Voltage : **DC 3.7V from Battery or DC 5V from USB port**

Measurement Standard Used:

FCC Rules and Regulations Part 15 Subpart C 2015, ANSI C63.4-2014

The device described above is tested by Shenzhen Alpha Product Testing Co., Ltd. to determine the maximum emission levels emanating from the device. The maximum emission levels are compared to the FCC Part 15 Subpart C limits both conducted and radiated emissions. The test results are contained in this test report and Shenzhen Alpha Product Testing Co., Ltd. is assumed of full responsibility for the accuracy and completeness of these tests.

After the test, our opinion is that EUT compliance with the requirement of the above standards.

This report applies to above tested sample only. This report shall not be reproduced in parts without written approval of Shenzhen Alpha Product Testing Co., Ltd.

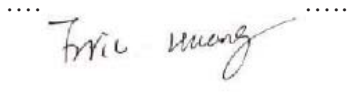
Tested by (name + signature).....: Eric Huang
 Test Engineer 

Approved by (name + signature).....: Simple Guan
 Project Manager 

Date of issue..... : November 03, 2015

1 General Information

1.1 Description of Device (EUT)

Trade Name : ION

EUT : Smart Badge

Model No. : iUL8

DIFF : N/A

Radio Technology : Bluetooth 4.0

Antenna Type : Integrated Antenna, Maximum Gain is 0dBi for Bluetooth 4.0

Operation : 2402MHz -2480MHz
frequency

Channel No. : 40 Channels

Modulation : GFSK

Power Supply : DC 3.7V from battery or DC 5V from USB port

Applicant : ION AUDIO,LLC

Address : 200 Scenic View Drive, Cumberland, RI 02864, U.S.A

manufacture : ION AUDIO, LLC

Address : 200 Scenic View Drive, Cumberland, RI 02864, U.S.A.

1.2 Description of Test Facility

Shenzhen Alpha Product Testing Co., Ltd
 Building B, East Area of Nanchang Second, Industrial Zone, Gushu 2nd Road,
 Bao'an, Shenzhen, China

August 11, 2014 File on Federal Communication Commission
 Registration Number: 203110

July 18, 2014 Certificated by IC
 Registration Number: 12135A

2 EMC Equipment List

Equipment	Manufacture	Model No.	Serial No.	Last cal.	Cal Interval
3m Semi-Anechoic	ETS-LINDGREN	N/A	SEL0017	2015.01.19	1Year
Spectrum analyzer	Agilent	E4407B	MY46185649	2015.01.19	1Year
Receiver	R&S	ESCI	1166.5950K03-1011	2015.01.19	1Year
Receiver	R&S	ESCI	101202	2015.01.19	1Year
Bilog Antenna	Schwarzbeck	VULB 9168	VULB9168-438	2015.01.21	1Year
Horn Antenna	EMCO	3115	640201028-06	2015.01.21	1Year
Active Loop Antenna	Beijing Daze	ZN30900A	SEL0097	2015.01.21	1Year
Cable	Resenberger	N/A	No.1	2015.01.19	1Year
Cable	SCHWARZBECK	N/A	No.2	2015.01.19	1Year
Cable	SCHWARZBECK	N/A	No.3	2015.01.19	1Year
Pre-amplifier	Schwarzbeck	BBV9743	9743-019	2015.01.19	1Year
Pre-amplifier	R&S	AFS33-18002650-30-8P-44	SEL0080	2015.01.19	1Year
Base station	Agilent	E5515C	GB44300243	2015.01.19	1 Year
Temperature controller	Terchy	MHQ	120	2015.01.19	1Year

Power divider	Anritsu	K240C	020346	2015.01.19	1 Year
Signal Generator	HP	83732B	VS3449051	2015.01.19	1 Year
Power Meter	Anritsu	ML2487A	6K00001491	2015.01.19	1Year
Power sensor	Anritsu	ML2491A	32516	2015.01.19	1Year
L.I.S.N.#1	Schwarzbeck	NSLK8126	8126466	2015.01.19	1Year
L.I.S.N.#2	ROHDE&SCHWARZ	ENV216	101043	2015.01.19	1 Year

3 Test Procedure

POWER LINE CONDUCTED INTERFERENCE: The test procedure used was ANSI Standard ANSI C63.4:2014 using a 50 u H LISN. Both Lines were observed. The bandwidth of the receiver was 10kHz with an appropriate sweep speed. The ambient temperature of the EUT was 25°C with a humidity of 58%.

RADIATION INTERFERENCE: The test procedure used was ANSI Standard ANSI C63.4:2014 using a ANRITSU spectrum analyzer with a pre-selector. The analyzer was calibrated in dB above a micro volt at the output of the antenna. The resolution bandwidth was 100kHz and the video bandwidth was 300 kHz up to 1 GHz and 1 MHz with a video BW of 3MHz above 1 GHz. The ambient temperature of the EUT was 25°C with a humidity of 58%.

FORMULA OF CONVERSION FACTORS: The Field Strength at 3m was established by adding the meter reading of the spectrum analyzer (which is set to read in units of dBuV) to the antenna correction factor supplied by the antenna manufacturer and cable loss. The antenna correction factors and cable loss are stated in terms of dB. The gain of the Pre-selector was accounted for in the Spectrum Analyzer Meter Reading.

Example:

Freq (MHz) METER READING + ACF + CABLE = FS

33.20 dBuV + 10.36 dB + 0.9 dB= 44.46 dBuV/m @ 3m

ANSI STANDARD ANSI C63.4:2014 10.1.7 MEASUREMENT PROCEDURES: The EUT was placed on a table 80 cm high and with dimensions of 1m by 1.5m. The EUT was placed in the center of the table (1.5m side). The table used for radiated measurements is capable of continuous rotation. When an emission was found, the table was rotated to produce the maximum signal strength. At this point, the antenna was raised and lowered from 1m to 4m. The antenna was placed in both the horizontal and vertical planes. The situation was similar for the conducted measurement except that the table did not rotate. The EUT was setup as described in ANSI Standard ANSI C63.4:2014 10.1.7 with the EUT 40 cm from the vertical ground wall.

4 Summary of Measurement

4.1 Summary of test result

Test Item	Test Requirement	Standards Paragraph	Result
Spurious Emission	FCC PART 15:2015	Section 15.247	Compliance
Conduction Emission	FCC PART 15:2015	Section 15.207	Compliance
Bandwidth Test	FCC PART 15:2015	Section 15.247	Compliance
Peak Power	FCC PART 15:2015	Section 15.247	Compliance
Power Density	FCC PART 15:2015	Section 15.247	Compliance
Band Edge	FCC PART 15:2015	Section 15.247	Compliance
Antenna Requirement	FCC PART 15:2015	Section 15.203	Compliance

Note: The EUT has been tested as an independent unit. And Continual Transmitting in maximum power.

4.2 Test connection

EUT

4.3 Assistant equipment used for test

Description	:	Notebook
Manufacturer	:	ACER
Model No.	:	ZQT
Remark: FCC DOC approved		

4.4 Test mode

Dutycycle :100%			
Keeping TX			
Mode	data rate (Mbps)(see Note)	Channel	Frequency (MHz)
GFSK	1	Low :CH1	2402
	1	Middle: CH19	2440
	1	High: CH39	2480
Note: According exploratory test, EUT will have maximum output power in those data rate. so those data rate were used for all test.			

4.5 Test Conditions

Temperature range	21-25°C
Humidity range	40-75%
Pressure range	86-106kPa

4.6 Measurement Uncertainty (95% confidence levels, k=2)

Item	MU	Remark
Uncertainty for Power point Conducted Emissions Test	2.42dB	
Uncertainty for Radiation Emission test in 3m chamber (below 30MHz)	2.13 dB	Polarize: V
	2.57dB	Polarize: H
Uncertainty for Radiation Emission test in 3m chamber (30MHz to 1GHz)	3.54dB	Polarize: V
	4.1dB	Polarize: H
Uncertainty for Radiation Emission test in 3m chamber (1GHz to 25GHz)	2.08dB	Polarize: H
	2.56dB	Polarize: V
Uncertainty for radio frequency	1×10^{-9}	
Uncertainty for conducted RF Power	0.65dB	
Uncertainty for temperature	0.2°C	
Uncertainty for humidity	1%	
Uncertainty for DC and low frequency voltages	0.06%	

5 Spurious Emission

5.1 Radiation Emission

5.1.1 Radiation Emission Limits(15.209)

Frequencies (MHz)	Field Strength (micorvolts/meter)	Measurement Distance (meters)
0.009~0.490	2400/F(KHz)	300
0.490~1.705	24000/F(KHz)	30
1.705~30.0	30	30
30~88	100	3
88~216	150	3
216~960	200	3
Above 960	500	3

Harmonic emissions limits comply with below 54 dBuV/m at 3m. Other emissions radiated outside of the specified frequency bands, except for harmonics, shall be attenuated by at least 50 dB below the level of the fundamental or comply with the radiated emissions limits specified in section 15.209(a) limit in the table below has to be followed.

NOTE:

- a) The tighter limit applies at the band edges.
- b) Emission Level(dB uV/m)=20log Emission Level(uv/m)

5.1.2 Test Setup

See the next page

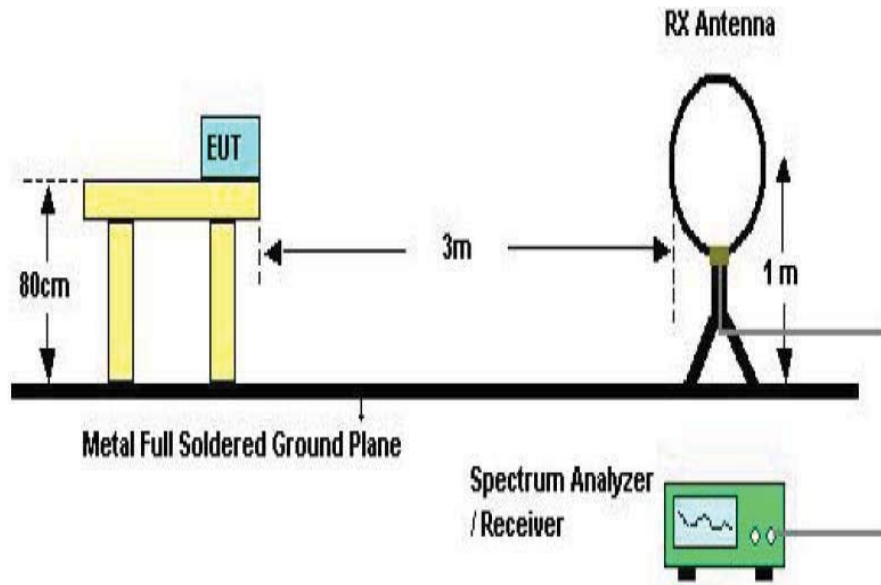

Below 30MHz Test Setup

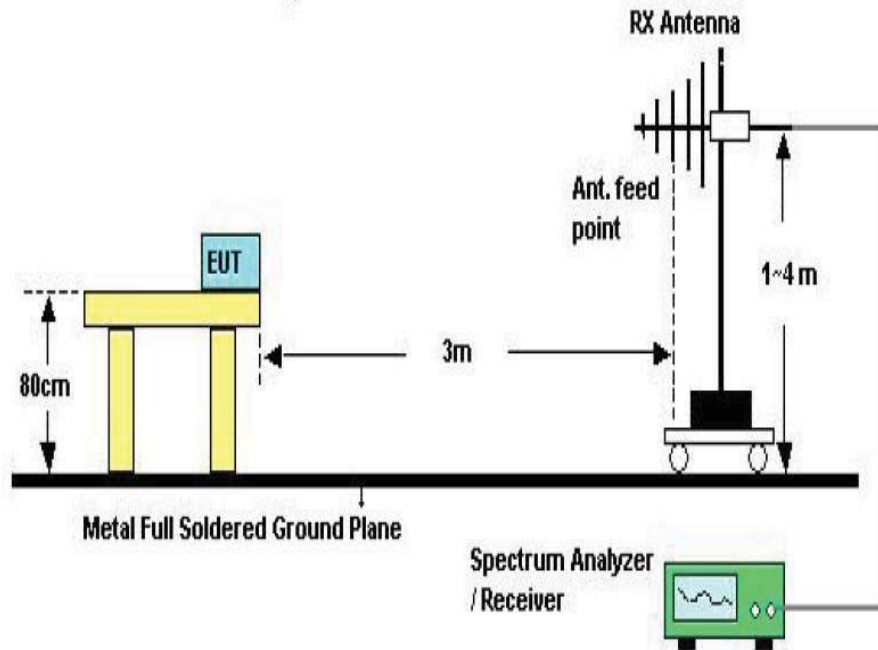

Above 30MHz Test Setup

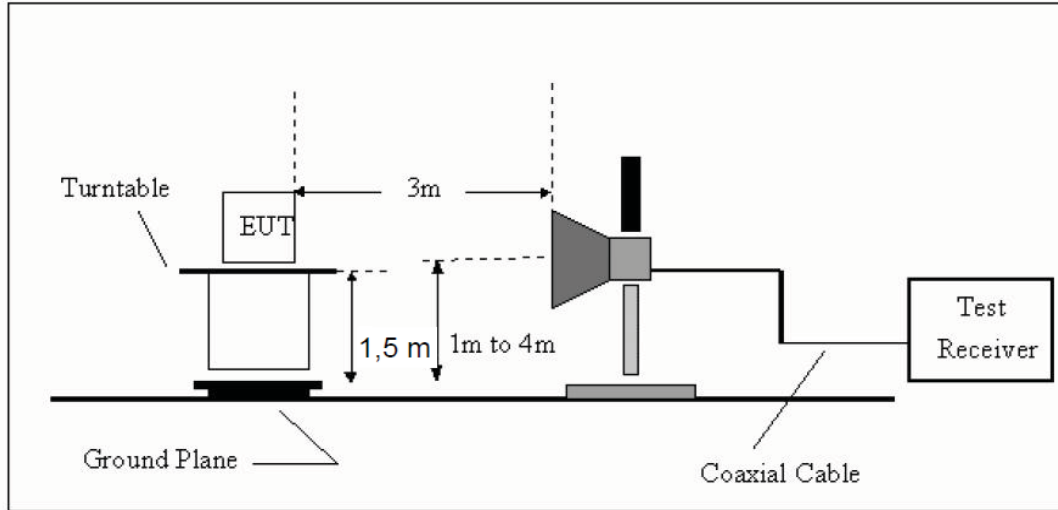

Above 1GHz Test Setup

5.1.3 Test Procedure

- a) The measuring distance of 3m shall be used for measurements at frequency up to 1GHz and above 1GHz, The EUT was placed on a rotating 0.8 m high above ground for below 1GHz and 1.5m high for above1GHz testing, The table was rotated 360 degrees to determine the position of the highest radiation
- b) The Test antenna shall vary between 1m and 4m,Both Horizontal and Vertical antenna are set of make measurement.
- c) The initial step in collecting conducted emission data is a spectrum analyzer Peak detector mode pre-scanning the measurement frequency range. Significant Peaks are then marked. and then Qusia Peak Detector mode premeasured
- d) If Peak value comply with QP limit Below 1GHz.The EUT deemed to comply with QP limit. But the Peak value and average value both need to comply with applicable limit above 1GHz.
- e) For the actual test configuration, please see the test setup photo.

5.1.4 Test Equipment Setting For emission test Result

9KHz~150KHz	RBW 200Hz	VBW1KHz
150KHz~30MHz	RBW 9KHz	VBW 30KHz
30MHz~1GHz	RBW 120KHz	VBW 300KHz

Above 1GHz RBW 1MHz VBW 3MHz

5.1.5 Test Condition

Continual Transmitting in maximum power.

5.1.6 Test Result

We have scanned the 9KHz from 25GHz to the EUT.
Detailed information please see the following page.

From 9KHz to 30MHz: Conclusion: PASS

Note: The amplitude of spurious emissions which are attenuated by more than 20dB below the permissible value has no need to be reported.

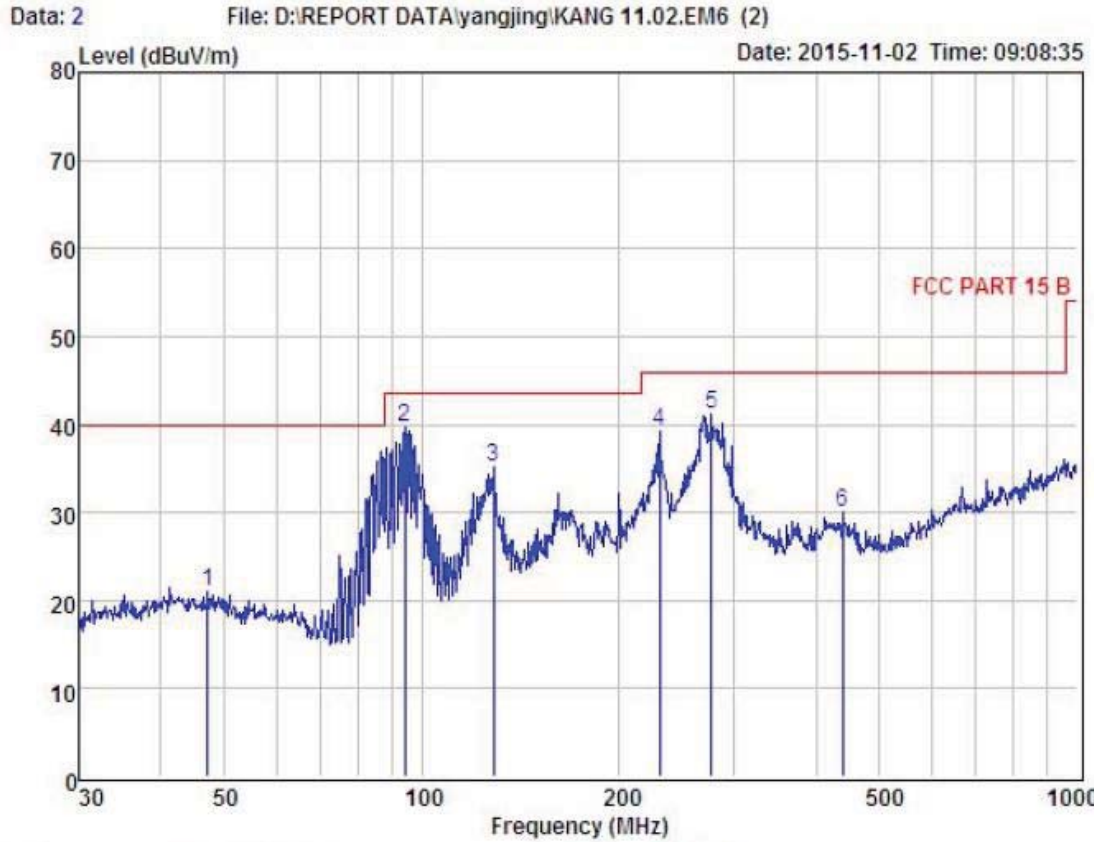

Condition : FCC PART 15 B 3m POL: HORIZONTAL
 EUI :
 Model No :
 Test Mode :
 Power : DC 5V from PC with AC 120V/60Hz
 Test Engineer :
 Remark :
 Temp : 24°C
 Hum : 32%

Item	Freq MHz	Read Level dBuV	Antenna Factor dB	Preamp Factor dB	Cable Loss dB	Level dBuV	Limit dBuV	Margin dBuV	Remark
1	47.16	37.43	13.59	30.10	0.08	21.00	40.00	-19.00	Peak
2	94.43	59.78	9.87	30.20	0.32	39.77	43.50	-3.73	Peak
3	128.56	51.62	12.68	29.53	0.38	35.15	43.50	-8.35	Peak
4	230.91	55.36	11.26	28.05	0.61	39.18	46.00	-6.82	Peak
5	277.09	56.42	12.31	28.09	0.49	41.13	46.00	-4.87	Peak
6	438.66	40.83	15.68	27.31	0.78	29.98	46.00	-16.02	Peak

Remark: Level = Read Level + Antenna Factor - Preamp Factor + Cable Loss

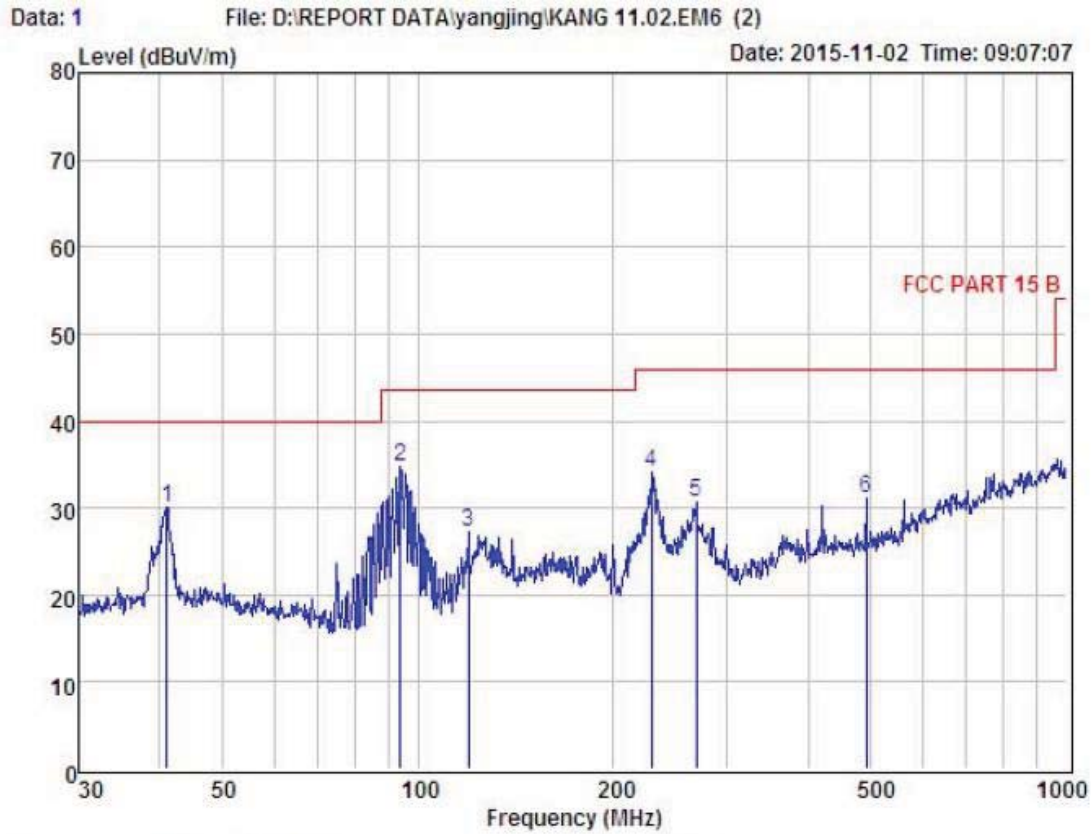

Condition : FCC PART 15 B 3m POL: VERTICAL
 EUI :
 Model No :
 Test Mode :
 Power : DC 5V from PC with AC 120V/60Hz
 Test Engineer :
 Remark :
 Temp : 24°C
 Hum : 32%

Item	Freq MHz	Read Level dBuV	Antenna Factor dB	Preamp Factor dB	Cable Loss dB	Level dBuV	Limit dBuV	Margin dBuV	Remark
1	40.99	46.85	13.93	30.85	0.18	30.11	40.00	-9.89	Peak
2	94.10	54.99	9.72	30.20	0.32	34.83	43.50	-8.67	Peak
3	119.86	44.51	12.06	29.68	0.36	27.25	43.50	-16.25	Peak
4	229.29	50.43	11.21	28.14	0.55	34.05	46.00	-11.95	Peak
5	268.49	46.14	12.03	28.14	0.70	30.73	46.00	-15.27	Peak
6	490.74	40.71	16.41	27.19	1.08	31.01	46.00	-14.99	Peak

Remark: Level = Read Level + Antenna Factor - Preamp Factor + Cable Loss

Above 1GHz

1GHz—25GHz Radiated emission Test result									
EUT: Smart Badge		M/N: iUL8							
Power: DC 3.7V from battery									
Test date: 2015-10-26 Test site: 3m Chamber Tested by: Store Chu									
Test mode: GFSK Tx CH1 2402MHz									
Antenna polarity: Vertical									
No	Freq (MHz)	Read Level (dBuV/m)	Antenna Factor (dB/m)	Cable loss(dB)	Amp Factor (dB)	Result (dBuV/m)	Limit (dBuV/m)	Margin (dB)	Remark
1	4804	41.67	33.95	10.18	34.26	51.54	74	22.46	PK
2	4804	33.28	33.95	10.18	34.26	43.15	54	10.85	AV
3	7206	/							
4	9608	/							
5	12010	/							
Antenna Polarity: Horizontal									
1	4804	41.26	33.95	10.18	34.26	51.13	74	22.87	PK
2	4804	32.64	33.95	10.18	34.26	42.51	54	11.49	AV
3	7206	/							
4	9608	/							
5	12010	/							
Note:									
1, Measuring frequency from 1GHz to 25GHz									
2, Spectrum Set for PK measure: RBW=1MHz, VBW=1MHz, Sweep time=Auto, Detector: PK									
2, Spectrum Set for AV measure: RBW=1MHz, VBW=3MHz, Sweep time=Auto, Detector: RMS									
3, Result = Read level + Antenna factor + cable loss-Amp factor									
4, All the other emissions not reported were too low to read and deemed to comply with FCC limit.									

1GHz—25GHz Radiated emission Test result									
EUT: Smart Badge		M/N: iUL8							
Power: DC 3.7V from battery									
Test date: 2015-10-26 Test site: 3m Chamber Tested by: Store Chu									
Test mode: GFSK Tx CH20 2440MHz									
Antenna polarity: Vertical									
No	Freq (MHz)	Read Level (dBuV/m)	Antenna Factor (dB/m)	Cable loss(dB)	Amp Factor (dB)	Result (dBuV/m)	Limit (dBuV/m)	Margin (dB)	Remark
1	4880	43	33.93	10.2	34.29	52.84	74	21.16	PK
2	4880	33.18	33.93	10.2	34.29	43.02	54	10.98	AV
3	7320	/							
4	9760	/							
5	12200	/							
Antenna Polarity: Horizontal									
1	4880	42.7	33.93	10.2	34.29	52.54	74	21.46	PK
2	4880	34.17	33.93	10.2	34.29	44.01	54	9.99	AV
3	7320	/							
4	9760	/							
5	12200	/							
Note:									
1, Measuring frequency from 1GHz to 25GHz									
2,Spectrum Set for PK measure: RBW=1MHz, VBW=1MHz, Sweep time=Auto, Detector: PK									
2,Spectrum Set for AV measure: RBW=1MHz, VBW=3MHz, Sweep time=Auto, Detector: RMS									
3, Result = Read level + Antenna factor + cable loss-Amp factor									
4, All the other emissions not reported were too low to read and deemed to comply with FCC limit.									

1GHz—25GHz Radiated emission Test result									
EUT: Smart Badge M/N: iUL8									
Power: DC 3.7V from battery									
Test date: 2015-10-26 Test site: 3m Chamber Tested by: Store Chu									
Test mode: GFSK Tx CH40 2480MHz									
Antenna polarity: Vertical									
No	Freq (MHz)	Read Level (dBuV/m)	Antenna Factor (dB/m)	Cable loss (dB)	Amp Factor (dB)	Result (dBuV/m)	Limit (dBuV/m)	Margin (dB)	Remark
1	4960	43.76	33.98	10.22	34.25	53.71	74	20.29	PK
2	4960	34.27	33.98	10.22	34.25	44.22	54	9.78	AV
3	7440	/							
4	9920	/							
5	12400	/							
Antenna Polarity: Horizontal									
1	4960	44.29	33.98	10.22	34.25	54.24	74	19.76	PK
2	4960	33.96	33.98	10.22	34.25	43.91	54	10.09	AV
3	7440	/							
4	9920	/							
5	12400	/							
Note:									
1, Measuring frequency from 1GHz to 25GHz									
2, Spectrum Set for PK measure: RBW=1MHz, VBW=1MHz, Sweep time=Auto, Detector: PK									
2,Spectrum Set for AV measure: RBW=1MHz, VBW=3MHz, Sweep time=Auto, Detector: RMS									
3, Result = Read level + Antenna factor + cable loss-Amp factor									
4, All the other emissions not reported were too low to read and deemed to comply with FCC limit.									

6 POWER LINE CONDUCTED EMISSION

6.1 Conducted Emission Limits(15.207)

Frequency MHz	Limits dB(μ V)	
	Quasi-peak Level	Average Level
0.15 -0.50	66 -56*	56 - 46*
0.50 -5.00	56	46
5.00 -30.00	60	50

Notes: 1. *Decreasing linearly with logarithm of frequency.

2. The lower limit shall apply at the transition frequencies.

3. The limit decreases in line with the logarithm of the frequency in the rang of 0.15 to 0.50 MHz.

6.2 Test Setup

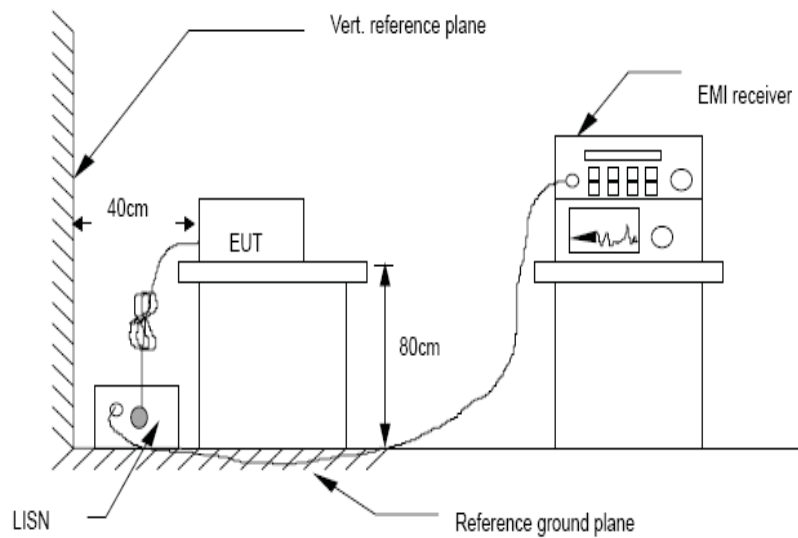

6.3 Test Procedure

The EUT is put on the plane 0.8m high above the ground by insulating support and is connected to the power mains through a line impedance stabilization network (L.I.S.N.). This provides a 50ohm coupling impedance for the EUT system. Please refer the block diagram of the test setup and photographs. Both sides of AC lines are checked to find out the maximum conducted emission. In order to find the maximum emission levels, the relative positions of equipment and all of the interface cables shall be changed according to ANSI C63.4:2014 on Conducted Emission Measurement. The bandwidth of test receiver (R & S ESCI) is set at 9 kHz.

6.4 Test Results

TX MODE

Worse case is reported only

PASS

Detailed information please see the following page.

Data: 168 File: E:\TEST REPORT\yj\Conduction 0.15-30.EM6 (171) Date: 2015-10-30 Time: 11:01:23

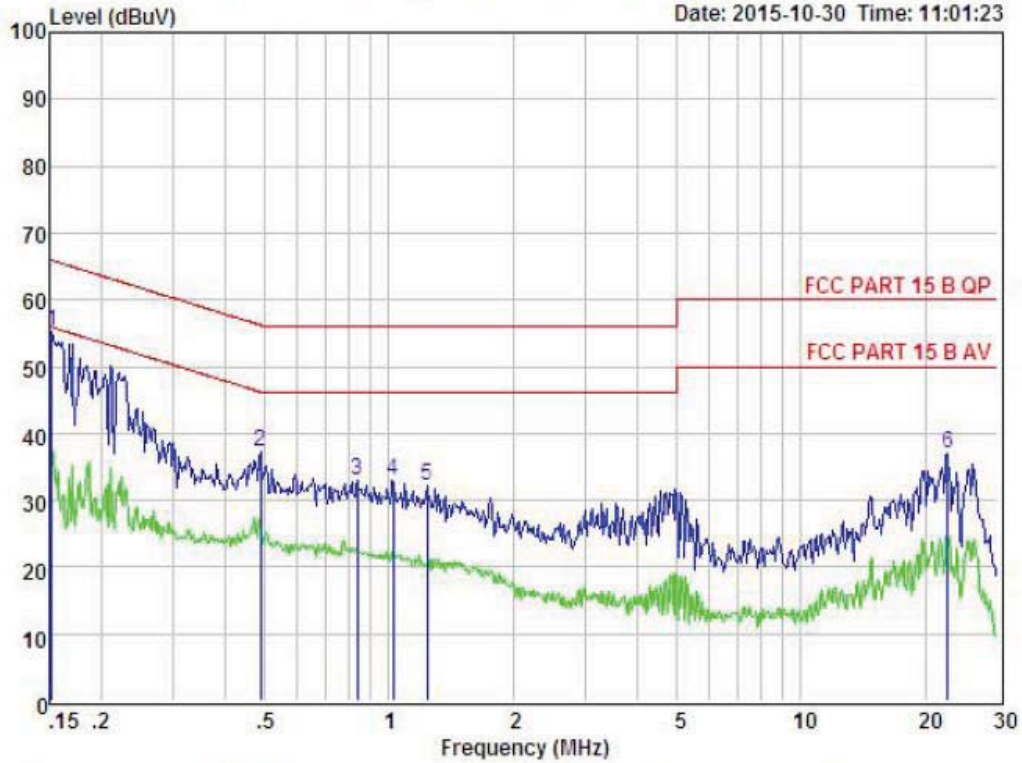

Condition : FCC PART 15 B QP POL: LINE Temp:24 °C Hum:56 %
 EUT :
 Model No :
 Test Mode :
 Power : DC 5V from PC with AC 120V/60Hz
 Test Engineer:
 Remark :

Item	Freq MHz	Read dBuV	LISN Factor dB	Preamp Factor dB	Cable Loss dB	Level dBuV	Limit dBuV	Margin dBuV	Remark
1	0.152	45.51	0.03	-9.52	0.10	55.16	65.91	-10.75	Peak
2	0.488	27.53	0.03	-9.58	0.10	37.24	56.20	-18.96	Peak
3	0.838	23.26	0.04	-9.60	0.10	33.00	56.00	-23.00	Peak
4	1.023	23.18	0.04	-9.63	0.10	32.95	56.00	-23.05	Peak
5	1.236	22.35	0.04	-9.65	0.10	32.14	56.00	-23.86	Peak
6	22.709	26.23	0.41	-9.81	0.42	36.87	60.00	-23.13	Peak

Remarks: Level = Read + LISN Factor - Preamp Factor + Cable loss

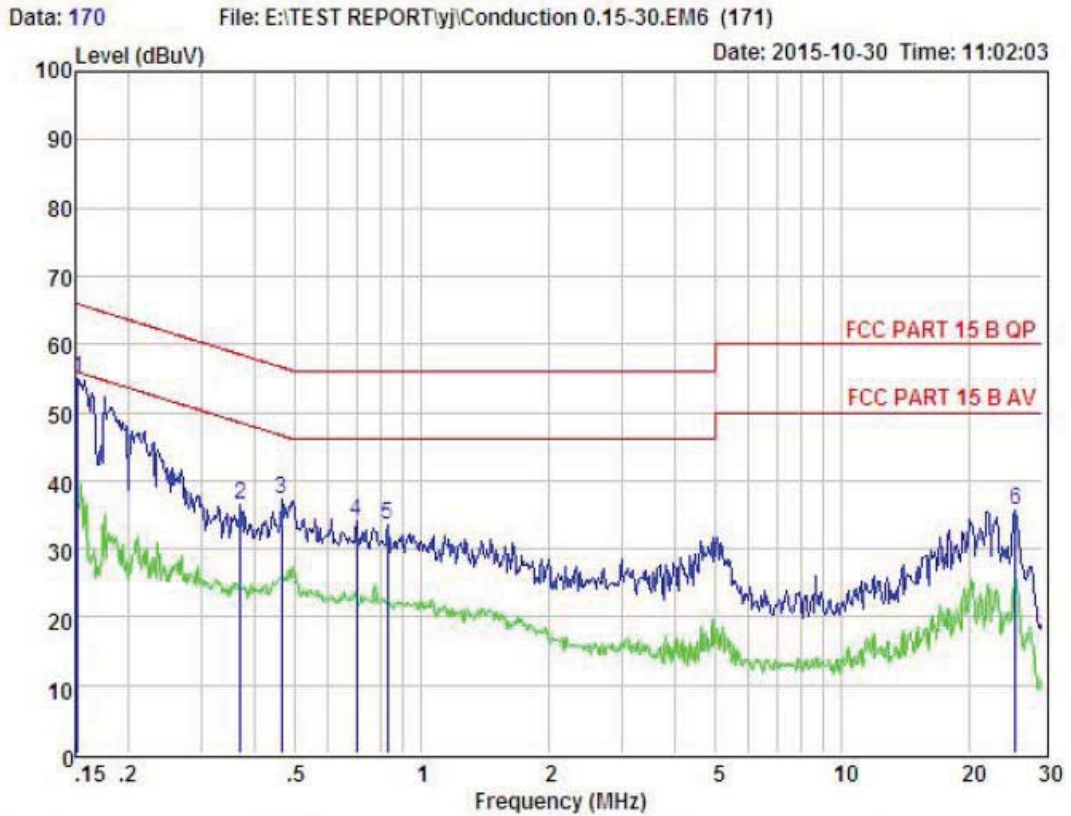

Condition : FCC PART 15 B QP POL: NEUTRAL Temp:24 °C Hum:56 %
 EUI :
 Model No :
 Test Mode :
 Power : DC 5V from PC with AC 120V/60Hz
 Test Engineer:
 Remark :

Item	Freq MHz	Read dBuV	LISN Factor dB	Preamp Factor dB	Cable Loss dB	Level dBuV	Limit dBuV	Margin dBuV	Remark
1	0.152	45.44	0.03	-9.52	0.10	55.09	65.91	-10.82	Peak
2	0.371	26.82	0.03	-9.57	0.10	36.52	58.48	-21.96	Peak
3	0.465	27.69	0.03	-9.58	0.10	37.40	56.61	-19.21	Peak
4	0.701	24.29	0.04	-9.59	0.10	34.02	56.00	-21.98	Peak
5	0.831	23.87	0.02	-9.60	0.10	33.59	56.00	-22.41	Peak
6	25.871	24.96	0.46	-9.83	0.51	35.76	60.00	-24.24	Peak

Remarks: Level = Read + LISN Factor - Preamp Factor + Cable loss

7 Conducted Maximum Output Power

7.1 Test limit

Please refer section 15.247.

7.2 Test Procedure

Details see the KDB558074 Meas Guidance V03

7.2.1 Place the EUT on the table and set it in transmitting mode.

7.2.2 Measure out each mode and each bands peak output power of EUT.

Note: The cable loss and attenuator loss were offset into measure device as amplitude offset.

Details see the KDB558074 DTS Meas Guidance V03

7.3 Test Setup

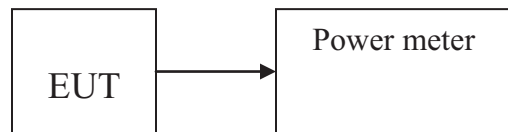

7.4 Test Results

PASS

Detailed information please see the following page.

EUT: Smart Badge		M/N: iUL8		
Test date: 2015-10-26		Test site: RF site		Tested by: Eric Huang
Mode	Frequency (MHz)	PK Output power(dBm)	Limit (dBm)	Judgment
GFSK	CH0: 2402	0.910	30	Pass
	CH19: 2440	0.291	30	Pass
	CH39: 2480	-0.351	30	Pass
Conclusion: PASS				

8 PEAK POWER SPECTRAL DENSITY

8.1 Test limit

8.1.1 Please refer section 15.247.

8.1.2 For direct sequence systems, the peak power spectral density conducted from the intentional radiator to the antenna shall not be greater than 8dBm in any 3kHz band during any time interval of continuous transmission.

8.1.3 The direct sequence operating of the hybrid system, with the frequency hopping operation turned off, shall comply with the power density requirements of paragraph (d) of this section.

8.2 Method of measurement

Details see the KDB558074 DTS Meas Guidance V03

8.2.1 Place the EUT on the table and set it in transmitting mode.

8.2.2 Remove the antenna from the EUT and then connect a low loss RF cable from the antenna port to the spectrum analyzer.

8.2.3 Set the spectrum analyzer as RBW = 3kHz, VBW = 10kHz, span=5-30%EBW, detail see the test plot.

8.2.4 Record the max reading.

8.2.5 Repeat the above procedure until the measurements for all frequencies are completed.

8.3 Test Setup



8.4 Test Results

PASS.

Detailed information please see the following page.

EUT: Smart Badge		M/N: iUL8		
Test date: 2015-10-26		Test site: RF site		Tested by: Eric Huang
Mode	Frequency (MHz)	PK Output power(dBm)	Limit (dBm)	Result
GFSK	CH0: 2402	-12.377	8	PASS
	CH19: 2440	-12.736	8	PASS
	CH39: 2480	-13.359	8	PASS
Conclusion: PASS				

GFSK :
CH Low :

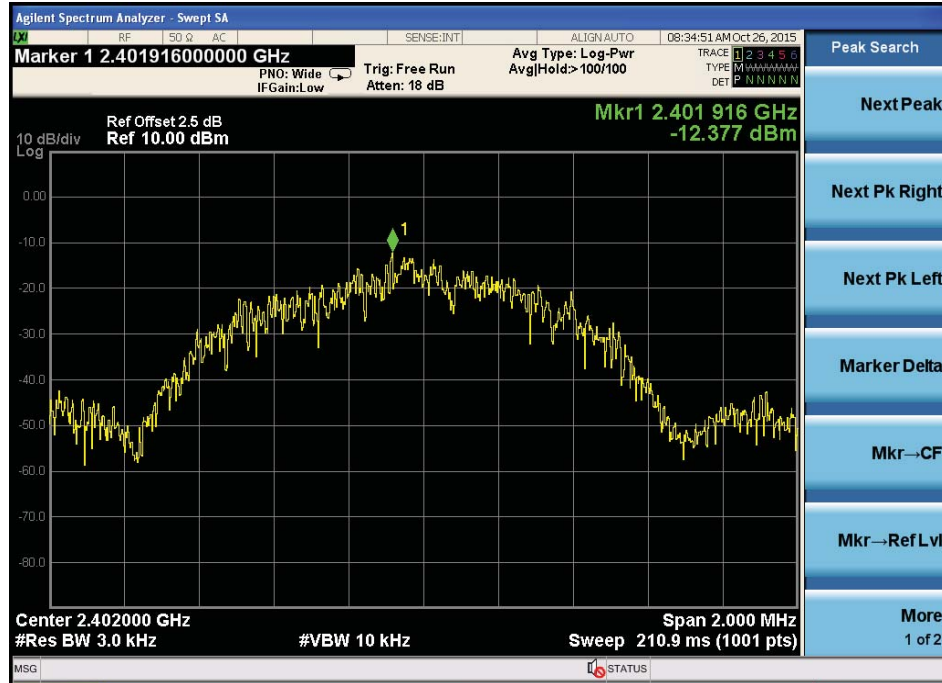

CH Mid:

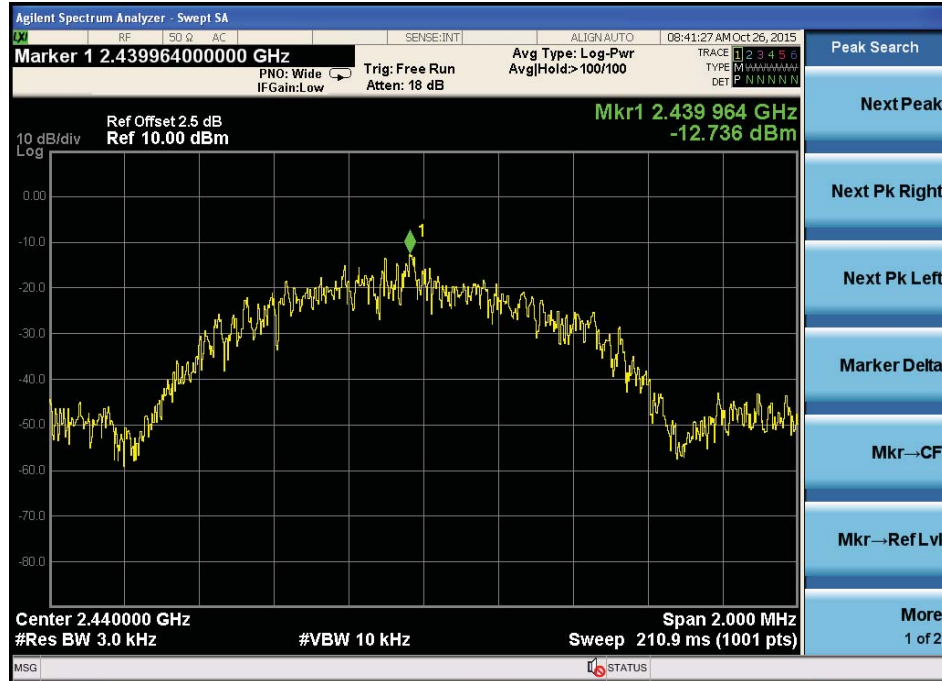

CH Hig:



9 Bandwidth

9.1 Test limit

Please refer section 15.247

For direct sequence systems, the minimum 6dB bandwidth shall be at least 500 kHz.

9.2 Method of measurement

Details see the KDB558074 D01 Meas Guidance

- a) The bandwidth is measured at an amplitude level reduced 20dB from the reference level. The reference level is the level of the highest amplitude signal observed from the transmitter at the fundamental frequency. Once the reference level is established, the equipment is conditioned with typical modulating signal to produce the worst-case (i.e. the widest) bandwidth.
- b) The test receiver set $RBW = 1-5 \% EBW$, $VBW \geq 3RBW$, Sweep time set auto, detail see the test plot. Peak detector is used.

9.3 Test Setup



9.4 Test Results

PASS.

Detailed information please see the following page.

Channel	Frequency (MHz)	6dB Bandwidth (MHz)	99% Occupied Bandwidth (MHz)	Limit (MHz)	Result
GFSK:					
Low	2402	0.6874	1.028	0.5	PASS
Mid	2440	0.6849	1.029	0.5	PASS
High	2480	0.6148	1.114	0.5	PASS

GFSK:
CH Low :

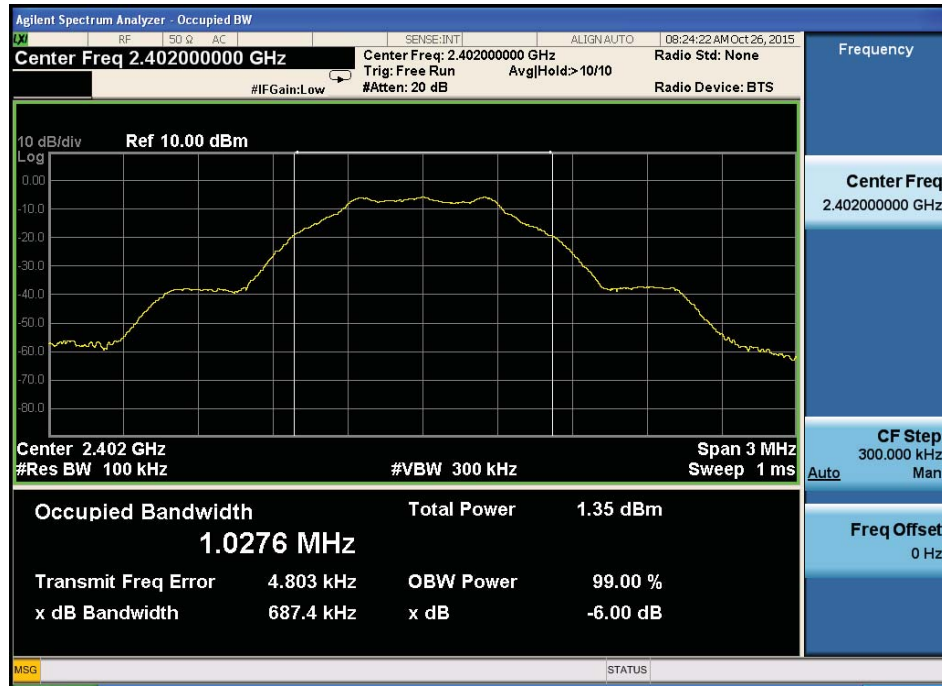

CH Mid :

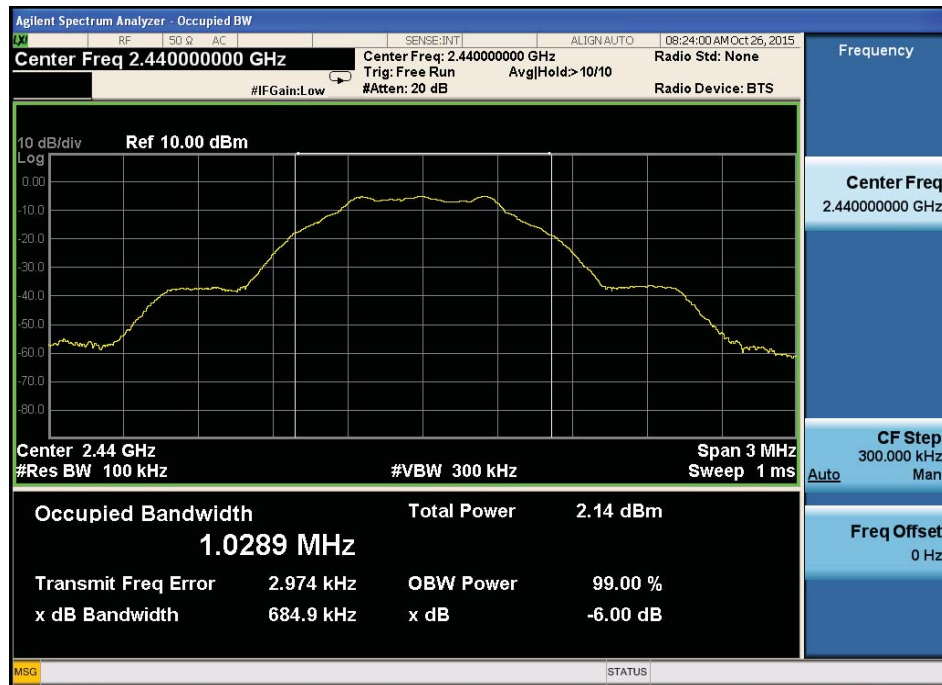

CH High :

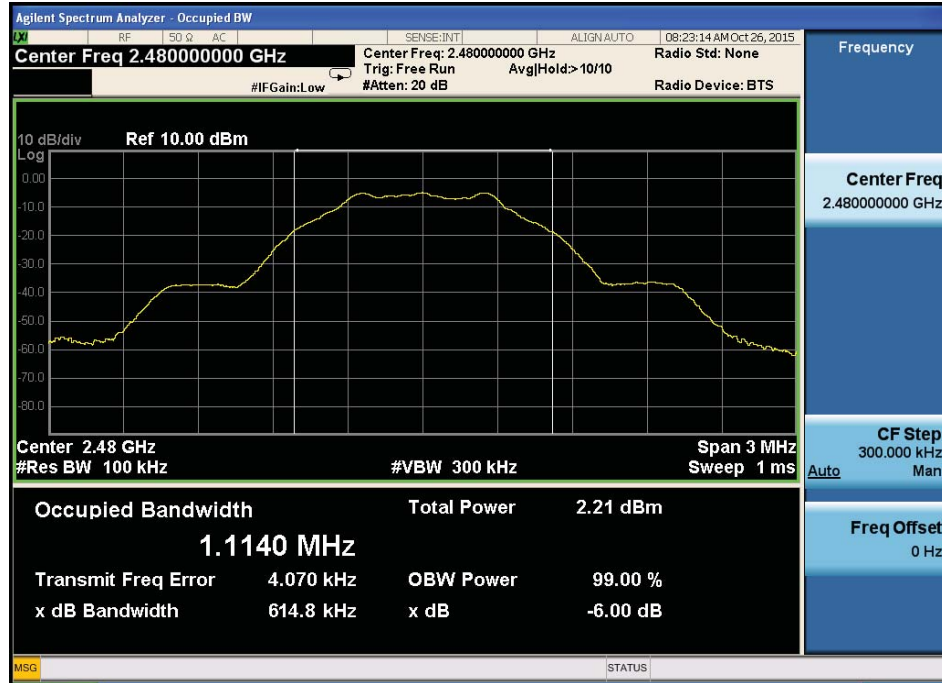

10 Band Edge Check

10.1 Test limit

Please refer section 15.247.

10.2 Test Procedure

12.2.1 Put the EUT on a 0.8m high table, power on the EUT. Emissions were scanned and measured rotating the EUT to 360 degrees, Find the maximum Emission

12.2.2 Check the spurious emissions out of band.

12.2.3 RBW 1MHz ,VBW 3MHz ,peak detector for peak value , RBW 1MHz ,VBW 3MHz ,RMS detector for AV value.

10.3 Test Setup

Same as 5.2.2.

10.4 Test Result

PASS.

Detailed information please see the following page.

Radiated Method:
GFSK

Band Edge Test result								
EUT: Smart Badge			M/N: iUL8					
Power: DC 3.7V from battery								
Test date: 2015-10-26 Test site: 3m Chamber Tested by: Eric Huang								
Test mode: Tx Low								
Antenna polarity: Vertical								
Freq (MHz)	Read Level (dBuV/m)	Antenna Factor (dB/m)	Cable loss(dB)	Amp Factor (dB)	Result (dBuV/m)	Limit (dBuV/m)	Margin (dB)	Remark
2390	42.77	27.62	3.92	34.97	39.34	74	34.66	PK
2390	--	27.62	3.92	34.97	--	54	--	AV
Antenna Polarity: Horizontal								
2390	42.26	27.62	3.92	34.97	38.83	74	35.17	PK
2390	--	27.62	3.92	34.97	--	54	--	AV
Note:								
1, Spectrum Set for PK measure: RBW=1MHz, VBW=1MHz, Sweep time=Auto, Detector: PK								
2, Spectrum Set for AV measure: RBW=1MHz, VBW=3MHz, Sweep time=Auto, Detector: RMS								
3, Result = Read level + Antenna factor + cable loss-Amp factor								
4, All the other emissions not reported were too low to read and deemed to comply with FCC limit.								

Band Edge Test result								
EUT: Smart Badge			M/N: iUL8					
Power: DC 3.7V from battery								
Test date: 2015-10-26			Test site: 3m Chamber			Tested by: Eric Huang		
Test mode: Tx High								
Antenna polarity: Vertical								
Freq (MHz)	Read Level (dBUV/m)	Antenna Factor (dB/m)	Cable loss(dB)	Amp Factor (dB)	Result (dBUV/m)	Limit (dBUV/m)	Margin (dB)	Remark
2483.5	42.1	27.89	4	34.97	39.02	74	34.98	PK
2483.5		--	--	--	--	54	--	AV
Antenna Polarity: Horizontal								
2483.5	42.29	27.89	4	34.97	39.21	74	34.79	PK
2483.5		--	--	--	--	54	--	AV
Note:								
1, Spectrum Set for PK measure: RBW=1MHz, VBW=1MHz, Sweep time=Auto, Detector: PK								
2, Spectrum Set for AV measure: RBW=1MHz, VBW=3MHz, Sweep time=Auto, Detector: RMS								
3, Result = Read level + Antenna factor + cable loss-Amp factor								
4, All the other emissions not reported were too low to read and deemed to comply with FCC limit.								

Conducted Method:
GFSK

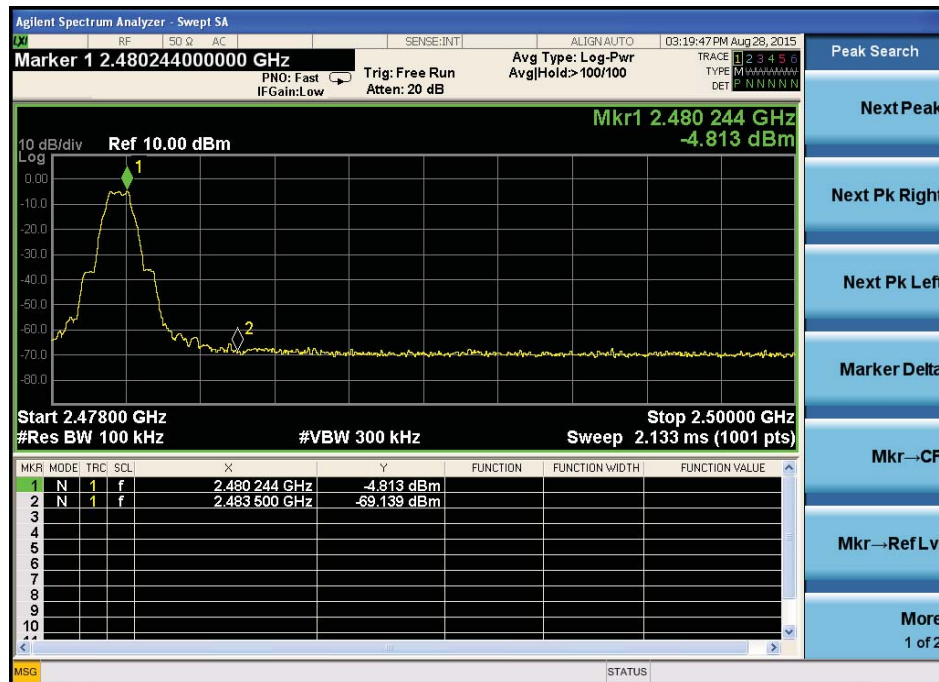
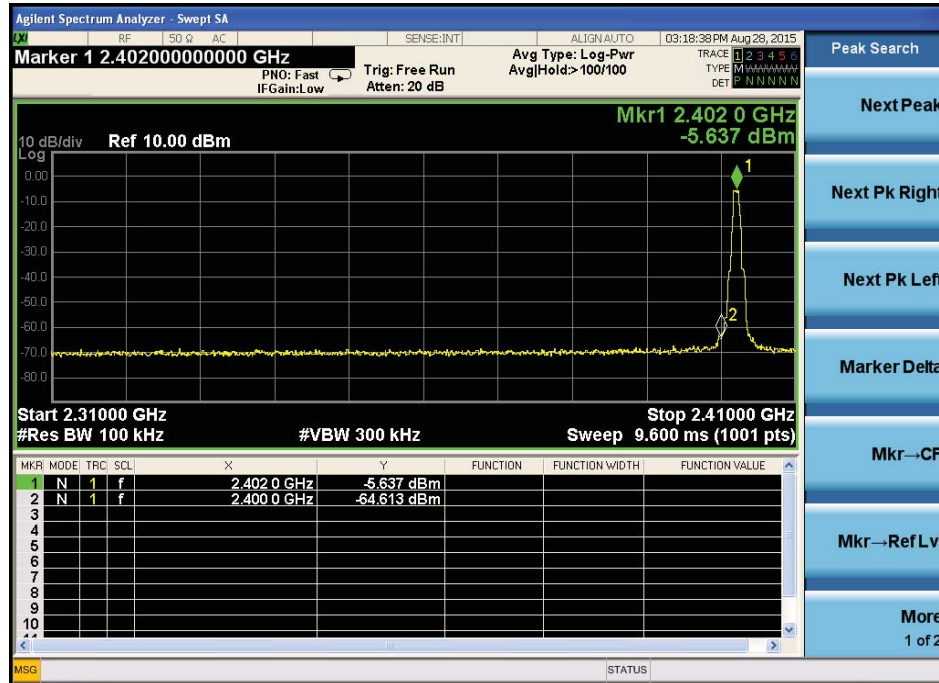

11 Antenna Requirement

11.1 Standard Requirement

An intentional radiator shall be designed to ensure that no antenna other than that furnished by the responsible party shall be used with the device. The use of a permanently attached antenna or of an antenna that uses a unique coupling to the intentional radiator shall be considered sufficient to comply with the provisions of this Section. The manufacturer may design the unit so that a broken antenna can be replaced by the user, but the use of a standard antenna jack or electrical connector is prohibited.

11.2 Antenna Connected Construction

The antenna connector is unique antenna and no consideration of replacement. Please see EUT photo for details.

11.3 Result

The EUT antenna is Integrated Antenna. It comply with the standard requirement.

12 Test setup photo

12.1 Photos of Radiated emission

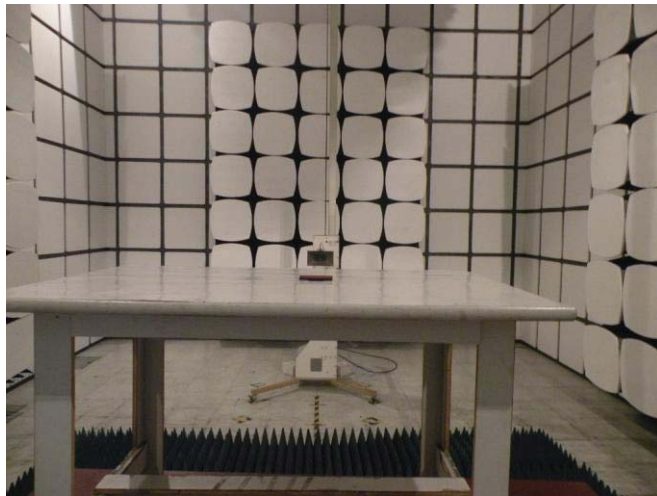
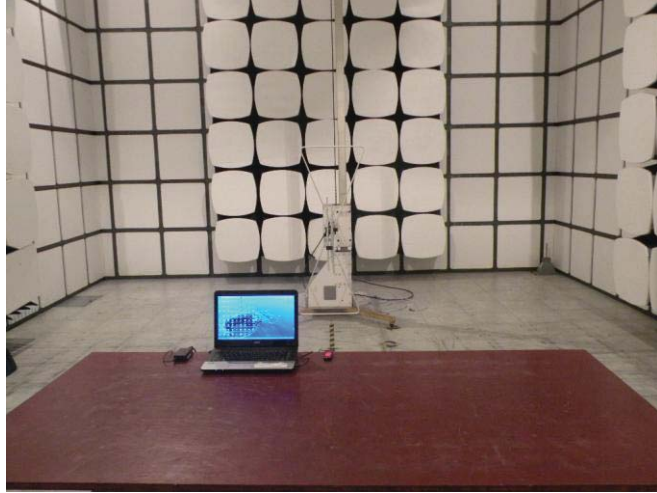

12.2 Photos of Conducted Emission test



12 Photographs of EUT

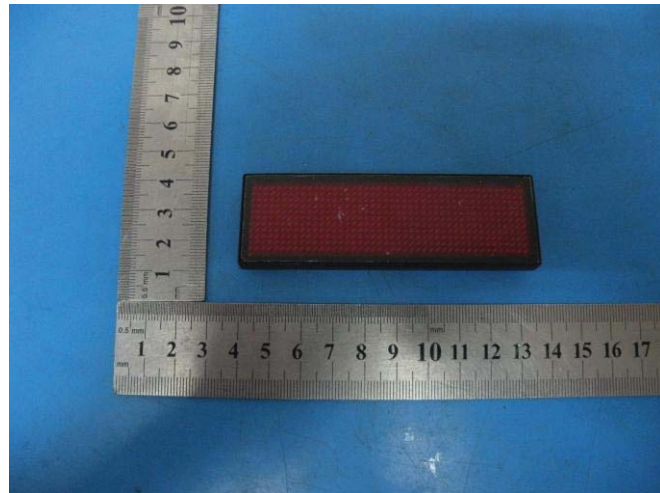
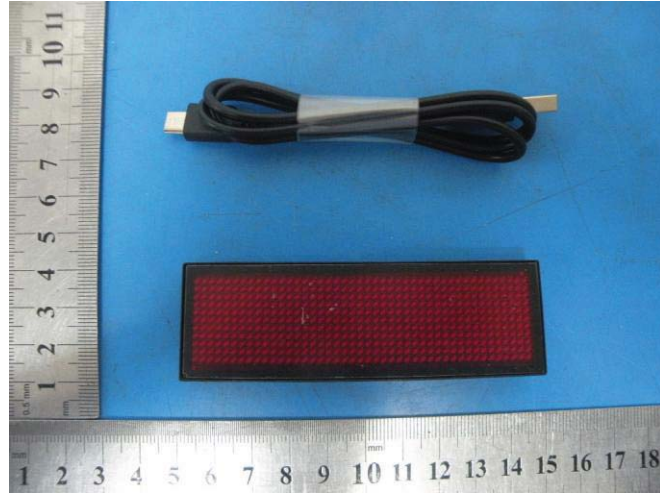

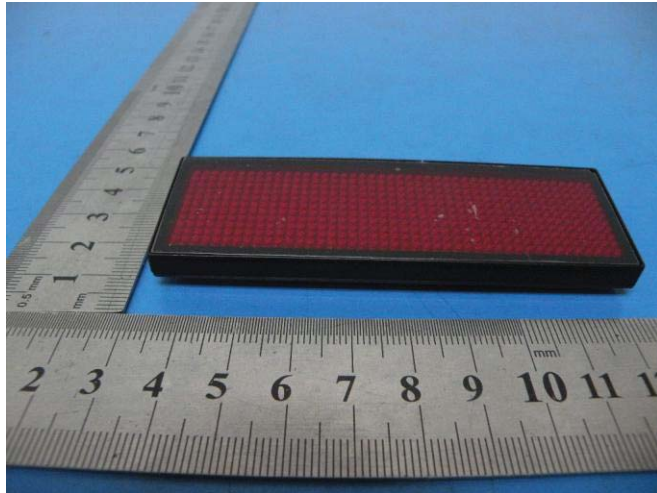





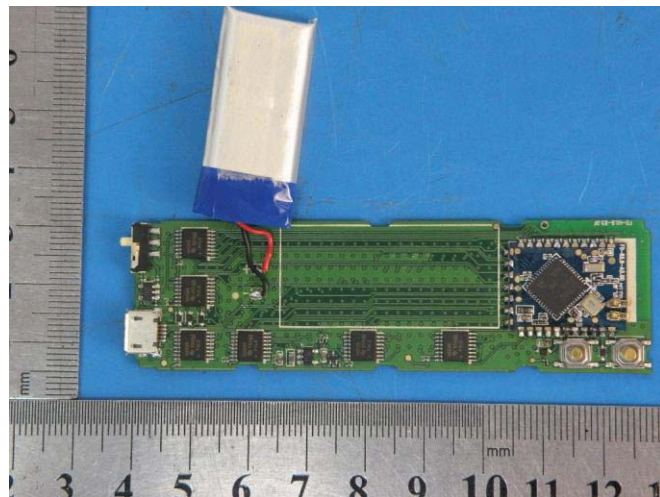
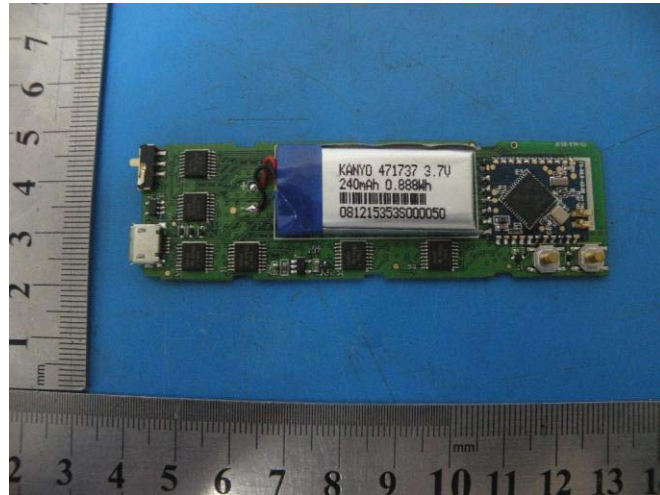

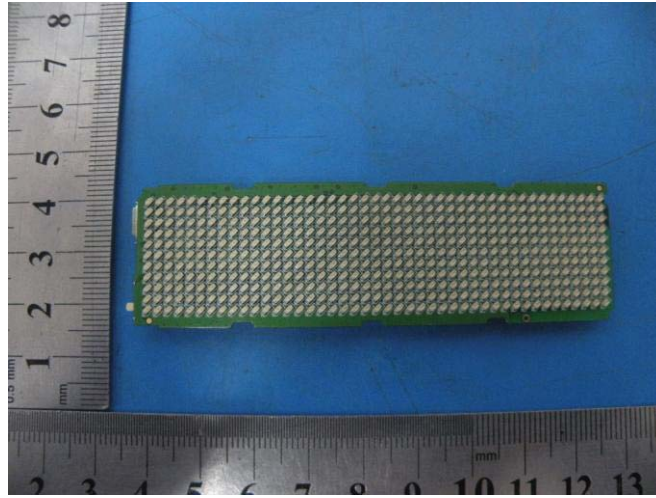

-----END OF THE REPORT-----