

## FCC AND IC CERTIFICATION TEST REPORT

### FOR

<b>Applicant</b>	:	ION Audio, LLC
<b>Address</b>	:	200 Scenic View Drive, Cumberland, RI 02864 U.S.A.
<b>Equipment under Test</b>	:	Outdoor Solar Speaker with Multi-Link
<b>Model No.</b>	:	SOLAR STONE MULTI
<b>Project Code</b>	:	iSP75
<b>Trade Mark</b>	:	ION
<b>FCC ID</b>	:	2AB3E-ISP75
<b>IC</b>	:	10541A-ISP75
<b>Manufacturer</b>	:	ION Audio, LLC
<b>Address</b>	:	200 Scenic View Drive, Cumberland, RI 02864 U.S.A.

**Issued By: Dongguan Dongdian Testing Service Co., Ltd.**

**Add:** No. 17, Zongbu Road 2, Songshan Lake Sci&Tech, Industry Park, Dongguan City,  
Guangdong Province, China, 523808

**Tel:** +86-0769-89201699, **E-mail:** ddt@dgddt.com, <http://www.dgddt.com>

## TABLE OF CONTENTS

	Test report declares.....	4
1.	Summary of test results .....	5
2.	General test information .....	6
2.1.	Description of EUT .....	6
2.2.	Accessories of EUT .....	6
2.3.	Assistant equipment used for test .....	6
2.4.	Block diagram of EUT configuration for test .....	6
2.5.	Test environment conditions .....	7
2.6.	Deviations of test standard .....	7
2.7.	Test laboratory.....	7
2.8.	Measurement uncertainty .....	8
3.	Equipment used during test .....	9
4.	20dB Bandwidth and 99% Bandwidth .....	10
4.1.	Block diagram of test setup .....	10
4.2.	Limits .....	10
4.3.	Test Procedure .....	10
4.4.	Test Result.....	10
4.5.	Original test data .....	11
5.	Radiated emission .....	13
5.1.	Block diagram of test setup .....	13
5.2.	Limit .....	14
5.3.	Test Procedure .....	15
5.4.	Test result .....	15
6.	Band Edge Compliance .....	19
6.1.	Block diagram of test setup .....	19
6.2.	Limit .....	19
6.3.	Test Procedure .....	19
6.4.	Test result .....	19
7.	Power Line Conducted Emission .....	24
7.1.	Block diagram of test setup .....	24
7.2.	Power Line Conducted Emission Limits .....	24
7.3.	Test Procedure .....	24
7.4.	Test Result.....	25
8.	Antenna Requirements .....	28
8.1.	Limit .....	28
8.2.	Result.....	28

## TEST REPORT DECLARE

<b>Applicant</b>	:	ION Audio, LLC
<b>Address</b>	:	200 Scenic View Drive, Cumberland, RI 02864 U.S.A.
<b>Equipment under Test</b>	:	Outdoor Solar Speaker with Multi-Link
<b>Model No.</b>	:	SOLAR STONE MULTI
<b>Trade mark</b>	:	ION
<b>Manufacturer</b>	:	ION Audio, LLC
<b>Address</b>	:	200 Scenic View Drive, Cumberland, RI 02864 U.S.A.

**Test Standard Used:**

FCC Rules and Regulations Part 15 Subpart C, RSS-210 Issue 9 August 2016.

**Test procedure used:**

ANSI C63.10:2013, RSS-Gen Issue 4, Nov. 2014.

**We Declare:**

The equipment described above is tested by Dongguan Dongdian Testing Service Co., Ltd. and in the configuration tested the equipment complied with the standards specified above. The test results are contained in this test report and Dongguan Dongdian Testing Service Co., Ltd. is assumed of full responsibility for the accuracy and completeness of these tests.

**After test and evaluation, our opinion is that the equipment provided for test compliance with the requirement of the above FCC&IC standards.**

<b>Report No:</b>	DDT-R17120707-1E1		
<b>Date of Receipt:</b>	Dec. 07, 2017	<b>Date of Test:</b>	Dec. 07, 2017 ~ Dec. 28, 2017

*Prepared By:*

*Sam Li*

*Sam Li/Engineer*

*Approved By:*

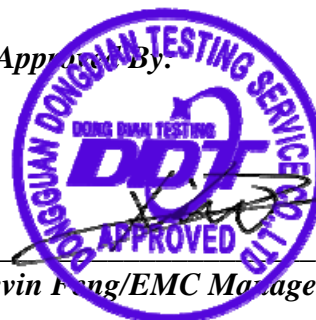

*Kevin Feng/EMC Manager*

Note: This report applies to above tested sample only. This report shall not be reproduced in parts without written approval of Dongguan Dongdian Testing Service Co., Ltd.

### Revision history

Rev.	Revisions	Issue Date	Revised By
---	Initial issue	Dec. 28, 2017	

## 1. Summary of test results

The EUT have been tested according to the applicable standards as referenced below.		
Description of Test Item	Standard	Results
20dB Bandwidth and 99% Bandwidth	FCC Part 15: 15.215 ANSI C63.10:2013 RSS-210 Issue 9 RSS-Gen Issue 4 6.6	PASS
Radiated Emission	FCC Part 15: 15.209 FCC Part 15: 15.249 ANSI C63.10:2013 RSS-210 Issue 9 B.10 RSS-Gen Issue 4 8.9 8.10	PASS
Band Edge Compliance	FCC Part 15: 15.205 FCC Part 15: 15.249 ANSI C63.10:2013 RSS-210 Issue 9 B.10 RSS-Gen Issue 4 8.9 8.10	PASS
Power Line Conducted Emission	FCC Part 15: 15.207 ANSI C63.10:2013 RSS-Gen Issue 4 8.8	PASS
Antenna requirement	FCC Part 15: 15.203 RSS-Gen Issue 4 8.3	PASS
N/A is an abbreviation for Not Applicable.		

## 2. General test information

### 2.1. Description of EUT

EUT* Name	: Outdoor Solar Speaker with Multi-Link
Model Number	: SOLAR STONE MULTI
EUT function description	: Please reference user manual of this device
Power supply	: DC 15V from external AC Adapter DC 12V built-in battery
Operation frequency	: 5727MHz -5800MHz
Modulation	: GFSK
Antenna Type	: Integral Antenna, maximum PK gain: 3.57dBi
Sample Type	: Series production

Note: EUT is the ab. of equipment under test.

EUT channels and frequencies list:

Channel	Frequency (MHz)	Channel	Frequency (MHz)
1	5727	9	5767
2	5731	10	5771
3	5734	11	5773
4	5738	12	5774
5	5749	13	5778
6	5753	14	5789
7	5756	15	5796
8	5760	16	5800

### 2.2. Accessories of EUT

Description of Accessories	Manufacturer	Model number	Serial No.	Other
AC/DC Power Adapter	SHEN ZHEN CITY HONGBEN ELECTRONIC CO., LTD	HB40-1502004SPA	N/A	INPUT: AC 100V-240V,50/60Hz , 0.8A; OUTPUT: DC 15V, 2000mA

### 2.3. Assistant equipment used for test

Assistant equipment	Manufacturer	Model number	Serial No.	Other
/	/	/	/	/

### 2.4. Block diagram of EUT configuration for test

Tx Mode:

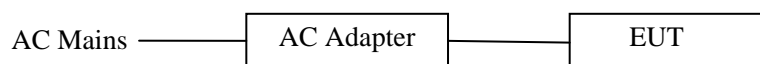

For Tx Mode, A special test firmware was installed in EUT and which can exercise the EUT work in continues RF test mode at specified test channel as below:

Note: Fully charged battery is used during all test

Tested mode, channel, information		
Mode	Channel	Frequency (MHz)
GFSK Tx mode	CH1	5727
	CH8	5760
	CH16	5800

## 2.5. Test environment conditions

During the measurement the environmental conditions were within the listed ranges:

Temperature range:	21-25°C
Humidity range:	40-75%
Pressure range:	86-106kPa

## 2.6. Deviations of test standard

No Deviation.

## 2.7. Test laboratory

Dongguan Dongdian Testing Service Co., Ltd

Add: No. 17, Zongbu Road 2, Songshan Lake Sci&Tech, Industry Park, Dongguan City, Guangdong Province, China, 523808 Tel: +86-0769-89201699, E-mail: ddt@dgddt.com, <http://www.dgddt.com>

CNAS Accreditation No. L6451; A2LA Accreditation No. 3870.01

Designation Number: CN1182; Test Firm Registration Number: 540522

Industry Canada site registration number: 10288A-1

## 2.8. Measurement uncertainty

Test Item	Uncertainty
Bandwidth	1.1%
Peak Output Power(Conducted)( Spectrum analyzer)	0.86dB(10 MHz $\leq$ f < 3.6GHz);
	1.38dB(3.6GHz $\leq$ f < 8GHz)
Peak Output Power(Conducted)(Power Sensor)	0.74dB
Power Spectral Density	0.74dB(10 MHz $\leq$ f < 3.6GHz);
	1.38dB(3.6GHz $\leq$ f < 8GHz)
Conducted spurious emissions	0.86dB(10 MHz $\leq$ f < 3.6GHz);
	1.40dB(3.6GHz $\leq$ f < 8GHz)
	1.66dB(8GHz $\leq$ f < 22GHz)
Uncertainty for radio frequency (RBW<20KHz)	$3 \times 10^{-8}$
Temperature	0.4°C
Humidity	2%
Uncertainty for Radiation Emission test (30MHz-1GHz)	4.70 dB (Antenna Polarize: V)
	4.84 dB (Antenna Polarize: H)
Uncertainty for Radiation Emission test (1GHz-40GHz)	4.10dB(1-6GHz)
	4.40dB (6GHz-18GHz)
	3.54dB(18GHz-26GHz)
	4.30dB (26GHz-40GHz)
Uncertainty for Power line conduction emission test	3.32dB (150KHz-30MHz)
Note: This uncertainty represents an expanded uncertainty expressed at approximately the 95% confidence level using a coverage factor of k=2.	



### 3. Equipment used during test

Equipment	Manufacturer	Model No.	Serial No.	Last Cal.	Cal. Interval
<b>RF Connected Test</b>					
Spectrum analyzer	R&S	FSU26	200071	Oct. 23, 2017	1Year
Wideband Radio Communication tester	R&S	CMW500	117491	Jun. 16, 2017	1 Year
Vector Signal Generator	Agilent	E8267D	US49060192	Oct. 23, 2017	1Year
Vector Signal Generator	Agilent	N5182A	MY48180737	Jun.16, 2017	1Year
Power Sensor	Agilent	U2021XA	MY55150010	Oct. 21, 2017	1Year
Power Sensor	Agilent	U2021XA	MY55150011	Oct. 23, 2017	1Year
DC Power Source	MATRIS	MPS-3005L-3	D813058W	Aug. 18, 2017	1Year
Attenuator	Mini-Circuits	BW-S10W2	101109	Aug. 18, 2017	1Year
RF Cable	Micable	C10-01-01-1	100309	Oct. 21, 2017	1Year
Temp&Humi Programmable	ZHIXIANG	ZXGDJS-150L	ZX170110-A	Oct. 21, 2017	1Year
Test Software	JS Tonscent	JS1120-3	Ver.2.7	N/A	N/A
USB Data acquisition	Agilent	U2531A	TW55043503	N/A	N/A
<b>Radiated Emission Test Chamber 1#</b>					
EMI Test Receiver	R&S	ESU8	100316	Oct. 21, 2017	1 Year
Spectrum analyzer	Agilent	E4447A	MY50180031	Jun. 16, 2017	1 Year
Trilog Broadband Antenna	Schwarzbeck	VULB9163	9163-462	Nov. 09, 2017	1 Year
Active Loop antenna	Schwarzbeck	FMZB-1519	1519-038	Oct. 17, 2017	1 Year
Double Ridged Horn Antenna	R&S	HF907	100276	Oct. 17, 2017	1 Year
Broad Band Horn Antenna	Schwarzbeck	BBHA 9170	790	Nov. 09, 2017	1 Year
Pre-amplifier	TERA-MW	TRLA-0040G35	101303	Oct. 21, 2017	1 Year
Preamplifier	A.H.Systems.Inc	PAM-0118	360	Oct. 21, 2017	1 Year
RF Cable	HUBSER	CP-X2+ CP-X1	W11.03+ W12.02	Oct. 21, 2017	1Year
RF Cable	N/A	SMAJ-SMAJ-1 M+ SMAJ-SMAJ-11 M	17070133+170 70131	Nov. 08, 2017	1 Year
Test software	Audix	E3	V 6.11111b	N/A	N/A
<b>Power Line Conducted Emissions Test</b>					
Test Receiver	R&S	ESPI	101761	Oct. 21, 2017	1 Year
LISN 1	R&S	ENV216	101109	Oct. 21, 2017	1 Year
LISN 2	R&S	ESH2-Z5	100309	Oct. 21, 2017	1 Year
Pulse Limiter	R&S	ESH3-Z2	101242	Oct. 21, 2017	1 Year
CE Cable 1	HUBSER	N/A	W10.01	Oct. 21, 2017	1 Year
Test software	Audix	E3	V 6.11111b	N/A	N/A

## 4. 20dB Bandwidth and 99% Bandwidth

### 4.1. Block diagram of test setup

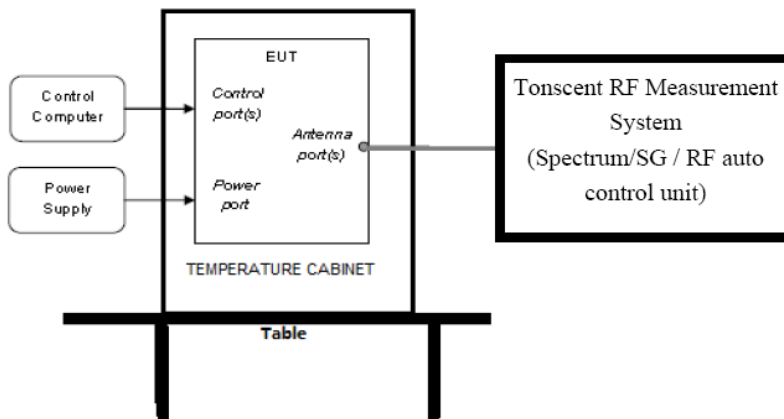

### 4.2. Limits

Intentional radiators operating under the alternative provisions to the general emission limits, as contained in § 15.217 through 15.257 and in Subpart E of this part, must be designed to ensure that the 20 dB bandwidth of the emission, or whatever bandwidth may otherwise be specified in the specific rule section under which the equipment operates, is contained within the frequency band designated in the rule section under which the equipment is operated.

### 4.3. Test Procedure

- (1) Connect EUT's antenna output to spectrum analyzer by RF cable.
- (2) Set the spectrum analyzer as follows:
  - RBW: 100kHz
  - VBW: 300kHz
  - Detector Mode: Peak
  - Sweep time: auto
  - Trace mode Max hold
- (3) Allow the trace to stabilize, measure the 20dB and 99% bandwidth of signal.

### 4.4. Test Result

Mode	Freq (MHz)	20dB bandwidth Result (MHz)	99% bandwidth Result (MHz)	Conclusion
GFSK	5727	3.478	3.237	PASS
	5760	3.478	3.253	PASS
	5800	3.494	3.285	PASS

4.5. Original test data

20 dB Bandwidth	
LCH 5727	<p>                     *RBW 100 kHz                      *VBM 300 kHz                      *Att 10 dB                      *SWT 20 ms                      Marker 1 [T1]                      -4.00 dBm                      5.727080128 GHz                      Ref 10 dBm                      Offset 1.5 dB                      nBW [T1] 20.00 dB                      BW 3.47756103 MHz                      Temp 1 [T1.nBW]                      -2.31 dBm                      5.72522154 GHz                      Temp 2 [T1.nBW]                      -2.99 dBm                      5.72869718 GHz                      Center 5.727 GHz                      1 MHz/                      Span 10 MHz                 </p>
MCH 5760	<p>                     *RBW 100 kHz                      *VBM 300 kHz                      *Att 10 dB                      *SWT 20 ms                      Marker 1 [T1]                      -3.88 dBm                      5.760096154 GHz                      Ref 10 dBm                      Offset 1.5 dB                      nBW [T1] 20.00 dB                      BW 3.47756103 MHz                      Temp 1 [T1.nBW]                      -2.46 dBm                      5.75823179 GHz                      Temp 2 [T1.nBW]                      -2.05 dBm                      5.76171744 GHz                      Center 5.76 GHz                      1 MHz/                      Span 10 MHz                 </p>
HCH 5800	<p>                     *RBW 100 kHz                      *VBM 300 kHz                      *Att 10 dB                      *SWT 20 ms                      Marker 1 [T1]                      -3.33 dBm                      5.800080128 GHz                      Ref 10 dBm                      Offset 1.5 dB                      nBW [T1] 20.00 dB                      BW 3.49358744 MHz                      Temp 1 [T1.nBW]                      -2.89 dBm                      5.79822154 GHz                      Temp 2 [T1.nBW]                      -2.45 dBm                      5.80171744 GHz                      Center 5.8 GHz                      1 MHz/                      Span 10 MHz                 </p>

Occupied Bandwidth	
LCH 5727	
MCH 5760	
HCH 5800	

### 5. Radiated emission

#### 5.1. Block diagram of test setup

In 3m Anechoic Chamber Test Setup Diagram for 9kHz-30MHz

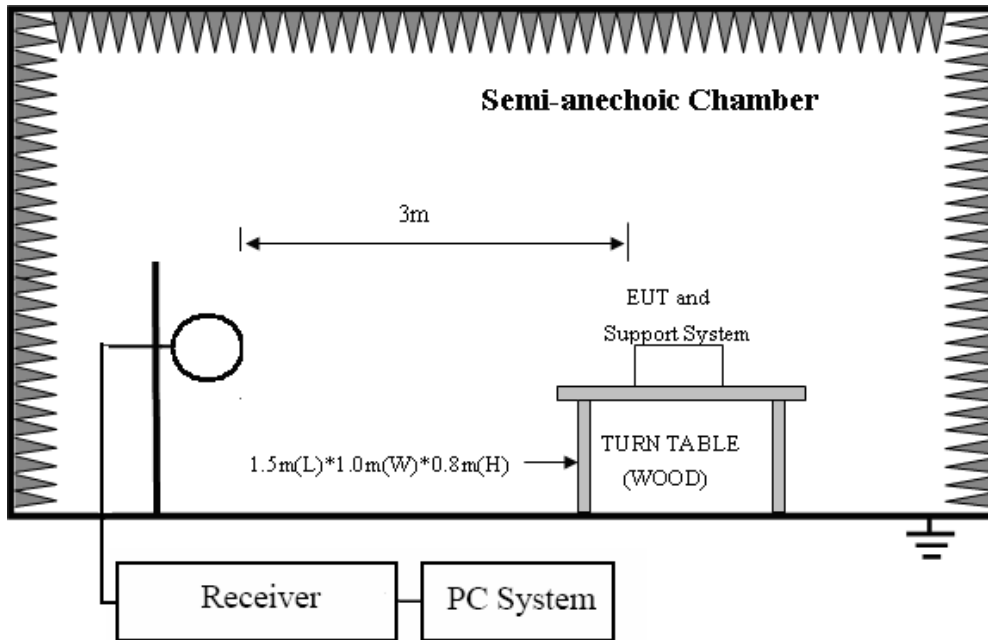

In 3m Anechoic Chamber Test Setup Diagram for 30MHz-1GHz

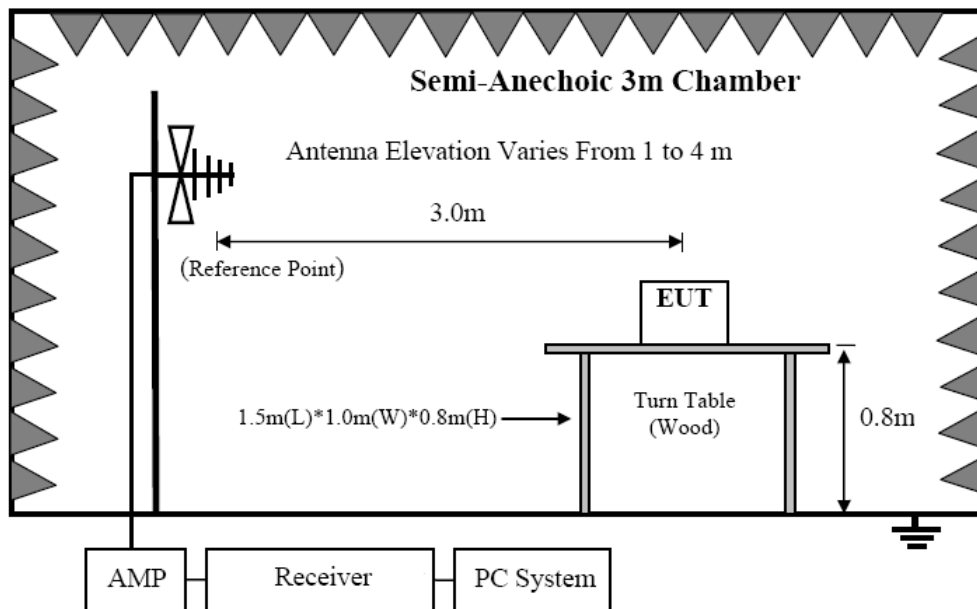

In 3m Anechoic Chamber Test Setup Diagram for frequency above 1GHz

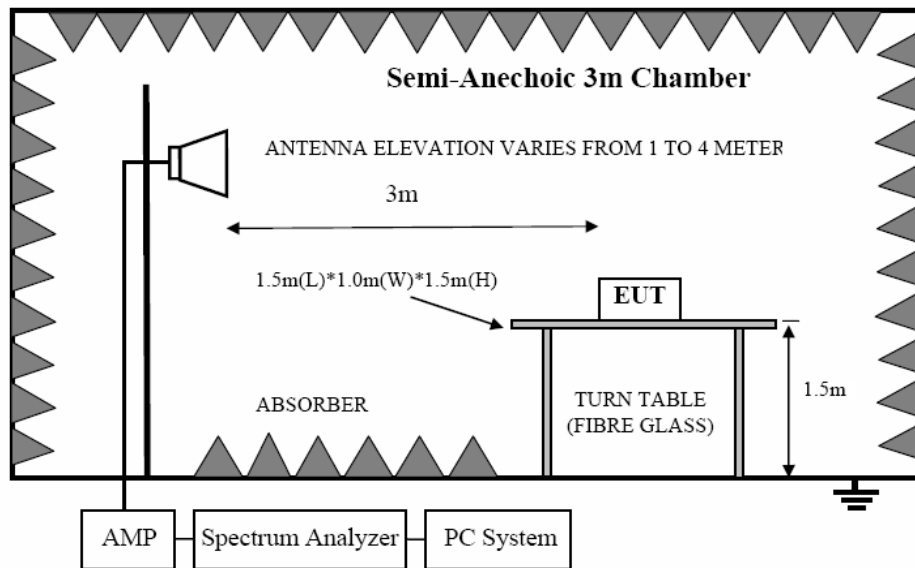

Note: For harmonic emissions test a appropriate high pass filter was inserted in the input port of AMP.

## 5.2. Limit

FREQUENCY MHz	DISTANCE Meters	FIELD STRENGTHS LIMIT	
		$\mu\text{V}/\text{m}$	$\text{dB}(\mu\text{V})/\text{m}$
30 ~ 88	3	100	40.0
88 ~ 216	3	150	43.5
216 ~ 960	3	200	46.0
960 ~ 1000	3	500	54.0
Above 1000MHz	3	74.0 $\text{dB}(\mu\text{V})/\text{m}$ (Peak) 54.0 $\text{dB}(\mu\text{V})/\text{m}$ (Average)	
Field Strength of Fundamental emission for 5725MHz-5875MHz	3	94.0 $\text{dB}(\mu\text{V})/\text{m}$ (Average) 114.0 $\text{dB}(\mu\text{V})/\text{m}$ (Peak)	
Field Strength of Harmonics	3	74.0 $\text{dB}(\mu\text{V})/\text{m}$ (Peak) 54.0 $\text{dB}(\mu\text{V})/\text{m}$ (Average)	

Remark:

- (1) Emission level  $\text{dB}\mu\text{V} = 20 \log$  Emission level  $\mu\text{V}/\text{m}$
- (2) The smaller limit shall apply at the cross point between two frequency bands.
- (3) Distance is the distance in meters between the measuring instrument, antenna and the closest point of any part of the device or system.
- (4) The emission limits shown in the above table are based on measurements employing a CISPR quasi-peak detector except for the frequency bands 9-90 kHz, 110-490 kHz and above 1000 MHz. Radiated emission limits in these three bands are based on measurements employing an average detector.

### 5.3. Test Procedure

- (1) EUT was placed on a non-metallic table, 80 cm above the ground plane inside a semi-anechoic chamber.
- (2) Setup EUT and assistant system according clause 2.3 and 4.2
- (3) Test antenna was located 3m from the EUT on an adjustable mast. Below pre-scan procedure was first performed in order to find prominent radiated emissions.
  - (a) Change work frequency or channel of device if practicable.
  - (b) Change modulation type of device if practicable.
  - (c) Change power supply range from 85% to 115% of the rated supply voltage
  - (d) Rotated EUT though three orthogonal axes to determine the attitude of EUT arrangement produces highest emissions
- (4) Spectrum frequency from 9kHz to 25GHz (tenth harmonic of fundamental frequency) was investigated, and no any obvious emission were detected from 9kHz to 30MHz and 18GHz to 25GHz, so below final test was performed with frequency range from 30MHz to 18GHz.
- (5) For final emissions measurements at each frequency of interest, the EUT were rotated and the antenna height was varied between 1m and 4m in order to maximize the emission. Measurements in both horizontal and vertical polarities were made and the data was recorded. In order to find the maximum emission, the relative positions of equipments and all of the interface cables were changed according to ANSI C63.10 2013 on Radiated Emission test.
- (6) For emissions from 30MHz to 1GHz, Quasi-Peak values were measured with EMI Receiver and the bandwidth of Receiver is 120 kHz.
- (7) For emissions above 1GHz, both Peak and Average level were measured with Spectrum Analyzer, and the RBW is set at 1MHz, VBW is set at 3MHz for Peak measure; RBW is set at 1MHz, VBW is set at 10Hz for Average measure. Peak detector is used for both PK and AV test.
- (8) For fundamental frequency test, set spectrum analyzer's RBW=10MHz, VBW=30MHz. peak detector for PK, RMS detector for AV, Read the Level in spectrum analyzer and record.
- (9) X axis, Y axis, Z axis are tested, and worse setup X axis is reported.

### 5.4. Test result

#### **PASS. (See below detailed test result)**

All the emissions except fundamental emission from 9kHz to 25GHz were comply with 15.209 limit.

Note1: According exploratory test no any obvious emission were detected from 9kHz to 30MHz and 18GHz to 25GHz, so the final test was performed with frequency range from 30MHz to 18GHz and recorded in below.

Note2: For emissions below 1GHz, according exploratory explorer test, when change Tx mode and channel, have no distinct influence on emissions level, so for emissions below 1GHz, the final test was only performed with EUT working in GFSK, Tx 5760MHz mode.

Note3: For emissions above 1GHz. If peak results comply with AV limit, AV Result is deemed to comply with AV limit.

#### **Radiated Emission test (below 1GHz)**

# TR-4-E-009 Radiated Emission Test Result

**Test Site** : DDT 3m Chamber 1# D:\2017 RE1# Report Data\Q17120707-1E\FCC 30M-1GEM6  
**Test Date** : 2017-12-11 **Tested By** : Aaron  
**EUT** : Outdoor Solar Speaker with Multi-Link **Model Number** : SOLAR STONE MULTI  
**Power Supply** : AC 120V/60Hz **Test Mode** : TX mode  
**Condition** : Temp:24.5°C,Humi:55%,  
 : Press:100.1kPa **Antenna/Distance** : 2017 VULB 9163 1#/3m/HORIZONTAL  
**Memo** :

Data: 11

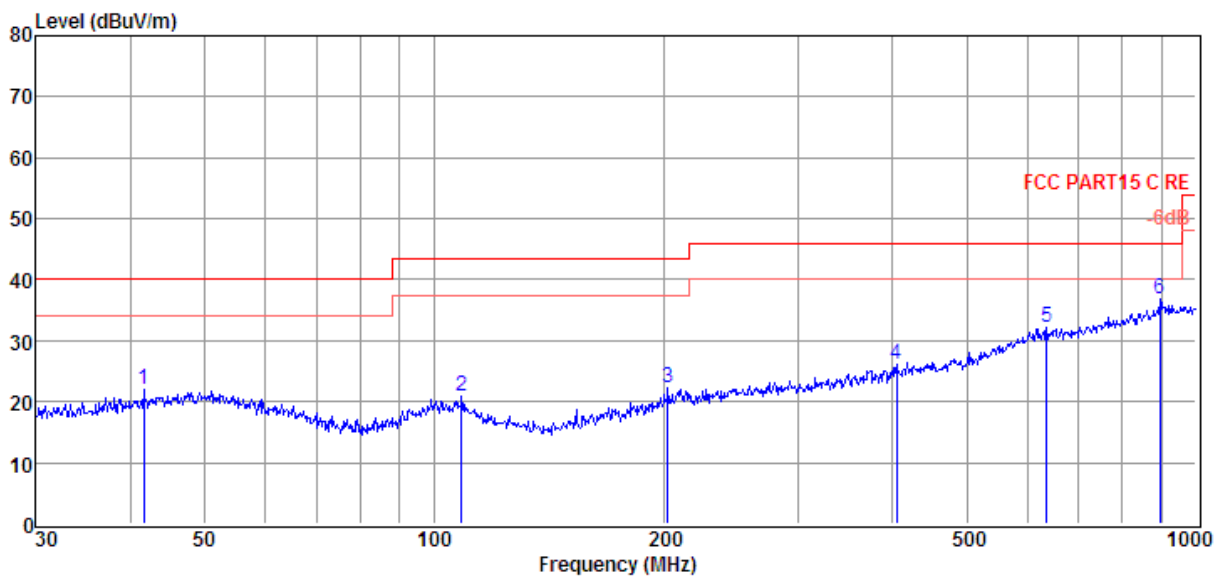

Item (Mark)	Freq. (MHz)	Read Level (dBμV)	Antenna Factor (dB/m)	Cable Loss dB	Result Level (dBμV/m)	Limit Line (dBμV/m)	Over Limit (dB)	Detector	Polarization
1	41.57	5.19	12.81	3.89	21.89	40.00	-18.11	Peak	HORIZONTAL
2	108.65	5.86	10.45	4.48	20.79	43.50	-22.71	Peak	HORIZONTAL
3	202.81	5.63	11.56	5.04	22.23	43.50	-21.27	Peak	HORIZONTAL
4	404.67	4.96	15.32	5.92	26.20	46.00	-19.80	Peak	HORIZONTAL
5	636.13	5.93	19.51	6.80	32.24	46.00	-13.76	Peak	HORIZONTAL
6	897.00	6.69	22.56	7.59	36.84	46.00	-9.16	Peak	HORIZONTAL

Note: 1. Result Level = Read Level + Antenna Factor + Cable loss.  
 2. If Peak Result complies with QP limit, QP Result is deemed to comply with QP limit.  
 3. Test setup: RBW: 120 kHz, VBW: 300 kHz, Sweep time: auto.



# TR-4-E-009 Radiated Emission Test Result

**Test Site** : DDT 3m Chamber 1# D:\2017 RE1# Report Data\Q17120707-1E\FCC 30M-1GEM6  
**Test Date** : 2017-12-11 **Tested By** : Aaron  
**EUT** : Outdoor Solar Speaker with Multi-Link **Model Number** : SOLAR STONE MULTI  
**Power Supply** : AC 120V/60Hz **Test Mode** : TX mode  
**Condition** : Temp:24.5°C,Humi:55%,  
 : Press:100.1kPa **Antenna/Distance** : 2017 VULB 9163 1#/3m/VERTICAL  
**Memo** :

Data: 12

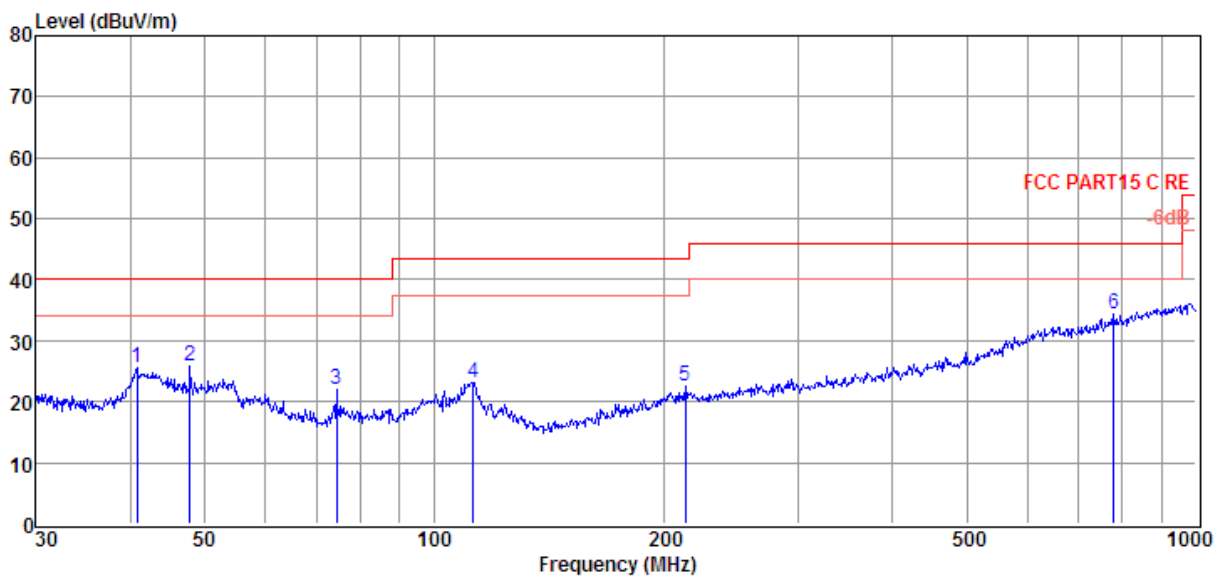

Item (Mark)	Freq. (MHz)	Read Level (dBμV)	Antenna Factor (dB/m)	Cable Loss (dB)	Result Level (dBμV/m)	Limit Line (dBμV/m)	Over Limit (dB)	Detector	Polarization
1	40.70	8.89	12.69	3.88	25.46	40.00	-14.54	Peak	VERTICAL
2	47.83	8.37	13.56	3.97	25.90	40.00	-14.10	Peak	VERTICAL
3	74.40	9.33	8.47	4.21	22.01	40.00	-17.99	Peak	VERTICAL
4	112.52	8.69	10.01	4.51	23.21	43.50	-20.29	Peak	VERTICAL
5	213.76	5.60	11.80	5.10	22.50	43.50	-21.00	Peak	VERTICAL
6	779.61	6.09	20.99	7.25	34.33	46.00	-11.67	Peak	VERTICAL

Note: 1. Result Level = Read Level + Antenna Factor + Cable loss.  
 2. If Peak Result complies with QP limit, QP Result is deemed to comply with QP limit.  
 3. Test setup: RBW: 120 kHz, VBW: 300 kHz, Sweep time: auto.

**Radiated Emission test (above 1GHz)**

Freq. (MHz)	Read level (dB $\mu$ V)	Antenna Factor (dB/m)	PRM Factor (dB)	Cable Loss (dB)	Result Level (dB $\mu$ V/m)	Limit (dB $\mu$ V/ m)	Margi n (dB)	Detector type	Polarization
<b>GFSK Tx mode 5727MHz</b>									
5727.00	76.57	35.59	43.36	8.04	76.84	114.00	-37.16	Peak	HORIZONTAL
8939.00	36.48	37.48	44.08	10.30	40.18	74.00	-33.82	Peak	HORIZONTAL
10316.00	35.26	38.39	44.35	10.94	40.24	74.00	-33.76	Peak	HORIZONTAL
12016.00	34.33	38.90	44.10	10.98	40.11	74.00	-33.89	Peak	HORIZONTAL
14039.00	39.16	40.12	44.59	12.38	47.07	74.00	-26.93	Peak	HORIZONTAL
15399.00	36.90	42.40	44.11	13.13	48.32	74.00	-25.68	Peak	HORIZONTAL
5727.00	81.66	35.59	43.36	8.04	81.93	114.00	-32.07	Peak	VERTICAL
8446.00	36.20	37.29	43.93	9.74	39.30	74.00	-34.70	Peak	VERTICAL
10690.00	35.44	38.61	44.30	11.01	40.76	74.00	-33.24	Peak	VERTICAL
12084.00	35.40	38.88	44.12	11.00	41.16	74.00	-32.84	Peak	VERTICAL
14124.00	37.19	40.37	44.56	12.42	45.42	74.00	-28.58	Peak	VERTICAL
15535.00	37.48	42.61	44.06	13.21	49.24	74.00	-24.76	Peak	VERTICAL
<b>GFSK Tx mode 5760MHz</b>									
5760.00	77.07	35.60	43.34	8.06	77.39	114.00	-36.61	Peak	HORIZONTAL
8786.00	35.86	37.41	44.04	10.13	39.36	74.00	-34.64	Peak	HORIZONTAL
10435.00	34.92	38.46	44.33	10.96	40.01	74.00	-33.99	Peak	HORIZONTAL
12016.00	34.83	38.90	44.10	10.98	40.61	74.00	-33.39	Peak	HORIZONTAL
14090.00	37.55	40.27	44.57	12.41	45.66	74.00	-28.34	Peak	HORIZONTAL
15671.00	36.59	42.67	44.02	13.30	48.54	74.00	-25.46	Peak	HORIZONTAL
5760.00	81.91	35.60	43.34	8.06	82.23	114.00	-31.77	Peak	VERTICAL
8446.00	35.98	37.29	43.93	9.74	39.08	74.00	-34.92	Peak	VERTICAL
10350.00	35.17	38.41	44.35	10.95	40.18	74.00	-33.82	Peak	VERTICAL
12356.00	34.80	38.83	44.19	11.11	40.55	74.00	-33.45	Peak	VERTICAL
13971.00	37.54	39.99	44.59	12.33	45.27	74.00	-28.73	Peak	VERTICAL
15620.00	36.88	42.65	44.03	13.27	48.77	74.00	-25.23	Peak	VERTICAL
<b>GFSK Tx mode 5800MHz</b>									
5800.00	74.70	35.62	43.32	8.08	75.08	114.00	-38.92	Peak	HORIZONTAL
8310.00	35.55	37.26	43.89	9.58	38.50	74.00	-35.50	Peak	HORIZONTAL
10401.00	35.27	38.44	44.34	10.96	40.33	74.00	-33.67	Peak	HORIZONTAL
11761.00	34.49	38.76	44.14	10.99	40.10	74.00	-33.90	Peak	HORIZONTAL
14124.00	36.73	40.37	44.56	12.42	44.96	74.00	-29.04	Peak	HORIZONTAL
15501.00	36.68	42.60	44.07	13.19	48.40	74.00	-25.60	Peak	HORIZONTAL
5800.00	79.97	35.62	43.32	8.08	80.35	114.00	-33.65	Peak	VERTICAL
8276.00	36.09	37.26	43.88	9.54	39.01	74.00	-34.99	Peak	VERTICAL
10180.00	35.14	38.31	44.37	10.92	40.00	74.00	-34.00	Peak	VERTICAL
11710.00	35.35	38.73	44.14	11.00	40.94	74.00	-33.06	Peak	VERTICAL
14090.00	38.19	40.27	44.57	12.41	46.30	74.00	-27.70	Peak	VERTICAL
15739.00	37.03	42.70	43.99	13.34	49.08	74.00	-24.92	Peak	VERTICAL
<b>Result: Pass</b>									

Note: Result Level = Read Level + Antenna Factor + Cable loss - PRM Factor.

## 6. Band Edge Compliance

### 6.1. Block diagram of test setup

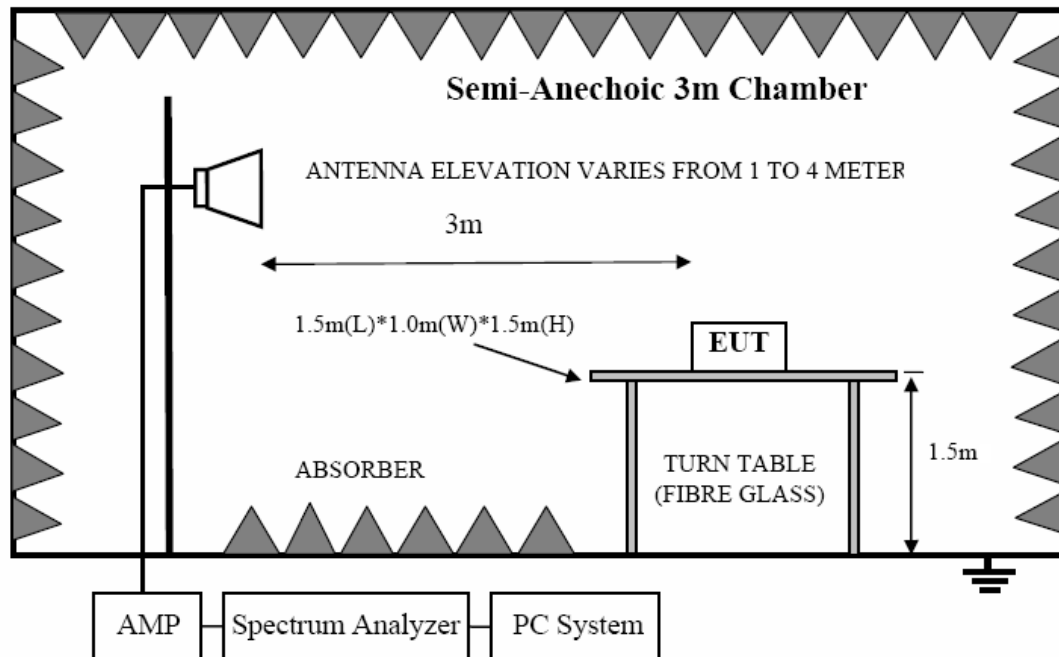

### 6.2. Limit

All the other emissions outside operation frequency band 5725MHz to 5875MHz shall be at least 20dB below the fundamental emissions, or comply with 15.209 limits.

### 6.3. Test Procedure

Same with clause 5.3 except change investigated frequency range from 5700MHz to 5730MHz and 5790MHz to 5900MHz.

Remark: All restriction band have been tested, and only the worse case is shown in report.

### 6.4. Test result

**PASS.** (See below detailed test result)

## TR-4-E-009 Radiated Emission Test Result

<b>Test Site</b>	: DDT 3m Chamber 1#	<b>D:\2017 RE1# Report Data\Q17120707-1\FCC.EM6</b>
<b>Test Date</b>	: 2017-12-28	<b>Tested By</b> : S a m
<b>EUT</b>	: Outdoor Solar Speaker with Multi-Link	<b>Model Number</b> : SOLAR STONE MULTI
<b>Power Supply</b>	: DC 12V	<b>Test Mode</b> : TX mode
<b>Condition</b>	: Temp:24.5°C,Humi:55%, Press:100.1kPa	<b>Antenna/Distance</b> : 2017 HF907/3m/HORIZONTAL
<b>Memo</b>	: 5727MHz	

Data: 1

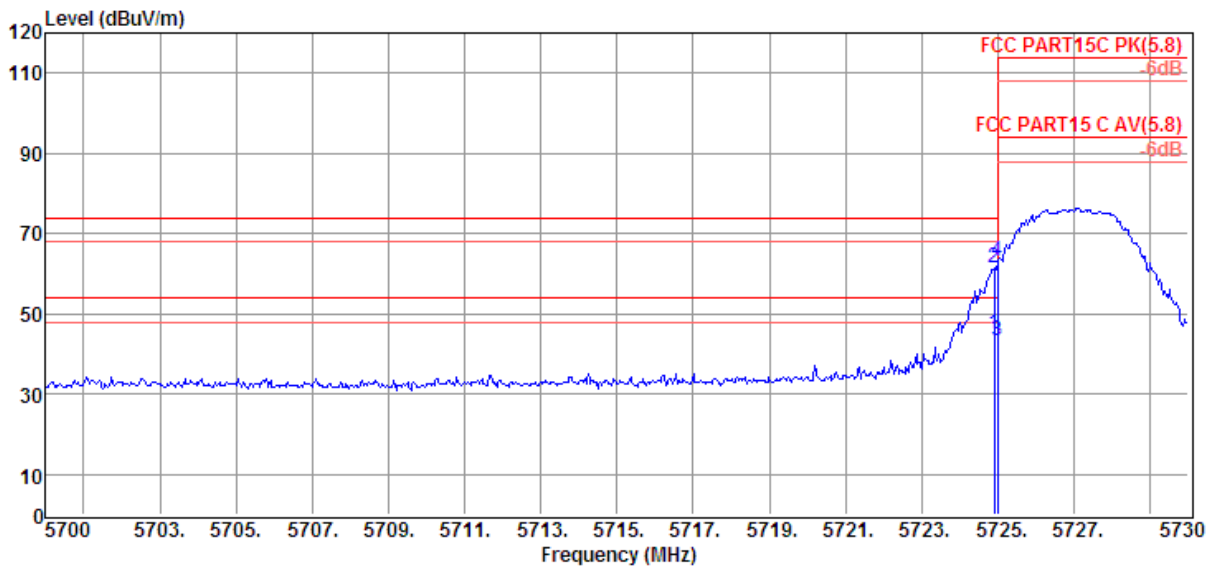

Item (Mark)	Freq. (MHz)	Read Level (dBμV)	Antenna Factor (dB/m)	PRM Factor dB	Cable Loss dB	Result Level (dBμV/m)	Limit Line (dBμV/m)	Over Limit (dB)	Detector	Polarization
1	5724.90	44.54	35.59	43.37	8.04	44.80	54.00	-9.20	Average	HORIZONTAL
2	5724.90	61.03	35.59	43.37	8.04	61.29	74.00	-12.71	Peak	HORIZONTAL
3	5725.00	42.86	35.59	43.37	8.04	43.12	54.00	-10.88	Average	HORIZONTAL
4	5725.00	62.73	35.59	43.37	8.04	62.99	74.00	-11.01	Peak	HORIZONTAL

Note: 1. Result Level = Read Level + Antenna Factor + Cable loss - PRM Factor.  
 2. If Peak Result complies with AV limit, AV Result is deemed to comply with AV limit.  
 3. Test setup: RBW: 1 MHz, VBW: 3 MHz, Sweep time: auto.

## TR-4-E-009 Radiated Emission Test Result

<b>Test Site</b>	: DDT 3m Chamber 1#	<b>D:\2017 RE1# Report Data\Q17120707-1\FCC.EM6</b>
<b>Test Date</b>	: 2017-12-28	<b>Tested By</b> : S a m
<b>EUT</b>	: Outdoor Solar Speaker with Multi-Link	<b>Model Number</b> : SOLAR STONE MULTI
<b>Power Supply</b>	: DC 12V	<b>Test Mode</b> : TX mode
<b>Condition</b>	: Temp:24.5°C,Humi:55%, Press:100.1kPa	<b>Antenna/Distance</b> : 2017 HF907/3m/VERTICAL
<b>Memo</b>	: 5727MHz	

Data: 2

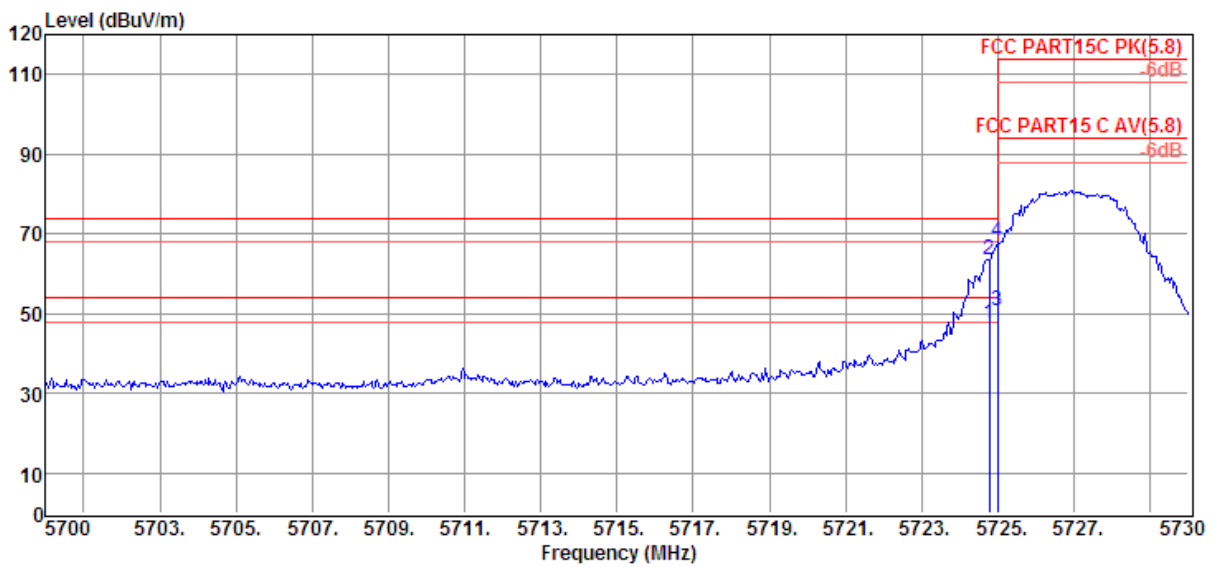

Item (Mark)	Freq. (MHz)	Read Level (dBμV)	Antenna Factor (dB/m)	PRM Factor dB	Cable Loss dB	Result Level (dBμV/m)	Limit Line (dBμV/m)	Over Limit (dB)	Detector	Polarization
1	5724.78	47.36	35.59	43.37	8.04	47.62	54.00	-6.38	Average	VERTICAL
2	5724.78	63.38	35.59	43.37	8.04	63.64	74.00	-10.36	Peak	VERTICAL
3	5725.00	50.50	35.59	43.37	8.04	50.76	54.00	-3.24	Average	VERTICAL
4	5725.00	67.75	35.59	43.37	8.04	68.01	74.00	-5.99	Peak	VERTICAL

Note: 1. Result Level = Read Level + Antenna Factor + Cable loss - PRM Factor.  
 2. If Peak Result complies with AV limit, AV Result is deemed to comply with AV limit.  
 3. Test setup: RBW: 1 MHz, VBW: 3 MHz, Sweep time: auto.

# TR-4-E-009 Radiated Emission Test Result

**Test Site** : DDT 3m Chamber 1# **D:\2017 RE1# Report Data\Q17120707-1\FCC.EM6**  
**Test Date** : 2017-12-28 **Tested By** : Sam  
**EUT** : Outdoor Solar Speaker with Multi-Link **Model Number** : SOLAR STONE MULTI  
**Power Supply** : DC 12V **Test Mode** : TX mode  
**Condition** : Temp:24.5°C,Humi:55%,  
 Press:100.1kPa **Antenna/Distance** : 2017 HF907/3m/HORIZONTAL  
**Memo** : 5800MHz

Data: 9

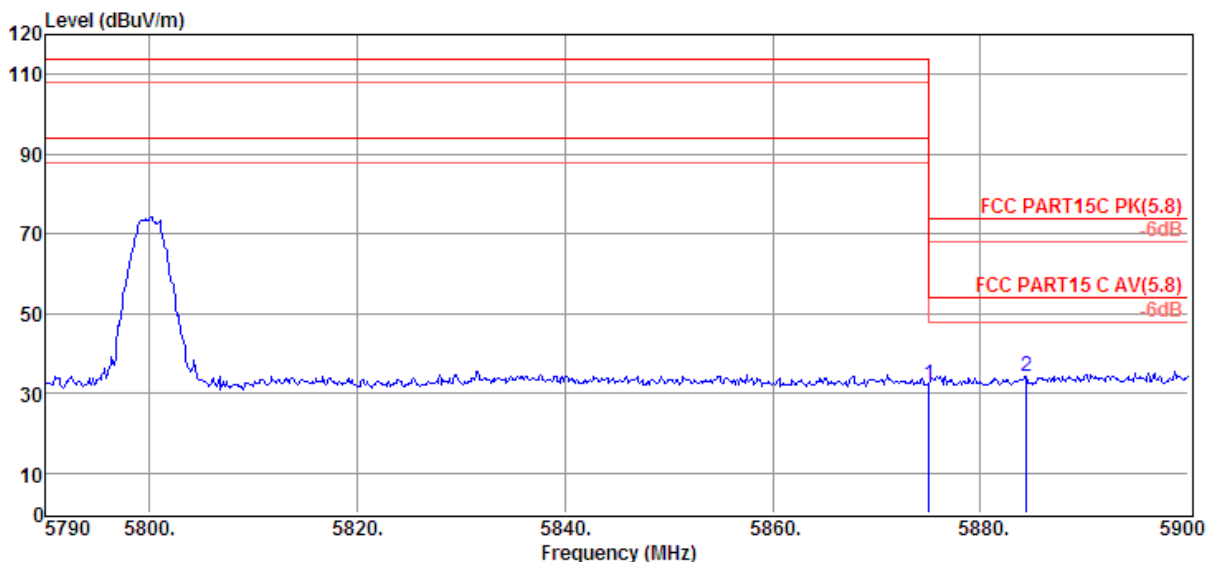

Item (Mark)	Freq. (MHz)	Read Level (dBμV)	Antenna Factor (dB/m)	PRM Factor dB	Cable Loss dB	Result Level (dBμV/m)	Limit Line (dBμV/m)	Over Limit (dB)	Detector	Polarization
1	5875.00	31.79	35.65	43.28	8.13	32.29	74.00	-41.71	Peak	HORIZONTAL
2	5884.38	33.63	35.65	43.27	8.14	34.15	74.00	-39.85	Peak	HORIZONTAL

- Note: 1. Result Level = Read Level + Antenna Factor + Cable loss - PRM Factor.  
 2. If Peak Result complies with AV limit, AV Result is deemed to comply with AV limit.  
 3. Test setup: RBW: 1 MHz, VBW: 3 MHz, Sweep time: auto.

## TR-4-E-009 Radiated Emission Test Result

<b>Test Site</b>	: DDT 3m Chamber 1#		D:\2017 RE1# Report Data\Q17120707-1\FCC.EM6
<b>Test Date</b>	: 2017-12-28	<b>Tested By</b>	: Sam
<b>EUT</b>	: Outdoor Solar Speaker with Multi-Link	<b>Model Number</b>	: SOLAR STONE MULTI
<b>Power Supply</b>	: DC 12V	<b>Test Mode</b>	: TX mode
<b>Condition</b>	: Temp:24.5°C,Humi:55%, Press:100.1kPa	<b>Antenna/Distance</b>	: 2017 HF907/3m/VERTICAL
<b>Memo</b>	: 5800MHz		

Data: 10

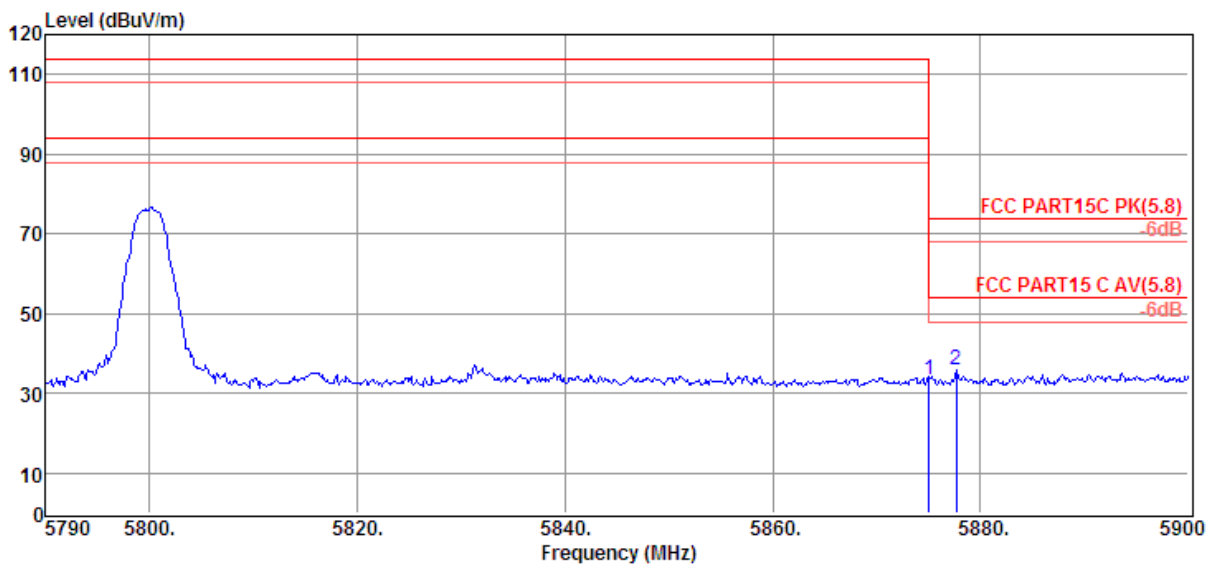

Item (Mark)	Freq. (MHz)	Read Level (dBμV)	Antenna Factor (dB/m)	PRM Factor dB	Cable Loss dB	Result Level (dBμV/m)	Limit Line (dBμV/m)	Over Limit (dB)	Detector	Polarization
1	5875.00	32.79	35.65	43.28	8.13	33.29	74.00	-40.71	Peak	VERTICAL
2	5877.67	35.19	35.65	43.27	8.13	35.70	74.00	-38.30	Peak	VERTICAL

- Note: 1. Result Level = Read Level + Antenna Factor + Cable loss - PRM Factor.  
 2. If Peak Result complies with AV limit, AV Result is deemed to comply with AV limit.  
 3. Test setup: RBW: 1 MHz, VBW: 3 MHz, Sweep time: auto.

## 7. Power Line Conducted Emission

### 7.1. Block diagram of test setup

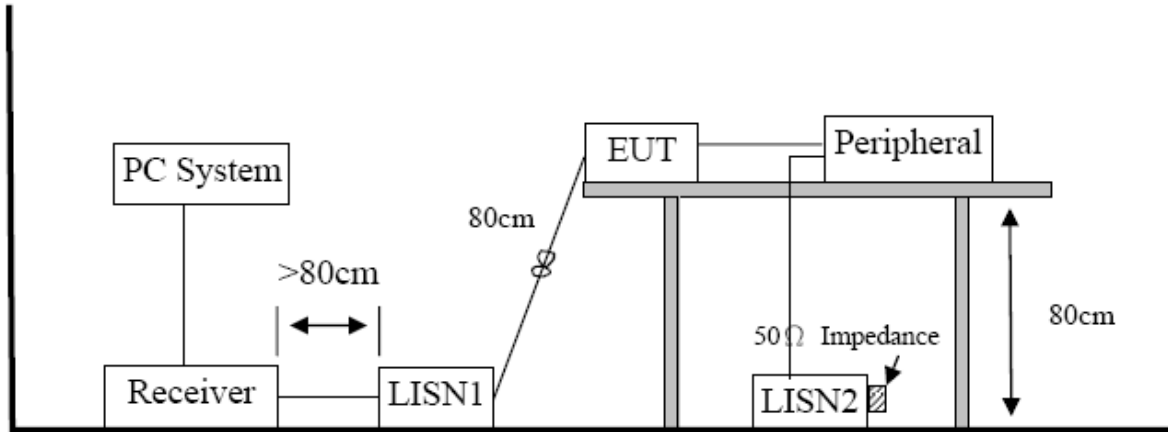

### 7.2. Power Line Conducted Emission Limits

Frequency	Quasi-Peak Level dB( $\mu$ V)	Average Level dB( $\mu$ V)
150kHz ~ 500kHz	66 ~ 56*	56 ~ 46*
500kHz ~ 5MHz	56	46
5MHz ~ 30MHz	60	50

Note 1: \* Decreasing linearly with logarithm of frequency.

Note 2: The lower limit shall apply at the transition frequencies.

### 7.3. Test Procedure

The EUT and Support equipment, if needed, were put placed on a non-metallic table, 80cm above the ground plane.

Configuration EUT to simulate typical usage as described in clause 2.4 and test equipment as described in clause 10.2 of this report.

All I/O cables were positioned to simulate typical actual usage as per ANSI C63.10.

All support equipment power received from a second LISN.

Emissions were measured on each current carrying line of the EUT using an EMI Test Receiver connected to the LISN powering the EUT.

The Receiver scanned from 150 kHz to 30MHz for emissions in each of the test modes.

During the above scans, the emissions were maximized by cable manipulation.

The test mode(s) described in clause 2.4 were scanned during the preliminary test.

After the preliminary scan, we found the test mode producing the highest emission level. The EUT configuration and worse cable configuration of the above highest emission levels were recorded



for reference of the final test.

EUT and support equipment were set up on the test bench as per the configuration with highest emission level in the preliminary test.

A scan was taken on both power lines, Neutral and Line, recording at least the six highest emissions.

Emission frequency and amplitude were recorded into a computer in which correction factors were used to calculate the emission level and compare reading to the applicable limit.

The test data of the worst-case condition(s) was recorded.

The bandwidth of test receiver is set at 9 KHz.

#### **7.4. Test Result**

**PASS. (See below detailed test result)**

Note1: All emissions not reported below are too low against the prescribed limits.

Note2: “-----” means Peak detection; “-----” means Average detection

Note3: Pre-test AC conducted emission at both voltage AC 120V/60Hz and AC 240V/50Hz, recorded worst case (AC 120V/60Hz).

# TR-4-E-010 Conducted Emission Test Result

**Test Site** : DDT 1# Shield Room E:\2017 CE report data\Q17112004-1E\CE.EM6  
**Test Date** : 2017-12-25 **Tested By** : Xian  
**EUT** : Outdoor Solar Speaker with Multi-Link **Model Number** : SOLAR STONE MULTI  
**Power Supply** : AC 120V/60Hz **Test Mode** : TX mode  
**Condition** : Temp:24.5°C,Humi:55%,  
**LISN** : 2017 ENV216/LINE  
 Press:100.1kPa  
**Memo** :

Data: 10

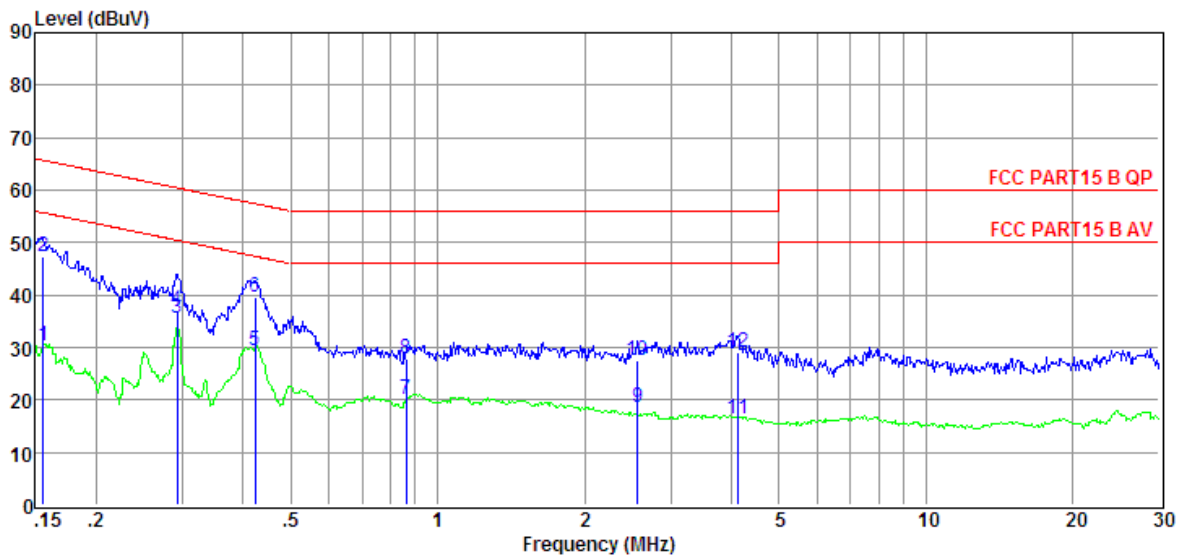

Item (Mark)	Freq. (MHz)	Read Level (dBμV)	LISN Factor (dB)	Cable Loss (dB)	Pulse Limiter Factor (dB)	Result Level (dBμV)	Limit Line (dBμV)	Over Limit (dB)	Detector	Phase
1	0.16	10.89	9.52	-0.04	9.86	30.23	55.69	-25.46	Average	LINE
2	0.16	27.89	9.52	-0.04	9.86	47.23	65.69	-18.46	QP	LINE
3	0.29	16.32	9.53	-0.04	9.86	35.67	50.46	-14.79	Average	LINE
4	0.29	17.83	9.53	-0.04	9.86	37.18	60.46	-23.28	QP	LINE
5	0.42	10.08	9.53	-0.04	9.82	29.39	47.37	-17.98	Average	LINE
6	0.42	20.39	9.53	-0.04	9.82	39.70	57.37	-17.67	QP	LINE
7	0.86	0.81	9.56	-0.12	9.86	20.11	46.00	-25.89	Average	LINE
8	0.86	8.42	9.56	-0.12	9.86	27.72	56.00	-28.28	QP	LINE
9	2.57	-0.75	9.61	-0.12	9.87	18.61	46.00	-27.39	Average	LINE
10	2.57	8.10	9.61	-0.12	9.87	27.46	56.00	-28.54	QP	LINE
11	4.11	-3.10	9.63	-0.10	9.87	16.30	46.00	-29.70	Average	LINE
12	4.11	9.71	9.63	-0.10	9.87	29.11	56.00	-26.89	QP	LINE

Note: 1. Result Level = Read Level + LISN Factor + Pulse Limiter Factor + Cable loss.  
 2. If QP Result complies with AV limit, AV Result is deemed to comply with AV limit.  
 3. Test setup: RBW: 200 Hz (9 kHz—150 kHz), 9 kHz (150 kHz—30 MHz).  
 4. Step size: 80Hz (0.009MHz-0.15MHz), 4 kHz (0.15MHz-30MHz), Scan time: auto.

# TR-4-E-010 Conducted Emission Test Result

**Test Site** : DDT 1# Shield Room E:\2017 CE report data\Q17112004-1E\CE.EM6  
**Test Date** : 2017-12-25 **Tested By** : Xian  
**EUT** : Outdoor Solar Speaker with Multi-Link **Model Number** : SOLAR STONE MULTI  
**Power Supply** : AC 120V/60Hz **Test Mode** : TX mode  
**Condition** : Temp:24.5°C,Humi:55%,  
**LISN** : 2017 ENV216/NEUTRAL  
 Press:100.1kPa  
**Memo** :

Data: 12

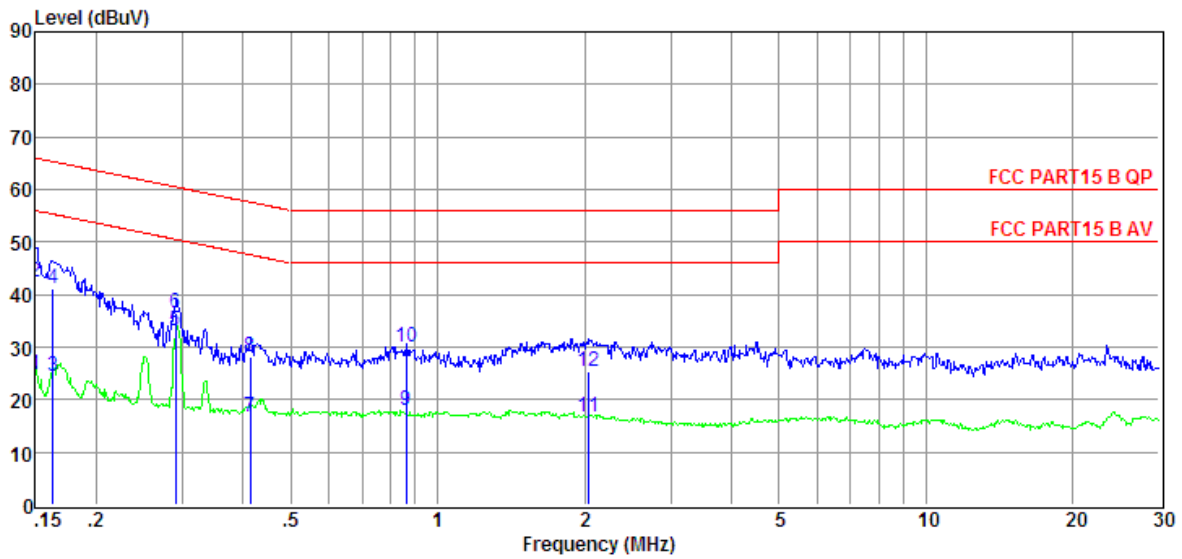

Item (Mark)	Freq. (MHz)	Read Level (dBμV)	LISN Factor (dB)	Cable Loss (dB)	Pulse Limiter Factor (dB)	Result Level (dBμV)	Limit Line (dBμV)	Over Limit (dB)	Detector	Phase
1	0.15	5.38	9.49	-0.04	9.86	24.69	56.00	-31.31	Average	NEUTRAL
2	0.15	23.18	9.49	-0.04	9.86	42.49	66.00	-23.51	QP	NEUTRAL
3	0.16	5.18	9.48	-0.04	9.86	24.48	55.30	-30.82	Average	NEUTRAL
4	0.16	21.87	9.48	-0.04	9.86	41.17	65.30	-24.13	QP	NEUTRAL
5	0.29	13.79	9.40	-0.04	9.86	33.01	50.50	-17.49	Average	NEUTRAL
6	0.29	17.12	9.40	-0.04	9.86	36.34	60.50	-24.16	QP	NEUTRAL
7	0.41	-2.48	9.37	-0.04	9.82	16.67	47.59	-30.92	Average	NEUTRAL
8	0.41	8.98	9.37	-0.04	9.82	28.13	57.59	-29.46	QP	NEUTRAL
9	0.86	-1.22	9.30	-0.12	9.86	17.82	46.00	-28.18	Average	NEUTRAL
10	0.86	10.87	9.30	-0.12	9.86	29.91	56.00	-26.09	QP	NEUTRAL
11	2.03	-2.46	9.29	-0.12	9.87	16.58	46.00	-29.42	Average	NEUTRAL
12	2.03	6.22	9.29	-0.12	9.87	25.26	56.00	-30.74	QP	NEUTRAL

Note: 1. Result Level = Read Level + LISN Factor + Pulse Limiter Factor + Cable loss.  
 2. If QP Result complies with AV limit, AV Result is deemed to comply with AV limit.  
 3. Test setup: RBW: 200 Hz (9 kHz—150 kHz), 9 kHz (150 kHz—30 MHz).  
 4. Step size: 80Hz (0.009MHz-0.15MHz), 4 kHz (0.15MHz-30MHz), Scan time: auto.

## **8. Antenna Requirements**

### **8.1. Limit**

For intentional device, according to FCC 47 CFR Section 15.203, an intentional radiator shall be designed to ensure that no antenna other than that furnished by the responsible party shall be used with the device.

### **8.2. Result**

The antennas used for this product are dedicated Antenna and that no antenna other than that furnished by the responsible party shall be used with the device, the maximum peak gain of the transmit antenna is only 3.57dBi.

**END OF REPORT**