

FCC 47 CFR PART 15 SUBPART C

CERTIFICATION TEST REPORT

For

WIRELESS STEREO SPEAKER WITH BUILT-IN LIGHTING

MODEL No.: Sound Shine

FCC ID: 2AB3E-ISP38

Trademark: ION

REPORT NO.: ES140929370E

ISSUE DATE: November 26, 2014

Prepared for

**Ion Audio, LLC
200 Scenic View Drive, Suite 201 Cumberland, United States**

Prepared by

SHENZHEN EMTEK CO., LTD.

**Bldg 69, Majialong Industry Zone, Nanshan District, Shenzhen,
Guangdong, China
TEL: 86-755-26954280
FAX: 86-755-26954282**

Table of Contents

1	TEST RESULT CERTIFICATION	3
2	EUT TECHNICAL DESCRIPTION	4
3	SUMMARY OF TEST RESULT	5
4	TEST METHODOLOGY	6
4.1	GENERAL DESCRIPTION OF APPLIED STANDARDS	6
4.2	MEASUREMENT EQUIPMENT USED	6
4.3	DESCRIPTION OF TEST MODES	6
5	FACILITIES AND ACCREDITATIONS	8
5.1	FACILITIES	8
5.2	LABORATORY ACCREDITATIONS AND LISTINGS	8
6	TEST SYSTEM UNCERTAINTY	9
7	SETUP OF EQUIPMENT UNDER TEST	10
7.1	RADIO FREQUENCY TEST SETUP 1	10
7.2	RADIO FREQUENCY TEST SETUP 2	10
7.3	CONDUCTED EMISSION TEST SETUP	11
7.4	SUPPORT EQUIPMENT	11
8	TEST REQUIREMENTS	12
8.1	20DB BANDWIDTH	12
8.2	CARRIER FREQUENCY SEPARATION	18
8.3	NUMBER OF HOPPING FREQUENCIES	24
8.4	AVERAGE TIME OF OCCUPANCY (DWELL TIME)	26
8.5	MAXIMUM PEAK CONDUCTED OUTPUT POWER	29
8.6	BAND EDGE TEST	35
8.7	TEST SET-UP (BLOCK DIAGRAM OF CONFIGURATION)	35
8.8	MEASUREMENT EQUIPMENT USED:	35
8.9	MEASUREMENT RESULTS:	36
8.10	CONDUCTED SUPRIOUS EMISSION	44
8.11	RADIATED SPURIOUS EMISSION	48
8.12	CONDUCTED EMISSION TEST	58
8.13	ANTENNA APPLICATION	61

1 TEST RESULT CERTIFICATION

Applicant:	Ion Audio, LLC 200 Scenic View Drive, Suite 201 Cumberland
Manufacturer:	SHENZHEN FENDA TECHNOLOGY CO., LTD. Fenda Hi-Tech Park, Zhoushi Road, Shiyan Town, Baoan District, Shenzhen City, Guangdong, China
Product Description:	WIRELESS STEREO SPEAKER WITH BUILT-IN LIGHTING
Model Number:	Sound Shine
File Number:	ES140929370E
Date of Test:	October 23, 2014 to November 26, 2014

Measurement Procedure Used:

APPLICABLE STANDARDS	
STANDARD	TEST RESULT
FCC 47 CFR Part 2, Subpart J FCC 47 CFR Part 15, Subpart C	PASS

The above equipment was tested by SHENZHEN EMTEK CO., LTD. The test data, data evaluation, test procedures, and equipment configurations shown in this report were made in accordance with the procedures given in ANSI C63.4 (2009) and the energy emitted by the sample EUT tested as described in this report is in compliance with the requirements of FCC Rules Part 2 and Part 15.247

The test results of this report relate only to the tested sample identified in this report

Date of Test : October 23, 2014 to November 26, 2014

Prepared by : 
 Yaping Shen/Editor

Reviewer : 
 Joe Xia/Supervisor

Approve & Authorized Signer : 
 Lisa Wang/Manager

2 EUT TECHNICAL DESCRIPTION

Characteristics	Description
Device Type:	WIRELESS STEREO SPEAKER WITH BUILT-IN LIGHTING
Data Rate	1Mbps for BT GFSK modulation 2Mbps for BT $\pi/4$ -DQPSK modulation 3Mbps for BT 8DPSK modulation
Modulation:	GFSK modulation $\pi/4$ -DQPSK modulation 8DPSK modulation
Operating Frequency Range(s):	2402-2480MHz
Number of Channels:	79 channels
Transmit Power Max:	0.351dBm
Antenna Type :	Integral Antenna
Antenna Gain:	2 dBi ;
Power supply:	<input type="checkbox"/> DC supply: 3.7V internal rechargeable lithium battery or DC 5V from AC adapter
	<input type="checkbox"/> Adapter supply: Model: A31-501000 Input: 100-240V~, 50/60Hz, 0.2A Output: DC 5.0V, 1000mA
	<input checked="" type="checkbox"/> AC supply: AC 100-240V 50/60Hz, 0.2A 10W
Temperature Range	-20°C ~ +55°C

Note: for more details, please refer to the User's manual of the EUT.

3 SUMMARY OF TEST RESULT

FCC Part Clause	Test Parameter	Verdict	Remark
15.247(a)(1)	20 dB Bandwidth	PASS	
15.247(a)(1)	Carrier Frequency Separation	PASS	
15.247(a)(1)	Number of Hopping Frequencies	PASS	
15.247(a)(1)	Average Time of Occupancy (Dwell Time)	PASS	
15.247(b)(1)	Maximum Peak Conducted Output Power	PASS	
15.247(c)	Conducted Spurious Emissions	PASS	
15.247(d) 15.209	Radiated Spurious Emissions	PASS	
15.207	Conducted Emission	PASS	
15.247(b)	Antenna Application	PASS	
NOTE1: N/A (Not Applicable)			

RELATED SUBMITTAL(S) / GRANT(S):

This submittal(s) (test report) is intended for FCC ID: 2AB3E-ISP38 filing to comply with Section 15.247 of the FCC Part 15, Subpart C Rules.

4 TEST METHODOLOGY

4.1 GENERAL DESCRIPTION OF APPLIED STANDARDS

According to its specifications, the EUT must comply with the requirements of the following standards:
 FCC 47 CFR Part 2, Subpart J
 FCC 47 CFR Part 15, Subpart C
 DA 00-705

4.2 MEASUREMENT EQUIPMENT USED

4.2.1 Conducted Emission Test Equipment

EQUIPMENT TYPE	MFR	MODEL NUMBER	SERIAL NUMBER	LAST CAL.
Test Receiver	Rohde & Schwarz	ESCS30	828985/018	05/17/2014
L.I.S.N.	Schwarzbeck	NNLK8129	8129203	05/17/2014
50Ω Coaxial Switch	Anritsu	MP59B	M20531	N/A
Pulse Limiter	Rohde & Schwarz	ESH3-Z2	100006	05/17/2014
Voltage Probe	Rohde & Schwarz	TK9416	N/A	05/17/2014
I.S.N	Rohde & Schwarz	ENY22	1109.9508.02	05/17/2014

4.2.2 Radiated Emission Test Equipment

EQUIPMENT TYPE	MFR	MODEL NUMBER	SERIAL NUMBER	LAST CAL.
EMI Test Receiver	Rohde & Schwarz	ESU	1302.6005.26	05/17/2014
Pre-Amplifier	HP	8447D	2944A07999	05/17/2014
Bilog Antenna	Schwarzbeck	VULB9163	142	05/17/2014
Loop Antenna	ARA	PLA-1030/B	1029	05/17/2014
Horn Antenna	Schwarzbeck	BBHA 9170	BBHA9170399	05/17/2014
Horn Antenna	Schwarzbeck	BBHA 9120	D143	05/17/2014
Cable	Schwarzbeck	AK9513	ACRX1	05/17/2014
Cable	Rosenberger	N/A	FP2RX2	05/17/2014
Cable	Schwarzbeck	AK9513	CRPX1	05/17/2014
Cable	Schwarzbeck	AK9513	CRRX2	05/17/2014

4.2.3 Radio Frequency Test Equipment

EQUIPMENT TYPE	MFR	MODEL NUMBER	SERIAL NUMBER	LAST CAL.
Spectrum Analyzer	Agilent	E4407B	88156318	05/17/2014
Power meter	Anritsu	ML2495A	0824006	05/17/2014
Power sensor	Anritsu	MA2411B	0738172	05/17/2014

Remark: Each piece of equipment is scheduled for calibration once a year.

4.3 DESCRIPTION OF TEST MODES

The EUT has been tested under its typical operating condition.
 The EUT configuration for testing is installed on RF field strength measurement to meet the Commissions requirement and operating in a manner which intends to maximize its emission characteristics in a continuous normal application.

The Transmitter was operated in the normal operating mode. The TX frequency was fixed which was for the purpose of the measurements.

Test of channel included the lowest and middle and highest frequency to perform the test, then record on this report.

Those data rates (1Mbps for Bluetooth v2.1 BR GFSK modulation; 2Mbps for Bluetooth v2.0/v2.1 /v3.0 EDR $\pi/4$ -DQPSK modulation; 3Mbps for Bluetooth v2.0/v2.1 /v3.0 EDR 8DPSK modulation) were used for all test.

Pre-defined engineering program for regulatory testing used to control the EUT for staying in continuous transmitting and receiving mode is programmed.

Frequency and Channel list for Bluetooth v2.1

Channel	Frequency (MHz)	Channel	Frequency (MHz)	Channel	Frequency (MHz)
1	2402	40	2441
2	2403	41	2442	77	2478
3	2404	42	2443	78	2479
...	79	2480

Note: $f_c=2402\text{MHz}+k\times 1\text{MHz}$ k=1 to 78

Test Frequency and channel for Bluetooth v2.1

Lowest Frequency		Middle Frequency		Highest Frequency	
Channel	Frequency (MHz)	Channel	Frequency (MHz)	Channel	Frequency (MHz)
1	2402	40	2441	79	2480

5 FACILITIES AND ACCREDITATIONS

5.1 FACILITIES

All measurement facilities used to collect the measurement data are located at

Bldg 69, Majialong Industry Zone District, Nanshan District, Shenzhen, China

The sites are constructed in conformance with the requirements of ANSI C63.7, ANSI C63.4 and CISPR Publication 22.

5.2 LABORATORY ACCREDITATIONS AND LISTINGS

Site Description

EMC Lab.

- : Accredited by CNAS, 2013.10.28
The certificate is valid until 2016.10.29
The Laboratory has been assessed and proved to be in compliance with CNAS-CL01: 2006(identical to ISO/IEC17025: 2005)
The Certificate Registration Number is L229

- : Accredited by TUV Rheinland Shenzhen, 2010.5.25
The Laboratory has been assessed according to the requirements ISO/IEC 17025.
- : Accredited by FCC, October 28, 2010
The Certificate Registration Number is 406365.
- : Accredited by FCC, February 28, 2013
The Certificate Registration Number is 709623.
- : Accredited by Industry Canada, May 24, 2008
The Certificate Registration Number is 4480A-2

6 TEST SYSTEM UNCERTAINTY

The following measurement uncertainty levels have been estimated for tests performed on the apparatus:

Parameter	Uncertainty
Radio Frequency	$\pm 1 \times 10^{-5}$
Maximum Peak Output Power Test	$\pm 1.0\text{dB}$
Conducted Emissions Test	$\pm 2.0\text{dB}$
Radiated Emission Test	$\pm 2.0\text{dB}$
Occupied Bandwidth Test	$\pm 1.0\text{dB}$
Band Edge Test	$\pm 3\text{dB}$
All emission, radiated	$\pm 3\text{dB}$
Antenna Port Emission	$\pm 3\text{dB}$
Temperature	$\pm 0.5^{\circ}\text{C}$
Humidity	$\pm 3\%$

Measurement Uncertainty for a level of Confidence of 95%

7 SETUP OF EQUIPMENT UNDER TEST

7.1 RADIO FREQUENCY TEST SETUP 1

The Bluetooth v2.1 component's antenna ports(s) of the EUT are connected to the measurement instrument per an appropriate attenuator. The EUT is controlled by PC/software to emit the specified signals for the purpose of measurements.

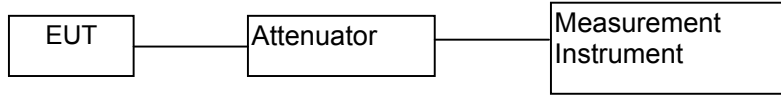

7.2 RADIO FREQUENCY TEST SETUP 2

The test site semi-anechoic chamber has met the requirement of NSA tolerance 4 dB according to the standards: ANSI C63.4. The test distance is 3m. The setup is according to the requirements in Section 13.1.4.1 of ANSI C63.4-2009 and CAN/CSA-CEI/IEC CISPR 22.

The maximal emission value is acquired by adjusting the antenna height, polarisation and turntable azimuth. Normally, the height range of antenna is 1 m to 4 m, the azimuth range of turntable is 0° to 360°, and the receive antenna has two polarizations Vertical (V) and Horizontal (H).

(a) Radiated Emission Test Set-Up, Frequency Below 1000MHz

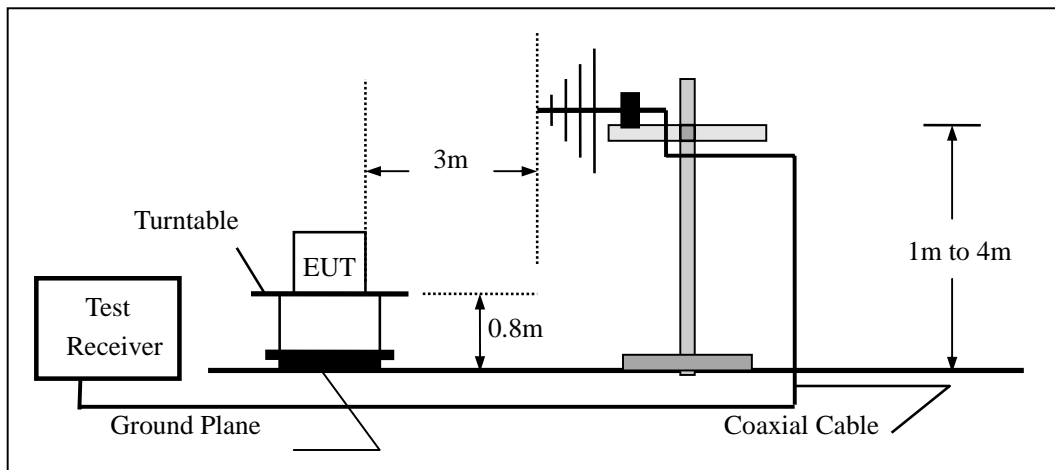

(b) Radiated Emission Test Set-Up, Frequency above 1000MHz

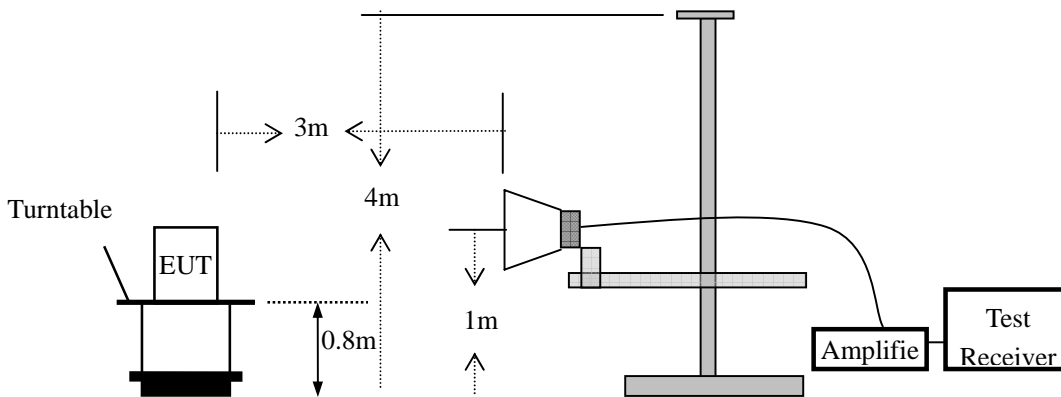

7.3 CONDUCTED EMISSION TEST SETUP

The mains cable of the EUT (maybe per AC/DC Adapter) must be connected to LISN. The LISN shall be placed 0.8 m from the boundary of EUT and bonded to a ground reference plane for LISN mounted on top of the ground reference plane. This distance is between the closest points of the LISN and the EUT. All other units of the EUT and associated equipment shall be at least 0.8m from the LISN.

Ground connections, where required for safety purposes, shall be connected to the reference ground point of the LISN and, where not otherwise provided or specified by the manufacturer, shall be of same length as the mains cable and run parallel to the mains connection at a separation distance of not more than 0.1 m.

According to the requirements in Section 13.1.4.1 of ANSI C63.4-2009 Conducted emissions from the EUT measured in the frequency range between 0.15 MHz and 30 MHz using CISPR Quasi-Peak and average detector mode.

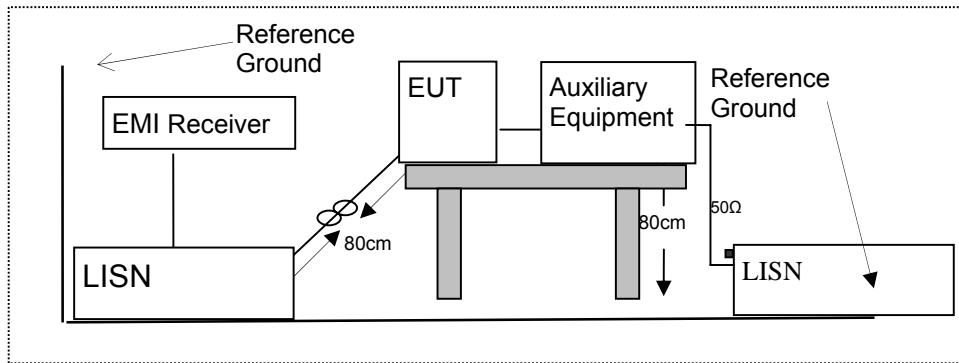

7.4 SUPPORT EQUIPMENT

Item	Equipment	Mfr/Brand	Model/Type No.	Series No.	Note
1.	iPhone 5C	Apple	A1526	N/A	N/A

Notes:

1. All the equipment/cables were placed in the worst-case configuration to maximize the emission during the test.
2. Grounding was established in accordance with the manufacturer's requirements and conditions for the intended use.

8 TEST REQUIREMENTS

8.1 20DB BANDWIDTH

8.1.1 Applicable Standard

According to FCC Part 15.247(a)(1) and DA 00-705

8.1.2 Conformance Limit

No limit requirement.

8.1.3 Test Configuration

Test according to clause 7.1 radio frequency test setup 1

8.1.4 Test Procedure

The EUT was operating in Bluetooth v2.1 mode and controlled its channel. Printed out the test result from the spectrum by hard copy function.

The RF output of EUT was connected to the spectrum analyzer by RF cable and attenuator. The path loss was compensated to the results for each measurement.

Set to the maximum power setting and enable the EUT transmit continuously

Set RBW = 30 kHz.

Set the video bandwidth (VBW) =100 kHz.

Set Span= approximately 2 to 3 times the 20 dB bandwidth

Set Detector = Peak.

Set Trace mode = max hold.

Set Sweep = auto couple.

The EUT should be transmitting at its maximum data rate. Allow the trace to stabilize. Use the marker-to-peak function to set the marker to the peak of the emission. Use the marker-delta function to measure 20 dB down one side of the emission. Reset the markerdelta function, and move the marker to the other side of the emission, until it is (as close as possible to) even with the reference marker level. The marker-delta reading at this point is the 20 dB bandwidth of the emission.

If this value varies with different modes of operation (e.g., data rate, modulation format, etc.), repeat this test for each variation.

Measure and record the results in the test report.

Test Results

Temperature : 28°C Test Date : October 29, 2014
 Humidity : 65 % Test By: KK

Modulation Mode	Channel Number	Channel Frequency (MHz)	Measurement Bandwidth (kHz)	Limit (kHz)	Verdict
GFSK	1	2402	911.400	N/A	PASS
	40	2441	849.074	N/A	PASS
	79	2480	874.257	N/A	PASS
$\pi/4$ -DQPSK	1	2402	1221.0	N/A	PASS
	40	2441	1211.0	N/A	PASS
	79	2480	1227.0	N/A	PASS
8DPSK	1	2402	1211.0	N/A	PASS
	40	2441	1214.0	N/A	PASS
	79	2480	1216.0	N/A	PASS
Note: N/A (Not Applicable)					

Test Model	20dB Bandwidth Bluetooth v2.1 Channel 1: 2402MHz	GFSK Modulation
------------	--	-----------------

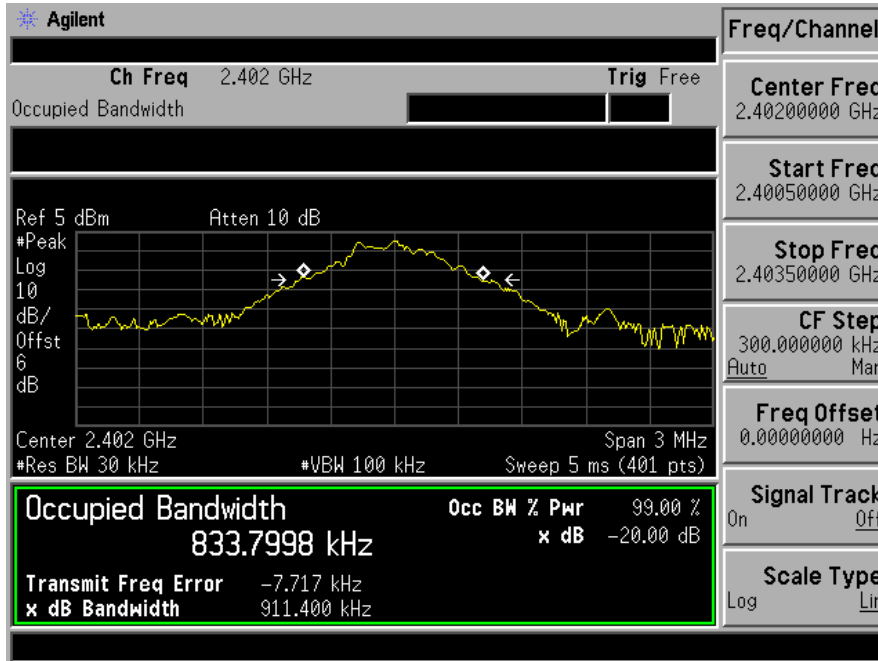

Test Model	20dB Bandwidth Bluetooth v2.1 Channel 40: 2441MHz	GFSK Modulation
------------	---	-----------------

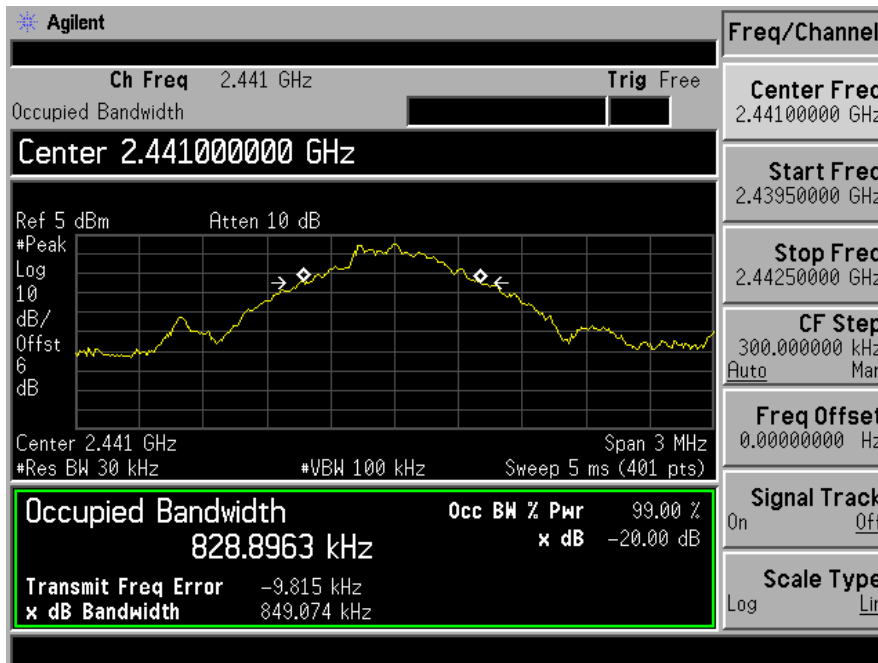

Test Model	20dB Bandwidth Bluetooth v2.1 Channel 79: 2480MHz	GFSK Modulation
------------	---	-----------------

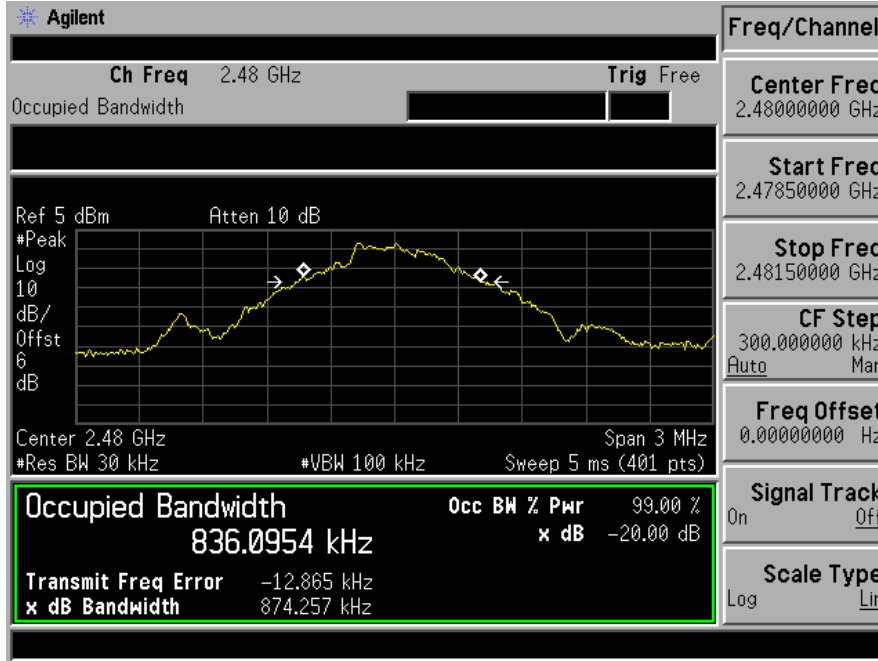

Test Model	20dB Bandwidth Bluetooth v2.1 Channel 1: 2402MHz	$\pi/4$ -DQPSK Modulation
------------	--	---------------------------

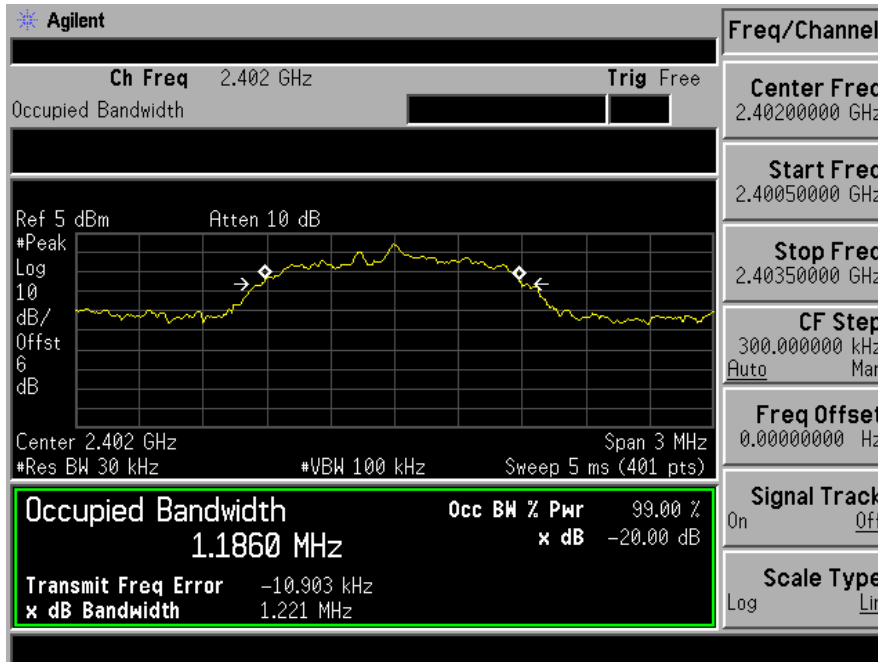

Test Model	20dB Bandwidth Bluetooth v2.1 Channel 40: 2441MHz	$\pi/4$ -DQPSK Modulation
------------	---	---------------------------

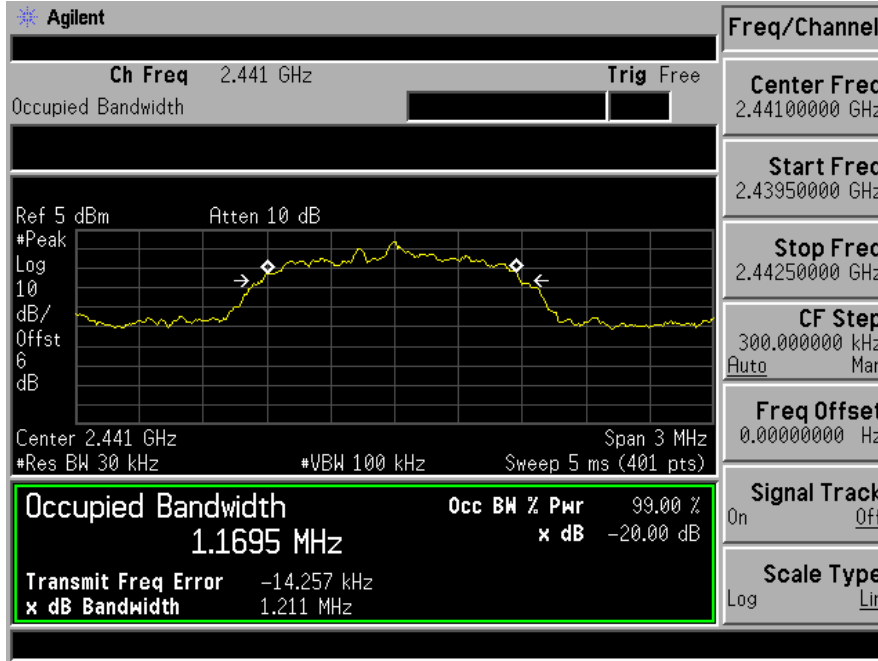

Test Model	20dB Bandwidth Bluetooth v2.1 Channel 79: 2480MHz	$\pi/4$ -DQPSK Modulation
------------	---	---------------------------

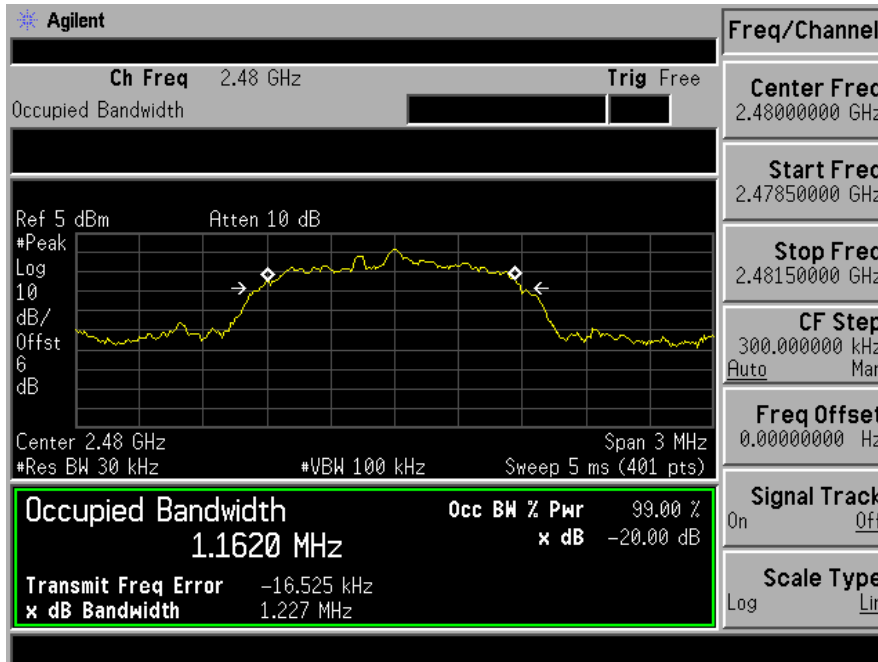

Test Model	20dB Bandwidth Bluetooth v2.1 Channel 1: 2402MHz	8DPSK Modulation
------------	--	------------------



Test Model	20dB Bandwidth Bluetooth v2.1 Channel 40: 2441MHz	8DPSK Modulation
------------	---	------------------

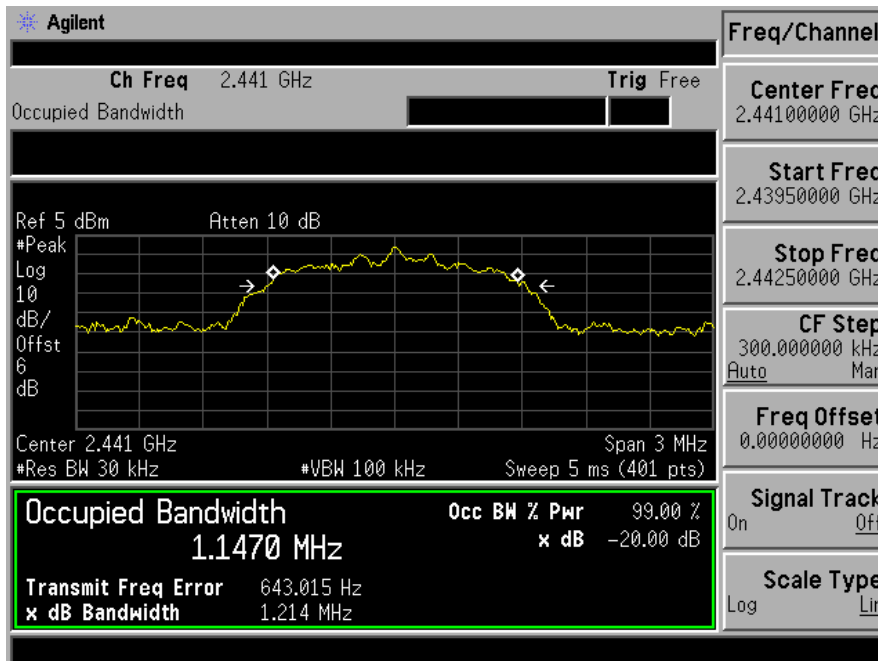

Test Model	20dB Bandwidth Bluetooth v2.1	8DPSK Modulation
	Channel 79: 2480MHz	

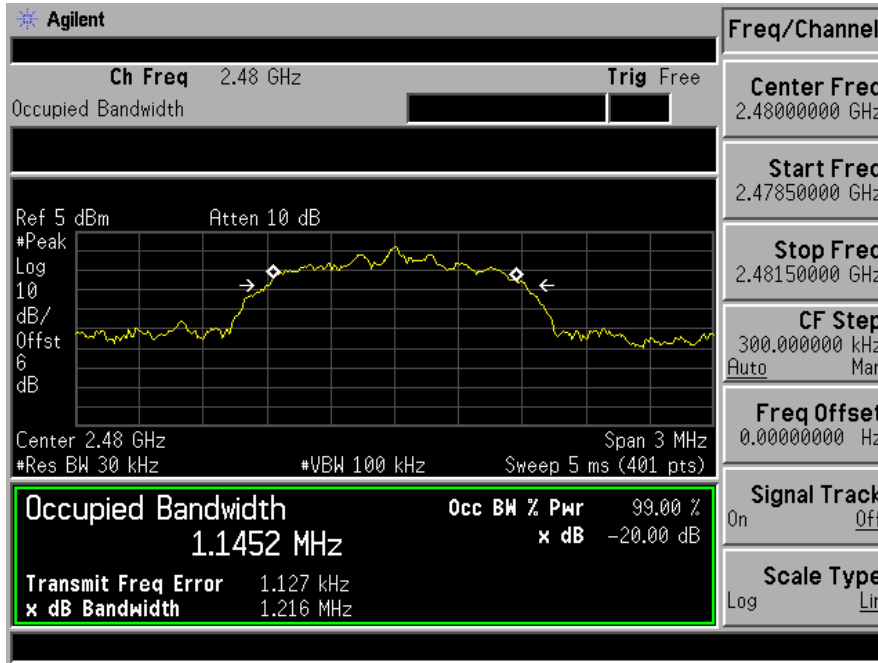

8.2 CARRIER FREQUENCY SEPARATION

8.2.1 Applicable Standard

According to FCC Part 15.247(a)(1) and DA 00-705

8.2.2 Conformance Limit

Frequency hopping systems operating in the 2400-2483.5MHz band shall have hopping channel carrier frequencies separated by a minimum of 25kHz or the 20dB bandwidth of the hopping channel, whichever is greater.

In case of an output power less than 125mW, the frequency hopping system may have channels separated by a minimum of 25kHz or two-thirds of the 20dB bandwidth of the hopping channel, whichever is greater.

8.2.3 Test Configuration

Test according to clause 7.1 radio frequency test setup 1

8.2.4 Test Procedure

■ According to FCC Part15.247(a)(1)

The EUT must have its hopping function enabled. Use the following spectrum analyzer settings:

Set the RBW =100kHz. Set VBW =300kHz.

Set the span = wide enough to capture the peaks of two adjacent channels

Set Sweep time = auto couple.

Set Detector = peak. Set Trace mode = max hold.

Allow the trace to stabilize. Use the marker-delta function to determine the separation between the peaks of the adjacent channels. The limit is specified in one of the subparagraphs of this Section. Submit this plot.

Test Results

Temperature : 28°C Test Date : October 29, 2014
 Humidity : 65 % Test By: KK

Modulation Mode	Channel Number	Channel Frequency (MHz)	Measurement Bandwidth (kHz)	Limit (kHz)	Verdict
GFSK	1	2402	1000	>911.400	PASS
	40	2441	1000	>849.074	PASS
	79	2480	1000	>874.257	PASS
π/4-DQPSK	1	2402	1000	>814.000	PASS
	40	2441	1000	>807.333	PASS
	79	2480	1000	>818.000	PASS
8DPSK	1	2402	1000	>807.333	PASS
	40	2441	1000	>809.333	PASS
	79	2480	1000	>810.667	PASS

Note: Limit = 20dB bandwidth for GFSK Modulation , Limit = 20dB bandwidth*2/3 for π/4-DQPSK &8DPSK Modulation, if it is greater than 25kHz and the output power is less than 125mW (21dBm).

Test Model	Carrier Frequency Separation Bluetooth v2.1 Channel 1: 2402MHz	GFSK Modulation
------------	--	-----------------

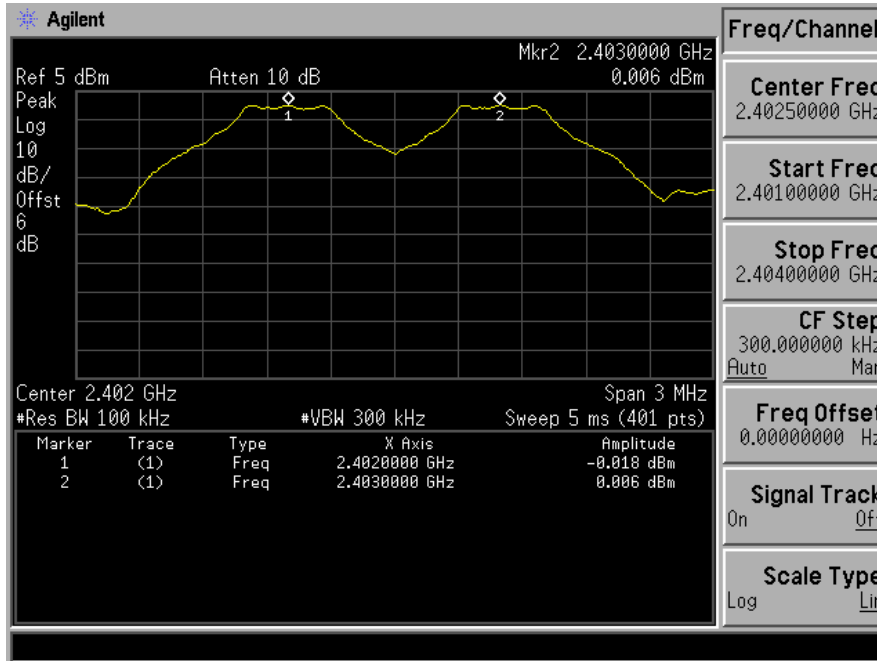

Test Model	Carrier Frequency Separation Bluetooth v2.1 Channel 40: 2441MHz	GFSK Modulation
------------	---	-----------------

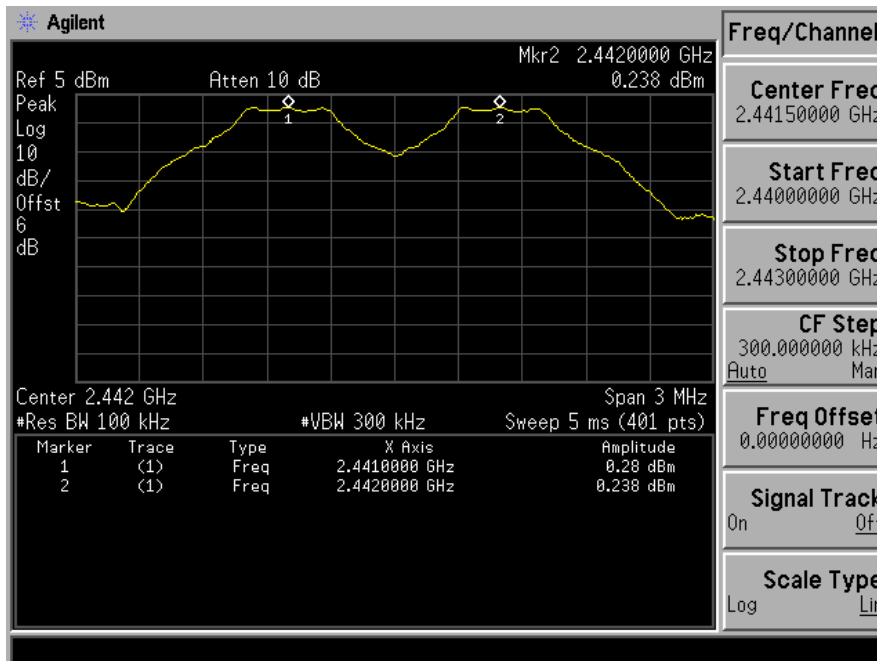

Test Model	Carrier Frequency Separation Bluetooth v2.1 Channel 79: 2480MHz	GFSK Modulation
------------	---	-----------------

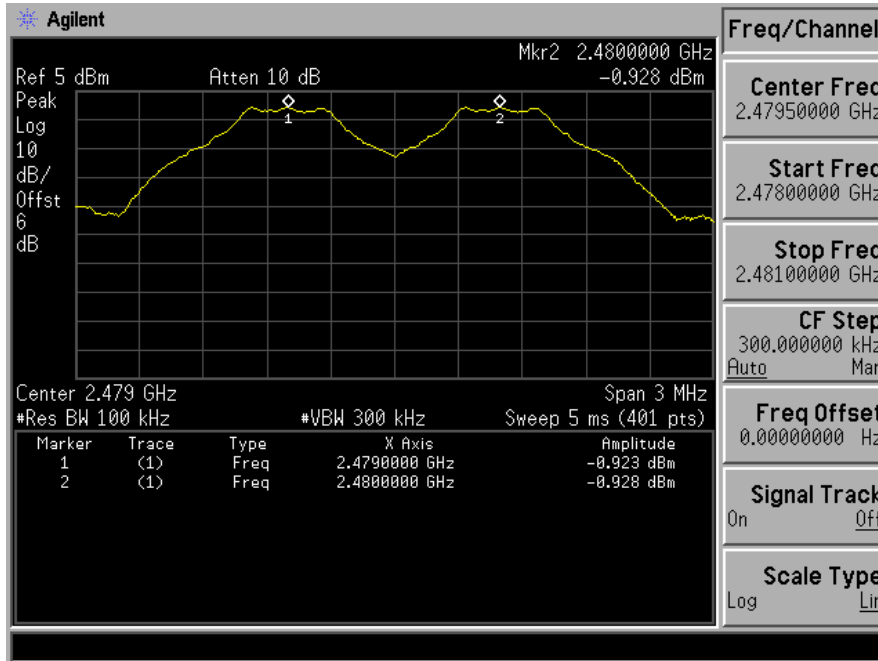

Test Model	Carrier Frequency Separation Bluetooth v2.1 Channel 1: 2402MHz	$\pi/4$ -DQPSK Modulation
------------	--	---------------------------

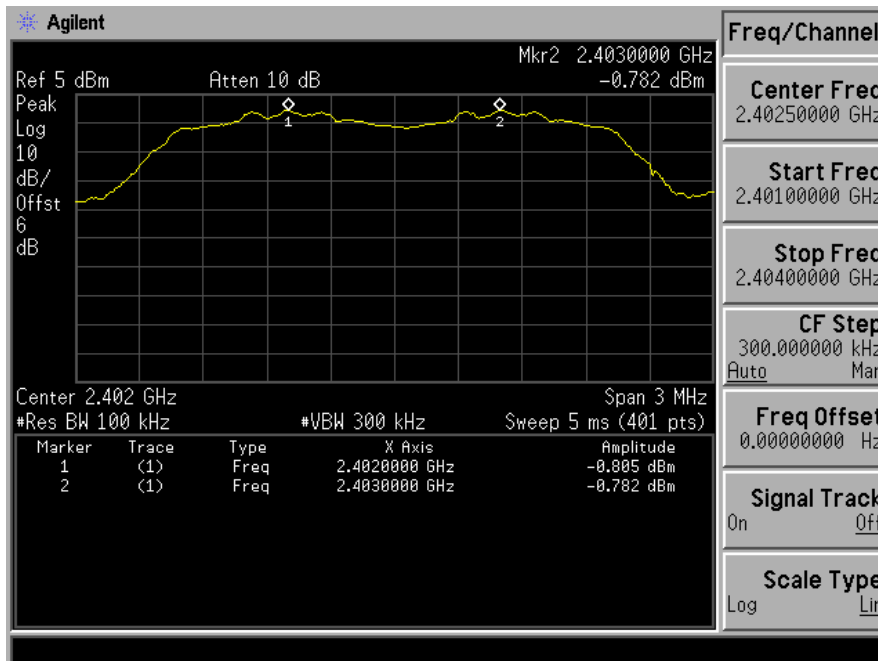

Test Model	Carrier Frequency Separation Bluetooth v2.1 Channel 40: 2441MHz	$\pi/4$ -DQPSK Modulation
------------	---	---------------------------

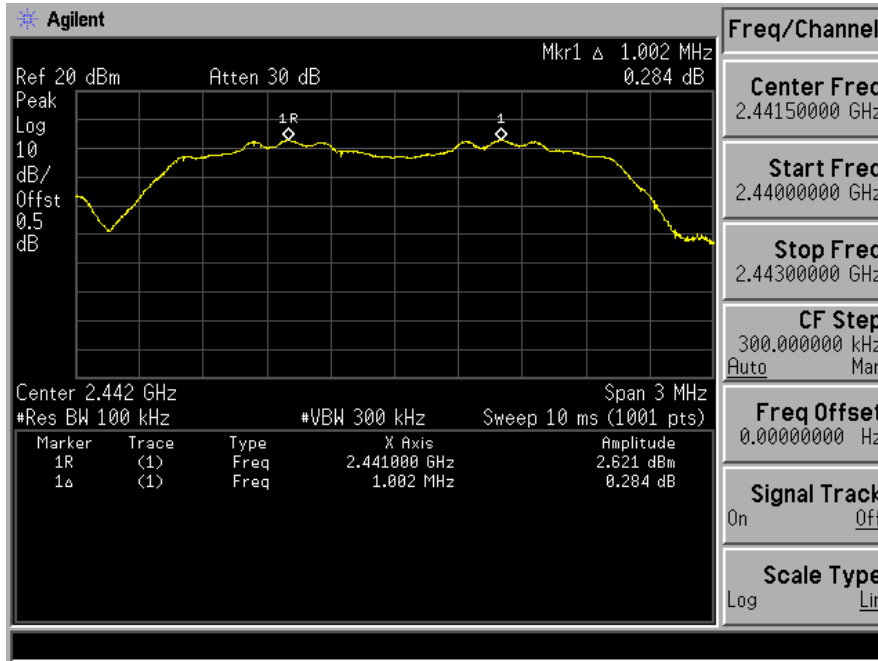

Test Model	Carrier Frequency Separation Bluetooth v2.1 Channel 79: 2480MHz	$\pi/4$ -DQPSK Modulation
------------	---	---------------------------

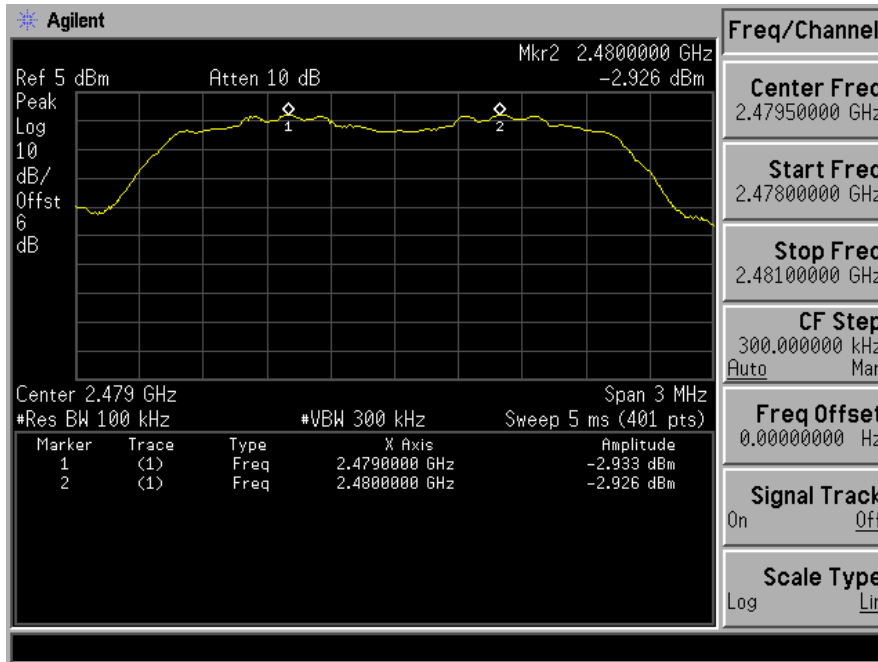

Test Model	Carrier Frequency Separation Bluetooth v2.1 Channel 1: 2402MHz	8DPSK Modulation
------------	--	------------------

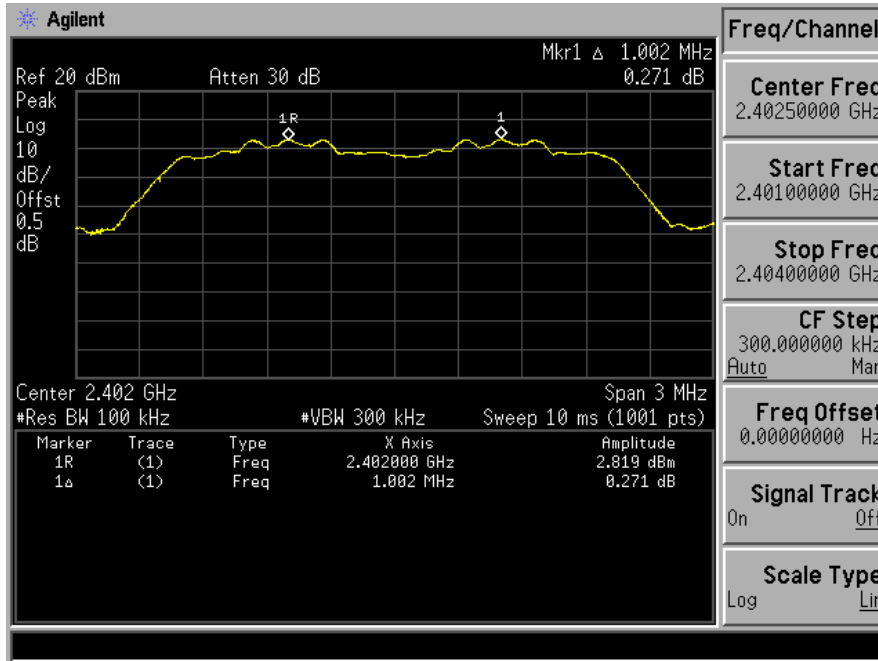

Test Model	Carrier Frequency Separation Bluetooth v2.1 Channel 40: 2441MHz	8DPSK Modulation
------------	---	------------------

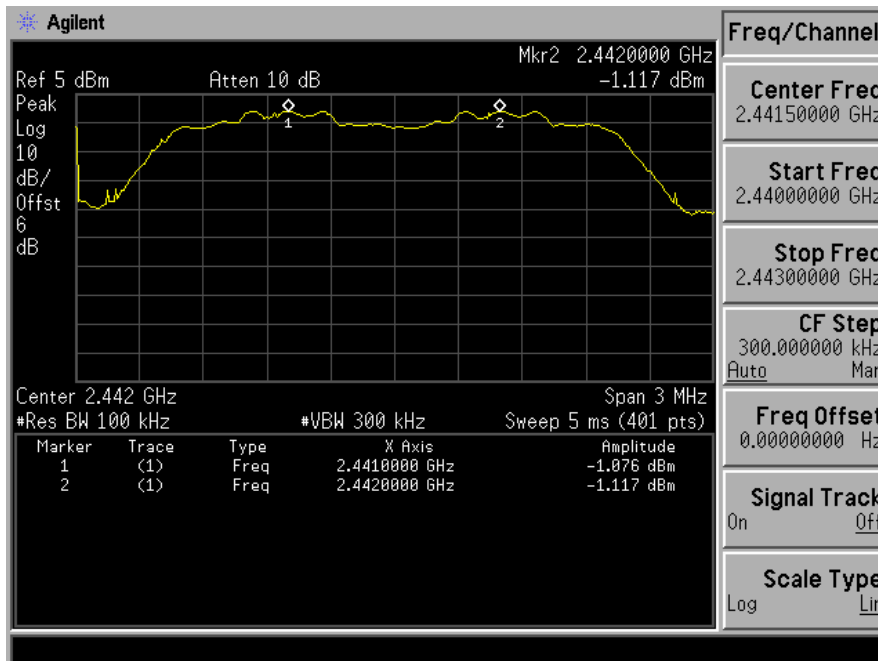

Test Model	Carrier Frequency Separation Bluetooth v2.1 Channel 79: 2480MHz	8DPSK Modulation
------------	---	------------------

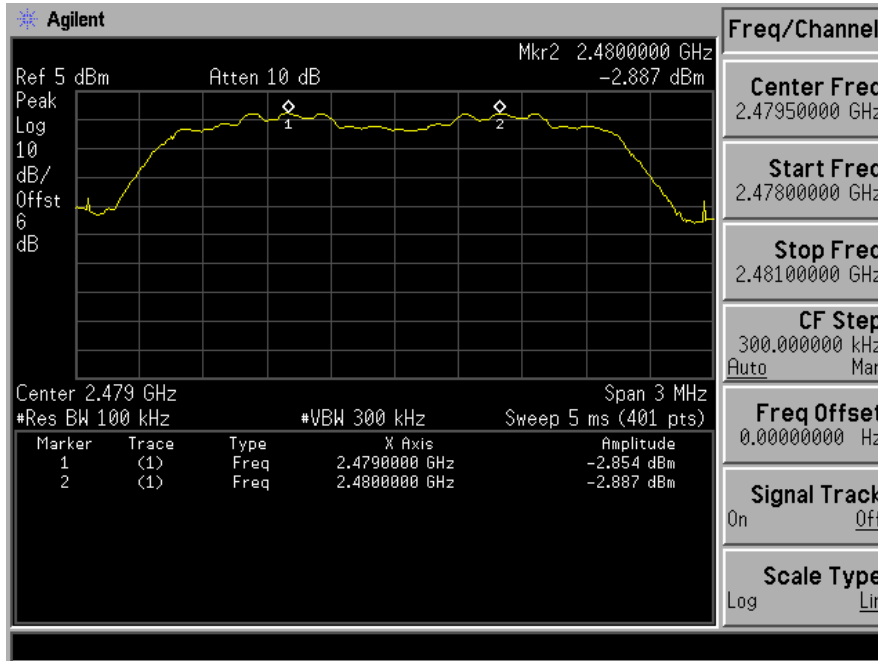

8.3 NUMBER OF HOPPING FREQUENCIES

8.3.1 Applicable Standard

According to FCC Part 15.247(a)(1) (iii)and DA 00-705

8.3.2 Conformance Limit

Frequency hopping systems operating in the 2400-2483.5MHz band shall use at least 15 channels.

8.3.3 Test Configuration

Test according to clause 7.1 radio frequency test setup 1

8.3.4 Test Procedure

- According to FCC Part15.247(a)(1)(iii)

The EUT must have its hopping function enabled. Use the following spectrum analyzer settings:

Span = the frequency band of operation (2390-2500MHz)

RBW \geq 1% of the span =500kHz

VBW \geq RBW

Sweep = auto

Detector function = peak

Trace = max hold

Allow the trace to stabilize. It may prove necessary to break the span up to sections, in order to clearly show all of the hopping frequencies.

Test Results

Hopping Channel Frequency Range	Quantity of Hopping Channel	Quantity of Hopping Channel limit
2402-2480	79	≥ 15

Test Model	Number Of Hopping Frequencies Bluetooth v2.1
------------	---

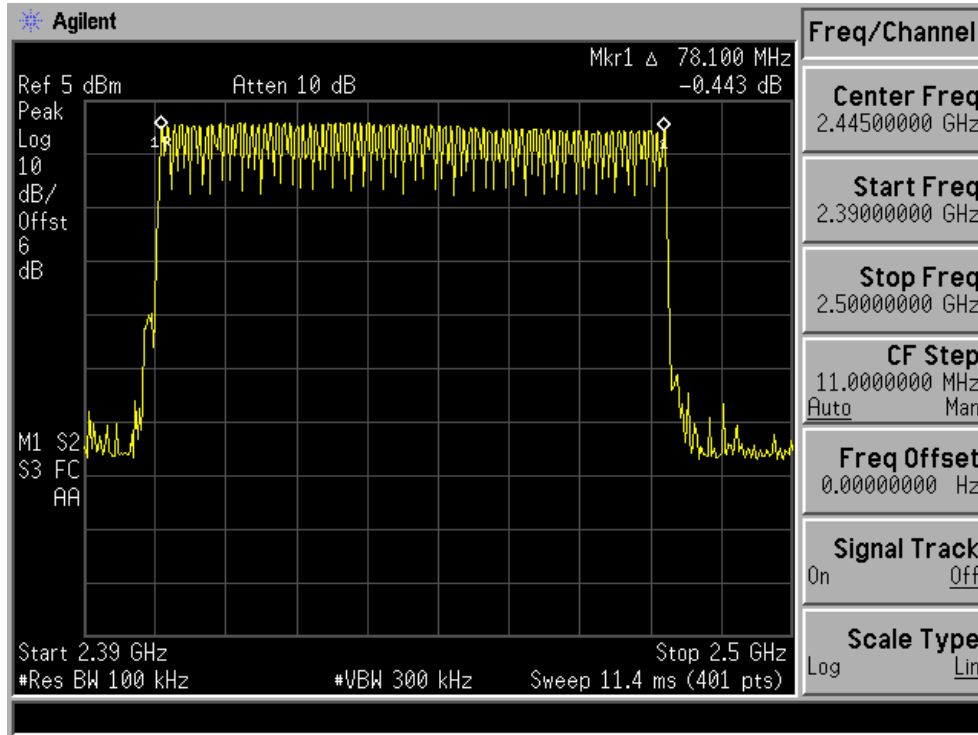

8.4 AVERAGE TIME OF OCCUPANCY (DWELL TIME)

8.4.1 Applicable Standard

According to FCC Part 15.247(a)(1)(iii) and DA 00-705

8.4.2 Conformance Limit

For frequency hopping systems operating in the 2400-2483.5MHz band, the average time of occupancy on any channel shall not be greater than 0.4s within a period of 0.4s multiplied by the number of hopping channels employed.

8.4.3 Test Configuration

Test according to clause 7.1 radio frequency test setup 1

8.4.4 Test Procedure

- According to FCC Part15.247(a)(1)(iii)

The EUT must have its hopping function enabled. Use the following spectrum analyzer settings:

Span = zero span, centered on a hopping channel

RBW = 1 MHz

VBW ≥ RBW

Sweep = as necessary to capture the entire dwell time per hopping channel

Detector function = peak

Trace = max hold

If possible, use the marker-delta function to determine the dwell time. If this value varies with different modes of operation (e.g., data rate, modulation format, etc.), repeat this test for each variation. The limit is specified in one of the subparagraphs of this Section.

8.4.5 Test Results

Temperature :	28°C	Test Date :	October 29, 2014
Humidity :	65 %	Test By:	KK

Modulation Mode	Channel Number	Packet type	Pulse width (ms)	Number per channel in 31.6s	dwell time (ms)	Limit (ms)	Verdict
GFSK	1	DH1	0.388	$1600/(2*79) \times 31.6 = 320$	124.2	<400	PASS
	1	DH3	1.650	$1600/(4*79) \times 31.6 = 160$	264.0	<400	PASS
	1	DH5	2.900	$1600/(6*79) \times 31.6 = 106.67$	309.3	<400	PASS

Note:

Test Model	Average Time Of Occupancy (Dwell Time)		
	Bluetooth v2.1		
	CH 1: 2402MHz		GFSK DH1

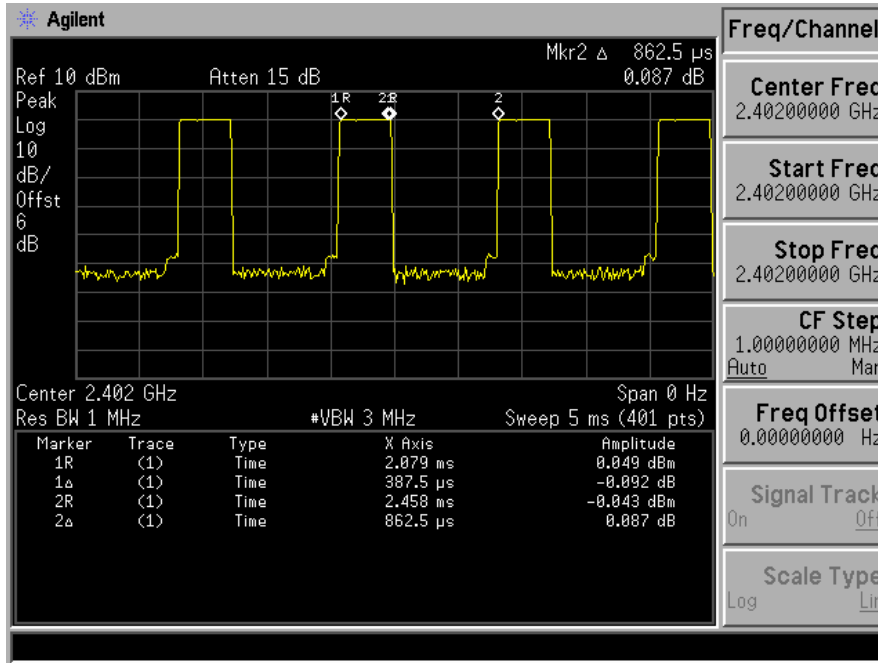

Test Model	Average Time Of Occupancy (Dwell Time)		
	Bluetooth v2.1		
	CH 1: 2402MHz		GFSK DH3

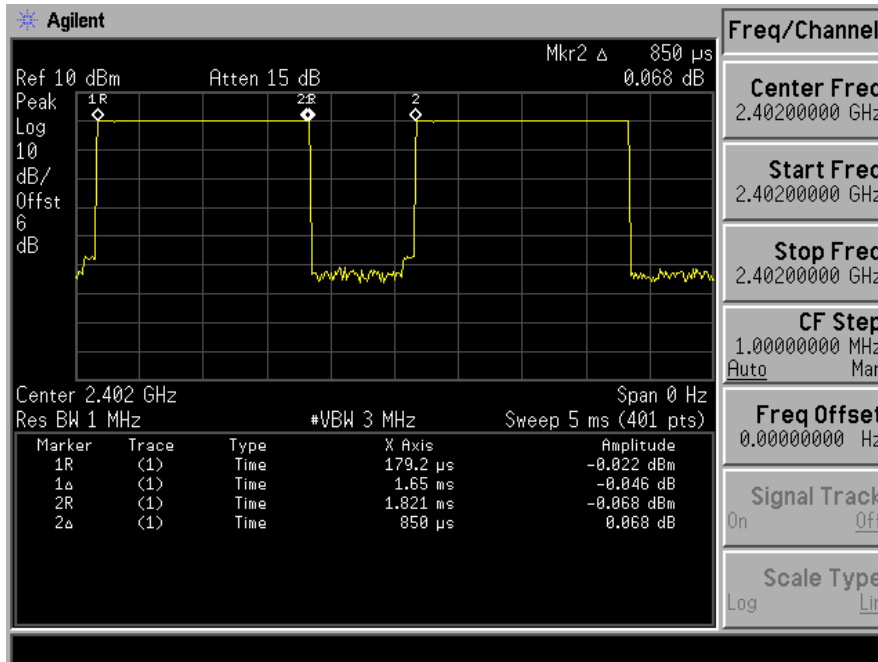

Test Model	Average Time Of Occupancy (Dwell Time)	
	Bluetooth v2.1	
	CH 1: 2402MHz	GFSK DH5

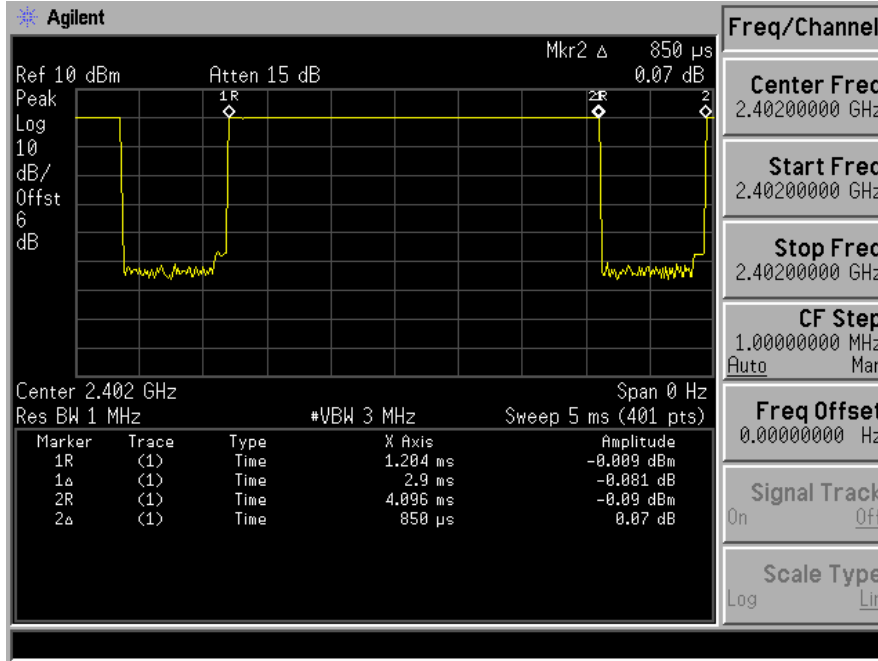

8.5 MAXIMUM PEAK CONDUCTED OUTPUT POWER

8.5.1 Applicable Standard

According to FCC Part 15.247(b)(1) and DA 00-705

8.5.2 Conformance Limit

The max For frequency hopping systems operating in the 2400-2483.5 MHz band employing at least 75 non-overlapping hopping channels: 1 watt. For all other frequency hopping systems in the 2400-2483.5 MHz band: 0.125 watts.

8.5.3 Test Configuration

Test according to clause 7.1 radio frequency test setup 1

8.5.4 Test Procedure

■ According to FCC Part15.247(b)(1)

As an alternative to a peak power measurement, compliance with the limit can be based on a measurement of the maximum conducted output power.

Use the following spectrum analyzer settings:

Set Span = approximately 5 times the 20 dB bandwidth, centered on a hopping channel (about 10MHz)

Set RBW > the 20 dB bandwidth of the emission being measured

Set VBW ≥ RBW

Set Sweep = auto

Set Detector function = peak

Set Trace = max hold

Allow the trace to stabilize. Use the marker-to-peak function to set the marker to the peak of the emission to determine the peak amplitude level.

Test Results

Temperature :	28°C	Test Date :	November 20, 2014
Humidity :	65 %	Test By:	KK
Antenna gain	2dBi		

Operation Mode	Channel Number	Channel Frequency (MHz)	Measurement Level (dBm)	Limit (dBm)	Verdict
GFSK	1	2402	0.046	30	PASS
	40	2441	0.351	30	PASS
	79	2480	-0.830	30	PASS
π/4-DQPSK	1	2402	-1.149	21	PASS
	40	2441	-1.772	21	PASS
	79	2480	-1.319	21	PASS
8DPSK	1	2402	-1.145	21	PASS
	40	2441	-1.762	21	PASS
	79	2480	-1.320	21	PASS

Test Model	Maximum Peak Conducted Output Power Bluetooth v2.1 Channel 1: 2402MHz	GFSK
------------	---	------

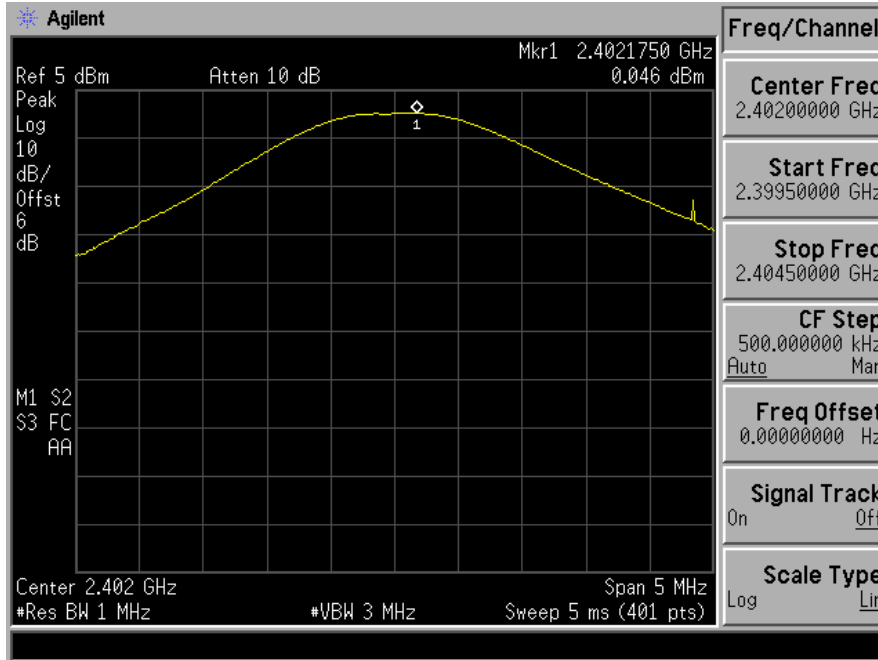

Test Model	Maximum Peak Conducted Output Power Bluetooth v2.1 Channel 40: 2441MHz	GFSK
------------	--	------

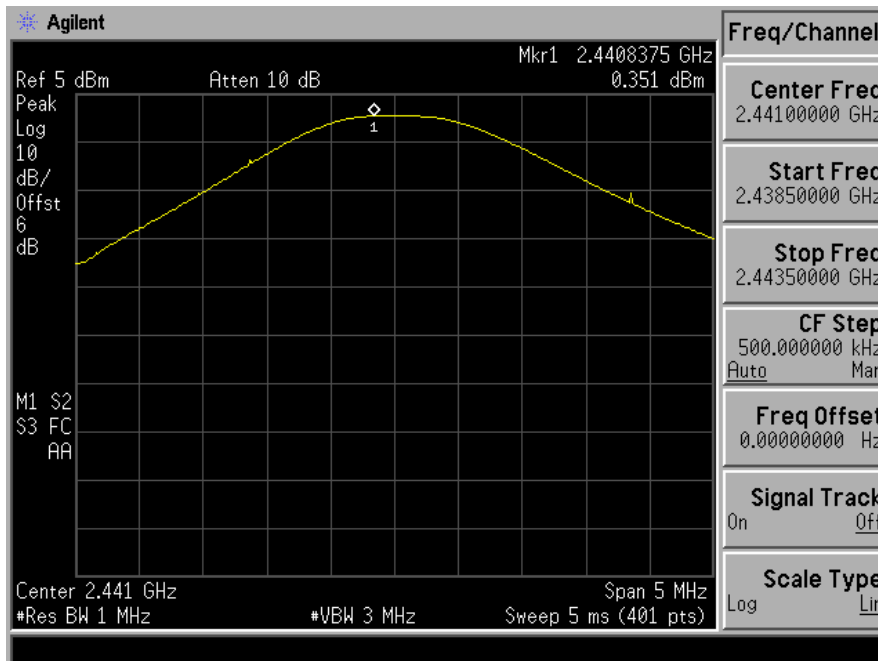

Test Model	Maximum Peak Conducted Output Power Bluetooth v2.1 Channel 79: 2480MHz	GFSK
------------	--	------

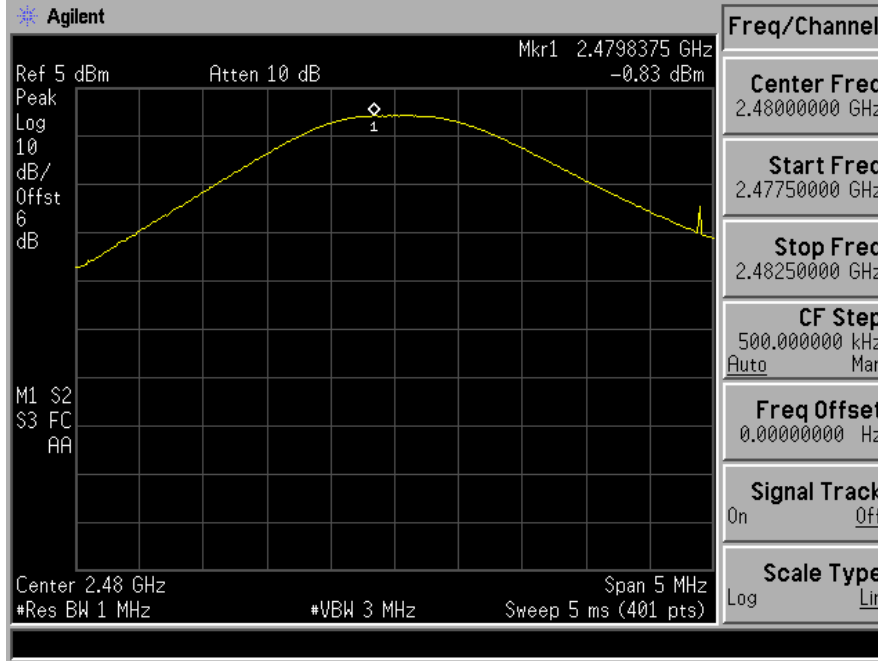

Test Model	Maximum Peak Conducted Output Power Bluetooth v2.1 Channel 1: 2402MHz	$\pi/4$ -DQPSK
------------	---	----------------

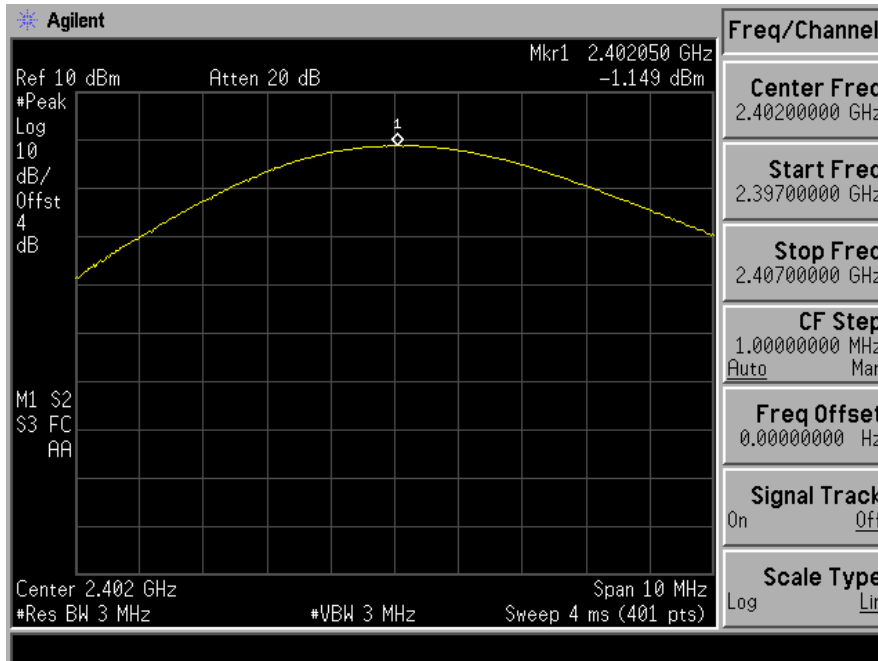

Test Model	Maximum Peak Conducted Output Power Bluetooth v2.1 Channel 40: 2441MHz	$\pi/4$ -DQPSK
------------	--	----------------

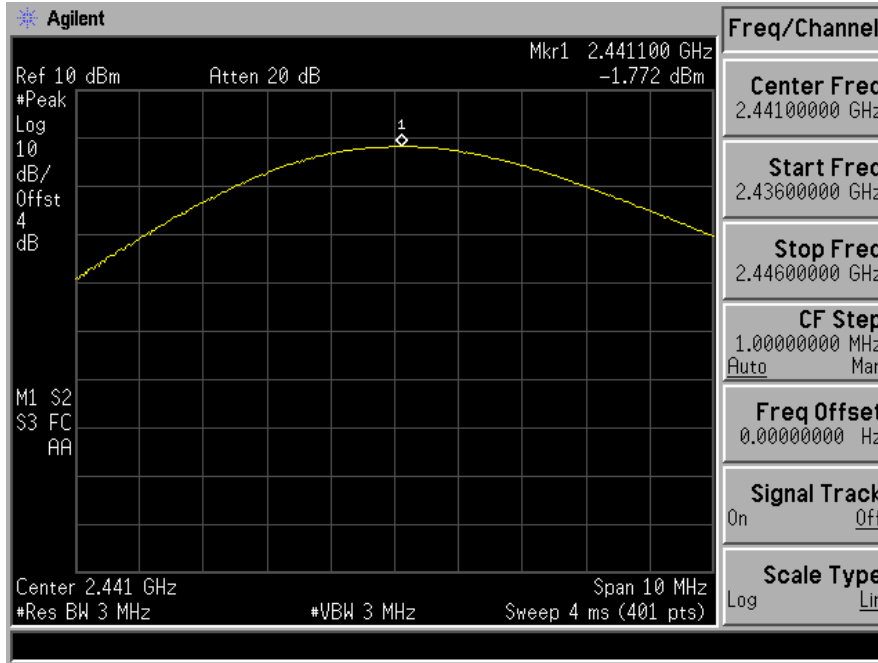

Test Model	Maximum Peak Conducted Output Power Bluetooth v2.1 Channel 79: 2480MHz	$\pi/4$ -DQPSK
------------	--	----------------

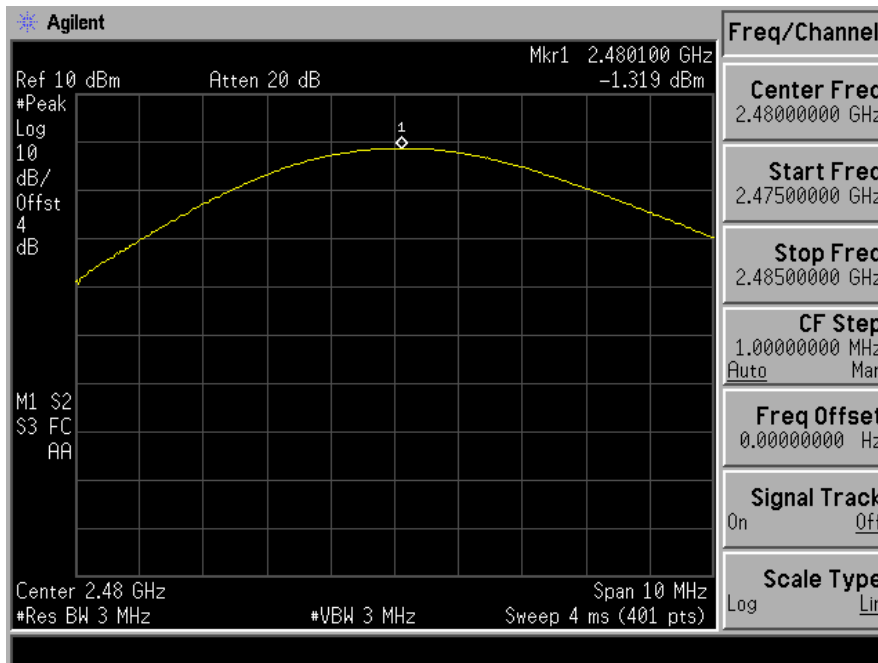

Test Model	Maximum Peak Conducted Output Power Bluetooth v2.1 Channel 1: 2402MHz	8DPSK
------------	---	-------

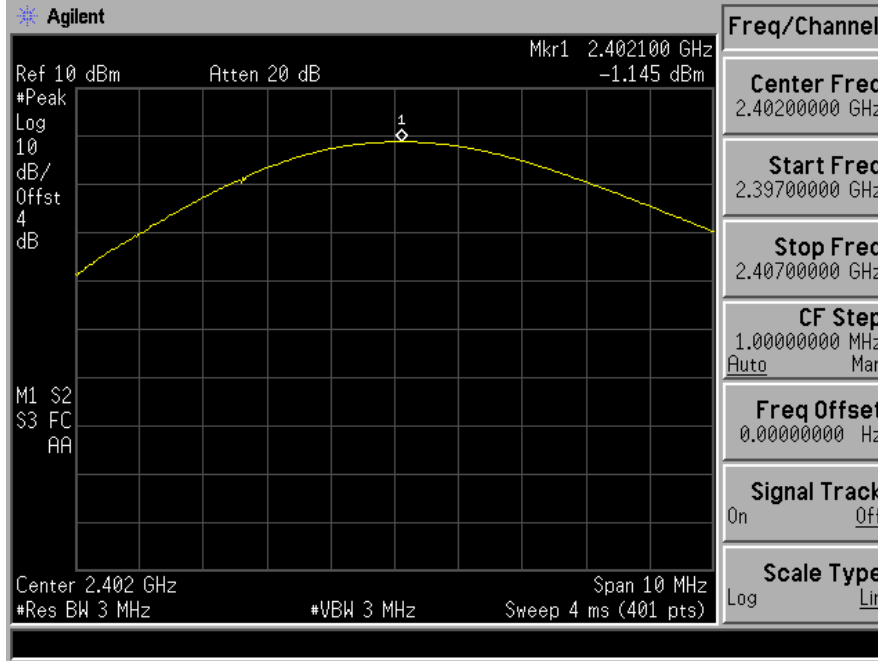

Test Model	Maximum Peak Conducted Output Power Bluetooth v2.1 Channel 40: 2441MHz	8DPSK
------------	--	-------

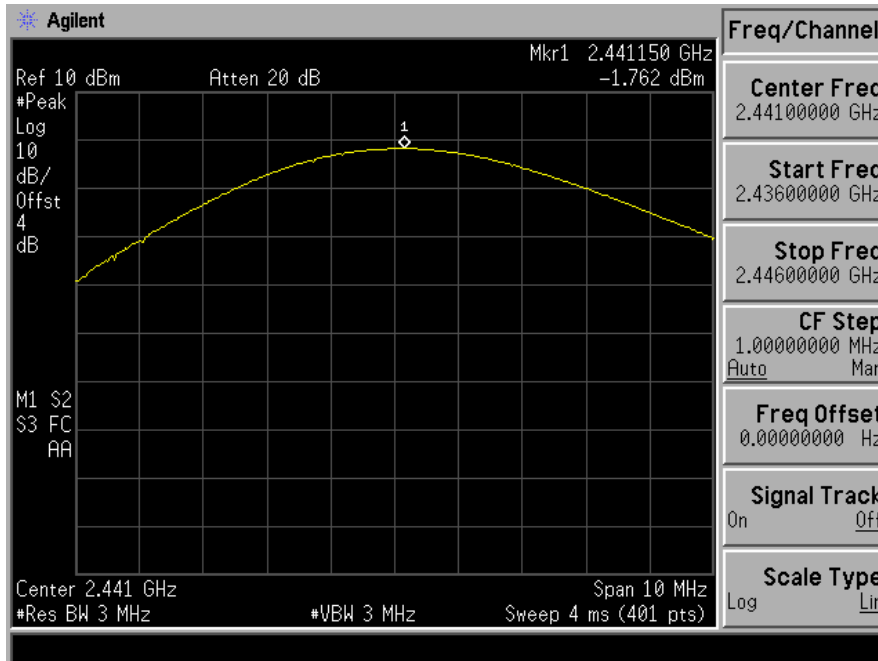

Test Model	Maximum Peak Conducted Output Power Bluetooth v2.1 Channel 79: 2480MHz	8DPSK
------------	--	-------

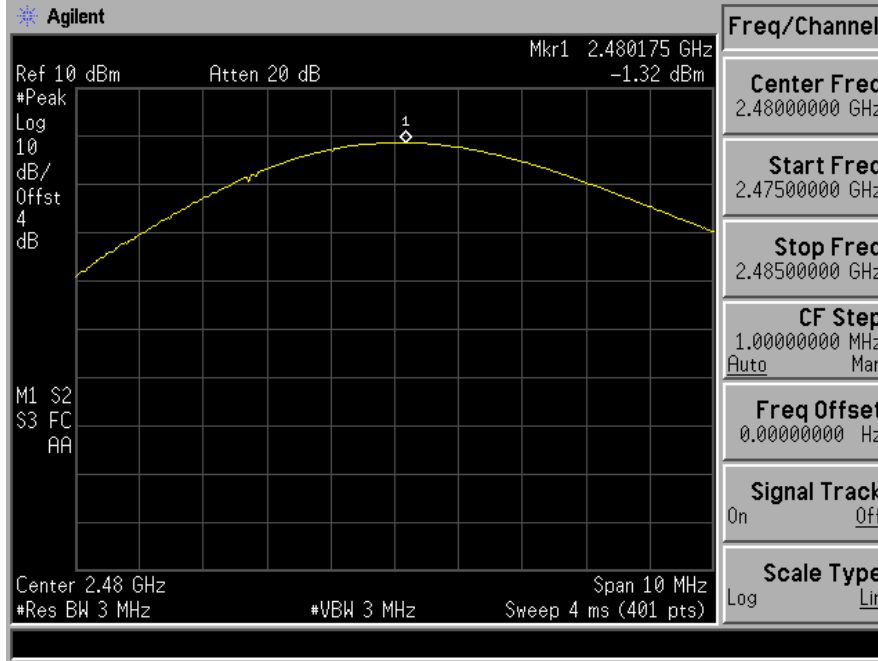

8.6 BAND EDGE TEST

8.6.1 Measurement Procedure

1. The EUT was Operating in hopping mode or could be controlled its channel. Printed out test result from the spectrum by hard copy function.
2. The EUT was placed on a turn table which is 0.8m above ground plane.
3. Maximum procedure was performed on the six highest emissions to ensure EUT compliance.
4. And also, each emission was to be maximized by changing the polarization of receiving antenna both horizontal and vertical.
5. Repeat above procedures until all frequency measured were complete.

EMI Test Receiver	Setting
Attenuation	Auto
RB	1MHz
VB	3MHz
Detector	Peak
Trace	Max hold

EMI Test Receiver	Setting
Attenuation	Auto
RB	1MHz
VB	10Hz
Detector	Peak
Trace	Max hold

8.7 TEST SET-UP (BLOCK DIAGRAM OF CONFIGURATION)

As 5.2 Test set up (B) and (C)

8.8 MEASUREMENT EQUIPMENT USED:

Same as 5.3 Radiated Emission Measurement.

8.9 MEASUREMENT RESULTS:

All the modes GFSK, 1/4π-DQPSK, 8DPSK and hopping mode have been tested and the worst result recorded as below.

Spectrum Detector: PK/AV Test Date : October 29, 2014
 Test By: SYP Temperature : 24 °C
 Test channel: 1 Humidity : 53 %
 Modulation: GFSK

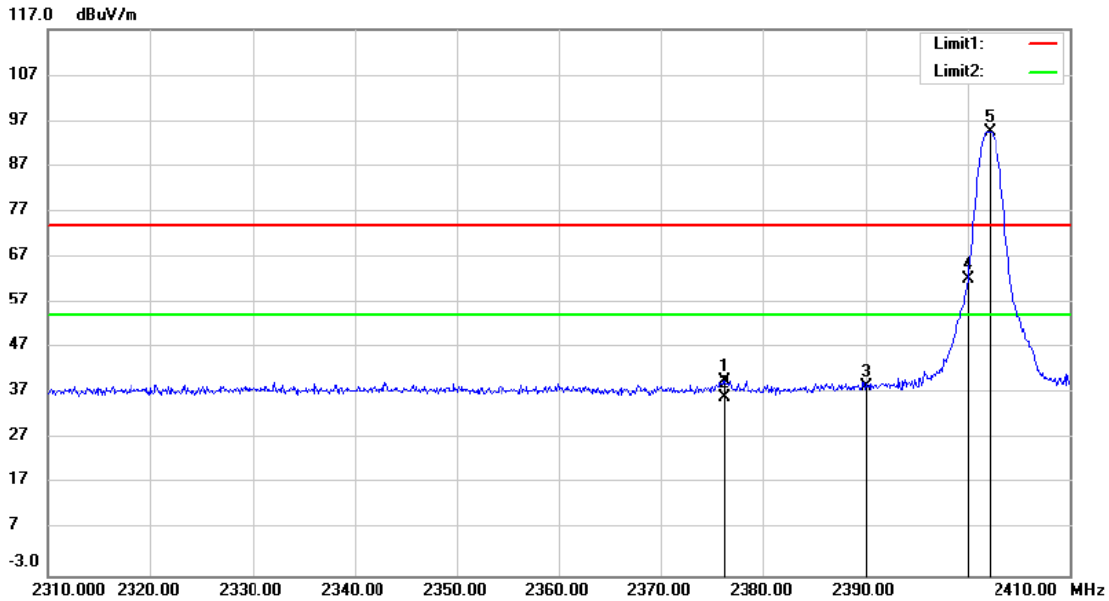

Site 3m Chamber #3 Polarization: **Horizontal** Temperature: 24 C
 Limit: (RE)FCC PART 15 C Power:AC 120V/60Hz Humidity: 53 %
 Mode:2402
 Note:

No.	Mk.	Freq. MHz	Reading Level dBuV	Correct Factor dB	Measure- ment dBuV/m	Limit dBuV/m	Over dB	Antenna Height cm	Table Degree degree	Comment
1		2376.200	63.02	-23.18	39.84	74.00	-34.16	peak		
2		2376.200	59.48	-23.18	36.30	54.00	-17.70	AVG		
3		2390.000	61.78	-23.11	38.67	74.00	-35.33	peak		
4		2400.000	85.39	-23.06	62.33	74.00	-11.67	peak		
5	*	2402.200	117.65	-23.04	94.61	74.00	20.61	peak		

*:Maximum data x:Over limit !:over margin

Operator: KK

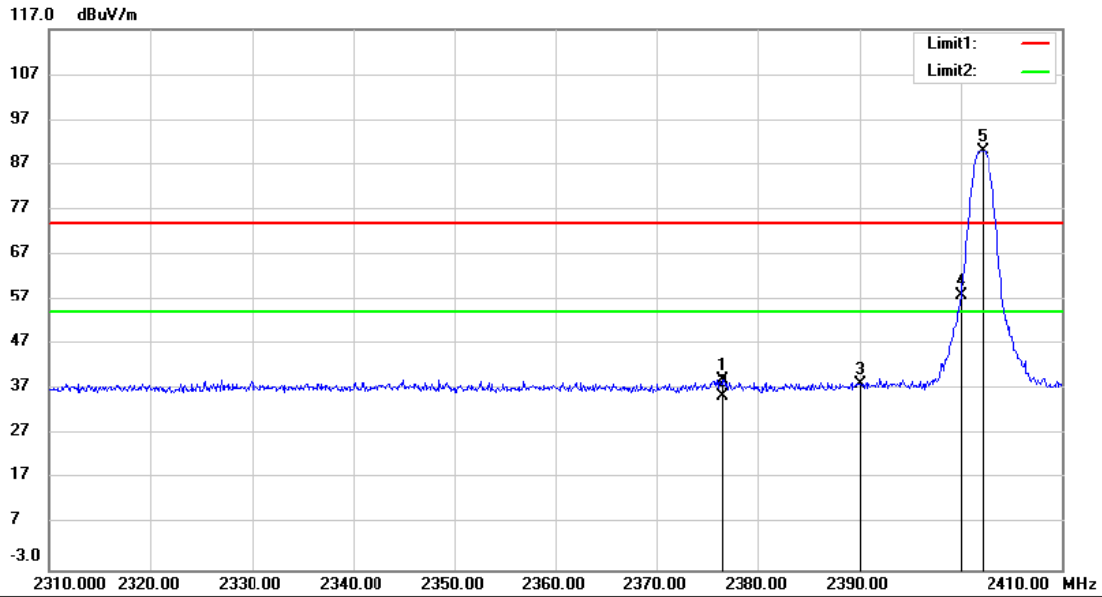

Site 3m Chamber #3 Polarization: **Vertical** Temperature: 24 C
 Limit: (RE)FCC PART 15 C Power:AC 120V/60Hz Humidity: 53 %
 Mode:2402
 Note:

No.	Mk.	Freq.	Reading Level	Correct Factor	Measurement	Limit	Over	Antenna Height	Table Degree	
		MHz	dBuV	dB	dBuV/m	dBuV/m	dB	cm	degree	Comment
1		2376.500	62.45	-23.18	39.27	74.00	-34.73			peak
2		2376.500	58.68	-23.18	35.50	54.00	-18.50			AVG
3		2390.000	61.35	-23.11	38.24	74.00	-35.76			peak
4		2400.000	81.08	-23.06	58.02	74.00	-15.98			peak
5	*	2402.200	113.16	-23.04	90.12	74.00	16.12			peak

*:Maximum data x:Over limit !:over margin

Operator: KK

Spectrum Detector: PK/AV Test Date : October 29, 2014
 Test By: SYP Temperature : 24 °C
 Test channel: 79 Humidity : 53 %
 Modulation: GFSK

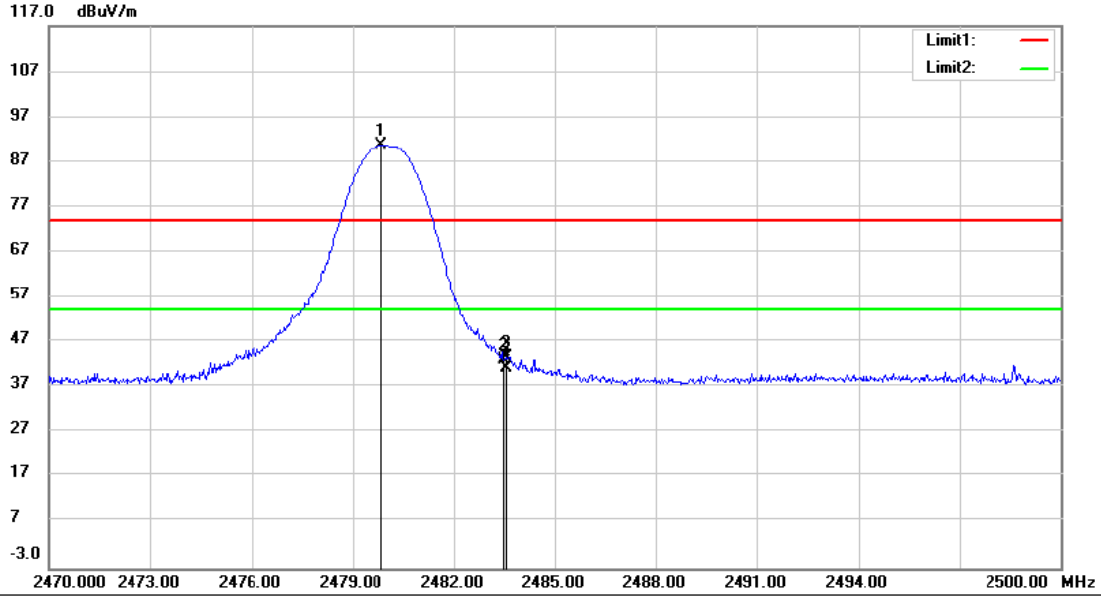

Site 3m Chamber #3 Polarization: **Horizontal** Temperature: 24 C
 Limit: (RE)FCC PART 15 C Power:AC 120V/60Hz Humidity: 53 %
 Mode:2480
 Note:

No.	Mk.	Freq. MHz	Reading Level dBuV	Correct Factor dB	Measure- ment dBuV/m	Limit dBuV/m	Over dB	Antenna Height cm	Table Degree degree	Comment
1	*	2479.870	113.28	-22.63	90.65	74.00	16.65	peak		
2		2483.500	65.68	-22.62	43.06	74.00	-30.94	peak		
3		2483.560	66.25	-22.62	43.63	74.00	-30.37	peak		
4		2483.560	63.82	-22.62	41.20	54.00	-12.80	AVG		

*:Maximum data x:Over limit !:over margin

Operator: KK

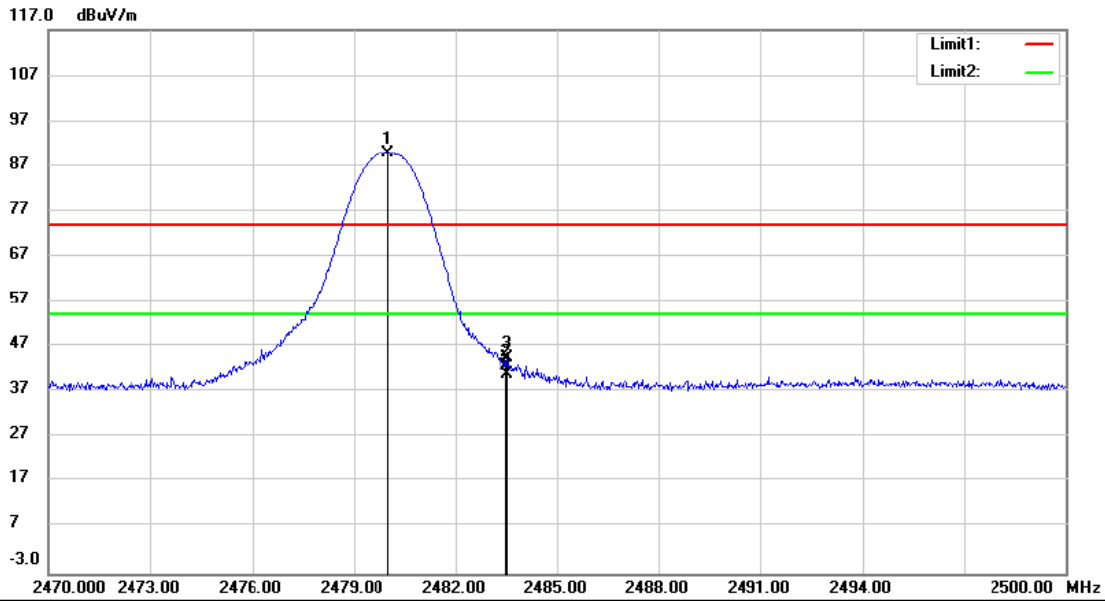

Site 3m Chamber #3 Polarization: **Vertical** Temperature: 24 C
 Limit: (RE)FCC PART 15 C Power:AC 120V/60Hz Humidity: 53 %
 Mode:2480
 Note:

No.	Mk.	Freq. MHz	Reading Level dBuV	Correct Factor dB	Measure- ment dBuV/m	Limit dBuV/m	Over dB	Detector	Antenna Height cm	Table Degree degree	Comment
1	*	2480.020	112.39	-22.63	89.76	74.00	15.76	peak			
2		2483.500	65.48	-22.62	42.86	74.00	-31.14	peak			
3		2483.530	67.08	-22.62	44.46	74.00	-29.54	peak			
4		2483.530	63.62	-22.62	41.00	54.00	-13.00	AVG			

*:Maximum data x:Over limit !:over margin

Operator: KK

Spectrum Detector: PK/AV Test Date : November 26, 2014
 Test By: SYP Temperature : 24 °C
 Test mode: Hopping Humidity : 53 %

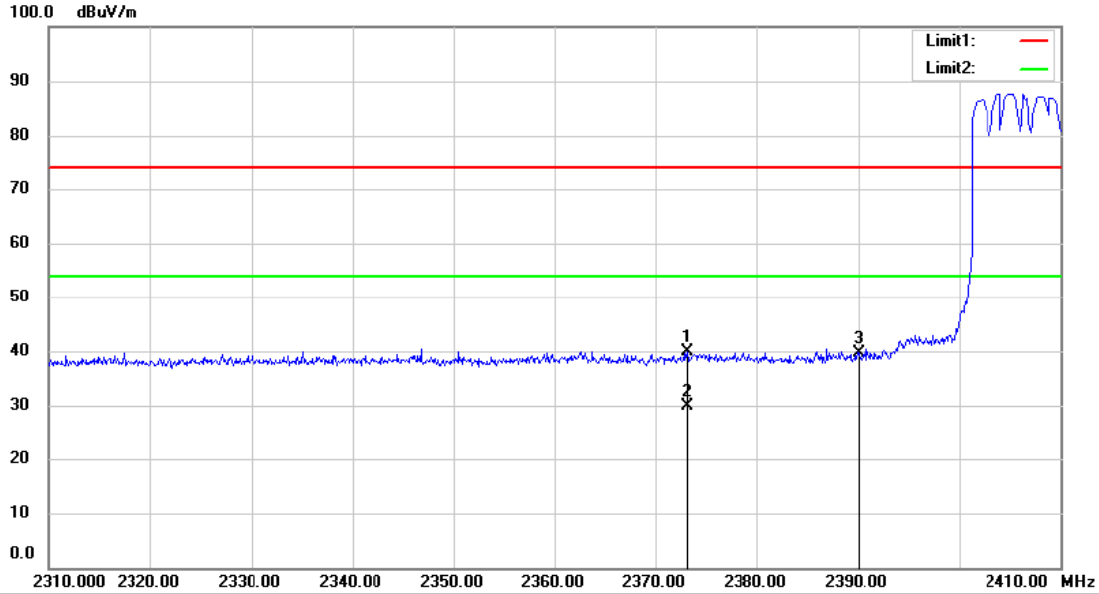

Site 3m Chamber #3 Polarization: **Horizontal** Temperature: 24 C
 Limit: (RE)FCC PART 15 C Power: AC 120V/60Hz Humidity: 53 %

Mode:HOPPING

Note:

No.	Mk.	Freq. MHz	Reading Level dBuV	Correct Factor dB	Measure- ment dBuV/m	Limit dBuV/m	Over dB	Antenna Height cm	Table Degree degree	Comment
1		2373.100	63.11	-23.19	39.92	74.00	-34.08	peak		
2	*	2373.100	52.99	-23.19	29.80	54.00	-24.20	AVG		
3		2390.000	62.82	-23.11	39.71	74.00	-34.29	peak		

*:Maximum data x:Over limit l:over margin

Operator: SYP

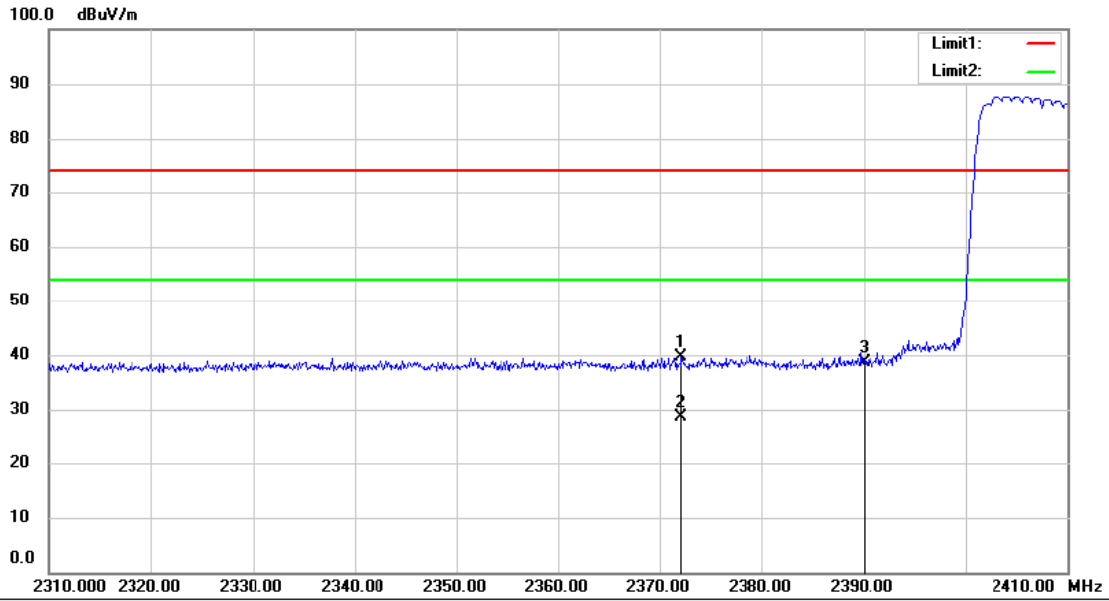

Site 3m Chamber #3 Polarization: **Vertical** Temperature: 24 C
 Limit: (RE)FCC PART 15 C Power: AC 120V/60Hz Humidity: 53 %
 Mode:HOPPING
 Note:

No.	Mk.	Freq. MHz	Reading Level dBuV	Correct Factor dB	Measure- ment dBuV/m	Limit dBuV/m	Over dB	Antenna Height cm	Table Degree degree	Comment
1		2372.100	62.74	-23.20	39.54	74.00	-34.46	peak		
2	*	2372.100	51.87	-23.20	28.67	54.00	-25.33	AVG		
3		2390.000	61.83	-23.11	38.72	74.00	-35.28	peak		

*:Maximum data x:Over limit !:over margin

Operator: SYP

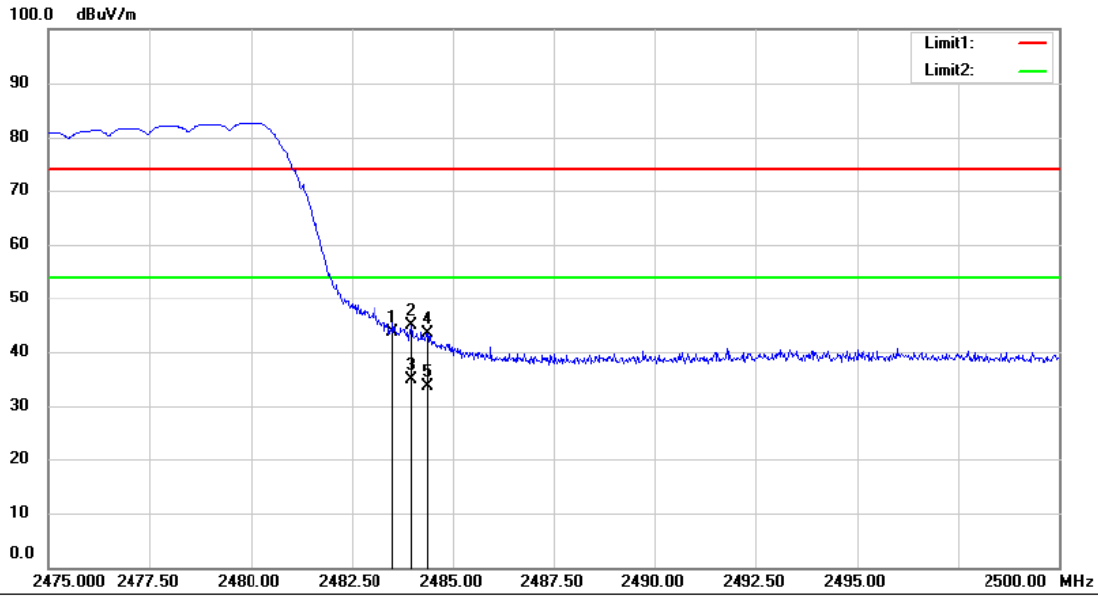

Site 3m Chamber #3 Polarization: **Horizontal** Temperature: 24 C
 Limit: (RE)FCC PART 15 C Power: AC 120V/60Hz Humidity: 53 %
 Mode:HOPPING
 Note:

No.	Mk.	Freq.	Reading Level	Correct Factor	Measure-ment	Limit	Over	Antenna Height	Table Degree	
		MHz	dBuV	dB	dBuV/m	dBuV/m	dB	cm	degree	Comment
1		2483.500	66.34	-22.62	43.72	74.00	-30.28			peak
2		2483.975	67.42	-22.61	44.81	74.00	-29.19			peak
3	*	2483.975	57.42	-22.61	34.81	54.00	-19.19			AVG
4		2484.375	66.11	-22.61	43.50	74.00	-30.50			peak
5		2484.375	56.20	-22.61	33.59	54.00	-20.41			AVG

*:Maximum data x:Over limit l:over margin

Operator: SYP

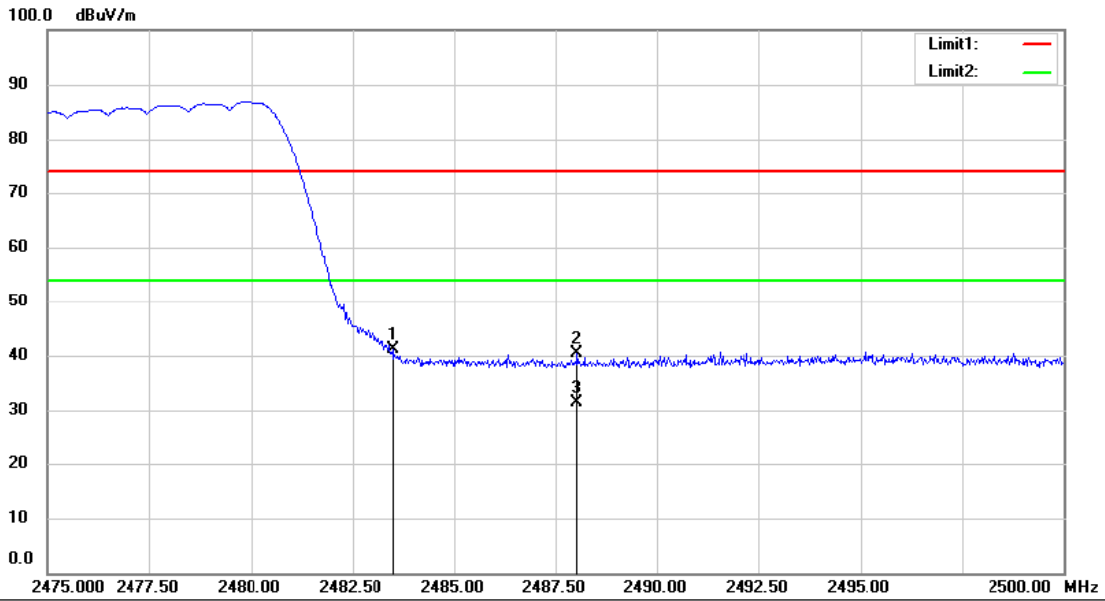

Site 3m Chamber #3 Polarization: **Vertical** Temperature: 24 C
 Limit: (RE)FCC PART 15 C Power: AC 120V/60Hz Humidity: 53 %
 Mode:HOPPING
 Note:

No.	Mk.	Freq.	Reading Level	Correct Factor	Measurement	Limit	Over	Antenna Height	Table Degree	
		MHz	dBuV	dB	dBuV/m	dBuV/m	dB	Detector	cm	degree
1		2483.500	63.66	-22.62	41.04	74.00	-32.96	peak		
2		2488.025	63.08	-22.59	40.49	74.00	-33.51	peak		
3	*	2488.025	54.08	-22.59	31.49	54.00	-22.51	AVG		

*:Maximum data x:Over limit !:over margin

Operator: SYP

8.10 CONDUCTED SUPRIIOUS EMISSION

8.10.1 Applicable Standard

According to FCC Part 15.247(d) and DA 00-705

8.10.2 Conformance Limit

According to FCC Part 15.247(d):

In any 100 kHz bandwidth outside the frequency band in which the spread spectrum intentional radiator is operating, the radio frequency power that is produced by the intentional radiator shall be at least 20 dB below that in the 100 kHz bandwidth within the band that contains the highest level of the desired power, based on either an RF conducted, provided the transmitter demonstrates compliance with the peak conducted power limits.

8.10.3 Test Configuration

Test according to clause 7.1 radio frequency test setup 1

8.10.4 Test Procedure

The transmitter output (antenna port) was connected to the spectrum analyzer

■ Reference level measurement

Establish a reference level by using the following procedure:

Set instrument center frequency to DSS channel center frequency.

Set Span = approximately 5 times the 20 dB bandwidth, centered on a hopping channel (about 6MHz).

Set the RBW = 100 kHz. Set the VBW $\geq 3 \times$ RBW.

Set Detector = peak. Set Sweep time = auto couple.

Set Trace mode = max hold. Allow trace to fully stabilize.

Use the peak marker function to determine the maximum Maximum conduceted level.

Note that the channel found to contain the maximum conduceted level can be used to establish the reference level.

■ Band-edge Compliance of RF Conducted Emissions

Use the following spectrum analyzer settings:

Span = wide enough to capture the peak level of the emission operating on the channel closest to the band-edge, as well as any modulation products which fall outside of the authorized band of operation

Set RBW $\geq 1\%$ of the span=100kHz Set VBW \geq RBW

Set Sweep = auto Set Detector function = peak Set Trace = max hold

Allow the trace to stabilize. Set the marker on the emission at the bandedge, or on the highest modulation product outside of the band, if this level is greater than that at the bandedge. Enable the marker-delta function, then use the marker-to-peak function to move the marker to the peak of the in-band emission.

The marker-delta value now displayed must comply with the limit specified in this Section.

Now, using the same instrument settings, enable the hopping function of the EUT. Allow the trace to stabilize. Follow the same procedure listed above to determine if any spurious emissions caused by the hopping function also comply with the specified limit.

■ Conduceted Spurious RF Conducted Emission

Use the following spectrum analyzer settings:

Span = wide enough to capture the peak level of the in-band emission and all spurious emissions (e.g., harmonics) from the lowest frequency generated in the EUT up through the 10th harmonic.(30MHz to 25GHz). Set RBW = 100 kHz Set VBW \geq RBW

Set Sweep = auto Set Detector function = peak Set Trace = max hold

Set Sweep = auto Set Detector function = peak Set Trace = max hold

Allow the trace to stabilize. Set the marker on the peak of any spurious emission recorded. The level displayed must comply with the limit specified in this Section.

8.10.5 Test Results

Test Model	Maximum Conducted Level RBW=100kHz Bluetooth v2.1 Channel 1: 2402MHz	GFSK
------------	--	------

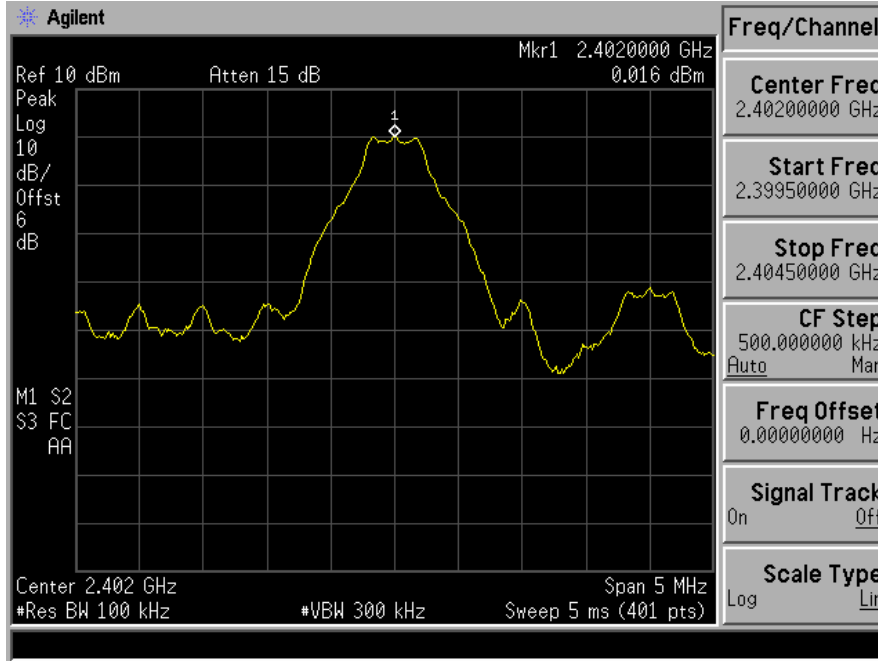

Test Model	Conducted Spurious RF Conducted Emission Bluetooth v2.1 Channel 1: 2402MHz	GFSK
------------	--	------

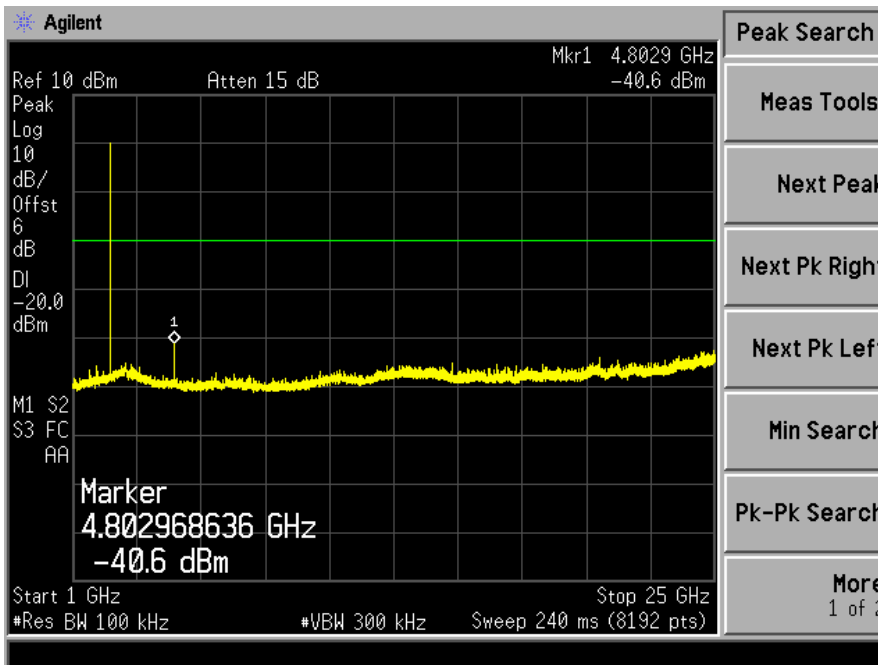

Test Model	Maximum Conducted Level RBW=100kHz Bluetooth v2.1 Channel 40: 2441MHz	GFSK
------------	---	------

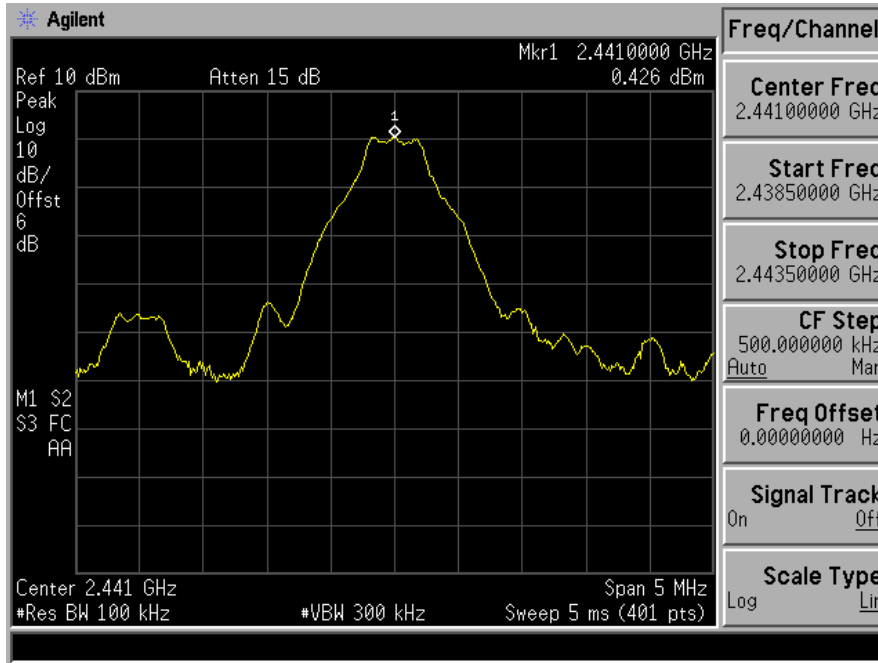

Test Model	Conducted Spurious RF Conducted Emission Bluetooth v2.1 Channel 40: 2441MHz	GFSK
------------	---	------

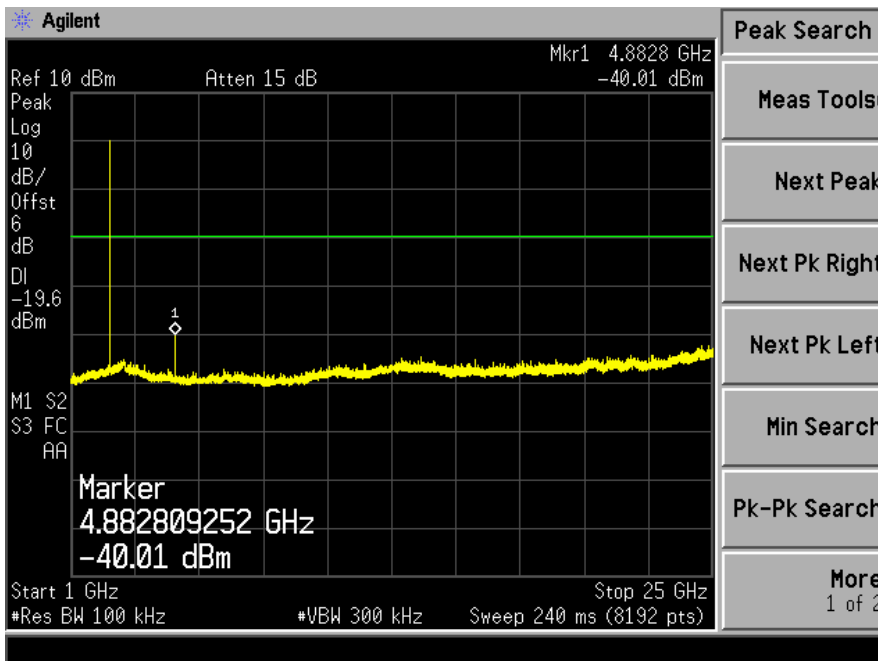

Test Model	Maximum Conducted Level RBW=100kHz Bluetooth v2.1 Channel 79: 2480MHz	GFSK
------------	---	------

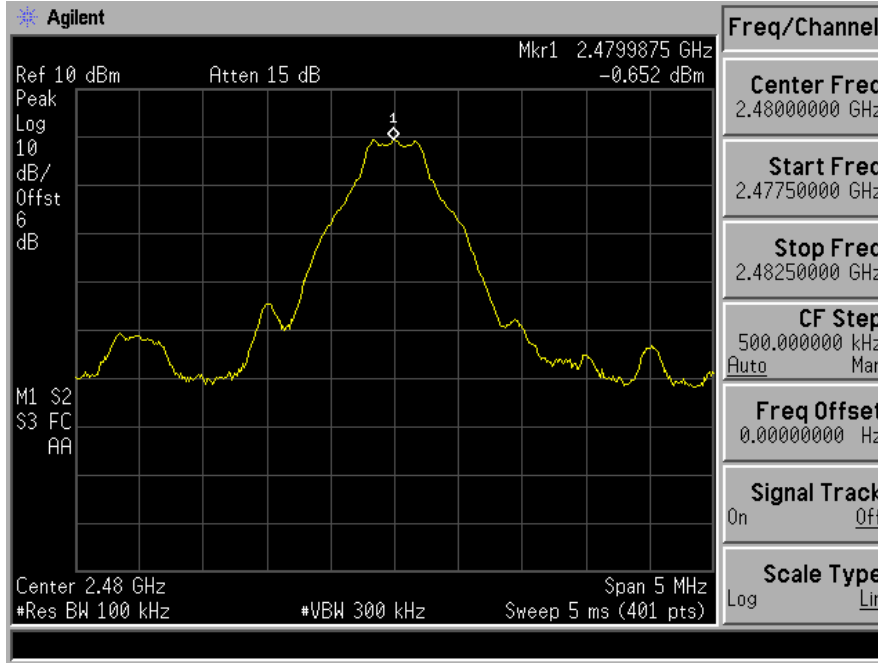

Test Model	Conducted Spurious RF Conducted Emission Bluetooth v2.1 Channel 79: 2480MHz	GFSK
------------	---	------

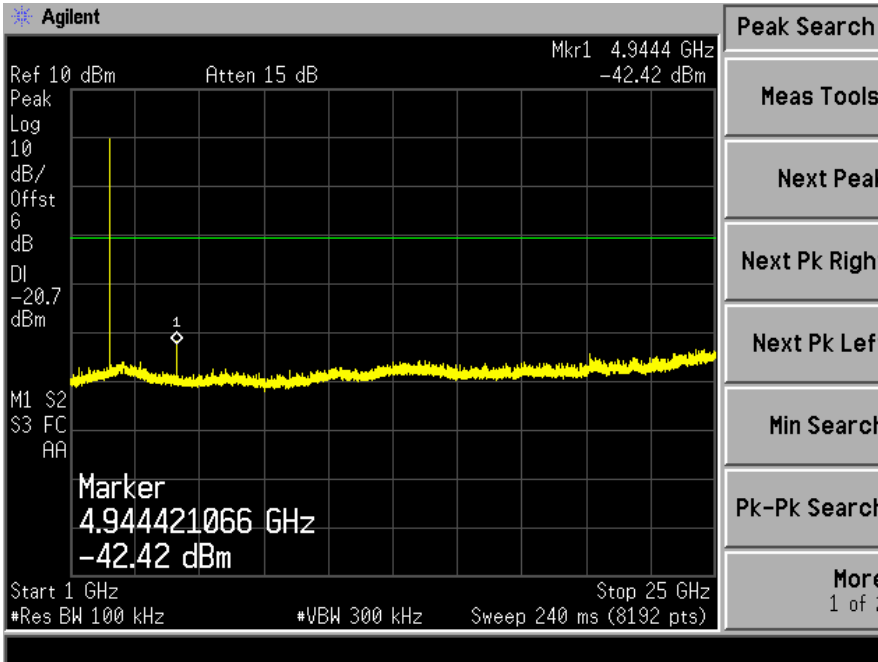

8.11 RADIATED SPURIOUS EMISSION

8.11.1 Applicable Standard

According to FCC Part 15.247(d) and 15.209 and DA 00-705

8.11.2 Conformance Limit

According to FCC Part 15.247(d): radiated emissions which fall in the restricted bands, as defined in §15.205(a), must also comply with the radiated emission limits specified in §15.209(a) (see §15.205(c)).
 According to FCC Part15.205, Restricted bands

MHz	MHz	MHz	GHz
0.090-0.110	16.42-16.423	399.9-410	4.5-5.15
10.495-0.505	16.69475-16.69525	608-614	5.35-5.46
2.1735-2.1905	16.80425-16.80475	960-1240	7.25-7.75
4.125-4.128	25.5-25.67	1300-1427	8.025-8.5
4.17725-4.17775	37.5-38.25	1435-1626.5	9.0-9.2
4.20725-4.20775	73-74.6	1645.5-1646.5	9.3-9.5
6.215-6.218	74.8-75.2	1660-1710	10.6-12.7
6.26775-6.26825	123-138	2200-2300	14.47-14.5
8.291-8.294	149.9-150.05	2310-2390	15.35-16.2
8.362-8.366	156.52475-156.52525	2483.5-2500	17.7-21.4
8.37625-8.38675	156.7-156.9	2690-2900	22.01-23.12
8.41425-8.41475	162.0125-167.17	3260-3267	23.6-24.0
12.29-12.293	167.72-173.2	3332-3339	31.2-31.8
12.51975-12.52025	240-285	3345.8-3358	36.43-36.5
12.57675-12.57725	322-335.4	3600-4400	(2)
13.36-13.41			

According to FCC Part15.205, the level of any transmitter spurious emission in Restricted bands shall not exceed the level of the emission specified in the following table

Restricted Frequency(MHz)	Field Strength (μV/m)	Field Strength (dBμV/m)	Measurement Distance
30-88	100	40	3
88-216	150	43.5	3
216-960	200	46	3
Above 960	500	54	3

8.11.3 Test Configuration

Test according to clause 7.2 radio frequency test setup 2

8.11.4 Test Procedure

This test is required for any spurious emission that falls in a Restricted Band, as defined in Section 15.205. It must be performed with the highest gain of each type of antenna proposed for use with the EUT. Use the following spectrum analyzer settings:

The EUT was placed on a turn table which is 0.8m above ground plane.

Maximum procedure was performed on the highest emissions to ensure EUT compliance.

Span = wide enough to fully capture the emission being measured

RBW = 1 MHz for $f \geq 1$ GHz(1GHz to 25GHz), 100 kHz for $f < 1$ GHz(30MHz to 1GHz)

VBW \geq RBW

Sweep = auto

Detector function = peak

Trace = max hold

Follow the guidelines in ANSI C63.4-1992 with respect to maximizing the emission by rotating the EUT, measuring the emission while the EUT is situated in three orthogonal planes (if appropriate), adjusting the measurement antenna height and polarization, etc. A pre-amp and a high pass filter are required for this

test, in order to provide the measuring system with sufficient sensitivity. Allow the trace to stabilize. The peak reading of the emission, after being corrected by the antenna factor, cable loss, pre-amp gain, etc., is the peak field strength, which must comply with the limit specified in Section 15.35(b). Submit this data. Now set the VBW to 10 Hz, while maintaining all of the other instrument settings. This peak level, once corrected, must comply with the limit specified in Section 15.209. If the dwell time per channel of the hopping signal is less than 100 ms, then the reading obtained with the 10 Hz VBW may be further adjusted by a “duty cycle correction factor”, derived from $20\log(\text{dwell time}/100 \text{ ms})$, in an effort to demonstrate compliance with the 15.209 limit. Submit this data.
 Repeat above procedures until all frequency measured was complete.

8.11.5 Test Results

All the modulation modes were tested the data of the worst mode (GFSK) are recorded in the following pages and all modulation methods do not exceed the above mentioned limits.

Operation Mode:	Bluetooth Mode	Test Date :	October 29, 2014
Frequency Range:	9KHz~30MHz	Temperature :	24 °C
Test Result:	PASS	Humidity :	53 %
Measured Distance:	3m	Test By:	KK

Freq. (MHz)	Ant.Pol. H/V	Emission Level (dBuV/m)	Limit 3m (dBuV/m)	Over (dB)
--	--	--	--	--

Note: the amplitude of spurious emission that is attenuated by more than 20dB below the permissible limit has no need to be reported.

Operation Mode: 2402MHz
 Frequency Range: 30~1000MHz
 Test Result: PASS
 Measured Distance: 3m
 Test mode: GFSK

Test Date : October 29, 2014
 Temperature : 24°C
 Humidity : 53 %
 Test By: KK

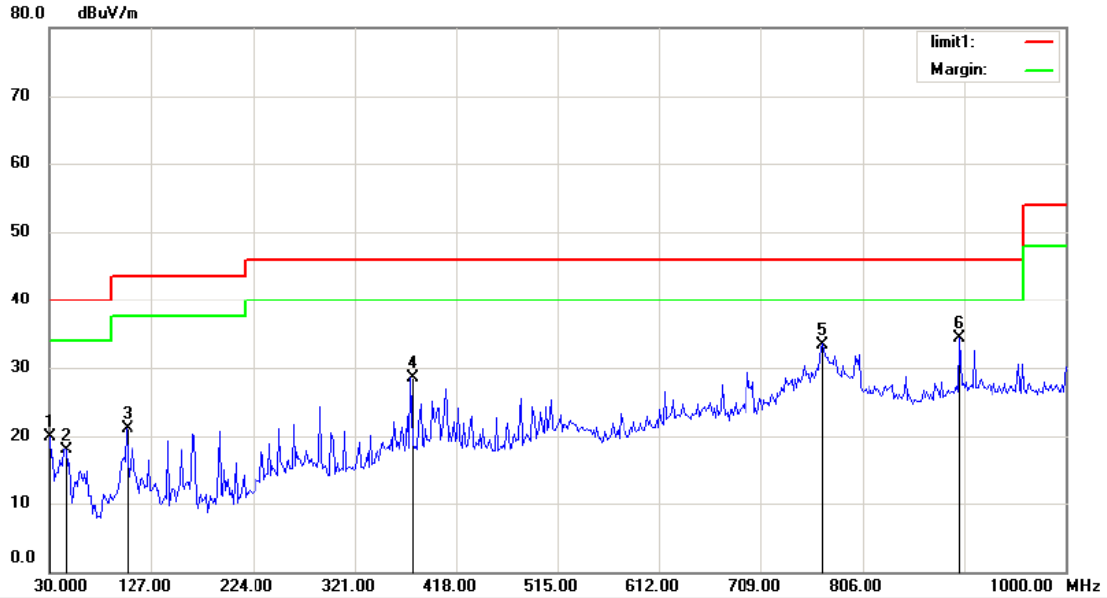

Site 3m Chamber #1 Polarization: **Horizontal** Temperature: 24
 Limit: (RE)FCC PART 15 C Power: Humidity: 53 %
 Mode:TX(2402)
 Note:

No.	Mk.	Freq. MHz	Reading Level dBuV	Correct Factor dB	Measure- ment dBuV/m	Limit dBuV/m	Over dB	Antenna Height cm	Table Degree degree	Comment
1		30.0000	7.86	11.98	19.84	40.00	-20.16			QP
2		43.9904	2.83	15.17	18.00	40.00	-22.00			QP
3		103.0610	8.25	12.87	21.12	43.50	-22.38			QP
4		375.0962	11.14	17.35	28.49	46.00	-17.51			QP
5		768.3814	8.58	24.82	33.40	46.00	-12.60			QP
6	*	898.9583	8.12	26.10	34.22	46.00	-11.78			QP

*:Maximum data x:Over limit !:over margin

Operator: KK

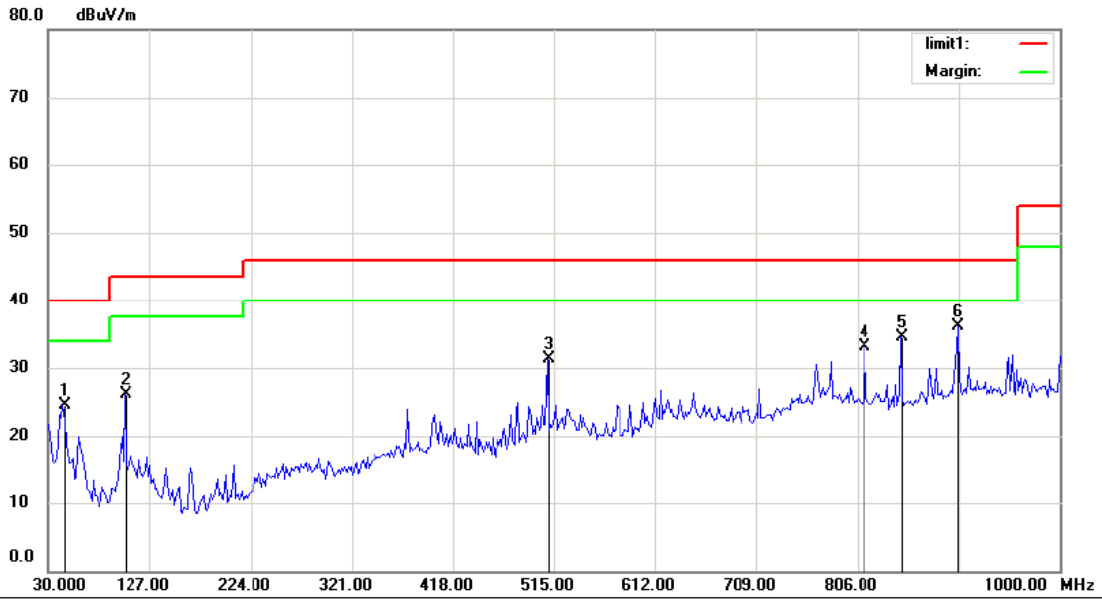

Site 3m Chamber #1 Polarization: **Vertical** Temperature: 24
 Limit: (RE)FCC PART 15 C Power: Humidity: 53 %
 Mode:TX(2402)
 Note:

No.	Mk.	Freq. MHz	Reading Level dBuV	Correct Factor dB	Measure- ment dBuV/m	Limit dBuV/m	Over dB	Antenna Height cm	Table Degree degree	Comment
1		43.9904	6.29	18.17	24.46	40.00	-15.54	QP		
2		103.0610	13.18	12.87	26.05	43.50	-17.45	QP		
3		508.7821	10.39	20.99	31.38	46.00	-14.62	QP		
4		813.4615	8.41	24.68	33.09	46.00	-12.91	QP		
5		847.6603	10.00	24.48	34.48	46.00	-11.52	QP		
6	*	902.0673	9.78	26.29	36.07	46.00	-9.93	QP		

*:Maximum data x:Over limit !:over margin

Operator: KK

Operation Mode: 2441MHz
 Frequency Range: 30~1000MHz
 Test Result: PASS
 Measured Distance: 3m
 Test mode: GFSK

Test Date : October 29, 2014
 Temperature : 24℃
 Humidity : 53 %
 Test By: KK

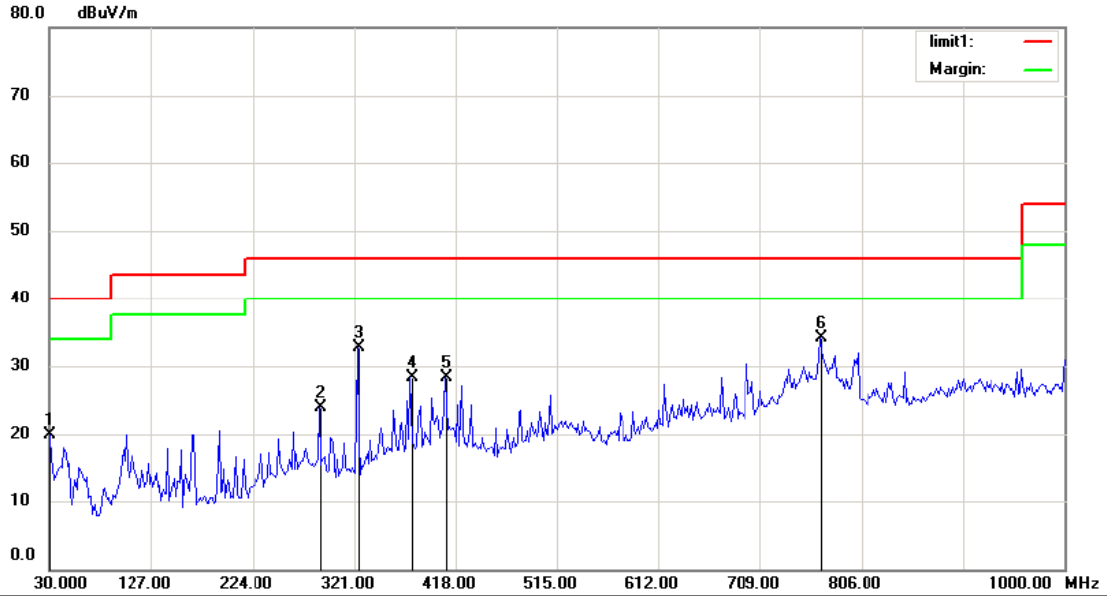

Site 3m Chamber #1 Polarization: **Horizontal** Temperature: 24
 Limit: (RE)FCC PART 15 C Power: Humidity: 53 %
 Mode: TX(2440)
 Note:

No.	Mk.	Freq.	Reading Level	Correct Factor	Measurement	Limit	Over	Antenna Height	Table Degree	
		MHz	dBuV	dB	dBuV/m	dBuV/m	dB	cm	degree	Comment
1		30.0000	7.89	11.98	19.87	40.00	-20.13	QP		
2		288.0450	8.95	14.92	23.87	46.00	-22.13	QP		
3		323.7981	18.07	14.60	32.67	46.00	-13.33	QP		
4		375.0962	10.90	17.35	28.25	46.00	-17.75	QP		
5		407.7404	9.47	18.86	28.33	46.00	-17.67	QP		
6	*	766.8270	9.39	24.75	34.14	46.00	-11.86	QP		

*:Maximum data x:Over limit l:over margin

Operator: KK

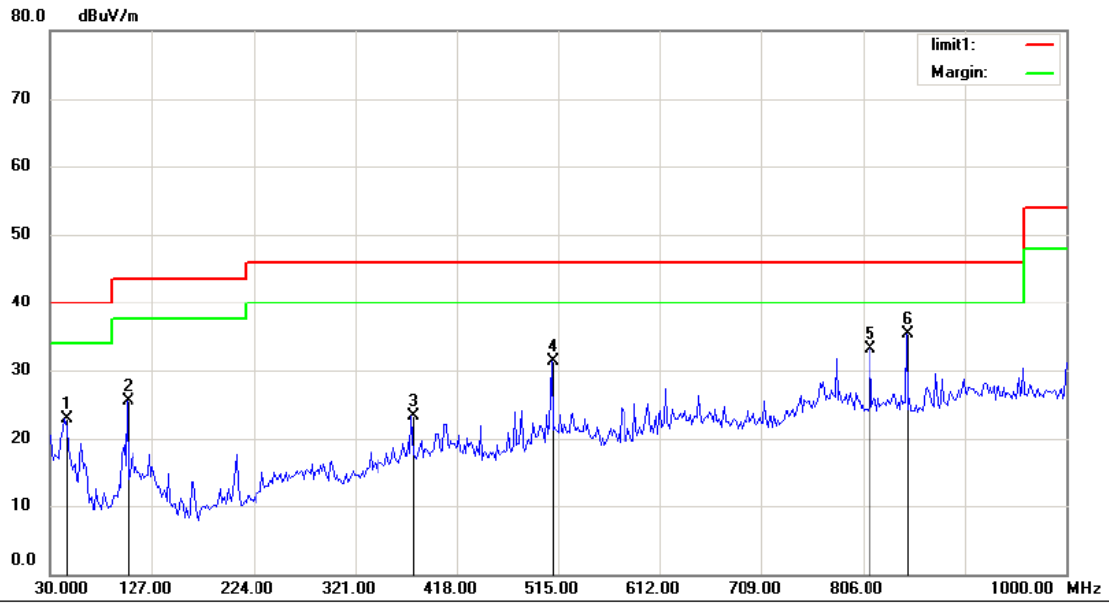

Site 3m Chamber #1 Polarization: **Vertical** Temperature: 24
 Limit: (RE)FCC PART 15 C Power: Humidity: 53 %
 Mode:TX(2440)
 Note:

No.	Mk.	Freq.	Reading Level	Correct Factor	Measurement	Limit	Over	Antenna Height	Table Degree	
		MHz	dBuV	dB	dBuV/m	dBuV/m	dB	cm	degree	Comment
1		43.9904	4.69	18.17	22.86	40.00	-17.14	QP		
2		103.0610	12.68	12.87	25.55	43.50	-17.95	QP		
3		375.0962	6.02	17.35	23.37	46.00	-22.63	QP		
4		508.7821	10.32	20.99	31.31	46.00	-14.69	QP		
5		813.4615	8.40	24.68	33.08	46.00	-12.92	QP		
6	*	847.6603	10.80	24.48	35.28	46.00	-10.72	QP		

*:Maximum data x:Over limit !:over margin

Operator: KK

Operation Mode: 2480MHz
 Frequency Range: 30~1000MHz
 Test Result: PASS
 Measured Distance: 3m
 Test mode: GFSK

Test Date : October 29, 2014
 Temperature : 24℃
 Humidity : 53 %
 Test By: KK

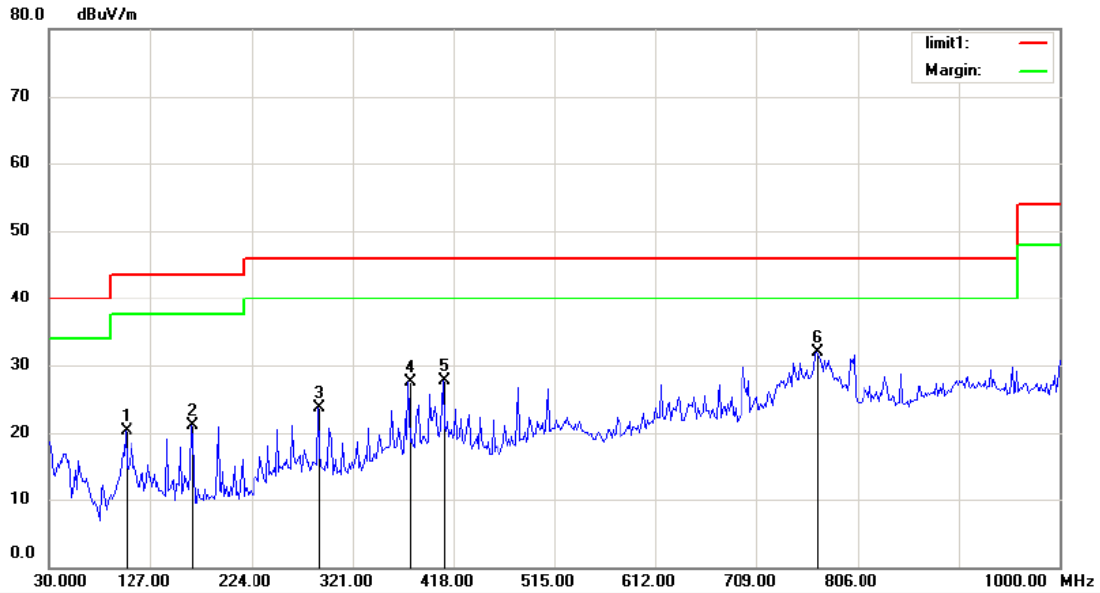

Site 3m Chamber #1 Polarization: **Horizontal** Temperature: 24
 Limit: (RE)FCC PART 15 C Power: Humidity: 53 %
 Mode:TX(2480)
 Note:

No.	Mk.	Freq. MHz	Reading Level dBuV	Correct Factor dB	Measure- ment dBuV/m	Limit dBuV/m	Over dB	Antenna Height cm	Table Degree degree	Comment
1		103.0610	7.52	12.87	20.39	43.50	-23.11	QP		
2		166.7950	13.17	7.95	21.12	43.50	-22.38	QP		
3		288.0450	8.73	14.92	23.65	46.00	-22.35	QP		
4		375.0962	10.20	17.35	27.55	46.00	-18.45	QP		
5		407.7404	8.80	18.86	27.66	46.00	-18.34	QP		
6	*	766.8270	7.17	24.75	31.92	46.00	-14.08	QP		

*:Maximum data x:Over limit !:over margin

Operator: KK

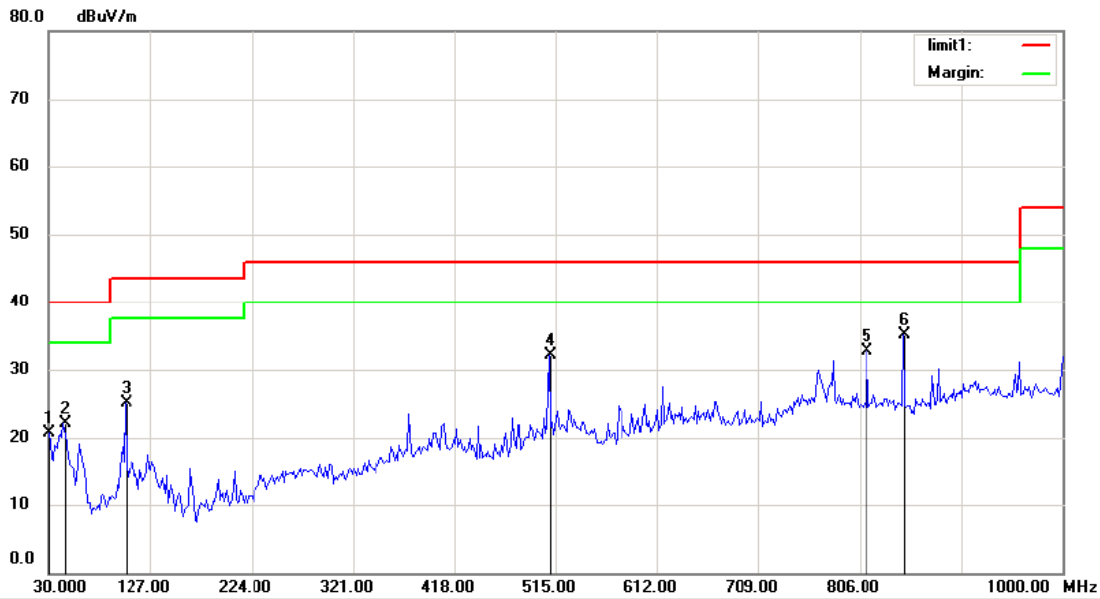

Site 3m Chamber #1 Polarization: **Vertical** Temperature: 24
 Limit: (RE)FCC PART 15 C Power: Humidity: 53 %
 Mode: TX(2480)
 Note:

No.	Mk.	Freq.	Reading Level	Correct Factor	Measurement	Limit	Over	Antenna Height	Table Degree	
		MHz	dBuV	dB	dBuV/m	dBuV/m	dB	cm	degree	Comment
1		30.0000	8.71	11.98	20.69	40.00	-19.31	QP		
2		43.9904	4.01	18.17	22.18	40.00	-17.82	QP		
3		103.0610	12.32	12.87	25.19	43.50	-18.31	QP		
4		508.7821	11.09	20.99	32.08	46.00	-13.92	QP		
5		813.4615	7.94	24.68	32.62	46.00	-13.38	QP		
6	*	847.6603	10.63	24.48	35.11	46.00	-10.89	QP		

*:Maximum data x:Over limit l:over margin

Operator: KK

Operation Mode: CH1: 2402MHz Test Date : October 29, 2014
Frequency Range: 1-25GHz Temperature : 24℃
Test Result: PASS Humidity : 53 %
Measured Distance: 3m Test By: KK
Test mode: GFSK

Freq. (MHz)	Ant.Pol. H/V	Emission Level(dBuV/m)		Limit 3m(dBuV/m)		Margin(dB)	
		PK	AV	PK	AV	PK	AV
4178.86	V	51.05	38.06	74.00	54.00	-22.95	-15.94
4671.86	V	52.40	39.16	74.00	54.00	-21.60	-14.84
7459.86	V	53.79	38.86	74.00	54.00	-20.21	-15.14
9329.86	V	56.52	39.26	74.00	54.00	-17.48	-14.74
14276.86	V	57.32	39.76	74.00	54.00	-16.68	-14.24
16197.86	V	56.93	40.86	74.00	54.00	-17.07	-13.14
4671.86	H	51.41	37.76	74.00	54.00	-22.59	-16.24
8224.86	H	54.14	39.26	74.00	54.00	-19.86	-14.74
9261.86	H	54.91	39.46	74.00	54.00	-19.09	-14.54
13545.86	H	56.09	38.76	74.00	54.00	-17.91	-15.24
14208.86	H	56.87	39.86	74.00	54.00	-17.13	-14.14
17523.86	H	58.56	40.96	74.00	54.00	-15.44	-13.04

No others harmonics emissions are higher than 20dB below the limits of 47 CFR Part 15.247.

- Note:** (1) All Readings are Peak Value and AV.
(2) Emission Level= Reading Level+Probe Factor +Cable Loss.
(3) Data of measurement within this frequency range shown “ -- ” in the table above means the reading of emissions are attenuated more than 20dB below the permissible limits or the field strength is too small to be measured.

Operation Mode: CH40: 2441MHz Test Date : October 29, 2014
Frequency Range: 1-25GHz Temperature : 24℃
Test Result: PASS Humidity : 53 %
Measured Distance: 3m Test By: KK
Test mode: GFSK

Freq. (MHz)	Ant.Pol. H/V	Emission Level(dBuV/m)		Limit 3m(dBuV/m)		Margin(dB)	
		PK	AV	PK	AV	PK	AV
3461.52	V	50.13	36.59	74.00	54.00	-23.87	-17.41
5423.06	V	50.30	36.76	74.00	54.00	-23.70	-17.24
8501.58	V	51.69	38.15	74.00	54.00	-22.31	-15.85
10027.22	V	51.13	37.59	74.00	54.00	-22.87	-16.41
11770.81	V	51.17	37.63	74.00	54.00	-22.83	-16.37
16892.60	V	50.79	37.25	74.00	54.00	-23.21	-16.75
5504.79	H	51.54	38.00	74.00	54.00	-22.46	-16.00
7357.35	H	52.21	38.67	74.00	54.00	-21.79	-15.33
8419.85	H	51.99	38.45	74.00	54.00	-22.01	-15.55
9972.73	H	51.63	38.09	74.00	54.00	-22.37	-15.91
13950.30	H	52.25	38.71	74.00	54.00	-21.75	-15.29
15612.16	H	51.71	38.17	74.00	54.00	-22.29	-15.83

No others harmonics emissions are higher than 20dB below the limits of 47 CFR Part 15.247.

- Note:** (1) All Readings are Peak Value and AV.
(2) Emission Level= Reading Level+Probe Factor +Cable Loss.
(3) Data of measurement within this frequency range shown “ -- ” in the table above means the reading of emissions are attenuated more than 20dB below the permissible limits or the field strength is too small to be measured.

Operation Mode:	CH79: 2480MHz	Test Date :	October 29, 2014
Frequency Range:	1-25GHz	Temperature :	24℃
Test Result:	PASS	Humidity :	53 %
Measured Distance:	3m	Test By:	KK
Test mode:	GFSK		

Freq. (MHz)	Ant.Pol. H/V	Emission Level(dBuV/m)		Limit 3m(dBuV/m)		Margin(dB)	
		PK	AV	PK	AV	PK	AV
1541.22	V	54.08	38.76	74.00	54.00	-19.92	-15.24
1895.39	V	53.40	38.08	74.00	54.00	-20.60	-15.92
6908.21	V	54.72	39.40	74.00	54.00	-19.28	-14.60
9905.00	V	54.14	38.82	74.00	54.00	-19.86	-15.18
12493.14	V	54.91	39.59	74.00	54.00	-19.09	-14.41
13882.56	V	55.33	40.01	74.00	54.00	-18.67	-13.99
1677.44	H	55.28	39.96	74.00	54.00	-18.72	-14.04
3584.49	H	55.61	40.29	74.00	54.00	-18.39	-13.71
6771.99	H	55.60	40.28	74.00	54.00	-18.40	-13.72
7970.70	H	56.90	41.58	74.00	54.00	-17.10	-12.42
9932.24	H	55.92	40.60	74.00	54.00	-18.08	-13.40
13610.13	H	56.32	41.00	74.00	54.00	-17.68	-13.00

No others harmonics emissions are higher than 20dB below the limits of 47 CFR Part 15.247.

- Note:**
- (1) All Readings are Peak Value and AV.
 - (2) Emission Level= Reading Level+Probe Factor +Cable Loss.
 - (3) Data of measurement within this frequency range shown “ -- ” in the table above means the reading of emissions are attenuated more than 20dB below the permissible limits or the field strength is too small to be measured.

8.12 CONDUCTED EMISSION TEST

8.12.1 Applicable Standard

According to FCC Part 15.207(a)

8.12.2 Conformance Limit

Frequency(MHz)	Conducted Emission Limit	
	Quasi-peak	Average
0.15-0.5	66-56	56-46
0.5-5.0	56	46
5.0-30.0	60	50

Note: 1. The lower limit shall apply at the transition frequencies
2. The limit decreases in line with the logarithm of the frequency in the range of 0.15 to 0.50MHz.

8.12.3 Test Configuration

Test according to clause 7.3 conducted emission test setup

8.12.4 Test Procedure

The EUT was placed on a table which is 0.8m above ground plane.
Maximum procedure was performed on the highest emissions to ensure EUT compliance.
Repeat above procedures until all frequency measured were complete.

8.12.5 Test Results

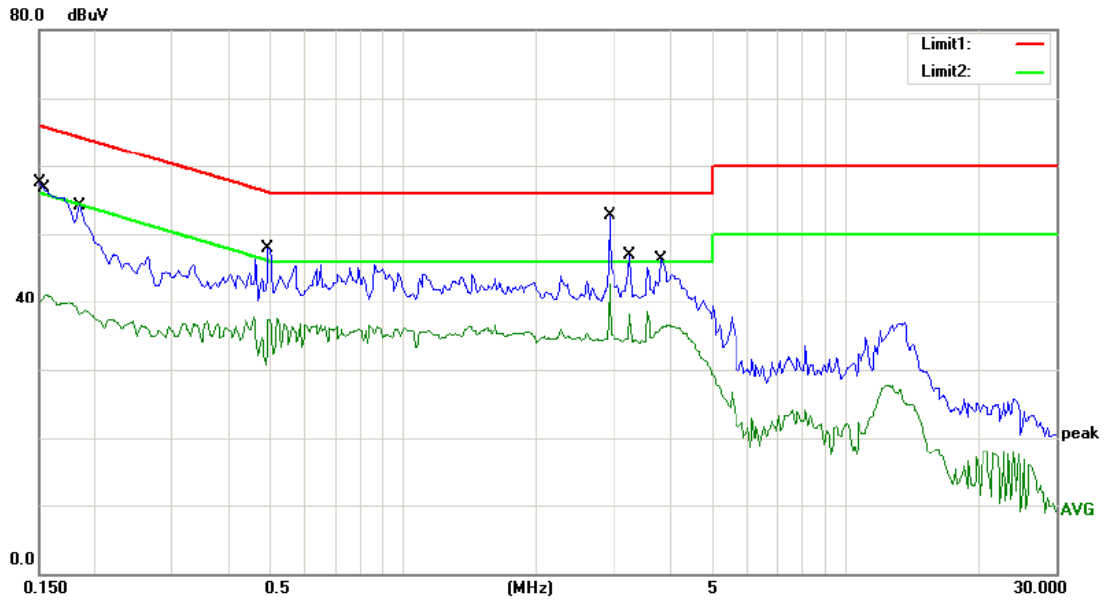

Site Conduction #2

Phase: **L1**

Temperature: 26

Limit: (CE)FCC PART 15 C

Power: AC 120V/60Hz

Humidity: 55 %

Mode:Bluetooth ON

Note:

No.	Mk.	Freq. MHz	Reading Level dBuV	Correct Factor dB	Measure- ment dBuV	Limit dBuV	Over dB	Detector	Comment
1		0.1500	57.45	0.00	57.45	66.00	-8.55	QP	
2		0.1550	41.14	0.00	41.14	55.73	-14.59	AVG	
3		0.1850	54.20	0.00	54.20	64.26	-10.06	QP	
4		0.1850	38.66	0.00	38.66	54.26	-15.60	AVG	
5		0.4950	47.90	0.00	47.90	56.08	-8.18	QP	
6		0.4950	37.49	0.00	37.49	46.08	-8.59	AVG	
7		2.9200	52.63	0.00	52.63	56.00	-3.37	QP	
8	*	2.9200	42.64	0.00	42.64	46.00	-3.36	AVG	
9		3.2500	46.92	0.00	46.92	56.00	-9.08	QP	
10		3.2500	38.45	0.00	38.45	46.00	-7.55	AVG	
11		3.8300	46.24	0.00	46.24	56.00	-9.76	QP	
12		3.8300	36.55	0.00	36.55	46.00	-9.45	AVG	

*:Maximum data x:Over limit !:over margin Comment: Factor build in receiver. Operator: WAP

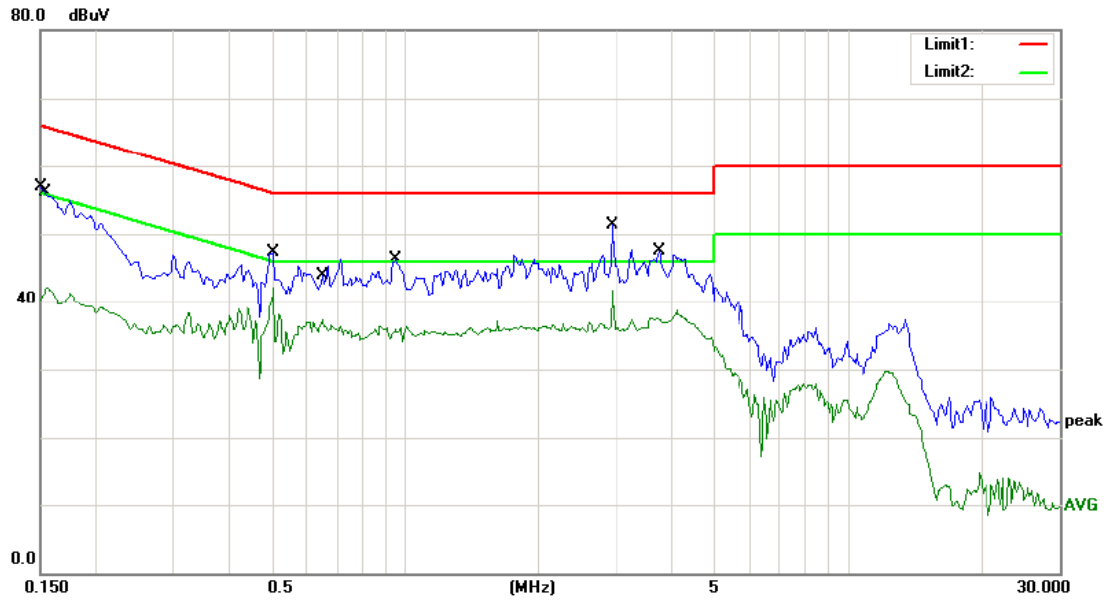

Site Conduction #2 Phase: **N** Temperature: 26
 Limit: (CE)FCC PART 15 C Power: AC 120V/60Hz Humidity: 55 %
 Mode:Bluetooth ON
 Note:

No.	Mk.	Freq.	Reading Level	Correct Factor	Measurement	Limit	Over	Detector	Comment
		MHz	dBuV	dB	dBuV	dBuV	dB		
1		0.1500	56.81	0.00	56.81	66.00	-9.19	QP	
2		0.1550	42.10	0.00	42.10	55.73	-13.63	AVG	
3		0.5050	47.26	0.00	47.26	56.00	-8.74	QP	
4	*	0.5050	42.10	0.00	42.10	46.00	-3.90	AVG	
5		0.6508	46.26	0.00	46.26	56.00	-9.74	QP	
6		0.6508	37.13	0.00	37.13	46.00	-8.87	AVG	
7		0.9550	46.37	0.00	46.37	56.00	-9.63	QP	
8		0.9550	36.30	0.00	36.30	46.00	-9.70	AVG	
9		2.9200	51.24	0.00	51.24	56.00	-4.76	QP	
10		2.9200	41.60	0.00	41.60	46.00	-4.40	AVG	
11		3.7500	47.51	0.00	47.51	56.00	-8.49	QP	
12		3.7500	38.61	0.00	38.61	46.00	-7.39	AVG	

*:Maximum data x:Over limit !:over margin Comment: Factor build in receiver. Operator: WAP

8.13 ANTENNA APPLICATION

8.13.1 Antenna Requirement

For intentional device, according to FCC 47 CFR Section 15.203, an intentional radiator shall be designed to ensure that no antenna other than that furnished by the responsible party shall be used with the device. And according to FCC 47 CFR Section 15.247 (b), if transmitting antennas of directional gain greater than 6dBi are used, the power shall be reduced by the amount in dB that the directional gain of the antenna exceeds 6dBi.

8.13.2 Result

The EUT'S antenna is integral antenna, and the antenna can't be replaced by the user, The antenna's gain is 2dBi and meets the requirement.