



TEST REPORT

FCC PART 15 SUBPART C 15.247 & RSS 247

Report Reference No.: **CTL1809283023-WF**

Compiled by:
(position+printed name+signature)

Happy Guo
(File administrators)

Happy Guo

Tested by:
(position+printed name+signature)

Nice Nong
(Test Engineer)

Nice Nong

Approved by:
(position+printed name+signature)

Ivan Xie
(Manager)

Ivan Xie

Product Name.....: High Power Bluetooth PA System with Lights

Model/Type reference: iPA69D

List Model(s).....: TOTAL PA GLOW 2, iPA91D, TOTAL PA ULTRA

Trade Mark.....: ION

FCC ID.....: **2AB3E-IPA69B**

IC.....: **10541A-IPA69B**

Applicant's name: **ION Audio LLC**

Address of applicant: 200 Scenic View Drive, Cumberland, RI 02864, U.S.A.

Test Firm.....: **Shenzhen CTL Testing Technology Co., Ltd.**

Address of Test Firm: Floor 1-A, Baisha Technology Park, No.3011, Shahexi Road, Nanshan District, Shenzhen, China 518055

Test specification.....:

Standard.....: **47 CFR FCC Part 15 Subpart C 15.247
RSS 247 Issue 2, February 2017**

TRF Originator: Shenzhen CTL Testing Technology Co., Ltd.

Master TRF: Dated 2011-01

Date of Receipt.....: Oct. 09, 2018

Date of Test Date.....: Oct. 09, 2018–Nov. 06, 2018

Data of Issue.....: Nov. 06, 2018

Result.....: Pass

Shenzhen CTL Testing Technology Co., Ltd. All rights reserved.

This publication may be reproduced in whole or in part for non-commercial purposes as long as the Shenzhen CTL Testing Technology Co., Ltd. is acknowledged as copyright owner and source of the material. Shenzhen CTL Testing Technology Co., Ltd. takes no responsibility for and will not assume liability for damages resulting from the reader's interpretation of the reproduced material due to its placement and context.

TEST REPORT

Test Report No. :	CTL1809283023-WF	Nov. 06, 2018
		Date of issue

Equipment under Test : High Power Bluetooth PA System with Lights

Model /Type : iPA69D

Listed Models : TOTAL PA GLOW 2, iPA91D, TOTAL PA ULTRA

Applicant : **ION Audio LLC**

Address : 200 Scenic View Drive, Cumberland, RI 02864, U.S.A.

Manufacturer : **ION Audio LLC**

Address : 200 Scenic View Drive, Cumberland, RI 02864, U.S.A.

Test result	Pass *
--------------------	---------------

* In the configuration tested, the EUT complied with the standards specified page 5.

The test report merely corresponds to the test sample.

It is not permitted to copy extracts of these test result without the written permission of the test laboratory.

Table of Contents

Page

- 1. SUMMARY..... 5**
 - 1.1. TEST STANDARDS.....5
 - 1.2. TEST DESCRIPTION.....5
 - 1.3. TEST FACILITY6
 - 1.4. STATEMENT OF THE MEASUREMENT UNCERTAINTY.....6

- 2. GENERAL INFORMATION..... 7**
 - 2.1. ENVIRONMENTAL CONDITIONS7
 - 2.2. GENERAL DESCRIPTION OF EUT7
 - 2.3. DESCRIPTION OF TEST MODES AND TEST FREQUENCY.....7
 - 2.4. EQUIPMENTS USED DURING THE TEST8
 - 2.5. RELATED SUBMITTAL(S) / GRANT (S).....9
 - 2.6. MODIFICATIONS.....9

- 3. TEST CONDITIONS AND RESULTS 10**
 - 3.1. CONDUCTED EMISSIONS TEST10
 - 3.2. RADIATED EMISSIONS AND BAND EDGE13

- 4. TEST SETUP PHOTOS OF THE EUT 20**

- 5. EXTERNAL AND INTERNAL PHOTOS OF THE EUT 21**

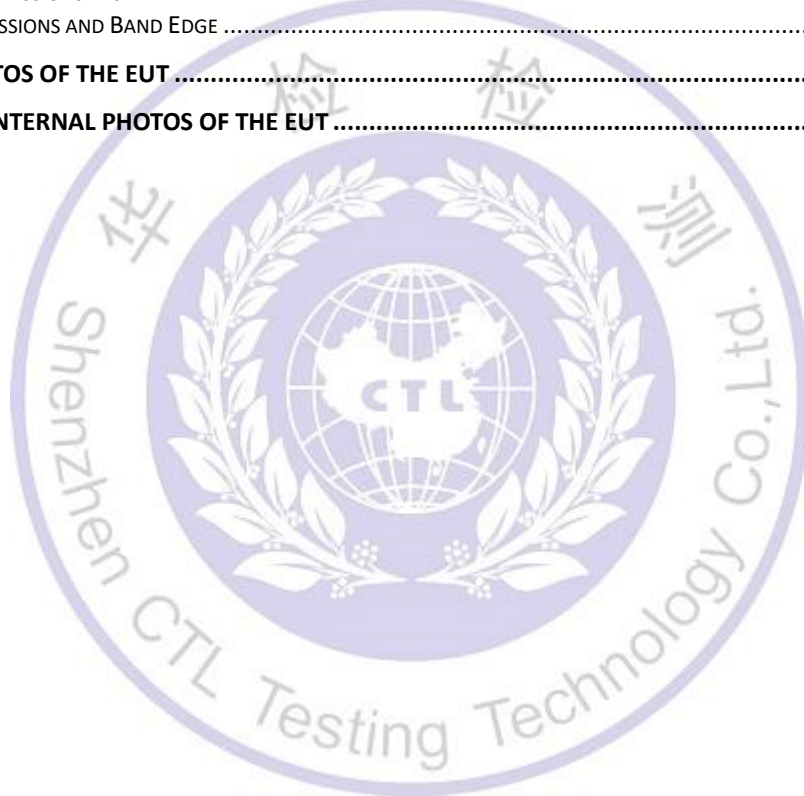

1. SUMMARY

1.1. TEST STANDARDS

The tests were performed according to following standards:

FCC Rules Part 15.247: Frequency Hopping, Direct Spread Spectrum and Hybrid Systems that are in operation within the bands of 902-928 MHz, 2400-2483.5 MHz, and 5725-5850 MHz

RSS-247-Issue 2: Digital Transmission Systems (DTSs), Frequency Hopping Systems (FHSs) and Licence-Exempt Local Area Network (LE-LAN) Devices.

RSS-Gen Issue 4: General Requirements for Compliance of Radio Apparatus

ANSI C63.10:2013 : American National Standard for Testing Unlicensed Wireless Devices

ANSI C63.4: 2014: –American National Standard for Methods of Measurement of Radio-Noise Emissions from Low-Voltage Electrical and Electronic Equipment in the Range of 9 kHz to 40GHz

1.2. Test Description

FCC PART 15.247 & RSS 247		
FCC Part 15.207 RSS-Gen 8.8	AC Power Conducted Emission	PASS
FCC Part 15.205/15.209 RSS-Gen 8.9	Radiated Emissions	PASS
FCC Part 15.247(d) RSS-Gen 8.10	Band Edge Compliance of RF Emission	PASS

1.3. Test Facility

1.3.1 Address of the test laboratory

Shenzhen CTL Testing Technology Co., Ltd.

Floor 1-A, Baisha Technology Park, No. 3011, Shahexi Road, Nanshan, Shenzhen 518055 China

There is one 3m semi-anechoic chamber and two line conducted labs for final test. The Test Sites meet the requirements in documents ANSI C63.4 and CISPR 32/EN 55032 requirements.

1.3.2 Laboratory accreditation

The test facility is recognized, certified, or accredited by the following organizations:

IC Registration No.: 9618B

The 3m alternate test site of Shenzhen CTL Testing Technology Co., Ltd. EMC Laboratory has been registered by Certification and Engineer Bureau of Industry Canada for the performance of with Registration No.: 9618B on November 13, 2013.

FCC-Registration No.: 399832

Shenzhen CTL Testing Technology Co., Ltd. EMC Laboratory has been registered and fully described in a report filed with the (FCC) Federal Communications Commission. The acceptance letter from the FCC is maintained in our files. Registration 970318, December 19, 2013.

1.4. Statement of the measurement uncertainty

The data and results referenced in this document are true and accurate. The reader is cautioned that there may be errors within the calibration limits of the equipment and facilities. The measurement uncertainty was calculated for all measurements listed in this test report acc. to CISPR 16 - 4 "Specification for radio disturbance and immunity measuring apparatus and methods – Part 4: Uncertainty in EMC Measurements" and is documented in the Shenzhen CTL Testing Technology Co., Ltd. quality system acc. to DIN EN ISO/IEC 17025. Furthermore, component and process variability of devices similar to that tested may result in additional deviation. The manufacturer has the sole responsibility of continued compliance of the device.

Hereafter the best measurement capability for CTL laboratory is reported:

Test	Measurement Uncertainty	Notes
Transmitter power conducted	±0.57 dB	(1)
Transmitter power Radiated	±2.20 dB	(1)
Conducted spurious emission 9KHz-40 GHz	±2.20 dB	(1)
Occupied Bandwidth	±0.01ppm	(1)
Radiated Emission 30~1000MHz	±4.10dB	(1)
Radiated Emission Above 1GHz	±4.32dB	(1)
Conducted Disturbance0.15~30MHz	±3.20dB	(1)

- (1) This uncertainty represents an expanded uncertainty expressed at approximately the 95% confidence level using a coverage factor of k=2.

2. GENERAL INFORMATION

2.1. Environmental conditions

During the measurement the environmental conditions were within the listed ranges:

Normal Temperature:	25°C
Relative Humidity:	55 %
Air Pressure:	101 kPa

2.2. General Description of EUT

Product Name:	High Power Bluetooth PA System with Lights
Model/Type reference:	iPA69D
Power supply:	100-120V/220-240V~, 50/60Hz, 320W
Bluetooth	
Version:	Bluetooth BR/EDR
Modulation:	GFSK, $\pi/4$ DQPSK, 8DPSK
Operation frequency:	2402MHz~2480MHz
Channel number:	79
Channel separation:	1MHz
Antenna type:	PCB antenna
Antenna gain:	0dBi

Note: For more details, refer to the user's manual of the EUT.

2.3. Description of Test Modes and Test Frequency

The Applicant provides communication tools software to control the EUT for staying in continuous transmitting and receiving mode for testing.

There are 79 channels provided to the EUT and Channel 00/39/78 was selected for testing.

Operation Frequency :

Channel	Frequency (MHz)
00	2402
01	2403
:	:
38	2440
39	2441
40	2442
:	:
77	2479
78	2480

Note: The line display in grey were the channel selected for testing

Preliminary tests were performed in each mode and packet length of BT, and found worst case as bellow, finally test were conducted at those mode and recorded in this report.

Test Items	Worst case
Conducted Emissions	DH5 Middle channel
Radiated Emissions and Band Edge	DH5
Maximum Conducted Output Power	DH5/2DH5/3DH5
20dB Bandwidth&99% Bandwidth	DH5/2DH5/3DH5
Frequency Separation	DH5/2DH5/3DH5 Middle channel
Number of hopping frequency	DH5/2DH5/3DH5
Time of Occupancy (Dwell Time)	DH1/DH3/DH5 Middle channel 2DH1/2DH3/2DH5 Middle channel 3DH1/3DH3/3DH5 Middle channel
Out-of-band Emissions	DH5/2DH5/3DH5

2.4. Equipments Used during the Test

Test Equipment	Manufacturer	Model No.	Serial No.	Calibration Date	Calibration Due Date
LISN	R&S	ENV216	3560.6550.12	2018/06/02	2019/06/01
LISN	R&S	ESH2-Z5	860014/010	2018/06/02	2019/06/01
Bilog Antenna	Sunol Sciences Corp.	JB1	A061713	2018/06/02	2019/06/01
EMI Test Receiver	R&S	ESCI	103710	2018/06/02	2019/06/01
Spectrum Analyzer	Agilent	E4407B	MY41440676	2018/05/21	2019/05/20
Spectrum Analyzer	Agilent	N9020	US46220290	2018/01/16	2019/01/17
Power Meter	Anritsu	ML2487B	110553	2018/06/02	2019/06/01
Power Sensor	Anritsu	MA2411B	100345	2018/05/21	2019/05/20
Controller	EM Electronics	Controller EM 1000	N/A	2018/05/21	2019/05/20
Horn Antenna	Sunol Sciences Corp.	DRH-118	A062013	2018/05/19	2019/05/18
Active Loop Antenna	SCHWARZBECK	FMZB1519	1519-037	2018/05/19	2019/05/18
Amplifier	Agilent	8449B	3008A02306	2018/05/19	2019/05/18
Amplifier	Agilent	8447D	2944A10176	2018/05/19	2019/05/18
Temperature/Humidity Meter	Gangxing	CTH-608	02	2018/05/20	2019/05/19
High-Pass Filter	K&L	9SH10-2700/X 12750-O/O	N/A	2018/05/20	2019/05/19
High-Pass Filter	K&L	41H10-1375/U 12750-O/O	N/A	2018/05/20	2019/05/19
Coaxial Cables	HUBER+SUHNER	SUCOFLEX 104PEA-10M	10m	2018/06/02	2019/06/01
Coaxial Cables	HUBER+SUHNER	SUCOFLEX 104PEA-3M	3m	2018/06/02	2019/06/01

Coaxial Cables	HUBER+SUHN ER	SUCOFLEX 104PEA-3M	3m	2018/06/02	2019/06/01
RF Cable	Megalon	RF-A303	N/A	2018/06/02	2019/06/01

The calibration interval was one year

2.5. Related Submittal(s) / Grant (s)

This submittal(s) (test report) is intended to comply with Section 15.247 of the FCC Part 15, Subpart C Rules ,RSS Gen and RSS 247 Rules.

2.6. Modifications

No modifications were implemented to meet testing criteria.



3. TEST CONDITIONS AND RESULTS

3.1. Conducted Emissions Test

LIMIT

According to FCC CFR Title 47 Part 15 Subpart C Section 15.207 and RSS Gen 8.8, AC Power Line Conducted Emissions Limits for Licence-Exempt Radio Apparatus as below:

Frequency range (MHz)	Limit (dBuV)	
	Quasi-peak	Average
0.15-0.5	66 to 56*	56 to 46*
0.5-5	56	46
5-30	60	50

* Decreases with the logarithm of the frequency.

TEST CONFIGURATION

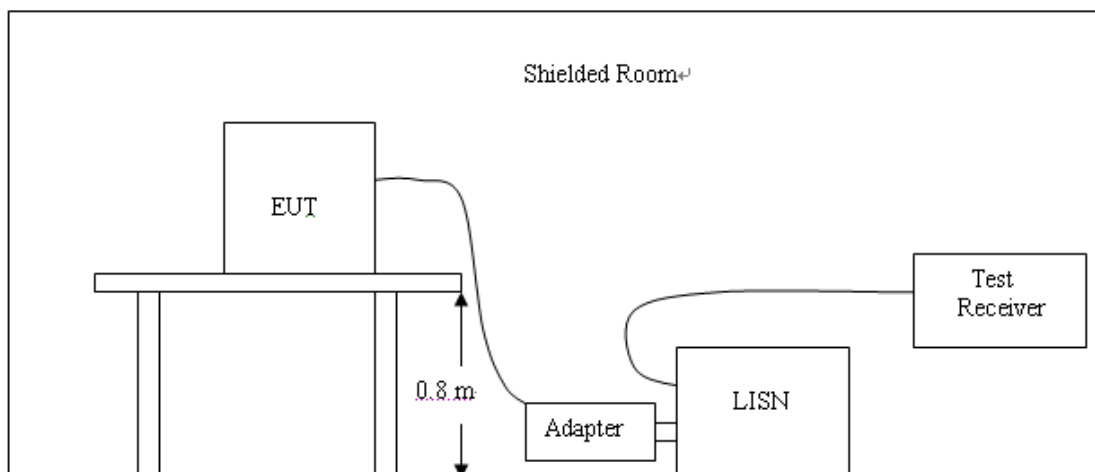

TEST PROCEDURE

1. The equipment was set up as per the test configuration to simulate typical actual usage per the user's manual. The EUT is a tabletop system; a wooden table with a height of 0.8 meters is used and is placed on the ground plane as per ANSI C63.10:2013.
2. Support equipment, if needed, was placed as per ANSI C63.10:2013
3. All I/O cables were positioned to simulate typical actual usage as per ANSI C63.10:2013.
4. The adapter received AC120V/60Hz power through a Line Impedance Stabilization Network (LISN) which supplied power source and was grounded to the ground plane.
5. All support equipments received AC power from a second LISN, if any.
6. The EUT test program was started. Emissions were measured on each current carrying line of the EUT using a spectrum Analyzer / Receiver connected to the LISN powering the EUT. The LISN has two monitoring points: Line 1 (Hot Side) and Line 2 (Neutral Side). Two scans were taken: one with Line 1 connected to Analyzer / Receiver and Line 2 connected to a 50 ohm load; the second scan had Line 1 connected to a 50 ohm load and Line 2 connected to the Analyzer / Receiver.
7. Analyzer / Receiver scanned from 150 KHz to 30MHz for emissions in each of the test modes.
8. During the above scans, the emissions were maximized by cable manipulation.

TEST RESULTS

Remark: All modes of GFSK, Pi/4 DQPSK, and 8DPSK were test at Low, Middle, and High channel; only the worst result of 8DPSK High Channel was reported as below:

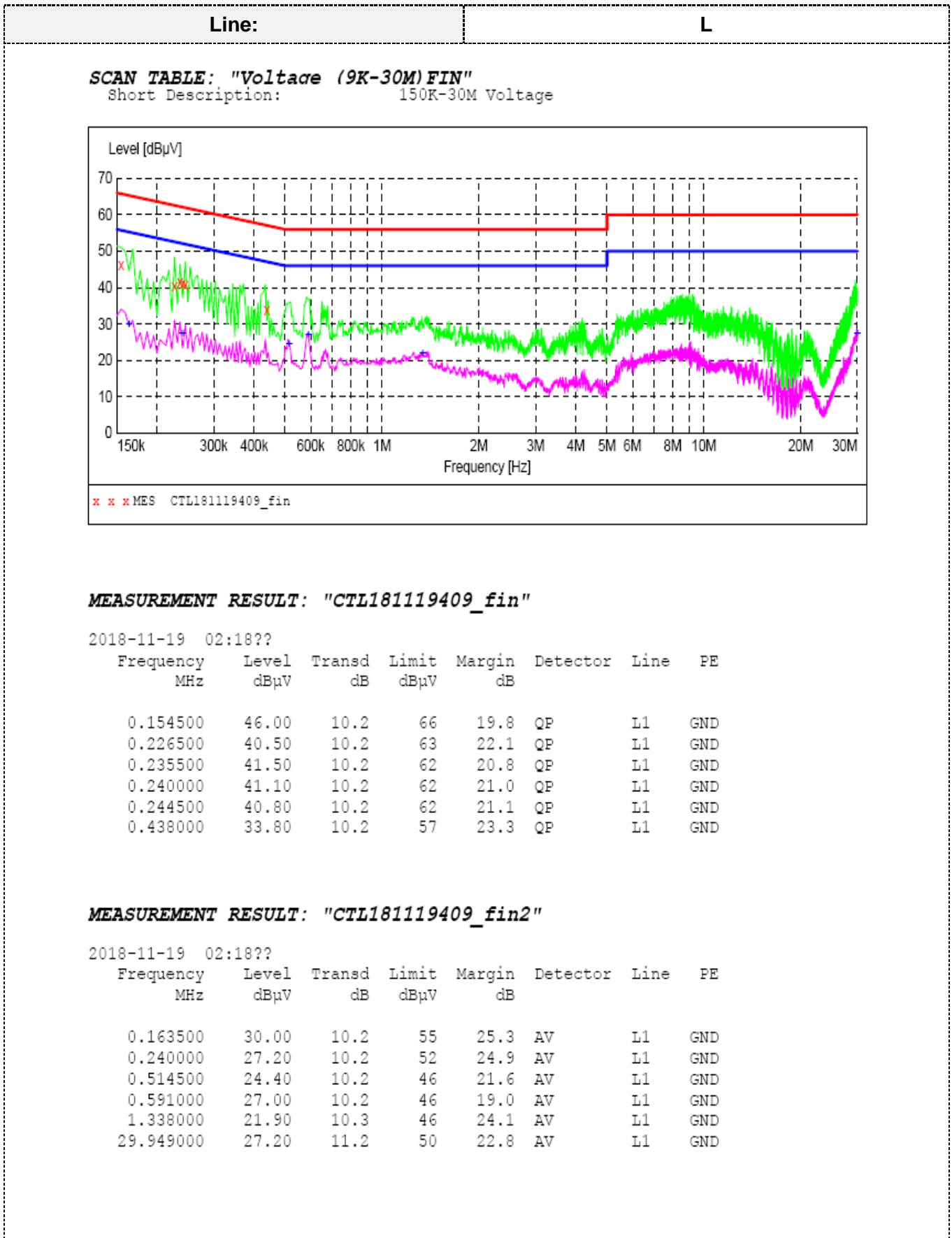

Line:	N
--------------	----------

SCAN TABLE: "Voltage (9K-30M) FIN"
 Short Description: 150K-30M Voltage

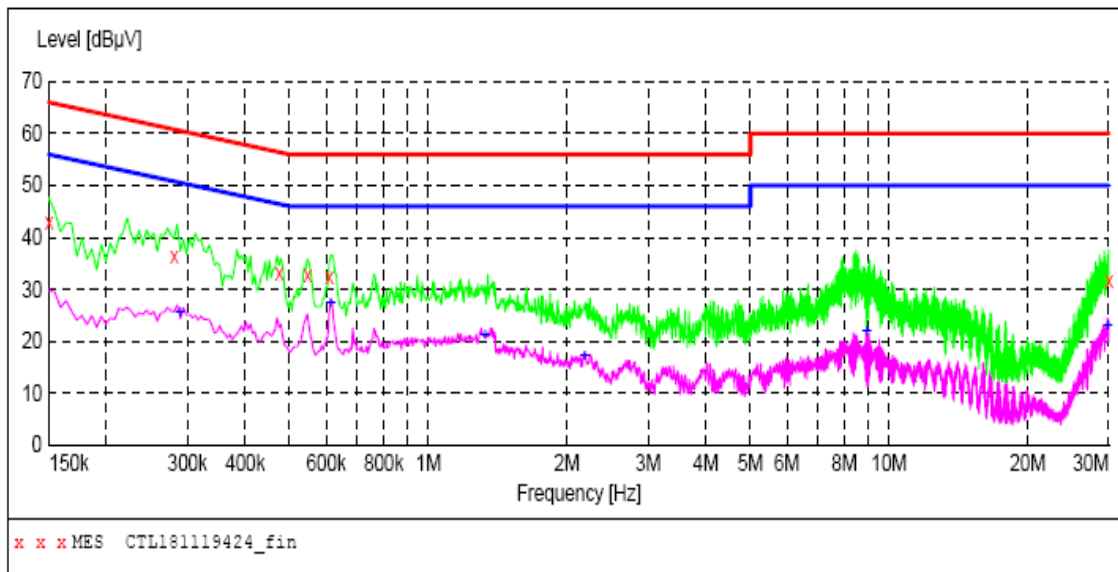

MEASUREMENT RESULT: "CTL181119424_fin"

2018-11-19 03:06??

Frequency MHz	Level dBµV	Transd dB	Limit dBµV	Margin dB	Detector	Line	PE
0.150000	42.90	10.2	66	23.1	QP	N	GND
0.280500	36.50	10.2	61	24.3	QP	N	GND
0.474000	33.00	10.2	56	23.4	QP	N	GND
0.546000	32.80	10.2	56	23.2	QP	N	GND
0.609000	32.30	10.2	56	23.7	QP	N	GND
29.971500	31.80	11.2	60	28.2	QP	N	GND

MEASUREMENT RESULT: "CTL181119424_fin2"

2018-11-19 03:06??

Frequency MHz	Level dBµV	Transd dB	Limit dBµV	Margin dB	Detector	Line	PE
0.289500	25.50	10.2	51	25.0	AV	N	GND
0.613500	27.30	10.2	46	18.7	AV	N	GND
1.329000	21.00	10.3	46	25.0	AV	N	GND
2.184000	17.10	10.4	46	28.9	AV	N	GND
8.952000	21.80	10.6	50	28.2	AV	N	GND
29.877000	22.80	11.2	50	27.2	AV	N	GND

3.2. Radiated Emissions and Band Edge

Limit

For intentional device, according to § 15.209(a), the general requirement of field strength of radiated emission out of authorized band shall not exceed the following table at a 3 meters measurement distance.

In addition, radiated emissions which fall in the restricted bands, as defined in §15.205(a), must also comply with the radiated emission limits specified in §15.209(a)

Radiated emission limits

Frequency (MHz)	Distance (Meters)	Radiated (dB μ V/m)	Radiated (μ V/m)
0.009-0.49	3	$20\log(2400/F(\text{KHz}))+40\log(300/3)$	$2400/F(\text{KHz})$
0.49-1.705	3	$20\log(24000/F(\text{KHz}))+40\log(30/3)$	$24000/F(\text{KHz})$
1.705-30	3	$20\log(30)+40\log(30/3)$	30
30-88	3	40.0	100
88-216	3	43.5	150
216-960	3	46.0	200
Above 960	3	54.0	500

TEST CONFIGURATION

(A) Radiated Emission Test Set-Up, Frequency Below 30MHz

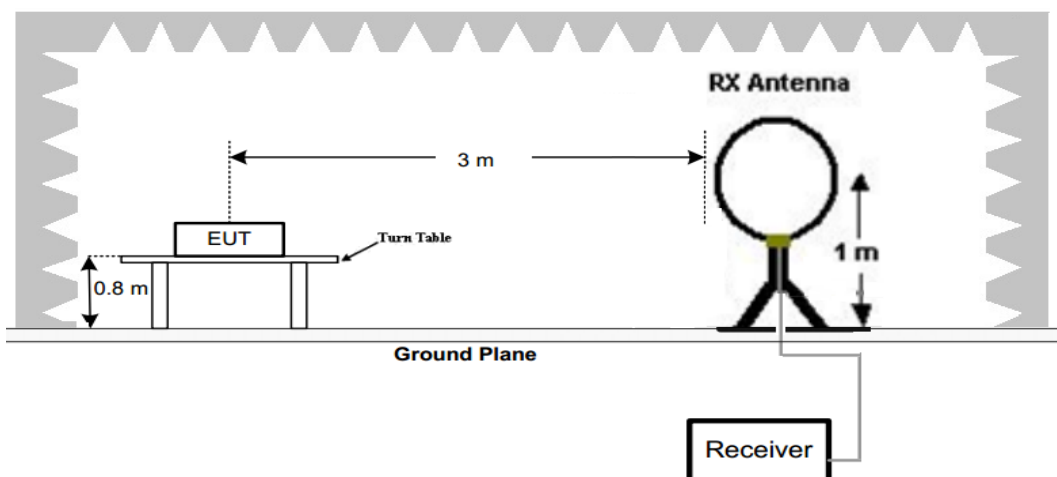

(B) Radiated Emission Test Set-Up, Frequency below 1000MHz

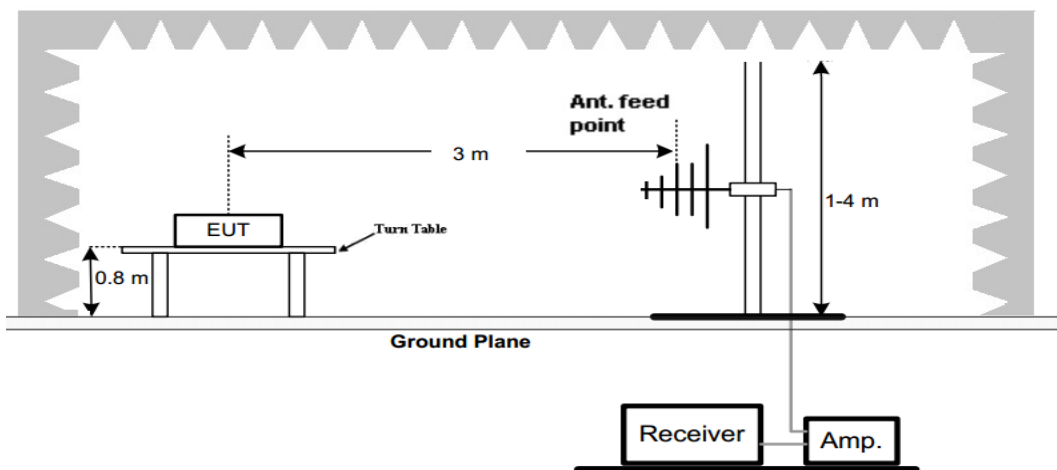

(C) Radiated Emission Test Set-Up, Frequency above 1000MHz

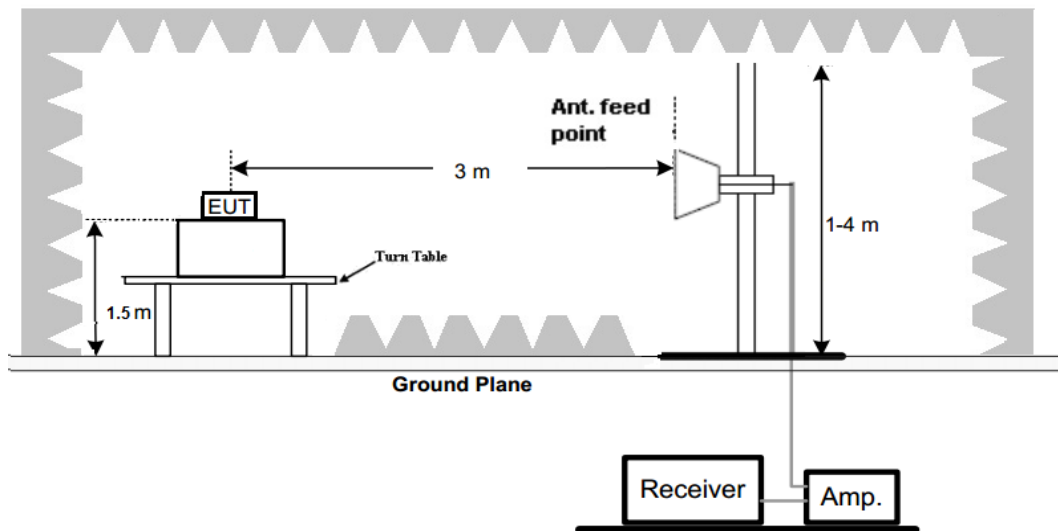

Test Procedure

1. Below 1GHz measurement the EUT is placed on a turntable which is 0.8m above ground plane, and above 1GHz measurement EUT was placed on a low permittivity and low loss tangent turn table which is 1.5m above ground plane.
2. Maximum procedure was performed by raising the receiving antenna from 1m to 4m and rotating the turn table from 0° to 360° to acquire the highest emissions from EUT
3. And also, each emission was to be maximized by changing the polarization of receiving antenna both horizontal and vertical.
4. Repeat above procedures until all frequency measurements have been completed.

TEST RESULTS

Remark:

1. We measured Radiated Emission at GFSK, $\pi/4$ DQPSK and 8DPSK mode from 9 KHz to 25GHz and recorded worst case at GFSK DH5 mode.
2. For below 1GHz testing recorded worst at GFSK DH5 low channel.
3. Radiated emission test from 9 KHz to 10th harmonic of fundamental was verified, and no emission found except system noise floor in 9 KHz to 30MHz and not recorded in this report.

For 30MHz-1GHz

Horizontal

SWEEP TABLE: "test (30M-1G)"

Short Description:		Field Strength			
Start	Stop	Detector	Meas. Time	IF Bandw.	Transducer
30.0 MHz	1.0 GHz	MaxPeak	200.0 ms	120 kHz	VULB 9168

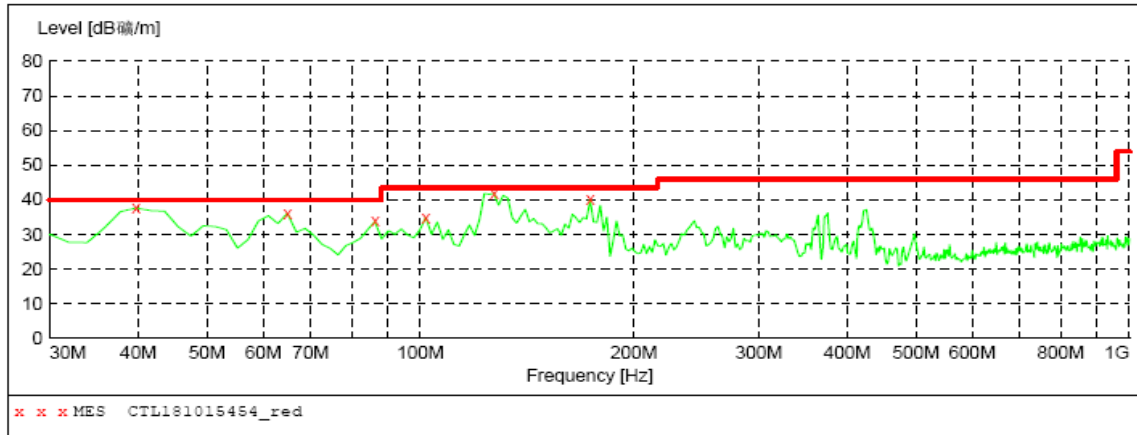

MEASUREMENT RESULT: "CTL181015454_red"

2018-10-15 16:37

Frequency MHz	Level dB/m	Transd dB	Limit dB/m	Margin dB	Det.	Height cm	Azimuth deg	Polarization
39.700000	37.70	14.8	40.0	2.3	---	0.0	0.00	HORIZONTAL
64.920000	36.20	12.4	40.0	3.8	---	0.0	0.00	HORIZONTAL
86.260000	33.80	10.3	40.0	6.2	---	0.0	0.00	HORIZONTAL
101.780000	34.90	11.2	43.5	8.6	---	0.0	0.00	HORIZONTAL
127.000000	41.90	13.6	43.5	1.6	---	0.0	0.00	HORIZONTAL
173.560000	40.00	13.7	43.5	3.5	---	0.0	0.00	HORIZONTAL

Vertical

SWEEP TABLE: "test (30M-1G)"

Short Description:		Field Strength			
Start	Stop	Detector	Meas. Time	IF Bandw.	Transducer
30.0 MHz	1.0 GHz	MaxPeak	200.0 ms	120 kHz	VULB 9168

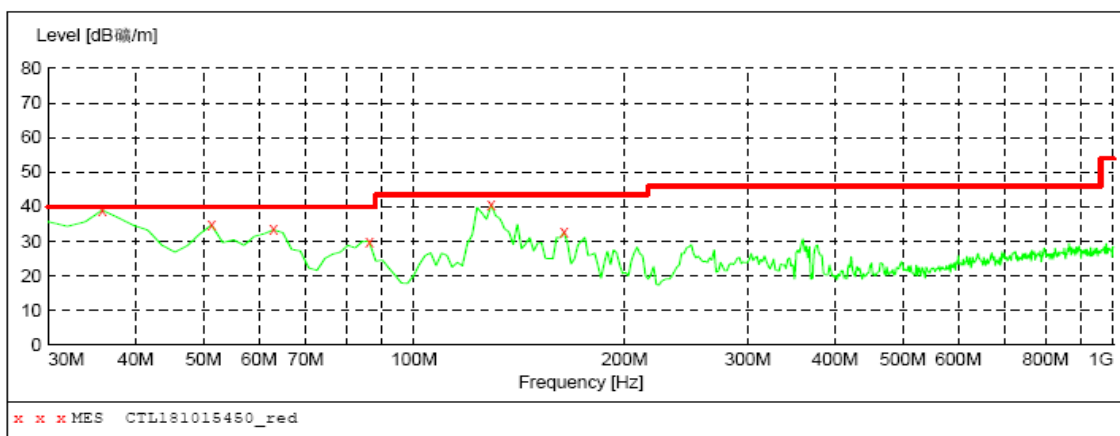

MEASUREMENT RESULT: "CTL181015450_red"

2018-10-15 16:35

Frequency MHz	Level dB/m	Transd dB	Limit dB/m	Margin dB	Det.	Height cm	Azimuth deg	Polarization
35.820000	39.00	14.2	40.0	1.0	---	0.0	0.00	VERTICAL
51.340000	34.70	14.1	40.0	5.3	---	0.0	0.00	VERTICAL
62.980000	33.40	12.8	40.0	6.6	---	0.0	0.00	VERTICAL
86.260000	30.00	10.3	40.0	10.0	---	0.0	0.00	VERTICAL
128.940000	40.60	13.7	43.5	2.9	---	0.0	0.00	VERTICAL
163.860000	32.60	14.8	43.5	10.9	---	0.0	0.00	VERTICAL

For 1GHz to 25GHz

Note: GFSK, Pi/4 DQPSK and 8DPSK all have been tested, only worse case GFSK is reported.

GFSK (above 1GHz)

Frequency(MHz):			2402		Polarity:			HORIZONTAL	
Frequency (MHz)	Emission Level (dBuV/m)		Limit (dBuV/m)	Margin (dB)	Raw Value (dBuV)	Antenna Factor (dB/m)	Cable Factor (dB)	Pre-amplifier (dB)	Correction Factor (dB/m)
4804.00	56.30	PK	74	17.70	51.79	33.49	6.91	35.89	4.51
4804.00	50.58	AV	54	3.42	46.07	33.49	6.91	35.89	4.51
5015.00	42.21	PK	74	31.79	35.37	34.03	7.04	34.24	6.84
5015.00	--	AV	54	--	--	--	--	--	--
7206.00	47.45	PK	74	26.55	36.34	36.95	9.18	35.03	11.11
7206.00	--	AV	54	--	--	--	--	--	--

Frequency(MHz):			2402		Polarity:			VERTICAL	
Frequency (MHz)	Emission Level (dBuV/m)		Limit (dBuV/m)	Margin (dB)	Raw Value (dBuV)	Antenna Factor (dB/m)	Cable Factor (dB)	Pre-amplifier (dB)	Correction Factor (dB/m)
4804.00	55.31	PK	74	18.69	50.80	33.49	6.91	35.89	4.51
4804.00	48.87	AV	54	5.13	44.36	33.49	6.91	35.89	4.51
5015.00	43.80	PK	74	30.20	36.96	34.03	7.04	34.24	6.84
5015.00	--	AV	54	--	--	--	--	--	--
7206.00	46.39	PK	74	27.61	35.28	36.95	9.18	35.03	11.11
7206.00	--	AV	54	--	--	--	--	--	--

Frequency(MHz):			2441		Polarity:			HORIZONTAL	
Frequency (MHz)	Emission Level (dBuV/m)		Limit (dBuV/m)	Margin (dB)	Raw Value (dBuV)	Antenna Factor (dB/m)	Cable Factor (dB)	Pre-amplifier (dB)	Correction Factor (dB/m)
4882.00	56.88	PK	74	17.12	52.23	33.60	6.95	35.90	4.65
4882.00	50.56	AV	54	3.44	45.91	33.60	6.95	35.90	4.65
5812.00	42.94	PK	74	31.06	35.17	34.80	7.49	34.52	7.77
5812.00	--	AV	54	--	--	--	--	--	--
7323.00	47.58	PK	74	26.42	35.88	37.46	9.23	35.00	11.70
7323.00	--	AV	54	--	--	--	--	--	--

Frequency(MHz):			2441		Polarity:			VERTICAL	
Frequency (MHz)	Emission Level (dBuV/m)		Limit (dBuV/m)	Margin (dB)	Raw Value (dBuV)	Antenna Factor (dB/m)	Cable Factor (dB)	Pre-amplifier (dB)	Correction Factor (dB/m)
4882.00	55.96	PK	74	18.04	51.31	33.60	6.95	35.90	4.65
4882.00	48.50	AV	54	5.50	43.85	33.60	6.95	35.90	4.65
5812.00	41.08	PK	74	32.92	33.31	34.80	7.49	34.52	7.77
5812.00	--	AV	54	--	--	--	--	--	--
7323.00	45.31	PK	74	28.69	33.61	37.46	9.23	35.00	11.70
7323.00	--	AV	54	--	--	--	--	--	--

Frequency(MHz):			2480		Polarity:			HORIZONTAL	
Frequency (MHz)	Emission Level (dBuV/m)		Limit (dBuV/m)	Margin (dB)	Raw Value (dBuV)	Antenna Factor (dB/m)	Cable Factor (dB)	Pre-amplifier (dB)	Correction Factor (dB/m)
4960.00	57.04	PK	74	16.96	52.12	33.84	7.00	35.92	4.92
4960.00	50.70	AV	54	3.30	45.78	33.84	7.00	35.92	4.92
6455.00	42.75	PK	74	31.25	34.10	35.17	8.29	34.81	8.65
6455.00	--	AV	54	--	--	--	--	--	--
7440.00	47.12	PK	74	26.88	35.17	37.64	9.28	34.97	11.95
7440.00	--	AV	54	--	--	--	--	--	--

Frequency(MHz):			2480		Polarity:			VERTICAL	
Frequency (MHz)	Emission Level (dBuV/m)		Limit (dBuV/m)	Margin (dB)	Raw Value (dBuV)	Antenna Factor (dB/m)	Cable Factor (dB)	Pre-amplifier (dB)	Correction Factor (dB/m)
4960.00	56.99	PK	74	17.01	52.07	33.84	7.00	35.92	4.92
4960.00	49.23	AV	54	4.77	44.31	33.84	7.00	35.92	4.92
6455.00	43.38	PK	74	30.62	34.73	35.17	8.29	34.81	8.65
6455.00	--	AV	54	--	--	--	--	--	--
7440.00	46.43	PK	74	27.57	34.48	37.64	9.28	34.97	11.95
7440.00	--	AV	54	--	--	--	--	--	--

REMARKS:

1. Emission level (dBuV/m) =Raw Value (dBuV)+Correction Factor (dB/m)
2. Correction Factor (dB/m) = Antenna Factor (dB/m)+Cable Factor (dB)-Pre-amplifier Factor
3. Margin value = Limit value- Emission level.
4. -- Mean the PK detector measured value is below average limit.
5. The other emission levels were very low against the limit.
6. RBW1MHz VBW3MHz Peak detector is for PK value; RBW 1MHz VBW10Hz Peak detector is for AV value.

Results of Band Edges Test (Radiated)

Note: GFSK, Pi/4 DQPSK and 8DPSK all have been tested, only worse case GFSK is reported.

Frequency(MHz):			2402		Polarity:			HORIZONTAL	
Frequency (MHz)	Emission Level (dBuV/m)		Limit (dBuV/m)	Margin (dB)	Raw Value (dBuV)	Antenna Factor (dB/m)	Cable Factor (dB)	Pre-amplifier (dB)	Correction Factor (dB/m)
2402.00	96.55	PK	--	--	63.15	28.78	4.61	0.00	33.40
2402.00	89.74	AV	--	--	56.34	28.78	4.61	0.00	33.40
2343.00	41.92	PK	74	32.08	8.95	28.43	4.55	0.00	32.97
2343.00	--	AV	54	--	--	--	--	--	--
2390.00	46.78	PK	74	27.22	13.46	28.72	4.60	0.00	33.32
2390.00	--	AV	54	--	--	--	--	--	--
2400.00	48.44	PK	74	25.56	15.05	28.78	4.61	0.00	33.39
2400.00	--	AV	54	--	--	--	--	--	--

Frequency(MHz):			2402		Polarity:			VERTICAL	
Frequency (MHz)	Emission Level (dBuV/m)		Limit (dBuV/m)	Margin (dB)	Raw Value (dBuV)	Antenna Factor (dB/m)	Cable Factor (dB)	Pre-amplifier (dB)	Correction Factor (dB/m)
2402.00	97.42	PK	--	--	64.02	28.78	4.61	0.00	33.40
2402.00	90.36	AV	--	--	56.96	28.78	4.61	0.00	33.40
2343.00	42.73	PK	74	31.27	9.76	28.43	4.55	0.00	32.97
2343.00	--	AV	54	--	--	--	--	--	--
2390.00	44.26	PK	74	29.74	10.94	28.72	4.60	0.00	33.32
2390.00	--	AV	54	--	--	--	--	--	--
2400.00	47.45	PK	74	26.55	14.06	28.78	4.61	0.00	33.39
2400.00	--	AV	54	--	--	--	--	--	--

Frequency(MHz):			2480		Polarity:			HORIZONTAL	
Frequency (MHz)	Emission Level (dBuV/m)		Limit (dBuV/m)	Margin (dB)	Raw Value (dBuV)	Antenna Factor (dB/m)	Cable Factor (dB)	Pre-amplifier (dB)	Correction Factor (dB/m)
2480.00	95.55	PK	--	--	61.93	28.92	4.70	0.00	33.62
2480.00	88.24	AV	--	--	54.62	28.92	4.70	0.00	33.62
2483.50	42.01	PK	74	31.99	8.38	28.93	4.70	0.00	33.63
2483.50	--	AV	54	--	--	--	--	--	--
2492.00	41.40	PK	74	32.60	7.74	28.95	4.71	0.00	33.66
2492.00	--	AV	54	--	--	--	--	--	--
2500.00	41.59	PK	74	32.41	7.91	28.96	4.72	0.00	33.68
2500.00	--	AV	54	--	--	--	--	--	--

Frequency(MHz):			2480		Polarity:			VERTICAL	
Frequency (MHz)	Emission Level (dBuV/m)		Limit (dBuV/m)	Margin (dB)	Raw Value (dBuV)	Antenna Factor (dB/m)	Cable Factor (dB)	Pre-amplifier (dB)	Correction Factor (dB/m)
2480.00	96.05	PK	--	--	62.43	28.92	4.70	0.00	33.62
2480.00	90.03	AV	--	--	56.41	28.92	4.70	0.00	33.62
2483.50	42.20	PK	74	31.80	8.57	28.93	4.70	0.00	33.63
2483.50	--	AV	54	--	--	--	--	--	--
2492.00	41.61	PK	74	32.39	7.95	28.95	4.71	0.00	33.66
2492.00	--	AV	54	--	--	--	--	--	--
2500.00	40.17	PK	74	33.83	6.49	28.96	4.72	0.00	33.68
2500.00	--	AV	54	--	--	--	--	--	--

REMARKS:

1. Emission level (dBuV/m) =Raw Value (dBuV)+Correction Factor (dB/m)
2. Correction Factor (dB/m) = Antenna Factor (dB/m)+Cable Factor (dB)-Pre-amplifier Factor
3. Margin value = Limit value- Emission level.
4. -- Mean the PK detector measured value is below average limit.
5. The other emission levels were very low against the limit.
6. RBW1MHz VBW3MHz Peak detector is for PK value; RBW 1MHz VBW10Hz Peak detector is for AV value.
7. For fundamental frequency, RBW 3MHz VBW 3MHz Peak detector is for PK Value; RMS detector is for AV value.

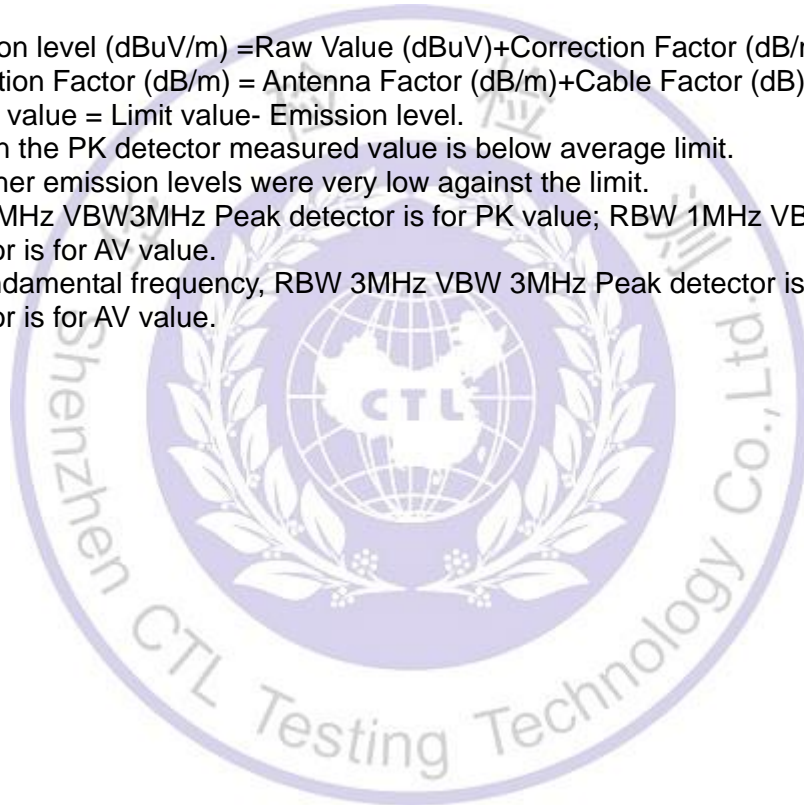

4. Test Setup Photos of the EUT

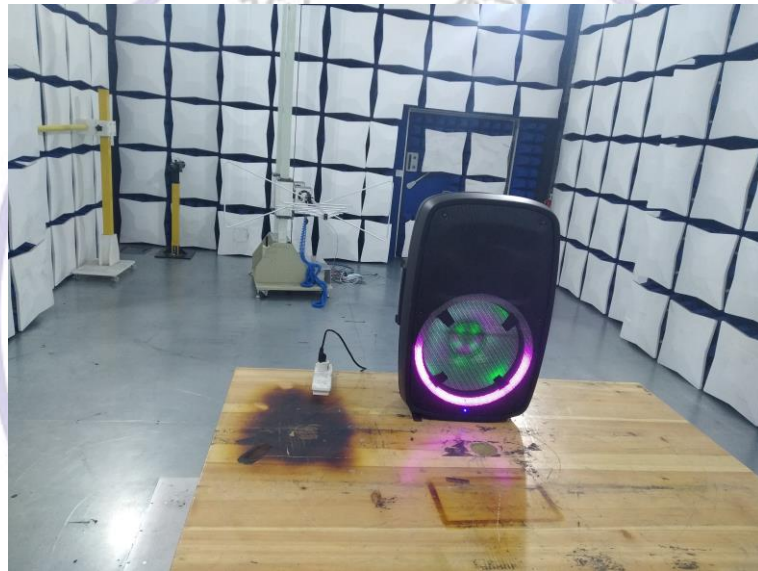

5. External and Internal Photos of the EUT

External Photos





Internal Photos of EUT

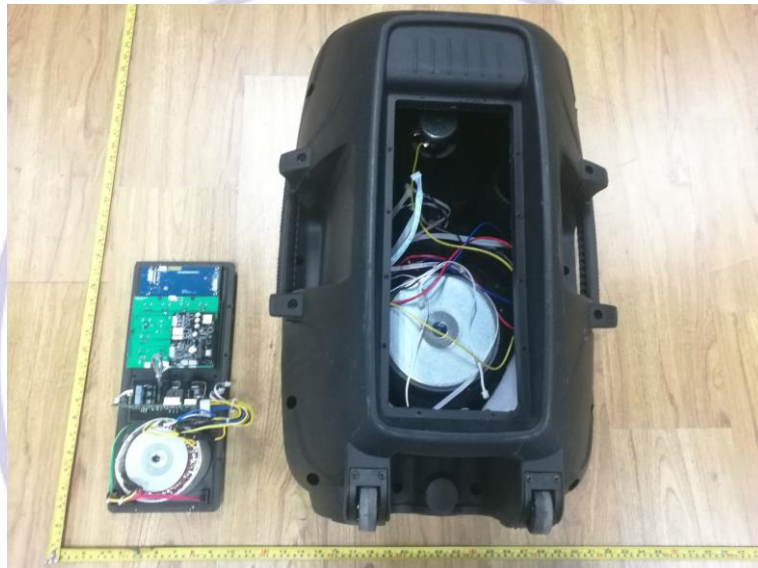

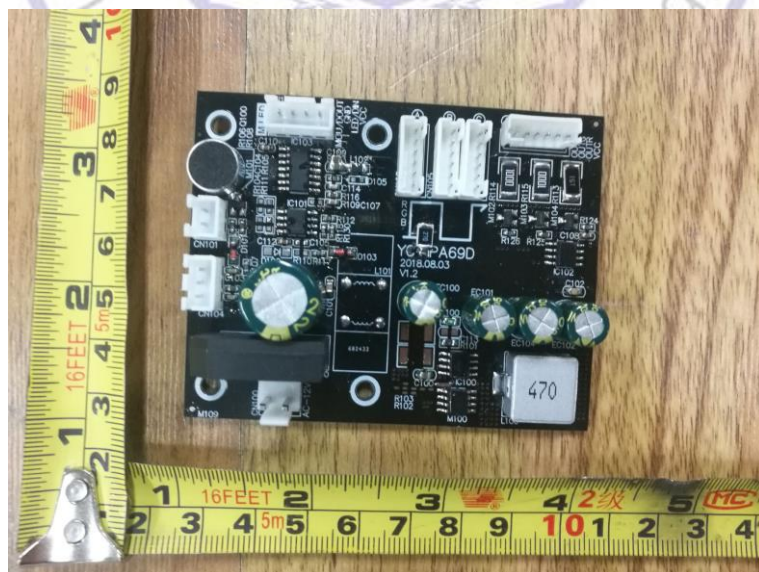
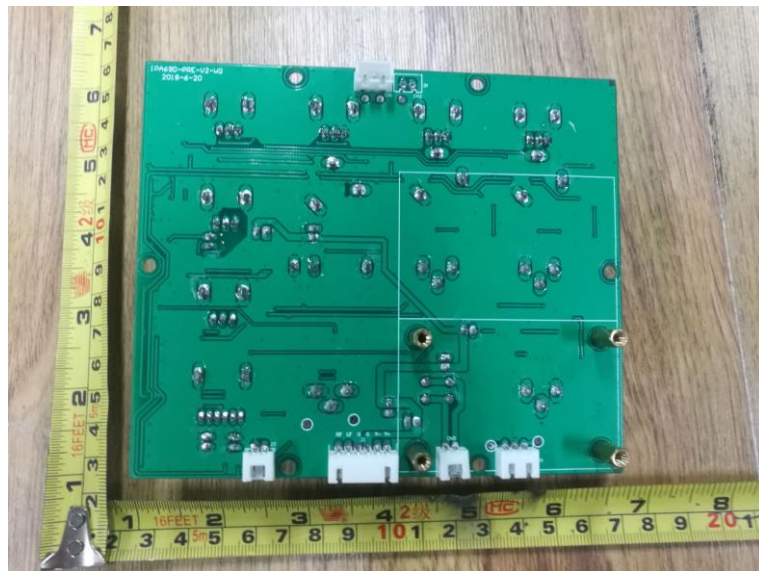

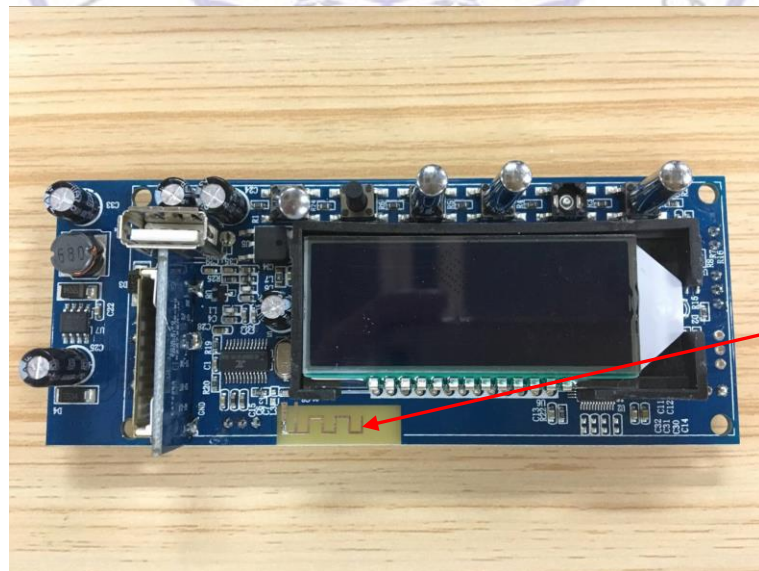
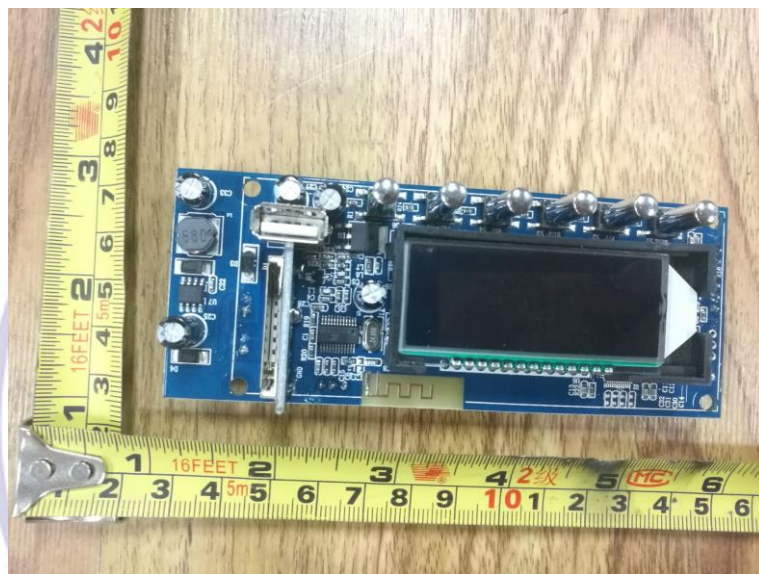
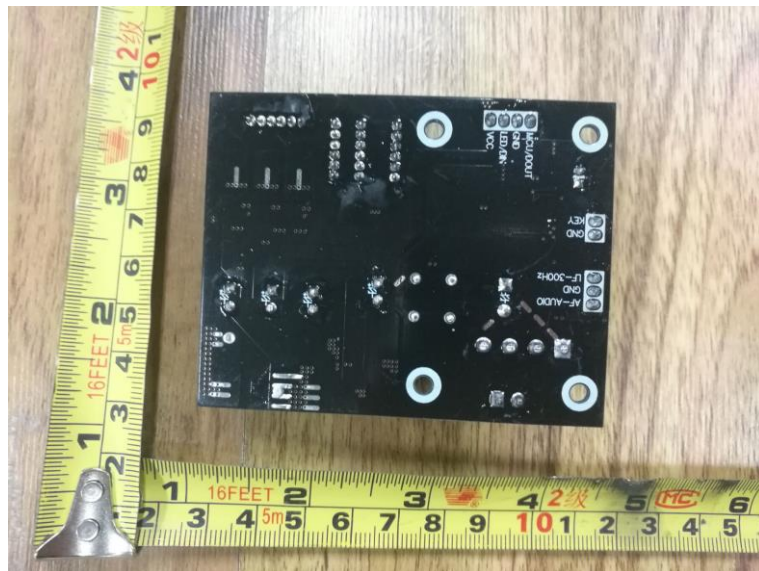

Antenna

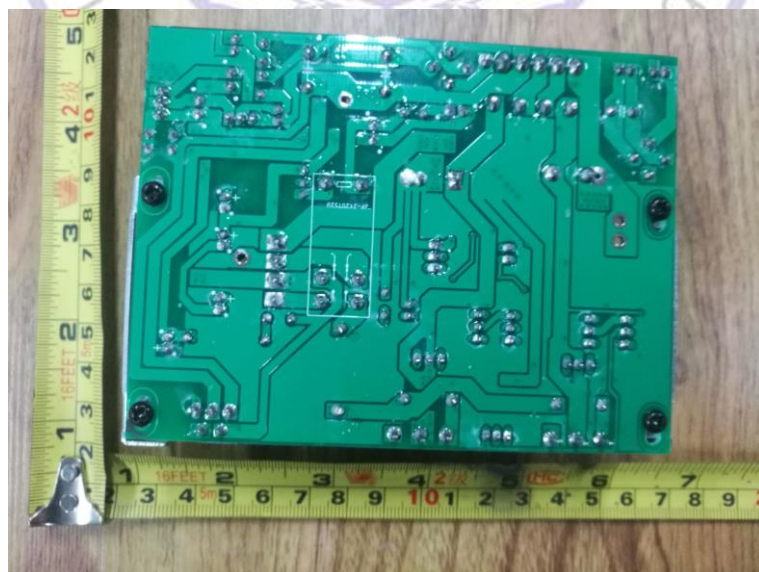
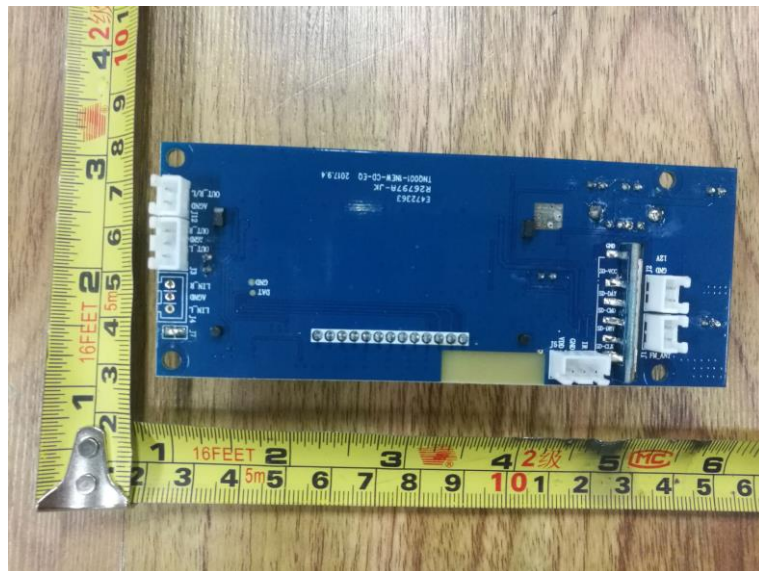

***** End of Report *****