



TEST REPORT

Report Reference No......: **CTL1611084501-WF**

Compiled by
(position+printed name+signature)...: Happy Guo
(File administrators) *Happy Guo*

Name of the organization performing the tests
(position+printed name+signature)...: Nice Nong
(Test Engineer) *Nice Nong*

Approved by
(position+printed name+signature)...: Allen Wang
(Manager) *Allen Wang*

Date of issue.....: Dec. 05, 2016

Test Firm.....: **Shenzhen CTL Testing Technology Co., Ltd.**

Address.....: Floor 1-A, Baisha Technology Park, No.3011, Shahehexi Road, Nanshan District, Shenzhen, China 518055

Applicant's name.....: **ION Audio, LLC**

Address.....: 200 Scenic View Drive, Cumberland, RI 02864, U.S.A.

Test specification:

Standard.....: **47 CFR FCC Part 15 Subpart C 15.247 & RSS 247 Issue 1, May 2015**

Master TRF.....: Dated 2011-01

Shenzhen CTL Testing Technology Co., Ltd. All rights reserved.

This publication may be reproduced in whole or in part for non-commercial purposes as long as the Shenzhen CTL Testing Technology Co., Ltd. is acknowledged as copyright owner and source of the material. Shenzhen CTL Testing Technology Co., Ltd. takes no responsibility for and will not assume liability for damages resulting from the reader's interpretation of the reproduced material due to its placement and context.

Test item description: **Complete High Power Bluetooth PA System**

FCC ID.....: **2AB3E-IPA69**

IC: **10541A-IPA69**

Trade Mark: ION

Model/Type reference.....: TOTAL PA PRO, iPA69A

Work frequency: 2402~2480MHz

Version.....: V2.1+EDR

Type of modulation.....: FHSS

Data Rate.....: 1Mbps(GFSK), 2Mbps(Pi/4 DQPSK), 3Mbps(8DPSK)

Antenna Gain: 0 dBi

Antenna type: Internal

Result.....: **Positive**

TEST REPORT

Test Report No. :	CTL1611084501-WF	Dec. 05, 2016
		Date of issue

Equipment under Test : Complete High Power Bluetooth PA System

Model /Type : TOTAL PA PRO

Listed Models : iPA69A

Difference Description : Only the color and model's name is different

Applicant : **ION Audio, LLC**

Address : 200 Scenic View Drive, Cumberland, RI 02864, U.S.A.

Manufacturer : **ION Audio, LLC**

Address : 200 Scenic View Drive, Cumberland, RI 02864, U.S.A.

Test Result according to the standards on page 5:	Positive
--	-----------------

The test report merely corresponds to the test sample.

It is not permitted to copy extracts of these test result without the written permission of the test laboratory.

Contents

1.	<u>TEST STANDARDS</u>	<u>4</u>
2.	<u>SUMMARY</u>	<u>5</u>
2.1.	General Remarks	5
2.2.	Equipment Under Test	5
2.3.	Short description of the Equipment under Test (EUT)	5
2.4.	EUT operation mode	5
2.5.	EUT configuration	6
2.6.	Configuration of Tested System	6
2.7.	Related Submittal(s) / Grant (s)	6
2.8.	Modifications	6
2.9.	Frequency Hopping System Requirements	6
2.10.	Mode of Operation	8
3.	<u>TEST ENVIRONMENT</u>	<u>9</u>
3.1.	Address of the test laboratory	9
3.2.	Test Facility	9
3.3.	Environmental conditions	9
3.4.	Statement of the measurement uncertainty	9
3.5.	Test Description	10
3.6.	Equipments Used during the Test	11
4.	<u>TEST CONDITIONS AND RESULTS</u>	<u>12</u>
4.1.	AC Power Conducted Emission	12
4.2.	Radiated Emission and Band Edge	15
5.	<u>TEST SETUP PHOTOS OF THE EUT</u>	<u>22</u>
6.	<u>EXTERNAL AND INTERNAL PHOTOS OF THE EUT</u>	<u>24</u>

1. TEST STANDARDS

The tests were performed according to following standards:

[FCC Rules Part 15.247](#): Frequency Hopping, Direct Spread Spectrum and Hybrid Systems that are in operation within the bands of 902-928 MHz, 2400-2483.5 MHz, and 5725-5850 MHz

[RSS-247-Issue 1](#): Digital Transmission Systems (DTSs), Frequency Hopping Systems (FHSs) and Licence-Exempt Local Area Network (LE-LAN) Devices.

[RSS-Gen Issue 4](#): General Requirements for Compliance of Radio Apparatus

[ANSI C63.10:2013](#) : American National Standard for Testing Unlicensed Wireless Devices

[ANSI C63.4: 2014](#): –American National Standard for Methods of Measurement of Radio-Noise Emissions from Low-Voltage Electrical and Electronic Equipment in the Range of 9 kHz to 40GHz



2. SUMMARY

2.1. General Remarks

Date of receipt of test sample	:	Nov. 20, 2016
Testing commenced on	:	Nov. 20, 2016
Testing concluded on	:	Dec. 05, 2016

2.2. Equipment Under Test

Power supply system utilised

Power supply voltage	:	<input checked="" type="radio"/> 120V / 60 Hz	<input type="radio"/> 115V / 60Hz
		<input type="radio"/> 12 V DC	<input type="radio"/> 24 V DC
		<input type="radio"/> Other (specified in blank below)	

2.3. Short description of the Equipment under Test (EUT)

Product Name:	Complete High Power Bluetooth PA System
Model/Type reference:	TOTAL PA PRO, iPA69A
Power supply:	AC 120V/60Hz
Bluetooth 2.1+EDR	
Modulation:	1Mbps(GFSK), 2Mbps($\pi/4$ DQPSK), 3Mbps(8DPSK)
Operation frequency:	2402MHz~2480MHz
Channel number:	79
Channel separation:	1MHz
Antenna type:	PCB Antenna
Antenna gain:	0dBi

2.4. EUT operation mode

The EUT has been tested under typical operating condition. The Applicant provides communication tools software to control the EUT for staying in continuous transmitting and receiving mode for testing. There are 79 channels of EUT, and the test carried out at the lowest channel, middle channel and highest channel.

Frequency Range:	2402-2480MHz
Channel number:	79 channels
Modulation type:	GFSK, $\pi/4$ -DQPSK, 8-DPSK
Antenna:	PCB antenna

Test Channel	Test Frequency
Low Channel	2402 MHz
Middle Channel	2441 MHz
High Channel	2480 MHz

2.5. EUT configuration

The following peripheral devices and interface cables were connected during the measurement:

- - supplied by the manufacturer
- - supplied by the lab

● Notebook PC(FCC DOC Approval)	Manufacturer :	DELL
	Model No. :	PP18L

2.6. Configuration of Tested System

Fig. 2-1 Configuration of Tested System



Table 2-1 Equipment Used in Tested System

2.7. Related Submittal(s) / Grant (s)

This submittal(s) (test report) is intended for **FCC ID: 2AB3E-IPA69** and **IC: 10541A-IPA69** filing to comply with Section 15.247 of the FCC Part 15, Subpart C Rules and RSS 247 Issue 1.

2.8. Modifications

No modifications were implemented to meet testing criteria.

2.9. Frequency Hopping System Requirements

Standard Applicable

According to FCC Part 15.247(a)(1), The system shall hop to channel frequencies that are selected at the system hopping rate from a pseudo randomly ordered list of hopping frequencies. Each frequency must be used equally on the average by each transmitter. The system receivers shall have input bandwidths that match the hopping channel bandwidths of their corresponding transmitters and shall shift frequencies in synchronization with the transmitted signals.

(g) Frequency hopping spread spectrum systems are not required to employ all available hopping channels during each transmission. However, the system, consisting of both the transmitter and the receiver, must be designed to comply with all of the regulations in this section should the transmitter be presented with a continuous data (or information) stream. In addition, a system employing short transmission bursts must comply with the definition of a frequency hopping system and must distribute its transmissions over the minimum number of hopping channels specified in this section.

(h) The incorporation of intelligence within a frequency hopping spread spectrum system that permits the system to recognize other users within the spectrum band so that it individually and independently chooses and adapts its hopsets to avoid hopping on occupied channels is permitted. The coordination of frequency

hopping systems in any other manner for the express purpose of avoiding the simultaneous occupancy of individual hopping frequencies by multiple transmitters is not permitted.

EUT Pseudorandom Frequency Hopping Sequence

The pseudorandom sequence may be generated in a nine-stage shift register whose 5th and 9th stage outputs are added in a modulo-two addition stage, and the result is fed back to the input of the first stage. The sequence begins with the first ONE of 9 consecutive ONES; i.e. the shift register is initialized with nine ones.

Number of shift register stages: 9
 Length of pseudo-random sequence: 29-1=511bits
 Longest sequence of zeros: 8(non-inverted signal)

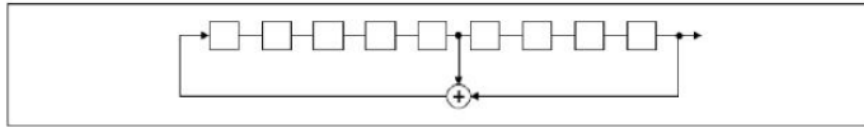

Linear Feedback Shift Register for Generation of the PRBS sequence

The frequencies allocated for the Bluetooth Module is $F(\text{MHz})=2402+1*n$ ($0 < n <= 78$). The lowest, middle, highest channel numbers of the Bluetooth Module used and tested in this report are separately 0 (2402MHz), 39 (2441MHz) and 78 (2480MHz).

Each frequency used equally on the average by each transmitter. The system receiver have input bandwidths that match the hopping channel bandwidths of their corresponding transmitters and shift frequencies in synchronization with the transmitted signals.

The selection scheme chooses a segment of 32 hop frequencies spanning about 64 MHz and visits these hops in a pseudo-random order. Next, a different 32-hop segment is chosen, etc. In the page, master page response, slave page response, page scan, inquiry, inquiry response and inquiry scan hopping sequences, the same 32-hop segment is used all the time (the segment is selected by the address; different devices will have different paging segments).

When the basic channel hopping sequence is selected, the output constitutes a pseudo-random sequence that slides through the 79 hops.

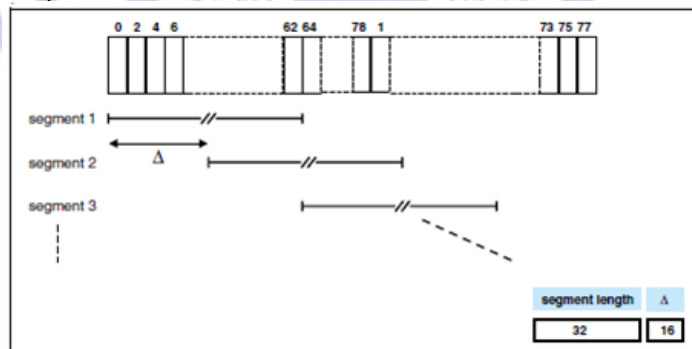

Hop selection scheme in CONNECTION state.

Channels list:

Channel	Frequency (MHz)	Channel	Frequency (MHz)	Channel	Frequency (MHz)
00	2402	27	2429	54	2456
01	2403	28	2430	55	2457
02	2404	29	2431	56	2458
03	2405	30	2432	57	2459
04	2406	31	2433	58	2460
05	2407	32	2434	59	2461
06	2408	33	2435	60	2462
07	2409	34	2436	61	2463
08	2410	35	2437	62	2464
09	2411	36	2438	63	2465

10	2412	37	2439	64	2466
11	2413	38	2440	65	2467
12	2414	39	2441	66	2468
13	2415	40	2442	67	2469
14	2416	41	2443	68	2470
15	2417	42	2444	69	2471
16	2418	43	2445	70	2472
17	2419	44	2446	71	2473
18	2420	45	2447	72	2474
19	2421	46	2448	73	2475
20	2422	47	2449	74	2476
21	2423	48	2450	75	2477
22	2424	49	2451	76	2478
23	2425	50	2452	77	2479
24	2426	51	2453	78	2480
25	2427	52	2454		
26	2428	53	2455		

The pseudorandom frequency hopping sequence sample:

42,41,66,4,78,59,55,48,54,46,52,78,41,26,24,34,39,32,51,18,25,9,12,73,70,58,54,6,66,4,32,67,60,16,3,78,78,76,47,45,47,49,14,34, etc.

Frequency Hopping System

This transmitter device is frequency hopping device, and complies with FCC part 15.247 rule.

This device uses Bluetooth radio which operates in 2400-2483.5 MHz band. Bluetooth uses a radio technology called frequency-hopping spread spectrum, which chops up the data being sent and transmits chunks of it on up to 79 channels (1 MHz separation; from 2402 to 2480 MHz) in the range 2,400-2,483.5 MHz. The transmitter switches hop frequencies 1,600 times per second to assure a high degree of data security. All Bluetooth devices participating in a given piconet are synchronized to the frequency-hopping channel for the piconet. The frequency hopping sequence is determined by the master's device address and the phase of the hopping sequence (the frequency to hop at a specific time) is determined by the master's internal clock. Therefore, all slaves in a piconet must know the master's device address and must synchronize their clocks with the master's clock.

Adaptive Frequency Hopping (AFH) was introduced in the Bluetooth specification to provide an effective way for a Bluetooth radio to counteract normal interference. AFH identifies "bad" channels, where either other wireless devices are interfering with the Bluetooth signal or the Bluetooth signal is interfering with another device. The AFH-enabled Bluetooth device will then communicate with other devices within its piconet to share details of any identified bad channels. The devices will then switch to alternative available "good" channels, away from the areas of interference, thus having no impact on the bandwidth used.

This device was tested with an bluetooth system receiver to check that the device maintained hopping synchronization, and the device complied with these requirements for DA 00-705 and FCC Part 15.247 rule.

2.10. Mode of Operation

CTL has verified the construction and function in typical operation. All the test modes were carried out with the EUT in TX operation, Worse case is shown in this test report and defined as:

Test Mode
Mode 1: Transmitter-1Mbps(GFSK_DH5) DH5
Mode 2: Transmitter-2Mbps(Pi/4 DQPSK_DH5) 2DH5
Mode 3: Transmitter-3Mbps(8DPSK_DH5) 3DH5

3. TEST ENVIRONMENT

3.1. Address of the test laboratory

Shenzhen CTL Testing Technology Co., Ltd.
Floor 1-A, Baisha Technology Park, No.3011, Shahexi Road, Nanshan District, Shenzhen, China 518055

The sites are constructed in conformance with the requirements of ANSI C63.7, ANSI C63.10 (2013) and CISPR Publication 22.

3.2. Test Facility

The test facility is recognized, certified, or accredited by the following organizations:

IC Registration No.: 9618B

The 3m alternate test site of Shenzhen CTL Testing Technology Co., Ltd. EMC Laboratory has been registered by Certification and Engineer Bureau of Industry Canada for the performance of with Registration No.: 9618B on November 13, 2013.

FCC-Registration No.: 970318

Shenzhen CTL Testing Technology Co., Ltd. EMC Laboratory has been registered and fully described in a report filed with the (FCC) Federal Communications Commission. The acceptance letter from the FCC is maintained in our files. Registration 970318, December 19, 2013.

3.3. Environmental conditions

During the measurement the environmental conditions were within the listed ranges:

Temperature:	<u>15-35 ° C</u>
Humidity:	<u>30-60 %</u>
Atmospheric pressure:	<u>950-1050mbar</u>

3.4. Statement of the measurement uncertainty

The data and results referenced in this document are true and accurate. The reader is cautioned that there may be errors within the calibration limits of the equipment and facilities. The measurement uncertainty was calculated for all measurements listed in this test report acc. to CISPR 16 - 4 „Specification for radio disturbance and immunity measuring apparatus and methods – Part 4: Uncertainty in EMC Measurements“ and is documented in the Shenzhen CTL Testing Technology Co., Ltd. quality system acc. to DIN EN ISO/IEC 17025. Furthermore, component and process variability of devices similar to that tested may result in additional deviation. The manufacturer has the sole responsibility of continued compliance of the device.

Hereafter the best measurement capability for CTL laboratory is reported:

Test	Range	Measurement Uncertainty	Notes
Radiated Emission	30~1000MHz	4.10dB	(1)
Radiated Emission	Above 1GHz	4.32dB	(1)
Conducted Disturbance	0.15~30MHz	3.20dB	(1)

- (1) This uncertainty represents an expanded uncertainty expressed at approximately the 95% confidence level using a coverage factor of k=2.

3.5. Test Description

FCC Part Section	RSS Section(s)	Test Description	Test Result
15.207 (a)	RSS-GEN 8.8	AC Power Conducted Emission	PASS
15.205, 15.209	RSS-GEN 8.9/7	Spurious Emission	PASS
15.205, 15.209	RSS-GEN 8.9/7	Radiated Emissions	PASS
15.247 (d)	RSS-247 5.5	Band Edge /Conducted Spurious Emission	PASS

Remark: The measurement uncertainty is not included in the test result.



3.6. Equipments Used during the Test

Test Equipment	Manufacturer	Model No.	Serial No.	Calibration Date	Calibration Due Date
ULTRA-ROADBAND ANTENNA	Sunol Sciences Corp.	JB1	A061713	2016/06/02	2017/06/01
EMI Test Receiver	R&S	ESCI	103710	2016/06/02	2017/06/01
Spectrum Analyzer	Agilent	E4407B	MY41440676	2016/05/21	2017/05/20
Controller	EM Electronics	Controller EM 1000	N/A	2016/05/21	2017/05/20
Horn Antenna	Sunol Sciences Corp.	DRH-118	A062013	2016/05/19	2017/05/18
Active Loop Antenna	Daze	ZN30900A	N/A	2016/05/19	2017/05/18
LISN	R&S	ENV216	3560.6550.12	2016/06/02	2017/06/01
LISN	R&S	ESH2-Z5	860014/010	2016/06/02	2017/06/01
ISN	FCC	F-071115-1057-1-09	11229	2016/05/19	2017/05/18
Amplifier	Agilent	8349B	3008A02306	2016/05/19	2017/05/18
Amplifier	Agilent	8447D	2944A10176	2016/05/19	2017/05/18
Transient Limiter	SCHWARZCECK	VTSD 9561F	9666	2016/06/02	2017/06/01
Radio Communication Tester	R&S	CMU200	115419	2016/05/22	2017/05/21
Temperature/Humidity Meter	Gangxing	CTH-608	02	2016/05/20	2017/05/19
SIGNAL GENERATOR	Agilent	E4421B	US40051744	2016/05/20	2017/05/19
Power Meter	Agilent	U2531A	TW53323507	2016/05/21	2017/05/20
Power Sensor	Agilent	U2021XA	MY5365004	2016/05/21	2017/05/20
Climate Chamber	ESPEC	EL-10KA	A20120523	2016/05/20	2017/05/19
High-Pass Filter	K&L	9SH10-2700/X12750-O/O	N/A	2016/05/20	2017/05/19
High-Pass Filter	K&L	41H10-1375/U12750-O/O	N/A	2016/05/20	2017/05/19
RF Cable	HUBER+SUHNER	RG214	N/A	2016/05/20	2017/05/19

4. TEST CONDITIONS AND RESULTS

4.1. AC Power Conducted Emission

TEST CONFIGURATION

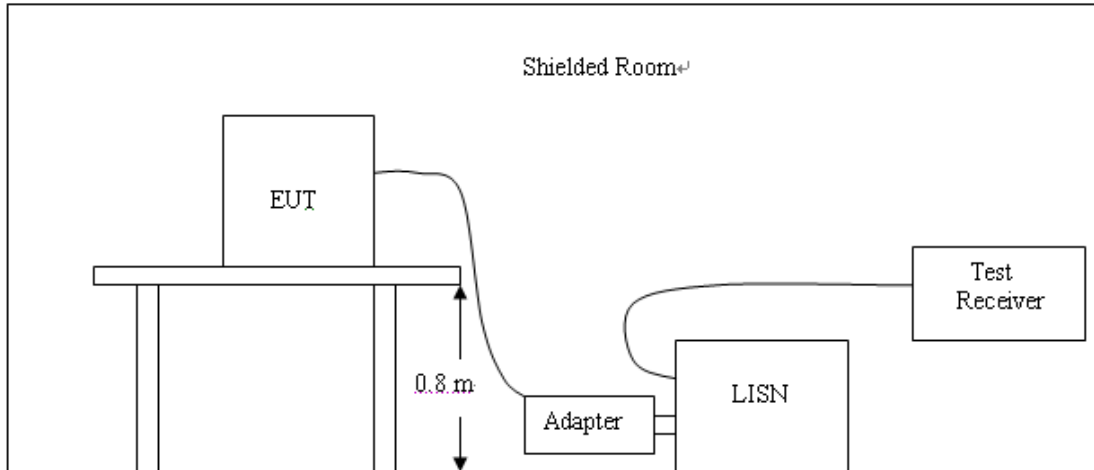

TEST PROCEDURE

- 1 The equipment was set up as per the test configuration to simulate typical actual usage per the user's manual. The EUT is a tabletop system, a wooden table with a height of 0.8 meters is used and is placed on the ground plane as per ANSI C63.10-2013.
- 2 Support equipment, if needed, was placed as per ANSI C63.10-2013
- 3 All I/O cables were positioned to simulate typical actual usage as per ANSI C63.10-2013
- 4 The EUT received DC5V power from the adapter, the adapter received AC120V/60Hz power through a Line Impedance Stabilization Network (LISN) which supplied power source and was grounded to the ground plane.
- 5 All support equipments received AC power from a second LISN, if any.
- 6 The EUT test program was started. Emissions were measured on each current carrying line of the EUT using a spectrum Analyzer / Receiver connected to the LISN powering the EUT. The LISN has two monitoring points: Line 1 (Hot Side) and Line 2 (Neutral Side). Two scans were taken: one with Line 1 connected to Analyzer / Receiver and Line 2 connected to a 50 ohm load; the second scan had Line 1 connected to a 50 ohm load and Line 2 connected to the Analyzer / Receiver.
- 7 Analyzer / Receiver scanned from 150 KHz to 30MHz for emissions in each of the test modes.
- 8 During the above scans, the emissions were maximized by cable manipulation.
Conducted emissions were investigated over the frequency range from 0.15MHz to 30MHz using a receiver bandwidth of 9kHz.

AC Power Conducted Emission Limit

For intentional device, according to § 15.207(a) AC Power Conducted Emission Limits is as following :

Frequency (MHz)	Maximum RF Line Voltage (dB μ V)			
	CLASS A		CLASS B	
	Q.P.	Ave.	Q.P.	Ave.
0.15 - 0.50	79	66	66-56*	56-46*
0.50 - 5.00	73	60	56	46
5.00 - 30.0	73	60	60	50

* Decreasing linearly with the logarithm of the frequency

TEST RESULTS

The 1Mbps (GFSK Modulation) is the worst case as results in the report based on the Pre-test for all modulation models.

Mode 1:

SCAN TABLE: "Voltage (9K-30M) FIN"

Short Description: 150K-30M Voltage

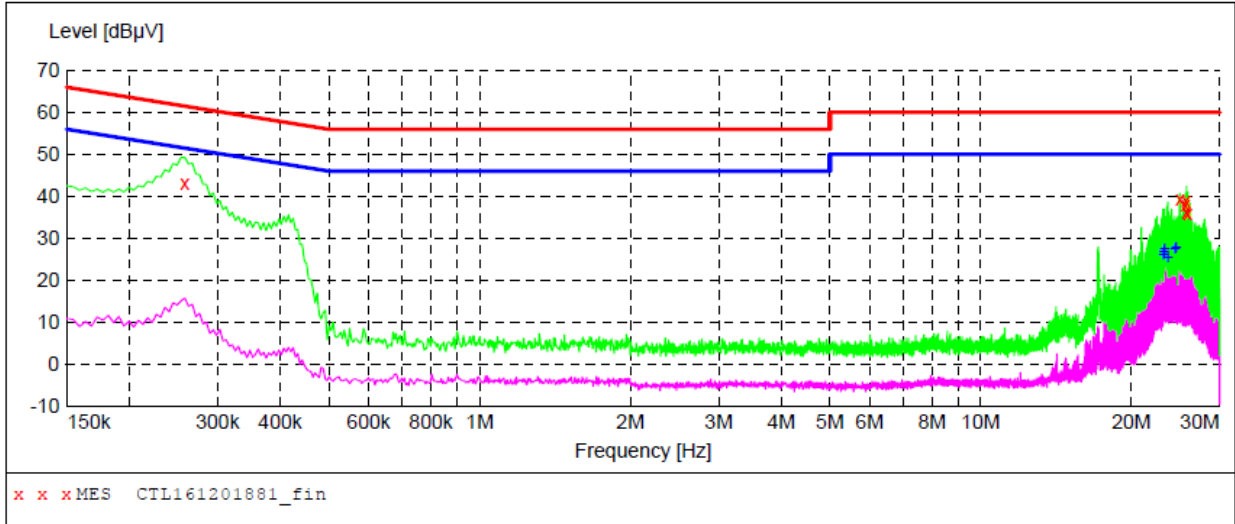

MEASUREMENT RESULT: "CTL161201881_fin"

12/1/2016 6:25PM

Frequency MHz	Level dBµV	Transd dB	Limit dBµV	Margin dB	Detector	Line	PE
0.258000	43.10	10.2	62	18.4	QP	L1	GND
24.968000	39.30	11.1	60	20.7	QP	L1	GND
25.628000	37.90	11.1	60	22.1	QP	L1	GND
25.688000	39.10	11.1	60	20.9	QP	L1	GND
25.754000	36.30	11.1	60	23.7	QP	L1	GND
25.934000	35.90	11.2	60	24.1	QP	L1	GND

MEASUREMENT RESULT: "CTL161201881_fin2"

12/1/2016 6:25PM

Frequency MHz	Level dBµV	Transd dB	Limit dBµV	Margin dB	Detector	Line	PE
23.162000	26.20	11.1	50	23.8	AV	L1	GND
23.222000	26.80	11.1	50	23.2	AV	L1	GND
23.282000	27.70	11.1	50	22.3	AV	L1	GND
23.642000	25.40	11.1	50	24.6	AV	L1	GND
24.428000	27.60	11.1	50	22.4	AV	L1	GND
24.548000	28.00	11.1	50	22.0	AV	L1	GND

SCAN TABLE: "Voltage (9K-30M) FIN"

Short Description: 150K-30M Voltage

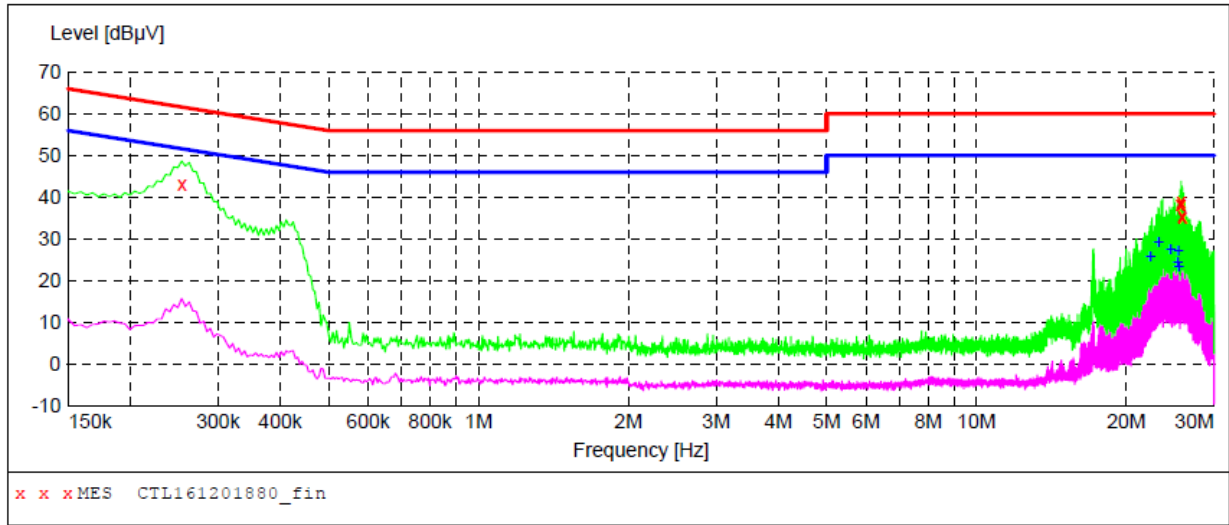

MEASUREMENT RESULT: "CTL161201880_fin"

12/1/2016 6:21PM

Frequency MHz	Level dBµV	Transd dB	Limit dBµV	Margin dB	Detector	Line	PE
0.254000	43.00	10.2	62	18.6	QP	N	GND
25.628000	38.40	11.1	60	21.6	QP	N	GND
25.748000	39.10	11.1	60	20.9	QP	N	GND
25.808000	38.30	11.1	60	21.7	QP	N	GND
25.868000	35.60	11.1	60	24.4	QP	N	GND
25.934000	35.20	11.2	60	24.8	QP	N	GND

MEASUREMENT RESULT: "CTL161204880_fin2"

12/1/2016 6:21PM

Frequency MHz	Level dBµV	Transd dB	Limit dBµV	Margin dB	Detector	Line	PE
22.382000	25.80	11.0	50	24.2	AV	N	GND
23.222000	29.40	11.1	50	20.6	AV	N	GND
24.548000	27.60	11.1	50	22.4	AV	N	GND
25.388000	24.40	11.1	50	25.6	AV	N	GND
25.448000	27.30	11.1	50	22.7	AV	N	GND
25.508000	23.40	11.1	50	26.6	AV	N	GND

4.2. Radiated Emission and Band Edge

TEST CONFIGURATION

Radiated Emission Test Set-Up
Frequency range 9KHz – 30MHz

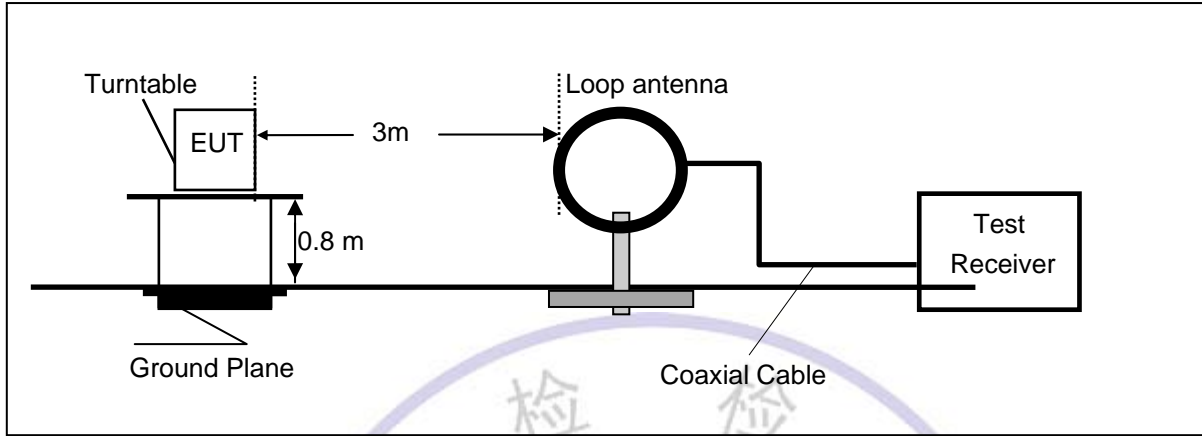

Frequency range 30MHz – 1000MHz

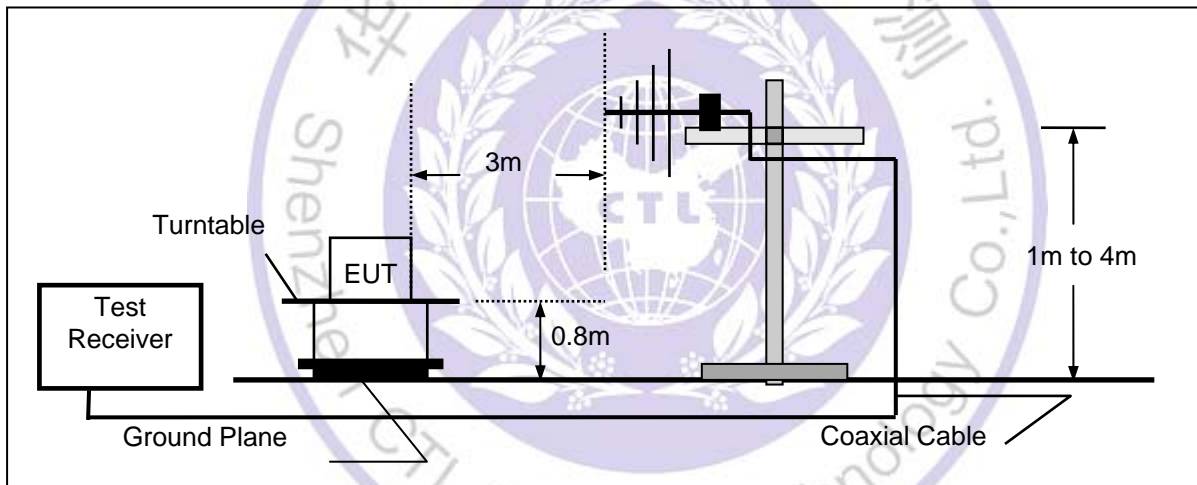

Frequency range above 1GHz-25GHz

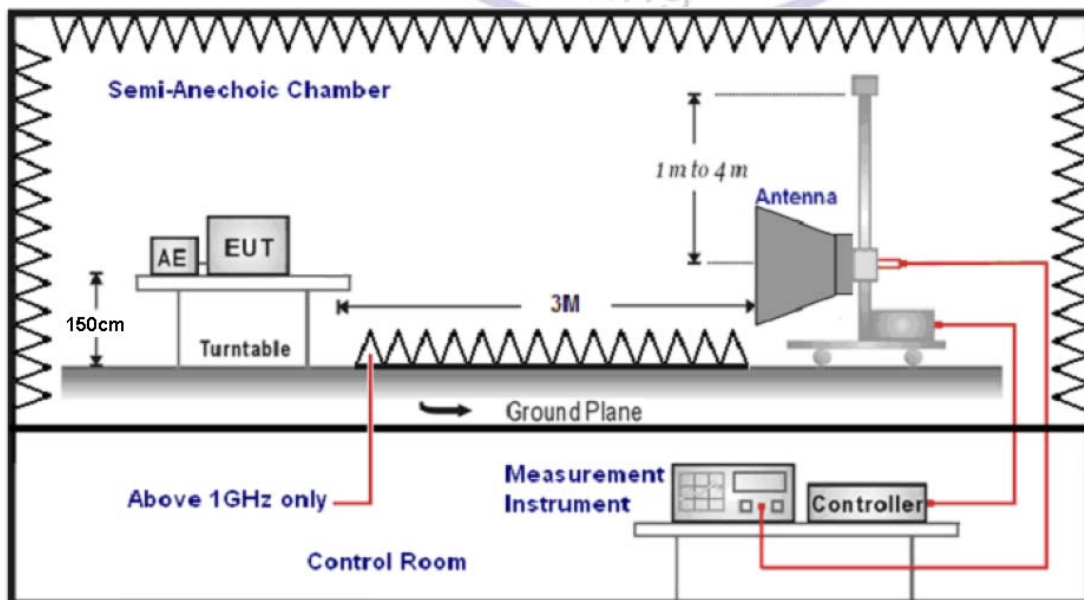

TEST PROCEDURE

1. The EUT is placed on a turntable, which is 0.8m above ground plane below 1GHz and 1.5m above ground plane above 1GHz.
2. Maximum procedure was performed by raising the receiving antenna from 1m to 4m and rotating the turn table from 0° to 360° to acquire the highest emissions from EUT
3. And also, each emission was to be maximized by changing the polarization of receiving antenna both horizontal and vertical.
4. Repeat above procedures until all frequency measurements have been completed.
5. The fundamental frequency is 2400-2483.5MHz, So the radiation emissions frequency range were tested from 9KHz to 25GHz.

Field Strength Calculation

The field strength is calculated by adding the Antenna Factor and Cable Factor and subtracting the Amplifier Gain and Duty Cycle Correction Factor(if any) from the measured reading. The basic equation with a sample calculation is as follows:

$$FS = RA + AF + CL - AG$$

Where FS = Field Strength	CL = Cable Attenuation Factor (Cable Loss)
RA = Reading Amplitude	AG = Amplifier Gain
AF = Antenna Factor	

For example

Frequency (MHz)	FS (dBμV/m)	RA (dBμV/m)	AF (dB)	CL (dB)	AG (dB)	Transd (dB)
300.00	40	58.1	12.2	1.6	31.90	-18.1

$$\text{Transd} = \text{AF} + \text{CL} - \text{AG}$$

RADIATION LIMIT

For intentional device, according to § 15.209(a), the general requirement of field strength of radiated emission from intentional radiators at a distance of 3 meters shall not exceed the following table. According to § 15.247(d), in any 100kHz bandwidth outside the frequency band in which the EUT is operating, the radio frequency power that is produced by the intentional radiator shall be at least 20dB below that in the 100kHz bandwidth within the band that contains the highest level of desired power.

Frequency (MHz)	Distance (Meters)	Radiated (dBμV/m)	Radiated (μV/m)
30-88	3	40.0	100
88-216	3	43.5	150
216-960	3	46.0	200
Above 960	3	54.0	500

TEST RESULTS

Below 1GHz:

The radiated measurement are performed the each test mode (GFSK / Pi/4 DQPSK /8DPSK) and channel (low/mid/high), the datum recorded below (GFSK mode, the middle channel) is the worst case for all the test mode and channel.

SWEEP TABLE: "test (30M-1G)"

Short Description:		Field Strength			
Start	Stop	Detector	Meas. Time	IF Bandw.	Transducer
Frequency	Frequency	MaxPeak	300.0 ms	120 kHz	JB1
30.0 MHz	1.0 GHz				

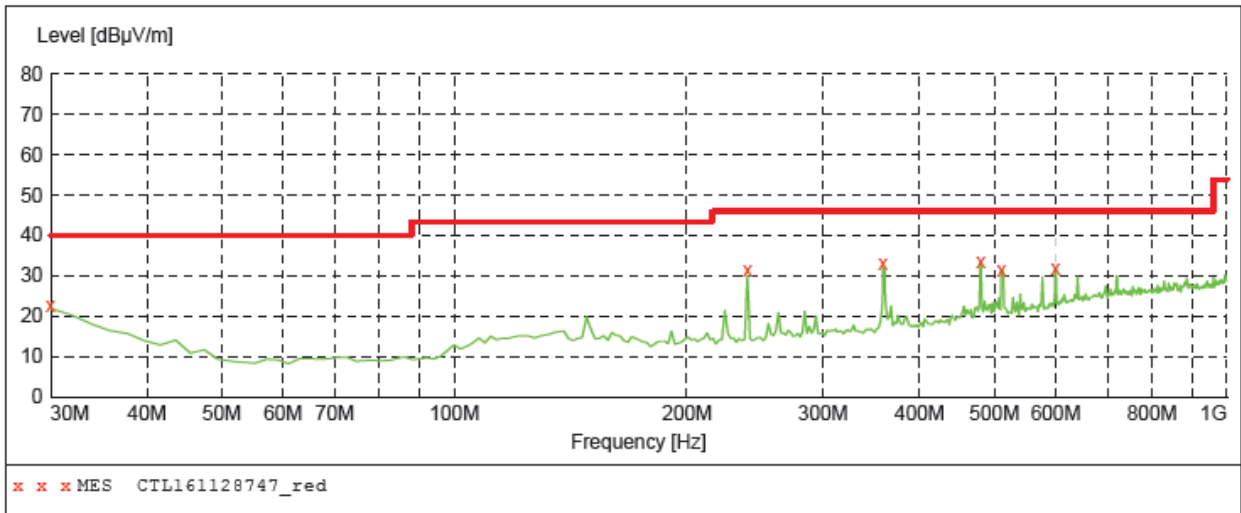

MEASUREMENT RESULT: "CTL161128747_red"

11/29/2016 9:53AM

Frequency MHz	Level dBµV/m	Transd dB	Limit dBµV/m	Margin dB	Det.	Height cm	Azimuth deg	Polarization
30.000000	21.50	20.8	40.0	18.5	---	0.0	0.00	HORIZONTAL
239.520000	30.70	13.7	46.0	15.3	---	0.0	0.00	HORIZONTAL
359.800000	32.20	17.2	46.0	13.8	---	0.0	0.00	HORIZONTAL
480.080000	32.50	20.0	46.0	13.5	---	0.0	0.00	HORIZONTAL
511.120000	30.40	20.3	46.0	15.6	---	0.0	0.00	HORIZONTAL
600.360000	30.90	21.8	46.0	15.1	---	0.0	0.00	HORIZONTAL



SWEEP TABLE: "test (30M-1G)"

Short Description:		Field Strength			
Start	Stop	Detector	Meas. Time	IF Bandw.	Transducer
30.0 MHz	1.0 GHz	MaxPeak	300.0 ms	120 kHz	JB1

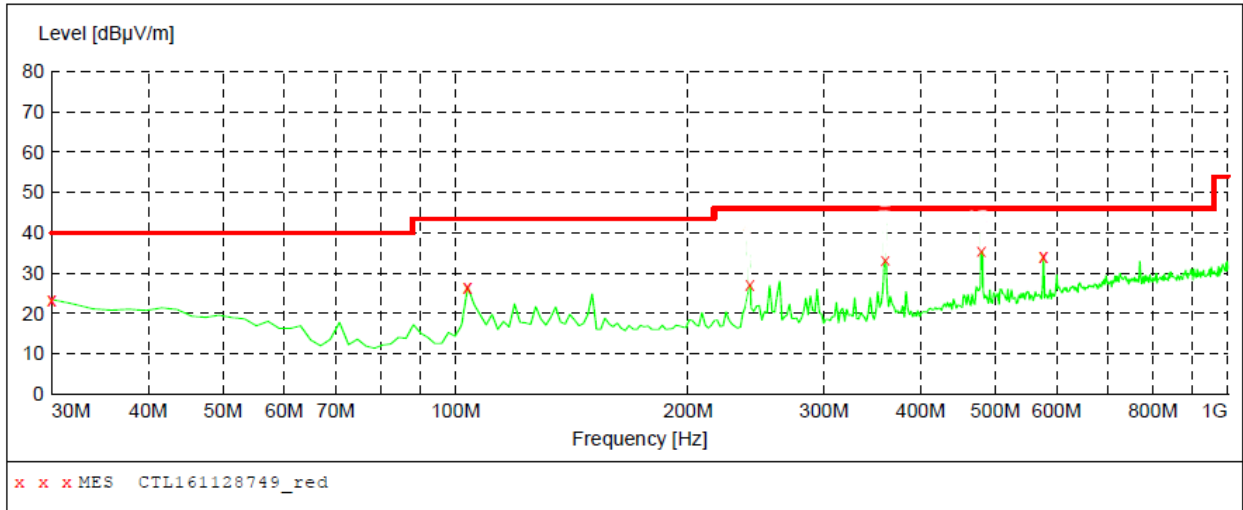

MEASUREMENT RESULT: "CTL161128749_red"

11/29/2016 9:56AM

Frequency MHz	Level dBµV/m	Transd dB	Limit dBµV/m	Margin dB	Det.	Height cm	Azimuth deg	Polarization
30.000000	23.40	20.8	40.0	16.6	---	0.0	0.00	VERTICAL
103.720000	26.60	12.0	43.5	16.9	---	0.0	0.00	VERTICAL
239.520000	27.70	13.7	46.0	18.3	---	0.0	0.00	VERTICAL
359.800000	34.07	17.2	46.0	12.3	---	0.0	0.00	VERTICAL
480.080000	36.40	20.0	46.0	9.6	---	0.0	0.00	VERTICAL
577.080000	34.10	21.4	46.0	11.9	---	0.0	0.00	VERTICAL



Above 1GHz:

Mode 1: Transmitter-1Mbps(GFSK_DH5)

CH	Antenna	Frequency (MHz)	Reading Level (dBuV/m)	Factor (dB)	Measure Level (dBuV/m)	Limit (dBuV/m)	Margin (dB)	Detector
0	V	2402	66.7	30.8	97.5	Fundamental	/	PK
	V	3200	12.1	31.1	43.2	54(note3)	10.8	PK
	V	2390	36.6	32.2	68.8	74	5.2	PK
	V	2390	16.9	32.2	49.1	54	4.9	AV
	V	2400	36.2	32.1	68.3	74	5.7	PK
	V	2400	17.1	32.1	49.2	54	4.8	AV
	V	4804	5.0	42.6	47.6	54(note3)	6.4	PK
	V	7206	20.6	46.5	67.1	74	6.9	PK
	V	7206	-3.4	46.5	43.1	54	10.9	AV
	H	24000	11.7	38.9	50.6	54	3.4	PK
39	V	2441	65.7	31.2	96.9	Fundamental	/	PK
	V	3200	11.3	31.1	42.4	54(note3)	11.6	PK
	V	4882	13.3	32.8	46.1	54(note3)	7.9	PK
	V	7323	20.4	46.8	67.2	74	6.8	PK
	V	7323	1.4	46.1	47.5	54	6.5	AV
	H	24000	11.7	38.9	50.6	54	3.4	PK
78	V	2480	65.3	30.9	96.2	Fundamental	/	PK
	V	3200	11.7	31.1	42.8	54(note3)	11.2	PK
	V	2483.5	32.0	30.2	62.2	74	11.8	PK
	V	2483.5	13.5	30.2	43.7	54	10.3	AV
	V	4960	15.6	32.5	48.1	54(note3)	5.9	PK
	V	7440	21.0	46.3	67.3	74	6.7	PK
	V	7440	0.1	46.3	46.4	54	7.6	AV
	H	24000	11.7	38.9	50.6	54	3.4	PK

Note: 1. Measure Level = Reading Level + Factor.

2. The test results which are attenuated more than 20 dB below the permissible value limit (the test frequency range: 9kHz~30MHz, 18GHz~25GHz), therefore no data appear in the report.

3. This limit applies for using average detector, if the test result on peak is lower than average limit, then average measurement needn't be performed.

Remark: RBW 1MHz VBW 3MHz peak detector for PK value, RMS detector for AV value

4. H and V polarity all have been tested ,only worse case is reported.

Mode 2: Transmitter-2Mbps(Pi/4 DQPSK_2DH5)

CH	Antenna	Frequency (MHz)	Reading Level (dBuV/m)	Factor (dB)	Measure Level (dBuV/m)	Limit (dBuV/m)	Margin (dB)	Detector
0	V	2402	62.4	30.8	93.2	Fundamental	/	PK
	V	3200	9.3	31.1	40.4	54(note3)	13.6	PK
	V	2390	35.5	32.2	67.7	74	6.3	PK
	V	2390	14.4	32.2	46.6	54	7.4	AV
	V	2400	37.3	32.1	69.4	74	4.6	PK
	V	2400	16.0	32.1	48.1	54	5.9	AV
	V	4804	4.2	42.6	46.8	54(note3)	7.2	PK
	V	7206	21.1	46.5	67.6	74	6.4	PK
	V	7206	-3.3	46.5	43.2	54	10.8	AV
	H	24000	11.7	38.9	50.6	54	3.4	PK
39	V	2441	63.5	31.2	94.7	Fundamental	/	PK
	V	3200	11.8	31.1	42.9	54(note3)	11.1	PK
	V	4882	14.4	32.8	47.2	54(note3)	6.8	PK
	V	7323	21.6	46.8	68.4	74	5.6	PK
	V	7323	1.3	46.1	47.4	54	6.6	AV
	H	24000	11.7	38.9	50.6	54	3.4	PK
78	V	2480	62.0	30.9	92.9	Fundamental	/	PK
	V	3200	10.7	31.1	41.8	54(note3)	12.2	PK
	V	2483.5	31.4	30.2	61.6	74	12.4	PK
	V	2483.5	18.2	30.2	48.4	54	5.6	AV
	V	4960	14.6	32.5	47.1	54(note3)	6.9	PK
	V	7440	21.2	46.3	67.5	74	6.5	PK
	V	7440	0.3	46.3	46.6	54	7.4	AV
	H	24000	11.7	38.9	50.6	54	3.4	PK

Note: 1. Measure Level = Reading Level + Factor.

2. The test results which are attenuated more than 20 dB below the permissible value limit (the test frequency range: 9kHz~30MHz, 18GHz~25GHz), therefore no data appear in the report.

3. This limit applies for using average detector, if the test result on peak is lower than average limit, then average measurement needn't be performed.

Remark: RBW 1MHz VBW 3MHz peak detector for PK value, RMS detector for AV value

4. H and V polarity all have been tested ,only worse case is reported

Mode 3: Transmitter-3Mbps(8DPSK_3DH5)

CH	Antenna	Frequency (MHz)	Reading Level (dBUV/m)	Factor (dB)	Measure Level (dBUV/m)	Limit (dBUV/m)	Margin (dB)	Detector
0	V	2402	63.3	30.8	94.1	Fundamental	/	PK
	V	3200	9.2	31.1	40.3	54(note3)	13.7	PK
	V	2390	34.5	32.2	66.7	74	7.3	PK
	V	2390	12.7	32.2	44.9	54	9.1	AV
	V	2400	35.2	32.1	67.3	74	6.7	PK
	V	2400	17.0	32.1	49.1	54	4.9	AV
	V	4804	6.2	42.6	48.8	54(note3)	5.2	PK
	V	7206	20.7	46.5	67.2	74	6.8	PK
	V	7206	1.4	46.5	47.9	54	6.1	AV
	H	24000	11.7	38.9	50.6	54	3.4	PK
39	V	2441	63.1	31.2	94.3	Fundamental	/	PK
	V	3200	10.5	31.1	41.6	54(note3)	12.4	PK
	V	4882	14.3	32.8	47.1	54(note3)	6.9	PK
	V	7323	19.5	46.8	66.3	74	7.7	PK
	V	7323	0.7	46.1	46.8	54	7.2	AV
	H	24000	11.7	38.9	50.6	54	3.4	PK
78	V	2480	62.3	30.9	93.2	Fundamental	/	PK
	V	3200	16.0	31.1	47.1	54(note3)	6.9	PK
	V	2483.5	32.7	30.2	62.9	74	11.1	PK
	V	2483.5	11.5	30.2	41.7	54	12.3	AV
	V	4960	13.6	32.5	46.1	54(note3)	7.9	PK
	V	7440	20.1	46.3	66.4	74	7.6	PK
	V	7440	-2.5	46.3	43.8	54	10.2	AV
	H	24000	11.7	38.9	50.6	54	3.4	PK

Note: 1. Measure Level = Reading Level + Factor.

2. The test results which are attenuated more than 20 dB below the permissible value limit (the test frequency range: 9kHz~30MHz, 18GHz~25GHz), therefore no data appear in the report.

3. This limit applies for using average detector, if the test result on peak is lower than average limit, then average measurement needn't be performed.

Remark: RBW 1MHz VBW 3MHz peak detector for PK value, RMS detector for AV value

4. H and V polarity all have been tested ,only worse case is reported

5. Test Setup Photos of the EUT





6. External and Internal Photos of the EUT

External Photos of EUT







Internal Photos of EUT

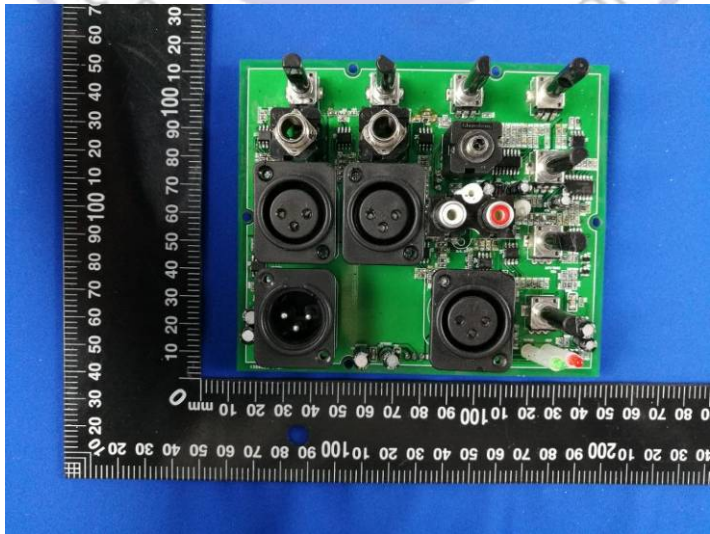
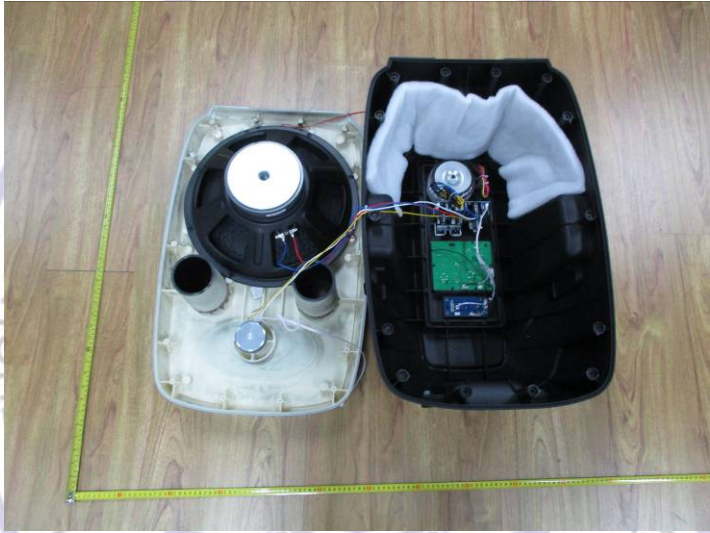

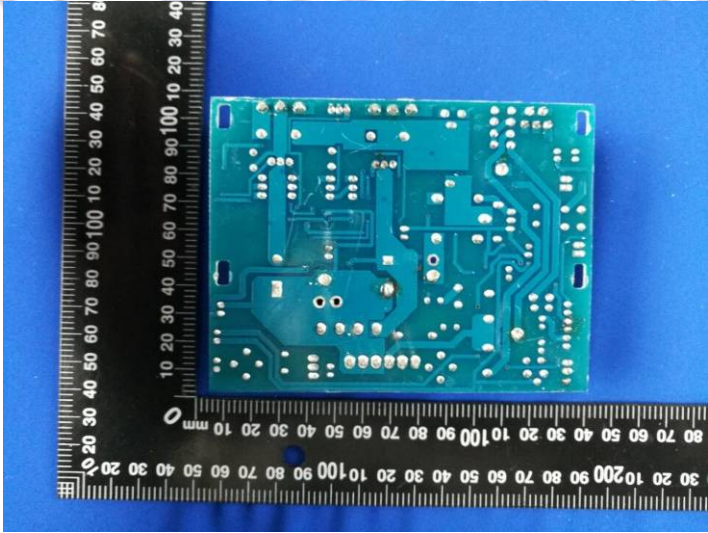
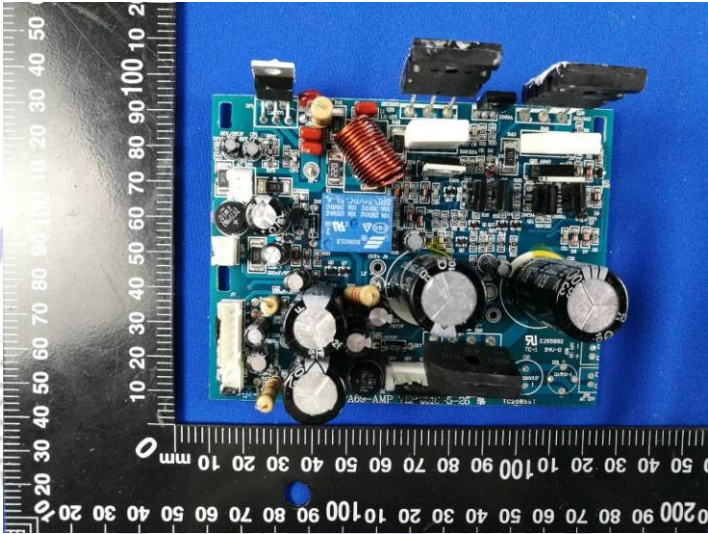
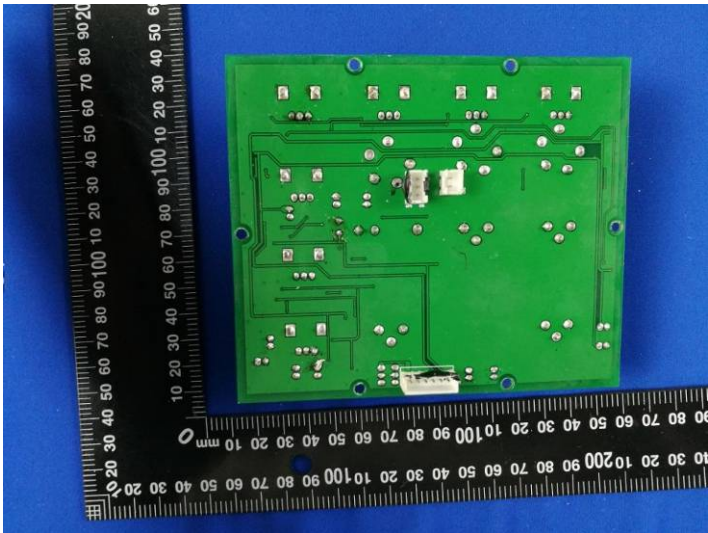

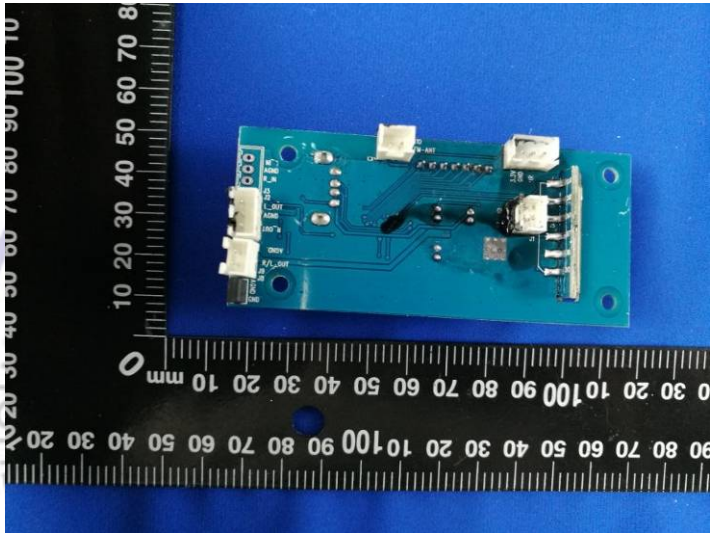
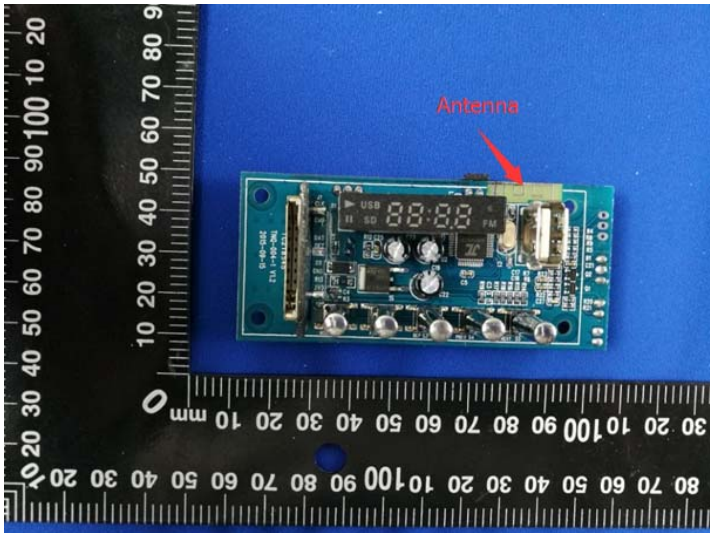

.....End of Report.....

