

## FCC CERTIFICATION TEST REPORT

### FOR

<b>Applicant</b>	:	ION Audio, LLC
<b>Address</b>	:	200 Scenic View Drive, Cumberland, RI 02864 U.S.A
<b>Equipment under Test</b>	:	High-Power All-Weather Speaker with Qi Wireless Charging
<b>Model No.</b>	:	PATHFINDER 4
<b>Project Code</b>	:	iPA125
<b>Trade Mark</b>	:	
<b>FCC ID</b>	:	2AB3E-IPA125
<b>Manufacturer</b>	:	ION Audio, LLC
<b>Address</b>	:	200 Scenic View Drive, Cumberland, RI 02864 U.S.A

**Issued By: Dongguan Dongdian Testing Service Co., Ltd.**

**Add:** No. 17, Zongbu Road 2, SongshanLakeSci&Tech, IndustryPark, Dongguan  
City, Guangdong Province, China, 523808

**Tel:** +86-0769-38826678, **E-mail:** ddt@dgddt.com, <http://www.dgddt.com>

# REPORT

## TABLE OF CONTENTS

	Test report declares.....	3
1	Summary of test results .....	5
2	General test information.....	6
2.1.	Description of EUT .....	6
2.2.	Accessories of EUT.....	7
2.3.	Assistant equipment used for test.....	7
2.4.	Block diagram of EUT configuration for test .....	7
2.5.	Deviations of test standard.....	7
2.6.	Test environment conditions .....	7
2.7.	Test laboratory .....	8
2.8.	Measurement uncertainty.....	8
3	Equipment used during test .....	9
4	20dB Bandwidth .....	10
4.1.	Block diagram of test setup.....	10
4.2.	Limits .....	10
4.3.	Test Procedure.....	10
4.4.	Test Result .....	10
4.5.	Original test data .....	11
5	Radiated emission.....	12
5.1.	Block diagram of test setup.....	12
5.2.	Limit.....	13
5.3.	Test Procedure.....	13
5.4.	Test result.....	14
6	Power Line Conducted Emission.....	17
6.1.	Block diagram of test setup.....	17
6.2.	Power Line Conducted Emission Limits .....	17
6.3.	Test Procedure.....	17
6.4.	Test Result .....	18
7	Antenna Requirements .....	21
8	Testsetupphotograph .....	22
9	Photos of the EUT .....	24

## TEST REPORT DECLARE

<b>Applicant</b>	:	ION Audio, LLC
<b>Address</b>	:	200 Scenic View Drive, Cumberland, RI 02864 U.S.A
<b>Equipment under Test</b>	:	High-Power All-Weather Speaker with Qi Wireless Charging
<b>Model No.</b>	:	PATHFINDER 4
<b>Trade Mark</b>	:	
<b>Manufacturer</b>	:	ION Audio, LLC
<b>Address</b>	:	200 Scenic View Drive, Cumberland, RI 02864 U.S.A

**Test Standard Used:**

FCC Rules and Regulations Part 15 Subpart C

**Test procedure used:**

ANSI C63.10:2013

**We Declare:**

The equipment described above is tested by Dongguan Dongdian Testing Service Co., Ltd and in the configuration tested the equipment complied with the standards specified above. The test results are contained in this test report and Dongguan Dongdian Testing Service Co., Ltd is assumed of full responsibility for the accuracy and completeness of these tests.

**After test and evaluation, our opinion is that the equipment provided for test compliance with the requirement of the above FCC standards.**

<b>Report No:</b>	DDT-R19112618-1E3		
<b>Date of Receipt:</b>	Dec. 10, 2019	<b>Date of Test:</b>	Dec. 10, 2019 ~ Feb. 27, 2020

**Prepared By:**

*Sam Li*

**Sam Li/Engineer**

**Approved By:**

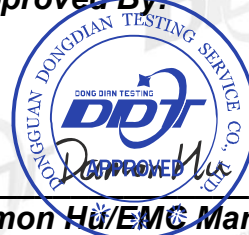

**Damon Hu/EMC Manager**

Note: This report applies to above tested sample only. This report shall not be reproduced in parts without written approval of Dongguan Dongdian Testing Service Co., Ltd.

## Revision history

Rev.	Revisions	Issue Date	Revised By
---	Initial issue	Feb. 27, 2020	

## 1 Summary of test results

Description of Test Item	Standard	Results
20dB Bandwidth	FCC Part 15: 15.215	PASS
Radiated Emission	FCC Part 15: 15.209	PASS
Power Line Conducted Emissions	FCC Part 15: 15.207	PASS
Antenna requirement	FCC Part 15: 15.203	PASS

## 2 General test information

### 2.1. Description of EUT

EUT* Name	: High-Power All-Weather Speaker with Qi Wireless Charging
Model Number	: PATHFINDER 4
EUT function description	: Please reference user manual of this device
Power supply	: AC 100-240V, 50/60Hz or DC 12V from built-in battery
Wireless charging Operation frequency	: 120kHz-205kHz
Antenna Type	: Inductive loop coil antenna
Sample Type	: Series production

Note: EUT is the ab. of equipment under test.

Channel information							
Channel	Frequency	Channel	Frequency	Channel	Frequency	Channel	Frequency
1	120kHz	23	142kHz	45	164kHz	67	186kHz
2	121kHz	24	143kHz	46	165kHz	68	187kHz
3	122kHz	25	144kHz	47	166kHz	69	188kHz
4	123kHz	26	145kHz	48	167kHz	70	189kHz
5	124kHz	27	146kHz	49	168kHz	71	190kHz
6	125kHz	28	147kHz	50	169kHz	72	191kHz
7	126kHz	29	148kHz	51	170kHz	73	192kHz
8	127kHz	30	149kHz	52	171kHz	74	193kHz
9	128kHz	31	150kHz	53	172kHz	75	194kHz
10	129kHz	32	151kHz	54	173kHz	76	195kHz
11	130kHz	33	152kHz	55	174kHz	77	196kHz
12	131kHz	34	153kHz	56	175kHz	78	197kHz
13	132kHz	35	154kHz	57	176kHz	79	198kHz
14	133kHz	36	155kHz	58	177kHz	80	199kHz
15	134kHz	37	156kHz	59	178kHz	81	200kHz
16	135kHz	38	157kHz	60	179kHz	82	201kHz
17	136kHz	39	158kHz	61	180kHz	83	202kHz
18	137kHz	40	159kHz	62	181kHz	84	203kHz
19	138kHz	41	160kHz	63	182kHz	85	204kHz
20	139kHz	42	161kHz	64	183kHz	86	205kHz
21	140kHz	43	162kHz	65	184kHz		
22	141kHz	44	163kHz	66	185kHz		

Note:

In section 15.31(m), regards to the operating frequency range less than 1 MHz, only one of channel was selected to perform the test.

Channel	Frequency (kHz)
Testing channel	130

## 2.2. Accessories of EUT

Description of Accessories	Manufacturer	Model number	Serial No.	Other
AC cable	N/A	N/A	N/A	Length: 1.8m, unshielded
Built-in Power Board	DONGGUAN CHENGUAN ELECTRONIC TECHNOLOGY CO., LTD.	EW72-160410 -L	Input: 100-240 Vac, 50/60Hz; Output: 16.0Vdc, 4.1A	Alternative
Built-in Power Board	Shenzhen Sunlight Electronic CO.,LTD	GO160041B	Input: 100-240 Vac, 50/60Hz; Output: 16.0Vdc, 4.1A	
Built-in Battery	JIANGXI HENGLI TECHNOLOGY BATTERY CO.,LTD.	CB7-12	12V7AH/20HR	Alternative
Built-in Battery	JIAHUA BATTERY (RUIJIN) CO., LTD	PL7-12	12V7AH	

## 2.3. Assistant equipment used for test

Assistant equipment	Manufacturer	Model number or Type	Serial No.	Other
Mobile phone	SAMSUNG	SM-G9600/DS	R28K331TTNF	N/A

## 2.4. Block diagram of EUT configuration for test



## 2.5. Deviations of test standard

No Deviation.

## 2.6. Test environment conditions

During the measurement the environmental conditions were within the listed ranges:

Temperature range:	21-25°C
Humidity range:	40-75%
Pressure range:	86-106kPa

## 2.7. Test laboratory

Dongguan Dongdian Testing Service Co., Ltd

Add: No. 17, Zongbu Road 2, Songshan Lake Sci&Tech, Industry Park, Dongguan City, Guangdong Province, China, 523808

Tel: +86-0769-38826678, <http://www.dgddt.com>, Email: [ddt@dgddt.com](mailto:ddt@dgddt.com)

CNAS Accreditation No. L6451; A2LA Accreditation No. 3870.01

FCC Designation Number: CN1182; FCC Test Firm Registration Number: 540522

Industry Canada site registration number: 10288A-1

## 2.8. Measurement uncertainty

Test Item	Uncertainty
Uncertainty for Conduction emission test	3.32dB (150kHz-30MHz)
	3.72dB (9kHz-150kHz)
Uncertainty for Radiation Emission test (30MHz-1GHz)	4.70 dB (Antenna Polarize: V)
	4.84 dB (Antenna Polarize: H)
Uncertainty for Radiation Emission test (1GHz to 18GHz)	4.10dB(1-6GHz)
	4.40dB (6GHz-18GHz)
Bandwidth	1.1%
Note: This uncertainty represents an expanded uncertainty expressed at approximately the 95% confidence level using a coverage factor of k=2.	



### 3 Equipment used during test

Equipment	Manufacturer	Model No.	Serial No.	Last Cal.	Cal. Interval
<b>RF Connected Test (Tonscend RF Measurement System)</b>					
Spectrum analyzer	R&S	FSU26	200071	Sep. 29, 2019	1 Year
Spectrum analyzer	R&S	FSU26	201124	Sep. 29, 2019	1 Year
Wideband Radio Communication tester	R&S	CMW500	117491	Jun. 25, 2019	1 Year
Vector Signal Generator	Agilent	E8267D	US49060192	Sep. 29, 2019	1 Year
Vector Signal Generator	Agilent	N5182A	MY48180737	Jun. 25, 2019	1 Year
Power Sensor	Agilent	U2021XA	MY55150010	Jun. 28, 2019	1 Year
Power Sensor	Agilent	U2021XA	MY55150011	Jun. 28, 2019	1 Year
Temp & Humi Programmable	ZHIXIANG	ZXGDJS-150L	ZX170110-A	Sep. 29, 2019	1 Year
Test Software	JS Tonscent	JS1120-3	Ver.2.7	N/A	N/A
USB Data acquisition	Agilent	U2531A	TW55043503	N/A	N/A
<b>Radiated Emission Test Chamber 1#</b>					
EMI Test Receiver	R&S	ESU8	100316	Sep. 29, 2019	1 Year
Spectrum analyzer	Agilent	E4447A	MY50180031	Jun. 25, 2019	1 Year
Trilog Broadband Antenna	Schwarzbeck	VULB9163	9163-462	Nov. 15, 2019	1 Year
Active Loop antenna	Schwarzbeck	FMZB-1519	1519-038	Sep. 29, 2019	1 Year
Double Ridged Horn Antenna	R&S	HF907	100276	Nov. 15, 2019	1 Year
Broad Band Horn Antenna	Schwarzbeck	BBHA 9170	790	Sep. 29, 2019	1 Year
Pre-amplifier	TERA-MW	TRLA-0040 G35	101303	Sep. 29, 2019	1 Year
RF Cable	HUBSER	CP-X2+ CP-X1	W11.03+ W12.02	Sep. 29, 2019	1 Year
RF Cable	N/A	SMAJ-SMAJ -1M+11M	17070133+17070131	Sep. 29, 2019	1 Year
Test software	Audix	E3	V 6.11111b	N/A	N/A
<b>Power Line Conducted Emissions Test</b>					
Test Receiver	R&S	ESU8	100316	Sep. 29, 2019	1 Year
LISN 1	R&S	ENV216	101109	Sep. 29, 2019	1 Year
LISN 2	R&S	ESH2-Z5	100309	Sep. 29, 2019	1 Year
Pulse Limiter	R&S	ESH3-Z2	101242	Sep. 29, 2019	1 Year
CE Cable 1	HUBSER	ESU8/RF2	W10.01	Sep. 29, 2019	1 Year
Test software	Audix	E3	V 6.11111b	N/A	N/A

## 4 20dB Bandwidth

### 4.1. Block diagram of test setup

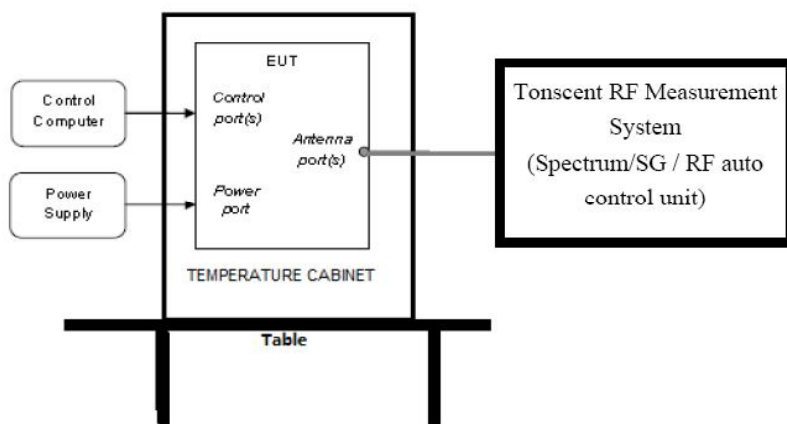

### 4.2. Limits

Intentional radiators operating under the alternative provisions to the general emission limits, as contained in § 15.217 through 15.257 and in Subpart E of this part, must be designed to ensure that the 20 dB bandwidth of the emission, or whatever bandwidth may otherwise be specified in the specific rule section under which the equipment operates, is contained within the frequency band designated in the rule section under which the equipment is operated.

### 4.3. Test Procedure

- (1) Connect EUT's antenna output to spectrum analyzer by RF cable.
- (2) The bandwidth of the fundamental frequency was measured by spectrum analyzer with 10 Hz RBW and 30Hz VBW. The 20dB bandwidth is defined as the total spectrum the power of which is higher than peak power minus 20dB.

### 4.4. Test Result

Freq. (kHz)	20dB bandwidth Result (Hz)	Conclusion
130	65	PASS

### 4.5. Original test data

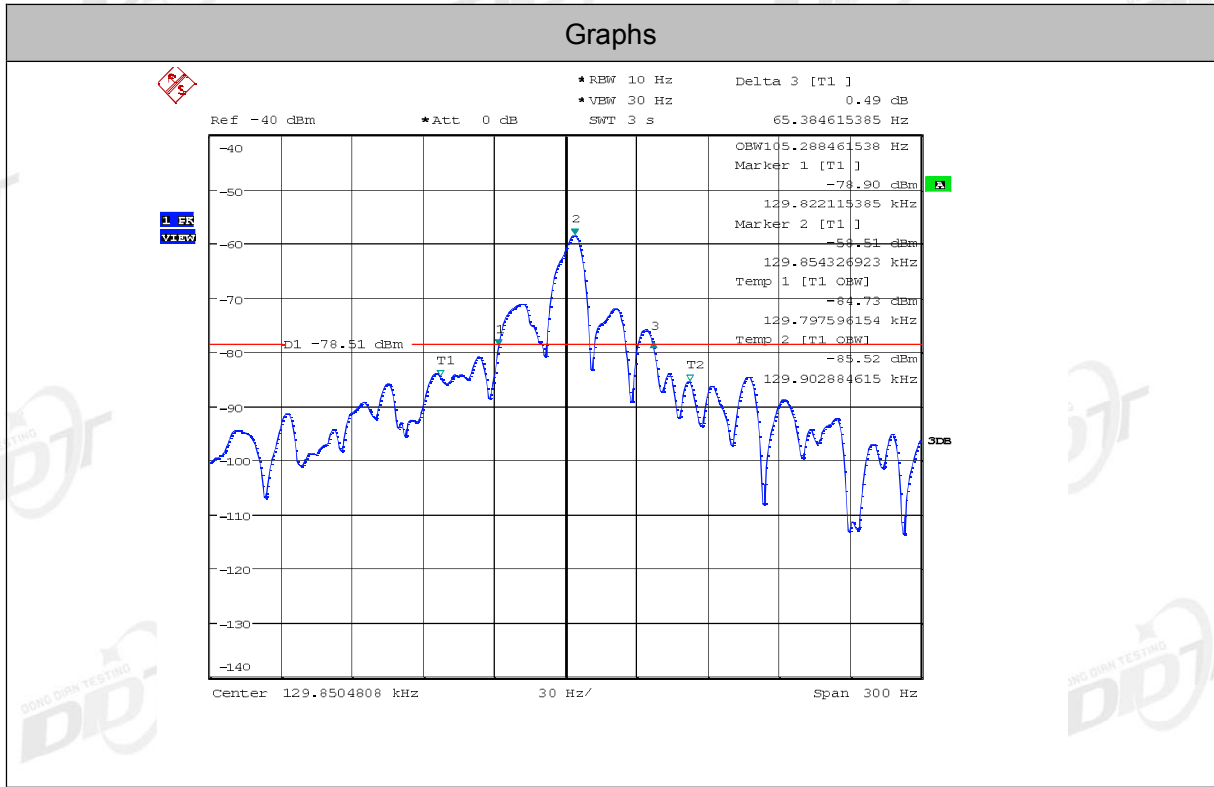

## 5 Radiated emission

### 5.1. Block diagram of test setup

In 3m Anechoic Chamber Test Setup Diagram for 9kHz~30MHz

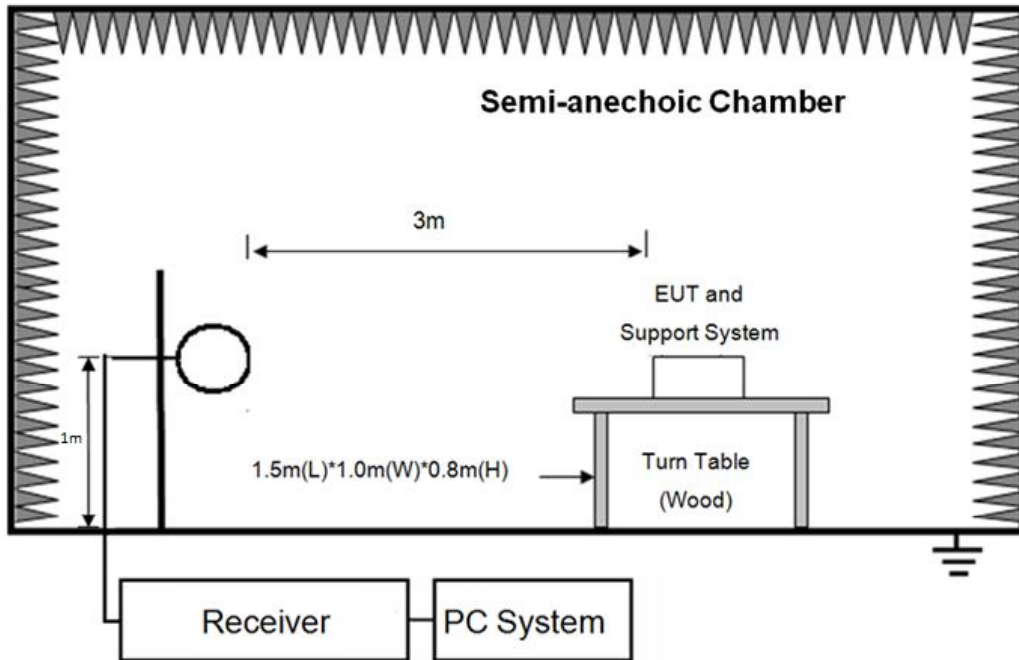

In 3m Anechoic Chamber Test Setup Diagram for 30MHz~1GHz

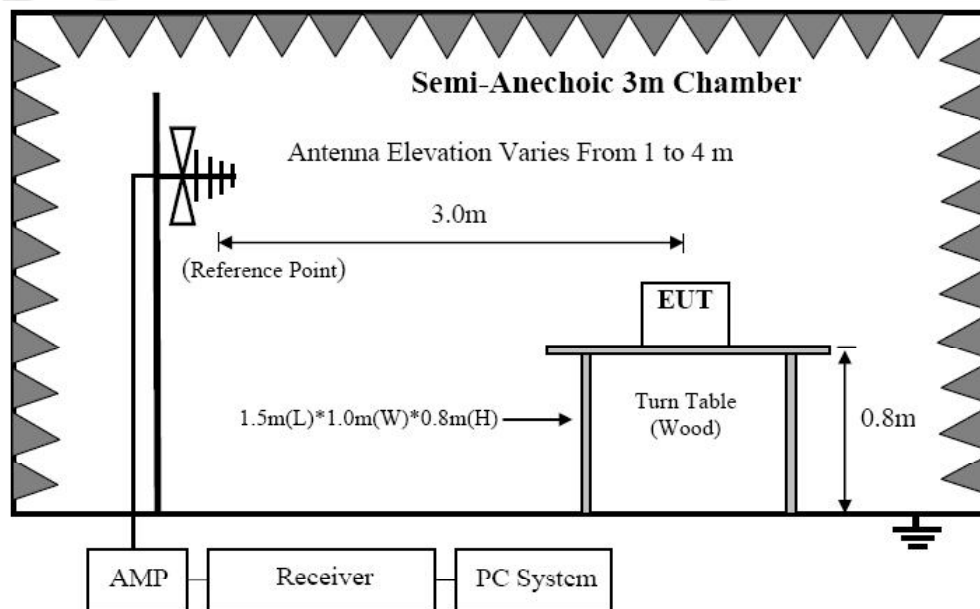

## 5.2. Limit

FREQUENCY MHz	DISTANCE Meters	FIELD STRENGTHS LIMIT	
		$\mu\text{V}/\text{m}$	$\text{dB}(\mu\text{V})/\text{m}$
0.009 ~ 0.490	300	2400/F(kHz)	67.6-20log(F)
0.490 ~ 1.705	30	24000/F(kHz)	87.6-20log(F)
1.705 ~ 30.0	30	30	29.54
30 ~ 88	3	100	40.0
88 ~ 216	3	150	43.5
216 ~ 960	3	200	46.0
960 ~ 1000	3	500	54.0

Note: (1) The emission limits shown in the above table are based on measurements employing a CISPR QP detector except for the frequency bands 9-90kHz, 110-490kHz and above 1000MHz. Radiated emissions limits in these three bands are based on measurements employing an average detector.

(2) At frequencies below 30MHz, measurement may be performed at a distance closer than that specified, and the limit at closer measurement distance can be extrapolated by below formula:

$$\text{Limit}_{3\text{m}}(\text{dBuV}/\text{m}) = \text{Limit}_{300\text{m}}(\text{dBuV}/\text{m}) + 40\text{Log}(300\text{m}/3\text{m}) = \text{Limit}_{300\text{m}}(\text{dBuV}/\text{m}) + 80$$

$$\text{Limit}_{3\text{m}}(\text{dBuV}/\text{m}) = \text{Limit}_{30\text{m}}(\text{dBuV}/\text{m}) + 40\text{Log}(30\text{m}/3\text{m}) = \text{Limit}_{30\text{m}}(\text{dBuV}/\text{m}) + 40$$

## 5.3. Test Procedure

(1) EUT was placed on a non-metallic table, 80 cm above the ground plane inside a semi-anechoic chamber.

(2) Test antenna was located 3m from the EUT on an adjustable mast, and the antenna used as below table.

Test frequency range	Test antenna used	Test antenna distance
9kHz-30MHz	Active Loop antenna	3m
30MHz-1GHz	Trilog Broadband Antenna	3m

According ANSI C63.10:2013 clause 6.4.4.2 and 6.5.3, for measurements below 30 MHz, the loop antenna was positioned with its plane vertical from the EUT and rotated about its vertical axis for maximum response at each azimuth position around the EUT. And the loop antenna also be positioned with its plane horizontal at the specified distance from the EUT. The center of the loop is 1 m above the ground. For measurement above 30MHz, the Trilog Broadband Antenna or Horn Antenna was located 3m from EUT, Measurements were made with the antenna positioned in both the horizontal and vertical planes of Polarization, and the measurement antenna was varied from 1 m to 4 m. in height above the reference ground plane to obtain the maximum signal strength.

(3) Below pre-scan procedure was first performed in order to find prominent frequency spectrum radiated emissions from 9kHz to 1GHz:

(a) Scanning the peak frequency spectrum with the antenna specified in step (3), and the EUT was rotated 360 degree, the antenna height was varied from 1m to 4m(Except loop antenna, it's

fixed 1m above ground.)

(b) Change work frequency or channel of device if practicable.

(c) Change modulation type of device if practicable.

(d) Rotated EUT though three orthogonal axes to determine the attitude of EUT arrangement produces highest emissions. Spectrum frequency from 9kHz to 1GHz (tenth harmonic of fundamental frequency) was investigated.

(4) For final emissions measurements at each frequency of interest, the EUT was rotated and the antenna height was varied between 1m and 4m in order to maximize the emission. Measurements in both horizontal and vertical polarities were made and the data was recorded. In order to find the maximum emission, the relative positions of equipments and all of the interface cables were changed according to ANSI C63.10:2013 on Radiated Emission test.

(5) The emissions from 9kHz to 1GHz were measured based on CISPR QP detector except for the frequency bands 9-90kHz, 110-490kHz, for emissions from 9kHz-90kHz, 110kHz-490kHz and above 1GHz were measured based on average detector, for emissions above 1GHz, peak emissions also be measured and need comply with Peak limit.

(6) The emissions from 9kHz to 1GHz, QP or average values were measured with EMI receiver with below RBW.

Frequency band	RBW
9kHz-150kHz	200Hz
150kHz-30MHz	9kHz
30MHz-1GHz	120kHz

#### 5.4. Test result

**PASS. (See below detailed test result)**

##### Below 30MHz:

Frequency (MHz)	Result@3m (dBuV/m)	Limit @3m (dBuV/m)	Detector	Conclusion
0.02	77.09	141.58	Peak	PASS
0.02	71.52	121.58	Average	PASS
0.130	97.46	125.33	Peak	PASS
0.130	90.78	105.33	Average	PASS
0.39	76.85	115.78	Peak	PASS
0.39	70.20	95.78	Average	PASS
0.42	74.51	115.14	Peak	PASS
0.42	68.36	95.14	Average	PASS
0.50	67.74	73.62	QP	PASS
0.70	65.84	70.70	QP	PASS

Above 30MHz:

# TR-4-E-009 Radiated Emission Test Result

**Test Site** : DDT 3m Chamber 1#  
**Test Date** : 2020-02-13  
**EUT** : High-Power All-Weather Speaker with Qi Wireless Charging  
**Power Supply** : AC 120V/60Hz  
**Condition** : Temp:24.5°C,Humi:55%,Press:100.1kPa  
**Memo** :

**D:\2019 RE1# Report Data\Q19112618-1E IPA125\FCC BELOW1G.EM6**  
**Tested By** : Talent  
**Model Number** : PATHFINDER 4  
**Test Mode** : Tx mode  
**Antenna/Distance** : 2019 VULB 9163 1#/3m/VERTICAL

Data: 1

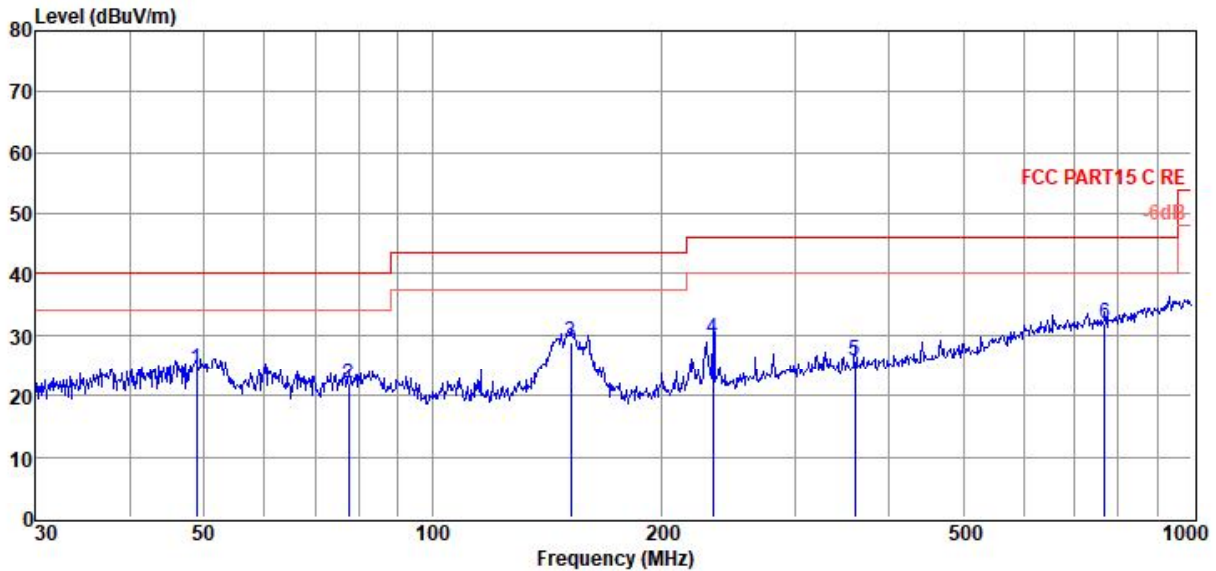

Item (Mark)	Freq. (MHz)	Read Level (dBμV)	Antenna Factor (dB/m)	Cable Loss (dB)	Result Level (dBμV/m)	Limit Line (dBμV/m)	Over Limit (dB)	Detector	Polarization
1	48.84	6.28	14.15	3.98	24.41	40.00	-15.59	QP	VERTICAL
2	77.59	8.64	9.21	4.23	22.08	40.00	-17.92	QP	VERTICAL
3	152.13	15.66	8.39	4.75	28.80	43.50	-14.70	QP	VERTICAL
4	234.17	11.64	12.45	5.21	29.30	46.00	-16.70	QP	VERTICAL
5	360.45	5.29	14.87	5.80	25.96	46.00	-20.04	QP	VERTICAL
6	768.75	4.11	20.46	7.28	31.85	46.00	-14.15	QP	VERTICAL

- Note: 1. Result Level = Read Level + Antenna Factor + Cable loss.  
 2. If Peak Result complies with QP limit, QP Result is deemed to comply with QP limit.  
 3. Test setup: RBW: 120 kHz, VBW: 300 kHz, Sweep time: auto.

# TR-4-E-009 Radiated Emission Test Result

**Test Site** : DDT 3m Chamber 1# D:\2019 RE1# Report Data\Q19112618-1E IPA125\FCC BELOW1G.EM6  
**Test Date** : 2020-02-13 **Tested By** : Talent  
**EUT** : High-Power All-Weather Speaker with Qi **Model Number** : PATHFINDER 4  
           : Wireless Charging **Test Mode** : Tx mode  
**Power Supply** : AC 120V/60Hz **Antenna/Distance** : 2019 VULB 9163 1#/3m/HORIZONTAL  
**Condition** : Temp:24.5'C,Humi:55%,Press:100.1kPa  
**Memo** :

Data: 2

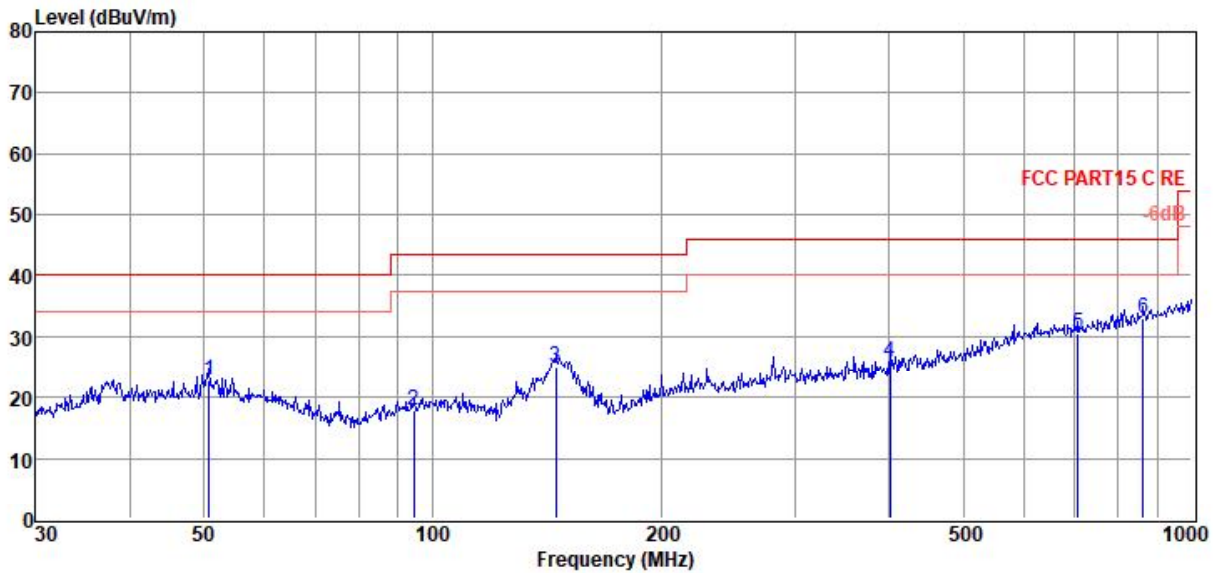

Item (Mark)	Freq. (MHz)	Read Level (dBuV)	Antenna Factor (dB/m)	Cable Loss (dB)	Result Level (dBuV/m)	Limit Line (dBuV/m)	Over Limit (dB)	Detector	Polarization
1	50.76	4.58	14.10	4.00	22.68	40.00	-17.32	QP	HORIZONTAL
2	94.43	2.16	11.36	4.37	17.89	43.50	-25.61	QP	HORIZONTAL
3	145.35	11.95	8.39	4.71	25.05	43.50	-18.45	QP	HORIZONTAL
4	400.43	4.63	15.31	5.96	25.90	46.00	-20.10	QP	HORIZONTAL
5	709.18	3.36	19.98	7.11	30.45	46.00	-15.55	QP	HORIZONTAL
6	863.06	3.98	21.41	7.57	32.96	46.00	-13.04	QP	HORIZONTAL

- Note: 1. Result Level = Read Level + Antenna Factor + Cable loss.  
 2. If Peak Result complies with QP limit, QP Result is deemed to comply with QP limit.  
 3. Test setup: RBW: 120 kHz, VBW: 300 kHz, Sweep time: auto.



## 6 Power Line Conducted Emission

### 6.1. Block diagram of test setup

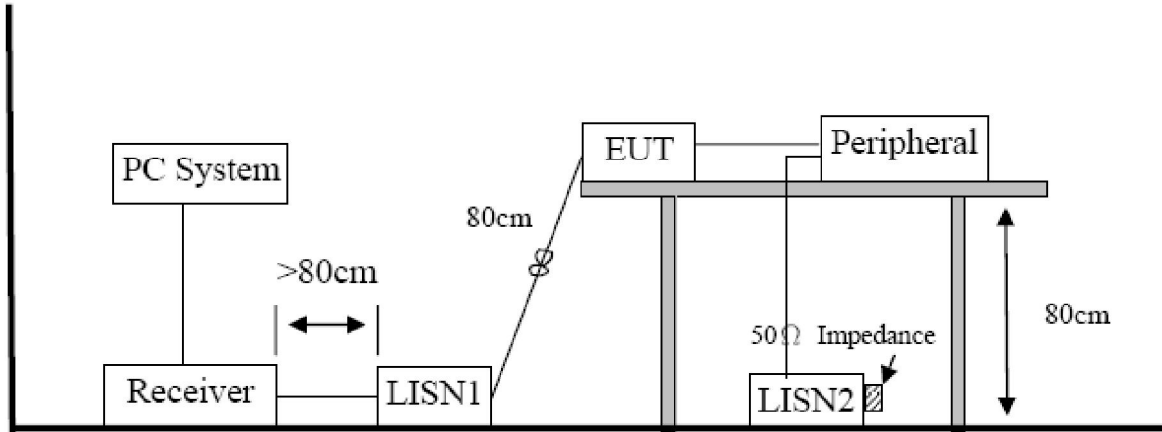

### 6.2. Power Line Conducted Emission Limits

Frequency	Quasi-Peak Level dB( $\mu$ V)	Average Level dB( $\mu$ V)
150kHz ~ 500kHz	66 ~ 56*	56 ~ 46*
500kHz ~ 5MHz	56	46
5MHz ~ 30MHz	60	50

Note 1: \* Decreasing linearly with logarithm of frequency.

Note 2: The lower limit shall apply at the transition frequencies.

### 6.3. Test Procedure

The EUT and Support equipment, if needed, were put placed on a non-metallic table, 80cm above the ground plane.

Configuration EUT to simulate typical usage as described in clause 2.4 and test equipment as described in clause 10.2 of this report.

All I/O cables were positioned to simulate typical actual usage as per ANSI C63.10.

All support equipment power received from a second LISN.

Emissions were measured on each current carrying line of the EUT using an EMI Test Receiver connected to the LISN powering the EUT.

The Receiver scanned from 150 kHz to 30MHz for emissions in each of the test modes.

During the above scans, the emissions were maximized by cable manipulation.

The test mode(s) described in clause 2.4 were scanned during the preliminary test.

After the preliminary scan, we found the test mode producing the highest emission level.

The EUT configuration and worse cable configuration of the above highest emission levels were recorded for reference of the final test.

EUT and support equipment were set up on the test bench as per the configuration with highest emission level in the preliminary test.

A scan was taken on both power lines, Neutral and Line, recording at least the six highest emissions.

Emission frequency and amplitude were recorded into a computer in which correction factors were used to calculate the emission level and compare reading to the applicable limit.

The test data of the worst-case condition(s) was recorded.

The bandwidth of test receiver is set at 9 kHz.

#### 6.4. Test Result

**PASS. (See below detailed test result)**

Note1: All emissions not reported below are too low against the prescribed limits.

Note2: "----" means Peak detection; "----" means Average detection.

Note3: Pre-test AC conducted emission at both voltage AC 120V/60Hz and AC 240V/60Hz, recorded worse case.

# TR-4-E-010 Conducted Emission Test Result

**Test Site** : DDT 1# Shield Room D:\2019 CE report data\Q19112618-1E\20200113 CE.EM6  
**Test Date** : 2020-01-13 **Tested By** : Telamon  
**EUT** : High-Power All-Weather Speaker with Qi Wireless Charging **Model Number** : PATHFINDER 4  
**Power Supply** : AC 120V/60Hz **Test Mode** : Tx mode  
**Condition** : Temp:24.5°C,Humi:55.5%, Press:100.1kPa **LISN** : 2019 ENV216 1#/NEUTRAL  
**Memo** :

Data: 27

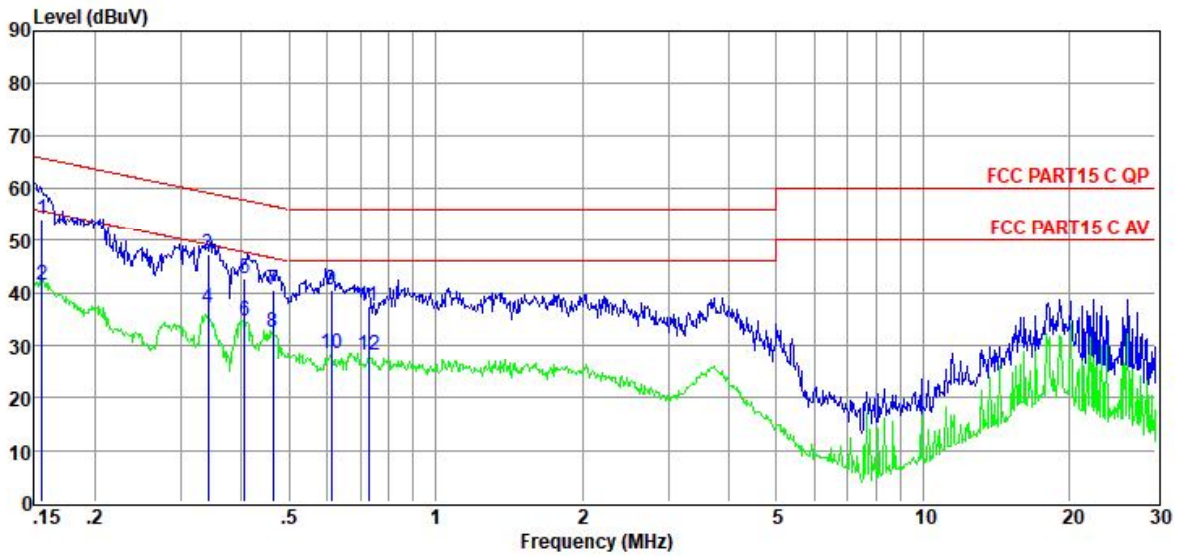

Item	Freq.	Read Level	LISN Factor	Cable Loss	Pulse Limiter Factor	Result Level	Limit Line	Over Limit	Detector	Phase
(Mark)	(MHz)	(dBμV)	(dB)	(dB)	(dB)	(dBμV)	(dBμV)	(dB)		
1	0.16	34.66	9.60	0.01	9.86	54.13	65.69	-11.56	QP	NEUTRAL
2	0.16	22.02	9.60	0.01	9.86	41.49	55.69	-14.20	Average	NEUTRAL
3	0.34	27.93	9.60	0.02	9.86	47.41	59.18	-11.77	QP	NEUTRAL
4	0.34	17.50	9.60	0.02	9.86	36.98	49.18	-12.20	Average	NEUTRAL
5	0.41	23.35	9.60	0.02	9.86	42.83	57.73	-14.90	QP	NEUTRAL
6	0.41	15.17	9.60	0.02	9.86	34.65	47.73	-13.08	Average	NEUTRAL
7	0.46	21.17	9.60	0.02	9.86	40.65	56.63	-15.98	QP	NEUTRAL
8	0.46	12.86	9.60	0.02	9.86	32.34	46.63	-14.29	Average	NEUTRAL
9	0.61	21.06	9.60	0.03	9.86	40.55	56.00	-15.45	QP	NEUTRAL
10	0.61	9.04	9.60	0.03	9.86	28.53	46.00	-17.47	Average	NEUTRAL
11	0.73	18.02	9.60	0.03	9.86	37.51	56.00	-18.49	QP	NEUTRAL
12	0.73	8.57	9.60	0.03	9.86	28.06	46.00	-17.94	Average	NEUTRAL

- Note: 1. Result Level = Read Level + LISN Factor + Pulse LimiterFactor + Cable loss.  
 2. If QP Result complies with AV limit, AV Result is deemed to comply with AV limit.  
 3. Test setup: RBW: 200 Hz (9 kHz—150 kHz), 9 kHz (150 kHz—30 MHz).  
 4. Step size: 80Hz (0.009MHz-0.15MHz), 4 kHz (0.15MHz-30MHz), Scan time: auto.

# TR-4-E-010 Conducted Emission Test Result

**Test Site** : DDT 1# Shield Room D:\2019 CE report data\Q19112618-1E\20200113 CE.EM6  
**Test Date** : 2020-01-13 **Tested By** : Telamon  
**EUT** : High-Power All-Weather Speaker with Qi Wireless Charging **Model Number** : PATHFINDER 4  
**Power Supply** : AC 120V/60Hz **Test Mode** : Tx mode  
**Condition** : Temp:24.5°C,Humi:55.5%, Press:100.1kPa **LISN** : 2019 ENV216 1#/LINE  
**Memo** :

Data: 28

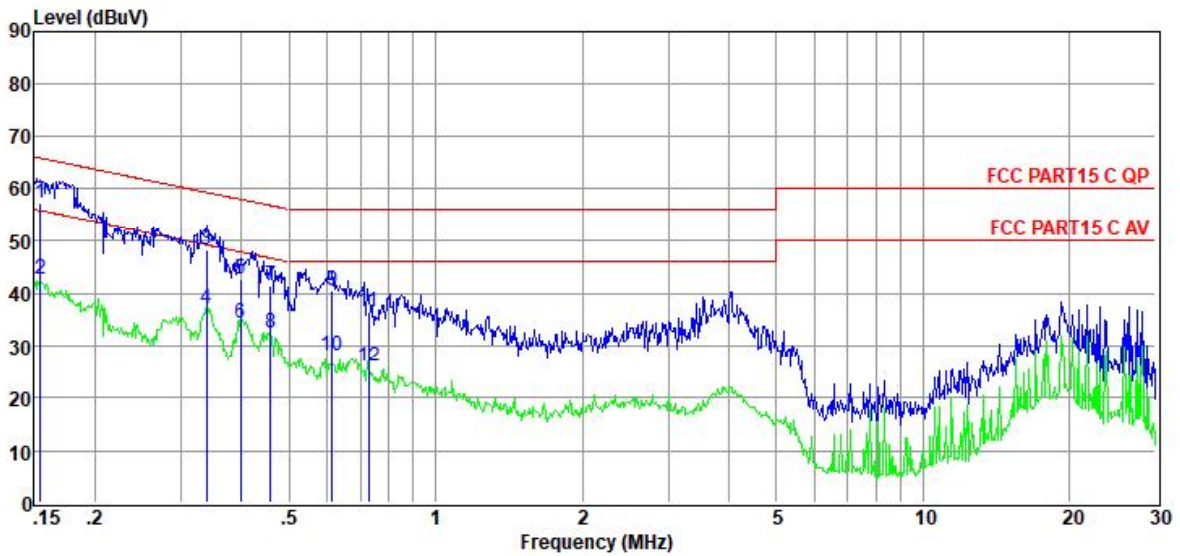

Item (Mark)	Freq. (MHz)	Read Level (dBμV)	LISN Factor (dB)	Cable Loss (dB)	Pulse Limiter Factor (dB)	Result Level (dBμV)	Limit Line (dBμV)	Over Limit (dB)	Detector	Phase
1	0.15	37.72	9.60	0.01	9.86	57.19	65.74	-8.55	QP	LINE
2	0.15	23.13	9.60	0.01	9.86	42.60	55.74	-13.14	Average	LINE
3	0.34	28.66	9.60	0.02	9.86	48.14	59.22	-11.08	QP	LINE
4	0.34	17.68	9.60	0.02	9.86	37.16	49.22	-12.06	Average	LINE
5	0.40	23.16	9.60	0.02	9.86	42.64	57.90	-15.26	QP	LINE
6	0.40	14.89	9.60	0.02	9.86	34.37	47.90	-13.53	Average	LINE
7	0.46	21.84	9.60	0.02	9.86	41.32	56.71	-15.39	QP	LINE
8	0.46	12.92	9.60	0.02	9.86	32.40	46.71	-14.31	Average	LINE
9	0.61	21.10	9.60	0.03	9.86	40.59	56.00	-15.41	QP	LINE
10	0.61	8.60	9.60	0.03	9.86	28.09	46.00	-17.91	Average	LINE
11	0.73	16.88	9.60	0.03	9.86	36.37	56.00	-19.63	QP	LINE
12	0.73	6.51	9.60	0.03	9.86	26.00	46.00	-20.00	Average	LINE

- Note: 1. Result Level = Read Level + LISN Factor + Pulse LimiterFactor + Cable loss.  
 2. If QP Result complies with AV limit, AV Result is deemed to comply with AV limit.  
 3. Test setup: RBW: 200 Hz (9 kHz—150 kHz), 9 kHz (150 kHz—30 MHz).  
 4. Step size: 80Hz (0.009MHz-0.15MHz), 4 kHz (0.15MHz-30MHz), Scan time: auto.

## 7 Antenna Requirements

For intentional device, according to FCC 47 CFR Section 15.203, An intentional radiator shall be designed to ensure that no antenna other than that furnished by the responsible party shall be used with the device. The use of a permanently attached antenna or of an antenna that uses a unique coupling to the intentional radiator shall be considered sufficient to comply with the provisions of this section. The manufacturer may design the unit so that a broken antenna can be replaced by the user, but the use of a standard antenna jack or electrical connector is prohibited.

The antenna used for this product is Inductive loop coil antenna.