



FCC AND ISED CERTIFICATION TEST REPORT

Applicant	:	ION Audio LLC
Address of Applicant	:	200 Scenic View Drive, Cumberland, RI 02864, U.S.A.
Manufacturer	:	ION Audio LLC
Address of Manufacturer	:	200 Scenic View Drive, Cumberland, RI 02864, U.S.A.
Equipment under Test	:	BATTERY-POWERED PORTABLE SPEAKER SYSTEM WITH MULTI-CHANNEL MIXER AND LIGHTS
Model No.	:	TROUPER™ 300
Project Code	:	iPA118C
FCC ID	:	2AB3E-IPA118C
IC	:	10541A-IPA118C
Test Standard(s)	:	FCC Rules and Regulations Part 15 Subpart C, RSS-247 Issue 3 August 2023, ANSI C63.10:2013, RSS-Gen Issue 5, Apr. 2018, Amendment 2 (February 2021)
Report No.	:	DDT-RE24031501-2E01
Issue Date	:	2024/08/07
Issue By	:	Guangdong Dongdian Testing Service Co., Ltd. Unit 2, Building 1, No. 17, Zongbu 2nd Road, Songshan Lake Park, Dongguan, Guangdong, China, 523808

Table of Contents

1.	Summary of Test Results	7
2.	General Test Information	8
2.1.	Description of EUT	8
2.2.	Accessories of EUT	9
2.3.	Block diagram of EUT configuration for test.....	9
2.4.	Decision of final test mode	9
2.5.	Deviations of test standard	10
2.6.	Test environment conditions.....	10
2.7.	Test laboratory	10
2.8.	Measurement uncertainty	11
3.	Equipment Used During Conductive Test	12
4.	20 dB Bandwidth.....	13
4.1.	Block diagram of test setup	13
4.2.	Limits.....	13
4.3.	Test procedure.....	13
4.4.	Test result	14
4.5.	Test graphs	15
5.	99% Bandwidth	18
5.1.	Block diagram of test setup	18
5.2.	Limits.....	18
5.3.	Test procedure.....	18
5.4.	Test result	19
5.5.	Test graphs	20
6.	Maximum Peak Output Power.....	23
6.1.	Block diagram of test setup	23
6.2.	Limits.....	23
6.3.	Test procedure.....	23
6.4.	Test result	24
6.5.	Test graphs	25
7.	Carrier Frequency Separation	28
7.1.	Block diagram of test setup	28
7.2.	Limits.....	28
7.3.	Test procedure.....	28
7.4.	Test result	29
7.5.	Test graphs	29
8.	Dwell Time	31

8.1.	Block diagram of test setup	31
8.2.	Limits.....	31
8.3.	Test procedure.....	31
8.4.	Test result	32
8.5.	Test graphs.....	33
9.	Number of Hopping Channel.....	39
9.1.	Block diagram of test setup	39
9.2.	Limits.....	39
9.3.	Test procedure.....	39
9.4.	Test result	40
9.5.	Test graphs.....	41
10.	Band Edge Compliance (Conducted Method).....	42
10.1.	Block diagram of test setup	42
10.2.	Limit.....	42
10.3.	Test procedure.....	42
10.4.	Test result	43
10.5.	Test graphs.....	44
11.	RF Conducted Spurious Emissions.....	48
11.1.	Block diagram of test setup	48
11.2.	Limits.....	48
11.3.	Test procedure.....	48
11.4.	Test result	48
11.5.	Test graphs.....	49
12.	Duty cycle	59
12.1.	Block diagram of test setup	59
12.2.	Limit.....	59
12.3.	Test procedure.....	59
12.4.	Test result	60
12.5.	Test graphs.....	61
13.	Antenna Requirements.....	64
13.1.	Limit.....	64
13.2.	Result.....	64
14.	Radiated Emission.....	65
14.1.	Test equipment.....	65
14.2.	Block diagram of test setup	66
14.3.	Limits.....	67
14.4.	Assistant equipment used for test	69
14.5.	Test procedure.....	69

14.6.	Test result	70
14.7.	Test data	71
15.	Band Edge Compliance	79
15.1.	Test equipment	79
15.2.	Block diagram of test setup	80
15.3.	Limits.....	80
15.4.	Assistant equipment used for test	80
15.5.	Test procedure.....	80
15.6.	Test result	80
15.7.	Test data	81
16.	Power Line Conducted Emissions.....	93
16.1.	Test equipment	93
16.2.	Block diagram of test setup	93
16.3.	Limits.....	93
16.4.	Assistant equipment used for test	93
16.5.	Test procedure.....	94
16.6.	Test result	94
16.7.	Test data	95
17.	Test Setup Photograph.....	97
18.	Photos of the EUT	99

Test Report Declare

Applicant	:	ION Audio LLC
Address of Applicant	:	200 Scenic View Drive, Cumberland, RI 02864, U.S.A.
Equipment under Test	:	BATTERY-POWERED PORTABLE SPEAKER SYSTEM WITH MULTI-CHANNEL MIXER AND LIGHTS
Model No.	:	TROUPER™ 300
Manufacturer	:	ION Audio LLC
Address of Manufacturer	:	200 Scenic View Drive, Cumberland, RI 02864, U.S.A.

Test Standard Used:

FCC Rules and Regulations Part 15 Subpart C,
 RSS-247 Issue 3 August 2023,
 ANSI C63.10:2013,
 RSS-Gen Issue 5, Apr. 2018, Amendment 2 (February 2021)

We Declare:

The equipment described above is tested by Guangdong Dongdian Testing Service Co., Ltd. and in the configuration tested the equipment complied with the standards specified above. The test results are contained in this test report and Guangdong Dongdian Testing Service Co., Ltd. is assumed of full responsibility for the accuracy and completeness of these tests.

Report No.:	DDT-RE24031501-2E01		
Date of Receipt:	2024/06/06	Date of Test:	2024/06/06~2024/08/07

Prepared By:

Johnson Huang

Johnson Huang/Engineer

Approved By:

Damon Hu

Damon Hu/EMC Manager

Note: This report applies to above tested sample only. This report shall not be reproduced in parts without written approval of Guangdong Dongdian Testing Service Co., Ltd.

Revision History

Rev.	Revisions	Issue Date	Revised By
---	Initial issue	2024/08/07	

1. Summary of Test Results

No.	Test Parameter	Clause No.	Condition	Result
1	Maximum Peak Output Power	FCC Part 15: 15.247(b)(1), RSS-247 Issue 3 clause 5.4(b)	/	Pass
2	20 dB Bandwidth	FCC Part 15: 15.247(a)(1), RSS-247 Issue 3 clause 5.1(a)	/	Pass
3	99% Bandwidth	RSS-Gen Issue 5 clause 6.7	/	Pass
4	Carrier Frequency Separation	FCC Part 15: 15.247(a)(1), RSS-247 Issue 3 clause 5.1(b)	/	Pass
5	Number of Hopping Channel	FCC Part 15: 15.247(a)(1)(iii), RSS-247 Issue 3 clause 5.1(d)	/	Pass
6	Dwell Time	FCC Part 15: 15.247(a)(1)(iii), RSS-247 Issue 3 clause 5.1(d)	/	Pass
7	RF Conducted Spurious Emissions	FCC Part 15: 15.247(d), RSS- 247 Issue 3 clause 5.5	/	Pass
8	Radiated Emission	FCC Part 15: 15.205, FCC Part 15: 15.209, FCC Part 15: 15.247(d), RSS-247 Issue 3 clause 5.5, RSS-Gen Issue 5 clause 8.9, RSS-Gen Issue 5 clause 8.10	/	Pass
9	Band Edge Compliance	FCC Part 15: 15.205, FCC Part 15: 15.209, FCC Part 15: 15.247(d), RSS-247 Issue 3 clause 5.5, RSS-Gen Issue 5 clause 8.9, RSS-Gen Issue 5 clause 8.10	/	Pass
10	Antenna Requirement	FCC Part 15: 15.203, RSS- Gen Issue 5 clause 6.8	/	Pass
11	Power Line Conducted Emissions	FCC Part 15: 15.207(a), RSS- Gen Issue 5 clause 8.8	/	Pass

Note: N/A is an abbreviation for Not Applicable, and means this item is not applicable for this device or no need to test according to standard.

2. General Test Information

2.1. Description of EUT

EUT Name	: BATTERY-POWERED PORTABLE SPEAKER SYSTEM WITH MULTI-CHANNEL MIXER AND LIGHTS
Model Number	: TROUPER™ 300
EUT Function Description	: Please reference user manual of this device
Power Supply	: AC 100-240V, 50/60Hz or DC 12V from Battery

Note: This EUT support Bluetooth BR/EDR/LE, this report only for Bluetooth BR/EDR.

Radio Specification	: Bluetooth BR/EDR
Operation Frequency	: 2402 MHz-2480 MHz
Modulation	: GFSK, $\pi/4$ -DQPSK, 8DPSK

Antenna information	
Antenna Type	: FPC
Max Antenna Gain(dBi)	: 3.2

Channel information					
Channel	Frequency (MHz)	Channel	Frequency (MHz)	Channel	Frequency (MHz)
0	2402	27	2429	54	2456
1	2403	28	2430	55	2457
2	2404	29	2431	56	2458
3	2405	30	2432	57	2459
4	2406	31	2433	58	2460
5	2407	32	2434	59	2461
6	2408	33	2435	60	2462
7	2409	34	2436	61	2463
8	2410	35	2437	62	2464
9	2411	36	2438	63	2465
10	2412	37	2439	64	2466
11	2413	38	2440	65	2467
12	2414	39	2441	66	2468
13	2415	40	2442	67	2469
14	2416	41	2443	68	2470
15	2417	42	2444	69	2471
16	2418	43	2445	70	2472
17	2419	44	2446	71	2473
18	2420	45	2447	72	2474
19	2421	46	2448	73	2475
20	2422	47	2449	74	2476

21	2423	48	2450	75	2477
22	2424	49	2451	76	2478
23	2425	50	2452	77	2479
24	2426	51	2453	78	2480
25	2427	52	2454		
26	2428	53	2455		

Note: The above EUT information is declared by manufacturer and for more detailed features description please refer to the manufacturer's specifications or User's Manual. The above Antenna information is declared by manufacturer and for more detailed features description please refer to the manufacturer's specifications, the laboratory shall not be held responsible.

“☑” means to be chosen or applicable; “☐” means don't to be chosen or not applicable; This note applies to entire report.

2.2. Accessories of EUT

Accessories	Manufacturer	Model number	Description
/	/	/	/

2.3. Block diagram of EUT configuration for test

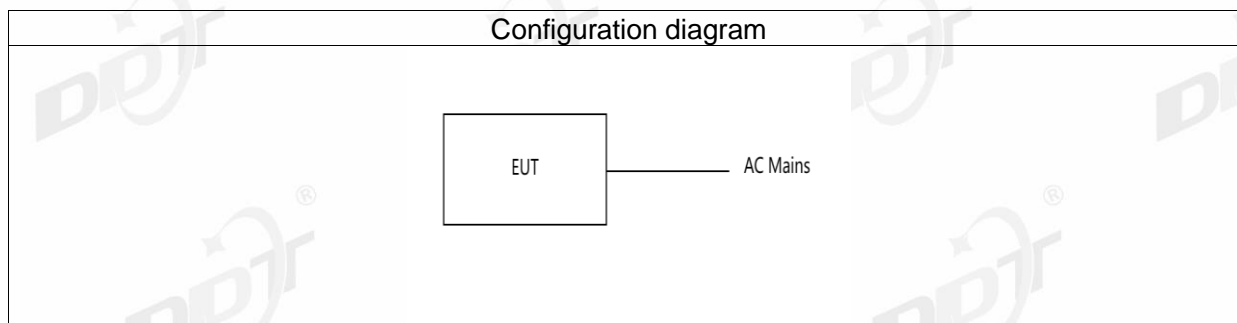

2.4. Decision of final test mode

According pre-test, the worst test modes were reported as below:

Test software: FrequencyTool_v0.2.8

The test software was used to control EUT work in Continuous Tx mode, and select test channel, wireless mode as below table.

The pathloss of external cable: 0.5 dB (According to the manufacturer's claims)

Tested mode, channel, information			
Mode	Setting Tx Power	Channel	Frequency (MHz)
GFSK hopping on Tx mode	-13	CH0 to CH78	2402 to 2480
$\pi/4$ -DQPSK hopping on Tx mode	-13	CH0 to CH78	2402 to 2480

8DPSK hopping on Tx mode	-13	CH0 to CH78	2402 to 2480
GFSK hopping off Tx mode	-13	CH0	2402
	-13	CH39	2441
	-13	CH78	2480
$\pi/4$ -DQPSK hopping off Tx mode	-13	CH0	2402
	-13	CH39	2441
	-13	CH78	2480
8DPSK hopping off Tx mode	-13	CH0	2402
	-13	CH39	2441
	-13	CH78	2480
Worst-case data rates were: GFSK mode: DH5, $\pi/4$ -DQPSK mode: 2DH5, 8DPSK mode: 3DH5			

2.5. Deviations of test standard

No deviation.

2.6. Test environment conditions

During the measurement the environmental conditions were within the listed ranges:

Temperature range:	+15°C to +35 °C
Humidity range:	20% to 75%
Pressure range:	86 kPa to 106 kPa

Note: The specific temperature and humidity information of each test item refers to the temperature and humidity record in the corresponding test data.

2.7. Test laboratory

Guangdong Dongdian Testing Service Co., Ltd.

Add.: Unit 2, Building 1, No. 17, Zongbu 2nd Road, Songshan Lake Park, Dongguan, Guangdong, China, 523808.

Tel.: +86-0769-38826678, <http://www.dgddt.com>, Email: ddt@dgddt.com.

CNAS Accreditation No. L6451; A2LA Accreditation Number: 3870.01

FCC Designation Number: CN1182, Test Firm Registration Number: 540522

Innovation, Science and Economic Development Canada Site Registration Number: 10288A

Conformity Assessment Body identifier: CN0048

VCCI facility registration number: C-20087, T-20088, R-20123, R-20155, G-20118

2.8. Measurement uncertainty

Test Item	Uncertainty
Bandwidth	1.1%
Peak Output Power (Conducted) (Spectrum analyzer)	0.86 dB (10 MHz ≤ f < 3.6 GHz);
	1.38 dB (3.6 GHz ≤ f < 8 GHz)
Peak Output Power (Conducted) (Power Sensor)	0.74 dB
Power Spectral Density	0.74 dB (10 MHz ≤ f < 3.6 GHz);
	1.38 dB (3.6 GHz ≤ f < 8 GHz)
Frequencies Stability	6.7 x 10 ⁻⁸ (Antenna couple method)
	5.5 x 10 ⁻⁸ (Conducted method)
Conducted spurious emissions	0.86 dB (10 MHz ≤ f < 3.6 GHz);
	1.40 dB (3.6 GHz ≤ f < 8 GHz)
	1.66 dB (8 GHz ≤ f < 26.5 GHz)
Uncertainty for radio frequency (RBW < 20 kHz)	3x10 ⁻⁸
Temperature	0.4 °C
Humidity	2 %
Uncertainty for Radiation Emission test (9 kHz – 30 MHz)	3.44 dB
Uncertainty for Radiation Emission test (30 MHz - 1 GHz)	4.70 dB (Antenna Polarize: V)
	4.84 dB (Antenna Polarize: H)
Uncertainty for Radiation Emission test (1 GHz - 40 GHz)	4.10 dB (1 - 6 GHz)
	4.40 dB (6 GHz - 18 GHz)
	3.54 dB (18 GHz - 26 GHz)
	4.30 dB (26 GHz - 40 GHz)
Uncertainty for Power line conduction emission test	3.34dB (150KHz-30MHz)
	3.72dB (9KHz-150KHz)

Note: This uncertainty represents an expanded uncertainty expressed at approximately the 95% confidence level using a coverage factor of k=2.

3. Equipment Used During Conductive Test

Equipment	Manufacturer	Model No.	Serial Number	Due Date
☑RF Connected Test (RF Measurement System 4#)				
Signal &Spectrum Analyzer	R&S	FSV3044	101173	2025/03/31
Wideband Radio Communication Tester	R&S	CMW500	168801	2025/03/31
MXG Vector Signal Generator	Agilent	N5182A	MY48180737	2025/03/31
PSG Vector Signal Generator	Agilent	E8267D	US49060192	2024/09/05
RF Control Unit	Tonsend	JS0806-2	2118060485	2025/03/31
TEMP&HUMI Programmable Chamber	ZHIXIANG	ZXGDJS-150L	ZX170110-A	2025/04/22
Test Software	Tonscend	JS1120-3	Ver.3.2.22	N/A

4. 20 dB Bandwidth

4.1. Block diagram of test setup

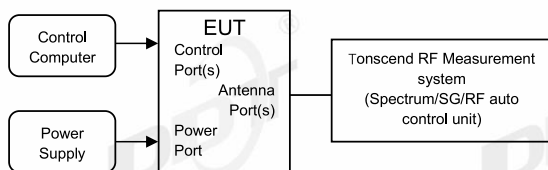

4.2. Limits

Intentional radiators operating under the alternative provisions to the general emission limits, as contained in § 15.217 through 15.257 and in Subpart E of this part, must be designed to ensure that the 20 dB bandwidth of the emission, or whatever bandwidth may otherwise be specified in the specific rule section under which the equipment operates, is contained within the frequency band designated in the rule section under which the equipment is operated.

4.3. Test procedure

- (1) The test according to ANSI C63.10-2013 clause 6.9.2.
- (2) Connect EUT's antenna output to spectrum analyzer by RF cable, the path loss was compensated to the results
- (3) Set the EUT as maximum power setting and enable the EUT transmit continuously
- (4) Use the following spectrum analyzer settings for the 20 dB bandwidth measurement:

RBW:	1% to 5% of the OBW
VBW:	approximately three times RBW
Span:	between 2 times and 5 times the OBW
Detector Mode:	Peak
Sweep time:	Auto
Trace mode:	Max hold

- (5) Measure and record the results in the report.

4.4. Test result

Test Engineer:	Zoe	Test Site:	RF Measurement System 4#
Ambient Condition:	23.6°C,47.8%RH	Test Date:	2024.07.19
Test Power Supply:	AC100-240V	Sample Number:	S24031501-004

Test Mode	Antenna	Frequency [MHz]	20dB EBW[MHz]
DH5	Ant1	2402	1.05
		2441	1.03
		2480	1.06
2DH5	Ant1	2402	1.32
		2441	1.30
		2480	1.32
3DH5	Ant1	2402	1.32
		2441	1.31
		2480	1.30

4.5. Test graphs

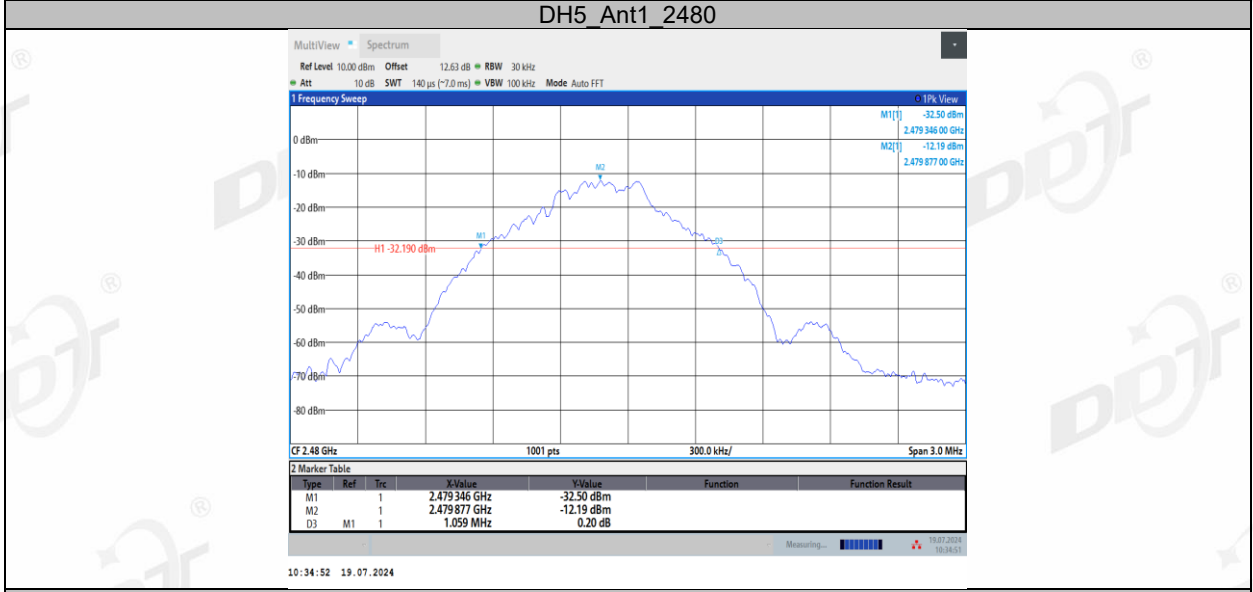
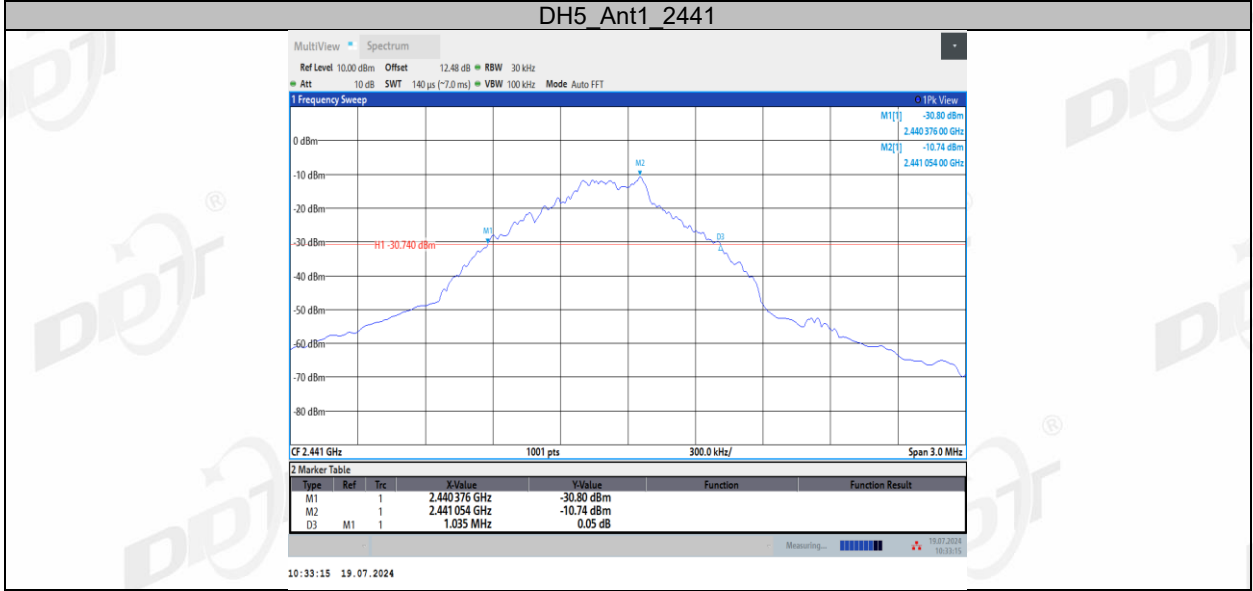
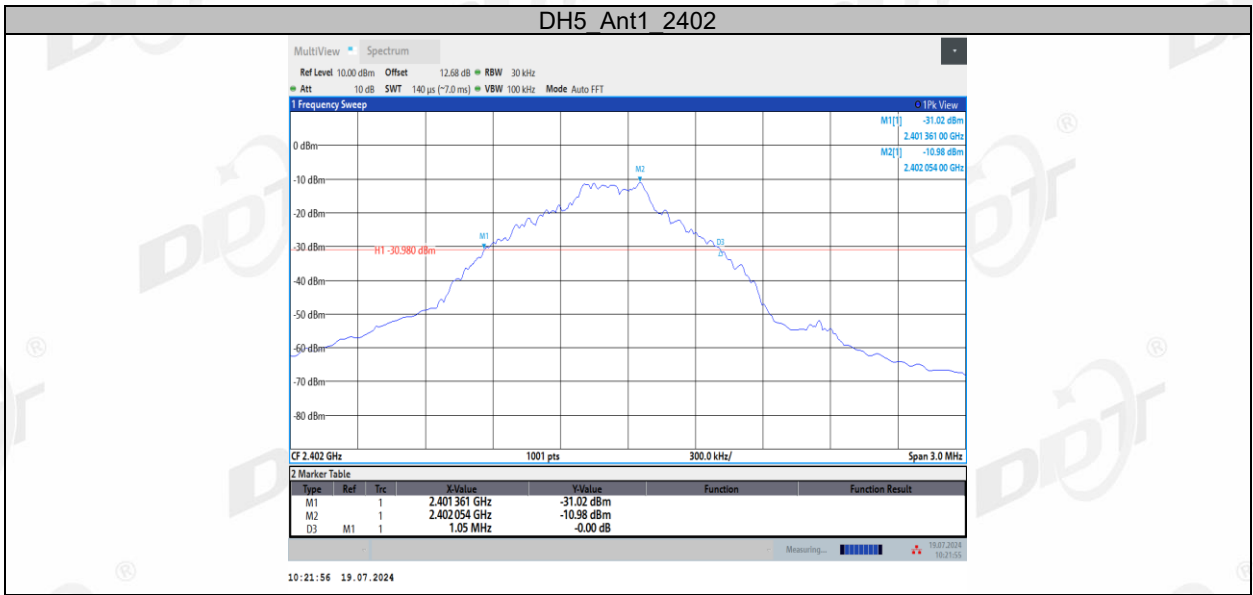

2DH5_Ant1_2402

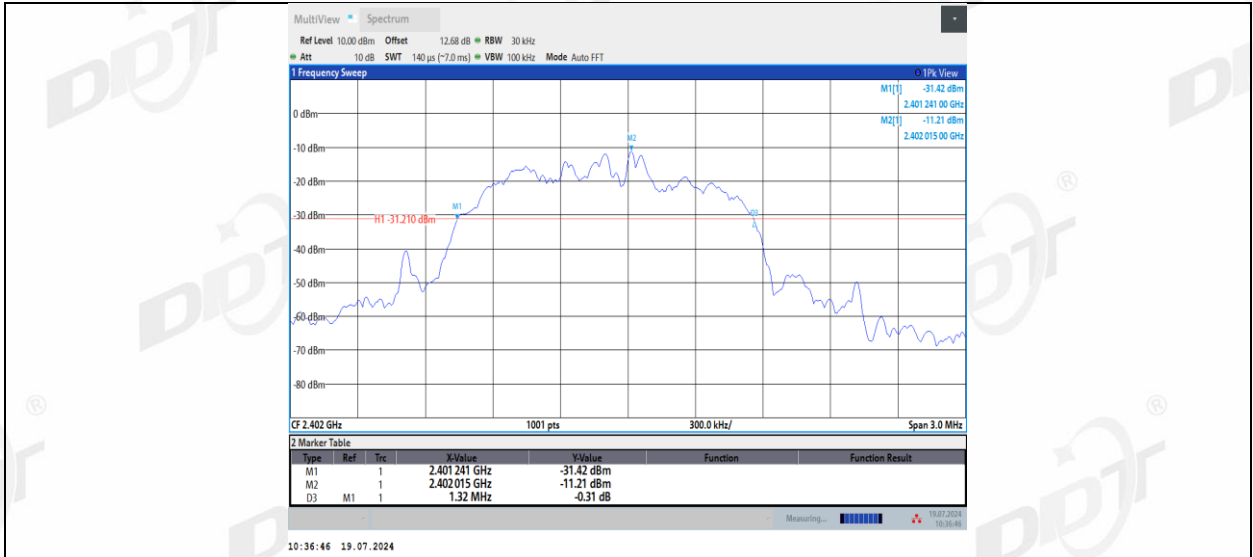

2DH5_Ant1_2441



2DH5_Ant1_2480

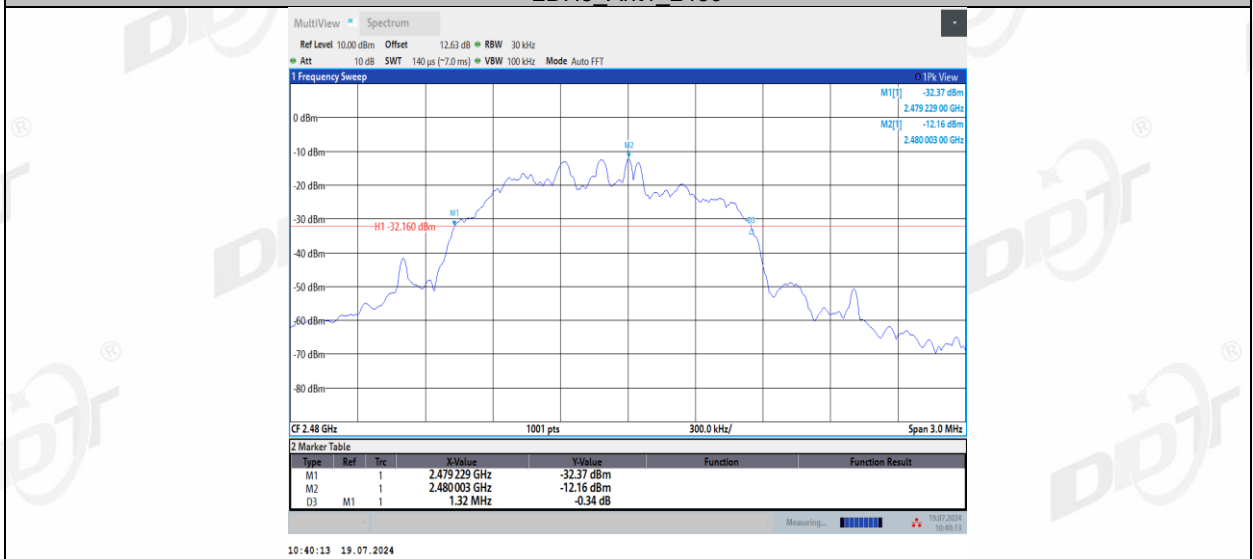

3DH5_Ant1_2402

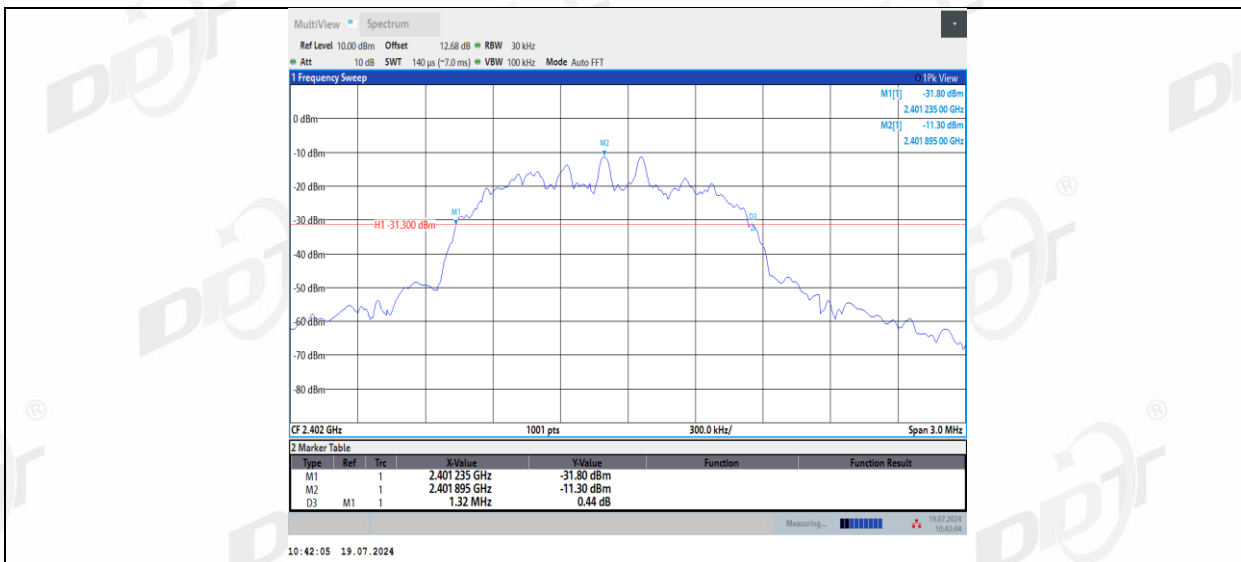

3DH5_Ant1_2441

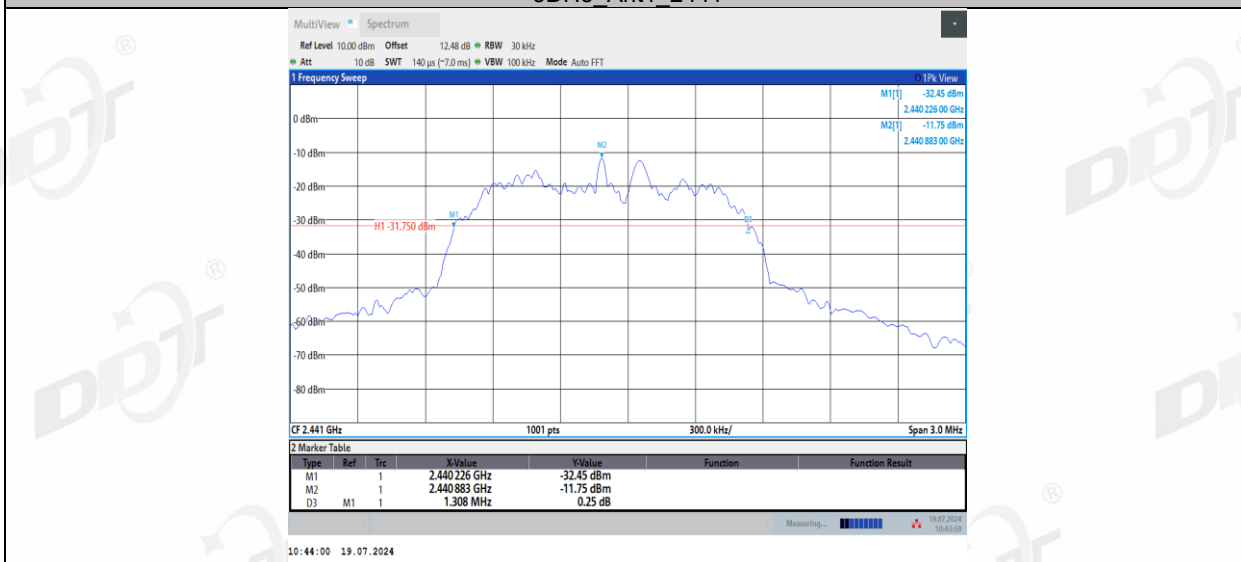

3DH5_Ant1_2480

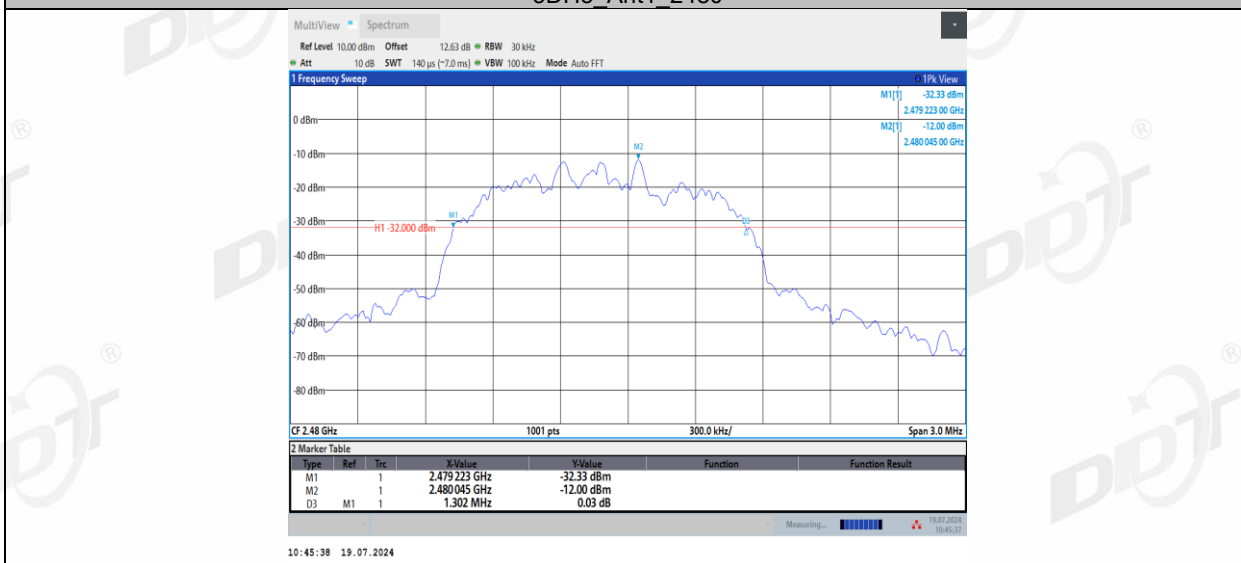

5. 99% Bandwidth

5.1. Block diagram of test setup

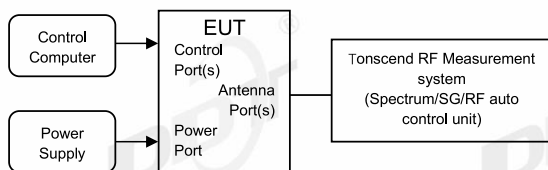

5.2. Limits

Just for Report.

5.3. Test procedure

- (1) The test according to ANSI C63.10-2013 clause 6.9.3.
- (2) Connect EUT's antenna output to spectrum analyzer by RF cable, the path loss was compensated to the results
- (3) Set the EUT as maximum power setting and enable the EUT transmit continuously
- (4) Use the following spectrum analyzer settings for the 99% bandwidth measurement:

RBW:	1% to 5% of the OBW
VBW:	approximately three times RBW
Span:	between 1.5 times and 5.0 times the OBW
Detector Mode:	Peak
Sweep time:	Auto
Trace mode:	Max hold
- (5) Measure and record the results in the report.

5.4. Test result

Test Engineer:	Zoe	Test Site:	RF Measurement System 4#
Ambient Condition:	23.6°C,47.8%RH	Test Date:	2024.07.19
Test Power Supply:	AC100-240V	Sample Number:	S24031501-004

Test Mode	Antenna	Frequency [MHz]	OCB [MHz]	FL[MHz]	FH[MHz]
DH5	Ant1	2402	0.917	2401.4294	2402.3465
		2441	0.902	2440.4296	2441.3319
		2480	0.928	2479.4104	2480.3384
2DH5	Ant1	2402	1.195	2401.3036	2402.4984
		2441	1.202	2440.2987	2441.5012
		2480	1.197	2479.2911	2480.4885
3DH5	Ant1	2402	1.214	2401.2932	2402.5067
		2441	1.202	2440.2937	2441.4954
		2480	1.194	2479.2898	2480.4842

5.5. Test graphs

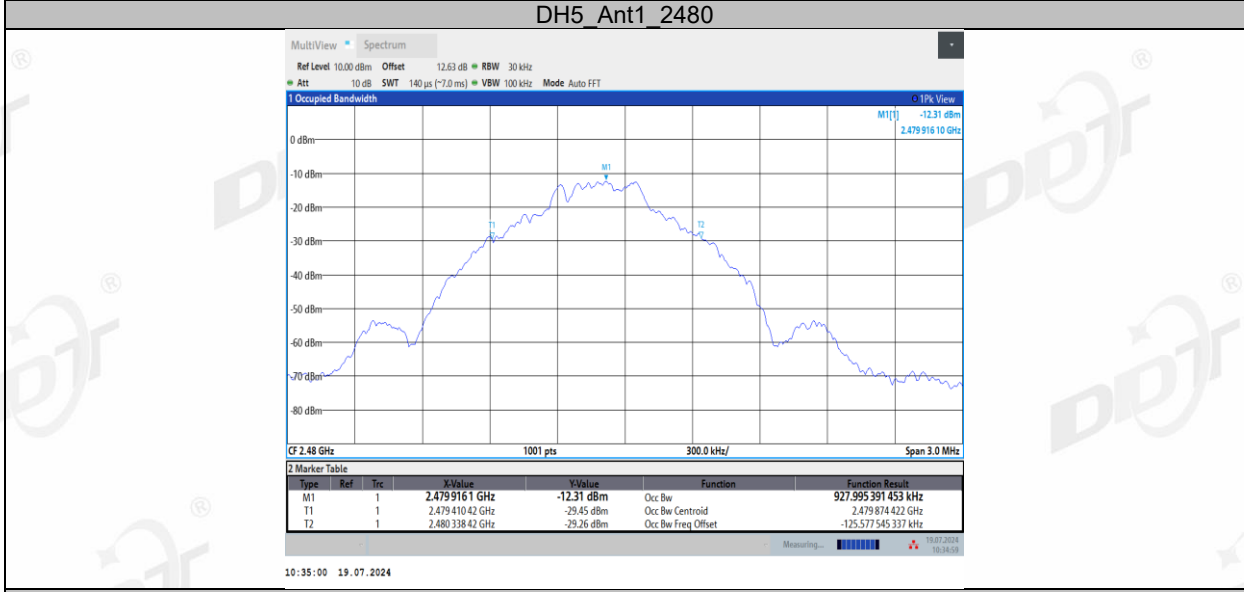
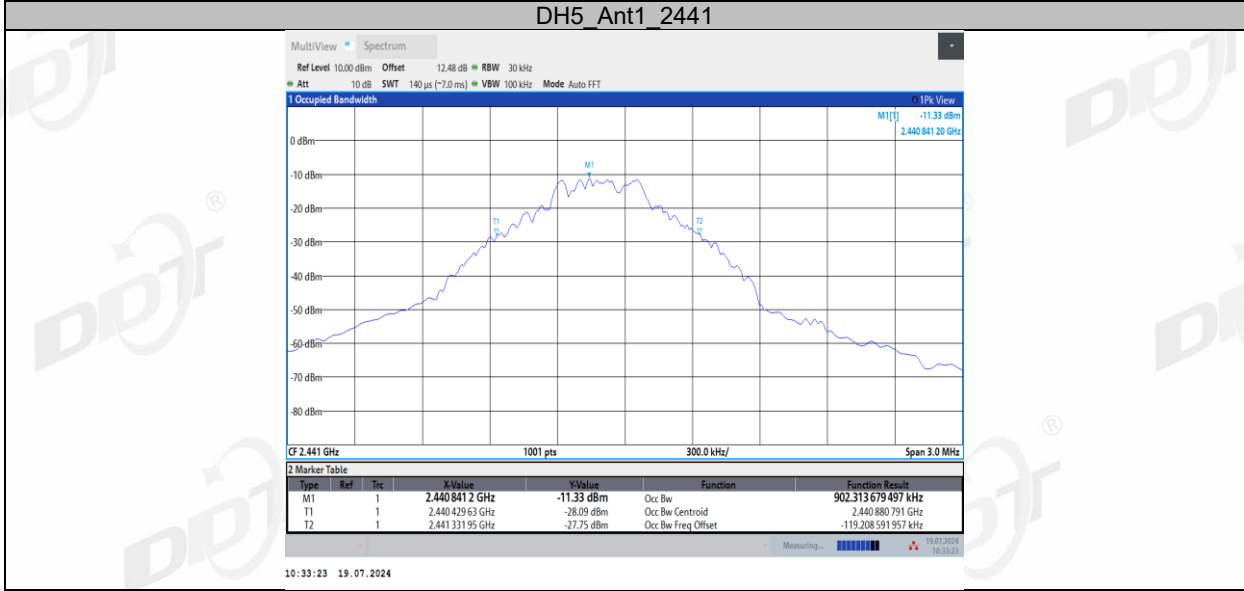
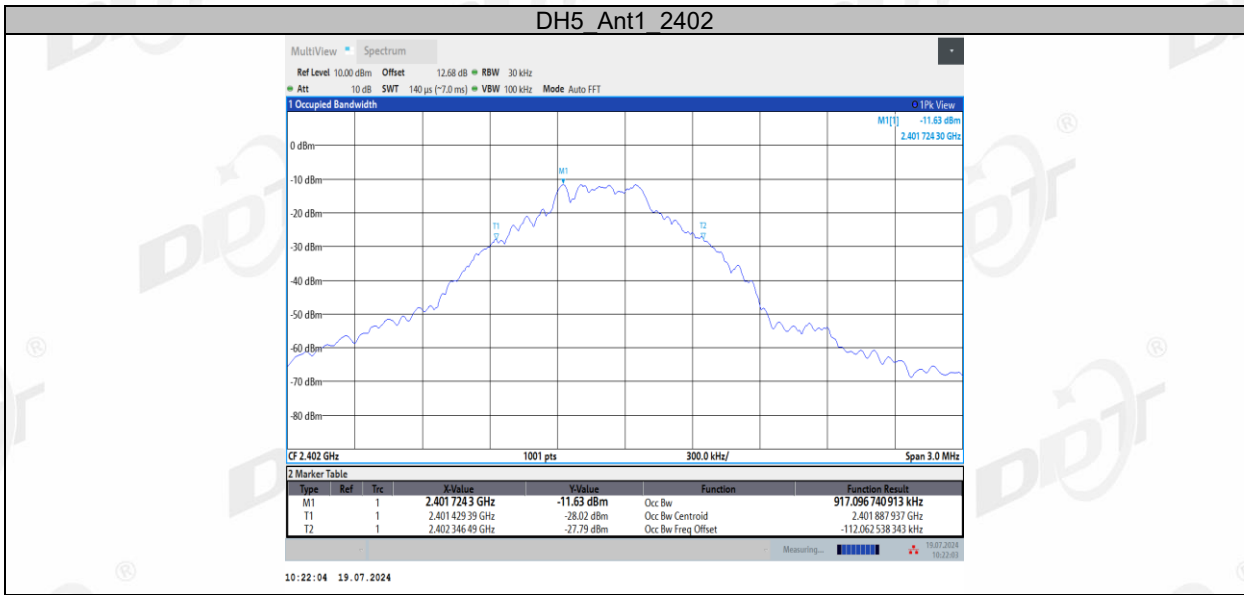

2DH5_Ant1_2402

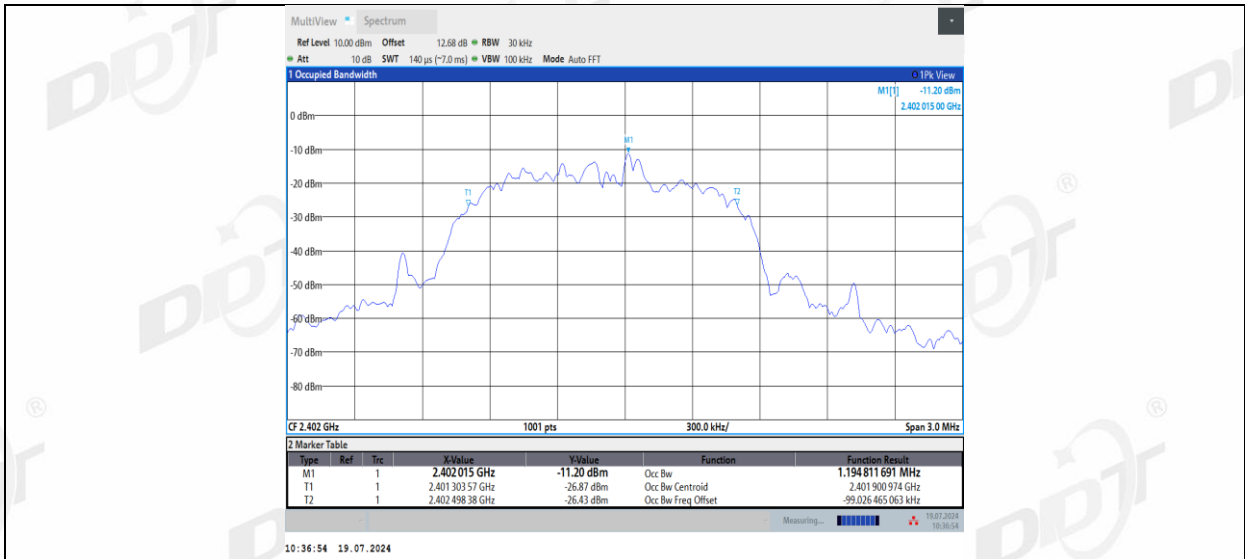

2DH5_Ant1_2441

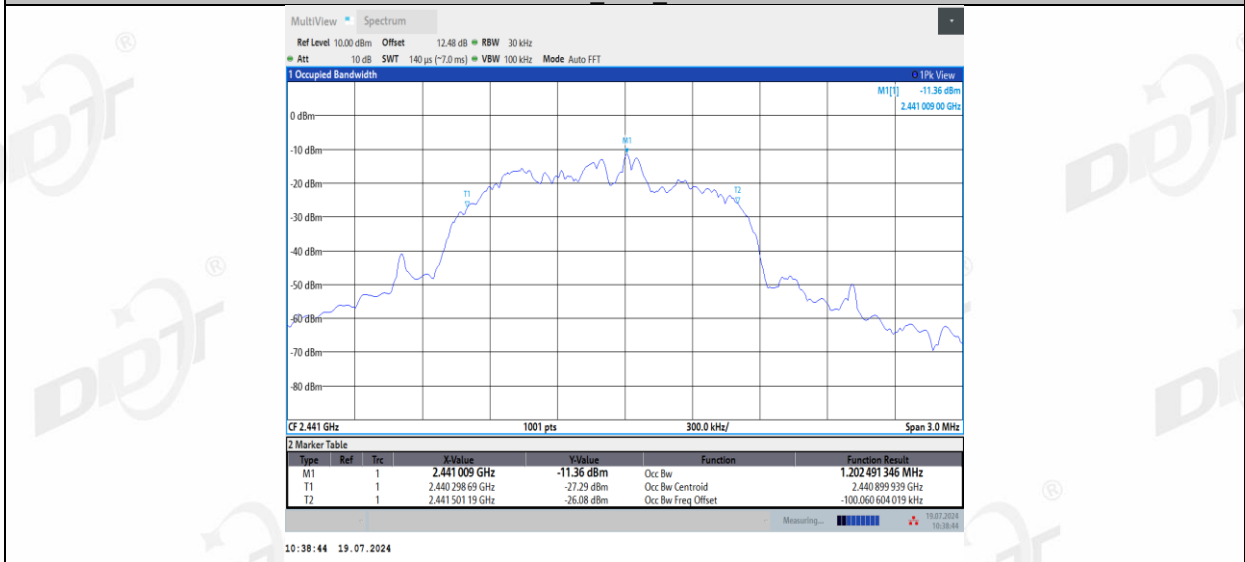

2DH5_Ant1_2480

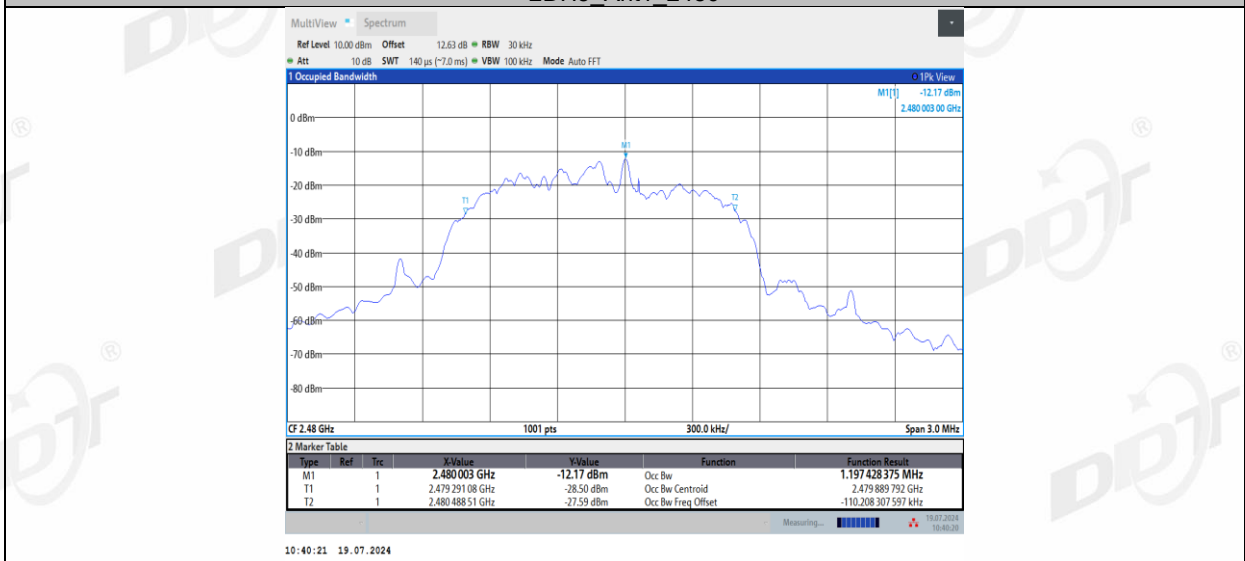

3DH5_Ant1_2402

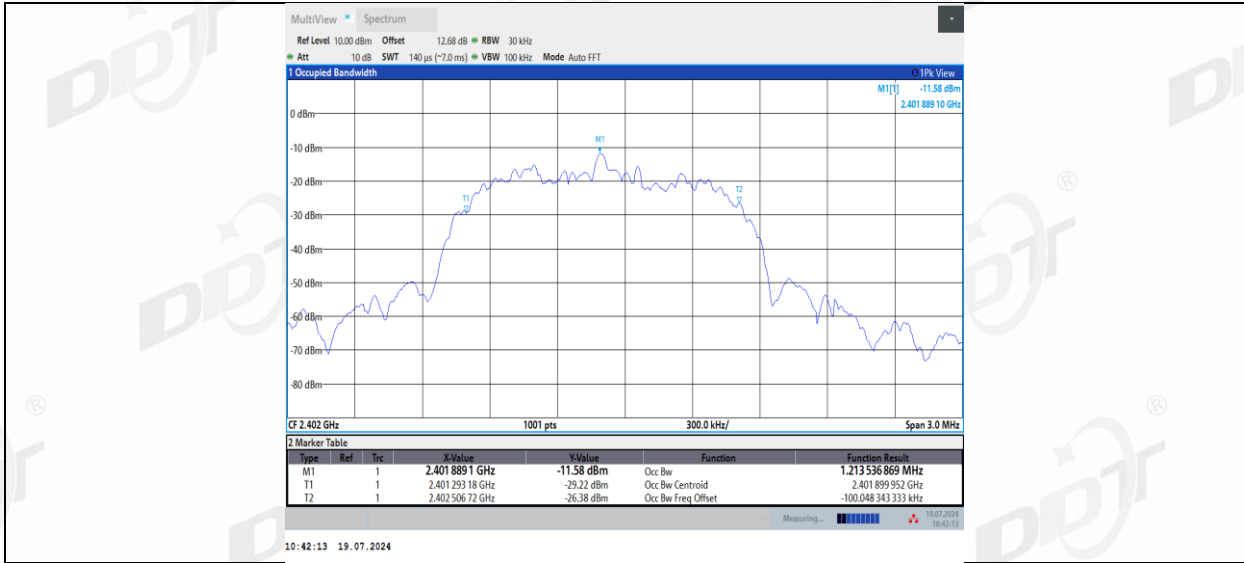

3DH5_Ant1_2441



3DH5_Ant1_2480

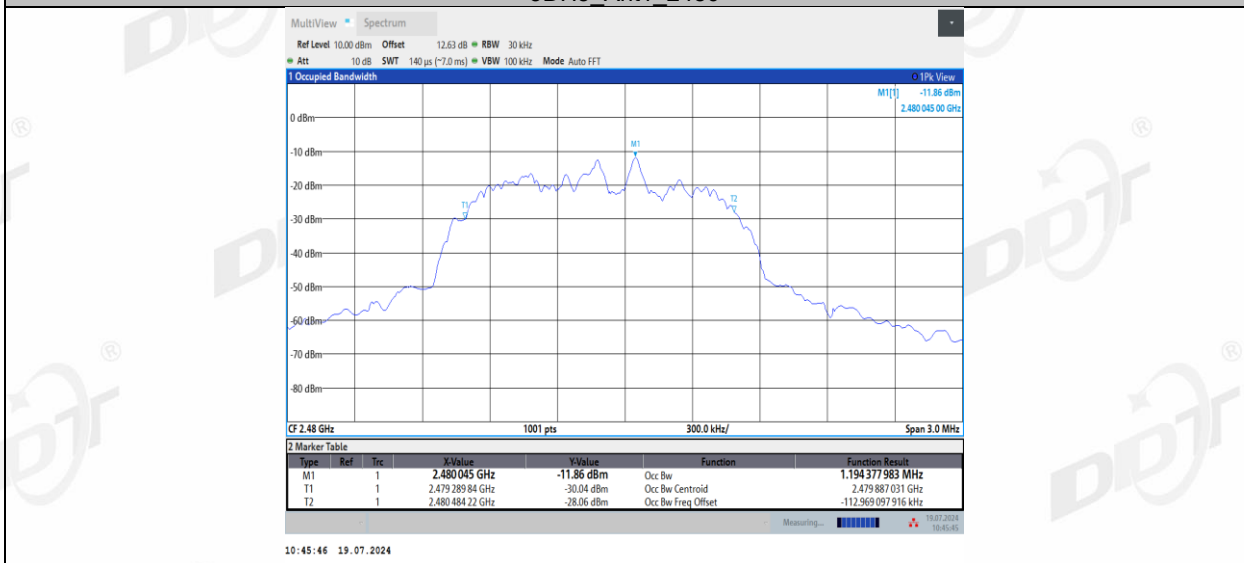

6. Maximum Peak Output Power

6.1. Block diagram of test setup

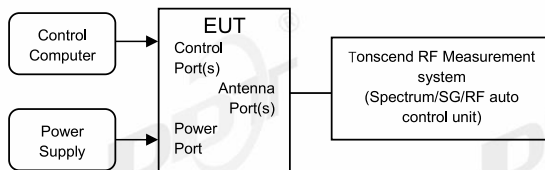

6.2. Limits

For frequency hopping systems operating in the 2400-2483.5 MHz band employing at least 75 non-overlapping hopping channels, and all frequency hopping systems in the 5725-5850 MHz band: 1 watt. For all other frequency hopping systems in the 2400-2483.5 MHz band: 0.125 watts, the e.i.r.p shall not exceed 4W.

6.3. Test procedure

- (1) The test according to ANSI C63.10-2013 clause 7.8.5.
- (2) Connect EUT's antenna output to spectrum analyzer by RF cable, the path loss was compensated to the results.
- (3) Set the EUT as maximum power setting and enable the EUT transmit continuously.
- (4) Use the following spectrum analyzer settings for the maximum peak output power measurement:

RBW:	> 20 dB bandwidth of the emission being measured.
VBW:	VBW \geq RBW.
Span:	Approximately five times the 20 dB bandwidth, centered on a hopping channel.
Detector Mode:	Peak
Sweep time:	Auto
Trace mode:	Max hold
- (5) Use the marker-to-peak function to set the marker to the peak of the emission and record the results in the report.

6.4. Test result

Test Engineer:	Zoe	Test Site:	RF Measurement System 4#
Ambient Condition:	23.6°C,47.8%RH	Test Date:	2024.07.19
Test Power Supply:	AC100-240V	Sample Number:	S24031501-004

Test Mode	Antenna	Frequency [MHz]	Conducted Peak Power[dBm]	Conducted Limit[dBm]	EIRP[dBm]	EIRP Limit[dBm]	Verdict
DH5	Ant1	2402	-7.28	≤20.97	-4.08	≤30	PASS
		2441	-7.42	≤20.97	-4.22	≤30	PASS
		2480	-8.20	≤20.97	-5.00	≤30	PASS
2DH5	Ant1	2402	-7.35	≤20.97	-4.15	≤30	PASS
		2441	-7.53	≤20.97	-4.33	≤30	PASS
		2480	-8.29	≤20.97	-5.09	≤30	PASS
3DH5	Ant1	2402	-7.39	≤20.97	-4.19	≤30	PASS
		2441	-7.51	≤20.97	-4.31	≤30	PASS
		2480	-8.24	≤20.97	-5.04	≤30	PASS

6.5. Test graphs

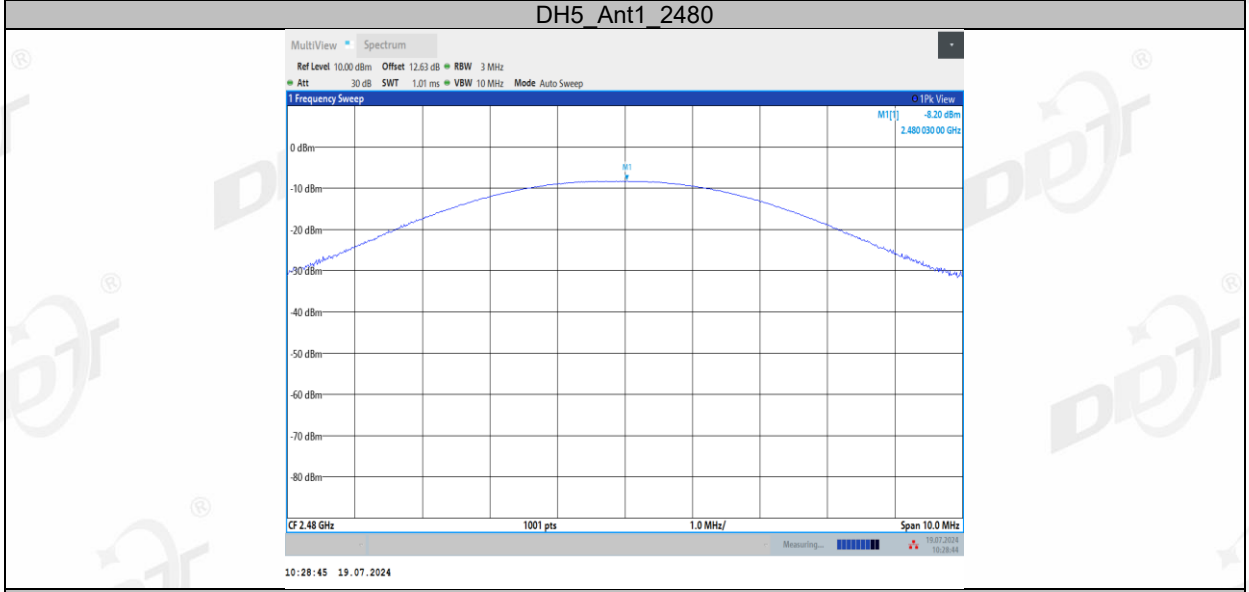
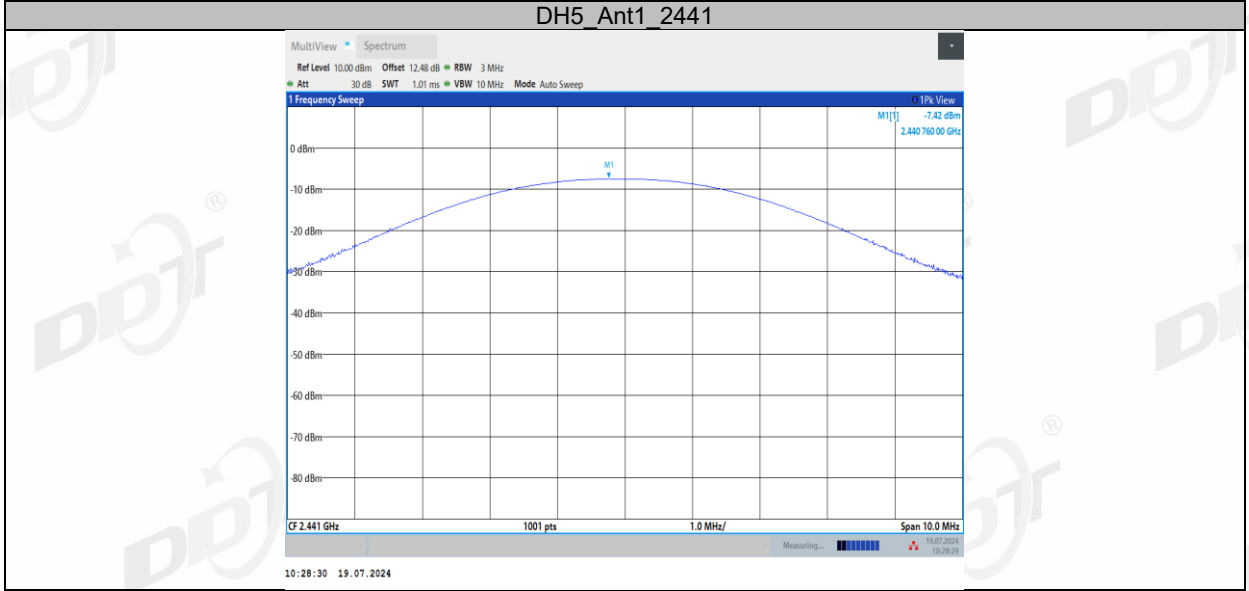
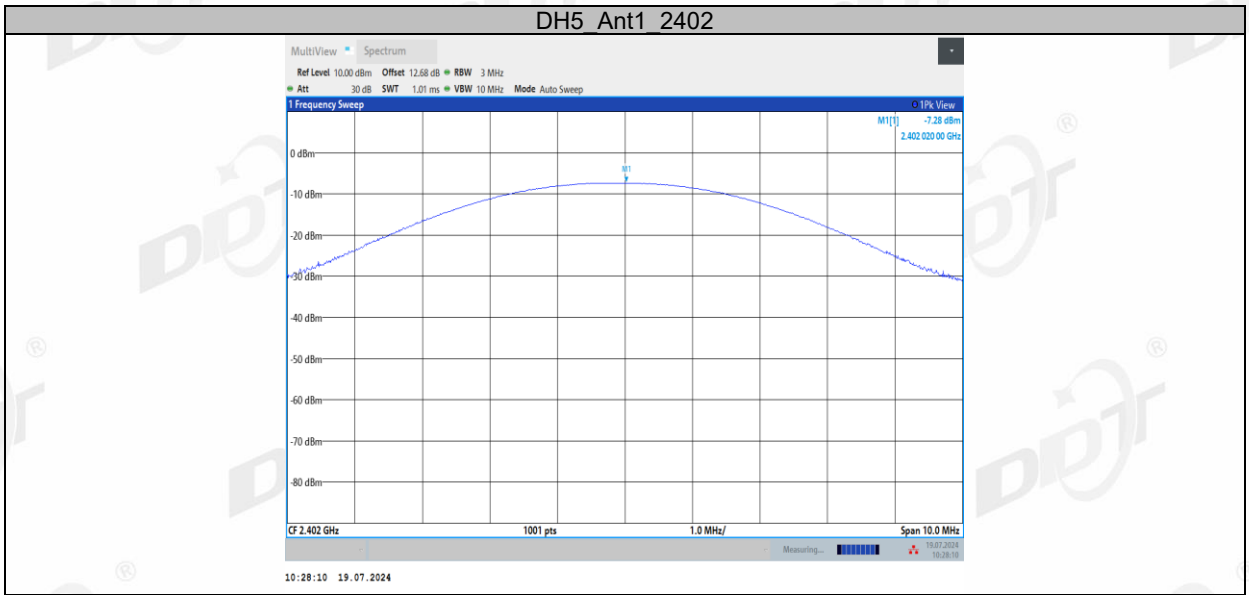

2DH5_Ant1_2402

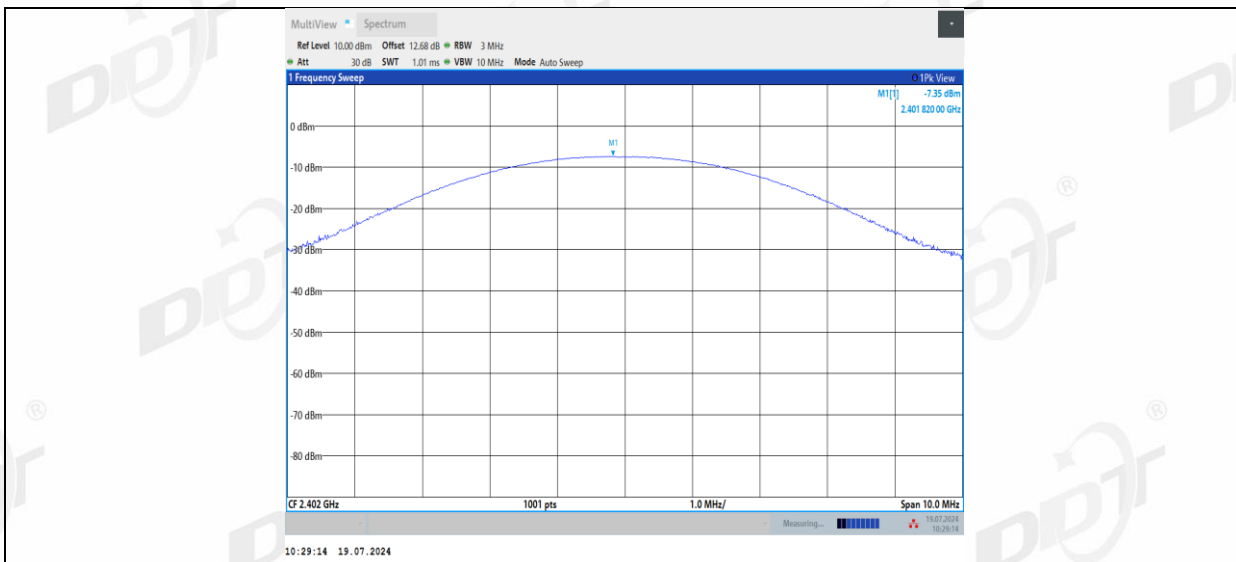

2DH5_Ant1_2441

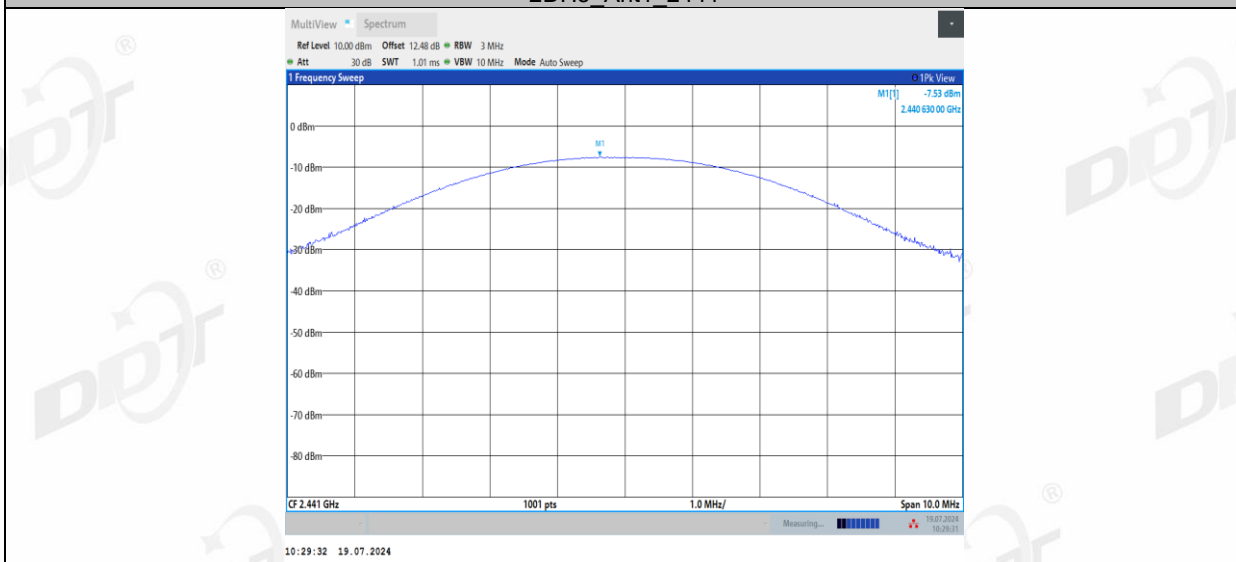

2DH5_Ant1_2480

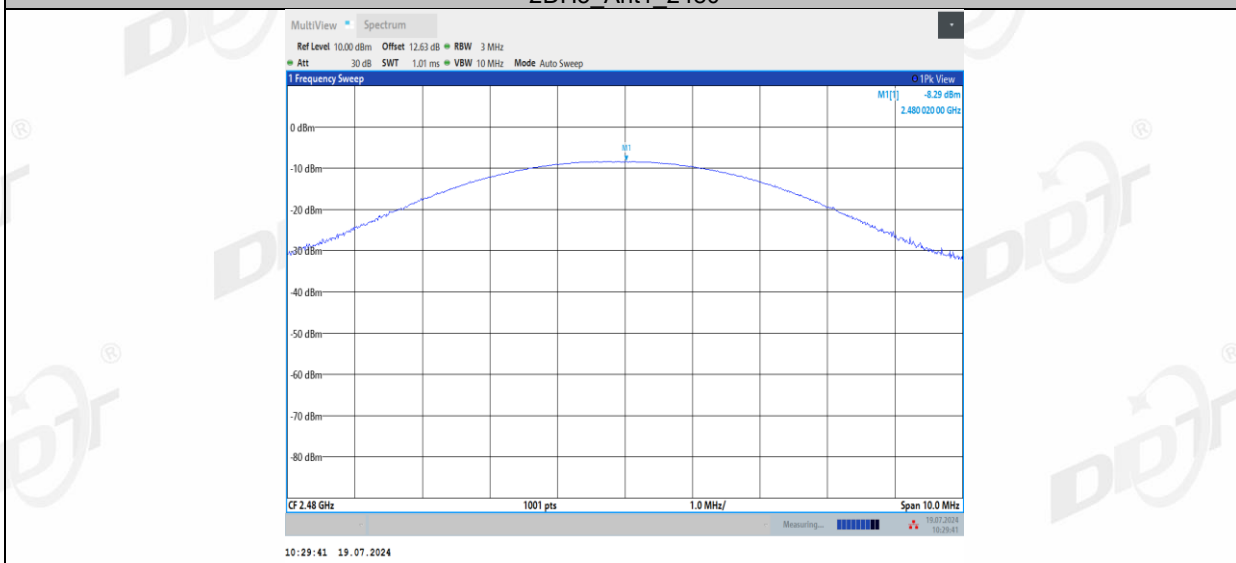

3DH5_Ant1_2402

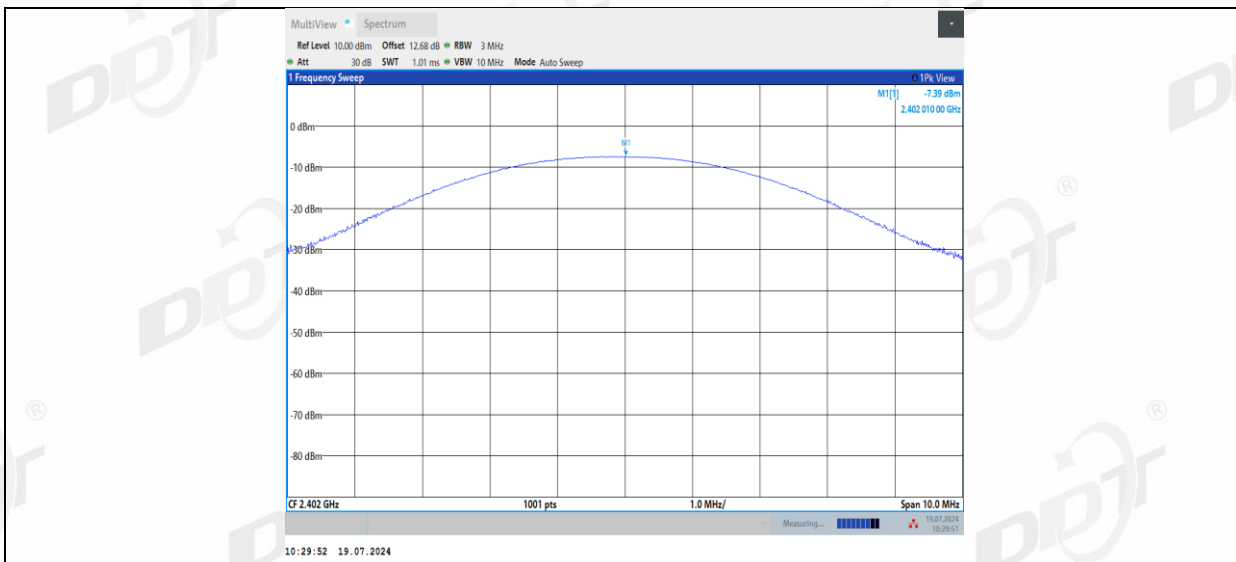

3DH5_Ant1_2441

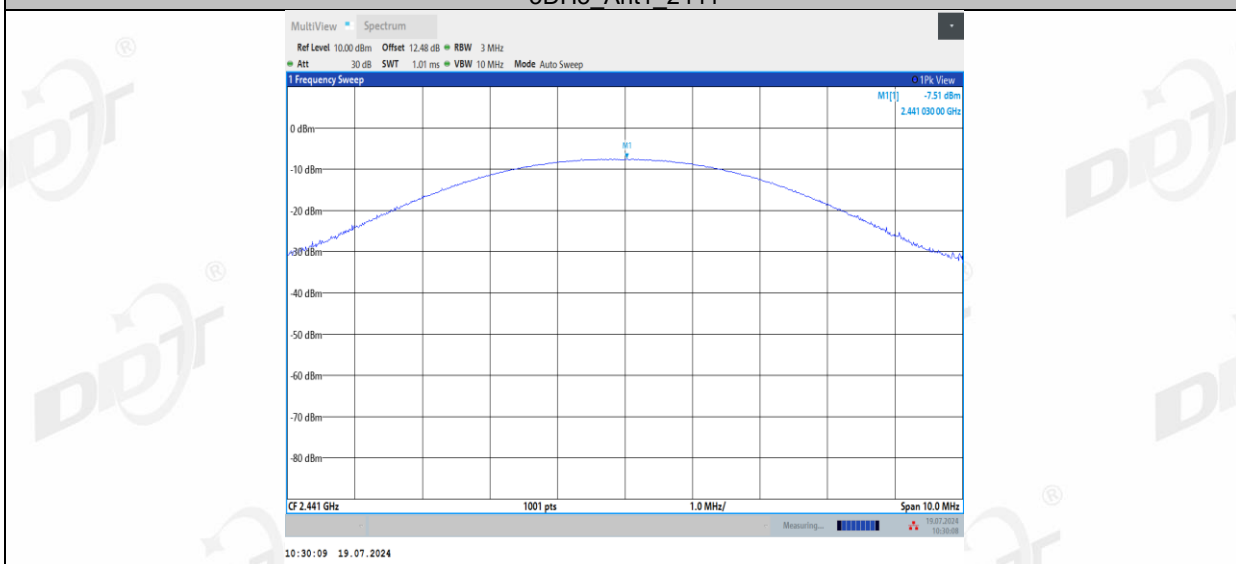

3DH5_Ant1_2480

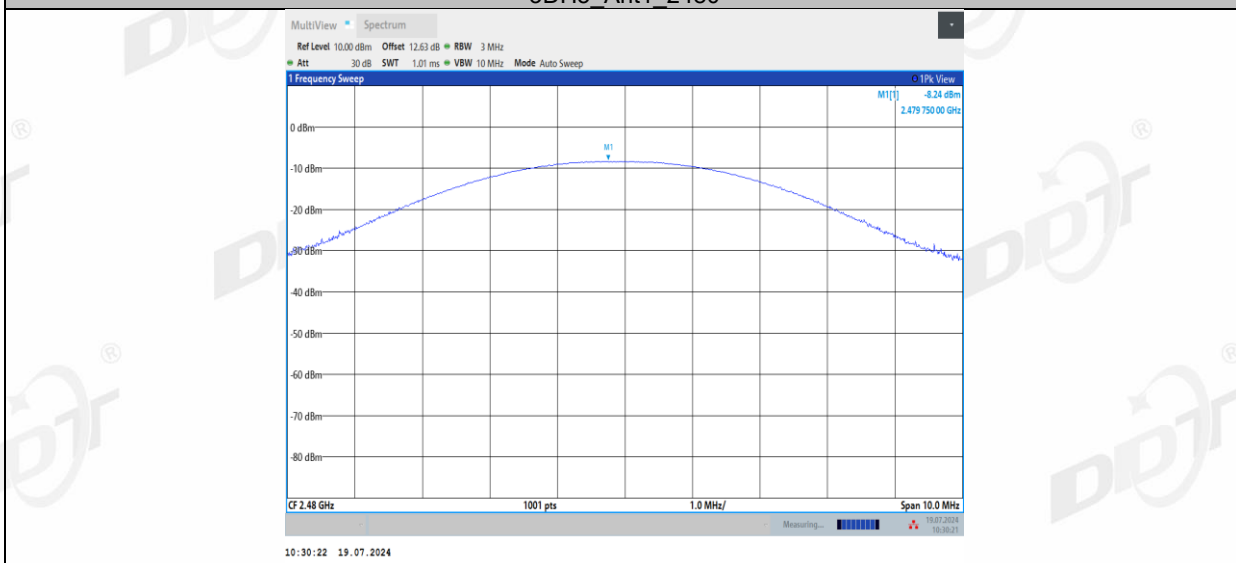

7. Carrier Frequency Separation

7.1. Block diagram of test setup

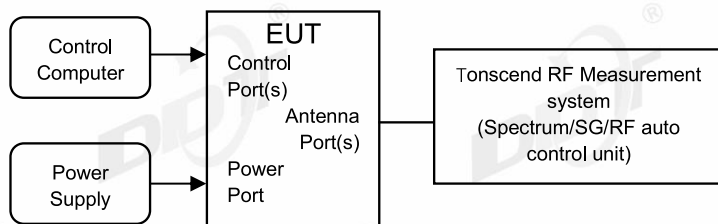

7.2. Limits

Frequency hopping systems shall have hopping channel carrier frequencies separated by a minimum of 25 kHz or the 20 dB bandwidth of the hopping channel, whichever is greater. Alternatively, frequency hopping systems operating in the 2400-2483.5 MHz band may have hopping channel carrier frequencies that are separated by 25 kHz or two-thirds of the 20 dB bandwidth of the hopping channel, whichever is greater, provided the systems operate with an output power no greater than 125 mW.

7.3. Test procedure

- (1) The test according to ANSI C63.10-2013 clause 7.8.2.
- (2) Connect EUT's antenna output to spectrum analyzer by RF cable, the path loss was compensated to the results.
- (3) Set the EUT as maximum power setting and enable the EUT transmit continuously.
- (4) Use the following spectrum analyzer settings for the maximum peak output power measurement:

RBW:	approximately 30% of the channel spacing
VBW:	VBW \geq RBW.
Span:	Wide enough to capture the peaks of two adjacent channels.
Detector Mode:	Peak
Sweep time:	Auto
Trace mode:	Max hold
- (5) Use the marker-delta function to determine the separation between the peaks of the adjacent channels and record the results in the report.

7.4. Test result

Test Engineer:	Zoe	Test Site:	RF Measurement System 4#
Ambient Condition:	23.6°C,47.8%RH	Test Date:	2024.07.19
Test Power Supply:	AC100-240V	Sample Number:	S24031501-004

Test Mode	Antenna	Frequency [MHz]	Result [MHz]	Limit [MHz]	Verdict
DH5	Ant1	Hop	1.006	≥0.707	PASS
2DH5	Ant1	Hop	1.006	≥0.880	PASS
3DH5	Ant1	Hop	0.992	≥0.880	PASS

7.5. Test graphs

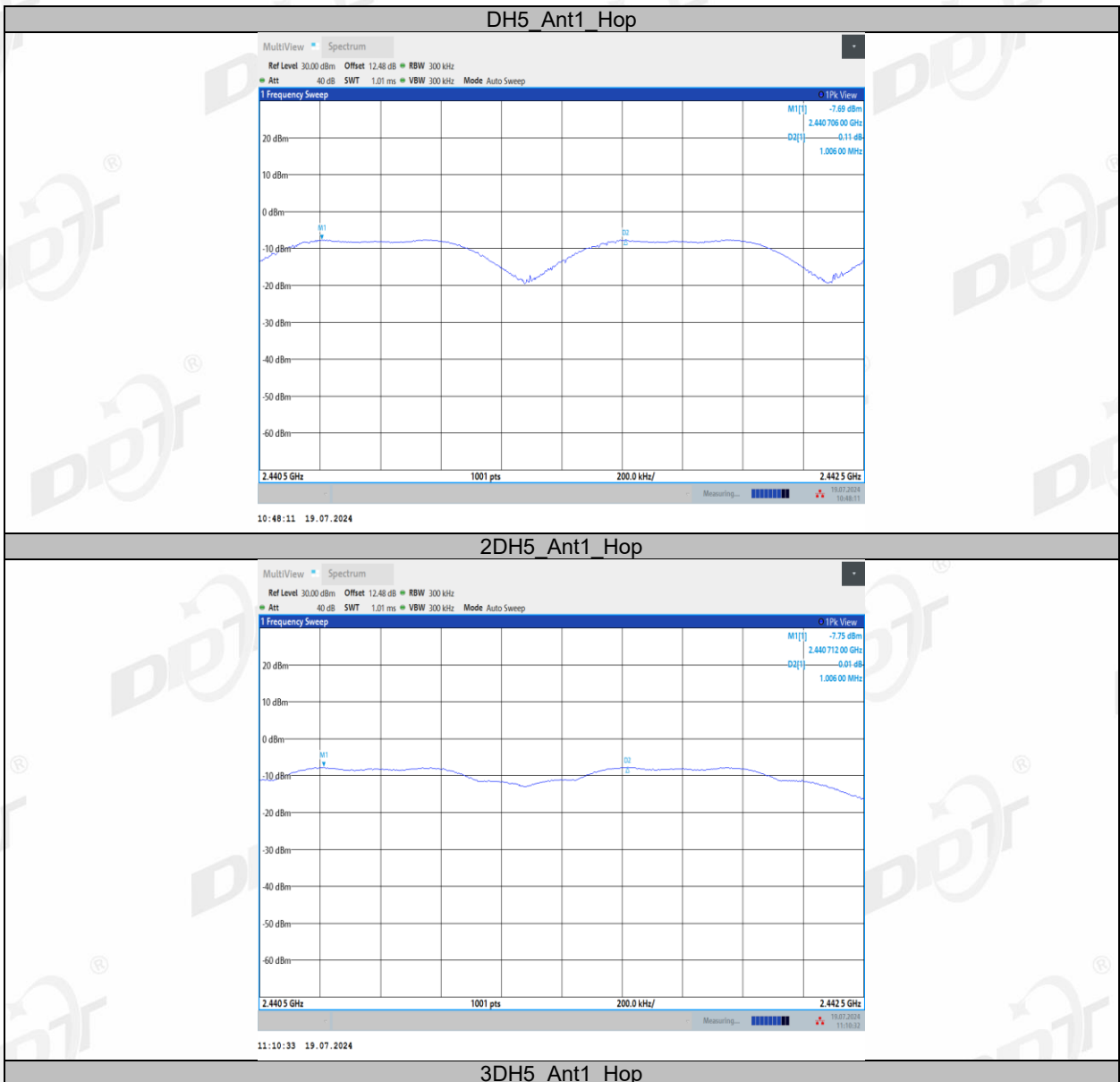

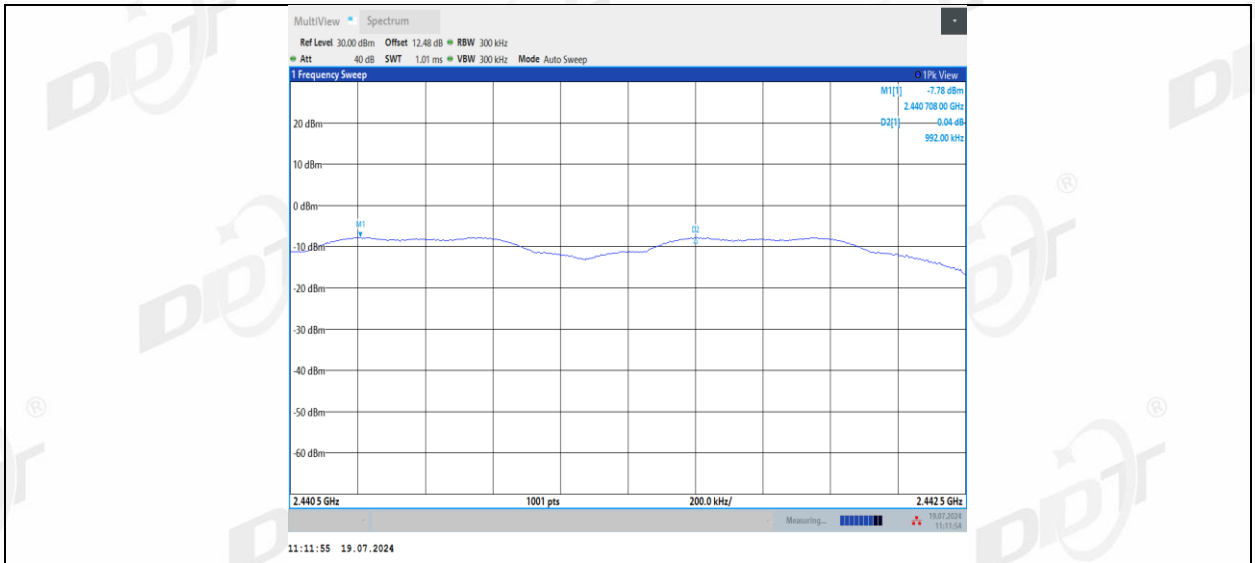

8. Dwell Time

8.1. Block diagram of test setup

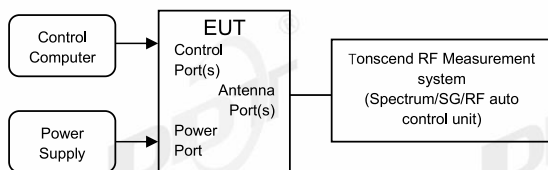

8.2. Limits

The average time of occupancy on any channel shall not be greater than 0.4 seconds within a period of 0.4 seconds multiplied by the number of hopping channels employed.

8.3. Test procedure

- (1) The test according to ANSI C63.10-2013 clause 7.8.4.
- (2) Connect EUT's antenna output to spectrum analyzer by RF cable, the path loss was compensated to the results.
- (3) Set the EUT as maximum power setting and enable the EUT transmit continuously.
- (4) Use the following spectrum analyzer settings for the maximum peak output power measurement:

RBW:	≤ channel spacing and where possible RBW should be set >>1 / T
VBW:	VBW ≥ RBW.
Span:	Zero span, centered on a hopping channel.
Detector Mode:	Peak
Sweep time:	Auto
Trace mode:	Clear Write.
- (5) The test period: $T = 0.4 \text{ Second/Channel} \times 79 \text{ Channel} = 31.6 \text{ s}$
- (6) Measure the hopping number and on time of each pulse with spectrum analyzer in zero span set, and calculate dwell time with formula Dwell time = total hops * pulse's on time.
- (7) Measure and record the results in the report.

8.4. Test result

Test Engineer:	Zoe	Test Site:	RF Measurement System 4#
Ambient Condition:	23.6°C,47.8%RH	Test Date:	2024.07.19
Test Power Supply:	AC100-240V	Sample Number:	S24031501-004

Test Mode	Antenna	Frequency [MHz]	BurstWidth [ms]	TotalHops [Num]	Result[s]	Limit[s]	Verdict
DH1	Ant1	Hop	0.360	311	0.112	≤0.4	PASS
DH3	Ant1	Hop	1.620	177	0.287	≤0.4	PASS
DH5	Ant1	Hop	2.880	107	0.308	≤0.4	PASS
2DH1	Ant1	Hop	0.370	312	0.115	≤0.4	PASS
2DH3	Ant1	Hop	1.620	177	0.287	≤0.4	PASS
2DH5	Ant1	Hop	2.870	107	0.307	≤0.4	PASS
3DH1	Ant1	Hop	0.370	311	0.115	≤0.4	PASS
3DH3	Ant1	Hop	1.620	177	0.287	≤0.4	PASS
3DH5	Ant1	Hop	2.880	107	0.308	≤0.4	PASS