

FCC AND IC CERTIFICATION TEST REPORT

FOR

Applicant	:	ION Audio, LLC.
Address	:	200 Scenic View Drive, Cumberland, RI 02864 U.S.A.
Equipment under Test	:	Portable CD Player with Bluetooth
Model No.	:	AIR CD
Project Code	:	iCD06
Trade Mark	:	ION
FCC ID	:	2AB3E- ICD06
IC	:	10541A- ICD06
Manufacturer	:	ION Audio, LLC.
Address	:	200 Scenic View Drive, Cumberland, RI 02864 U.S.A.

Issued By: Dongguan Dongdian Testing Service Co., Ltd.

Add: No. 17, Zongbu Road 2, Songshan Lake Sci&Tech, Industry Park, Dongguan
City, Guangdong Province, China, 523808

Tel: +86-0769-89201699, **E-mail:** ddt@dgddt.com, <http://www.dgddt.com>

REPORT

TABLE OF CONTENTS

	Test report declares.....	4
1.	Summary of test results	6
2.	General test information	7
2.1.	Description of EUT.....	7
2.2.	Accessories of EUT	7
2.3.	Assistant equipment used for test.....	7
2.4.	Block diagram of EUT configuration for test	7
2.5.	Deviations of test standard	8
2.6.	Test environment conditions	8
2.7.	Test laboratory.....	8
2.8.	Measurement uncertainty	9
3.	Equipment used during test	10
4.	Maximum Peak Output Power	11
4.1.	Block diagram of test setup	11
4.2.	Limits	11
4.3.	Test Procedure	11
4.4.	Test Result	11
4.5.	Original test data.....	12
5.	20dB Bandwidth and 99% Bandwidth.....	15
5.1.	Block diagram of test setup	15
5.2.	Limits	15
5.3.	Test Procedure	15
5.4.	Test Result	15
5.5.	Original test data.....	16
6.	Carrier Frequency Separation.....	18
6.1.	Block diagram of test setup	18
6.2.	Limits	18
6.3.	Test Procedure	18
6.4.	Test Result	18
6.5.	Original test data.....	18
7.	Number Of Hopping Channel.....	19
7.1.	Block diagram of test setup	19
7.2.	Limits	19
7.3.	Test Procedure	19
7.4.	Test Result	19
7.5.	Original test data.....	20
8.	Dwell Time	21

8.1.	Block diagram of test setup	21
8.2.	Limits	21
8.3.	Test Procedure	21
8.4.	Test Result	21
8.5.	Original test data.....	22
9.	Band Edge Compliance (conducted method)	26
9.1.	Block diagram of test setup	26
9.2.	Limit	26
9.3.	Test result.....	26
9.4.	Original test data.....	26
10.	Radiated emission	30
10.1.	Block diagram of test setup	30
10.2.	Limit	31
10.3.	Test Procedure	32
10.4.	Test result.....	34
11.	RF Conducted Spurious Emissions	38
11.1.	Block diagram of test setup	38
11.2.	Limits	38
11.3.	Test Procedure	38
11.4.	Test Result	39
11.5.	Original test data.....	39
12.	Band Edge Compliance (radiated method).....	46
12.1.	Block diagram of test setup	46
12.2.	Limit	46
12.3.	Test Procedure	46
12.4.	Test result.....	46
13.	Power Line Conducted Emission	55
13.1.	Block diagram of test setup	55
13.2.	Power Line Conducted Emission Limits.....	55
13.3.	Test Procedure	55
13.4.	Test Result	56
14.	Antenna Requirements	59
14.1.	Limit	59
14.2.	Result	59

TEST REPORT DECLARE

Applicant	:	ION Audio, LLC.
Address	:	200 Scenic View Drive, Cumberland, RI 02864 U.S.A.
Equipment under Test	:	Portable CD Player with Bluetooth
Model No.	:	AIR CD
Trade mark	:	ION
Manufacturer	:	ION Audio, LLC.
Address	:	200 Scenic View Drive, Cumberland, RI 02864 U.S.A.

Test Standard Used:

FCC Rules and Regulations Part 15 Subpart C, RSS-247 Issue 2 February 2017.

Test procedure used:

ANSI C63.10:2013, RSS-Gen Issue 4, Nov. 2014.

We Declare:

The equipment described above is tested by Dongguan Dongdian Testing Service Co., Ltd. and in the configuration tested the equipment complied with the standards specified above. The test results are contained in this test report and Dongguan Dongdian Testing Service Co., Ltd. is assumed of full responsibility for the accuracy and completeness of these tests.

After test and evaluation, our opinion is that the equipment provided for test compliance with the requirement of the above FCC&IC standards.

Report No.:	DDT-R18030703-1E2		
Date of Receipt:	Mar. 20, 2018	Date of Test:	Mar. 20, 2018 ~ Mar. 30, 2018

Prepared By:

Sam Li
Sam Li/Engineer

Approved By

Kevin Feng/EMC Manager

Note: This report applies to above tested sample only. This report shall not be reproduced in parts without written approval of Dongguan Dongdian Testing Service Co., Ltd.

Revision history

Rev.	Revisions	Issue Date	Revised By
---	Initial issue	Apr. 04, 2018	

1. Summary of test results

Description of Test Item	Standard	Results
Maximum Peak Output Power	FCC Part 15: 15.247(b)(1) ANSI C63.10:2013 RSS-247 Issue 2	PASS
20dB Bandwidth and 99% Bandwidth	FCC Part 15: 15.215 ANSI C63.10:2013 RSS-247 Issue 2	PASS
Carrier Frequency Separation	FCC Part 15: 15.247(a)(1) ANSI C63.10:2013 RSS-247 Issue 2	PASS
Number Of Hopping Channel	FCC Part 15: 15.247(a)(1)(iii) ANSI C63.10:2013 RSS-247 Issue 2	PASS
Dwell Time	FCC Part 15: 15.247(a)(1)(iii) ANSI C63.10:2013 RSS-247 Issue 2	PASS
Radiated Emission	FCC Part 15: 15.209 FCC Part 15: 15.247(d) ANSI C63.10:2013 RSS-247 Issue 2 RSS-Gen Issue 4 clause 7.2.2 RSS-Gen Issue 4 clause 7.2.5	PASS
Band Edge Compliance	FCC Part 15: 15.247(d) ANSI C63.10:2013 RSS-247 Issue 2 RSS-Gen Issue 4 clause 7.2.2 RSS-Gen Issue 4 clause 7.2.5	PASS
Power Line Conducted Emissions	FCC Part 15: 15.207 ANSI C63.10:2013 RSS-Gen Issue 4 clause 7.2.4	PASS
Antenna requirement	FCC Part 15: 15.203 RSS-Gen Issue 4 clause 7.1.2	PASS

2. General test information

2.1. Description of EUT

EUT* Name	: Portable CD Player with Bluetooth
Model Number	: AIR CD
EUT function description	: Please reference user manual of this device
Power supply	: DC 4.5V from external AC/DC power adapter : DC 3V (2*1.5 "AA" batteries)
Radio Specification	: Bluetooth V2.1
Operation frequency	: 2402MHz -2480MHz
Modulation	: GFSK, $\pi/4$ -DQPSK, 8DPSK
Data rate	: 1Mbps, 2Mbps, 3Mbps
Antenna Type	: Integrated PCB antenna, maximum PK gain: 0dBi
Sample Type	: Series production

Note: EUT is the ab. of equipment under test.

2.2. Accessories of EUT

Description of Accessories	Manufacturer	Model number	Serial No.	Other
USB cable	N/A	N/A	N/A	Length: 0.3m

2.3. Assistant equipment used for test

Assistant equipment	Manufacturer	Model number	Serial No.	Other
Notebook	DELL	Latitude D610	FCC DOC	00045-534-136-300

2.4. Block diagram of EUT configuration for test

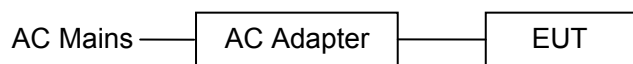

Test software: BK3256 RF Test_V1.3.EXE

The test software was used to control EUT work in Continuous Tx mode, and select test channel, wireless mode as blow table.

Tested mode, channel, information		
Mode	Channel	Frequency (MHz)
GFSK hopping on Tx mode	CH0 to CH78	2402 to 2480
$\pi/4$ -DQPSK hopping on Tx mode	CH0 to CH78	2402 to 2480
8DPSK hopping on Tx mode	CH0 to CH78	2402 to 2480
GFSK hopping off Tx mode	CH0	2402
	CH39	2441
	CH78	2480
$\pi/4$ -DQPSK hopping off Tx mode	CH0	2402
	CH39	2441
	CH78	2480
8DPSK hopping off Tx mode	CH0	2402
	CH39	2441
	CH78	2480

Note: For $\pi/4$ -DQPSK its same modulation type with 8DPSK, and based exploratory test, there is no significant difference of that two types test result, so except output power, except the RF output power, all other items final test were only performed with the worse case 8DPSK and GFSK.

2.5. Deviations of test standard

No Deviation.

2.6. Test environment conditions

During the measurement the environmental conditions were within the listed ranges:

Temperature range:	21-25°C
Humidity range:	40-75%
Pressure range:	86-106kPa

2.7. Test laboratory

Dongguan Dongdian Testing Service Co., Ltd

Add: No. 17, Zongbu Road 2, Songshan Lake Sci&Tech, Industry Park, Dongguan City, Guangdong Province, China, 523808

Tel: +86-0769-89201699, <http://www.dgddt.com>, Email: ddt@dgddt.com

CNAS Accreditation No. L6451; A2LA Accreditation No. 3870.01

Designation Number: CN1182; Test Firm Registration Number: 540522

Industry Canada site registration number: 10288A-1

2.8. Measurement uncertainty

Test Item	Uncertainty
Bandwidth	1.1%
Peak Output Power(Conducted)(Spectrum analyzer)	0.86dB (10 MHz ≤ f < 3.6GHz);
	1.38dB (3.6GHz ≤ f < 8GHz)
Peak Output Power(Conducted)(Power Sensor)	0.74dB
Power Spectral Density	0.74dB (10 MHz ≤ f < 3.6GHz);
	1.38dB (3.6GHz ≤ f < 8GHz)
Frequencies Stability	6.7×10^{-8} (Antenna couple method)
	5.5×10^{-8} (Conducted method)
Conducted spurious emissions	0.86dB (10 MHz ≤ f < 3.6GHz);
	1.40dB (3.6GHz ≤ f < 8GHz)
	1.66dB (8GHz ≤ f < 22GHz)
Uncertainty for radio frequency (RBW<20kHz)	3×10^{-8}
Temperature	0.4℃
Humidity	2%
Uncertainty for Radiation Emission test (30MHz-1GHz)	4.70 dB (Antenna Polarize: V)
	4.84 dB (Antenna Polarize: H)
Uncertainty for Radiation Emission test (1GHz-40GHz)	4.10dB (1-6GHz)
	4.40dB (6GHz-18GHz)
	3.54dB (18GHz-26GHz)
	4.30dB (26GHz-40GHz)
Uncertainty for Power line conduction emission test	3.32dB (150kHz-30MHz)
Note: This uncertainty represents an expanded uncertainty expressed at approximately the 95% confidence level using a coverage factor of k=2.	

3. Equipment used during test

Equipment	Manufacturer	Model No.	Serial No.	Last Cal.	Cal. Interval
RF Connected Test (Tonscend RF Measurement System)					
Spectrum analyzer	R&S	FSU26	200071	Oct. 23, 2017	1 Year
Wideband Radio Communication tester	R&S	CMW500	117491	Jun. 16, 2017	1 Year
Vector Signal Generator	Agilent	E8267D	US49060192	Oct. 23, 2017	1 Year
Vector Signal Generator	Agilent	N5182A	MY48180737	Jun.16, 2017	1 Year
Power Sensor	Agilent	U2021XA	MY55150010	Oct. 21, 2017	1 Year
Power Sensor	Agilent	U2021XA	MY55150011	Oct. 23, 2017	1 Year
DC Power Source	MATRIS	MPS-3005L-3	D813058W	Aug. 18, 2017	1 Year
Attenuator	Mini-Circuits	BW-S10W2	101109	Aug. 18, 2017	1 Year
RF Cable	Micable	C10-01-01-1	100309	Oct. 21, 2017	1 Year
Temp&Humi Programmable	ZHIXIANG	ZXGDJS-150L	ZX170110-A	Oct. 21, 2017	1 Year
Test Software	JS Tonscend	JS1120-3	Ver.2.7	N/A	N/A
Radiated Emission Test Chamber 1#					
EMI Test Receiver	R&S	ESU8	100316	Oct. 21, 2017	1 Year
Spectrum analyzer	Agilent	E4447A	MY50180031	Jun. 16, 2017	1 Year
Trilog Broadband Antenna	Schwarzbeck	VULB9163	9163-462	Nov. 09, 2017	1 Year
Active Loop antenna	Schwarzbeck	FMZB-1519	1519-038	Oct. 17, 2017	1 Year
Double Ridged Horn Antenna	R&S	HF907	100276	Oct. 17, 2017	1 Year
Broad Band Horn Antenna	Schwarzbeck	BBHA 9170	790	Nov. 09, 2017	1 Year
Pre-amplifier	A.H.	PAM-0118	360	Oct. 21, 2017	1 Year
Pre-amplifier	TERA-MW	TRLA-0040 G35	101303	Oct. 21, 2017	1 Year
RF Cable	HUBSER	CP-X2+ CP-X1	W11.03+ W12.02	Oct. 21, 2017	1 Year
RF Cable	N/A	SMAJ-SMA J-1M+ 11M	17070133+17070131	Nov. 08, 2017	1 Year
MI Cable	HUBSER	C10-01-01-1 M	1091629	Oct. 21, 2017	1 Year
Test software	Audix	E3	V 6.11111b	N/A	N/A
Power Line Conducted Emissions Test					
EMI Test Receiver	R&S	ESU8	100316	Oct. 21, 2017	1 Year
LISN 1	R&S	ENV216	101109	Oct. 21, 2017	1 Year
LISN 2	R&S	ESH2-Z5	100309	Oct. 21, 2017	1 Year
Pulse Limiter	R&S	ESH3-Z2	101242	Oct. 21, 2017	1 Year
CE Cable 1	HUBSER	N/A	W10.01	Oct. 21, 2017	1 Year
Test software	Audix	E3	V 6.11111b	N/A	N/A

4. Maximum Peak Output Power

4.1. Block diagram of test setup

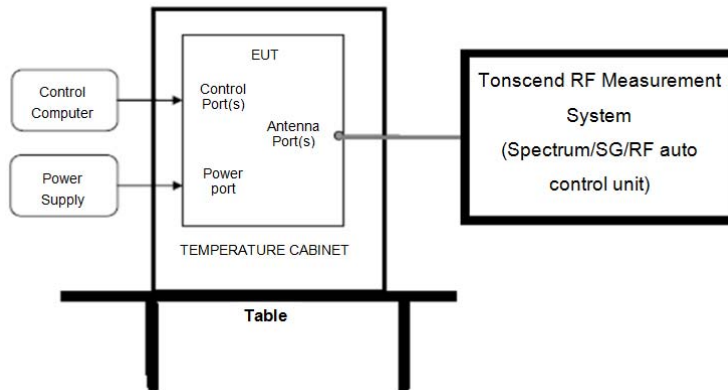

4.2. Limits

For frequency hopping systems operating in the 2400-2483.5 MHz band employing at least 75 non-overlapping hopping channels, and all frequency hopping systems in the 5725-5850 MHz band: 1 watt. For all other frequency hopping systems in the 2400-2483.5 MHz band: 0.125 watts, the e.i.r.p shall not exceed 4W.

4.3. Test Procedure

- (1) Connect EUT's antenna output to spectrum analyzer by RF cable.
- (2) Measure the maximum output power of EUT by spectrum analyzer with PK detector and RBW=3MHz(above 20dB bandwidth of measured signal), VBW=10MHz

Note: The attenuator loss was inputted into spectrum analyzer as amplitude offset.

4.4. Test Result

Mode	Freq (MHz)	Result (dBm)	Limit (dBm)	Conclusion
GFSK	2402	0.22	21	PASS
	2441	-0.14	21	PASS
	2480	0.03	21	PASS
$\pi/4$ -DQPSK	2402	-0.33	21	PASS
	2441	-0.70	21	PASS
	2480	-0.52	21	PASS
8DPSK	2402	-0.33	21	PASS
	2441	-0.65	21	PASS
	2480	-0.49	21	PASS

4.5. Original test data

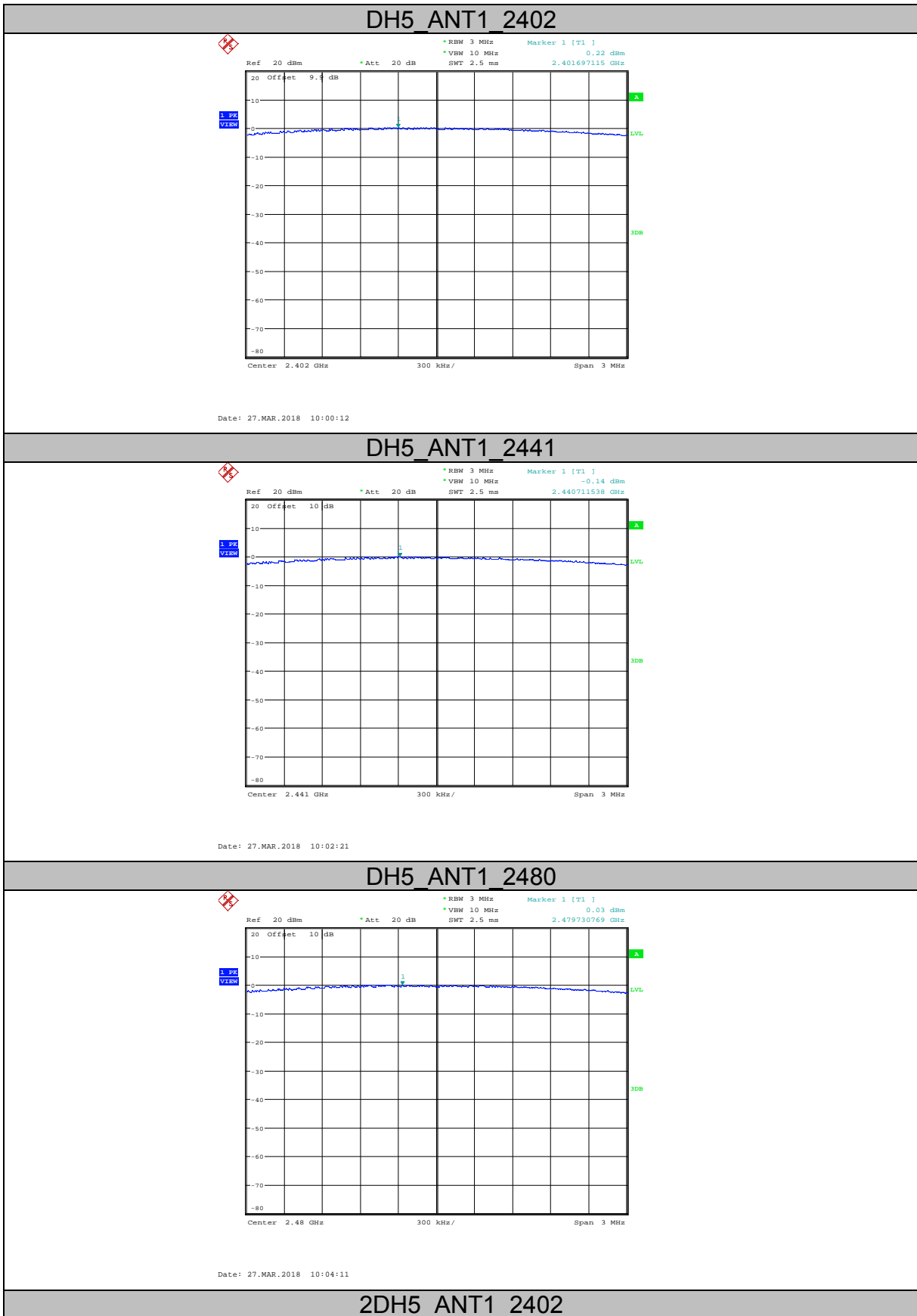

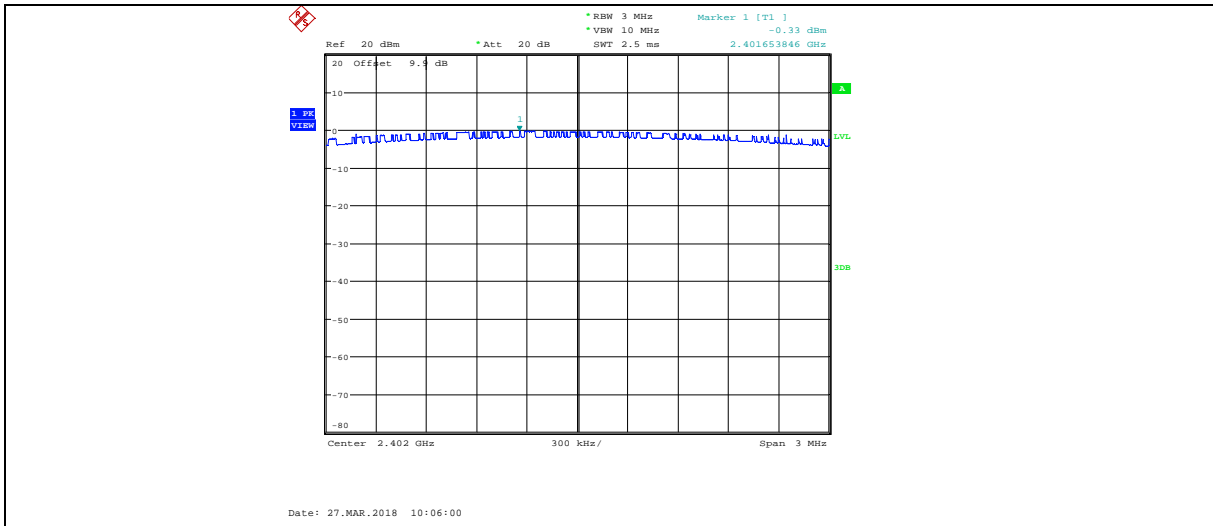

2DH5_ANT1_2441

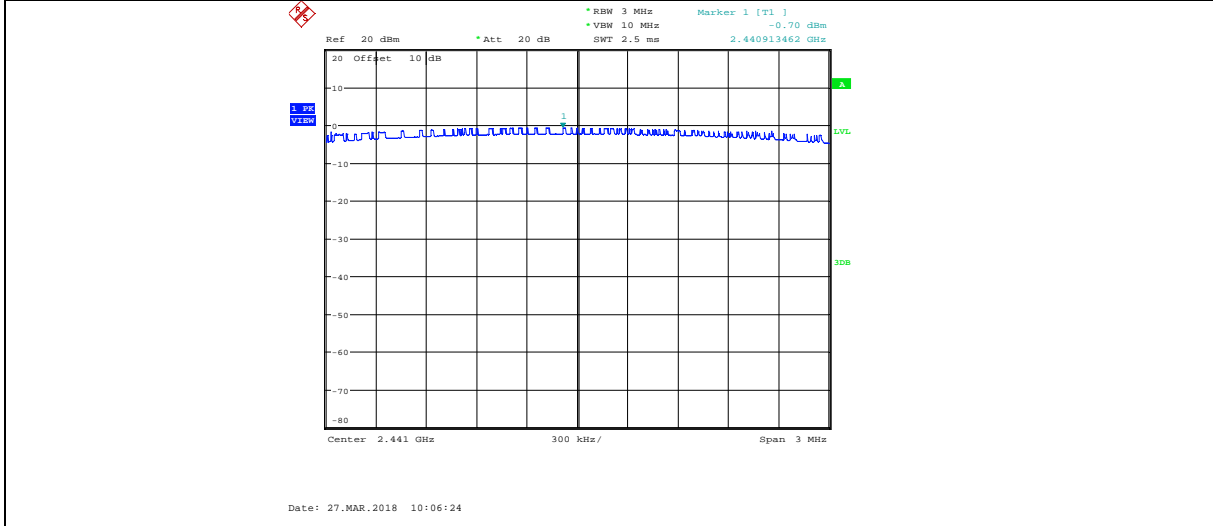

2DH5_ANT1_2480

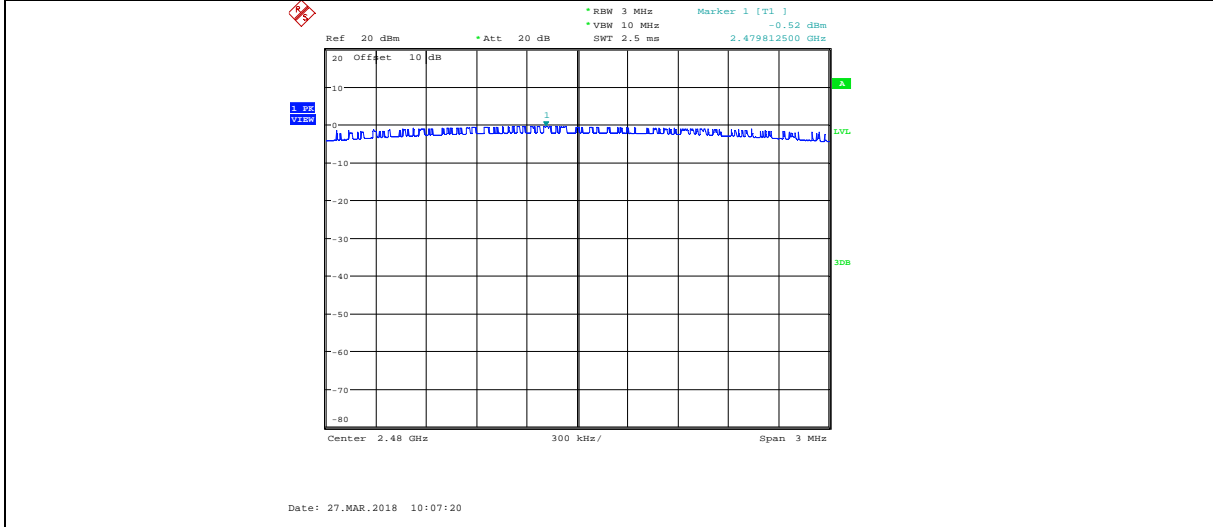

3DH5_ANT1_2402

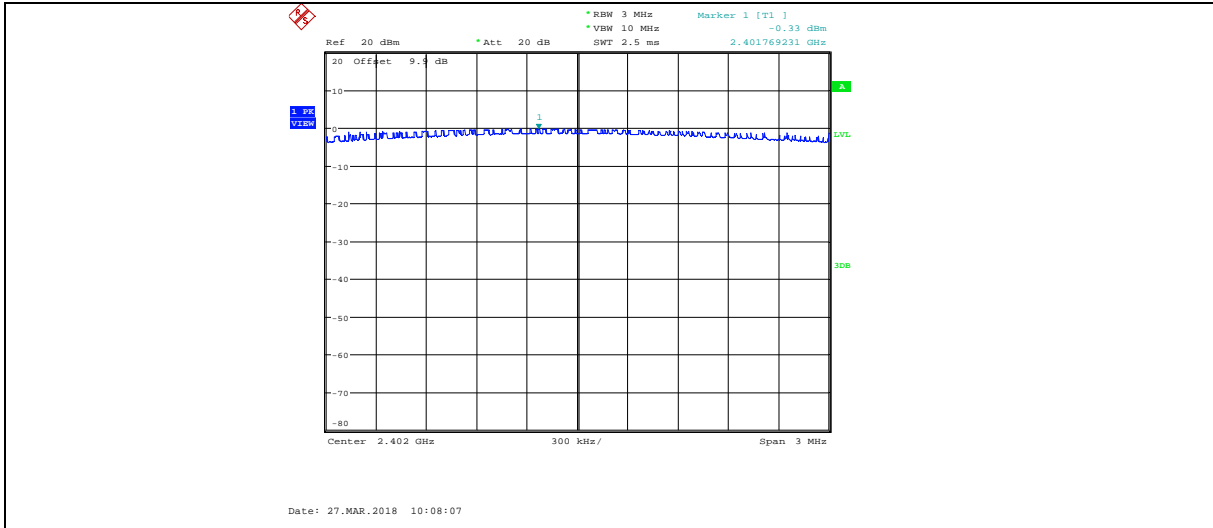

3DH5 ANT1 2441

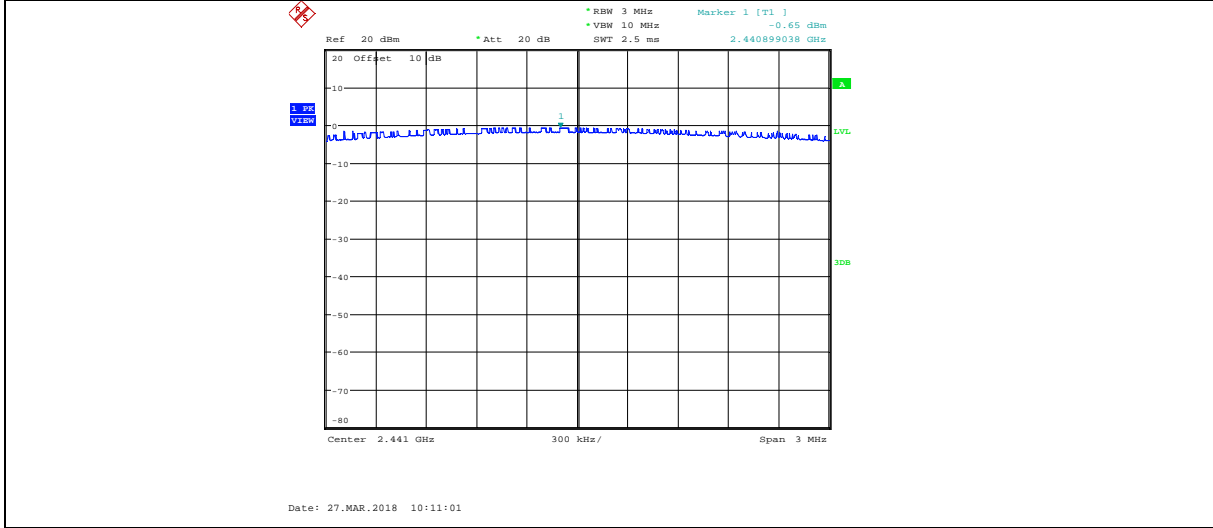

3DH5 ANT1 2480

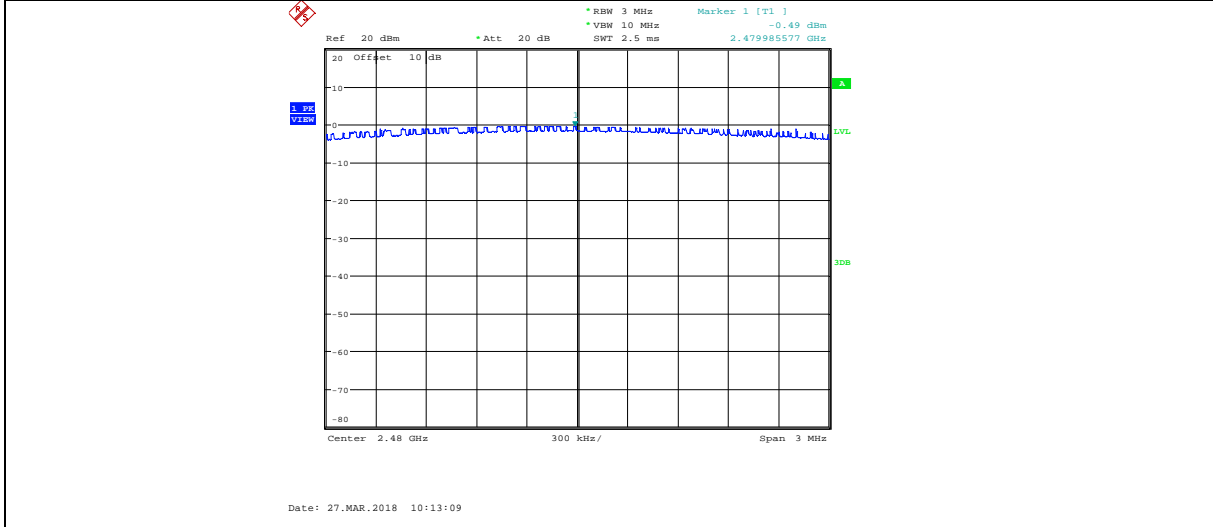

5. 20dB Bandwidth and 99% Bandwidth

5.1. Block diagram of test setup

Same as section 4.1

5.2. Limits

Intentional radiators operating under the alternative provisions to the general emission limits, as contained in § 15.217 through 15.257 and in Subpart E of this part, must be designed to ensure that the 20 dB bandwidth of the emission, or whatever bandwidth may otherwise be specified in the specific rule section under which the equipment operates, is contained within the frequency band designated in the rule section under which the equipment is operated.

5.3. Test Procedure

- (1) Connect EUT's antenna output to spectrum analyzer by RF cable.
- (2) The bandwidth of the fundamental frequency was measured by spectrum analyzer with 30 kHz RBW and 100 kHz VBW. The 20dB bandwidth is defined as the total spectrum the power of which is higher than peak power minus 20dB.

5.4. Test Result

Mode	Freq. (MHz)	20dB bandwidth Result (MHz)	99% bandwidth Result (MHz)	Conclusion
GFSK	2402	1.104	0.972	PASS
	2441	1.098	0.960	PASS
	2480	1.050	0.960	PASS
8DPSK	2402	1.350	1.287	PASS
	2441	1.362	1.299	PASS
	2480	1.362	1.413	PASS

5.5. Original test data

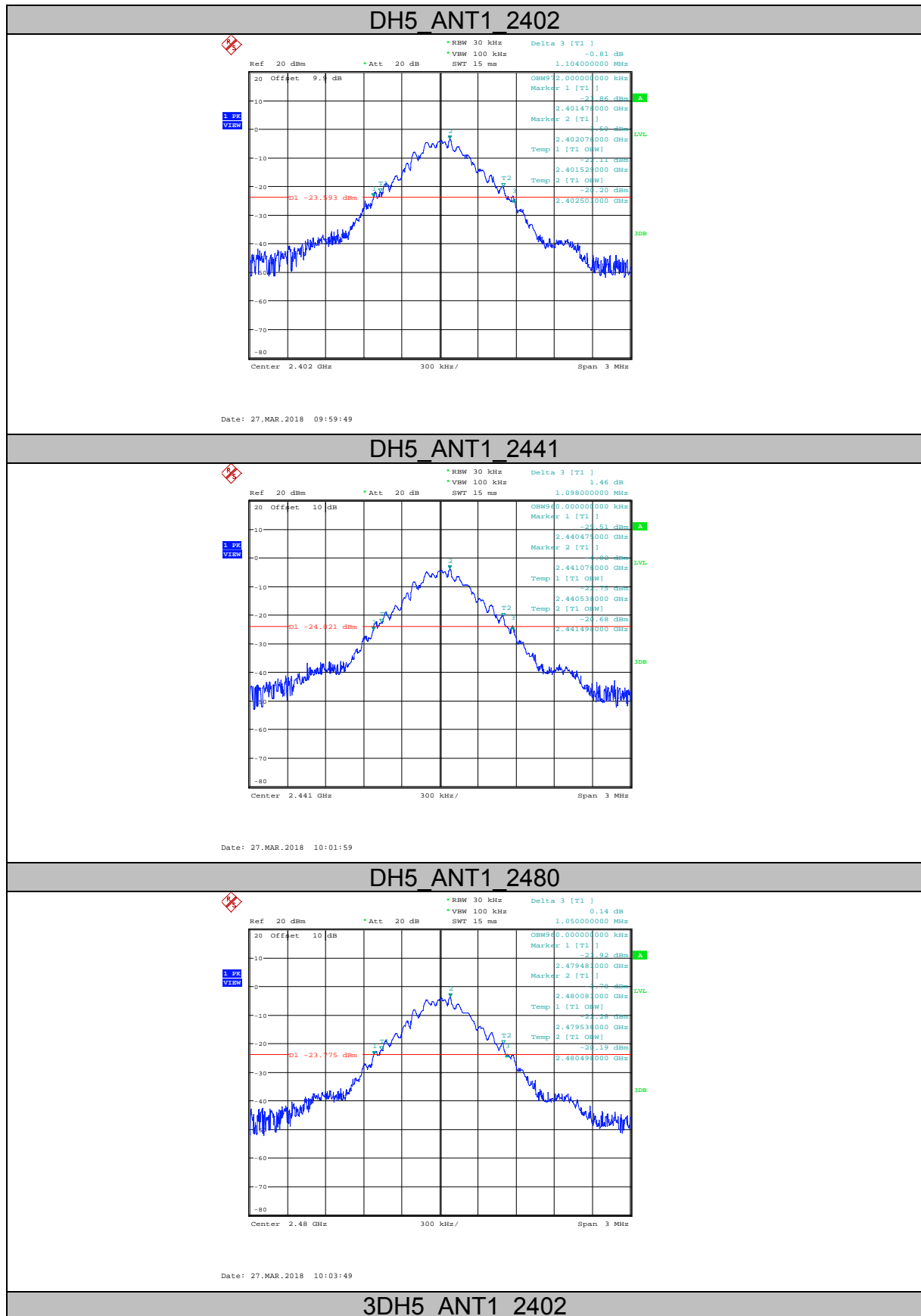

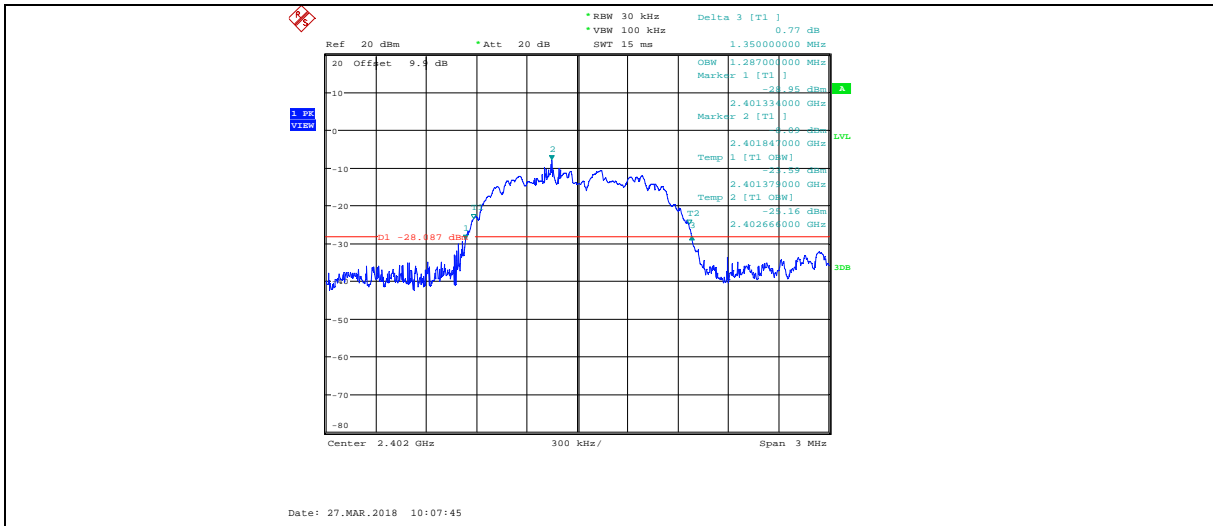

3DH5 ANT1 2441

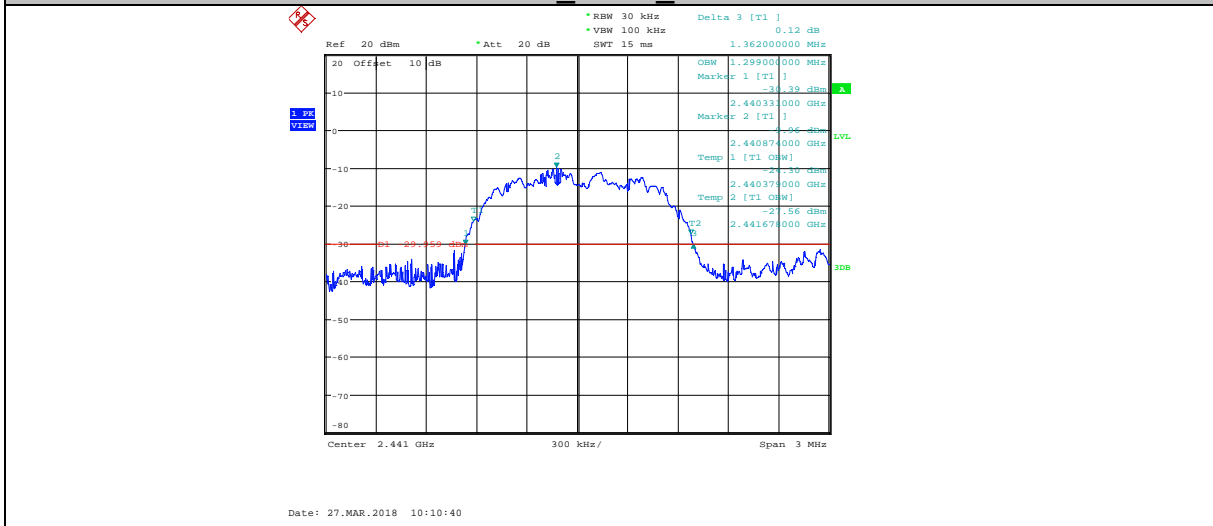

3DH5 ANT1 2480

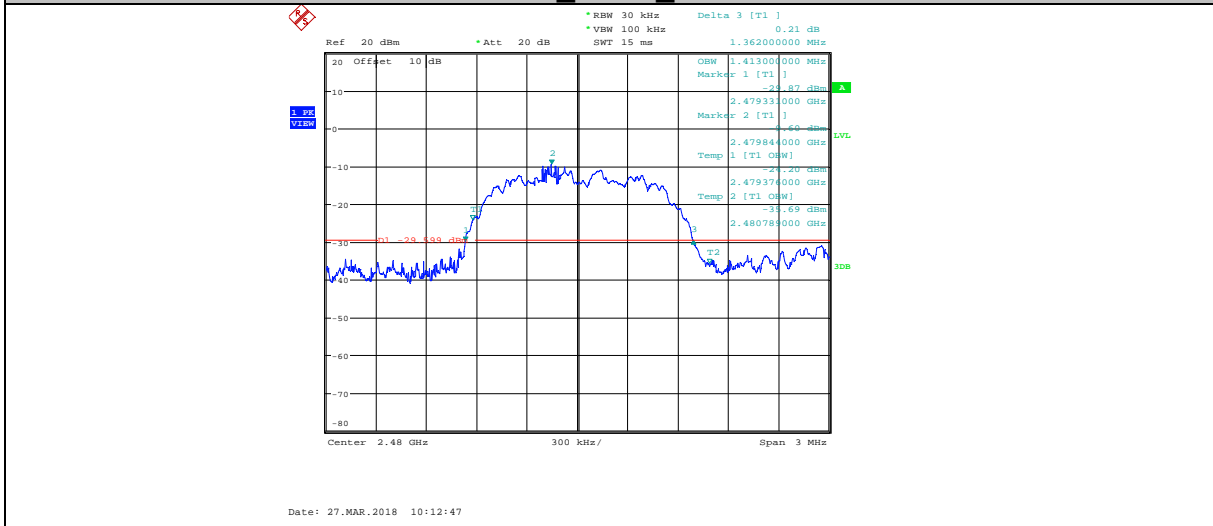

6. Carrier Frequency Separation

6.1. Block diagram of test setup

Same as section 4.1

6.2. Limits

Frequency hopping systems shall have hopping channel carrier frequencies separated by a minimum of 25 kHz or the 20 dB bandwidth of the hopping channel, whichever is greater. Alternatively, frequency hopping systems operating in the 2400-2483.5 MHz band may have hopping channel carrier frequencies that are separated by 25 kHz or two-thirds of the 20 dB bandwidth of the hopping channel, whichever is greater, provided the systems operate with an output power no greater than 125 mW.

6.3. Test Procedure

- (1) Connect EUT's antenna output to spectrum analyzer by RF cable.
- (2) The carrier frequency was measured by spectrum analyzer with 100 kHz RBW and 300 kHz VBW.

6.4. Test Result

Mode	Channel separation (MHz)	20dB bandwidth (MHz) (worse case)	Limit (MHz) 2/3 of 20dB bandwidth	Conclusion
GFSK	0.990	1.104	≥0.736	PASS
8DPSK	1.026	1.362	≥0.908	PASS

6.5. Original test data

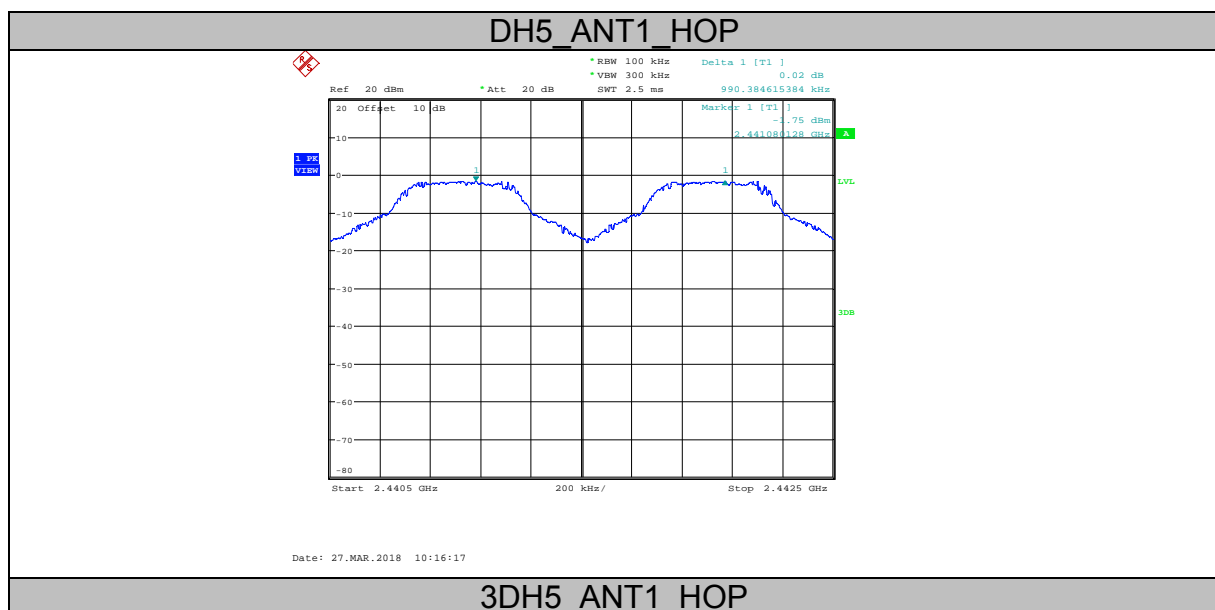

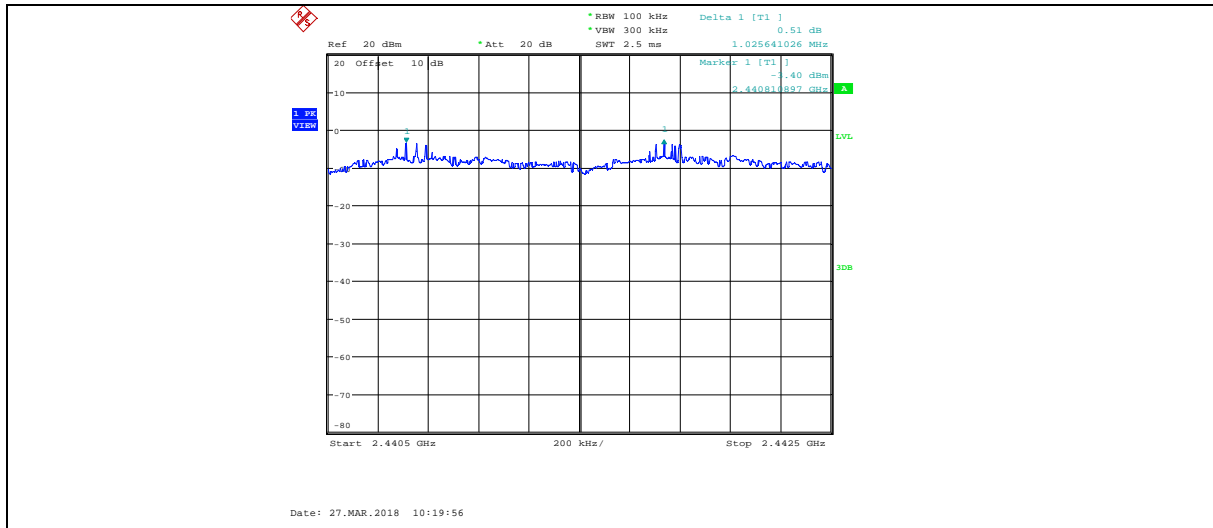

7. Number Of Hopping Channel

7.1. Block diagram of test setup

Same as section 4.1

7.2. Limits

Frequency hopping systems in the 2400-2483.5 MHz band shall use at least 15 channels.

7.3. Test Procedure

- (1) Connect EUT's antenna output to spectrum analyzer by RF cable.
- (2) The number of hopping channel was measured by spectrum analyzer with 100 kHz RBW and 300 kHz VBW.

7.4. Test Result

Mode	Number of hopping channel	Limit	Conclusion
GFSK	79	>15	PASS
8DPSK	79	>15	PASS

7.5. Original test data

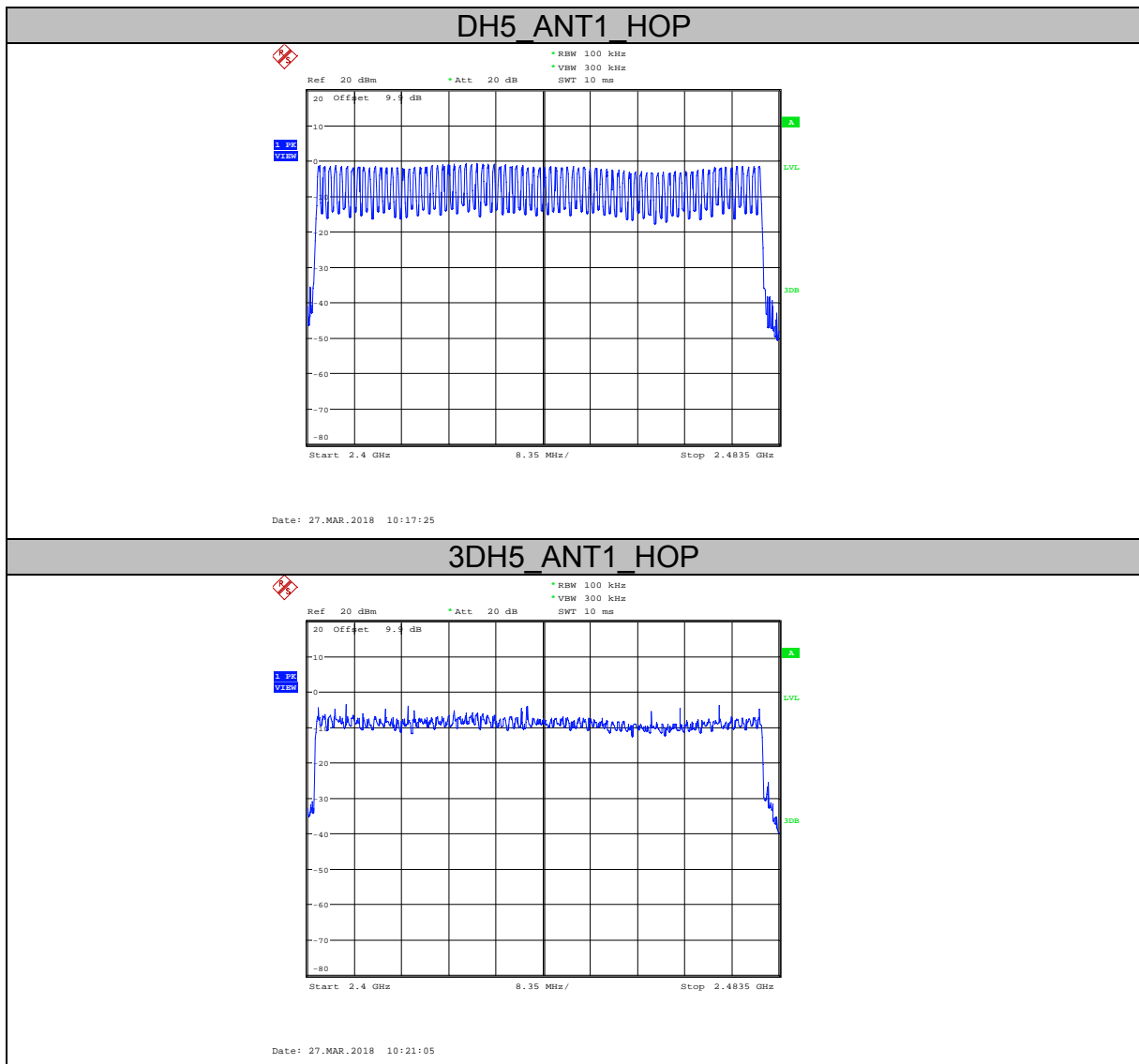

8. Dwell Time

8.1. Block diagram of test setup

Same as section 4.1

8.2. Limits

The average time of occupancy on any channel shall not be greater than 0.4 seconds within a period of 0.4 seconds multiplied by the number of hopping channels employed.

8.3. Test Procedure

- (1) Connect EUT's antenna output to spectrum analyzer by RF cable.
- (2) The test period: $T = 0.4 \text{ Second/Channel} \times 79 \text{ Channel} = 31.6 \text{ s}$
- (3) Measure the hopping number and on time of each pulse with spectrum analyzer in zero span set, and calculate dwell time with formula $\text{Dwell time} = \text{total hops} \times \text{pulse's on time}$.

8.4. Test Result

Mode	Dwell time (s)	Pulse's on time (ms)	Total hops	Limit	Conclusion
DH1	0.117	0.39	304	<400ms	PASS
DH3	0.265	1.74	152	<400ms	PASS
DH5	0.289	2.75	105	<400ms	PASS
3-DH1	0.073	0.24	305	<400ms	PASS
3-DH3	0.268	1.76	152	<400ms	PASS
3-DH5	0.305	2.93	104	<400ms	PASS

Note: $\text{Dwell time} = \text{total hops} \times \text{pulse's on time}$.

8.5. Original test data

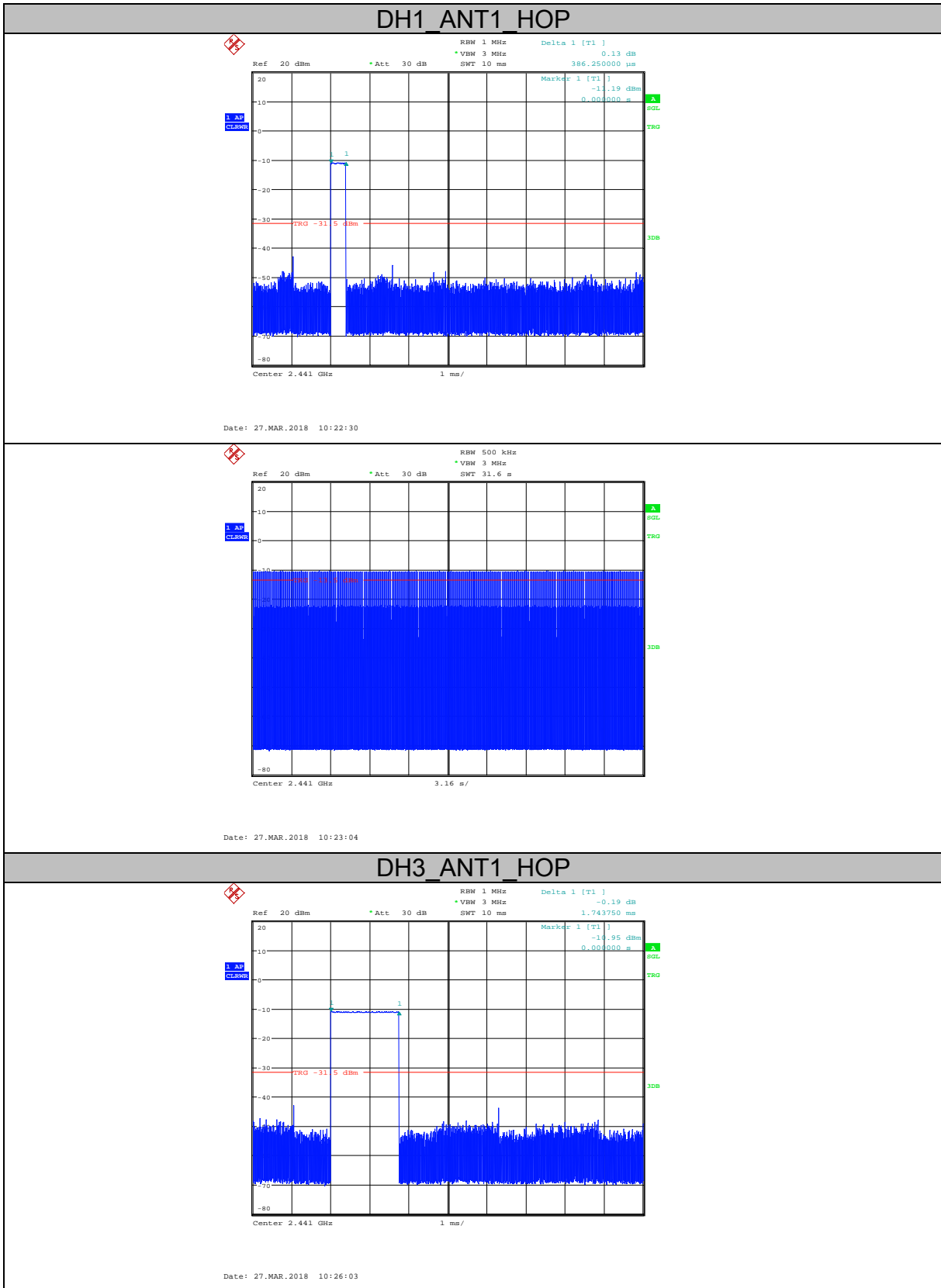

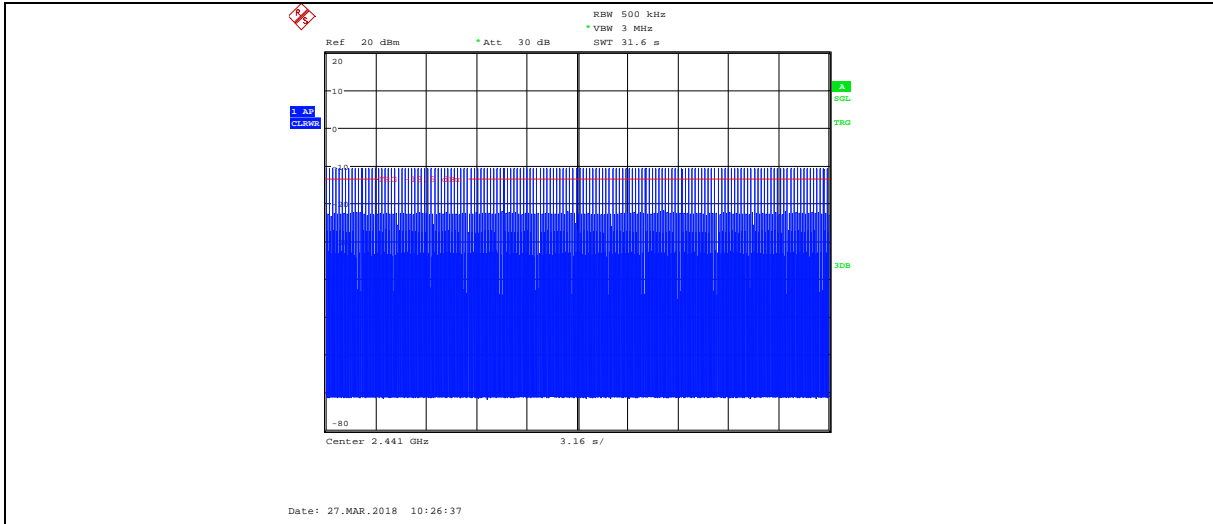

DH5 ANT1 HOP

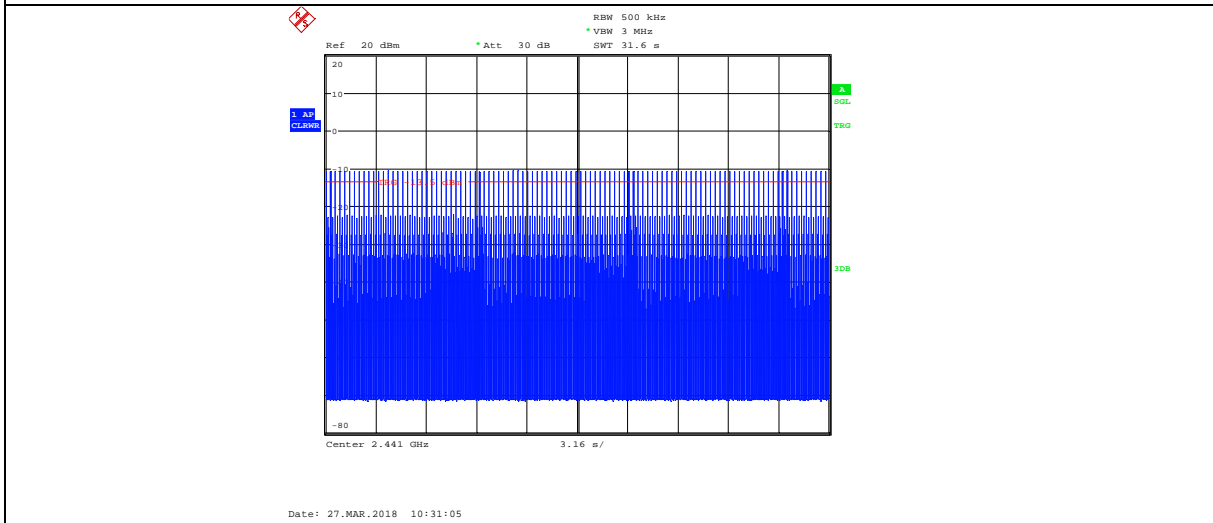
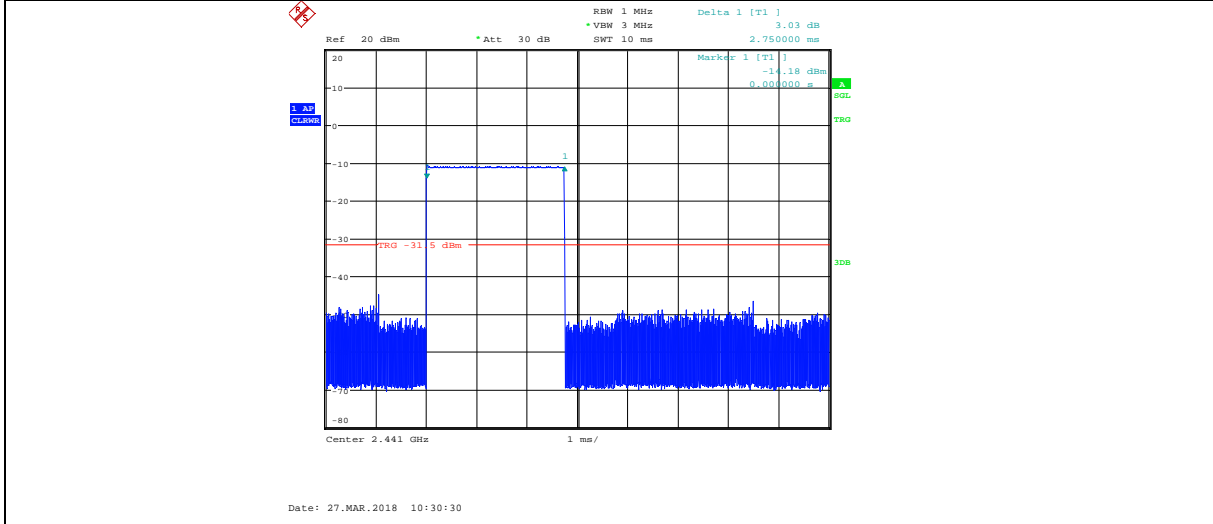

3DH1 ANT1 HOP

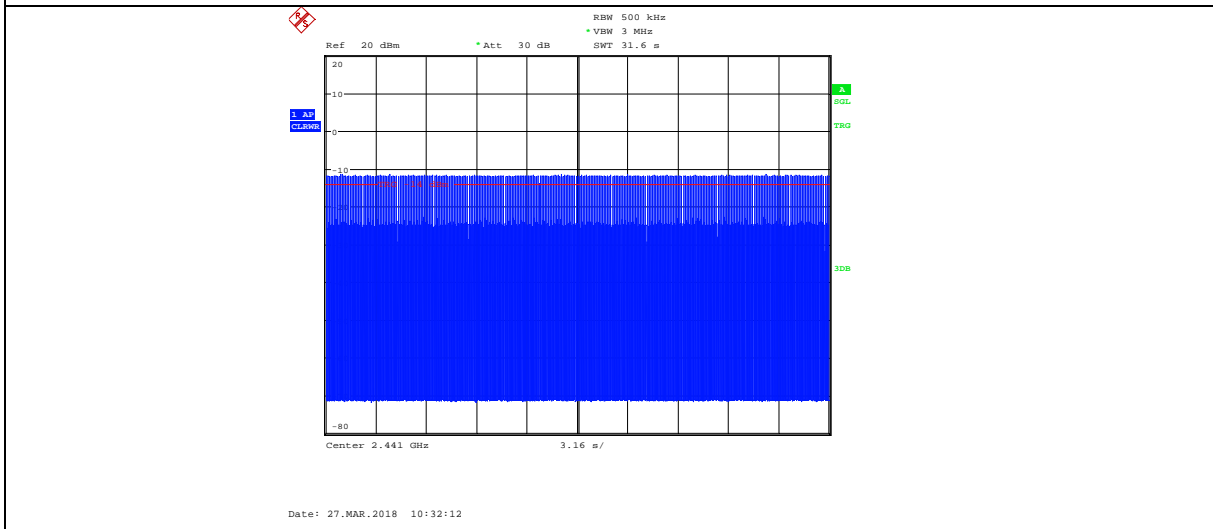
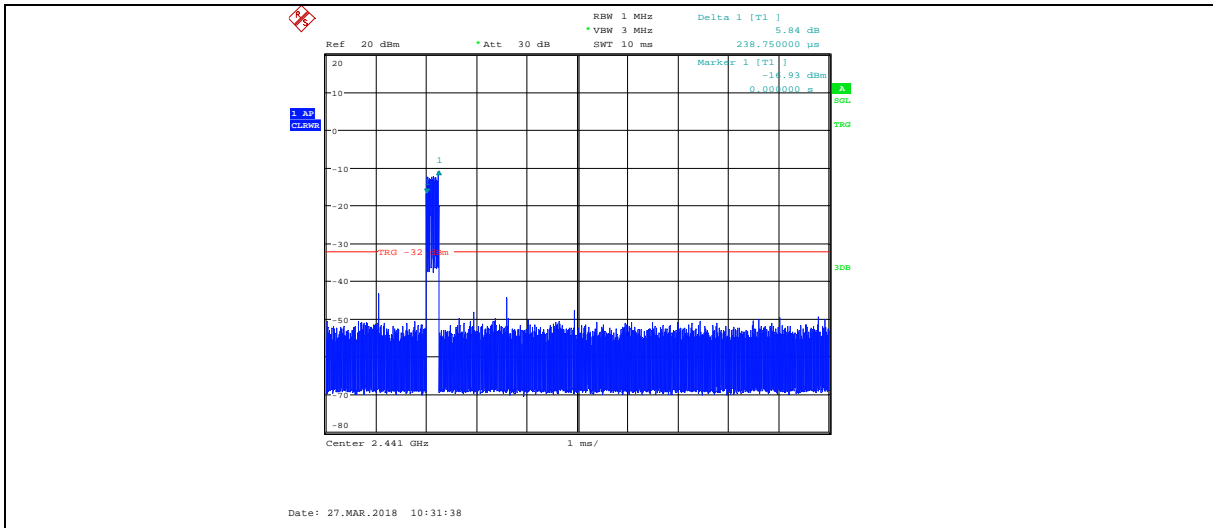

3DH3 ANT1 HOP

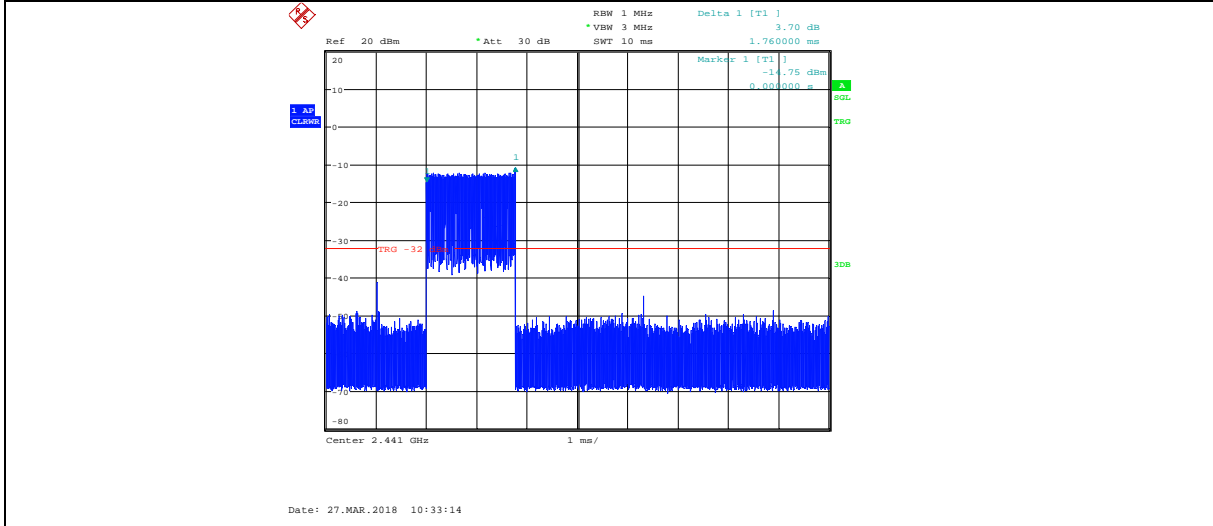

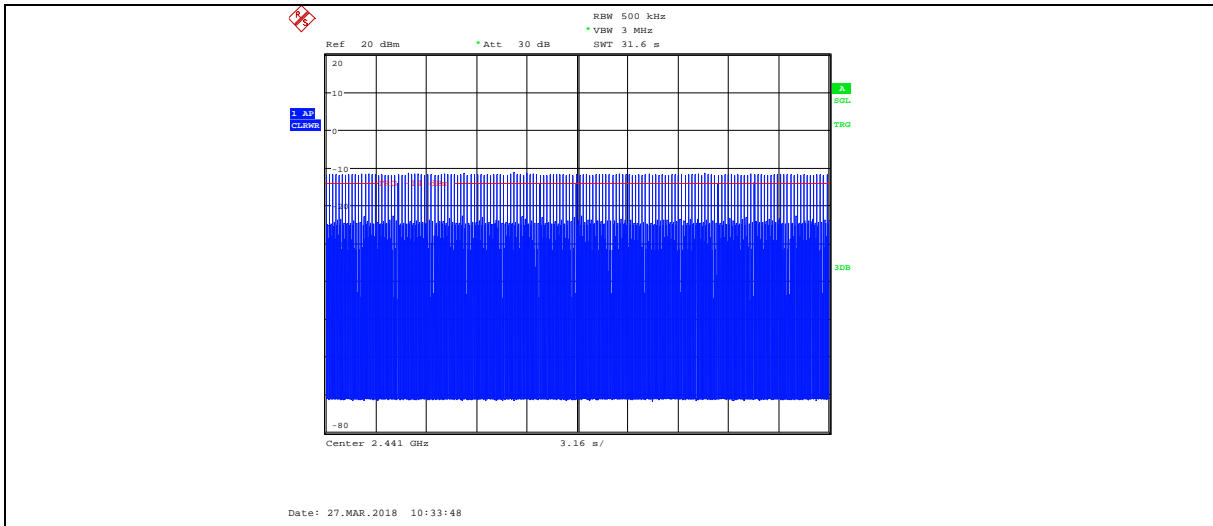

3DH5 ANT1 HOP

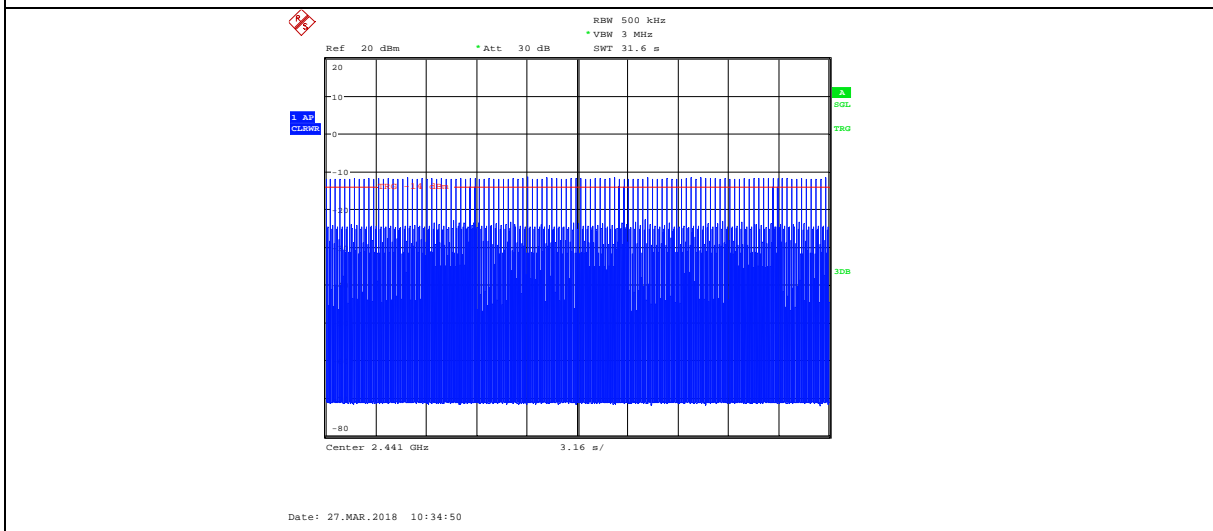
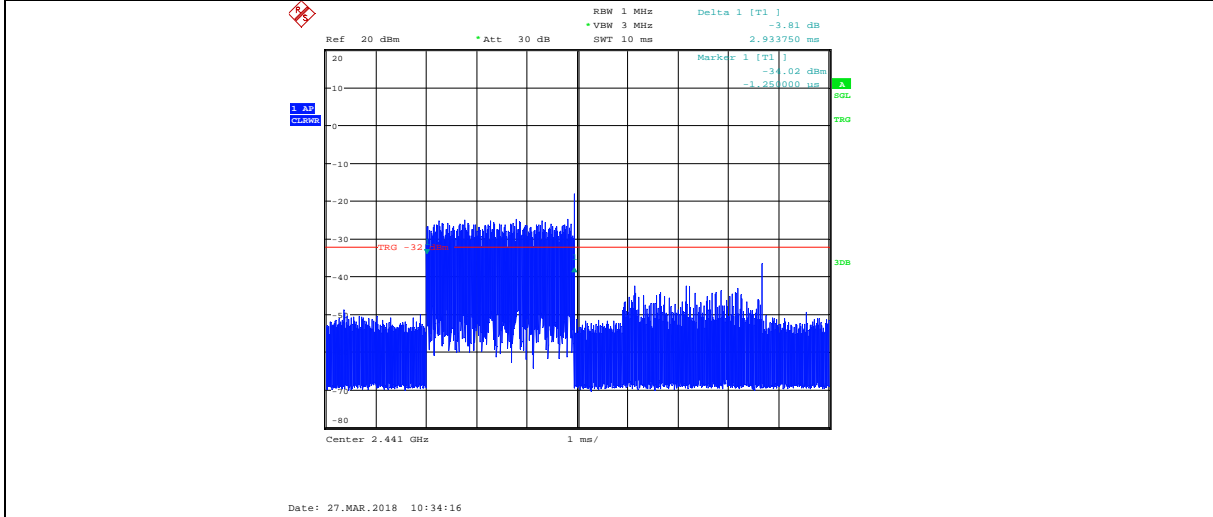

9. Band Edge Compliance (conducted method)

9.1. Block diagram of test setup

Same as section 4.1

9.2. Limit

All restriction band should comply with 15.209, other emission should be at least 20dB blow the fundamental.

9.3. Test result

Mode	Freq (MHz)	Conclusion
GFSK	Hopping off 2402	PASS
	Hopping off 2480	PASS
	Hopping on	PASS
8DPSK	Hopping off 2402	PASS
	Hopping off 2480	PASS
	Hopping on	PASS

9.4. Original test data

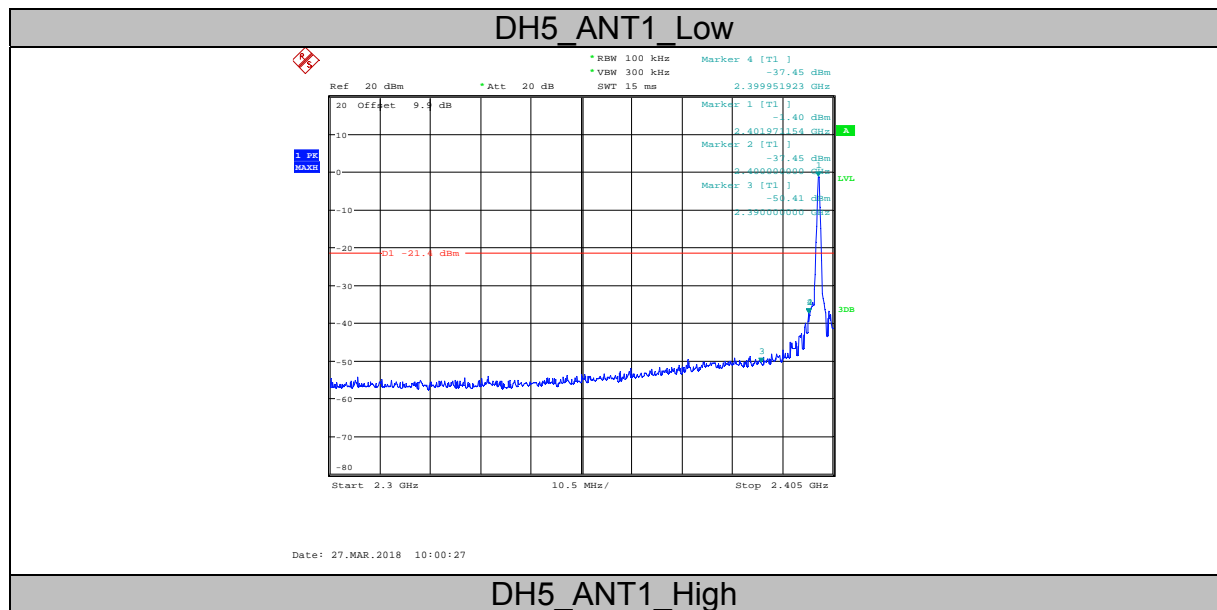

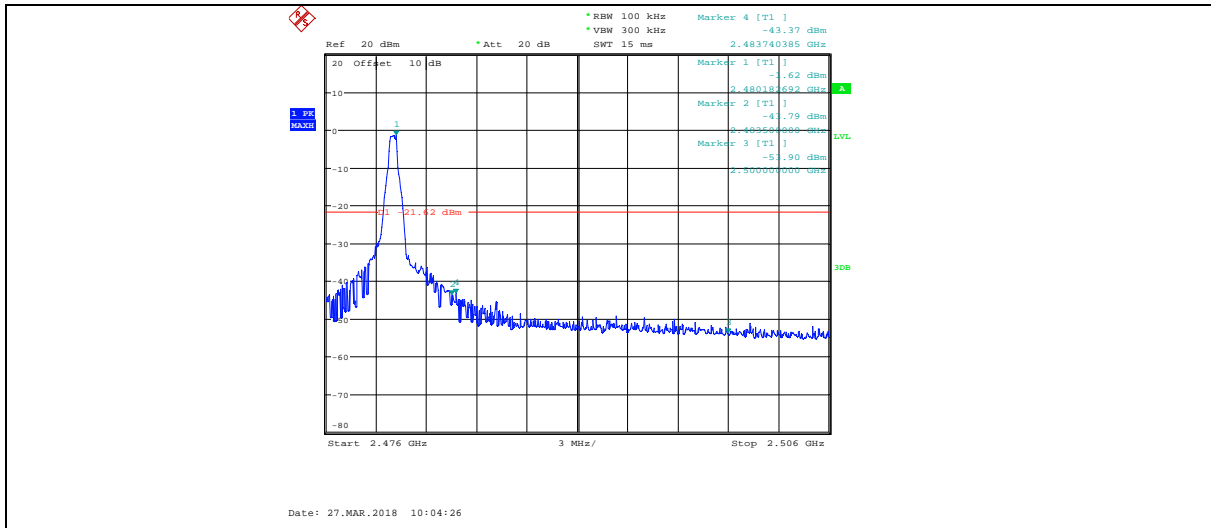

DH5_ANT1_Low

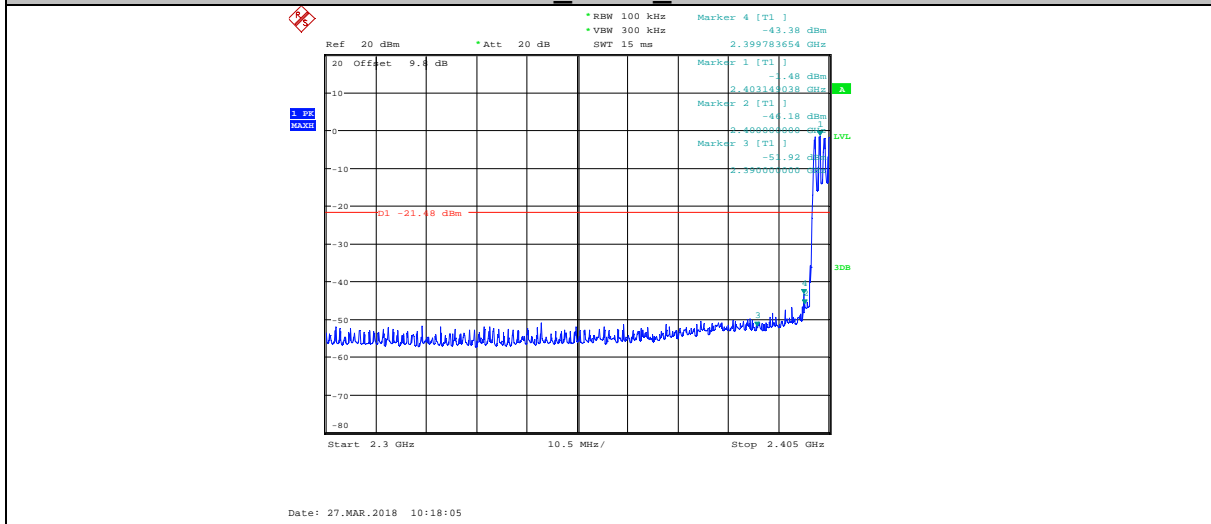

DH5_ANT1_High

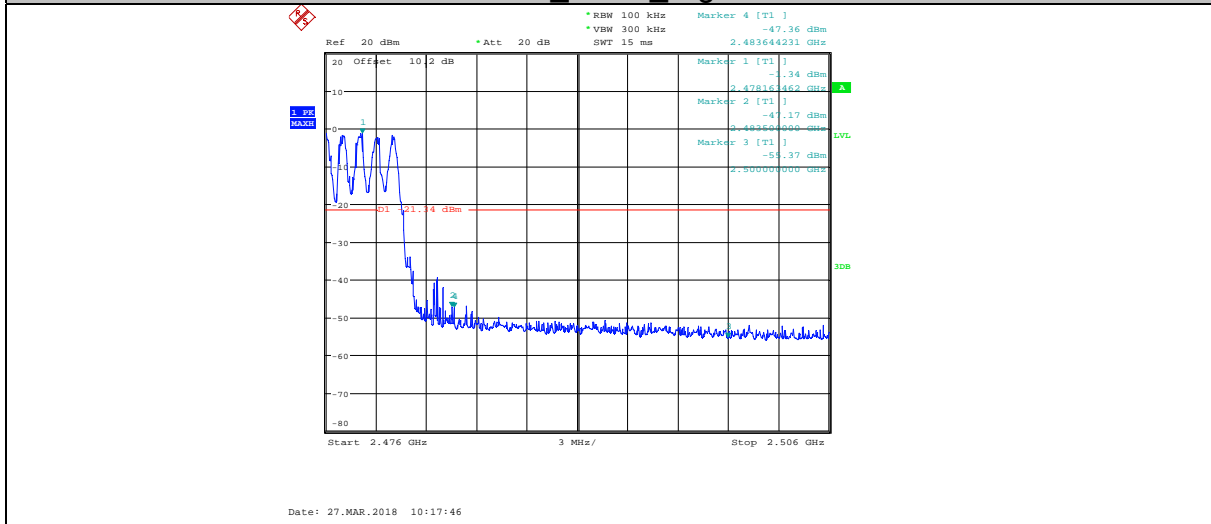

3DH5_ANT1_Low

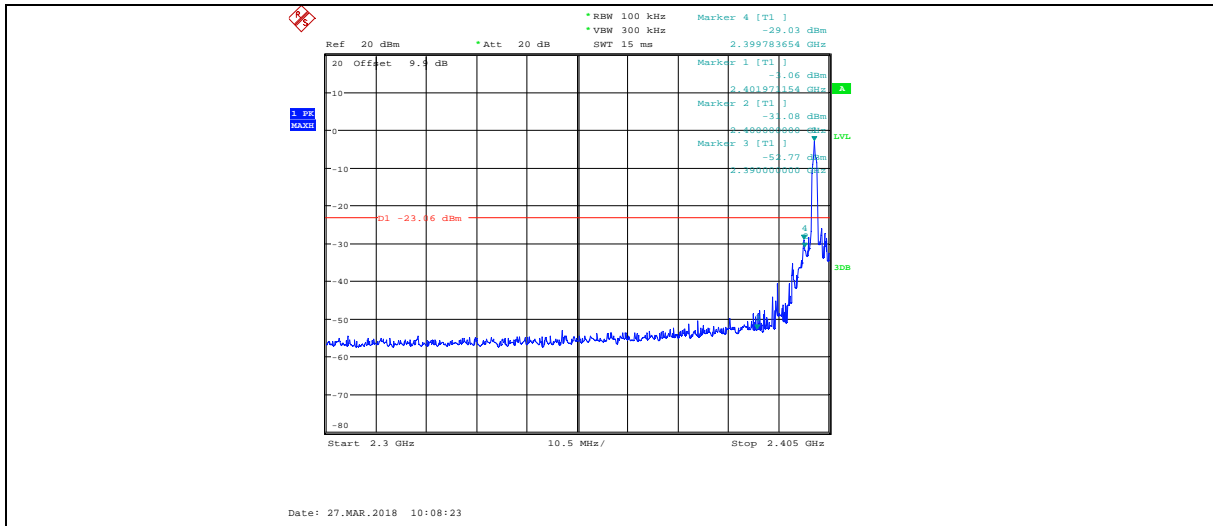

3DH5 ANT1 High

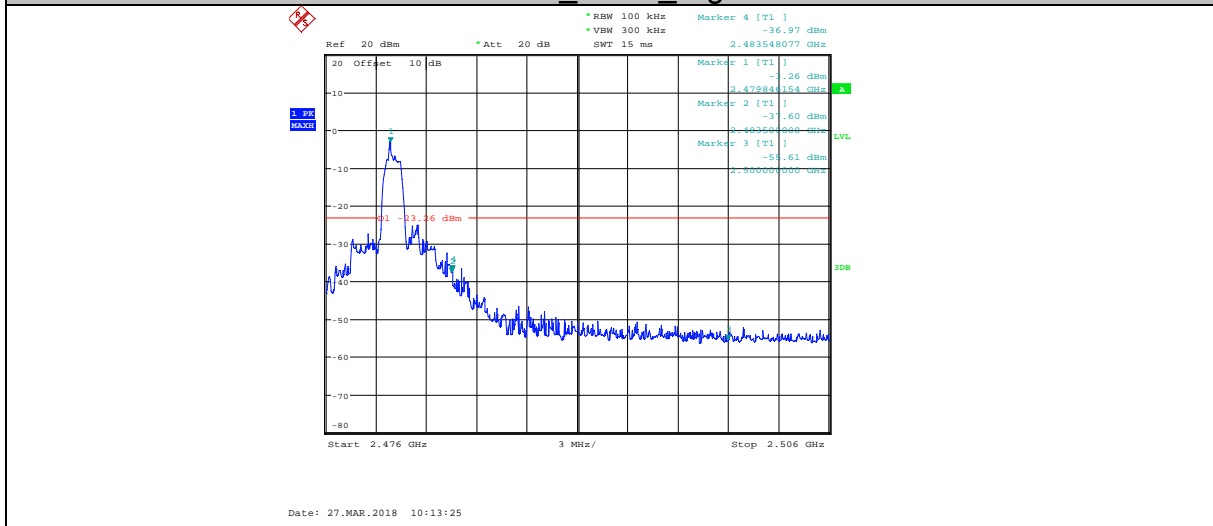

3DH5 ANT1 Low

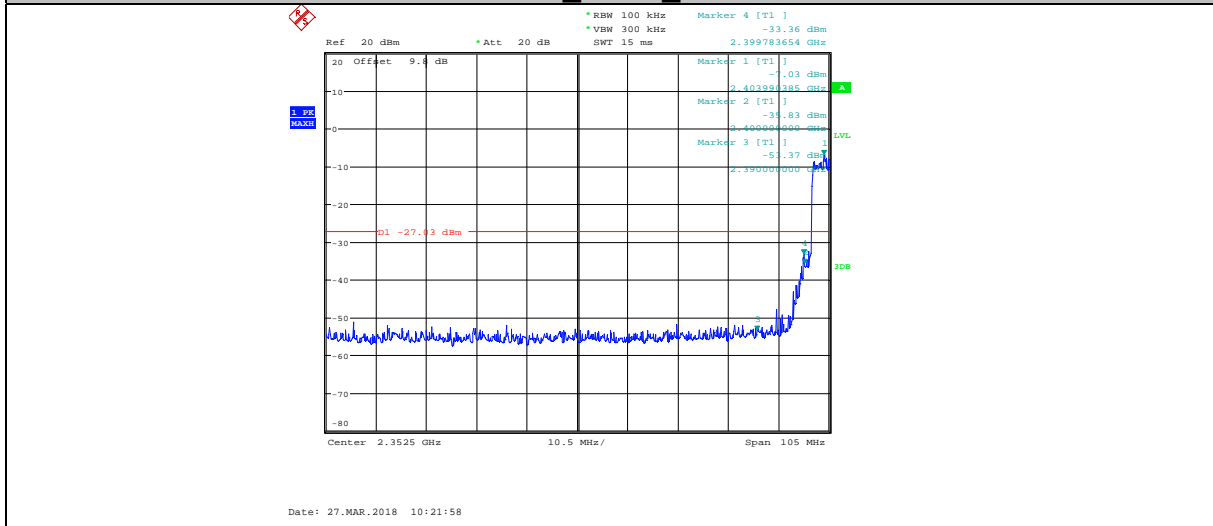

3DH5 ANT1 High

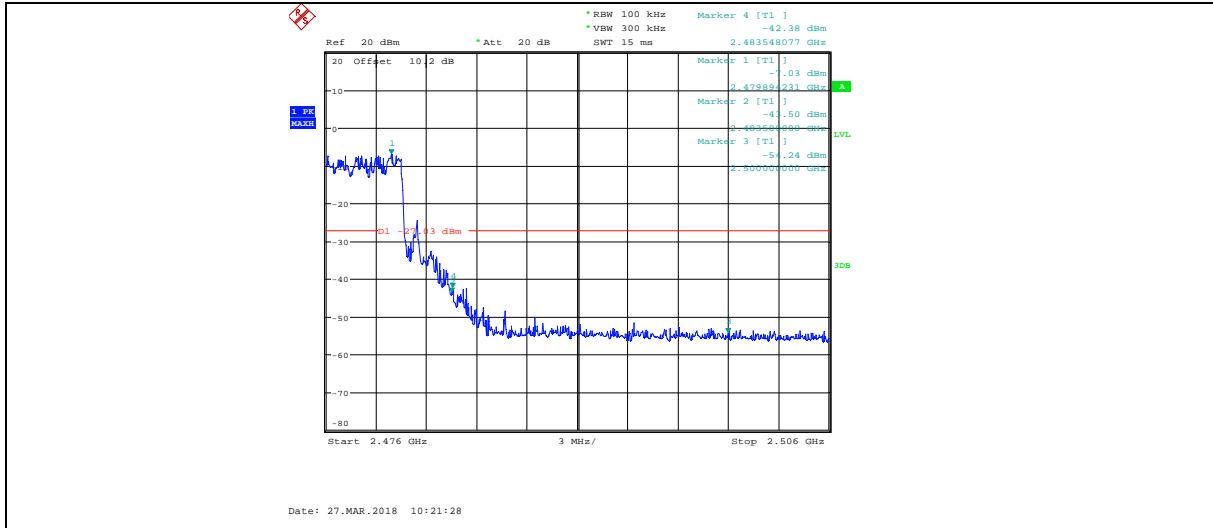

10. Radiated emission

10.1. Block diagram of test setup

In 3m Anechoic Chamber Test Setup Diagram for 9kHz-30MHz

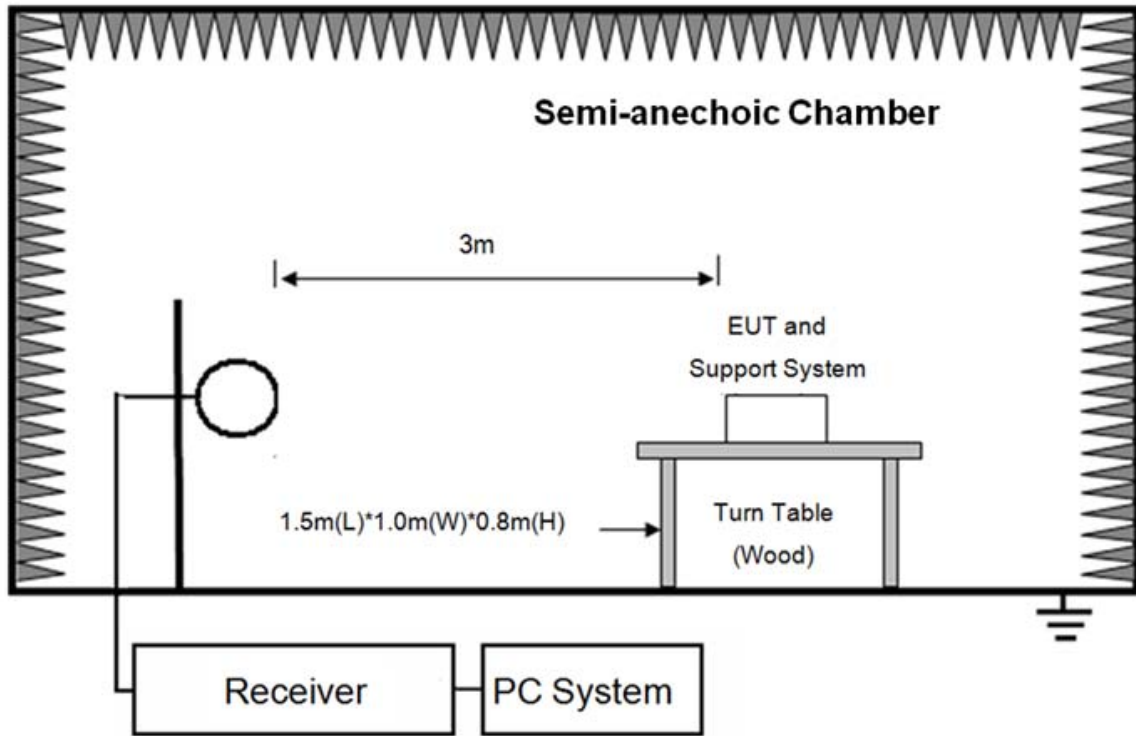

In 3m Anechoic Chamber Test Setup Diagram for below 1GHz

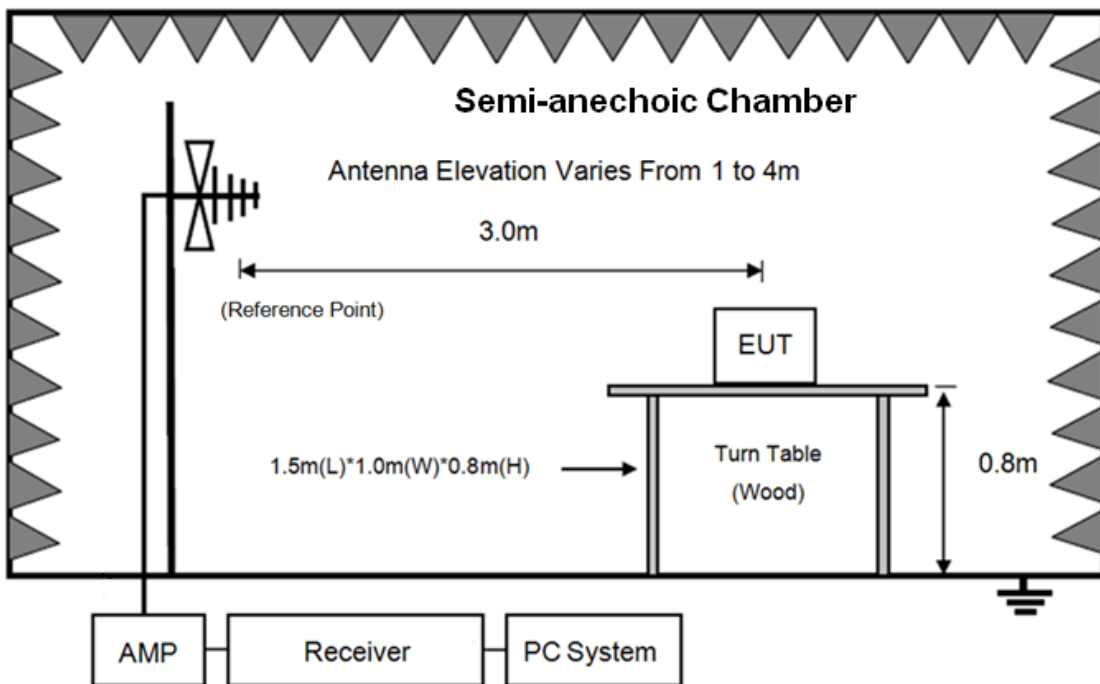

In 3m Anechoic Chamber Test Setup Diagram for frequency above 1GHz

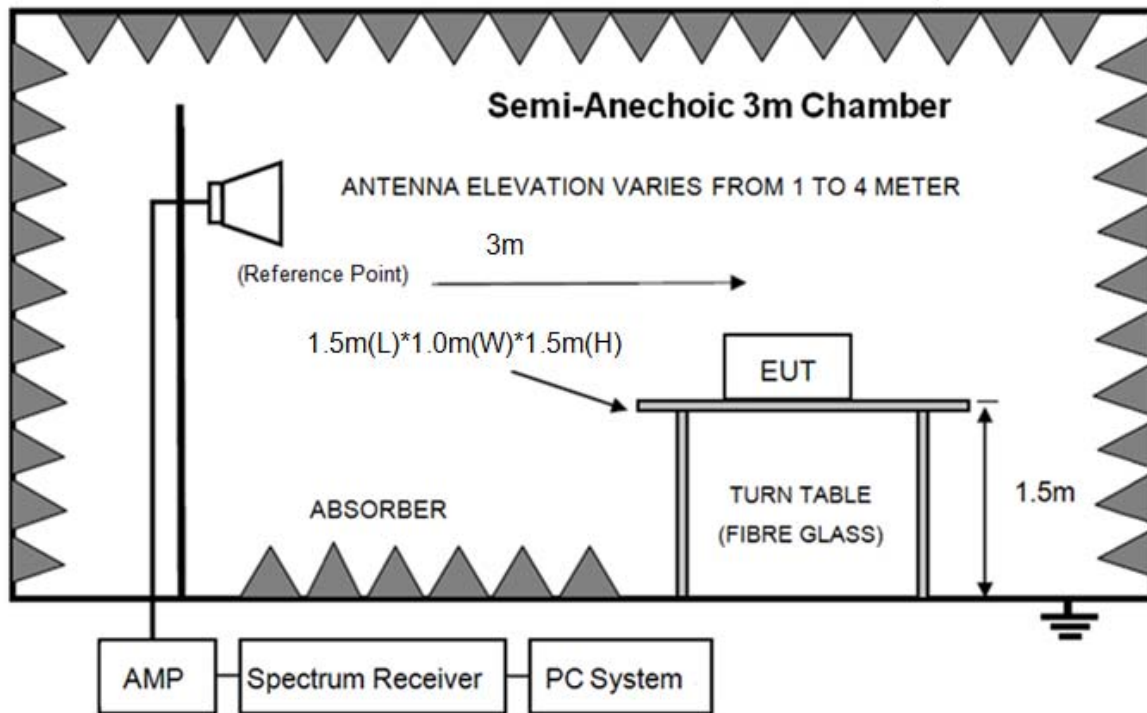

Note: For harmonic emissions test a appropriate high pass filter was inserted in the input port of AMP.

10.2. Limit

(1) FCC 15.205 Restricted frequency band

MHz	MHz	MHz	GHz
0.090-0.110	16.42-16.423	399.9-410	4.5-5.15
10.495-0.505	16.69475-16.69525	608-614	5.35-5.46
2.1735-2.1905	16.80425-16.80475	960-1240	7.25-7.75
4.125-4.128	25.5-25.67	1300-1427	8.025-8.5
4.1772&4.1775	37.5-38.25	1435-1626.5	9.0-9.2
4.2072&4.2075	73-74.6	1645.5-1646.5	9.3-9.5
6.215-6.218	74.8-75.2	1660-1710	10.6-12.7
6.26775-6.26825	108-121.94	1718.8-1722.2	13.25-13.4
6.31175-6.31225	123-138	2200-2300	14.47-14.5
8.291-8.294	149.9-150.05	2310-2390	15.35-16.2
8.362-8.366	156.52475-156.52525	2483.5-2500	17.7-21.4
8.37625-8.38675	156.7-156.9	2690-2900	22.01-23.12
8.41425-8.41475	162.0125-167.17	3260-3267	23.6-24.G
12.29-12.293	167.72-173.2	3332-3339	31.2-31.8
12.51975-12.52025	240-285	3345.8-3358	36.43-36.5
12.57675-12.57725	322-335.4	3600-4400	(²)
13.36-13.41			

(2) FCC 15.209 Limit.

FREQUENCY MHz	DISTANCE Meters	FIELD STRENGTHS LIMIT	
		$\mu\text{V}/\text{m}$	$\text{dB}(\mu\text{V})/\text{m}$
0.009 ~ 0.490	300	2400/F(kHz)	67.6-20log(F)
0.490 ~ 1.705	30	24000/F(kHz)	87.6-20log(F)
1.705 ~ 30.0	30	30	29.54
30 ~ 88	3	100	40.0
88 ~ 216	3	150	43.5
216 ~ 960	3	200	46.0
960 ~ 1000	3	500	54.0
Above 1000	3	74.0 $\text{dB}(\mu\text{V})/\text{m}$ (Peak) 54.0 $\text{dB}(\mu\text{V})/\text{m}$ (Average)	

Note: (1)The emission limits shown in the above table are based on measurements employing a CISPR QP detector except for the frequency bands 9-90kHz, 110-490kHz and above 1000MHz. Radiated emissions limits in these three bands are based on measurements employing an average detector.

(2) At frequencies below 30MHz, measurement may be performed at a distance closer than that specified, and the limit at closer measurement distance can be extrapolated by below formula:

$$\text{Limit}_{3\text{m}}(\text{dB}\mu\text{V}/\text{m}) = \text{Limit}_{30\text{m}}(\text{dB}\mu\text{V}/\text{m}) + 40\text{Log}(30\text{m}/3\text{m})$$

(3) Limit for this EUT

All the emissions appearing within 15.205 restricted frequency bands shall not exceed the limits shown in 15.209, all the other emissions shall be at least 20dB below the fundamental emissions, or comply with 15.209 limits.

10.3. Test Procedure

(1) EUT was placed on a non-metallic table, 80 cm above the ground plane inside a semi-anechoic chamber for below 1G and 150 cm above the ground plane inside a semi-anechoic chamber for above 1G.

(2) Test antenna was located 3m from the EUT on an adjustable mast, and the antenna used as below table.

Test frequency range	Test antenna used	Test antenna distance
9kHz-30MHz	Active Loop antenna	3m
30MHz-1GHz	Trilog Broadband Antenna	3m
1GHz-18GHz	Double Ridged Horn Antenna(1GHz-18GHz)	3m
18GHz-40GHz	Horn Antenna(18GHz-40GHz)	1m

According ANSI C63.10:2013 clause 6.4.4.2 and 6.5.3, for measurements below 30 MHz, the loop antenna was positioned with its plane vertical from the EUT and rotated about its vertical axis for maximum response at each azimuth position around the EUT. And the loop antenna also be positioned with its plane horizontal at the specified distance from the EUT. The center of the loop is 1 m above the ground. for measurement above 30MHz, the Trilog Broadband Antenna or

Horn Antenna was located 3m from EUT, Measurements were made with the antenna positioned in both the horizontal and vertical planes of Polarization, and the measurement antenna was varied from 1 m to 4 m. in height above the reference ground plane to obtain the maximum signal strength.

(3) Below pre-scan procedure was first performed in order to find prominent frequency spectrum radiated emissions from 9kHz to 25GHz:

(a) Scanning the peak frequency spectrum with the antenna specified in step (3), and the EUT was rotated 360 degree, the antenna height was varied from 1m to 4m(Except loop antenna, it's fixed 1m above ground.)

(b) Change work frequency or channel of device if practicable.

(c) Change modulation type of device if practicable.

(d) Change power supply range from 85% to 115% of the rated supply voltage

(e) Rotated EUT though three orthogonal axes to determine the attitude of EUT arrangement produces highest emissions.

Spectrum frequency from 9kHz to 25GHz (tenth harmonic of fundamental frequency) was investigated, and no any obvious emission were detected from 18GHz to 25GHz, so below final test was performed with frequency range from 9kHz to 18GHz.

(4) For final emissions measurements at each frequency of interest, the EUT was rotated and the antenna height was varied between 1m and 4m in order to maximize the emission. Measurements in both horizontal and vertical polarities were made and the data was recorded. In order to find the maximum emission, the relative positions of equipments and all of the interface cables were changed according to ANSI C63.10 2013 on Radiated Emission test.

(5) The emissions from 9kHz to 1GHz were measured based on CISPR QP detector except for the frequency bands 9-90kHz, 110-490kHz, for emissions from 9kHz-90kHz,110kHz-490kHz and above 1GHz were measured based on average detector, for emissions above 1GHz, peak emissions also be measured and need comply with Peak limit.

(6) The emissions from 9kHz to 1GHz, QP or average values were measured with EMI receiver with below RBW.

Frequency band	RBW
9kHz-150kHz	200Hz
150kHz-30MHz	9kHz
30MHz-1GHz	120kHz

(7) For emissions above 1GHz, both Peak and Average level were measured with Spectrum Analyzer, and the RBW is set at 1MHz, VBW is set at 3MHz for Peak measure; RMS detector RBW 1MHz VBW 3MHz for Average measure(according ANSI C63.10:2013 clause 4.1.4.2.2 procedure for average measure).

(8) X axis, Y axis, Z axis are tested, and worse setup X axis is reported.

10.4. Test result

PASS. (See below detailed test result)

All the emissions except fundamental emission from 9 kHz to 25GHz were comply with 15.209 limits.

Note1: According exploratory test no any obvious emission were detected from 9kHz to 30MHz and 18GHz to 25GHz.

Note2: For emissions below 1GHz, according exploratory explorer test, when change Tx mode and channel, have no distinct influence on emissions level, so for emissions below 1GHz, the final test was only performed with EUT working in GFSK, Tx 2441MHz mode.

Note3: For emissions above 1GHz. If peak results comply with AV limit, AV Result is deemed to comply with AV limit.

Radiated Emission test (below 1GHz) TR-4-E-009 Radiated Emission Test Result

Test Site	: DDT 3m Chamber 1#	D:\2018 RE1# Report Data\Q18030703-1E Air CD\RF.EM6
Test Date	: 2018-03-29	Tested By : Sunny
EUT	: Portable CD Player with Bluetooth	Model Number : AIR CD
Power Supply	: DC 3.0V	Test Mode : Tx mode
Condition	: Temp:24.5°C,Humi:55%, Press:100.1kPa	Antenna/Distance : 2017 VULB 9163 1#/3m/HORIZONTAL
Memo	:	

Data: 15

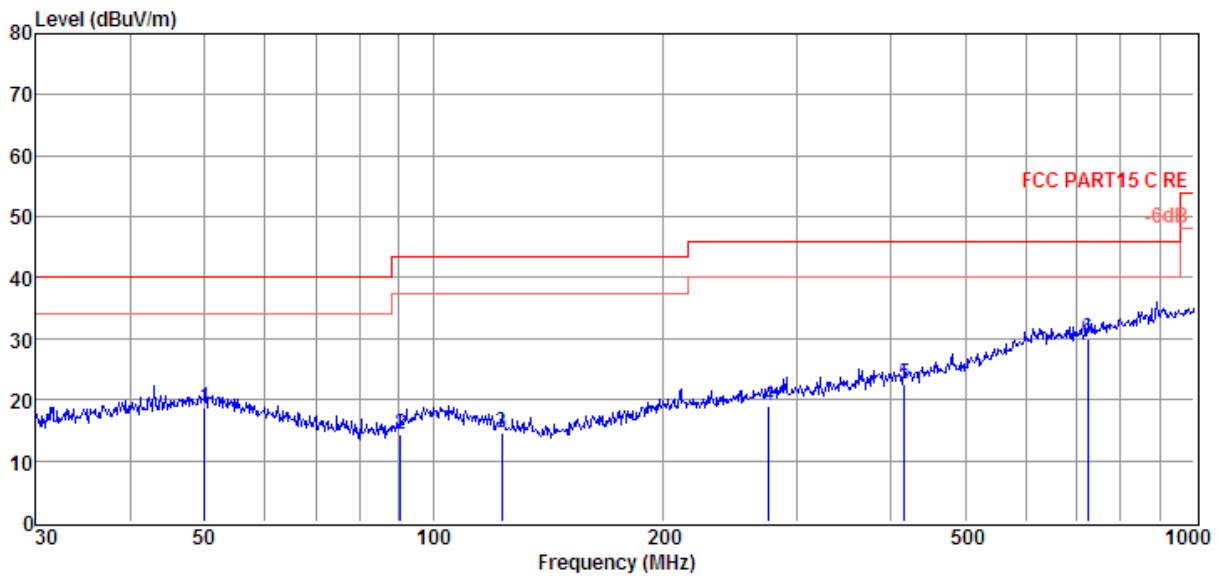

Item (Mark)	Freq. (MHz)	Read Level (dBμV)	Antenna Factor (dB/m)	Cable Loss dB	Result Level (dBμV/m)	Limit Line (dBμV/m)	Over Limit (dB)	Detector	Polarization
1	50.06	0.83	13.79	3.99	18.61	40.00	-21.39	QP	HORIZONTAL
2	90.54	0.38	9.52	4.34	14.24	43.50	-29.26	QP	HORIZONTAL
3	122.83	0.99	8.93	4.59	14.51	43.50	-28.99	QP	HORIZONTAL
4	276.12	0.71	12.93	5.42	19.06	46.00	-26.94	QP	HORIZONTAL
5	416.18	0.99	15.61	5.84	22.44	46.00	-23.56	QP	HORIZONTAL
6	724.26	2.76	20.11	7.09	29.96	46.00	-16.04	QP	HORIZONTAL

Note: 1. Result Level = Read Level + Antenna Factor + Cable loss.
 2. If Peak Result complies with QP limit, QP Result is deemed to comply with QP limit.
 3. Test setup: RBW: 120 kHz, VBW: 300 kHz, Sweep time: auto.

TR-4-E-009 Radiated Emission Test Result

Test Site : DDT 3m Chamber 1# D:\2018 RE1# Report Data\Q18030703-1E Air CD\RF.EM6
Test Date : 2018-03-29 **Tested By** : Sunny
EUT : Portable CD Player with Bluetooth **Model Number** : AIR CD
Power Supply : DC 3.0V **Test Mode** : Tx mode
Condition : Temp:24.5°C,Humi:55%,
 Press:100.1kPa **Antenna/Distance** : 2017 VULB 9163 1#/3m/VERTICAL
Memo :

Data: 16

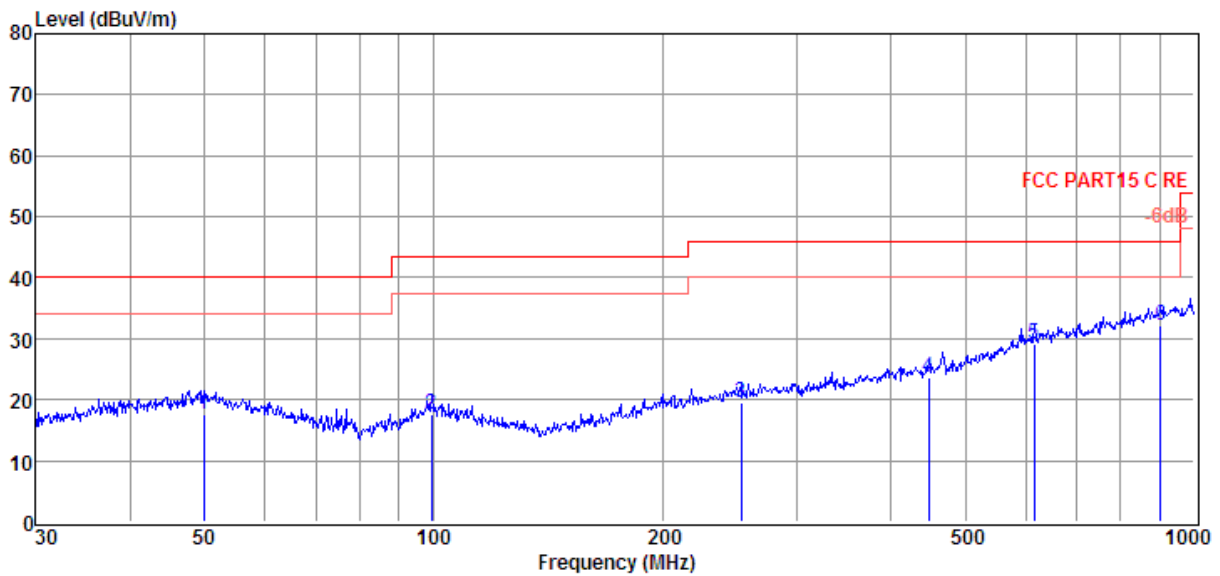

Item (Mark)	Freq. (MHz)	Read Level (dBμV)	Antenna Factor (dB/m)	Cable Loss (dB)	Result Level (dBμV/m)	Limit Line (dBμV/m)	Over Limit (dB)	Detector	Polarization
1	49.88	-0.29	13.79	3.99	17.49	40.00	-22.51	QP	VERTICAL
2	99.53	1.76	11.41	4.41	17.58	43.50	-25.92	QP	VERTICAL
3	253.84	1.68	12.56	5.31	19.55	46.00	-26.45	QP	VERTICAL
4	447.98	1.68	16.37	5.63	23.68	46.00	-22.32	QP	VERTICAL
5	616.37	2.89	19.45	6.73	29.07	46.00	-16.93	QP	VERTICAL
6	903.31	1.97	22.59	7.61	32.17	46.00	-13.83	QP	VERTICAL

Note: 1. Result Level = Read Level + Antenna Factor + Cable loss.
 2. If Peak Result complies with QP limit, QP Result is deemed to comply with QP limit.
 3. Test setup: RBW: 120 kHz, VBW: 300 kHz, Sweep time: auto.

Radiated Emission test (above 1GHz)

Freq. (MHz)	Read level (dB μ V)	Antenna Factor (dB/m)	PRM Factor (dB)	Cable Loss (dB)	Result Level (dB μ V/m)	Limit (dB μ V/ m)	Margin (dB)	Detector type	Polarization
GFSK Tx mode 2402MHz									
5522.00	42.75	35.51	43.49	7.91	42.68	74.00	-31.32	Peak	HORIZONTAL
7018.00	41.30	36.81	43.51	8.35	42.95	74.00	-31.05	Peak	HORIZONTAL
9279.00	41.26	37.61	44.18	10.52	45.21	74.00	-28.79	Peak	HORIZONTAL
11166.00	44.13	38.73	44.23	11.05	49.68	74.00	-24.32	Peak	HORIZONTAL
12849.00	39.80	39.15	44.31	11.29	45.93	74.00	-28.07	Peak	HORIZONTAL
13920.00	39.50	39.97	44.58	12.28	47.17	74.00	-26.83	Peak	HORIZONTAL
5607.00	42.52	35.54	43.44	7.96	42.58	74.00	-31.42	Peak	VERTICAL
7936.00	41.89	37.17	43.78	9.17	44.45	74.00	-29.55	Peak	VERTICAL
9738.00	41.73	37.94	44.32	10.75	46.10	74.00	-27.90	Peak	VERTICAL
10639.00	44.73	38.58	44.30	11.00	50.01	74.00	-23.99	Peak	VERTICAL
11812.00	40.95	38.79	44.13	10.99	46.60	74.00	-27.40	Peak	VERTICAL
13971.00	41.44	39.99	44.59	12.33	49.17	74.00	-24.83	Peak	VERTICAL
GFSK Tx mode 2441MHz									
6559.00	41.61	35.83	43.37	8.28	42.35	74.00	-31.65	Peak	HORIZONTAL
7936.00	42.26	37.17	43.78	9.17	44.82	74.00	-29.18	Peak	HORIZONTAL
9602.00	40.95	37.80	44.28	10.68	45.15	74.00	-28.85	Peak	HORIZONTAL
10639.00	42.66	38.58	44.30	11.00	47.94	74.00	-26.06	Peak	HORIZONTAL
11523.00	41.54	38.61	44.17	11.01	46.99	74.00	-27.01	Peak	HORIZONTAL
13393.00	40.81	39.69	44.45	11.75	47.80	74.00	-26.20	Peak	HORIZONTAL
5522.00	43.03	35.51	43.49	7.91	42.96	74.00	-31.04	Peak	VERTICAL
7239.00	42.10	36.90	43.57	8.55	43.98	74.00	-30.02	Peak	VERTICAL
9330.00	41.52	37.63	44.20	10.54	45.49	74.00	-28.51	Peak	VERTICAL
11472.00	41.67	38.61	44.18	11.02	47.12	74.00	-26.88	Peak	VERTICAL
13393.00	40.18	39.69	44.45	11.75	47.17	74.00	-26.83	Peak	VERTICAL
14821.00	40.04	41.56	44.31	12.78	50.07	74.00	-23.93	Peak	VERTICAL
GFSK Tx mode 2480MHz									
5828.00	42.83	35.63	43.30	8.10	43.26	74.00	-30.74	Peak	HORIZONTAL
6831.00	41.77	36.43	43.45	8.31	43.06	74.00	-30.94	Peak	HORIZONTAL
8395.00	39.71	37.28	43.92	9.68	42.75	74.00	-31.25	Peak	HORIZONTAL
9806.00	41.73	38.01	44.34	10.79	46.19	74.00	-27.81	Peak	HORIZONTAL
11166.00	42.41	38.73	44.23	11.05	47.96	74.00	-26.04	Peak	HORIZONTAL
12832.00	40.04	39.13	44.31	11.29	46.15	74.00	-27.85	Peak	HORIZONTAL
5709.00	42.12	35.58	43.37	8.03	42.36	74.00	-31.64	Peak	VERTICAL
7817.00	41.17	37.13	43.75	9.07	43.62	74.00	-30.38	Peak	VERTICAL
8888.00	42.44	37.46	44.07	10.24	46.07	74.00	-27.93	Peak	VERTICAL
11132.00	42.04	38.75	44.23	11.05	47.61	74.00	-26.39	Peak	VERTICAL
13138.00	41.17	39.44	44.38	11.49	47.72	74.00	-26.28	Peak	VERTICAL
14719.00	40.58	41.54	44.35	12.73	50.50	74.00	-23.50	Peak	VERTICAL
Result: Pass									

Note: 1.30MHz~25GHz: (Scan with GFSK, $\pi/4$ -DQPSK, 8DPSK, the worst case is GFSK Mode)

2. Result Level = Read Level + Antenna Factor + Cable loss - PRM Factor.

3: For emissions above 1GHz. If peak results comply with AV limit, AV Result is deemed to comply with AV limit.

11. RF Conducted Spurious Emissions

11.1. Block diagram of test setup

Same as section 4.1

11.2. Limits

In any 100kHz bandwidth outside the frequency bands in which the spread spectrum intentional radiator is operating, the radio frequency power that is produced by the intentional radiator shall be at least 20dB below that in the 100kHz bandwidth within the band that contains the highest level of the desired power.

11.3. Test Procedure

(1) Connect EUT's antenna output to spectrum analyzer by RF cable.

(2) Establish a reference level by using the following procedure:

Center frequency	DTS Channel center frequency
RBW:	100kHz
VBW:	300kHz
Span	1.5times the DTS bandwidth
Detector Mode:	Peak
Sweep time:	auto
Trace mode	Max hold

(3) Allow the trace to stabilize, use the peak marker function to determine the maximum peak power level to establish the reference level.

(4) Set the spectrum analyzer as follows:

RBW:	100kHz
VBW:	300kHz
Span	Encompass frequency range to be measured
Number of measurement points	$\geq \text{span}/\text{RBW}$
Detector Mode:	Peak
Sweep time:	auto
Trace mode	Max hold

(5) Allow the trace to stabilize, use the peak marker function to determine the maximum amplitude of all unwanted emissions outside of the authorized frequency band

11.4. Test Result

Mode	Freq. (MHz)	Conclusion
GFSK	Hopping off 2402	PASS
	Hopping off 2441	PASS
	Hopping off 2480	PASS
8DPSK	Hopping off 2402	PASS
	Hopping off 2441	PASS
	Hopping off 2480	PASS

11.5. Original test data

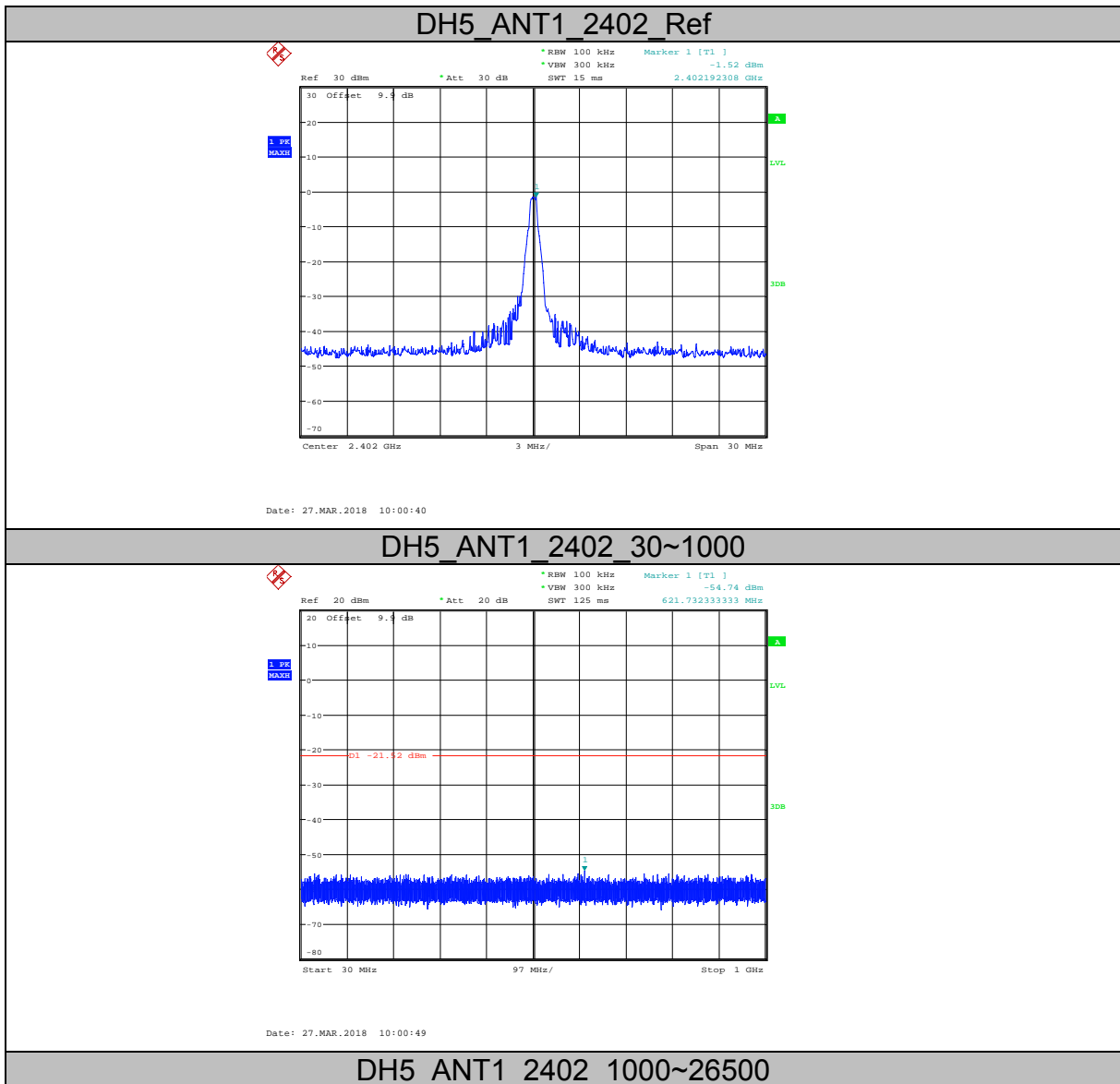

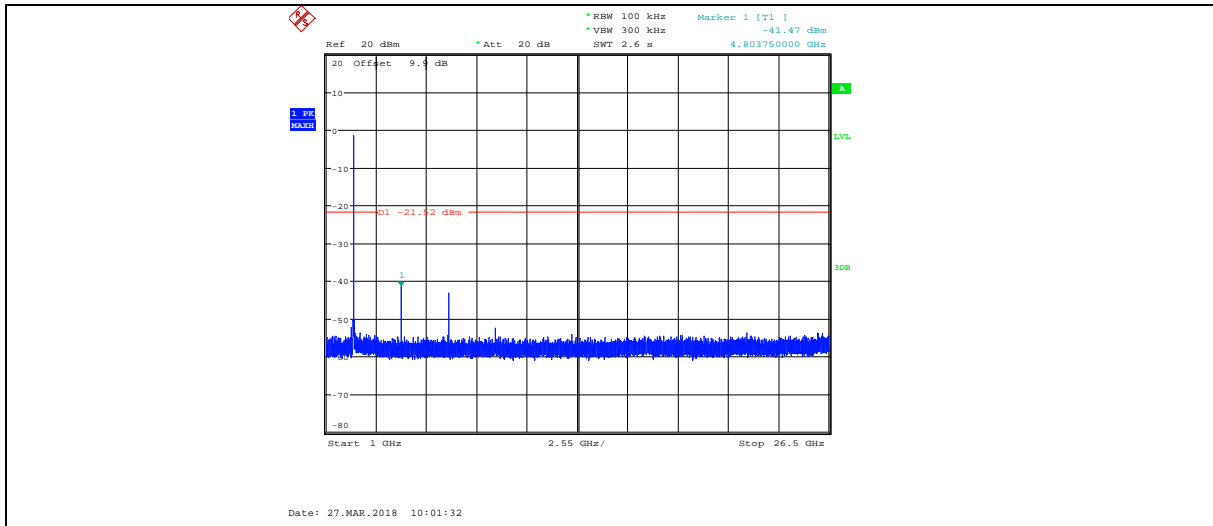

DH5_ANT1_2441_Ref

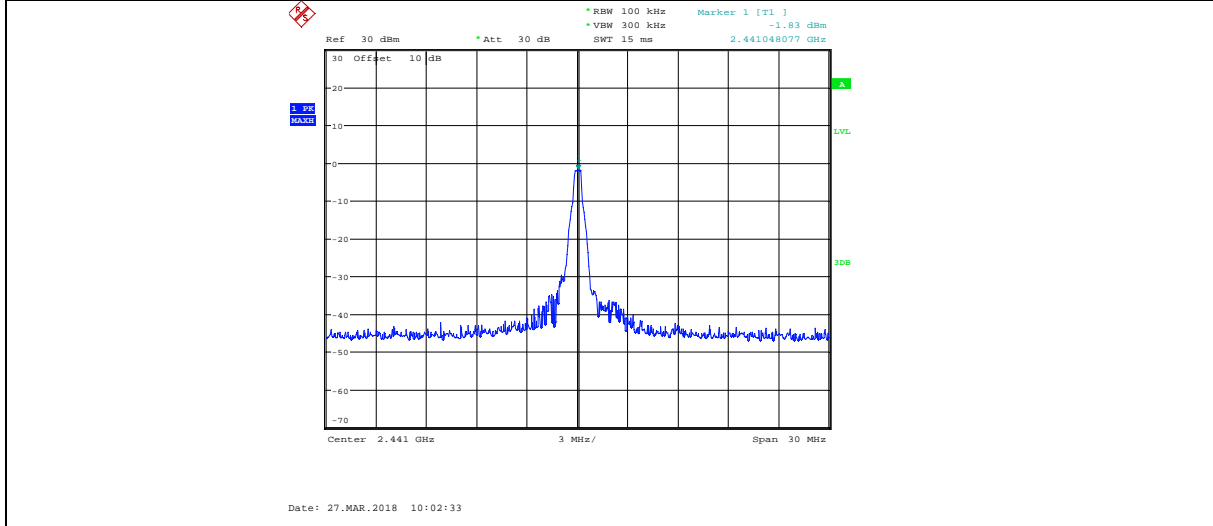

DH5_ANT1_2441_30~1000

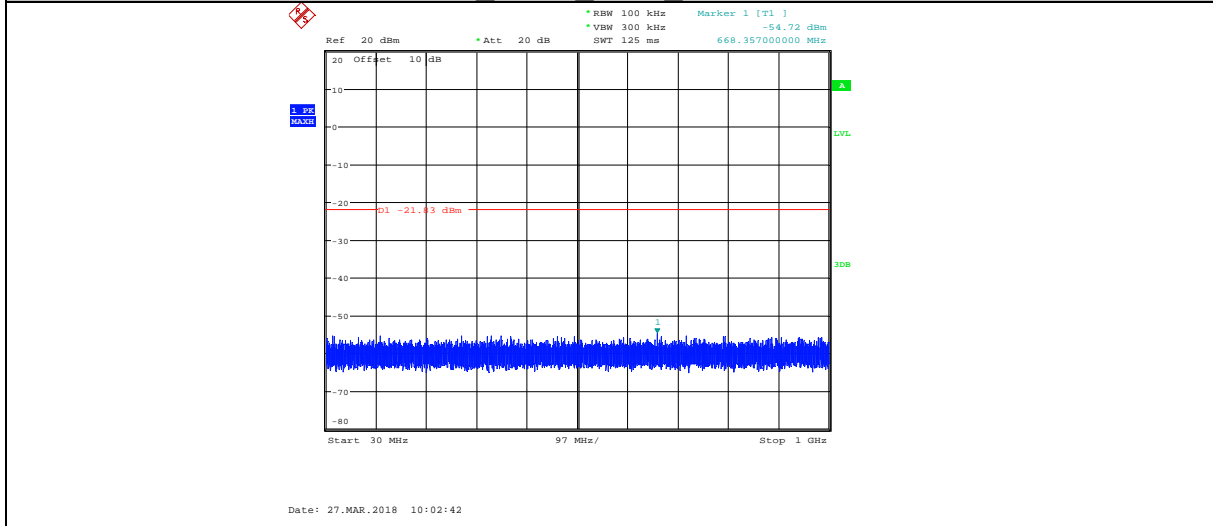

DH5_ANT1_2441_1000~26500

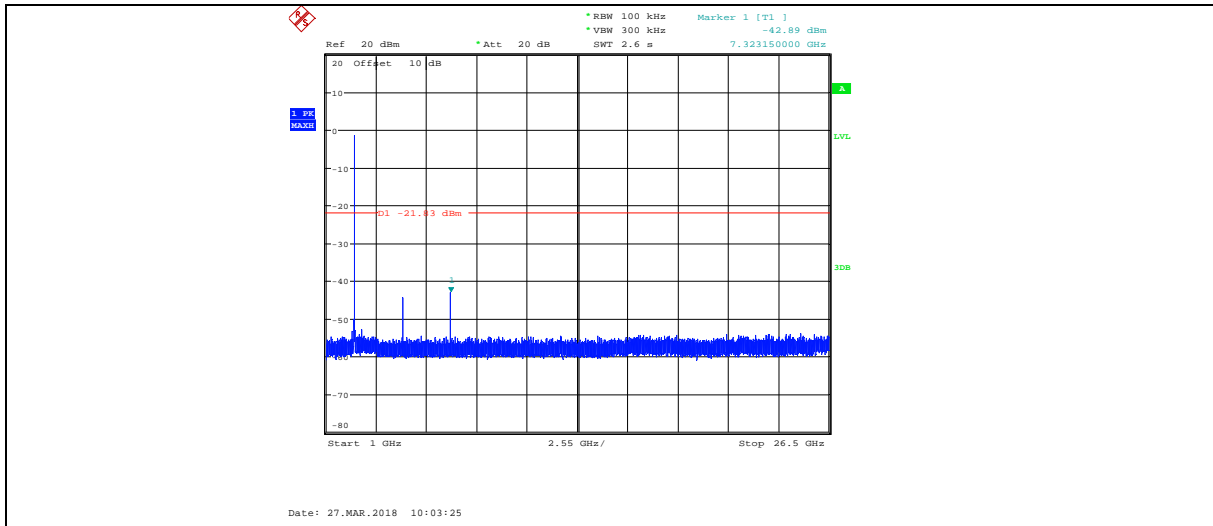

DH5_ANT1_2480_Ref

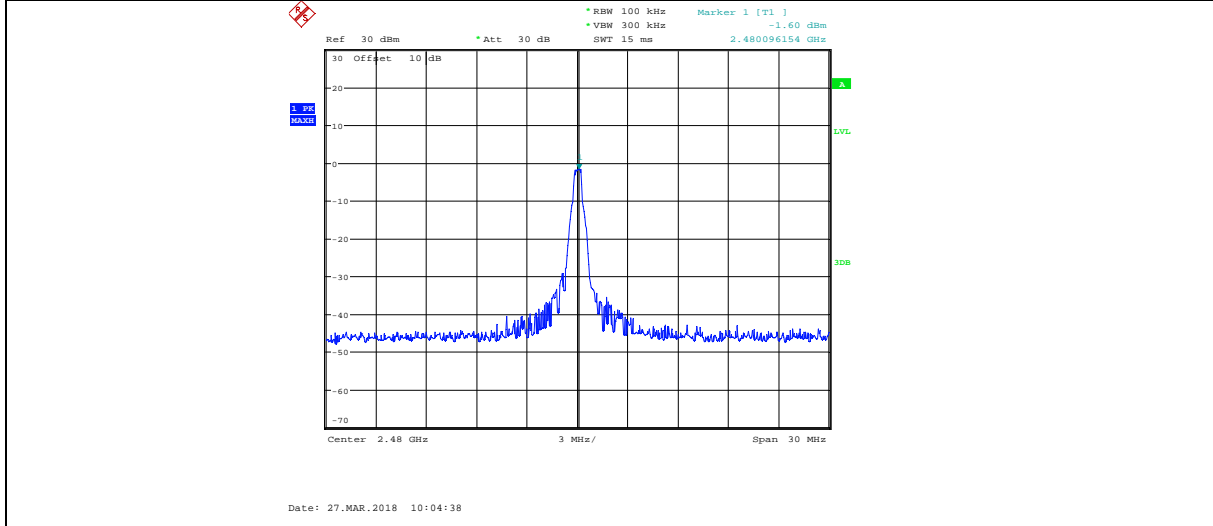

DH5_ANT1_2480_30~1000

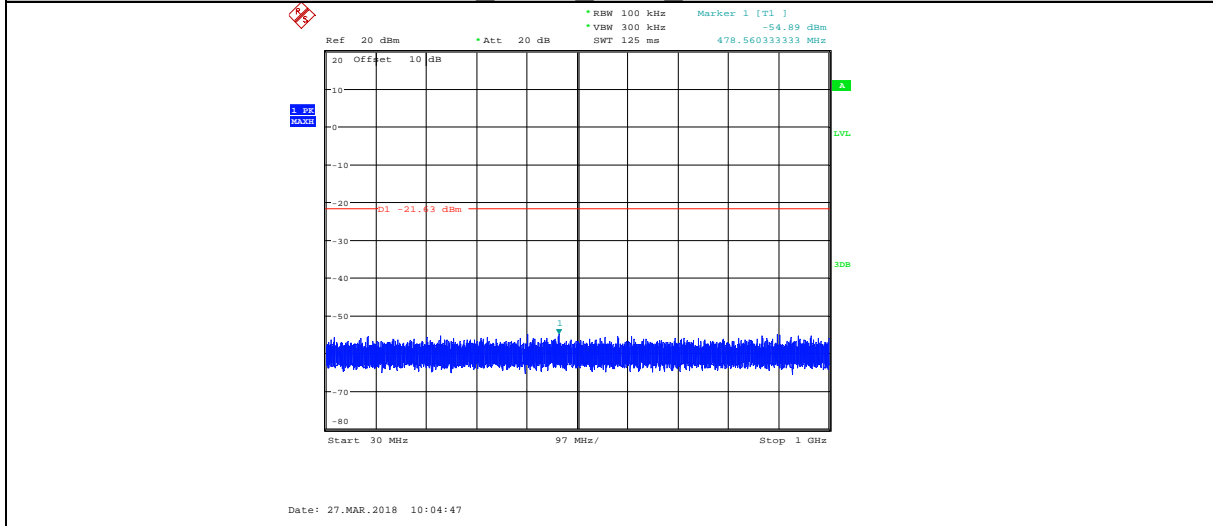

DH5_ANT1_2480_1000~26500

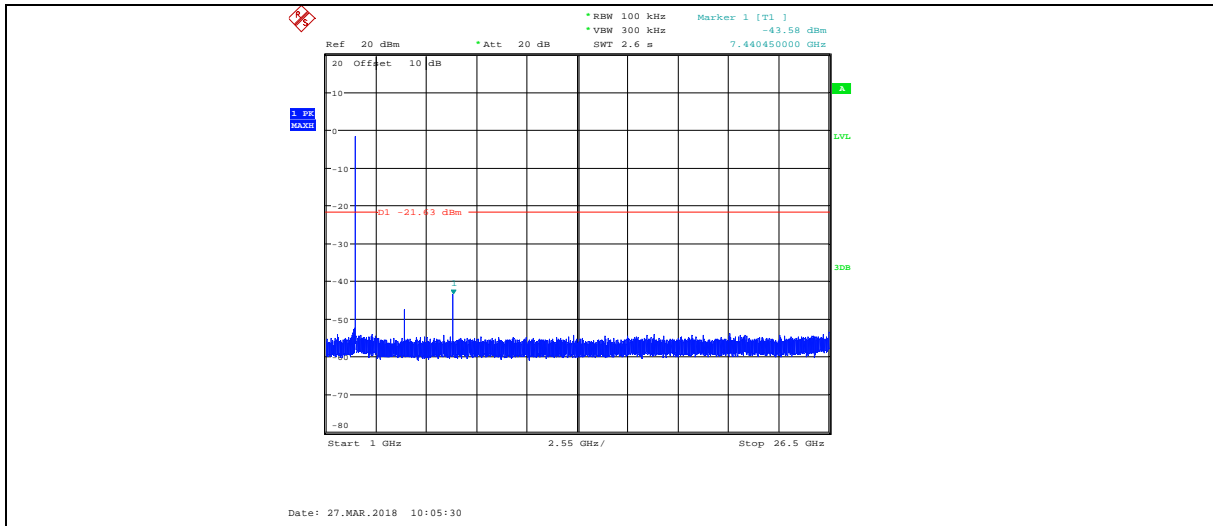

3DH5_ANT1_2402_Ref

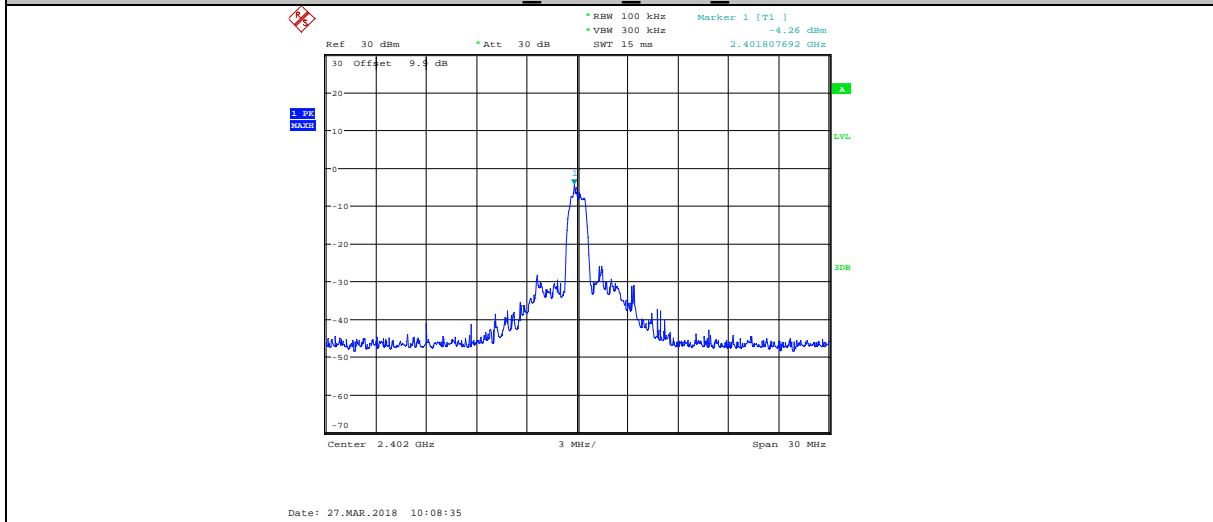

3DH5_ANT1_2402_30~1000

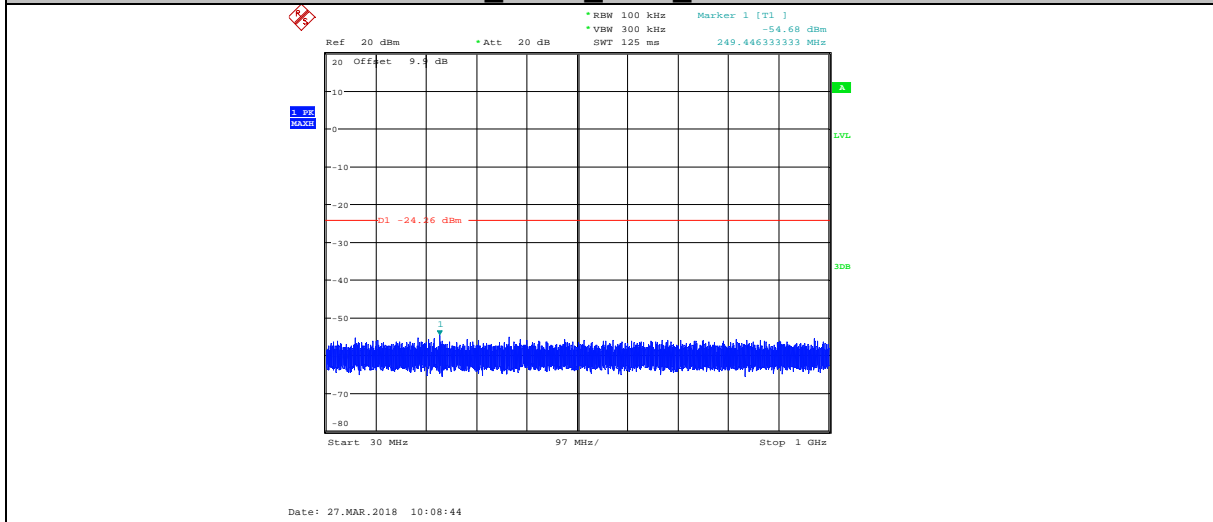

3DH5_ANT1_2402_1000~26500

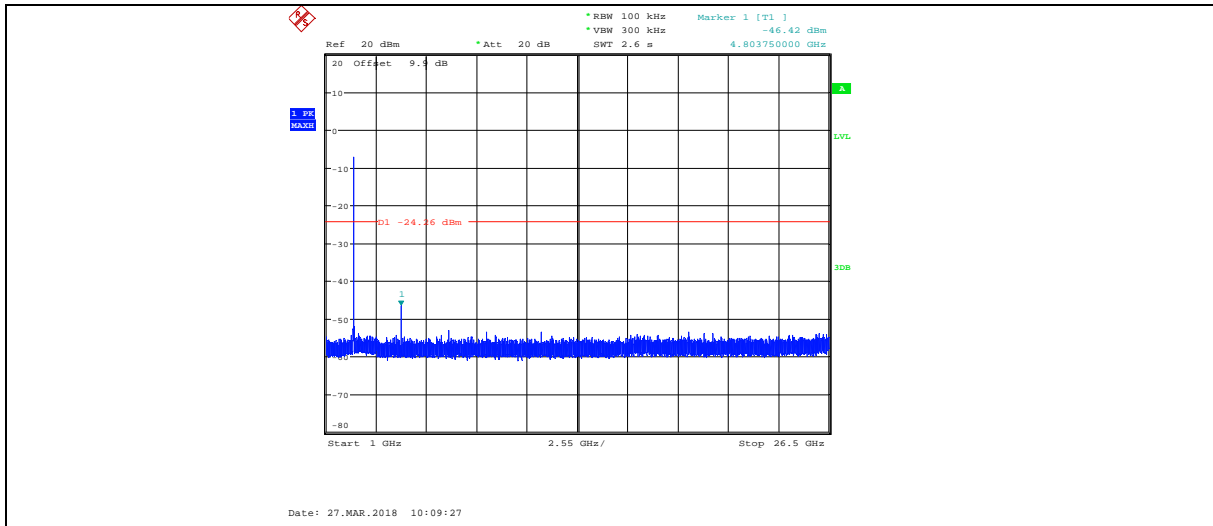

3DH5_ANT1_2441_Ref

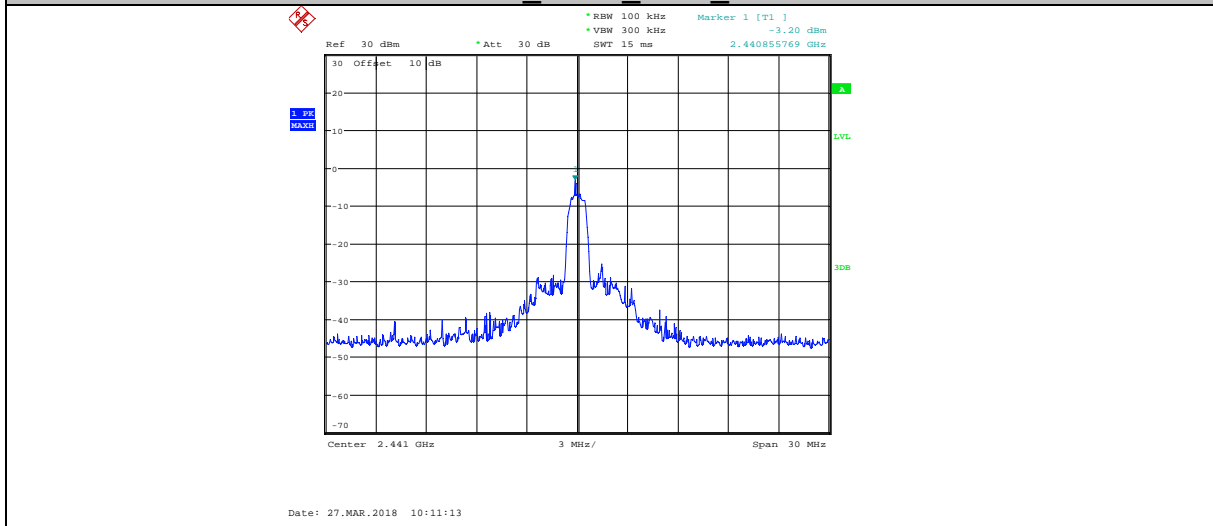

3DH5_ANT1_2441_30~1000

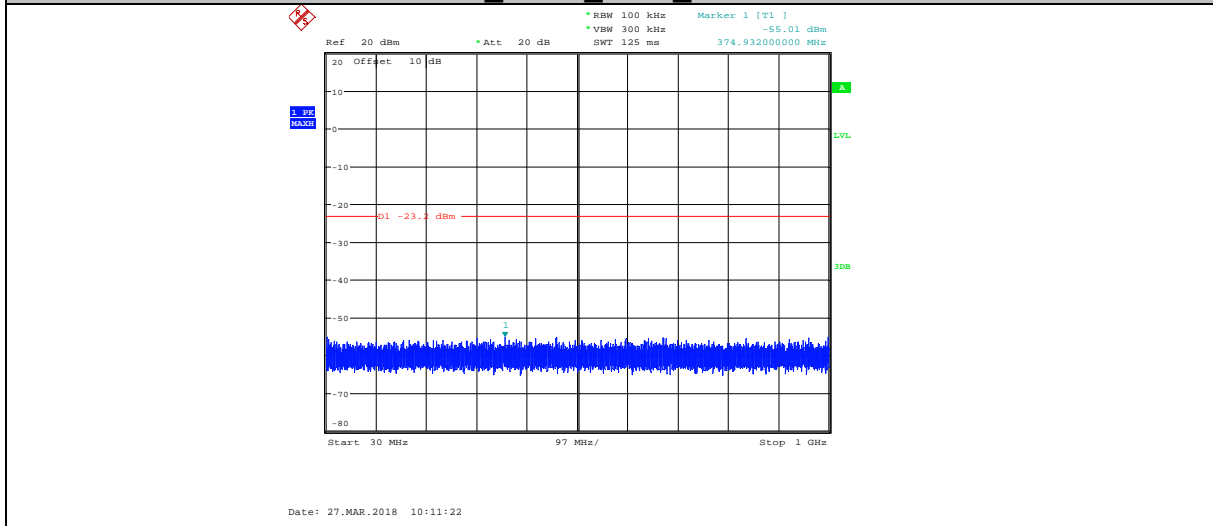

3DH5_ANT1_2441_1000~26500

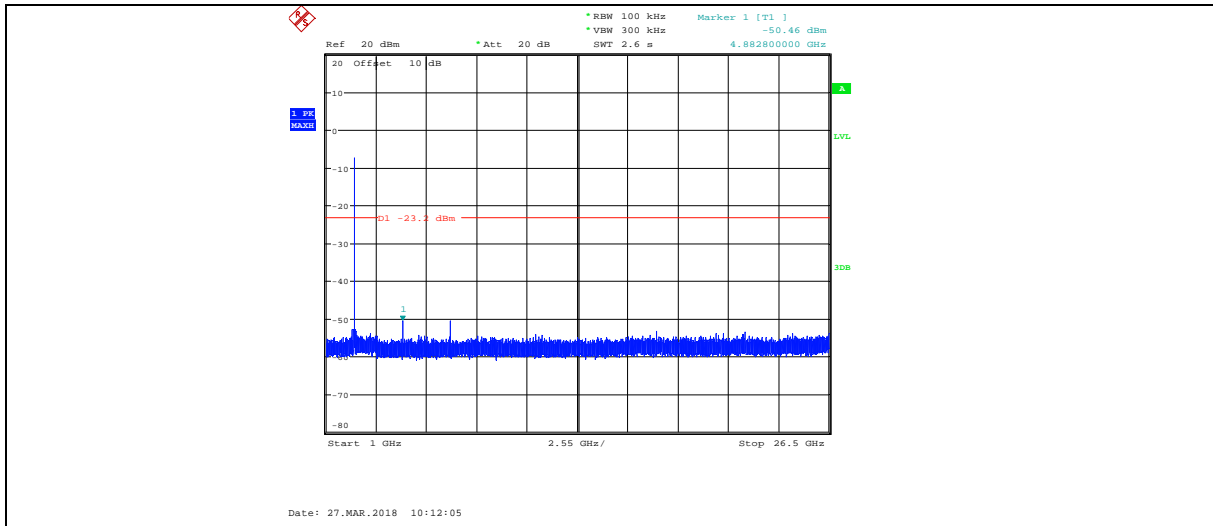

3DH5_ANT1_2480_Ref

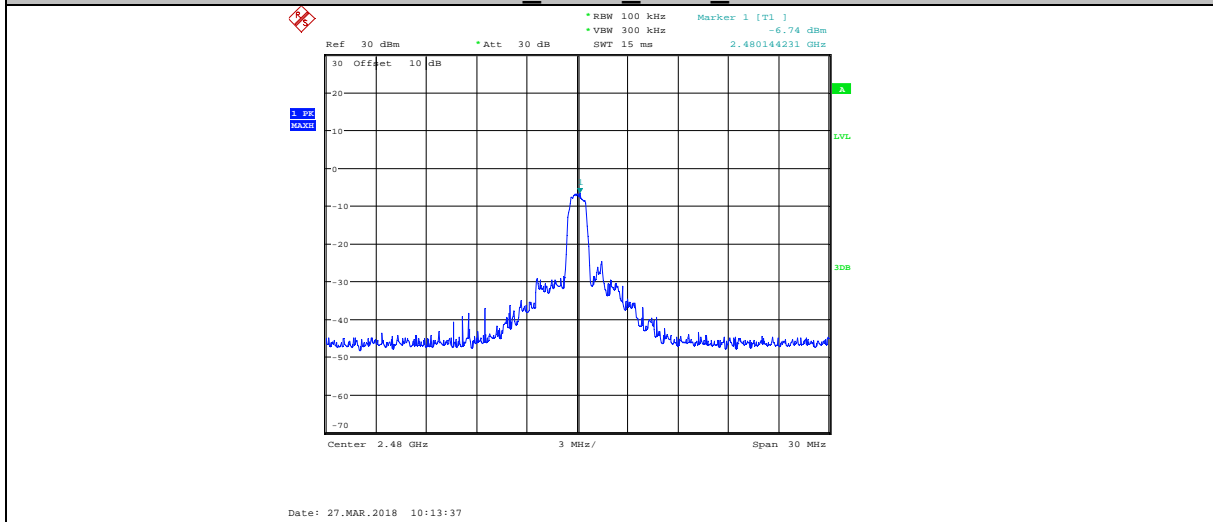

3DH5_ANT1_2480_30~1000

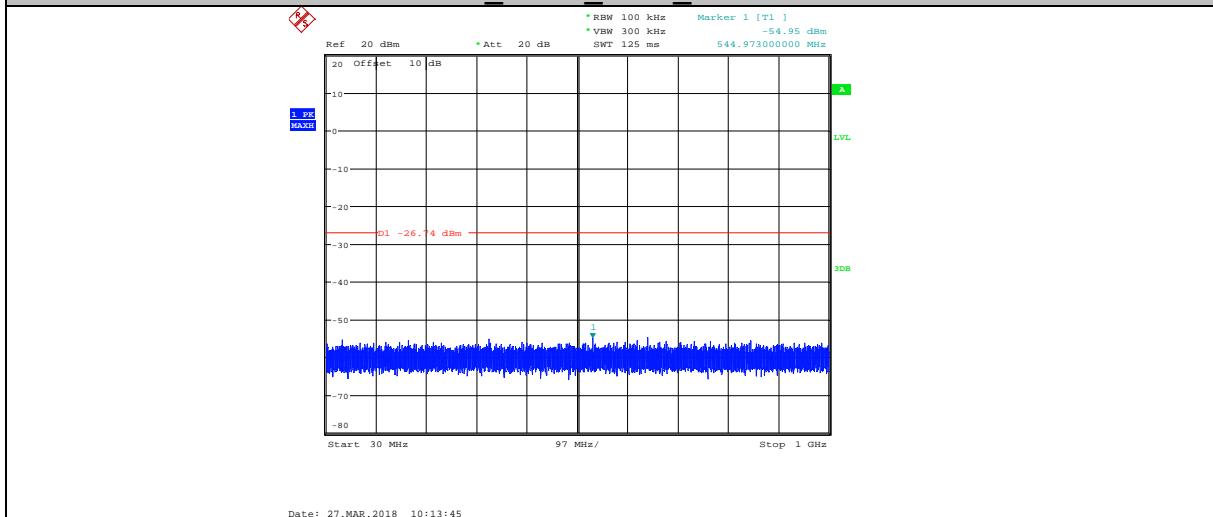

3DH5_ANT1_2480_1000~26500

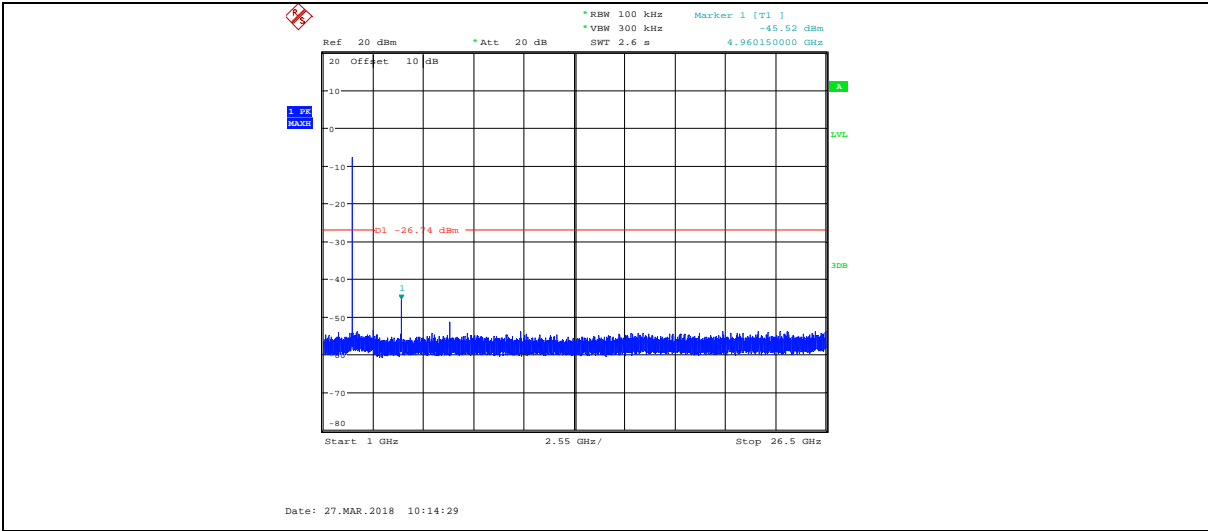

12. Band Edge Compliance (radiated method)

12.1. Block diagram of test setup

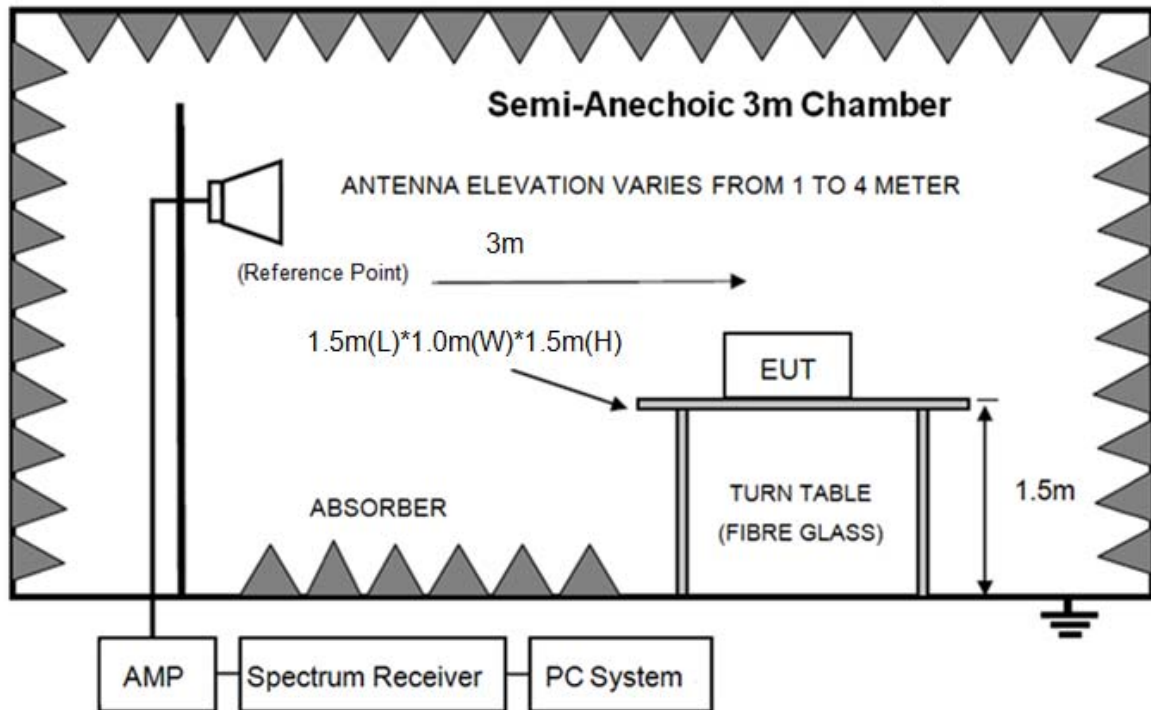

12.2. Limit

All restriction band should comply with 15.209, other emission should be at least 20dB below the fundamental.

12.3. Test Procedure

Same with clause 10.3 except change investigated frequency range from 2310MHz to 2410MHz and 2475MHz to 2500MHz.

Remark: All restriction band have been tested, and only the worse case is shown in report.

12.4. Test result

PASS. (See below detailed test result)

Remark: hopping on and hopping off mode all have been test, hopping off mode is worst and reported only.

TR-4-E-009 Radiated Emission Test Result

Test Site : DDT 3m Chamber 1# D:\2018 RE1# Report Data\Q18030703-1E Air CD\RF.EM6
Test Date : 2018-03-29 **Tested By** : Sunny
EUT : Portable CD Player with Bluetooth **Model Number** : AIR CD
Power Supply : DC 3.0V **Test Mode** : Tx mode
Condition : Temp:24.5°C,Humi:55%,
 Press:100.1kPa **Antenna/Distance** : 2017 HF907/3m/HORIZONTAL
Memo : GFSK 2402MHz

Data: 1

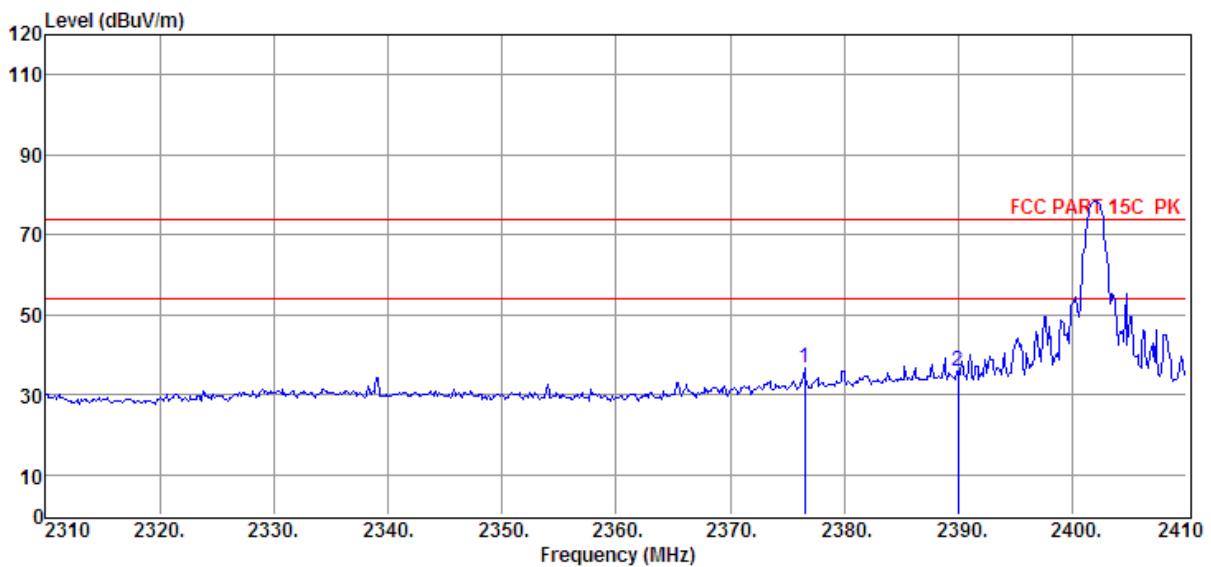

Item (Mark)	Freq. (MHz)	Read Level (dBµV)	Antenna Factor (dB/m)	PRM Factor dB	Cable Loss dB	Result Level (dBµV/m)	Limit Line (dBµV/m)	Over Limit (dB)	Detector	Polarization
1	2376.50	48.78	26.96	44.32	5.09	36.51	74.00	-37.49	Peak	HORIZONTAL
2	2390.00	48.26	27.00	44.32	5.11	36.05	74.00	-37.95	Peak	HORIZONTAL

Note: 1. Result Level = Read Level + Antenna Factor + Cable loss - PRM Factor.
 2. If Peak Result complies with AV limit, AV Result is deemed to comply with AV limit.
 3. Test setup: RBW: 1 MHz, VBW: 3 MHz, Sweep time: auto.

TR-4-E-009 Radiated Emission Test Result

Test Site : DDT 3m Chamber 1# D:\2018 RE1# Report Data\Q18030703-1E Air CD\RF.EM6
Test Date : 2018-03-29 **Tested By** : Sunny
EUT : Portable CD Player with Bluetooth **Model Number** : AIR CD
Power Supply : DC 3.0V **Test Mode** : Tx mode
Condition : Temp:24.5°C,Humi:55%,
 Press:100.1kPa **Antenna/Distance** : 2017 HF907/3m/VERTICAL
Memo : GFSK 2402MHz

Data: 2

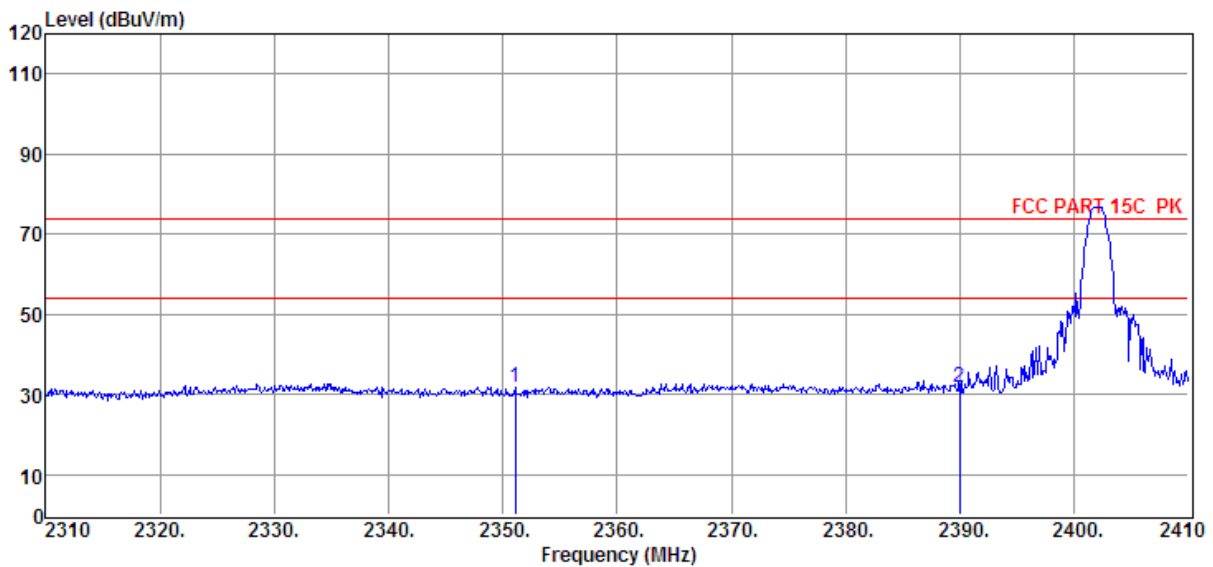

Item (Mark)	Freq. (MHz)	Read Level (dBμV)	Antenna Factor (dB/m)	PRM Factor dB	Cable Loss dB	Result Level (dBμV/m)	Limit Line (dBμV/m)	Over Limit (dB)	Detector	Polarization
1	2351.10	44.29	26.86	44.32	5.07	31.90	74.00	-42.10	Peak	VERTICAL
2	2390.00	43.81	27.00	44.32	5.11	31.60	74.00	-42.40	Peak	VERTICAL

Note: 1. Result Level = Read Level + Antenna Factor + Cable loss - PRM Factor.
 2. If Peak Result complies with AV limit, AV Result is deemed to comply with AV limit.
 3. Test setup: RBW: 1 MHz, VBW: 3 MHz, Sweep time: auto.

TR-4-E-009 Radiated Emission Test Result

Test Site : DDT 3m Chamber 1# D:\2018 RE1# Report Data\Q18030703-1E Air CD\RF.EM6
Test Date : 2018-03-29 **Tested By** : Sunny
EUT : Portable CD Player with Bluetooth **Model Number** : AIR CD
Power Supply : DC 3.0V **Test Mode** : Tx mode
Condition : Temp:24.5°C,Humi:55%,
 Press:100.1kPa **Antenna/Distance** : 2017 HF907/3m/HORIZONTAL
Memo : GFSK 2480MHz

Data: 9

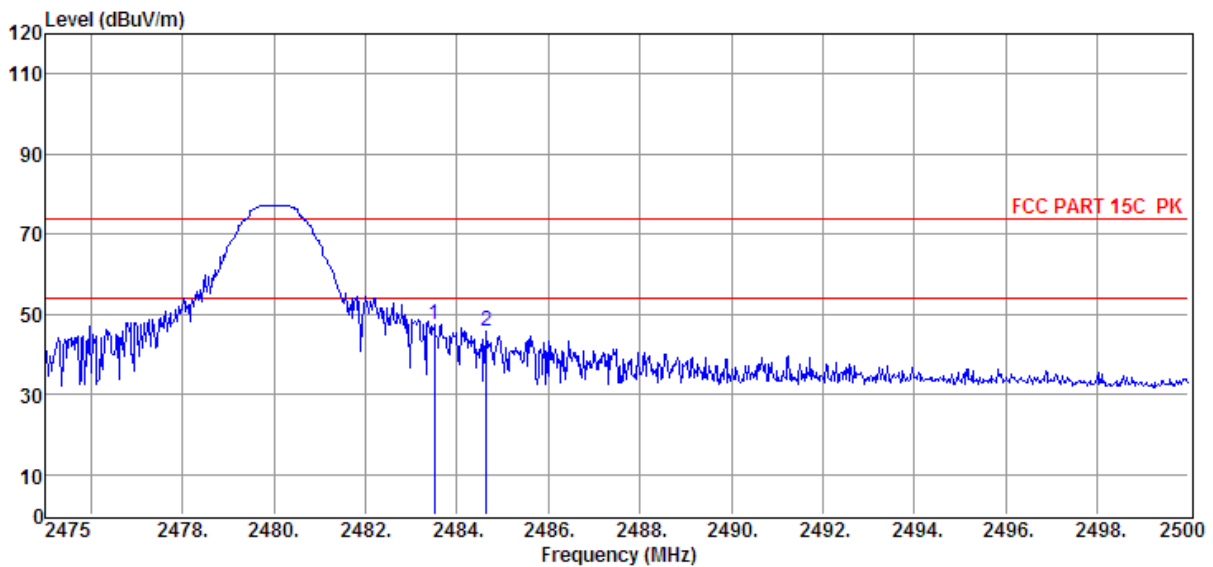

Item (Mark)	Freq. (MHz)	Read Level (dBμV)	Antenna Factor (dB/m)	PRM Factor dB	Cable Loss dB	Result Level (dBμV/m)	Limit Line (dBμV/ m)	Over Limit (dB)	Detector	Polarization
1	2483.50	59.30	27.34	44.32	5.21	47.53	74.00	-26.47	Peak	HORIZONTAL
2	2484.65	57.60	27.34	44.32	5.21	45.83	74.00	-28.17	Peak	HORIZONTAL

- Note: 1. Result Level = Read Level + Antenna Factor + Cable loss - PRM Factor.
 2. If Peak Result complies with AV limit, AV Result is deemed to comply with AV limit.
 3. Test setup: RBW: 1 MHz, VBW: 3 MHz, Sweep time: auto.

TR-4-E-009 Radiated Emission Test Result

Test Site : DDT 3m Chamber 1# D:\2018 RE1# Report Data\Q18030703-1E Air CD\RF.EM6
Test Date : 2018-03-29 **Tested By** : Sunny
EUT : Portable CD Player with Bluetooth **Model Number** : AIR CD
Power Supply : DC 3.0V **Test Mode** : Tx mode
Condition : Temp:24.5°C,Humi:55%,
 Press:100.1kPa **Antenna/Distance** : 2017 HF907/3m/VERTICAL
Memo : GFSK 2480MHz

Data: 10

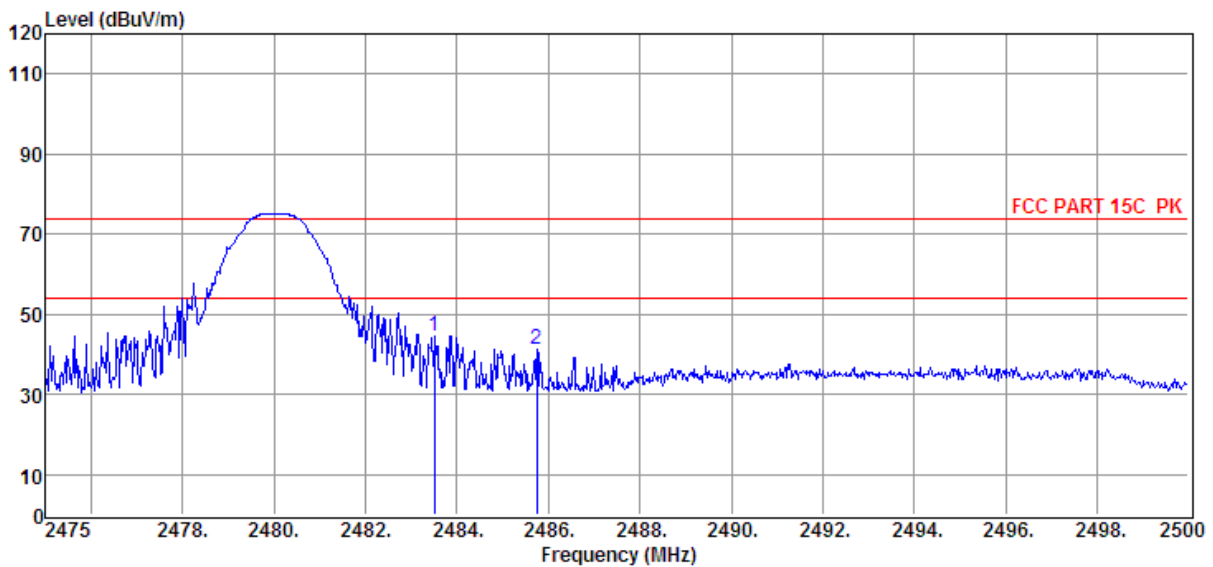

Item (Mark)	Freq. (MHz)	Read Level (dBμV)	Antenna Factor (dB/m)	PRM Factor dB	Cable Loss dB	Result Level (dBμV/m)	Limit Line (dBμV/ m)	Over Limit (dB)	Detector	Polarization
1	2483.50	56.32	27.34	44.32	5.21	44.55	74.00	-29.45	Peak	VERTICAL
2	2485.75	53.12	27.35	44.32	5.21	41.36	74.00	-32.64	Peak	VERTICAL

- Note: 1. Result Level = Read Level + Antenna Factor + Cable loss - PRM Factor.
 2. If Peak Result complies with AV limit, AV Result is deemed to comply with AV limit.
 3. Test setup: RBW: 1 MHz, VBW: 3 MHz, Sweep time: auto.

TR-4-E-009 Radiated Emission Test Result

Test Site : DDT 3m Chamber 1# D:\2018 RE1# Report Data\Q18030703-1E Air CD\RF.EM6
Test Date : 2018-03-29 **Tested By** : Sunny
EUT : Portable CD Player with Bluetooth **Model Number** : AIR CD
Power Supply : DC 3.0V **Test Mode** : Tx mode
Condition : Temp:24.5°C,Humi:55%,
 Press:100.1kPa **Antenna/Distance** : 2017 HF907/3m/HORIZONTAL
Memo : 8-QPSK 2402MHz

Data: 12

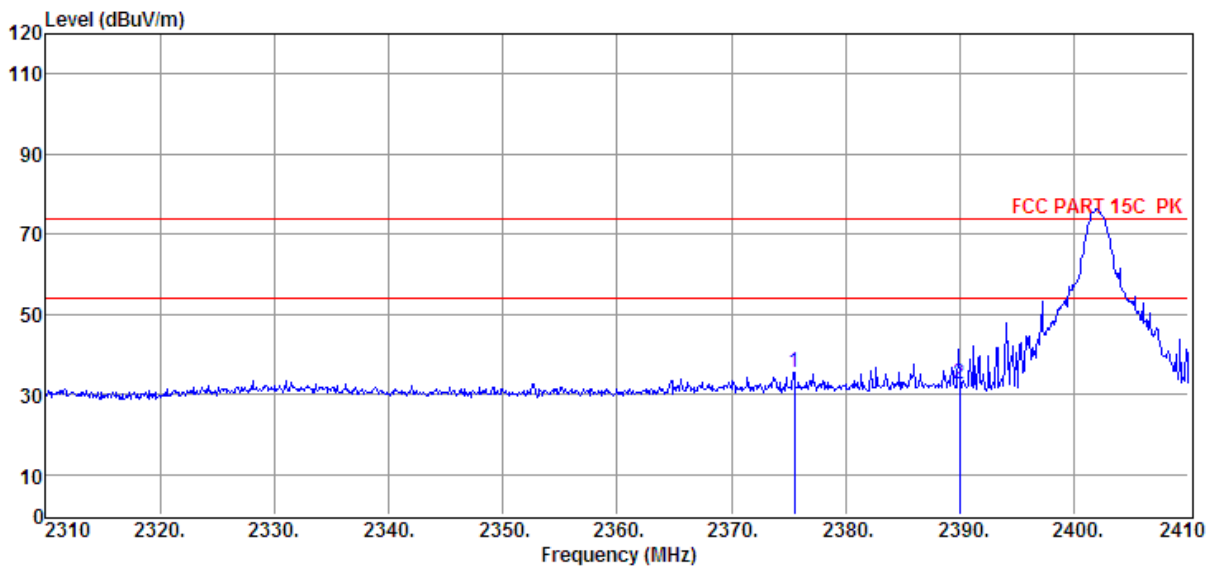

Item (Mark)	Freq. (MHz)	Read Level (dBμV)	Antenna Factor (dB/m)	PRM Factor dB	Cable Loss dB	Result Level (dBμV/m)	Limit Line (dBμV/m)	Over Limit (dB)	Detector	Polarization
1	2375.50	47.94	26.95	44.32	5.09	35.66	74.00	-38.34	Peak	HORIZONTAL
2	2390.00	44.77	27.00	44.32	5.11	32.56	74.00	-41.44	Peak	HORIZONTAL

- Note: 1. Result Level = Read Level + Antenna Factor + Cable loss - PRM Factor.
 2. If Peak Result complies with AV limit, AV Result is deemed to comply with AV limit.
 3. Test setup: RBW: 1 MHz, VBW: 3 MHz, Sweep time: auto.

TR-4-E-009 Radiated Emission Test Result

Test Site : DDT 3m Chamber 1# D:\2018 RE1# Report Data\Q18030703-1E Air CD\RF.EM6
Test Date : 2018-03-29 **Tested By** : Sunny
EUT : Portable CD Player with Bluetooth **Model Number** : AIR CD
Power Supply : DC 3.0V **Test Mode** : Tx mode
Condition : Temp:24.5°C,Humi:55%,
 Press:100.1kPa **Antenna/Distance** : 2017 HF907/3m/VERTICAL
Memo : 8-QPSK 2402MHz

Data: 11

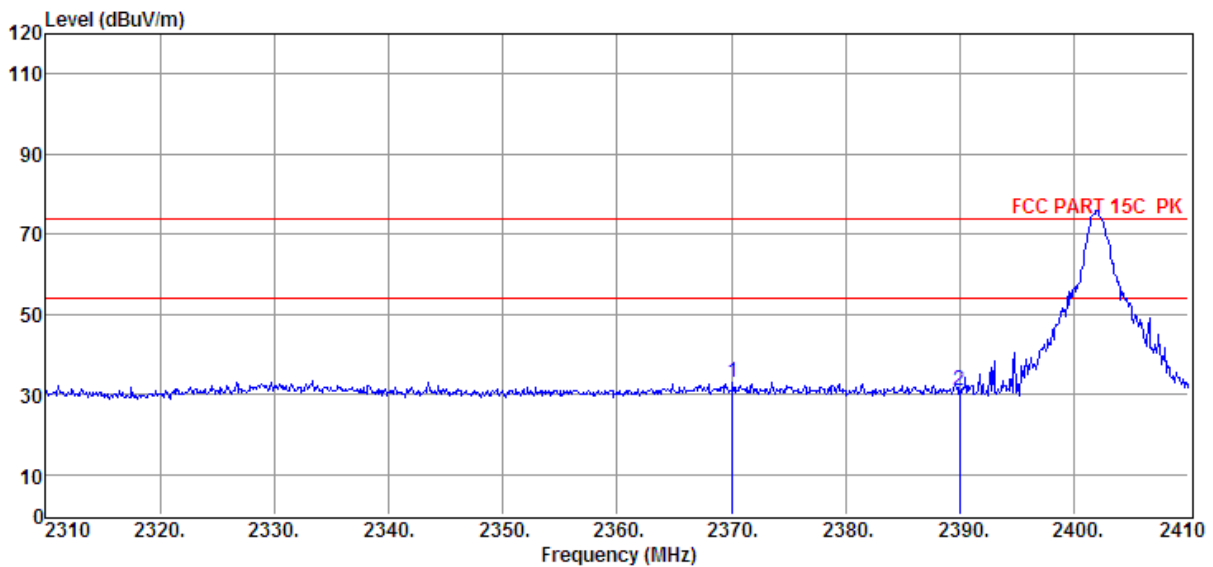

Item (Mark)	Freq. (MHz)	Read Level (dBμV)	Antenna Factor (dB/m)	PRM Factor dB	Cable Loss dB	Result Level (dBμV/m)	Limit Line (dBμV/ m)	Over Limit (dB)	Detector	Polarization
1	2370.10	45.19	26.93	44.32	5.09	32.89	74.00	-41.11	Peak	VERTICAL
2	2390.00	42.98	27.00	44.32	5.11	30.77	74.00	-43.23	Peak	VERTICAL

- Note: 1. Result Level = Read Level + Antenna Factor + Cable loss - PRM Factor.
 2. If Peak Result complies with AV limit, AV Result is deemed to comply with AV limit.
 3. Test setup: RBW: 1 MHz, VBW: 3 MHz, Sweep time: auto.

TR-4-E-009 Radiated Emission Test Result

Test Site : DDT 3m Chamber 1# D:\2018 RE1# Report Data\Q18030703-1E Air CD\RF.EM6
Test Date : 2018-03-29 **Tested By** : Sunny
EUT : Portable CD Player with Bluetooth **Model Number** : AIR CD
Power Supply : DC 3.0V **Test Mode** : Tx mode
Condition : Temp:24.5°C,Humi:55%,
 Press:100.1kPa **Antenna/Distance** : 2017 HF907/3m/HORIZONTAL
Memo : 8-QPSK 2480MHz

Data: 13

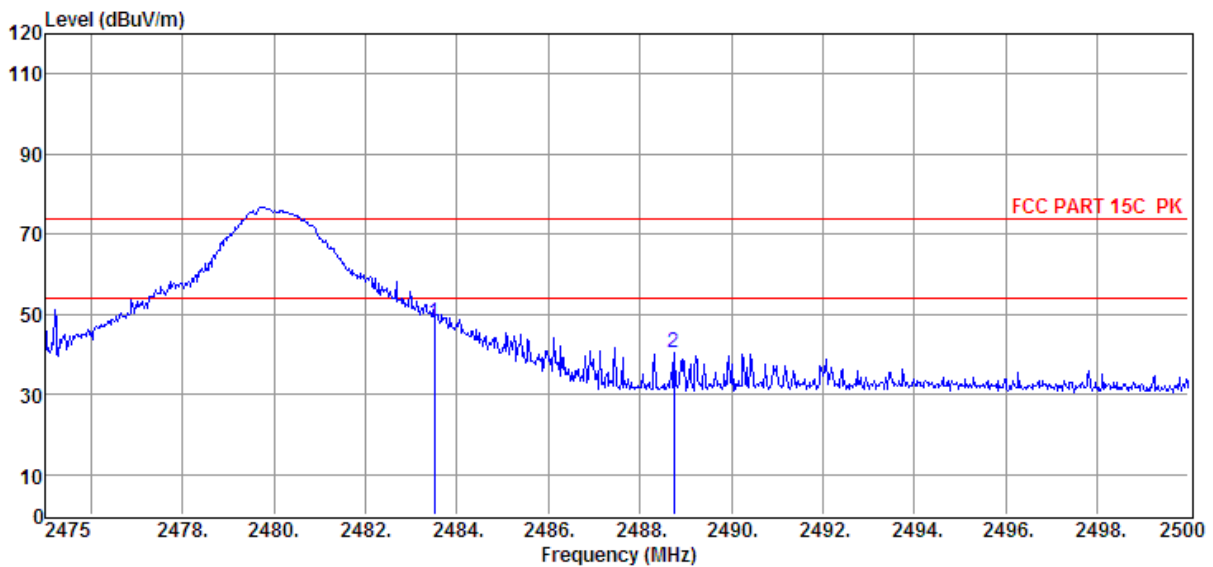

Item (Mark)	Freq. (MHz)	Read Level (dBμV)	Antenna Factor (dB/m)	PRM Factor dB	Cable Loss dB	Result Level (dBμV/m)	Limit Line (dBμV/ m)	Over Limit (dB)	Detector	Polarization
1	2483.50	59.60	27.34	44.32	5.21	47.83	74.00	-26.17	Peak	HORIZONTAL
2	2488.75	52.21	27.36	44.32	5.22	40.47	74.00	-33.53	Peak	HORIZONTAL

Note: 1. Result Level = Read Level + Antenna Factor + Cable loss - PRM Factor.
 2. If Peak Result complies with AV limit, AV Result is deemed to comply with AV limit.
 3. Test setup: RBW: 1 MHz, VBW: 3 MHz, Sweep time: auto.

TR-4-E-009 Radiated Emission Test Result

Test Site : DDT 3m Chamber 1# D:\2018 RE1# Report Data\Q18030703-1E Air CD\RF.EM6
Test Date : 2018-03-29 **Tested By** : Sunny
EUT : Portable CD Player with Bluetooth **Model Number** : AIR CD
Power Supply : DC 3.0V **Test Mode** : Tx mode
Condition : Temp:24.5'C,Humi:55%,
 Press:100.1kPa **Antenna/Distance** : 2017 HF907/3m/VERTICAL
Memo : 8-QPSK 2480MHz

Data: 14

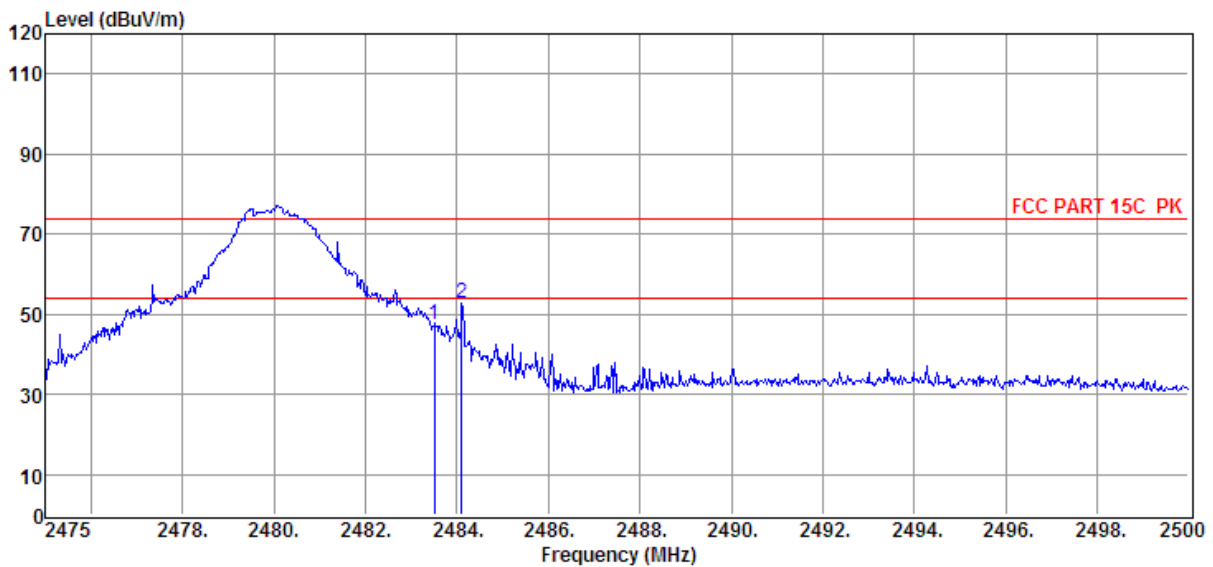

Item (Mark)	Freq. (MHz)	Read Level (dBμV)	Antenna Factor (dB/m)	PRM Factor dB	Cable Loss dB	Result Level (dBμV/m)	Limit Line (dBμV/ m)	Over Limit (dB)	Detector	Polarization
1	2483.50	59.35	27.34	44.32	5.21	47.58	74.00	-26.42	Peak	VERTICAL
2	2484.10	64.39	27.34	44.32	5.21	52.62	74.00	-21.38	Peak	VERTICAL

Note: 1. Result Level = Read Level + Antenna Factor + Cable loss - PRM Factor.
 2. If Peak Result complies with AV limit, AV Result is deemed to comply with AV limit.
 3. Test setup: RBW: 1 MHz, VBW: 3 MHz, Sweep time: auto.

13. Power Line Conducted Emission

13.1. Block diagram of test setup

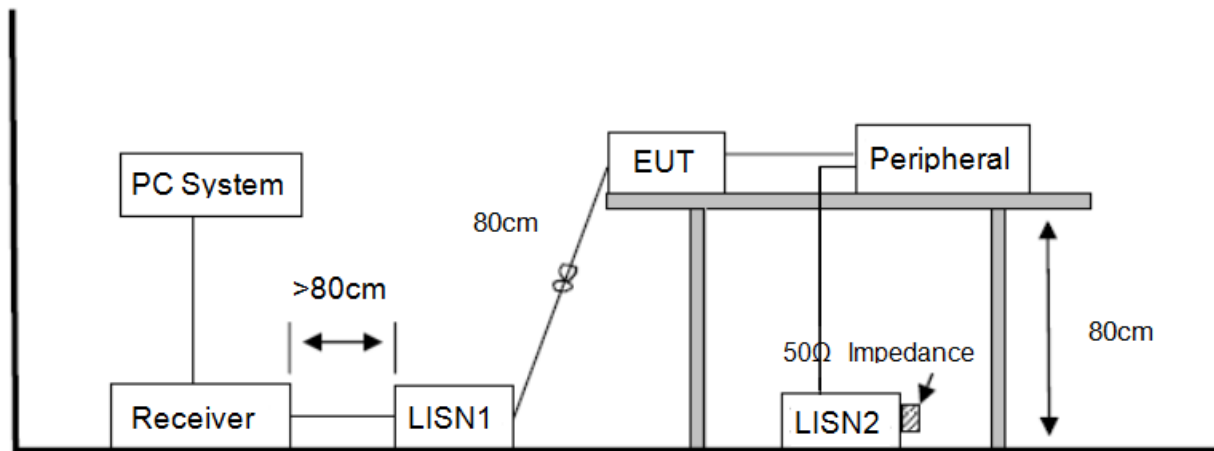

13.2. Power Line Conducted Emission Limits

Frequency	Quasi-Peak Level dB(μ V)	Average Level dB(μ V)
150kHz ~ 500kHz	66 ~ 56*	56 ~ 46*
500kHz ~ 5MHz	56	46
5MHz ~ 30MHz	60	50

Note 1: * Decreasing linearly with logarithm of frequency.

Note 2: The lower limit shall apply at the transition frequencies.

13.3. Test Procedure

The EUT and Support equipment, if needed, were put placed on a non-metallic table, 80cm above the ground plane.

Configuration EUT to simulate typical usage as described in clause 2.4 and test equipment as described in clause 10.2 of this report.

All I/O cables were positioned to simulate typical actual usage as per ANSI C63.10.

All support equipment power received from a second LISN.

Emissions were measured on each current carrying line of the EUT using an EMI Test Receiver connected to the LISN powering the EUT.

The Receiver scanned from 150 kHz to 30MHz for emissions in each of the test modes.

During the above scans, the emissions were maximized by cable manipulation.

The test mode(s) described in clause 2.4 were scanned during the preliminary test.

After the preliminary scan, we found the test mode producing the highest emission level.

The EUT configuration and worse cable configuration of the above highest emission levels were recorded for reference of the final test.

EUT and support equipment were set up on the test bench as per the configuration with highest emission level in the preliminary test.

A scan was taken on both power lines, Neutral and Line, recording at least the six highest emissions.

Emission frequency and amplitude were recorded into a computer in which correction factors were used to calculate the emission level and compare reading to the applicable limit.

The test data of the worst-case condition(s) was recorded.

The bandwidth of test receiver is set at 9 kHz.

13.4. Test Result

PASS. (See below detailed test result)

Note1: All emissions not reported below are too low against the prescribed limits.

Note2: "----" means Peak detection; "----" means Average detection.

Note3: Pre-test AC conducted emission at both voltage AC 120V/60Hz and AC 230V/50Hz, recorded worst case (AC 120V/60Hz).

TR-4-E-010 Conducted Emission Test Result

Test Site : DDT 1# Shield Room E:\2018 CE report data\Q18030703-1E\CE.EM6
Test Date : 2018-03-26 **Tested By** : Aaron
EUT : Portable CD Player with Bluetooth **Model Number** : AIR CD
Power Supply : AC 120V/60Hz **Test Mode** : Tx mode
Condition : Temp:24.5°C,Humi:55%,
LISN : 2017 ENV216/NEUTRAL
 Press:100.1kPa
Memo :

Data: 6

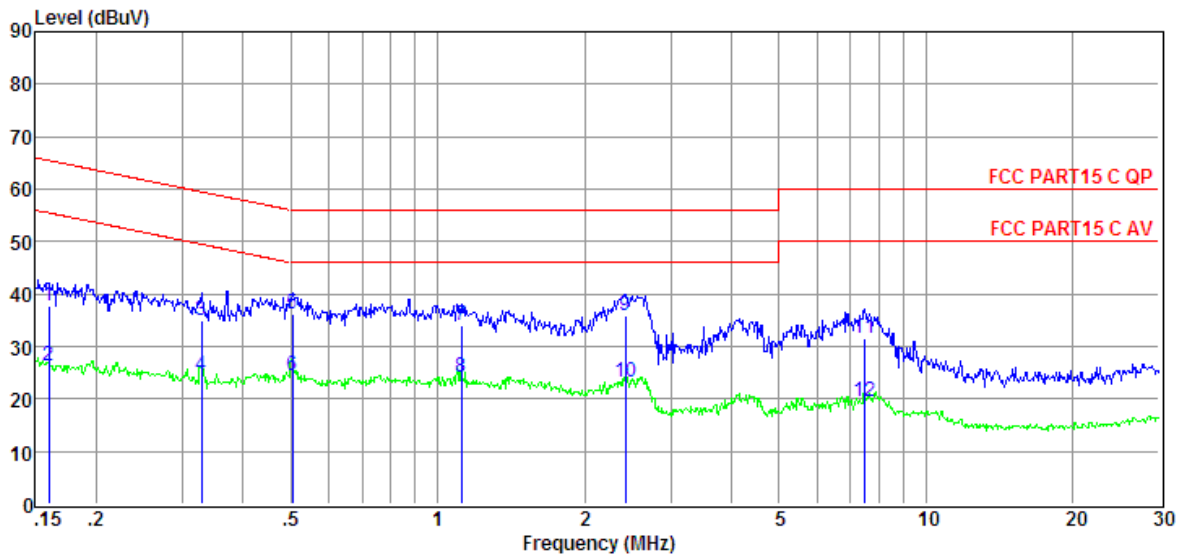

Item (Mark)	Freq. (MHz)	Read Level (dBµV)	LISN Factor (dB)	Cable Loss (dB)	Pulse Limiter Factor (dB)	Result Level (dBµV)	Limit Line (dBµV)	Over Limit (dB)	Detector	Phase
1	0.16	18.46	9.48	0.04	9.86	37.84	65.47	-27.63	QP	NEUTRAL
2	0.16	7.01	9.48	0.04	9.86	26.39	55.47	-29.08	Average	NEUTRAL
3	0.33	15.69	9.39	0.04	9.85	34.97	59.49	-24.52	QP	NEUTRAL
4	0.33	5.01	9.39	0.04	9.85	24.29	49.49	-25.20	Average	NEUTRAL
5	0.50	17.09	9.35	0.04	9.80	36.28	56.00	-19.72	QP	NEUTRAL
6	0.50	5.35	9.35	0.04	9.80	24.54	46.00	-21.46	Average	NEUTRAL
7	1.12	14.70	9.29	0.14	9.86	33.99	56.00	-22.01	QP	NEUTRAL
8	1.12	4.92	9.29	0.14	9.86	24.21	46.00	-21.79	Average	NEUTRAL
9	2.42	16.50	9.40	0.12	9.87	35.89	56.00	-20.11	QP	NEUTRAL
10	2.42	3.65	9.40	0.12	9.87	23.04	46.00	-22.96	Average	NEUTRAL
11	7.49	12.36	9.34	0.11	9.88	31.69	60.00	-28.31	QP	NEUTRAL
12	7.49	0.13	9.34	0.11	9.88	19.46	50.00	-30.54	Average	NEUTRAL

- Note: 1. Result Level = Read Level + LISN Factor + Pulse Limiter Factor + Cable loss.
 2. If QP Result complies with AV limit, AV Result is deemed to comply with AV limit.
 3. Test setup: RBW: 200 Hz (9 kHz—150 kHz), 9 kHz (150 kHz—30 MHz).
 4. Step size: 80Hz (0.009MHz-0.15MHz), 4 kHz (0.15MHz-30MHz), Scan time: auto.

TR-4-E-010 Conducted Emission Test Result

Test Site : DDT 1# Shield Room E:\2018 CE report data\Q18030703-1E\CE.EM6
Test Date : 2018-03-26 **Tested By** : Aaron
EUT : Portable CD Player with Bluetooth **Model Number** : AIR CD
Power Supply : AC 120V/60Hz **Test Mode** : Tx mode
Condition : Temp:24.5°C,Humi:55%,
LISN : 2017 ENV216/LINE
 Press:100.1kPa
Memo :

Data: 8

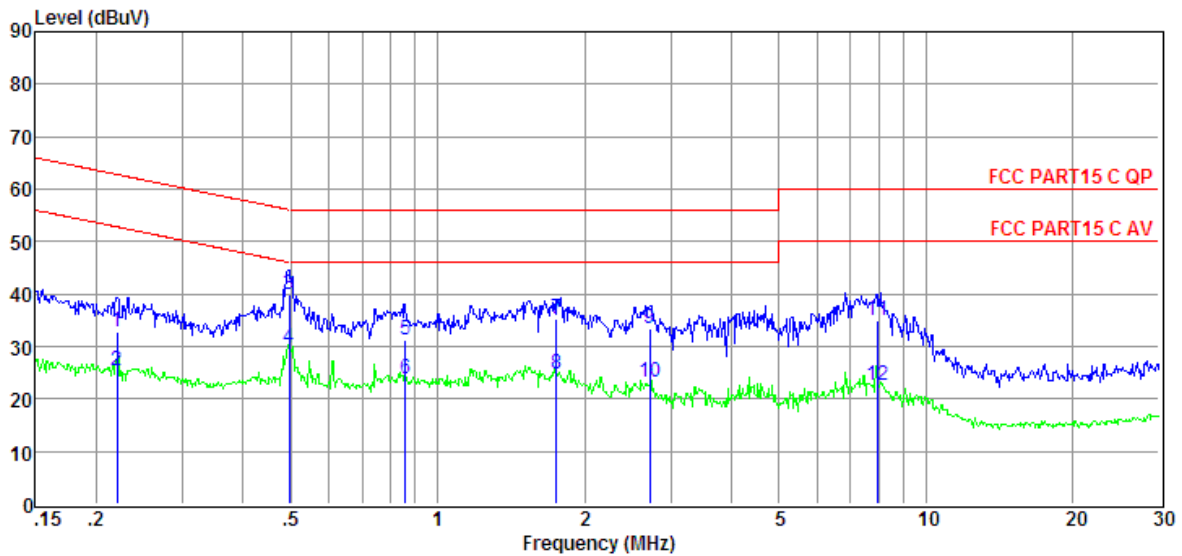

Item (Mark)	Freq. (MHz)	Read Level (dBµV)	LISN Factor (dB)	Cable Loss (dB)	Pulse Limiter Factor (dB)	Result Level (dBµV)	Limit Line (dBµV)	Over Limit (dB)	Detector	Phase
1	0.22	13.51	9.51	0.04	9.86	32.92	62.79	-29.87	QP	LINE
2	0.22	5.85	9.51	0.04	9.86	25.26	52.79	-27.53	Average	LINE
3	0.50	20.42	9.54	0.04	9.80	39.80	56.05	-16.25	QP	LINE
4	0.50	10.20	9.54	0.04	9.80	29.58	46.05	-16.47	Average	LINE
5	0.86	11.55	9.56	0.12	9.86	31.09	56.00	-24.91	QP	LINE
6	0.86	4.40	9.56	0.12	9.86	23.94	46.00	-22.06	Average	LINE
7	1.75	15.59	9.60	0.13	9.87	35.19	56.00	-20.81	QP	LINE
8	1.75	5.22	9.60	0.13	9.87	24.82	46.00	-21.18	Average	LINE
9	2.72	13.79	9.61	0.12	9.87	33.39	56.00	-22.61	QP	LINE
10	2.72	3.59	9.61	0.12	9.87	23.19	46.00	-22.81	Average	LINE
11	7.94	15.11	9.74	0.11	9.88	34.84	60.00	-25.16	QP	LINE
12	7.94	2.93	9.74	0.11	9.88	22.66	50.00	-27.34	Average	LINE

- Note: 1. Result Level = Read Level + LISN Factor + Pulse Limiter Factor + Cable loss.
 2. If QP Result complies with AV limit, AV Result is deemed to comply with AV limit.
 3. Test setup: RBW: 200 Hz (9 kHz—150 kHz), 9 kHz (150 kHz—30 MHz).
 4. Step size: 80Hz (0.009MHz-0.15MHz), 4 kHz (0.15MHz-30MHz), Scan time: auto.

14. Antenna Requirements

14.1. Limit

For intentional device, according to FCC 47 CFR Section 15.203, an intentional radiator shall be designed to ensure that no antenna other than that furnished by the responsible party shall be used with the device. And according to FCC 47 CFR Section 15.247 (b), if transmitting antennas of directional gain greater than 6dBi are used, the power shall be reduced by the amount in dB that the directional gain of the antenna exceeds 6dBi.

14.2. Result

The antennas used for this product are integrated antenna and that no antenna other than that furnished by the responsible party shall be used with the device, the maximum peak gain of the transmit antenna is only 0dBi.

END OF REPORT