



FCC PART 15 SUBPART C TEST REPORT

FCC PART 15.247

Report Reference No......: **TRE1402009601 R/C:17462**

FCC ID.....: **2AB33-TST178**

Compiled by

(position+printed name+signature)..: File administrators Eric Wang

Eric Wang

Supervised by

(position+printed name+signature)..: Test Engineer Yuchao Wang

yuchao.wang

Approved by

(position+printed name+signature)..: Manager Wenliang Li

Wenliang Li

Date of issue.....: Mar 24, 2014

Testing Laboratory Name: **Shenzhen Huatongwei International Inspection Co., Ltd**

Address: Keji Nan No.12 Road, Hi-tech Park, Shenzhen, China

Applicant's name.....: **Thunder Software Technology(Shenzhen) Co.,Ltd.**

Address: 7A03 Room, Microprofit Mansion, Nanshan District, Shenzhen City, China

Test specification

Standard: **FCC Part 15.247: Operation within the bands 902-928 MHz, 2400-2483.5 MHz and 5725-5850 MHz**

TRF Originator.....: Shenzhen Huatongwei International Inspection CO., Ltd

Master TRF.....: Dated 2006-06

Shenzhen Huatongwei International Inspection Co., Ltd. All rights reserved.

This publication may be reproduced in whole or in part for non-commercial purposes as long as the Shenzhen Huatongwei International Inspection Co., Ltd is acknowledged as copyright owner and source of the material. Shenzhen Huatongwei International Inspection Co., Ltd takes no responsibility for and will not assume liability for damages resulting from the reader's interpretation of the reproduced material due to its placement and context.

Test item description

Trade Mark: /

Model/Type reference.....: TST-178-A

Listed Models: TST-178-B

Manufacturer: **Thunder Software Technology(Shenzhen) Co.,Ltd.**

Operation Frequency.....: From 2412MHz to 2462MHz

Rating: Internal battery: 3.7V, 3000mAh

Adaptor: Input 100-240V a.c., 50/60Hz, 0.5A; Output 5V d.c., 2.5A

Result.....: **PASS**

TEST REPORT

Test Report No. :	TRE1402009601	Mar 24, 2014
		Date of issue

Equipment under Test : PAD

Model /Type : TST-178-A

Listed Models : TST-178-B

Applicant : **Thunder Software Technology(Shenzhen) Co.,Ltd.**

Address : 7A03 Room, Microprofit Mansion, Nanshan District, Shenzhen City, China

Manufacturer : **Thunder Software Technology(Shenzhen) Co.,Ltd.**

Address : 7A03 Room, Microprofit Mansion, Nanshan District, Shenzhen City, China

Test Result	PASS
--------------------	-------------

The test report merely corresponds to the test sample.

It is not permitted to copy extracts of these test result without the written permission of the test laboratory.

Contents

1.	<u>TEST STANDARDS</u>	4
2.	<u>SUMMARY</u>	5
2.1.	General Remarks	5
2.2.	Product Description	5
2.3.	Equipment Under Test	5
2.4.	Description of the test mode	5
2.5.	Internal Identification of AE used during the test	6
2.6.	Short description of the Equipment under Test (EUT)	6
2.7.	EUT operation mode	6
2.8.	EUT configuration	6
2.9.	Related Submittal(s) / Grant (s)	6
2.10.	Modifications	6
2.11.	NOTE	6
3.	<u>TEST ENVIRONMENT</u>	8
3.1.	Address of the test laboratory	8
3.2.	Test Facility	8
3.3.	Environmental conditions	9
3.4.	Test Description	9
3.5.	Statement of the measurement uncertainty	9
3.6.	Equipments Used during the Test	10
4.	<u>TEST CONDITIONS AND RESULTS</u>	11
4.1.	AC Power Conducted Emission	11
4.2.	Radiated Emission	13
4.3.	Maximum Peak Output Power	21
4.4.	Power Spectral Density	30
4.5.	Band Edge Compliance of RF Emission	39
4.6.	Spurious RF Conducted Emission	50
4.7.	6dB Bandwidth	75
4.8.	Antenna Requirement	84
5.	<u>TEST SETUP PHOTOS OF THE EUT</u>	85
6.	<u>EXTERNAL AND INTERNAL PHOTOS OF THE EUT</u>	87

1. TEST STANDARDS

The tests were performed according to following standards:

[FCC Rules Part 15.247](#): Frequency Hopping, Direct Spread Spectrum and Hybrid Systems that are in operation within the bands of 902-928 MHz, 2400-2483.5 MHz, and 5725-5850 MHz.

[ANSI C63.10](#): American National Standard for Testing Unlicensed Wireless Devices

[KDB558074 D01 V03](#): Guidance for Performing Compliance Measurements on Digital Transmission Systems (DTS) Operating Under §15.247

2. SUMMARY

2.1. General Remarks

Date of receipt of test sample	:	Feb 15, 2014
Testing commenced on	:	Feb 17, 2014
Testing concluded on	:	Mar 23, 2014

2.2. Product Description

The **Thunder Software Technology(Shenzhen) Co.,Ltd.** 's Model:TST-178-A or the "EUT" as referred to in this report; more general information as follows, for more details, refer to the user's manual of the EUT.

Name of EUT	PAD
Model Number	TST-178-A,TST-178-B
FCC ID	2AB33-TST178
WLAN	Supported 802.11b/802.11g/802.11n
Bluetooth	Not Supported
Antenna Type	Internal
WLAN FCC Operation frequency	IEEE 802.11b: 2412MHz—2462MHz IEEE 802.11g: 2412MHz—2462MHz IEEE 802.11n HT20: 2412MHz—2462MHz IEEE 802.11n HT40: 2422MHz—2452MHz
WLAN Modulation	IEEE 802.11b: DSSS(CCK,DQPSK,DBPSK) IEEE 802.11g: OFDM(64QAM, 16QAM, QPSK, BPSK) IEEE 802.11n HT20: OFDM (64QAM, 16QAM, QPSK,BPSK) IEEE 802.11n HT40: OFDM (64QAM, 16QAM, QPSK,BPSK)

2.3. Equipment Under Test

Power supply system utilised

Power supply voltage	:	<input type="radio"/> 120V / 60 Hz	<input type="radio"/> 115V / 60Hz
		<input type="radio"/> 12 V DC	<input type="radio"/> 24 V DC
		<input checked="" type="radio"/> Other (specified in blank below)	

Internal battery:3.7V, 3000mAh

Adaptor:Input 100-240Va.c., 50/60Hz, 0.5A; Output 5Vd.c., 2.5A

2.4. Description of the test mode

IEEE 802.11b/g/n: Eleven channels are provided to the EUT.

Channel	Frequency(MHz)	Channel	Frequency(MHz)
1	2412	8	2447
2	2417	9	2452
3	2422	10	2457
4	2427	11	2462
5	2432		
6	2437		
7	2442		

2.5. Internal Identification of AE used during the test

AE ID*	Description
AE1	Battery
AE2	Charger and USB cable

AE2:

MODEL: AW018WR-0500250V V
 INPUT:100-240V~0.3A 50/60Hz 0.5A
 OUTPUT: 5V DC 2.5A
 ◇ Shielded ◆ Unshielded

*AE ID: is used to identify the test sample in the lab internally.

2.6. Short description of the Equipment under Test (EUT)

2.4GHz (PAD (M/N: TST-178-A))

For more details, refer to the user's manual of the EUT.

2.7. EUT operation mode

The EUT has been tested under typical operating condition. The Applicant provides command to control the EUT for staying in continuous transmitting and receiving mode for testing.

2.8. EUT configuration

The following peripheral devices and interface cables were connected during the measurement:

- - supplied by the manufacturer
- - supplied by the lab

<input type="radio"/>	Power Cable	Length (m) :	/
		Shield :	/
		Detachable :	/
<input type="radio"/>	Multimeter	Manufacturer :	/
		Model No. :	/

2.9. Related Submittal(s) / Grant (s)

This submittal(s) (test report) is intended for **FCC ID: 2AB33-TST178** filing to comply with Section 15.247 of the FCC Part 15, Subpart C Rules.

2.10. Modifications

No modifications were implemented to meet testing criteria.

2.11. NOTE

1. The EUT is a PAD with WLAN function, The functions of the EUT listed as below:

	Test Standards	Reference Report
WLAN	FCC Part 15 C 15.247	TRE1402009601
USB Port	FCC Part 15 Subpart B	TRE1402009602
RF Exposure	FCC Per 47 CFR 2.1093(d)	TRE1402009603

2. The frequency bands used in this EUT are listed as follows:

Frequency Band(MHz)	2400-2483.5	5150-5350	5470-5725	5725-5850
802.11b	√	—	—	—
802.11g	√	—	—	—
802.11n(20MHz)	√	—	—	—
802.11n(40MHz)	√	—	—	—

3. The EUT incorporates a SISO function,Physically,the EUT provides one completed transmitter and one completed receiver.

Modulation Mode	TX Function
802.11b	1TX
802.11g	1TX
802.11n (20MHz)	1TX
802.11n (40MHz)	1TX

3 . TEST ENVIRONMENT

3.1. Address of the test laboratory

Shenzhen Huatongwei International Inspection Co., Ltd
Keji Nan No.12 Road, Hi-tech Park, Shenzhen, China
Phone: 86-755-26715686 Fax: 86-755-26748089

The sites are constructed in conformance with the requirements of ANSI C63.7, ANSI C63.4 (2009) and CISPR Publication 22.

3.2. Test Facility

The test facility is recognized, certified, or accredited by the following organizations:

CNAS-Lab Code: L1225

Shenzhen Huatongwei International Inspection Co., Ltd. has been assessed and proved to be in compliance with CNAS-CL01 Accreditation Criteria for Testing and Calibration Laboratories (identical to ISO/IEC 17025: 2005 General Requirements) for the Competence of Testing and Calibration Laboratories, Date of Registration: Mar. 29, 2012. Valid time is until Feb. 28, 2015.

A2LA-Lab Cert. No. 2243.01

Shenzhen Huatongwei International Inspection Co., Ltd. EMC Laboratory has been accredited by A2LA for technical competence in the field of electrical testing, and proved to be in compliance with ISO/IEC 17025: 2005 General Requirements for the Competence of Testing and Calibration Laboratories and any additional program requirements in the identified field of testing. Valid time is until Sept. 30, 2015.

FCC-Registration No.: 662850

Shenzhen Huatongwei International Inspection Co., Ltd. EMC Laboratory has been registered and fully described in a report filed with the FCC (Federal Communications Commission). The acceptance letter from the FCC is maintained in our files. Registration 662850, Renewal date Jun. 01, 2012, valid time is until Jun. 01, 2015.

IC-Registration No.: 5377A

The 3m Alternate Test Site of Shenzhen Huatongwei International Inspection Co., Ltd. has been registered by Certification and Engineering Bureau of Industry Canada for the performance of radiated measurements with Registration No. 5377A on Dec. 31, 2013, valid time is until Dec. 31, 2016.

ACA

Shenzhen Huatongwei International Inspection Co., Ltd. EMC Laboratory can also perform testing for the Australian C-Tick mark as a result of our A2LA accreditation.

VCCI

The 3m Semi-anechoic chamber (12.2m×7.95m×6.7m) and Shielded Room (8m×4m×3m) of Shenzhen Huatongwei International Inspection Co., Ltd. has been registered in accordance with the Regulations for Voluntary Control Measures with Registration No.: G-292. Date of Registration: Dec. 20, 2012. Valid time is until Dec. 19, 2015.

Main Ports Conducted Interference Measurement of Shenzhen Huatongwei International Inspection Co., Ltd. has been registered in accordance with the Regulations for Voluntary Control Measures with Registration No.: C-2726. Date of Registration: Dec. 20, 2012. Valid time is until Dec. 19, 2015.

Telecommunication Ports Conducted Interference Measurement of Shenzhen Huatongwei International Inspection Co., Ltd. has been registered in accordance with the Regulations for Voluntary Control Measures with Registration No.: T-1837. Date of Registration: May 07, 2013. Valid time is until May 06, 2016.

DNV

Shenzhen Huatongwei International Inspection Co., Ltd. has been found to comply with the requirements of DNV towards subcontractor of EMC and safety testing services in conjunction with the EMC and Low voltage Directives and in the voluntary field. The acceptance is based on a formal quality Audit and follow-ups according to relevant parts of ISO/IEC Guide 17025 (2005), in accordance with the requirements of the DNV Laboratory Quality Manual towards subcontractors. Valid time is until Aug. 24, 2016.

3.3. Environmental conditions

During the measurement the environmental conditions were within the listed ranges:

Temperature:	<u>15-35 ° C</u>
Humidity:	<u>30-60 %</u>
Atmospheric pressure:	<u>950-1050mbar</u>

3.4. Test Description

FCC PART 15 15.247		
FCC Part 15.207	AC Power Conducted Emission	PASS
FCC Part 15.247(a)(2)	6dB Bandwidth	PASS
FCC Part 15.247(d)	Spurious RF Conducted Emission	PASS
FCC Part 15.247(b)	Maximum Peak Output Power	PASS
FCC Part 15.247(e)	Power Spectral Density	PASS
FCC Part 15.109/ 15.205/ 15.209	Radiated Emissions	PASS
FCC Part 15.247(d)	Band Edge	PASS
FCC Part 15.203/15.247 (b)	Antenna Requirement	PASS

Remark: The measurement uncertainty is not included in the test result.

Preliminary tests were performed in different data rate to find the worst radiated emission. The data rate shown in the table below is the worst-case rate with respect to the specific test item. Investigation has been done on all the possible configurations for searching the worst cases. The following table is a list of the test modes shown in this test report.

Test Items	Mode	Data Rate	Channel
Maximum Peak Conducted Output Power	11b/DSSS	1 Mbps	1/6/11
Power Spectral Density	11g/OFDM	6 Mbps	1/6/11
6dB Bandwidth	11n(20MHz)/OFDM	6.5Mbps	1/6/11
Spurious RF conducted emission	11n(40MHz)/OFDM	13.5Mbps	3/6/9
Radiated Emission 9kHz~1GHz&	11b/DSSS	1 Mbps	1/11
Radiated Emission 1GHz~10th Harmonic	11g/OFDM	6 Mbps	1/11
Band Edge	11n(20MHz)/OFDM	6.5Mbps	1/11
	11n(40MHz)/OFDM	13.5Mbps	3/9

3.5. Statement of the measurement uncertainty

The data and results referenced in this document are true and accurate. The reader is cautioned that there may be errors within the calibration limits of the equipment and facilities. The measurement uncertainty was calculated for all measurements listed in this test report acc. to CISPR 16 - 4 „Specification for radio disturbance and immunity measuring apparatus and methods – Part 4: Uncertainty in EMC Measurements“ and is documented in the Shenzhen Huatongwei International Inspection Co., Ltd quality system acc. to DIN EN ISO/IEC 17025. Furthermore, component and process variability of devices similar to that tested may result in additional deviation. The manufacturer has the sole responsibility of continued compliance of the device.

Hereafter the best measurement capability for Shenzhen Huatongwei laboratory is reported:

Test Items	Measurement Uncertainty	Notes
Frequency stability	25 Hz	(1)
Transmitter power conducted	0.57 dB	(1)
Transmitter power Radiated	2.20 dB	(1)
Conducted spurious emission 9KHz-12.75 GHz	1.60 dB	(1)
Radiated spurious emission 9KHz-12.75 GHz	2.20 dB	(1)
Conducted Emission 9KHz-30MHz	3.39 dB	(1)
Radiated Emission 30~1000MHz	4.24 dB	(1)
Radiated Emissio 1~18GHz	5.16 dB	(1)

Radiated Emissio 18-40GHz	5.54 dB	(1)
Occupied Bandwidth	-----	(1)
Emission Mask	-----	(1)
Modulation Characteristic	-----	(1)
Transmitter Frequency Behavior	-----	(1)

(1) This uncertainty represents an expanded uncertainty expressed at approximately the 95% confidence level using a coverage factor of k=1.96.

3.6. Equipments Used during the Test

AC Power Conducted Emission					
Item	Test Equipment	Manufacturer	Model No.	Serial No.	Cal.Due
1	Artificial Mains	Rohde&Schwarz	ESH2-Z5	100028	2014/10/25
2	EMI Test Receiver	Rohde&Schwarz	ESCI	100106	2014/10/25
3	Pulse Limiter	Rohde&Schwarz	ESHSZ2	100044	2014/10/25
4	EMI Test Software	Rohde&Schwarz	ES-K1 V1.71	N/A	N/A

Radiated Emission					
Item	Test Equipment	Manufacturer	Model No.	Serial No.	Cal.Due
1	Ultra-Broadband Antenna	Rohde&Schwarz	HL562	100015	2014/10/25
2	EMI TEST RECEIVER	Rohde&Schwarz	ESI 26	100009	2014/10/25
3	EMI TEST OPTWARE	Audix	E3	N/A	2014/10/25
4	TURNTABLE	ETS	2088	2149	N/A
5	ANTENNA MAST	ETS	2075	2346	N/A
6	EMI TEST Software	Rohde&Schwarz	ESK1	N/A	N/A
7	HORN ANTENNA	ShwarzBeck	9120D	1011	2014/10/25
8	Amplifer	Sonoma	310N	E009-13	2014/10/25
9	JS amplifer	Rohde&Schwarz	JS4-00101800-28-5A	F201504	2014/10/25
10	High pass filter	Compliance Direction systems	BSU-6	34202	2014/10/25
11	HORN ANTENNA	ShwarzBeck	9120D	1012	2014/10/25
12	Amplifer	Compliance Direction systems	PAP1-4060	120	2014/10/25
13	Loop Antenna	Rohde&Schwarz	HFH2-Z2	100020	2014/10/25
14	TURNTABLE	MATURO	TT2.0	----	N/A
15	ANTENNA MAST	MATURO	TAM-4.0-P	----	N/A
16	Horn Antenna	SCHWARZBECK	BBHA9170	25841	2014/10/25

Maximum Peak Output Power / Power Spectral Density / 6dB Bandwidth / Band Edge Compliance of RF Emission / Spurious RF Conducted Emission					
Item	Test Equipment	Manufacturer	Model No.	Serial No.	Cal.Due
1	Spectrum Analyzer	Rohde&Schwarz	FSP	1164.4391.40	2014/10/25

The Cal.Interval was one year

4. TEST CONDITIONS AND RESULTS

4.1. AC Power Conducted Emission

TEST CONFIGURATION

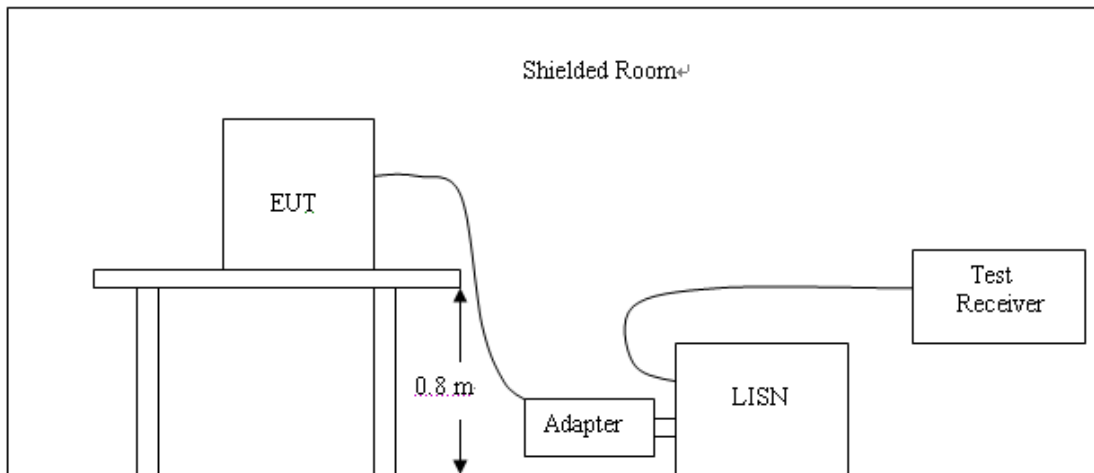

TEST PROCEDURE

- 1 The equipment was set up as per the test configuration to simulate typical actual usage per the user's manual. The EUT is a tabletop system, a wooden table with a height of 0.8 meters is used and is placed on the ground plane as per ANSI C63.4-2009.
- 2 Support equipment, if needed, was placed as per ANSI C63.4-2009
- 3 All I/O cables were positioned to simulate typical actual usage as per ANSI C63.4-2009
- 4 The EUT received DC5V power from the adapter, the adapter received AC120V/60Hz power through a Line Impedance Stabilization Network (LISN) which supplied power source and was grounded to the ground plane.
- 5 All support equipments received AC power from a second LISN, if any.
- 6 The EUT test program was started. Emissions were measured on each current carrying line of the EUT using a spectrum Analyzer / Receiver connected to the LISN powering the EUT. The LISN has two monitoring points: Line 1 (Hot Side) and Line 2 (Neutral Side). Two scans were taken: one with Line 1 connected to Analyzer / Receiver and Line 2 connected to a 50 ohm load; the second scan had Line 1 connected to a 50 ohm load and Line 2 connected to the Analyzer / Receiver.
- 7 Analyzer / Receiver scanned from 150 KHz to 30MHz for emissions in each of the test modes.
- 8 During the above scans, the emissions were maximized by cable manipulation.

AC Power Conducted Emission Limit

For intentional device, according to § 15.207(a) AC Power Conducted Emission Limits is as following :

Frequency (MHz)	Maximum RF Line Voltage (dBµV)			
	CLASS A		CLASS B	
	Q.P.	Ave.	Q.P.	Ave.
0.15 - 0.50	79	66	66-56*	56-46*
0.50 - 5.00	73	60	56	46
5.00 - 30.0	73	60	60	50

* Decreasing linearly with the logarithm of the frequency

TEST RESULTS

The AC Power Conducted Emission measurement are performed the each test mode (b/g/n) and channel (low/mid/high), the datum recorded below (802.11b mode, the middle channel) is the worst case for all the test modes and channels.

SCAN TABLE: "Voltage (9K-30M) FIN"
 Short Description: 150K-30M Voltage

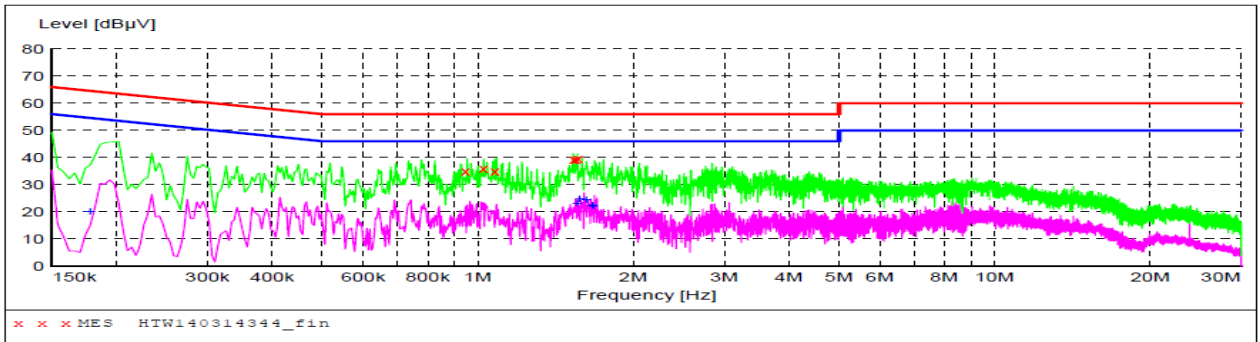

MEASUREMENT RESULT: "HTW140314344_fin"

3/14/2014 2:44PM

Frequency MHz	Level dBuV	Transd dB	Limit dBuV	Margin dB	Detector	Line	PE
0.946000	34.80	10.5	56	21.2	QP	N	GND
1.026000	36.00	10.6	56	20.0	QP	N	GND
1.078000	35.00	10.6	56	21.0	QP	N	GND
1.534000	39.30	10.5	56	16.7	QP	N	GND
1.550000	39.30	10.5	56	16.7	QP	N	GND
1.566000	39.40	10.5	56	16.6	QP	N	GND

MEASUREMENT RESULT: "HTW140314344_fin2"

3/14/2014 2:44PM

Frequency MHz	Level dBuV	Transd dB	Limit dBuV	Margin dB	Detector	Line	PE
0.178000	20.10	12.4	55	34.5	AV	N	GND
1.558000	23.20	10.5	46	22.8	AV	N	GND
1.574000	24.80	10.5	46	21.2	AV	N	GND
1.622000	24.60	10.5	46	21.4	AV	N	GND
1.666000	22.60	10.5	46	23.4	AV	N	GND
1.670000	22.10	10.5	46	23.9	AV	N	GND

SCAN TABLE: "Voltage (9K-30M) FIN"
 Short Description: 150K-30M Voltage

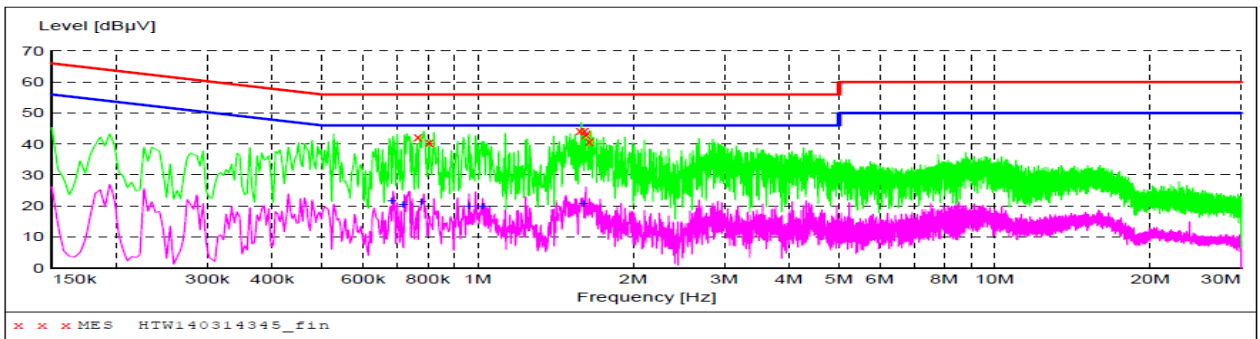

MEASUREMENT RESULT: "HTW140314345_fin"

3/14/2014 2:47PM

Frequency MHz	Level dBuV	Transd dB	Limit dBuV	Margin dB	Detector	Line	PE
0.766000	42.20	10.4	56	13.8	QP	L1	GND
0.806000	40.60	10.4	56	15.4	QP	L1	GND
1.578000	44.40	10.5	56	11.6	QP	L1	GND
1.610000	44.30	10.5	56	11.7	QP	L1	GND
1.618000	43.20	10.5	56	12.8	QP	L1	GND
1.646000	40.70	10.5	56	15.3	QP	L1	GND

MEASUREMENT RESULT: "HTW140314345_fin2"

3/14/2014 2:47PM

Frequency MHz	Level dBuV	Transd dB	Limit dBuV	Margin dB	Detector	Line	PE
0.682000	21.70	10.4	46	24.3	AV	L1	GND
0.718000	20.60	10.4	46	25.4	AV	L1	GND
0.778000	21.50	10.4	46	24.5	AV	L1	GND
0.962000	20.10	10.5	46	25.9	AV	L1	GND
1.022000	19.90	10.6	46	26.1	AV	L1	GND
1.602000	21.00	10.5	46	25.0	AV	L1	GND

4.2. Radiated Emission

TEST CONFIGURATION

Frequency range 9KHz – 30MHz

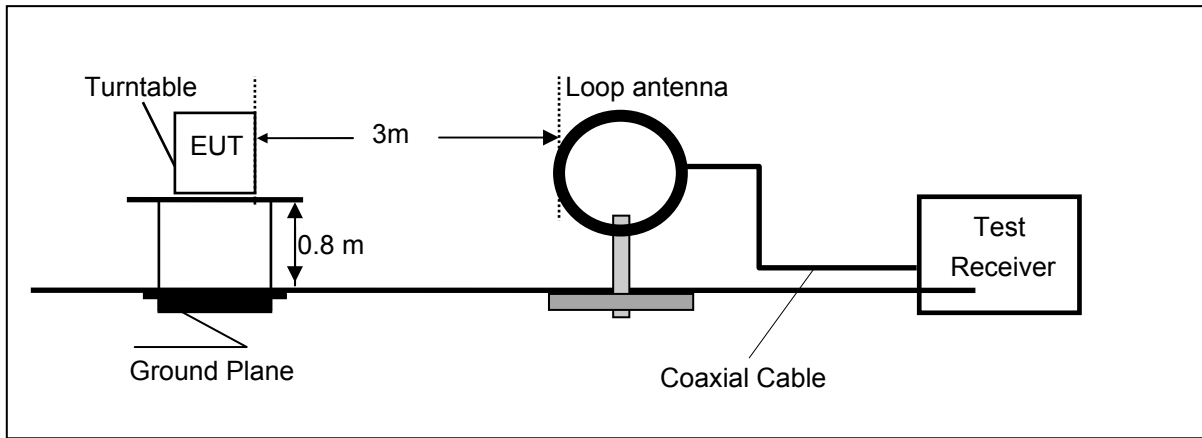

Frequency range 30MHz – 100MHz

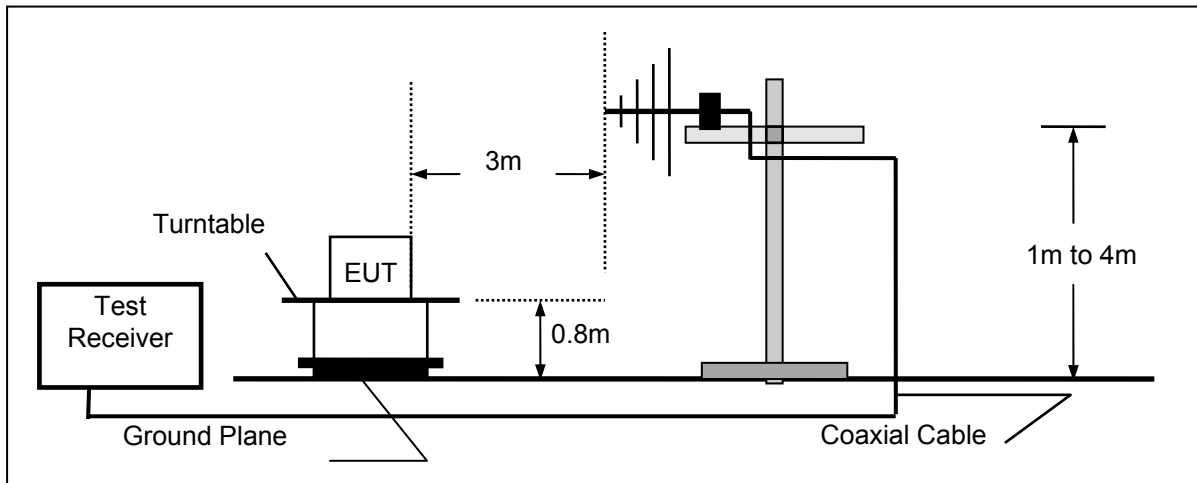

Frequency range above 1GHz-25GHz

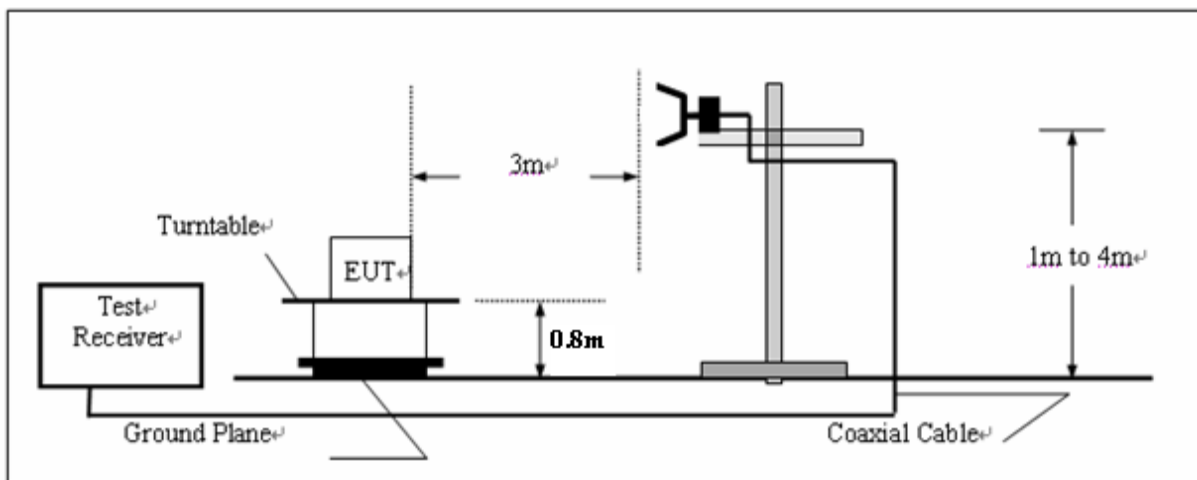

TEST PROCEDURE

1. The EUT was placed on a turn table which is 0.8m above ground plane.
2. Maximum procedure was performed by raising the receiving antenna from 1m to 4m and rotating the turn table from 0° to 360° to acquire the highest emissions from EUT

3. And also, each emission was to be maximized by changing the polarization of receiving antenna both horizontal and vertical.
4. Repeat above procedures until all frequency measurements have been completed.
5. The EUT minimum operation frequency was 32.768KHz and maximum operation frequency was 2462MHz.so radiated emission test frequency band from 9KHz to 25GHz.

Field Strength Calculation

The field strength is calculated by adding the Antenna Factor and Cable Factor and subtracting the Amplifier Gain and Duty Cycle Correction Factor(if any) from the measured reading. The basic equation with a sample calculation is as follows:

$$FS = RA + AF + CL - AG$$

Where FS = Field Strength	CL = Cable Attenuation Factor (Cable Loss)
RA = Reading Amplitude	AG = Amplifier Gain
AF = Antenna Factor	

RADIATION LIMIT

For intentional device, according to § 15.209(a), the general requirement of field strength of radiated emission from intentional radiators at a distance of 3 meters shall not exceed the following table. According to § 15.247(d), in any 100kHz bandwidth outside the frequency band in which the EUT is operating, the radio frequency power that is produced by the intentional radiator shall be at least 20dB below that in the100kHz bandwidth within the band that contains the highest level of desired power.

The frequency spectrum above 1 GHz for Transmitter was investigated. All emission not reported are much lower than the prescribed limits. Set the RBW=1MHz,VBW=3MHz for Peak Detector while the RBW=1MHz,VBW=10Hz for Average Detector,Readings are both peak and average values.

Frequency (MHz)	Distance (Meters)	Radiated (dBµV/m)	Radiated (µV/m)
0.009-0.49	300	20log(2400/F(KHz))+80	2400/F(KHz)
0.49-1.705	30	20log(24000/F(KHz))+40	24000/F(KHz)
1.705-30	30	20log(30)+40	30
30-88	3	40.0	100
88-216	3	43.5	150
216-960	3	46.0	200
Above 960	3	54.0	500

TEST RESULTS

Remark:

1. The radiated measurement are performed the each test mode (b/g/n) and channel (low/mid/high), the datum recorded below (802.11b mode,the middle channel) is the worst case for all the test mode and channel.
2. ULTRA-BROADBAND ANTENNA for the radiation emission test below 1G.
3. HORN ANTENNA for the radiation emission test above 1G.
4. We tested both battery powered and charging mode at three orientations,recored woest case at charging mode.

For 9KHz to 30MHz

Frequency (MHz)	Corrected Reading (dBµV/m)@3m	FCC Limit (dBµV/m) @3m	Margin (dB)	Detector	Result
0.25	65.21	99.65	34.44	QP	PASS
1.51	45.14	64.02	18.88	QP	PASS
15.35	49.32	69.54	20.22	QP	PASS
25.34	42.08	69.54	27.46	QP	PASS

For 30MHz to 1000MHz

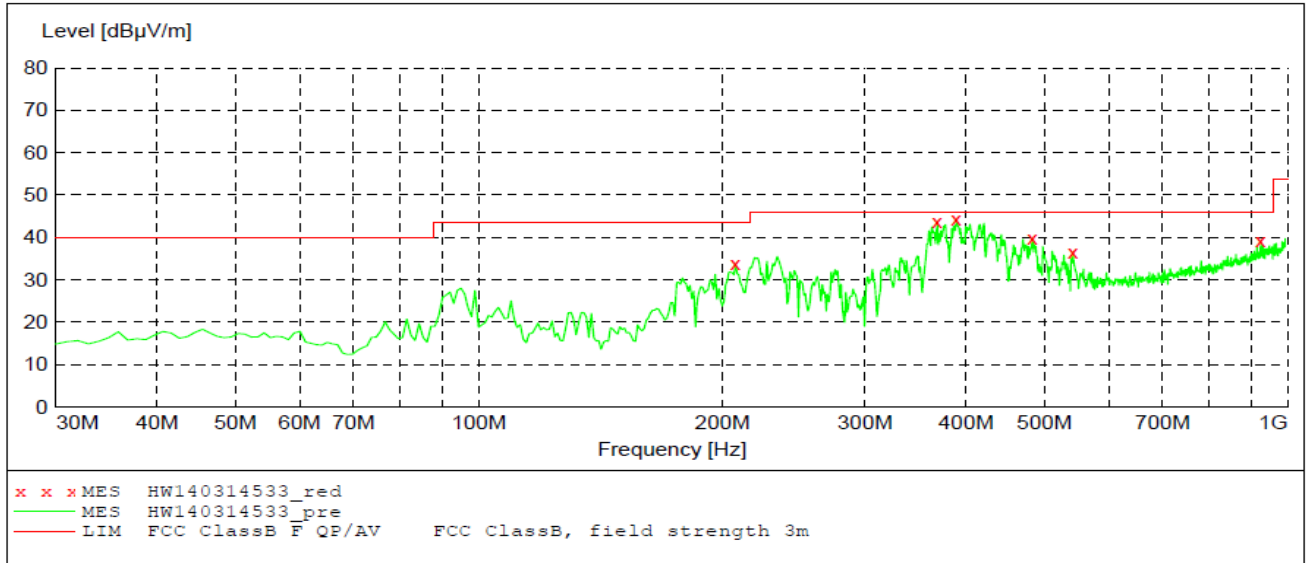

MEASUREMENT RESULT: "HW140314533_red"

3/14/2014 1:23PM

Frequency MHz	Level dBµV/m	Transd dB	Limit dBµV/m	Margin dB	Det.	Height cm	Azimuth deg	Polarization
207.510000	33.70	-14.9	43.5	9.8	PK	300.0	61.00	HORIZONTAL
368.530000	43.70	-11.7	46.0	2.3	PK	100.0	164.00	HORIZONTAL
388.900000	44.30	-11.2	46.0	1.7	PK	100.0	187.00	HORIZONTAL
482.990000	39.80	-7.9	46.0	6.2	PK	100.0	187.00	HORIZONTAL
542.160000	36.60	-5.6	46.0	9.4	PK	100.0	28.00	HORIZONTAL
925.310000	39.10	3.1	46.0	6.9	PK	300.0	0.00	HORIZONTAL

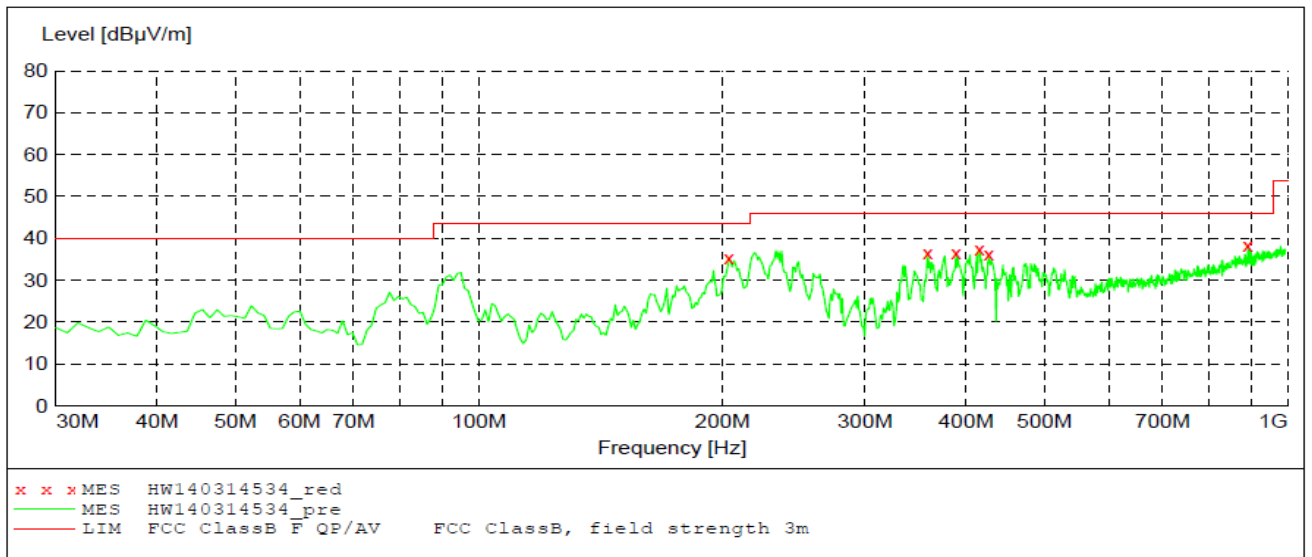

MEASUREMENT RESULT: "HW140314534_red"

3/14/2014 1:27PM

Frequency MHz	Level dBµV/m	Transd dB	Limit dBµV/m	Margin dB	Det.	Height cm	Azimuth deg	Polarization
203.630000	35.40	-14.7	43.5	8.1	PK	100.0	102.00	VERTICAL
358.830000	36.60	-11.8	46.0	9.4	PK	100.0	57.00	VERTICAL
388.900000	36.40	-11.2	46.0	9.6	PK	100.0	358.00	VERTICAL
416.060000	37.30	-10.1	46.0	8.7	PK	100.0	358.00	VERTICAL
426.730000	36.10	-9.7	46.0	9.9	PK	100.0	0.00	VERTICAL
892.330000	38.40	2.3	46.0	7.6	PK	100.0	360.00	VERTICAL

For 1GHz to 25GHz

802.11b Mode(above 1GHz)

ANTENNA POLARITY & TEST DISTANCE: HORIZONTAL AT 3 M (802.11b--2412MHz)												
No.	Frequency (MHz)	Emission Level (dBuV/m)		Limit (dBuV/m)	Margin (dB)	Antenna Height (m)	Table Angle (Degree)	Raw Value (dBuV)	Antenna Factor (dB/m)	Cable Factor (dB)	Pre-amplifier	Correction Factor (dB/m)
1	4824.00	56.23	PK	74.00	17.77	1.00 H	123	54.13	31.60	7.00	36.5	2.10
1	4824.00	35.20	AV	54.00	18.80	1.00 H	123	33.10	31.60	7.00	36.5	2.10
2	7236.00	56.30	PK	74.00	17.70	1.00 H	155	45.37	37.33	8.90	35.3	10.93
2	7236.00	35.11	AV	54.00	18.89	1.00 H	125	24.18	37.33	8.90	35.3	10.93

ANTENNA POLARITY & TEST DISTANCE: VERTICAL AT 3 M (802.11b--2412MHz)												
No.	Frequency (MHz)	Emission Level (dBuV/m)		Limit (dBuV/m)	Margin (dB)	Antenna Height (m)	Table Angle (Degree)	Raw Value (dBuV)	Antenna Factor (dB/m)	Cable Factor (dB)	Pre-amplifier	Correction Factor (dB/m)
1	4824.00	57.69	PK	74.00	16.31	1.00 H	185	55.59	31.60	7.00	36.5	2.10
1	4824.00	39.20	AV	54.00	14.80	1.00 H	185	37.10	31.60	7.00	36.5	2.10
2	7236.00	57.26	PK	74.00	16.74	1.00 H	205	46.33	37.33	8.90	35.3	10.93
2	7236.00	37.58	AV	54.00	16.42	1.00 H	205	26.65	37.33	8.90	35.3	10.93

ANTENNA POLARITY & TEST DISTANCE: HORIZONTAL AT 3 M (802.11b--2437MHz)												
No.	Frequency (MHz)	Emission Level (dBuV/m)		Limit (dBuV/m)	Margin (dB)	Antenna Height (m)	Table Angle (Degree)	Raw Value (dBuV)	Antenna Factor (dB/m)	Cable Factor (dB)	Pre-amplifier	Correction Factor (dB/m)
1	4874.00	57.25	PK	74.00	16.75	1.00 H	95	55.13	31.02	7.60	36.5	2.12
1	4874.00	37.65	AV	54.00	16.35	1.00 H	95	35.53	31.02	7.60	36.5	2.12
2	7311.00	58.21	PK	74.00	15.79	1.00 H	115	47.13	37.28	8.60	34.8	11.08
2	7311.00	38.82	AV	54.00	15.18	1.00 H	115	27.74	37.28	8.60	34.8	11.08

ANTENNA POLARITY & TEST DISTANCE: VERTICAL AT 3 M (802.11b--2437MHz)												
No.	Frequency (MHz)	Emission Level (dBuV/m)		Limit (dBuV/m)	Margin (dB)	Antenna Height (m)	Table Angle (Degree)	Raw Value (dBuV)	Antenna Factor (dB/m)	Cable Factor (dB)	Pre-amplifier	Correction Factor (dB/m)
1	4874.00	58.21	PK	74.00	15.79	1.00 H	257	56.09	31.02	7.60	36.5	2.12
1	4874.00	40.20	AV	54.00	13.80	1.00 H	257	38.08	31.02	7.60	36.5	2.12
2	7311.00	56.78	PK	74.00	17.22	1.00 H	135	45.70	37.28	8.60	34.8	11.08
2	7311.00	37.09	AV	54.00	16.91	1.00 H	135	26.01	37.28	8.60	34.8	11.08

ANTENNA POLARITY & TEST DISTANCE: HORIZONTAL AT 3 M (802.11b--2462MHz)												
No.	Frequency (MHz)	Emission Level (dBuV/m)		Limit (dBuV/m)	Margin (dB)	Antenna Height (m)	Table Angle (Degree)	Raw Value (dBuV)	Antenna Factor (dB/m)	Cable Factor (dB)	Pre-amplifier	Correction Factor (dB/m)
1	4924.00	56.35	PK	74.00	17.65	1.00 H	125	53.97	31.58	7.00	36.2	2.38
1	4924.00	38.47	AV	54.00	15.53	1.00 H	125	36.09	31.58	7.00	36.2	2.38
2	7386.00	57.32	PK	74.00	16.68	1.00 H	95	45.61	38.51	8.50	35.3	11.71
2	7386.00	38.16	AV	54.00	15.84	1.00 H	95	26.45	38.51	8.50	35.3	11.71

ANTENNA POLARITY & TEST DISTANCE: VERTICAL AT 3 M (802.11b--2462MHz)												
No.	Frequency (MHz)	Emission Level (dBuV/m)		Limit (dBuV/m)	Margin (dB)	Antenna Height (m)	Table Angle (Degree)	Raw Value (dBuV)	Antenna Factor (dB/m)	Cable Factor (dB)	Pre-amplifier	Correction Factor (dB/m)
1	4924.00	57.12	PK	74.00	16.88	1.00 H	120	54.74	31.58	7.00	36.2	2.38
1	4924.00	39.30	AV	54.00	14.70	1.00 H	120	36.92	31.58	7.00	36.2	2.38
2	7386.00	53.78	PK	74.00	20.22	1.00 H	145	42.07	38.51	8.50	35.3	11.71
2	7386.00	34.36	AV	54.00	19.64	1.00 H	145	22.65	38.51	8.50	35.3	11.71

REMARKS: 1. Emission level (dBuV/m)=Raw Value(dBuV)+Correction Factor(dB/m)
 2. Correction Factor (dB/m) = Antenna Factor (dB/m)+Cable Factor (dB)-Pre-amplifier Factor

3. The other emission levels were very low against the limit.
4. Margin value = Limit value- Emission level.
5. For Wireless 802.11b mode at 1Mbps.

802.11g Mode(above 1GHz)

ANTENNA POLARITY & TEST DISTANCE: HORIZONTAL AT 3 M (802.11g--2412MHz)												
No.	Frequency (MHz)	Emission Level (dBuV/m)		Limit (dBuV/m)	Margin (dB)	Antenna Height (m)	Table Angle (Degree)	Raw Value (dBuV)	Antenna Factor (dB/m)	Cable Factor (dB)	Pre-amplifier	Correction Factor (dB/m)
1	4824.00	55.34	PK	74.00	18.66	1.00 H	136	53.24	31.6	7.00	36.5	2.10
1	4824.00	36.47	AV	54.00	17.53	1.00 H	136	34.37	31.6	7.00	36.5	2.10
2	7236.00	58.62	PK	74.00	25.38	1.00 H	125	47.69	37.33	8.90	35.3	10.93
2	7236.00	40.85	AV	54.00	14.15	1.00 H	125	38.92	37.33	8.90	35.3	10.93

ANTENNA POLARITY & TEST DISTANCE: VERTICAL AT 3 M (802.11g--2412MHz)												
No.	Frequency (MHz)	Emission Level (dBuV/m)		Limit (dBuV/m)	Margin (dB)	Antenna Height (m)	Table Angle (Degree)	Raw Value (dBuV)	Antenna Factor (dB/m)	Cable Factor (dB)	Pre-amplifier	Correction Factor (dB/m)
1	4824.00	56.75	PK	74.00	17.25	1.00 H	147	54.65	31.60	7.00	36.5	2.10
1	4824.00	37.69	AV	54.00	16.31	1.00 H	147	35.59	31.60	7.00	36.5	2.10
2	7236.00	59.62	PK	74.00	34.38	1.00 H	158	28.69	37.33	8.90	35.3	10.93
2	7236.00	40.44	AV	54.00	23.56	1.00 H	158	19.51	37.33	8.90	35.3	10.93

ANTENNA POLARITY & TEST DISTANCE: HORIZONTAL AT 3 M (802.11g--2437MHz)												
No.	Frequency (MHz)	Emission Level (dBuV/m)		Limit (dBuV/m)	Margin (dB)	Antenna Height (m)	Table Angle (Degree)	Raw Value (dBuV)	Antenna Factor (dB/m)	Cable Factor (dB)	Pre-amplifier	Correction Factor (dB/m)
1	4874.00	55.79	PK	74.00	18.21	1.00 H	130	53.67	31.02	7.60	36.5	2.12
1	4874.00	38.36	AV	54.00	15.64	1.00 H	130	36.24	31.02	7.60	36.5	2.12
2	7311.00	57.98	PK	74.00	16.02	1.00 H	185	46.90	37.28	8.60	34.8	11.08
2	7311.00	40.11	AV	54.00	13.89	1.00 H	185	29.03	37.28	8.60	34.8	11.08

ANTENNA POLARITY & TEST DISTANCE: VERTICAL AT 3 M (802.11g--2437MHz)												
No.	Frequency (MHz)	Emission Level (dBuV/m)		Limit (dBuV/m)	Margin (dB)	Antenna Height (m)	Table Angle (Degree)	Raw Value (dBuV)	Antenna Factor (dB/m)	Cable Factor (dB)	Pre-amplifier	Correction Factor (dB/m)
1	4874.00	57.62	PK	74.00	16.38	1.00 H	110	55.50	31.02	7.60	36.5	2.12
1	4874.00	39.78	AV	54.00	14.22	1.00 H	110	37.66	31.02	7.60	36.5	2.12
2	7311.00	59.02	PK	74.00	14.98	1.00 H	120	47.94	37.28	8.60	34.8	11.08
2	7311.00	40.36	AV	54.00	13.64	1.00 H	120	29.28	37.28	8.60	34.8	11.08

ANTENNA POLARITY & TEST DISTANCE: HORIZONTAL AT 3 M (802.11g--2462MHz)												
No.	Frequency (MHz)	Emission Level (dBuV/m)		Limit (dBuV/m)	Margin (dB)	Antenna Height (m)	Table Angle (Degree)	Raw Value (dBuV)	Antenna Factor (dB/m)	Cable Factor (dB)	Pre-amplifier	Correction Factor (dB/m)
1	4924.00	55.89	PK	74.00	18.11	1.00 H	150	53.51	31.58	7.00	36.2	2.38
1	4924.00	38.10	AV	54.00	15.90	1.00 H	150	35.72	31.58	7.00	36.2	2.38
2	7311.00	58.06	PK	74.00	15.94	1.00 H	174	46.35	38.51	8.50	35.3	11.71
2	7311.00	41.33	AV	54.00	12.67	1.00 H	174	29.62	38.51	8.50	35.3	11.71

ANTENNA POLARITY & TEST DISTANCE: VERTICAL AT 3 Mv (802.11g--2462MHz)												
No.	Frequency (MHz)	Emission Level (dBuV/m)		Limit (dBuV/m)	Margin (dB)	Antenna Height (m)	Table Angle (Degree)	Raw Value (dBuV)	Antenna Factor (dB/m)	Cable Factor (dB)	Pre-amplifier	Correction Factor (dB/m)
1	4924.00	57.58	PK	74.00	16.42	1.00 H	23	55.20	31.58	7.00	36.2	2.38
1	4924.00	39.68	AV	54.00	14.32	1.00 H	23	37.30	31.58	7.00	36.2	2.38
2	7386.00	58.15	PK	74.00	15.85	1.00 H	120	46.44	38.51	8.50	35.3	11.71
2	7386.00	40.65	AV	54.00	13.35	1.00 H	120	28.94	38.51	8.50	35.3	11.71

- REMARKS:**
1. Emission level (dBuV/m) =Raw Value (dBuV) + Correction Factor (dB/m)
 2. Correction Factor (dB/m) = Antenna Factor (dB/m)+Cable Factor (dB)-Pre-amplifier Factor
 3. The other emission levels were very low against the limit.
 4. Margin value = Limit value- Emission level.
 5. For Wireless 802.11g mode at 6Mbps.

802.11n(20MHz) Mode(above 1GHz)

ANTENNA POLARITY & TEST DISTANCE: HORIZONTAL AT 3 M (802.11n20--2412MHz)												
No.	Frequency (MHz)	Emission Level (dBuV/m)		Limit (dBuV/m)	Margin (dB)	Antenna Height (m)	Table Angle (Degree)	Raw Value (dBuV)	Antenna Factor (dB/m)	Cable Factor (dB)	Pre-amplifier	Correction Factor (dB/m)
1	4824.00	55.39	PK	74.00	18.61	1.00 H	165	53.29	31.60	7.00	36.5	2.10
1	4824.00	38.20	AV	54.00	15.80	1.00 H	165	36.10	31.60	7.00	36.5	2.10
2	7236.00	56.90	PK	74.00	17.10	1.00 H	255	45.97	37.33	8.90	35.3	10.93
2	7236.00	40.26	AV	54.00	13.74	1.00 H	255	29.33	37.33	8.90	35.3	10.93

ANTENNA POLARITY & TEST DISTANCE: VERTICAL AT 3 M (802.11n20--2412MHz)												
No.	Frequency (MHz)	Emission Level (dBuV/m)		Limit (dBuV/m)	Margin (dB)	Antenna Height (m)	Table Angle (Degree)	Raw Value (dBuV)	Antenna Factor (dB/m)	Cable Factor (dB)	Pre-amplifier	Correction Factor (dB/m)
1	4824.00	56.30	PK	74.00	17.70	1.00 H	115	54.20	31.60	7.00	36.5	2.10
1	4824.00	39.68	AV	54.00	14.32	1.00 H	115	37.58	31.60	7.00	36.5	2.10
2	7236.00	55.20	PK	74.00	18.80	1.00 H	135	44.27	37.33	8.90	35.3	10.93
2	7236.00	39.87	AV	54.00	14.13	1.00 H	135	28.94	37.33	8.90	35.3	10.93

ANTENNA POLARITY & TEST DISTANCE: HORIZONTAL AT 3 M (802.11n20--2437MHz)												
No.	Frequency (MHz)	Emission Level (dBuV/m)		Limit (dBuV/m)	Margin (dB)	Antenna Height (m)	Table Angle (Degree)	Raw Value (dBuV)	Antenna Factor (dB/m)	Cable Factor (dB)	Pre-amplifier	Correction Factor (dB/m)
1	4874.00	54.20	PK	74.00	19.80	1.00 H	155	52.08	31.02	7.60	36.5	2.12
1	4874.00	38.69	AV	54.00	15.31	1.00 H	155	36.57	31.02	7.60	36.5	2.12
2	7311.00	58.24	PK	74.00	15.76	1.00 H	122	47.16	37.28	8.60	34.8	11.08
2	7311.00	40.02	AV	54.00	13.98	1.00 H	122	28.94	37.28	8.60	34.8	11.08

ANTENNA POLARITY & TEST DISTANCE: VERTICAL AT 3 M (802.11n20--2437MHz)												
No.	Frequency (MHz)	Emission Level (dBuV/m)		Limit (dBuV/m)	Margin (dB)	Antenna Height (m)	Table Angle (Degree)	Raw Value (dBuV)	Antenna Factor (dB/m)	Cable Factor (dB)	Pre-amplifier	Correction Factor (dB/m)
1	4874.00	57.30	PK	74.00	16.70	1.00 H	180	55.18	31.02	7.60	36.5	2.12
1	4874.00	39.67	AV	54.00	14.33	1.00 H	180	37.55	31.02	7.60	36.5	2.12
2	7311.00	58.05	PK	74.00	15.95	1.00 H	135	46.97	37.28	8.60	34.8	11.08
2	7311.00	40.98	AV	54.00	13.02	1.00 H	135	29.90	37.28	8.60	34.8	11.08

ANTENNA POLARITY & TEST DISTANCE: HORIZONTAL AT 3 M (802.11n20--2462MHz)												
No.	Frequency (MHz)	Emission Level (dBuV/m)		Limit (dBuV/m)	Margin (dB)	Antenna Height (m)	Table Angle (Degree)	Raw Value (dBuV)	Antenna Factor (dB/m)	Cable Factor (dB)	Pre-amplifier	Correction Factor (dB/m)
1	4924.00	55.02	PK	74.00	18.98	1.00 H	122	52.64	31.58	7.00	36.2	2.38
1	4924.00	38.48	AV	54.00	15.52	1.00 H	122	36.10	31.58	7.00	36.2	2.38
2	7386.00	59.76	PK	74.00	14.24	1.00 H	120	48.05	38.51	8.50	35.3	11.71
2	7386.00	40.77	AV	54.00	13.23	1.00 H	120	29.06	38.51	8.50	35.3	11.71

ANTENNA POLARITY & TEST DISTANCE: VERTICAL AT 3 M (802.11n20--2462MHz)												
No.	Frequency (MHz)	Emission Level (dBuV/m)		Limit (dBuV/m)	Margin (dB)	Antenna Height (m)	Table Angle (Degree)	Raw Value (dBuV)	Antenna Factor (dB/m)	Cable Factor (dB)	Pre-amplifier	Correction Factor (dB/m)
1	4924.00	56.98	PK	74.00	17.02	1.00 H	174	54.60	31.58	7.00	36.2	2.38
1	4924.00	40.21	AV	54.00	13.79	1.00 H	174	37.83	31.58	7.00	36.2	2.38
2	7386.00	58.69	PK	74.00	15.31	1.00 H	180	46.98	38.51	8.50	35.3	11.71
2	7386.00	40.33	AV	54.00	13.67	1.00 H	180	28.62	38.51	8.50	35.3	11.71

- REMARKS:**
1. Emission level (dBuV/m) = Raw Value (dBuV) + Correction Factor (dB/m)
 2. Correction Factor (dB/m) = Antenna Factor (dB/m) + Cable Factor (dB) - Pre-amplifier Factor
 3. The other emission levels were very low against the limit.
 4. Margin value = Limit value - Emission level.
 5. For Wireless 802.11n (20MHz) mode at 6.5Mbps.

802.11n(40MHz) Mode(above 1GHz)

ANTENNA POLARITY & TEST DISTANCE: HORIZONTAL AT 3 M (802.11n40--2422MHz)												
No.	Frequency (MHz)	Emission Level (dBuV/m)		Limit (dBuV/m)	Margin (dB)	Antenna Height (m)	Table Angle (Degree)	Raw Value (dBuV)	Antenna Factor (dB/m)	Cable Factor (dB)	Pre-amplifier	Correction Factor (dB/m)
1	4844.00	54.32	PK	74.00	19.68	1.00 H	152	52.21	31.01	7.30	36.2	2.11
1	4844.00	39.64	AV	54.00	14.36	1.00 H	152	37.53	31.01	7.30	36.2	2.11
2	7266.00	57.05	PK	74.00	16.95	1.00 H	110	46.25	36.70	8.90	34.8	10.80
2	7266.00	40.23	AV	54.00	13.77	1.00 H	110	29.43	36.70	8.90	34.8	10.80

ANTENNA POLARITY & TEST DISTANCE: VERTICAL AT 3 M (802.11n40--2422MHz)												
No.	Frequency (MHz)	Emission Level (dBuV/m)		Limit (dBuV/m)	Margin (dB)	Antenna Height (m)	Table Angle (Degree)	Raw Value (dBuV)	Antenna Factor (dB/m)	Cable Factor (dB)	Pre-amplifier	Correction Factor (dB/m)
1	4844.00	55.20	PK	74.00	18.80	1.00 H	180	53.09	31.01	7.30	36.2	2.11
1	4844.00	41.98	AV	54.00	12.02	1.00 H	180	39.87	31.01	7.30	36.2	2.11
2	7266.00	58.74	PK	74.00	15.26	1.00 H	135	47.94	36.70	8.90	34.8	10.80
2	7266.00	40.88	AV	54.00	13.12	1.00 H	135	30.08	36.70	8.90	34.8	10.80

ANTENNA POLARITY & TEST DISTANCE: HORIZONTAL AT 3 M (802.11n40--2437MHz)												
No.	Frequency (MHz)	Emission Level (dBuV/m)		Limit (dBuV/m)	Margin (dB)	Antenna Height (m)	Table Angle (Degree)	Raw Value (dBuV)	Antenna Factor (dB/m)	Cable Factor (dB)	Pre-amplifier	Correction Factor (dB/m)
1	4874.00	54.03	PK	74.00	19.97	1.00 H	95	51.91	31.02	7.60	36.5	2.12
1	4874.00	40.98	AV	54.00	13.02	1.00 H	95	38.86	31.02	7.60	36.5	2.12
2	7311.00	58.69	PK	74.00	15.31	1.00 H	178	47.61	37.28	8.60	34.8	11.08
2	7311.00	40.24	AV	54.00	13.76	1.00 H	178	29.16	37.28	8.60	34.8	11.08

ANTENNA POLARITY & TEST DISTANCE: VERTICAL AT 3 M (802.11n40--2437MHz)												
No.	Frequency (MHz)	Emission Level (dBuV/m)		Limit (dBuV/m)	Margin (dB)	Antenna Height (m)	Table Angle (Degree)	Raw Value (dBuV)	Antenna Factor (dB/m)	Cable Factor (dB)	Pre-amplifier	Correction Factor (dB/m)
1	4874.00	54.23	PK	74.00	19.77	1.00 H	156	52.11	31.02	7.60	36.5	2.12
1	4874.00	41.20	AV	54.00	12.80	1.00 H	156	39.08	31.02	7.60	36.5	2.12
2	7311.00	58.69	PK	74.00	15.31	1.00 H	122	47.61	37.28	8.60	34.8	11.08
2	7311.00	40.16	AV	54.00	13.84	1.00 H	122	29.08	37.28	8.60	34.8	11.08

ANTENNA POLARITY & TEST DISTANCE: HORIZONTAL AT 3 M (802.11n40--2452MHz)												
No.	Frequency (MHz)	Emission Level (dBUV/m)		Limit (dBUV/m)	Margin (dB)	Antenna Height (m)	Table Angle (Degree)	Raw Value (dBUV)	Antenna Factor (dB/m)	Cable Factor (dB)	Pre-amplifier	Correction Factor (dB/m)
1	4904.00	54.01	PK	74.00	19.99	1.00 H	185	51.74	31.47	7.00	36.2	2.27
1	4904.00	39.68	AV	54.00	14.32	1.00 H	185	37.41	31.47	7.00	36.2	2.27
2	7356.00	58.38	PK	74.00	15.62	1.00 H	275	46.73	38.45	8.50	35.3	11.65
2	7356.00	40.44	AV	54.00	13.56	1.00 H	275	28.79	38.45	8.50	35.3	11.65

ANTENNA POLARITY & TEST DISTANCE: VERTICAL AT 3 M (802.11n40--2452MHz)												
No.	Frequency (MHz)	Emission Level (dBUV/m)		Limit (dBUV/m)	Margin (dB)	Antenna Height (m)	Table Angle (Degree)	Raw Value (dBUV)	Antenna Factor (dB/m)	Cable Factor (dB)	Pre-amplifier	Correction Factor (dB/m)
1	4904.00	55.20	PK	74.00	18.80	1.00 H	110	52.93	31.47	7.00	36.2	2.27
1	4904.00	40.96	AV	54.00	13.04	1.00 H	110	38.69	31.47	7.00	36.2	2.27
2	7356.00	58.94	PK	74.00	15.06	1.00 H	135	47.29	38.45	8.50	35.3	11.65
2	7356.00	40.13	AV	54.00	13.87	1.00 H	135	28.48	38.45	8.50	35.3	11.65

- REMARKS:**
1. Emission level (dBUV/m) = Raw Value (dBUV) + Correction Factor (dB/m)
 2. Correction Factor (dB/m) = Antenna Factor (dB/m) + Cable Factor (dB) - Pre-amplifier Factor
 3. The other emission levels were very low against the limit.
 4. Margin value = Limit value - Emission level.
 5. For Wireless 802.11n (40MHz) mode at 13.5Mbps.

4.3. Maximum Peak Output Power

TEST CONFIGURATION

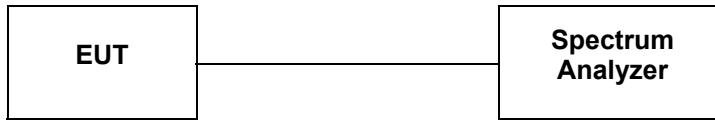

TEST PROCEDURE

The EUT was directly connected to the spectrum analyzer and antenna output port as show in the block diagram as TEST CONFIGURATION shows.

Accoding to KDB558074 D01 V03 Integrated band power method for this procedure may be used when the maximum available RBW of the measurement instrument is less than the DTS bandwidth.

1. Set the RBW = 1 MHz.
2. Set the VBW \geq 3 RBW
3. Set the span \geq 1.5 x DTS bandwidth.
4. Detector = peak.
5. Sweep time = auto couple.
6. Trace mode = max hold.
7. Allow trace to fully stabilize.
8. Use the instrument's band/channel power measurement function with the band limits set equal to the DTS bandwidth edges (for some instruments, this may require a manual override to select peak detector). If the instrument does not have a band power function, sum the spectrum levels (in linear power units) at intervals equal to the RBW extending across the DTS channel bandwidth.

LIMIT

The Maximum Peak Output Power Measurement is 30dBm.

TEST RESULTS

Remark:We measured output power at difference data rate for each mode and recorded woest case for each mode.

4.3.1 802.11b Test Mode

A. Test Verdict

Channel	Frequency (MHz)	Measured Output Peak Power (dBm)	Refer to Plot	Limits (dBm)	Verdict
1	2412	9.09	Plot 4.3.1 A	30	PASS
6	2437	9.68	Plot 4.3.1 B	30	PASS
11	2462	9.57	Plot 4.3.1 C	30	PASS

Note: 1. For 802.11b mode at final test to get the worst-case emission at 1Mbps.
2.The test results including the cable lose.

B. Test Plots

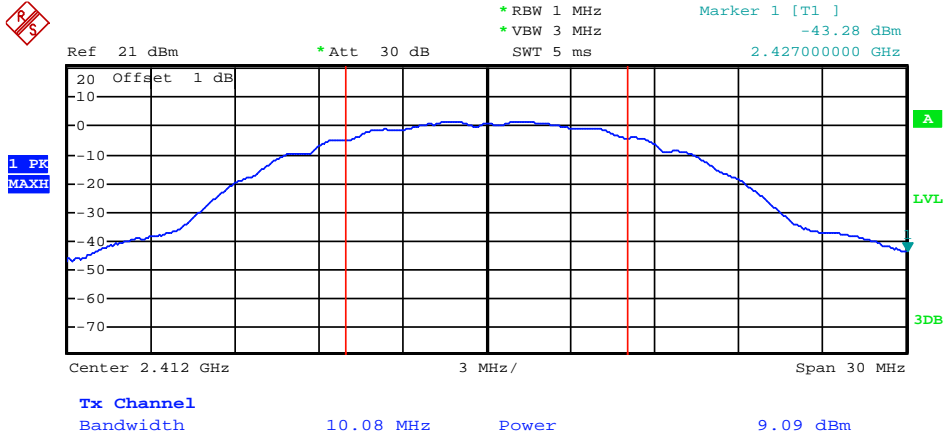

Date: 11.MAR.2014 11:02:33

(Plot 4.3.1 A: Channel 1: 2412MHz @ 802.11b)

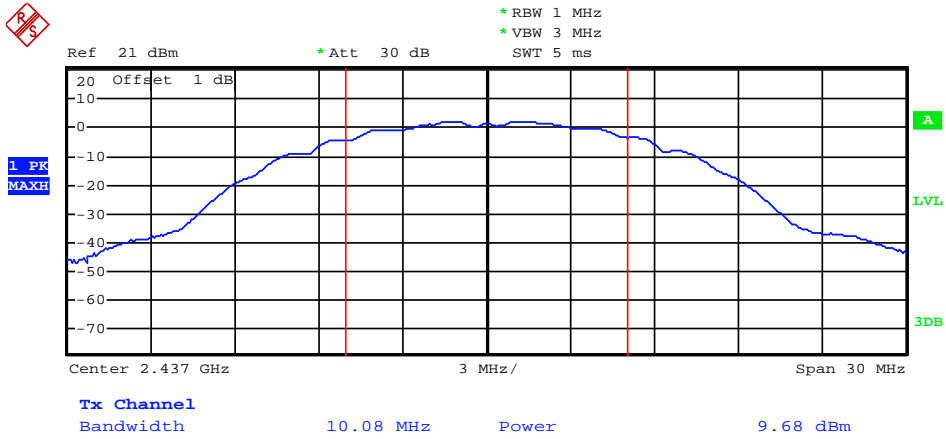

Date: 11.MAR.2014 11:03:35

(Plot 4.3.1 B: Channel 1: 2437MHz @ 802.11b)

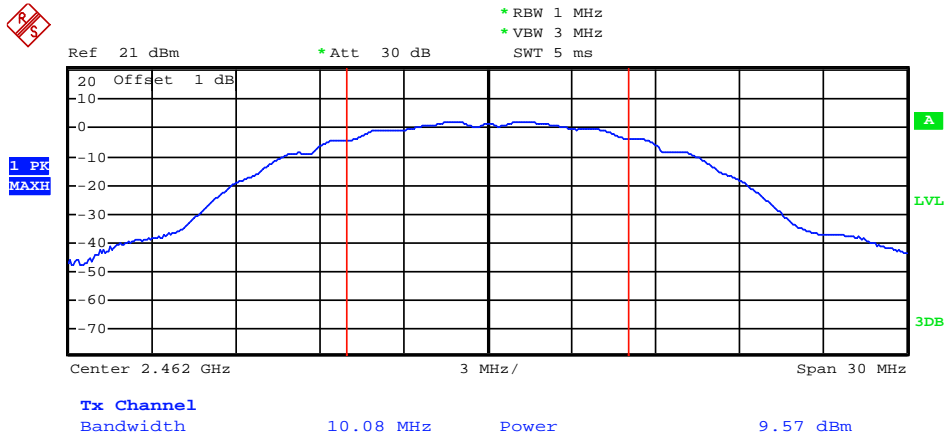

Date: 11.MAR.2014 11:04:12

(Plot 4.3.1 C: Channel 11: 2462MHz @ 802.11b)

4.3.2 802.11g Test Mode

A. Test Verdict

Channel	Frequency (MHz)	Measured Output Peak Power (dBm)	Refer to Plot	Limits (dBm)	Verdict
1	2412	8.56	Plot 4.3.2 A	30	PASS
6	2437	8.78	Plot 4.3.2 B	30	PASS
11	2462	8.81	Plot 4.3.2 C	30	PASS

Note: 1. For 802.11g mode at final test to get the worst-case emission at 6Mbps.
 2. The test results including the cable lose.

B. Test Plots

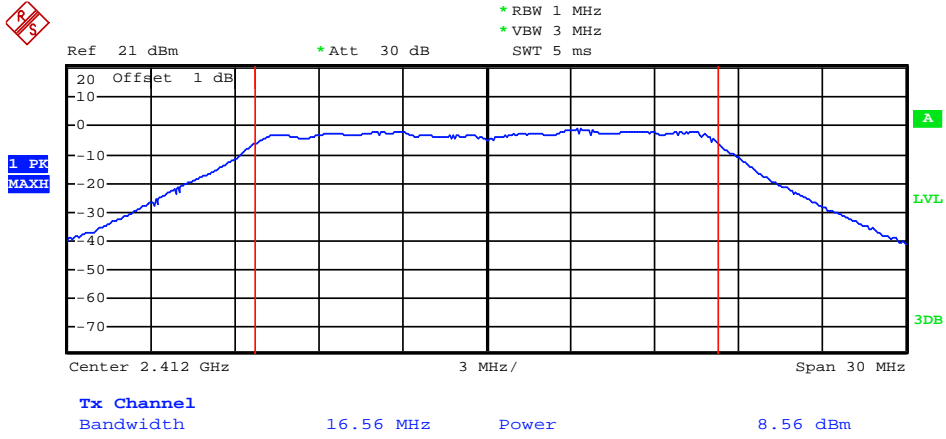

Date: 11.MAR.2014 11:05:24

(Plot 4.3.2 A: Channel 1: 2412MHz @ 802.11g)

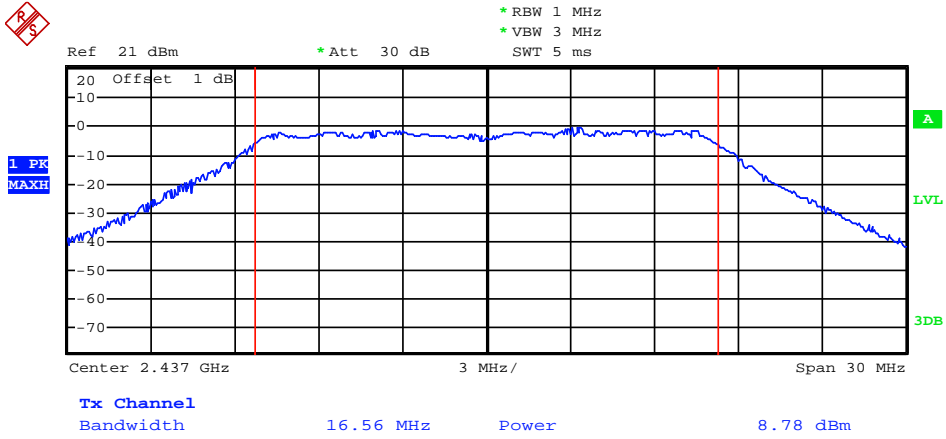

Date: 11.MAR.2014 11:05:53

(Plot 4.3.2 B: Channel 1: 2437MHz @ 802.11g)

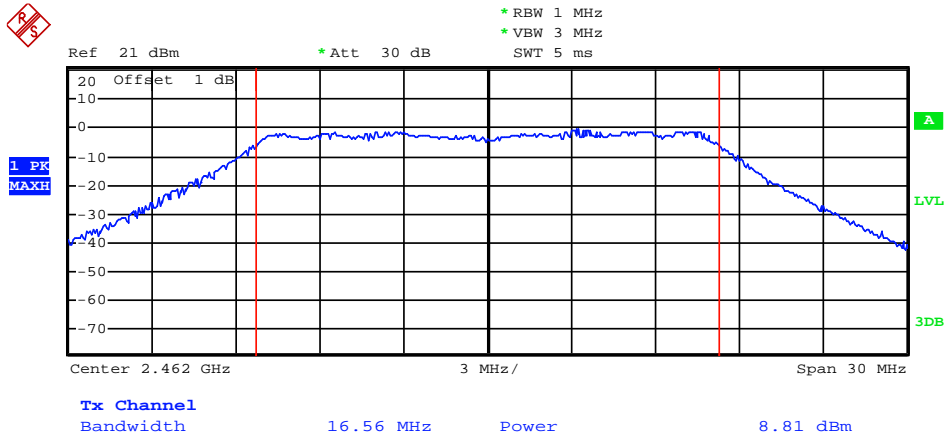

Date: 11.MAR.2014 11:06:40

(Plot 4.3.2 C: Channel 11: 2462MHz @ 802.11g)

4.3.3 802.11n(20MHz) Test Mode

A. Test Verdict

Channel	Frequency (MHz)	Measured Output Peak Power (dBm)	Refer to Plot	Limits (dBm)	Verdict
1	2412	8.30	Plot 4.3.3 A	30	PASS
6	2437	8.67	Plot 4.3.3 B	30	PASS
11	2462	8.80	Plot 4.3.3 C	30	PASS

Note: 1. For 802.11n(20MHz) mode at final test to get the worst-case emission at 6.5Mbps.
 2. The test results including the cable lose.

B. Test Plots

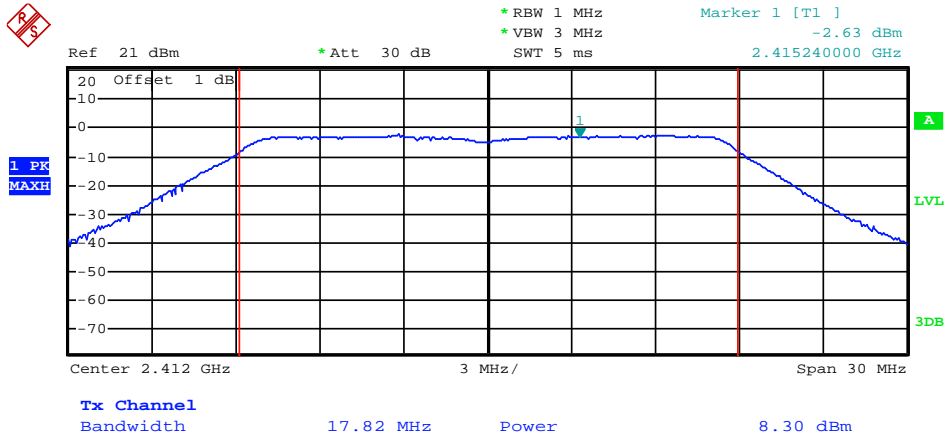

Date: 11.MAR.2014 11:07:55

(Plot 4.3.3 A: Channel 1: 2412MHz @ 802.11n(20MHz))

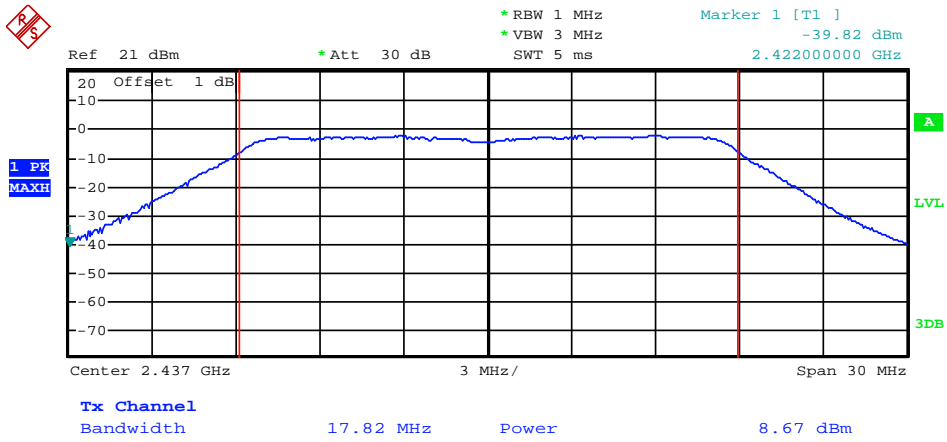

Date: 11.MAR.2014 11:08:19

(Plot 4.3.3 B: Channel 6: 2437MHz @ 802.11n(20MHz))

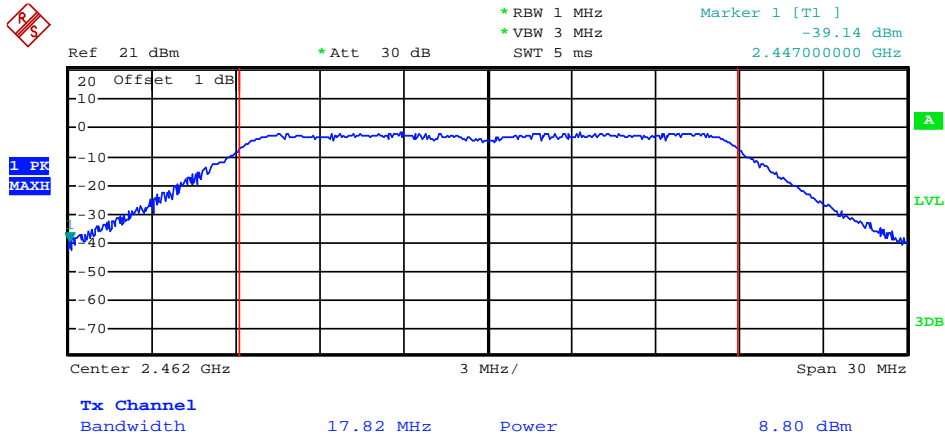

Date: 11.MAR.2014 11:08:45

(Plot 4.3.3 C: Channel 11: 2462MHz @ 802.11n(20MHz)

4.3.4 802.11n(40MHz) Test Mode

A. Test Verdict

Channel	Frequency (MHz)	Measured Output Peak Power (dBm)	Refer to Plot	Limits (dBm)	Verdict
3	2422	8.03	Plot 4.3.3 A	30	PASS
6	2437	7.95	Plot 4.3.3 B	30	PASS
9	2452	8.05	Plot 4.3.3 C	30	PASS

Note: 1. For 802.11n(20MHz) mode at final test to get the worst-case emission at 13.5Mbps.
 2. The test results including the cable lose.

B. Test Plots

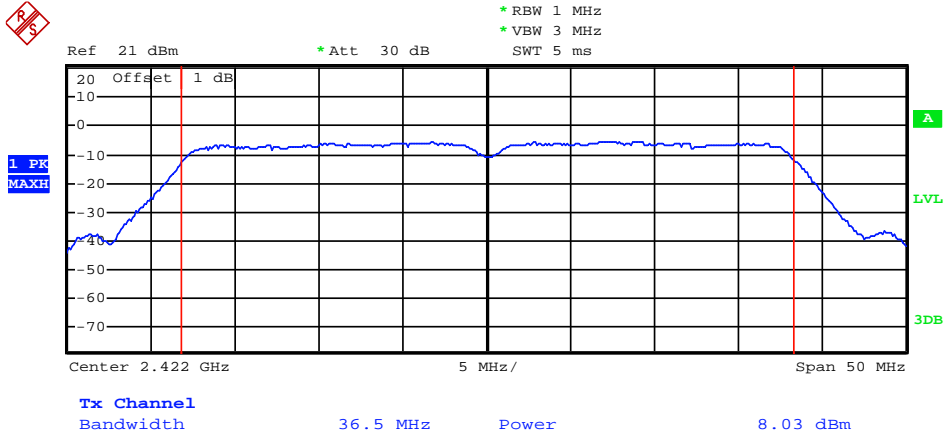

Date: 11.MAR.2014 10:57:32

(Plot 4.3.4 A: Channel 3: 2422MHz @ 802.11n(40MHz))

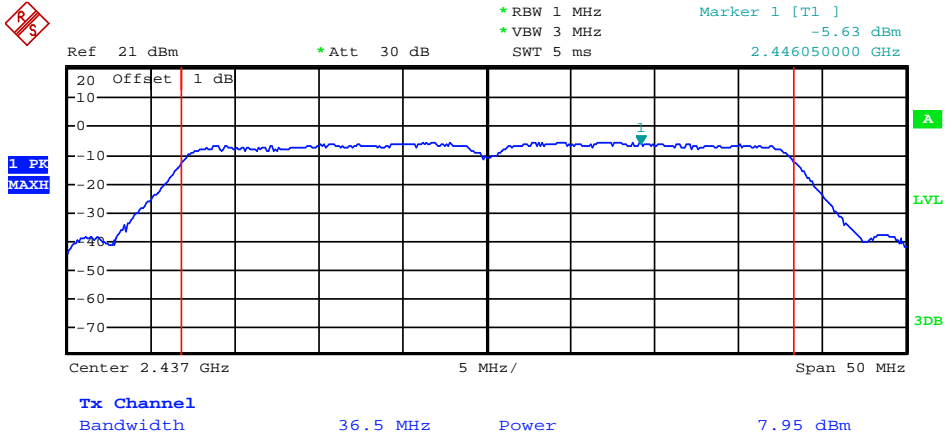

Date: 11.MAR.2014 10:56:22

(Plot 4.3.4 B: Channel 6: 2437MHz @ 802.11n(40MHz))

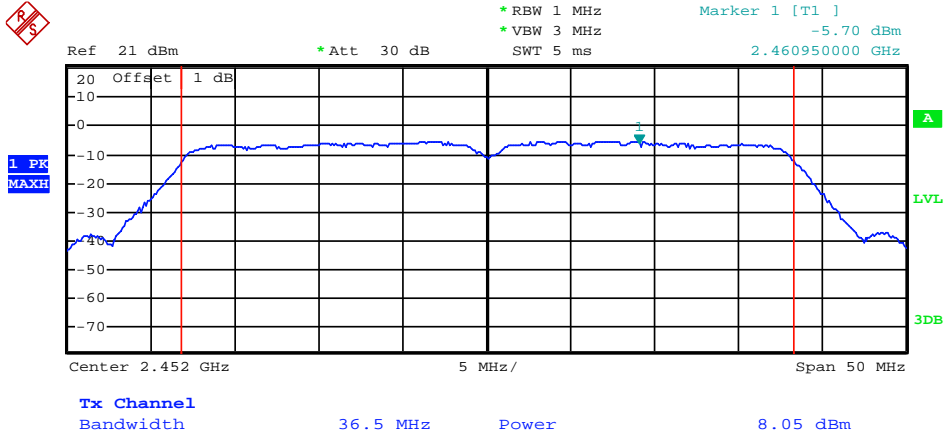

Date: 11.MAR.2014 10:55:29

(Plot 4.3.4 C: Channel 9: 2452MHz @ 802.11n(40MHz))

4.4. Power Spectral Density

TEST CONFIGURATION

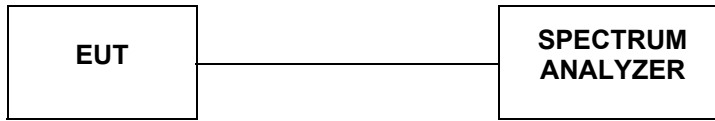

TEST PROCEDURE

According to KDB 558074 D01 V03 Method PKPSD (peak PSD) This procedure shall be used if maximum peak conducted output power was used to demonstrate compliance, and is optional if the maximum conducted (average) output power was used to demonstrate compliance.

1. Set analyzer center frequency to DTS channel center frequency.
2. Set the span to 1.5 times the DTS bandwidth.
3. Set the RBW to: $3 \text{ kHz} \leq \text{RBW} \leq 100 \text{ kHz}$.
4. Set the VBW $\geq 3 \text{ RBW}$.
5. Detector = peak.
6. Sweep time = auto couple.
7. Trace mode = max hold.
8. Allow trace to fully stabilize.
9. Use the peak marker function to determine the maximum amplitude level within the RBW.
10. If measured value exceeds limit, reduce RBW (no less than 3 kHz) and repeat.

LIMIT

For digitally modulated systems, the power spectral density conducted from the intentional radiator to the antenna shall not be greater than 8 dBm in any 3 kHz band during any time interval of continuous transmission.

TEST RESULTS

4.4.1 802.11b Test Mode

A. Test Verdict

Channel	Frequency (MHz)	Report PSD (dBm/3kHz)	Refer to Plot	Limits (dBm/3KHz)	Verdict
1	2412	-25.21	Plot 4.4.1 A	8	PASS
6	2437	-24.33	Plot 4.4.1 B	8	PASS
11	2462	-23.83	Plot 4.4.1 C	8	PASS

- Note: 1. For 802.11b mode at final test to get the worst-case emission at 1Mbps.
 2. The test results including the cable loss.

B. Test Plots



*RBW 3 kHz Marker 1 [T1]
*VBW 10 kHz -25.21 dBm
SWT 1.7 s 2.412771120 GHz

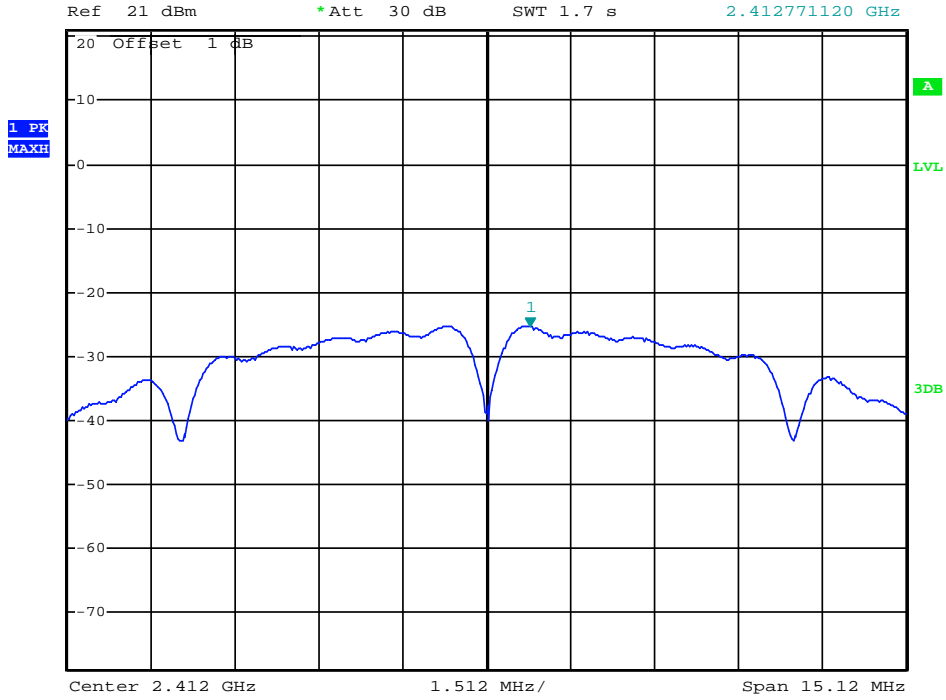

Date: 11.MAR.2014 11:10:13

(Plot 4.4.1 A: Channel 1: 2412MHz @ 802.11b)



*RBW 3 kHz Marker 1 [T1]
*VBW 10 kHz -24.33 dBm
SWT 1.7 s 2.437740880 GHz

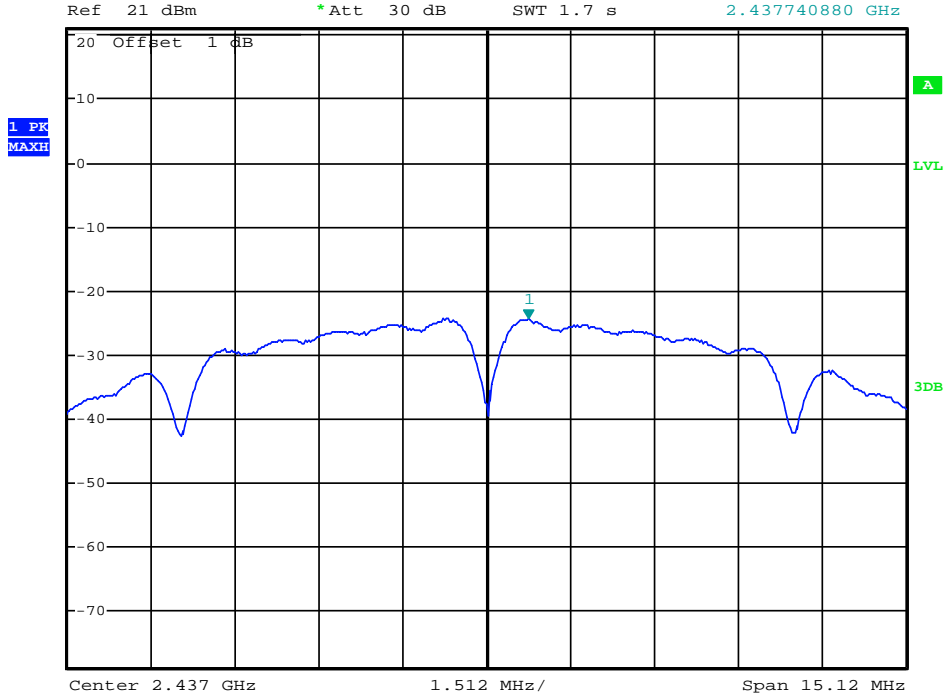

Date: 11.MAR.2014 11:10:41

(Plot 4.4.1 B: Channel 6: 2437MHz @ 802.11b)



*RBW 3 kHz Marker 1 [T1]
 *VBW 10 kHz -23.83 dBm
 Ref 21 dBm *Att 30 dB SWI 1.7 s 2.461274240 GHz

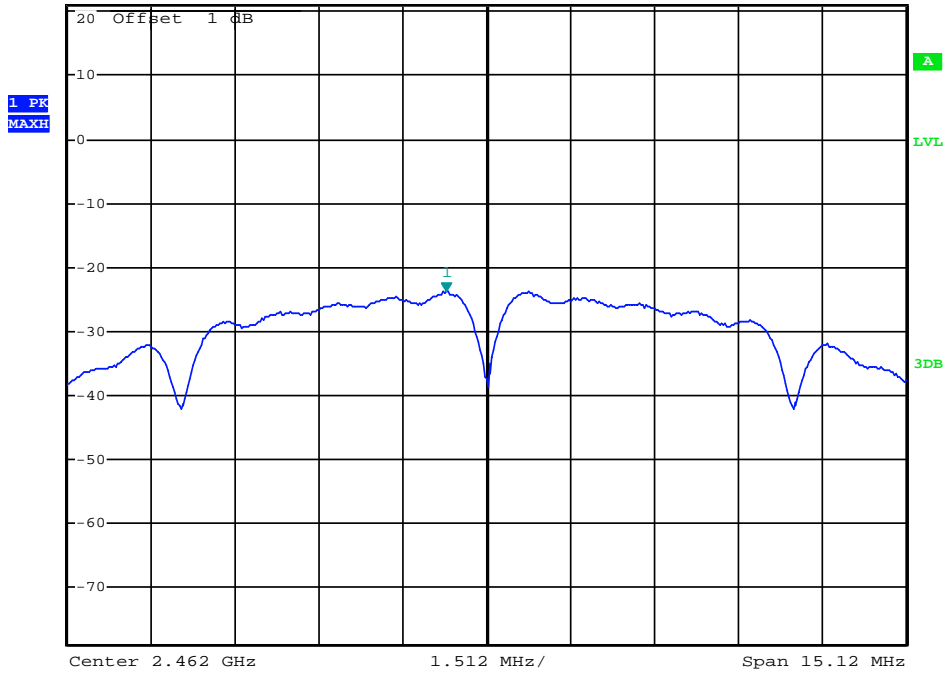

Date: 11.MAR.2014 11:11:06

(Plot 4.4.1 C: Channel 11: 2462MHz @ 802.11b)

4.4.2 802.11g Test Mode

A. Test Verdict

Channel	Frequency (MHz)	Report PSD (dBm/3kHz)	Refer to Plot	Limits (dBm/3KHz)	Verdict
1	2412	-27.00	Plot 4.4.2 A	8	PASS
6	2437	-26.33	Plot 4.4.2 B	8	PASS
11	2462	-26.00	Plot 4.4.2 C	8	PASS

Note: 1. For 802.11g mode at final test to get the worst-case emission at 6Mbps.
 2. The test results including the cable lose.

B. Test Plots



*RBW 3 kHz Marker 1 [T1]
*VBW 10 kHz -27.00 dBm
SWT 2.8 s 2.415154680 GHz

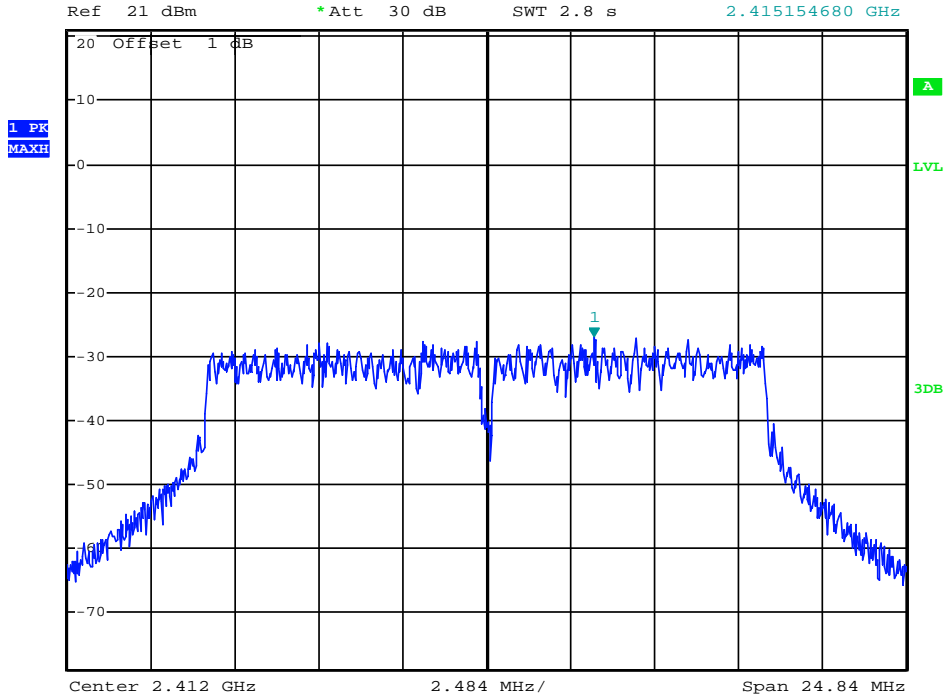

Date: 11.MAR.2014 11:12:21

(Plot 4.4.2 A: Channel 1: 2412MHz @ 802.11g)



*RBW 3 kHz Marker 1 [T1]
*VBW 10 kHz -26.33 dBm
SWT 2.8 s 2.440154680 GHz

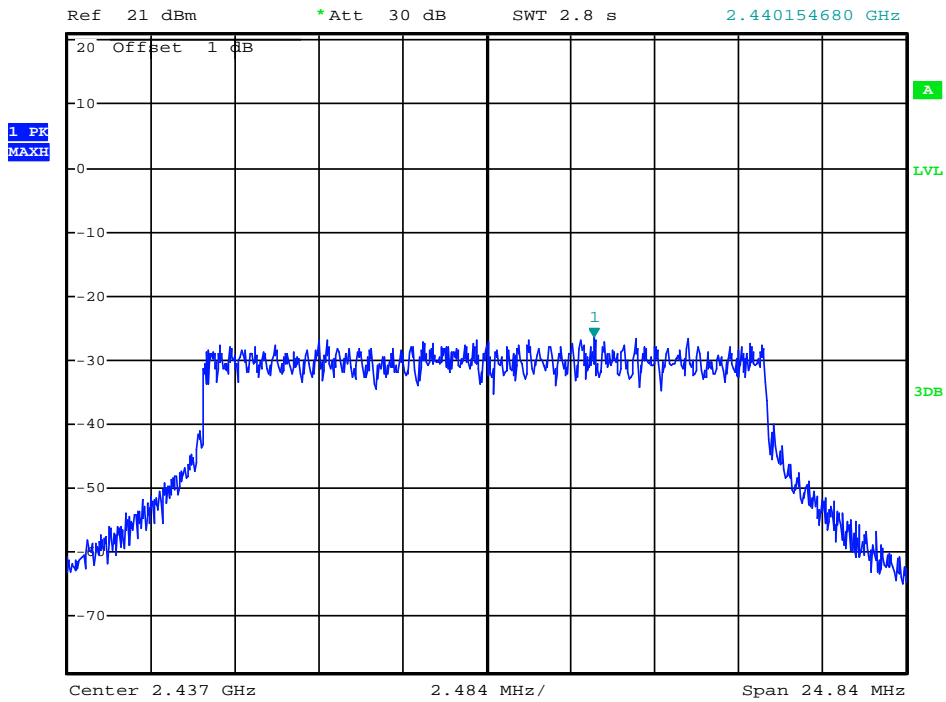

Date: 11.MAR.2014 11:13:04

(Plot 4.4.2 B: Channel 6: 2437MHz @ 802.11g)



*RBW 3 kHz Marker 1 [T1]
 *VBW 10 kHz -26.00 dBm
 Ref 21 dBm *Att 30 dB SWI 2.8 s 2.467961600 GHz

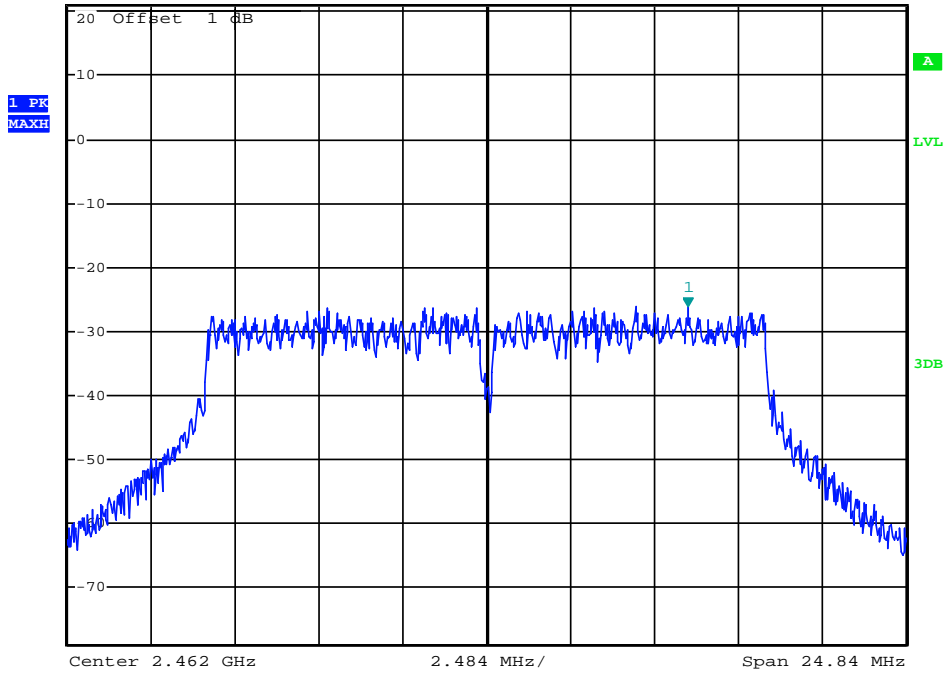

Date: 11.MAR.2014 11:13:31

(Plot 4.4.2 C: Channel 11: 2462MHz @ 802.11g)

4.4.3 802.11n(20MHz) Test Mode

A. Test Verdict

Channel	Frequency (MHz)	Report PSD (dBm/3kHz)	Refer to Plot	Limits (dBm/3KHz)	Verdict
1	2412	-28.82	Plot 4.4.3 A	8	PASS
6	2437	-27.87	Plot 4.4.3 B	8	PASS
11	2462	-27.47	Plot 4.4.3 C	8	PASS

Note: 1. For 802.11n(20MHz) mode at final test to get the worst-case emission at 6.5Mbps.
 2. The test results including the cable loss.

B. Test Plots



*RBW 3 kHz Marker 1 [T1]
*VBW 10 kHz -28.82 dBm
SWT 3 s 2.405370960 GHz

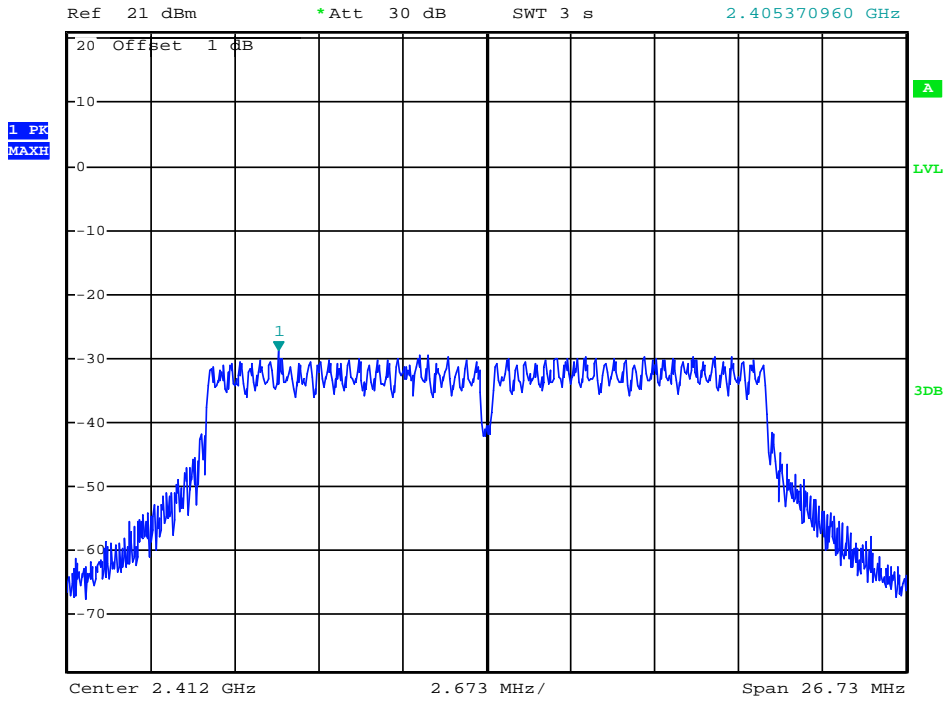

Date: 11.MAR.2014 11:14:32

(Plot 4.4.3 A: Channel 1: 2412MHz @ 802.11n(20MHz))



*RBW 3 kHz Marker 1 [T1]
*VBW 10 kHz -27.87 dBm
SWT 3 s 2.430424420 GHz

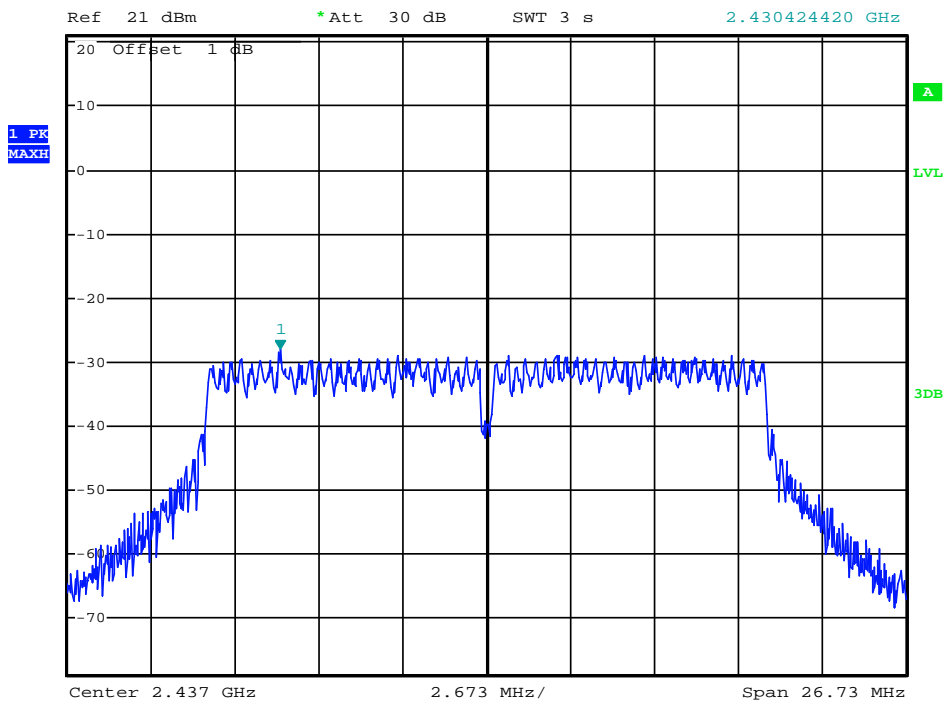

Date: 11.MAR.2014 11:14:55

(Plot 4.4.3 B: Channel 6: 2437MHz @ 802.11n(20MHz))



*RBW 3 kHz Marker 1 [T1]
 *VBW 10 kHz -27.47 dBm
 Ref 21 dBm *Att 30 dB SWT 3 s 2.455370960 GHz

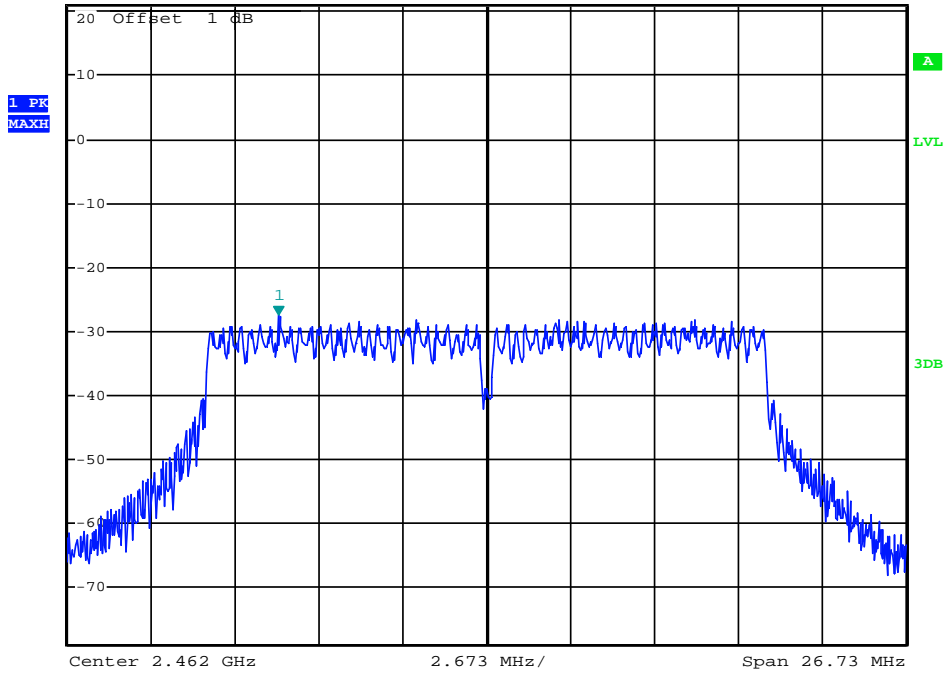

Date: 11.MAR.2014 11:15:18

(Plot 4.4.3 C: Channel 11: 2462MHz @ 802.11n(20MHz))

4.4.4 802.11n(40MHz) Test Mode

A. Test Verdict

Channel	Frequency (MHz)	Report PSD (dBm/3kHz)	Refer to Plot	Limits (dBm/3KHz)	Verdict
3	2422	-30.01	Plot 4.4.3 A	8	PASS
6	2437	-31.35	Plot 4.4.3 B	8	PASS
9	2452	-30.74	Plot 4.4.3 C	8	PASS

Note: 1. For 802.11n(40MHz) mode at final test to get the worst-case emission at 13.5Mbps.
 2. The test results including the cable lose.

B. Test Plots



*RBW 3 kHz Marker 1 [T1]
*VBW 10 kHz -30.01 dBm
SWT 6.2 s 2.418550750 GHz

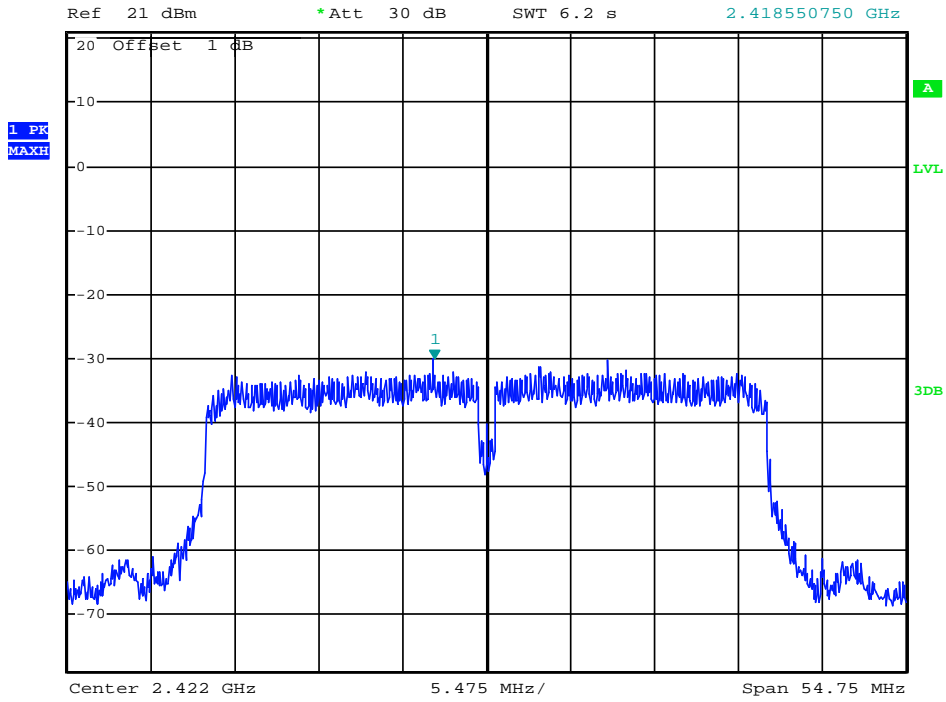

Date: 11.MAR.2014 11:16:02

(Plot 4.4.4 A: Channel 3: 2422MHz @ 802.11n(40MHz))



*RBW 3 kHz Marker 1 [T1]
*VBW 10 kHz -31.35 dBm
SWT 6.2 s 2.439792250 GHz

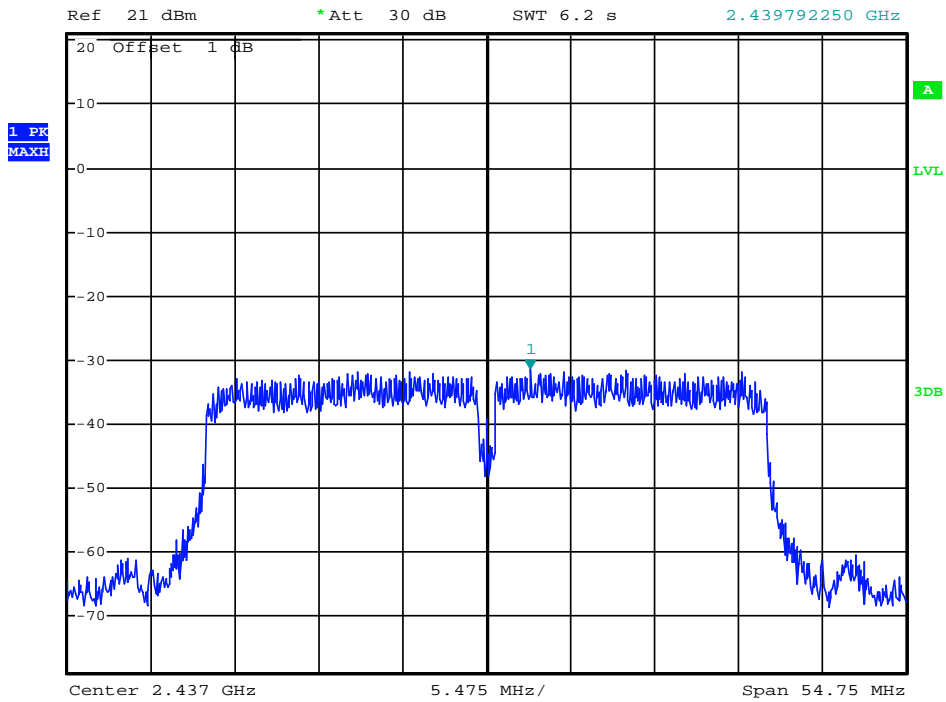

Date: 11.MAR.2014 11:16:27

(Plot 4.4.4 B: Channel 6: 2437MHz @ 802.11n(40MHz))



*RBW 3 kHz Marker 1 [T1]
*VBW 10 kHz -30.74 dBm
SWT 6.2 s 2.444225500 GHz

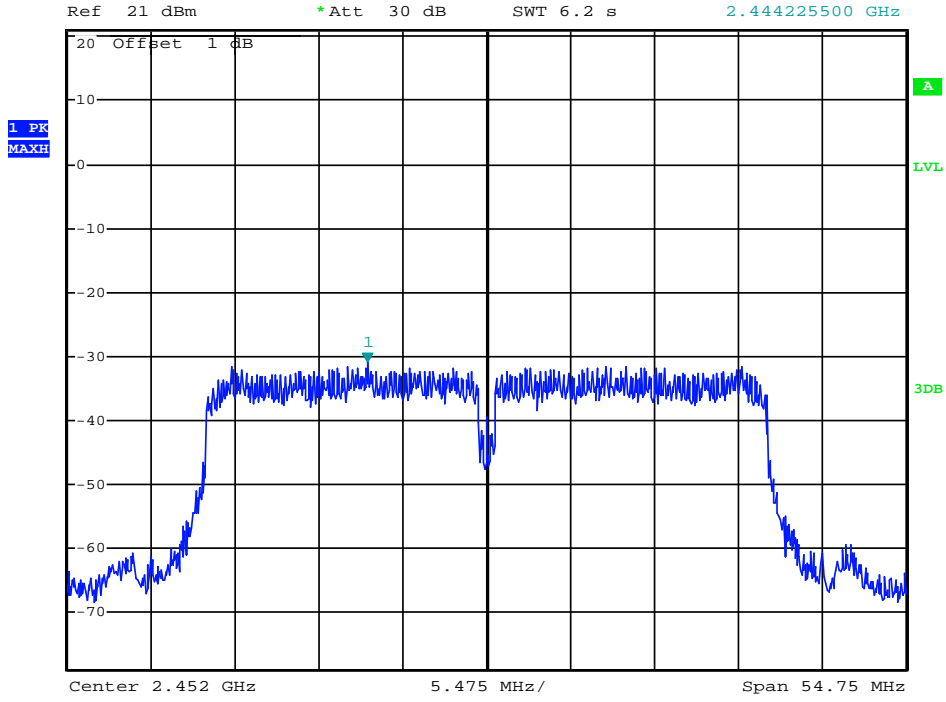

Date: 11.MAR.2014 11:16:53

(Plot 4.4.4 C: Channel 9: 2452MHz @ 802.11n(40MHz))

4.5. Band Edge Compliance of RF Emission

TEST REQUIREMENT

In any 100 kHz bandwidth outside the frequency band in which the spread spectrum or digitally modulated intentional radiator is operating, the radio frequency power that is produced by the intentional radiator shall be at least 20 dB below that in the 100 kHz bandwidth within the band that contains the highest level of the desired power, based on either an RF conducted or a radiated measurement, provided the transmitter demonstrates compliance with the peak conducted power limits. If the transmitter complies with the conducted power limits based on the use of RMS averaging over a time interval, as permitted under paragraph (b)(3) of this section, the attenuation required under this paragraph shall be 30 dB instead of 20 dB. Attenuation below the general limits specified in §15.209(a) is not required. In addition, radiated emissions which fall in the restricted bands, as defined in §15.205(a), must also comply with the radiated emission limits specified in §15.209(a) (see §15.205(c)).

TEST PROCEDURE

According to KDB 558074 D01 V03 for Antenna-port conducted measurement. Antenna-port conducted measurements may also be used as an alternative to radiated measurements for demonstrating compliance in the restricted frequency bands. If conducted measurements are performed, then proper impedance matching must be ensured and an additional radiated test for cabinet/case spurious emissions is required.

1. Check the calibration of the measuring instrument using either an internal calibrator or a known signal from an external generator.
2. Remove the antenna from the EUT and then connect to a low loss RF cable from the antenna port to a EMI test receiver, then turn on the EUT and make it operate in transmitting mode. Then set it to Low Channel and High Channel within its operating range, and make sure the instrument is operated in its linear range.
3. Set both RBW and VBW of spectrum analyzer to 100 kHz with a convenient frequency span including 100kHz bandwidth from band edge, for Radiated emissions restricted band RBW=1MHz, VBW=3MHz for peak detector and RBW=1MHz, VBW=10Hz for average detector.
4. Measure the highest amplitude appearing on spectral display and set it as a reference level. Plot the graph with marking the highest point and edge frequency.
5. Repeat above procedures until all measured frequencies were complete.
6. Measure the conducted output power (in dBm) using the detector specified by the appropriate regulatory agency (see 12.2.2, 12.2.3, and 12.2.4 for guidance regarding measurement procedures for determining quasi-peak, peak, and average conducted output power, respectively).
7. Add the maximum transmit antenna gain (in dBi) to the measured output power level to determine the EIRP level (see 12.2.5 for guidance on determining the applicable antenna gain)
8. Add the appropriate maximum ground reflection factor to the EIRP level (6 dB for frequencies \leq 30 MHz, 4.7 dB for frequencies between 30 MHz and 1000 MHz, inclusive and 0 dB for frequencies $>$ 1000 MHz).
9. For devices with multiple antenna-ports, measure the power of each individual chain and sum the EIRP of all chains in linear terms (e.g., Watts, mW).
10. Convert the resultant EIRP level to an equivalent electric field strength using the following relationship:
$$E = \text{EIRP} - 20\log D + 104.8$$

where:

E = electric field strength in dB μ V/m,

EIRP = equivalent isotropic radiated power in dBm

D = specified measurement distance in meters.

11. Since the out-of-band characteristics of the EUT transmit antenna will often be unknown, the use of a conservative antenna gain value is necessary. Thus, when determining the EIRP based on the measured conducted power, the upper bound on antenna gain for a device with a single RF output shall be selected as the maximum in-band gain of the antenna across all operating bands, or 2 dBi, whichever is greater. However, for devices that operate in multiple frequency bands while using the same transmit antenna, the highest gain of the antenna within the operating band nearest in frequency to the restricted band emission being measured may be used in lieu of the overall highest gain when the emission is at a frequency that is within 20 percent of the nearest band edge frequency, but in no case shall a value less than 2 dBi be used.
12. Compare the resultant electric field strength level to the applicable regulatory limit.

LIMIT

Below -20dB of the highest emission level in operating band.

Radiated emissions which fall in the restricted bands, as defined in § 15.205(a), must also comply with the radiated emission limits specified in § 15.209(a)

TEST RESULTS

Remark: The Bandedge was measured at difference data rate for each mode and recorded worst case for each mode.

4.5.1 802.11b Test Mode

A. Test Verdict

Frequency (MHz)	Conducted Power (dBm)	Antenna Gain (dBi)	Ground Reflection Factor (dB)	Covert Radiated E Level At 3m (dBuV/m)	Detector	Limit (dBuV/m)	Refer to Plot
2390.00	-49.44	2.00	0.00	47.82	Peak	74.00	Plot 4.5.1 A1
2390.00	-59.98	2.00	0.00	37.28	AV	54.00	Plot 4.5.1 A2
2413.12	4.41	2.00	0.00	101.67	Peak	---	Plot 4.5.1 A1
2411.28	-0.14	2.00	0.00	97.12	AV	---	Plot 4.5.1 A2
2463.04	5.63	2.00	0.00	102.89	Peak	---	Plot 4.5.1 A3
2461.28	1.07	2.00	0.00	98.33	AV	---	Plot 4.5.1 A4
2483.50	-48.61	2.00	0.00	48.65	Peak	74.00	Plot 4.5.1 A3
2483.50	-58.54	2.00	0.00	38.72	AV	54.00	Plot 4.5.1 A4

- Note:
1. For 802.11b mode at final test to get the worst-case emission at 1Mbps.
 2. The test results including the cable lose.
 3. "—" means that the fundamental frequency not for 15.209 limits requirement.

B. Test Plots

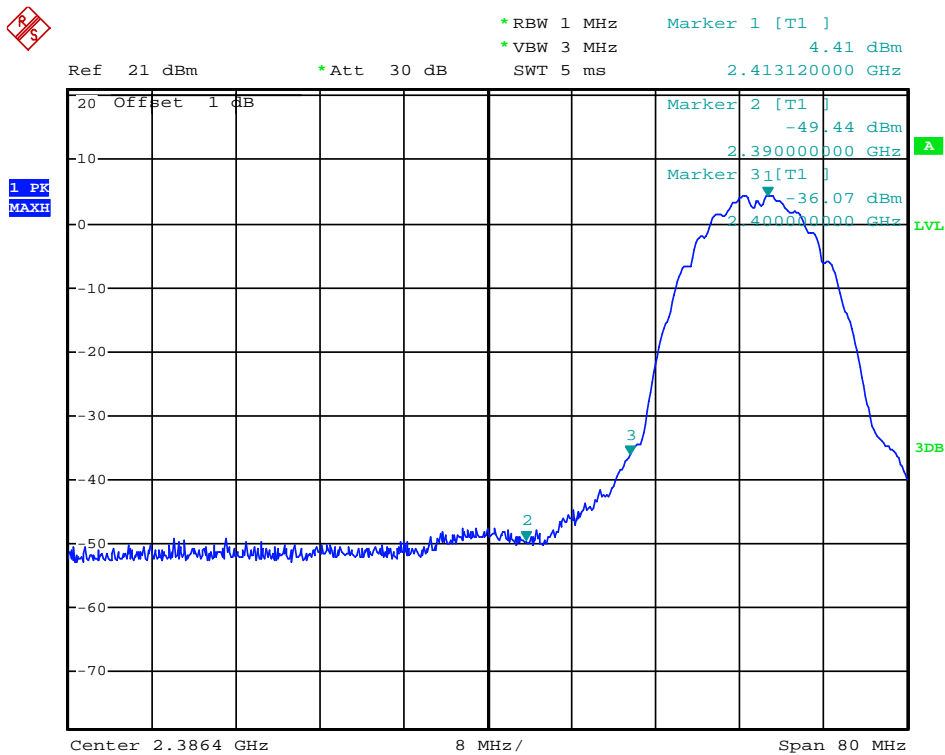

Date: 11.MAR.2014 13:23:52

(Plot 4.5.1 A1: Channel 1: 2412MHz @ 802.11b)

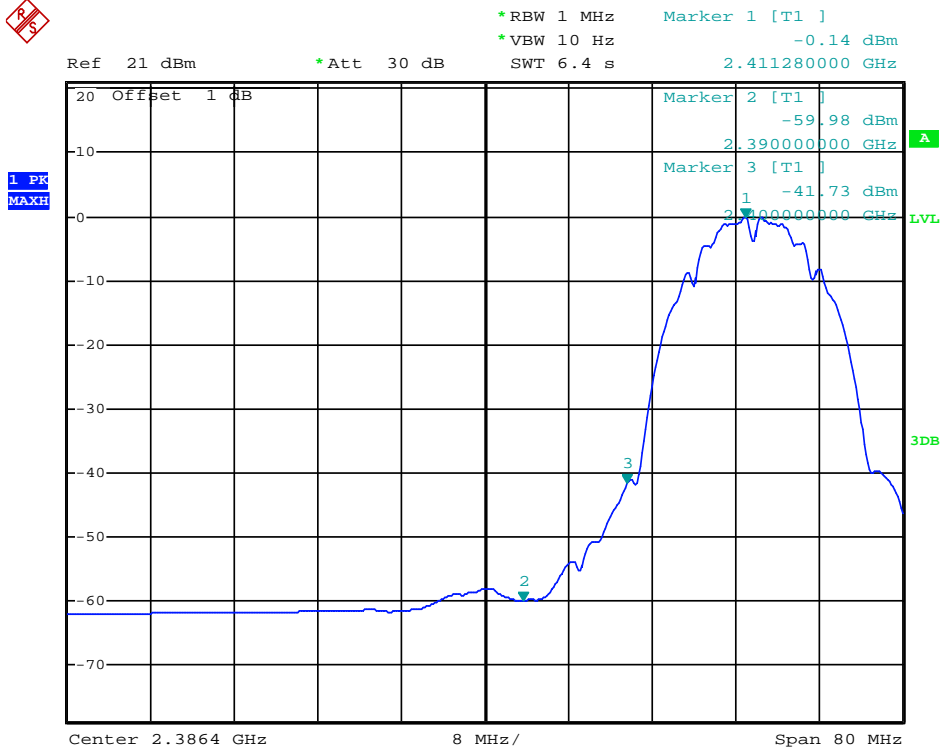

Date: 11.MAR.2014 13:24:15

(Plot 4.5.1 A2: Channel 1: 2412MHz @ 802.11b)

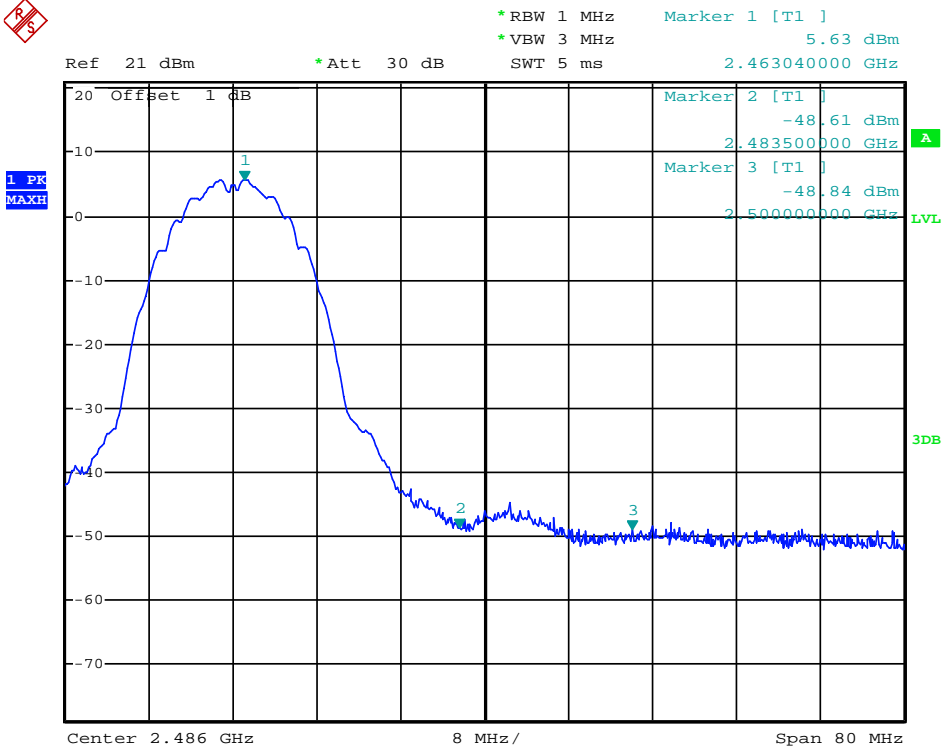

Date: 11.MAR.2014 13:32:50

(Plot 4.5.1 A3: Channel 11: 2462MHz @ 802.11b)

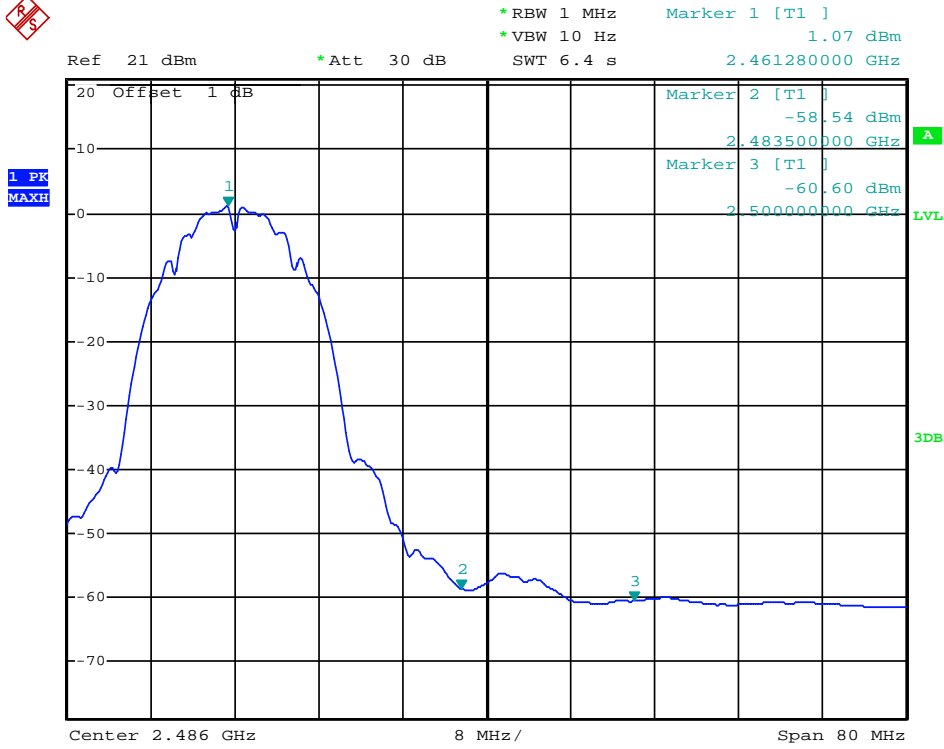

Date: 11.MAR.2014 13:33:13

(Plot 4.5.1 A4: Channel 11: 2462MHz @ 802.11b)

4.5.2 802.11g Test Mode

A. Test Verdict

Frequency (MHz)	Conducted Power (dBm)	Antenna Gain (dBi)	Ground Reflection Factor (dB)	Covert Radiated E Level At 3m (dBuV/m)	Detector	Limit (dBuV/m)	Refer to Plot
2390.00	-46.68	2.00	0.00	50.58	Peak	74.00	Plot 4.5.2 A1
2390.00	-60.07	2.00	0.00	37.19	AV	54.00	Plot 4.5.2 A2
2415.20	2.91	2.00	0.00	100.17	Peak	---	Plot 4.5.2 A1
2415.44	-8.70	2.00	0.00	88.56	AV	---	Plot 4.5.2 A2
2465.12	3.24	2.00	0.00	100.50	Peak	---	Plot 4.5.2 A3
2453.60	-8.44	2.00	0.00	88.82	AV	---	Plot 4.5.2 A4
2483.50	-47.19	2.00	0.00	50.07	Peak	74.00	Plot 4.5.2 A3
2483.50	-59.39	2.00	0.00	37.87	AV	54.00	Plot 4.5.2 A4

Note: 1. For 802.11g mode at final test to get the worst-case emission at 6Mbps.
 2. The test results including the cable lose.
 3. “---” means that the fundamental frequency not for 15.209 limits requirement.

B. Test Plots

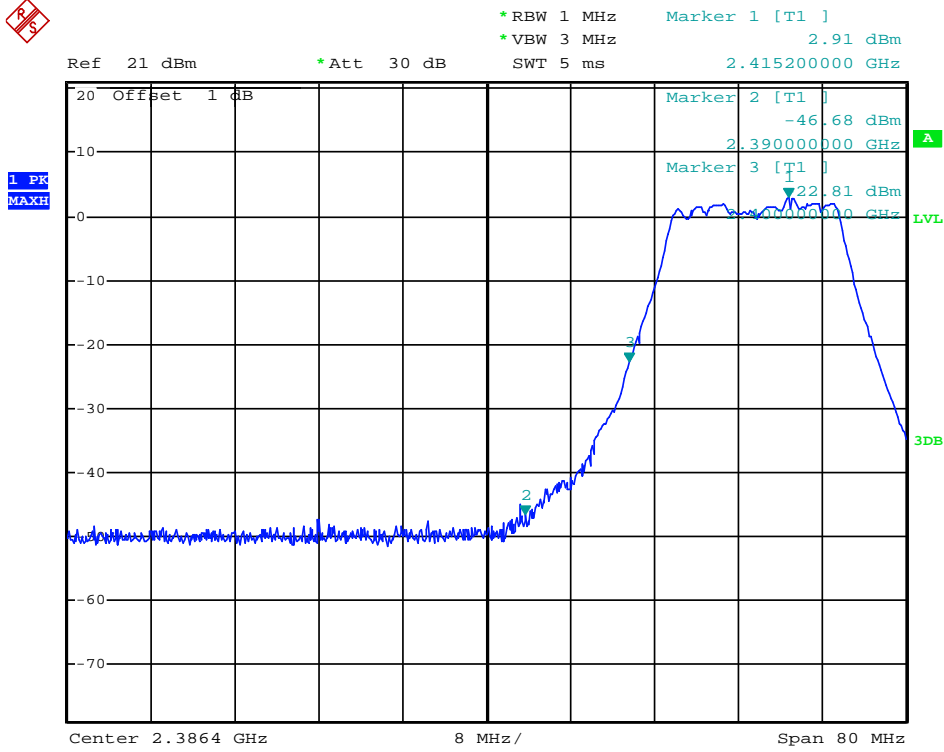

Date: 11.MAR.2014 13:26:51

(Plot 4.5.2 A1: Channel 1: 2412MHz @ 802.11g)

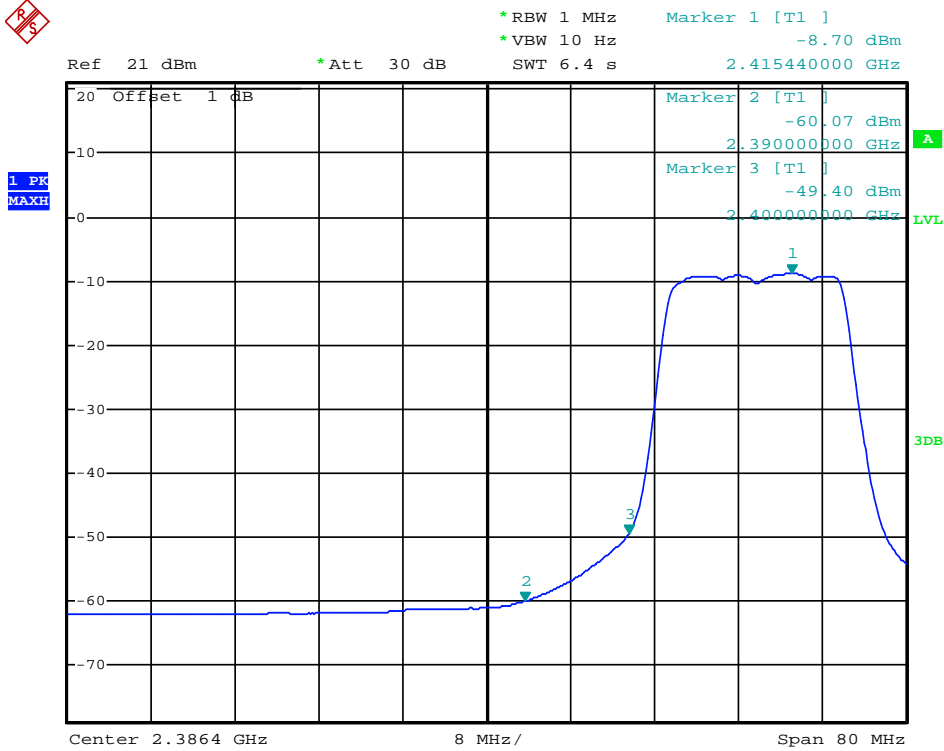

Date: 11.MAR.2014 13:27:15

(Plot 4.5.2 A2: Channel 1: 2412MHz @ 802.11g)

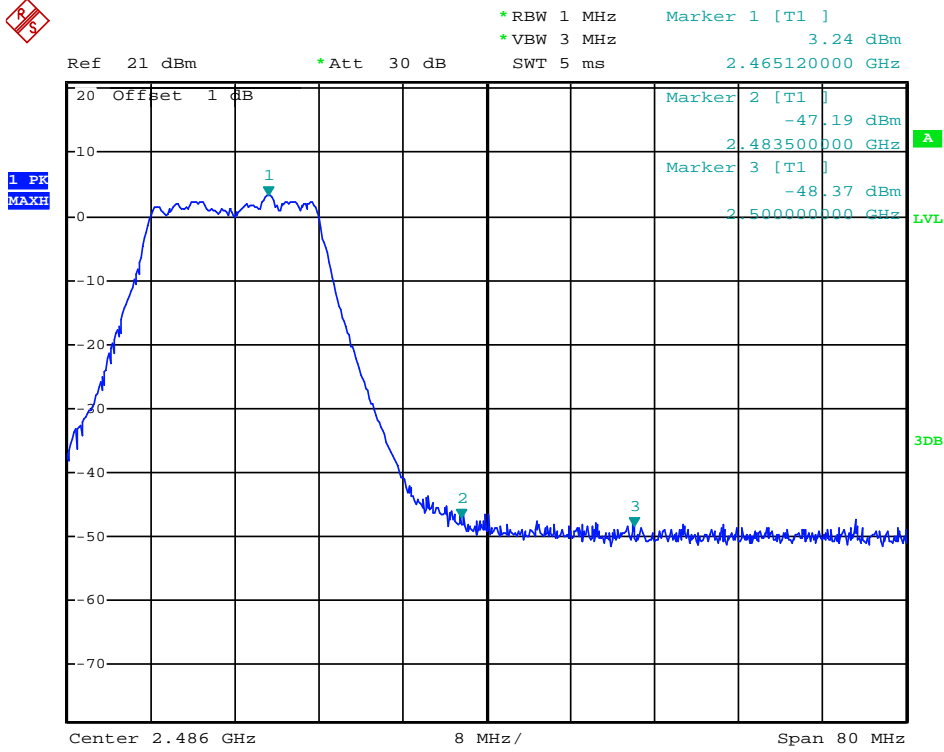

Date: 11.MAR.2014 13:34:14

(Plot 4.5.2 A3: Channel 11: 2462MHz @ 802.11g)

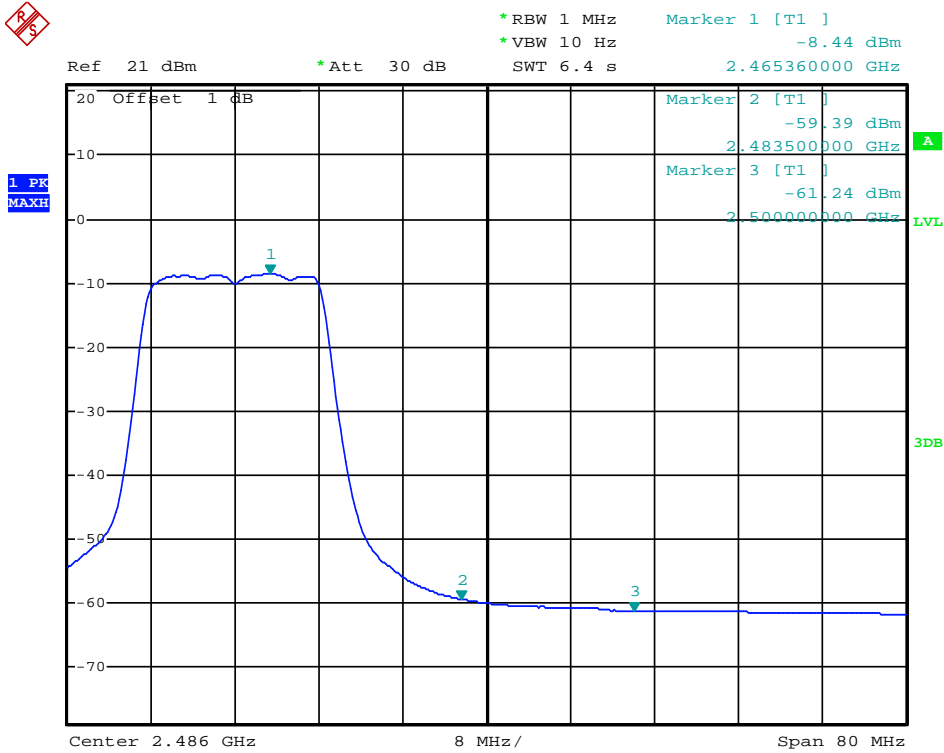

Date: 11.MAR.2014 13:34:38

(Plot 4.5.2 A4: Channel 11: 2462MHz @ 802.11g)

4.5.3 802.11n(20MHz) Test Mode

A. Test Verdict

Frequency (MHz)	Conducted Power (dBm)	Antenna Gain (dBi)	Ground Reflection Factor (dB)	Covert Radiated E Level At 3m (dBuV/m)	Detector	Limit (dBuV/m)	Refer to Plot
2390.00	-47.61	2.00	0.00	49.65	Peak	74.00	Plot 4.5.3 A1
2390.00	-59.99	2.00	0.00	37.27	AV	54.00	Plot 4.5.3 A2
2408.96	0.81	2.00	0.00	98.07	Peak	---	Plot 4.5.3 A1
2415.20	-10.03	2.00	0.00	87.23	AV	---	Plot 4.5.3 A2
2458.64	2.35	2.00	0.00	99.61	Peak	---	Plot 4.5.3 A3
2465.12	-8.41	2.00	0.00	88.85	AV	---	Plot 4.5.3 A4
2483.50	-47.03	2.00	0.00	50.23	Peak	74.00	Plot 4.5.3 A3
2483.50	-58.99	2.00	0.00	38.27	AV	54.00	Plot 4.5.3 A4

Note: 1. For 802.11n(20MHz) mode at final test to get the worst-case emission at 6.5Mbps.
 2. The test results including the cable loss.
 3. "----" means that the fundamental frequency not for 15.209 limits requirement.

B. Test Plots

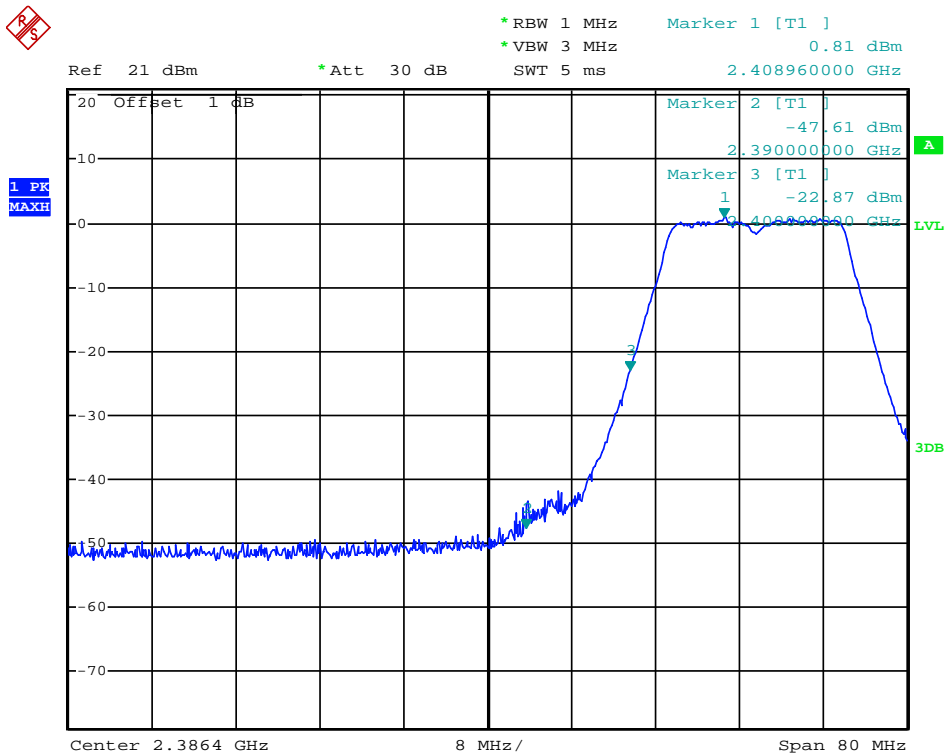

Date: 11.MAR.2014 13:28:40

(Plot 4.5.3 A1: Channel 1: 2412MHz @ 802.11n(20MHz))

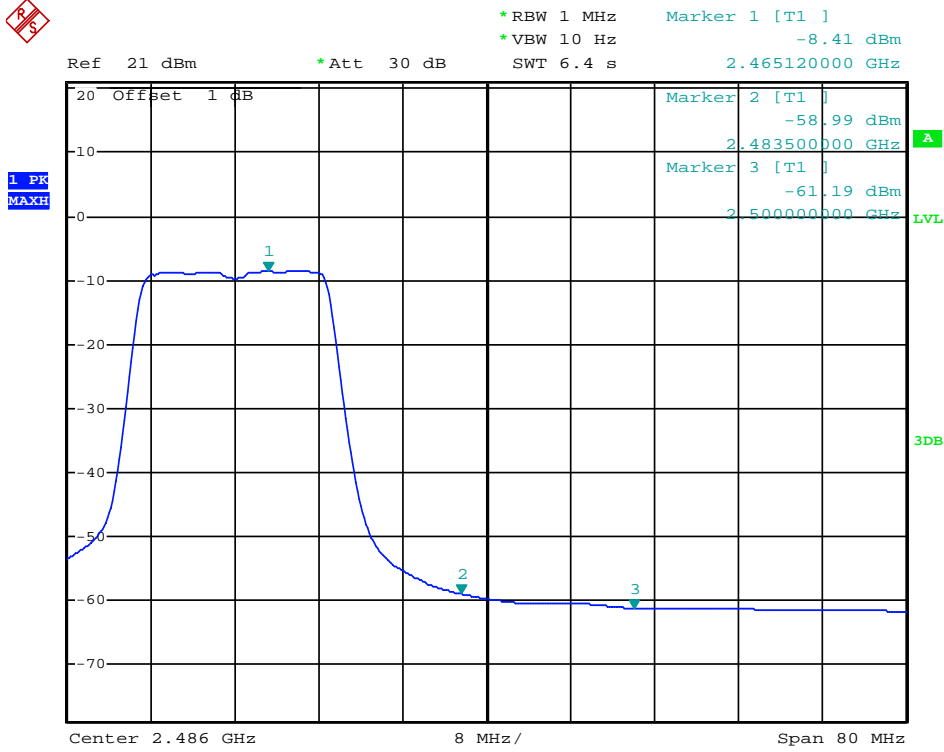

Date: 11.MAR.2014 13:31:44

(Plot 4.5.3 A4: Channel 11: 2462MHz @ 802.11n(20MHz))

4.5.4 802.11n(40MHz) Test Mode

A. Test Verdict

Frequency (MHz)	Conducted Power (dBm)	Antenna Gain (dBi)	Ground Reflection Factor (dB)	Covert Radiated E Level At 3m (dBuV/m)	Detector	Limit (dBuV/m)	Refer to Plot
2390.00	-49.96	2.00	0.00	47.30	Peak	74.00	Plot 4.5.4 A1
2390.00	-61.19	2.00	0.00	36.07	AV	54.00	Plot 4.5.4 A2
2431.10	-5.88	2.00	0.00	91.38	Peak	---	Plot 4.5.4 A1
2431.30	-16.66	2.00	0.00	80.60	AV	---	Plot 4.5.4 A2
2461.10	-5.44	2.00	0.00	91.82	Peak	---	Plot 4.5.4 A3
2461.10	-16.02	2.00	0.00	81.24	AV	---	Plot 4.5.4 A4
2483.50	-49.26	2.00	0.00	48.00	Peak	74.00	Plot 4.5.4 A3
2483.50	-60.43	2.00	0.00	36.83	AV	54.00	Plot 4.5.4 A4

Note: 1. For 802.11n(40MHz) mode at final test to get the worst-case emission at 13.5Mbps.
 2. The test results including the cable loss.
 3. "—" means that the fundamental frequency not for 15.209 limits requirement.

B. Test Plots

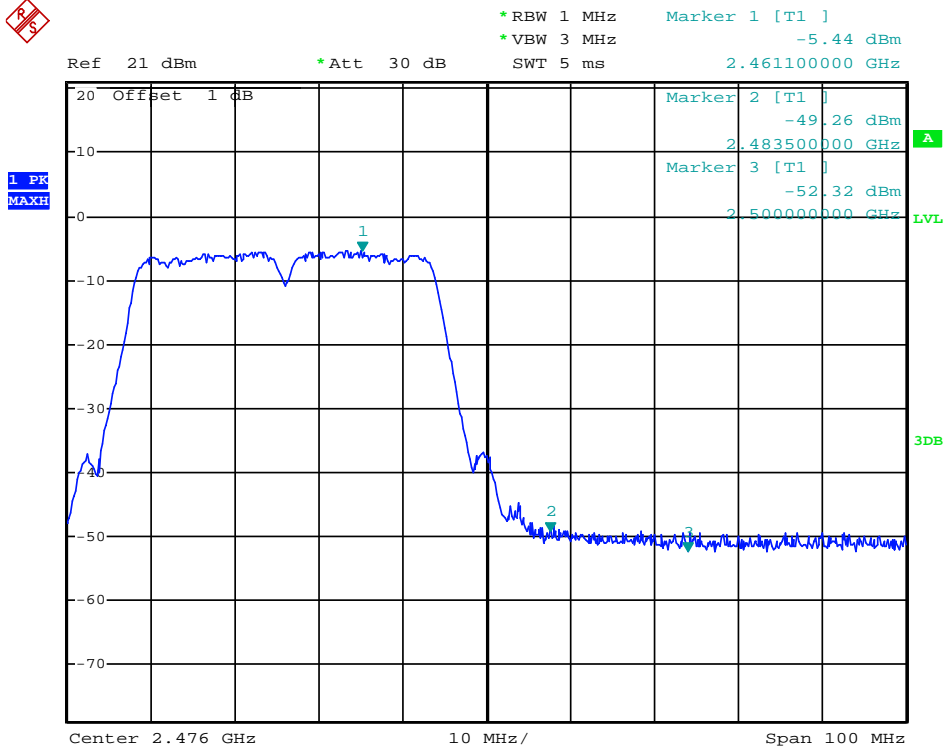

Date: 11.MAR.2014 13:39:10

(Plot 4.5.4 A3: Channel 9: 2452MHz @ 802.11n(40MHz))

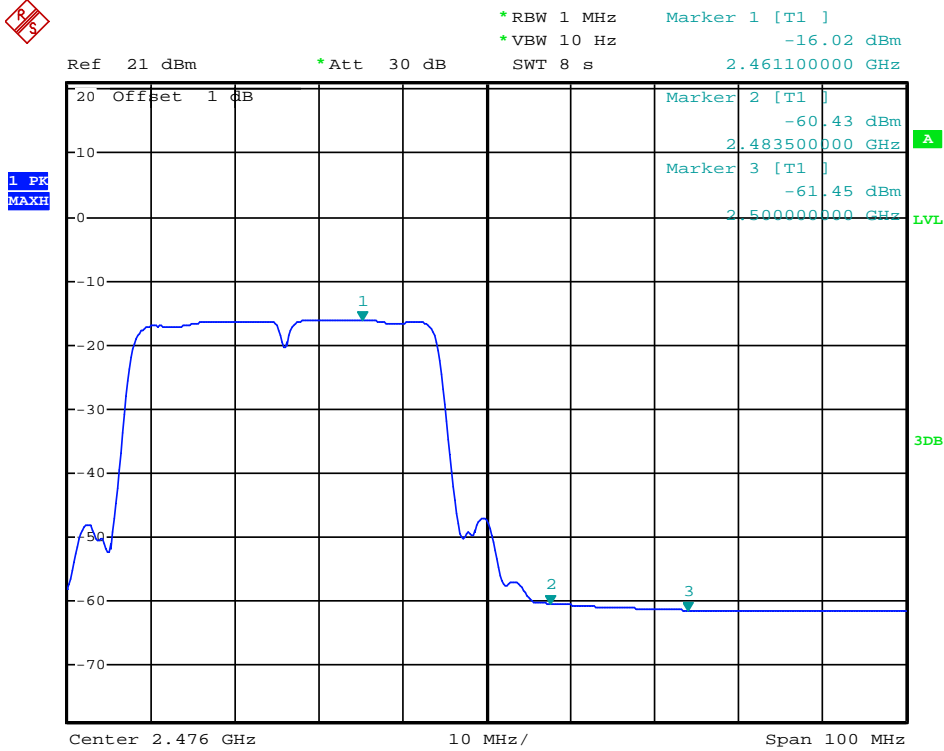

Date: 11.MAR.2014 13:39:37

(Plot 4.5.4 A4: Channel 9: 2452MHz @ 802.11n(40MHz))

4.6. Spurious RF Conducted Emission

TEST CONFIGURATION

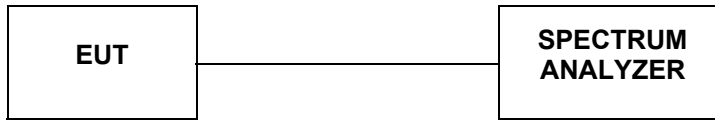

TEST PROCEDURE

The Spurious RF conducted emissions compliance of RF radiated emission should be measured by following the guidance in ANSI C63.10-2009 with respect to maximizing the emission by rotating the EUT, measuring the emission while the EUT is situated in three orthogonal planes (if appropriate), adjusting the measurement antenna height and polarization etc. Set RBW=100kHz and VBM= 300KHz to measure the peak field strength, and measure frequency range from 30MHz to 26.5GHz.

LIMIT

1. Below -20dB of the highest emission level in operating band.
2. Fall in the restricted bands listed in section 15.205. The maximum permitted average field strength is listed in section 15.209.

TEST RESULTS

Remark: The measurement frequency range is from 30MHz to the 10th harmonic of the fundamental frequency. The lowest, middle and highest channels are tested to verify the spurious emissions and bandedge measurement data.

4.6.1 802.11b Test Mode

A. Test Verdict

Channel	Frequency (MHz)	Frequency Range	Refer to Plot	Limit (dBc)	Verdict
1	2412	30MHz-3GHz	Plot 4.6.1 A1	20	PASS
		3GHz-15GHz	Plot 4.6.1 A2	20	PASS
		15GHz-25GHz	Plot 4.6.1 A3	20	PASS
6	2437	30MHz-3GHz	Plot 4.6.1 B1	20	PASS
		3GHz-15GHz	Plot 4.6.1 B2	20	PASS
		15GHz-25GHz	Plot 4.6.1 B3	20	PASS
11	2462	30MHz-3GHz	Plot 4.6.1 C1	20	PASS
		3GHz-15GHz	Plot 4.6.1 C2	20	PASS
		15GHz-25GHz	Plot 4.6.1 C3	20	PASS

Frequency (MHz)	Delta Peak to Band emission (dBc)	Detector	Limit (dBc)	Refer to Plot	Verdict
2400.00	-39.28	Peak	-20	Plot 4.6.1 D	PASS
2483.50	-49.95	Peak	-20	Plot 4.6.1 E	PASS

- Note: 1. For 802.11b mode at final test to get the worst-case emission at 1Mbps.
2. The test results including the cable loss.

B. Test Plots

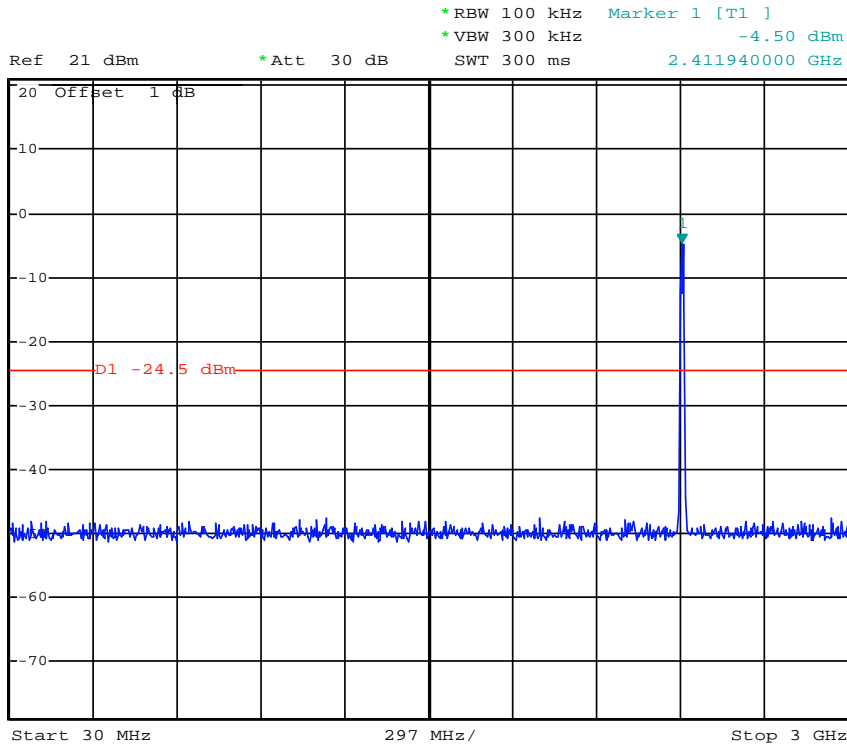

Date: 11.MAR.2014 13:02:53

(Plot 4.6.1 A1: Channel 1: 2412MHz @ 802.11b)

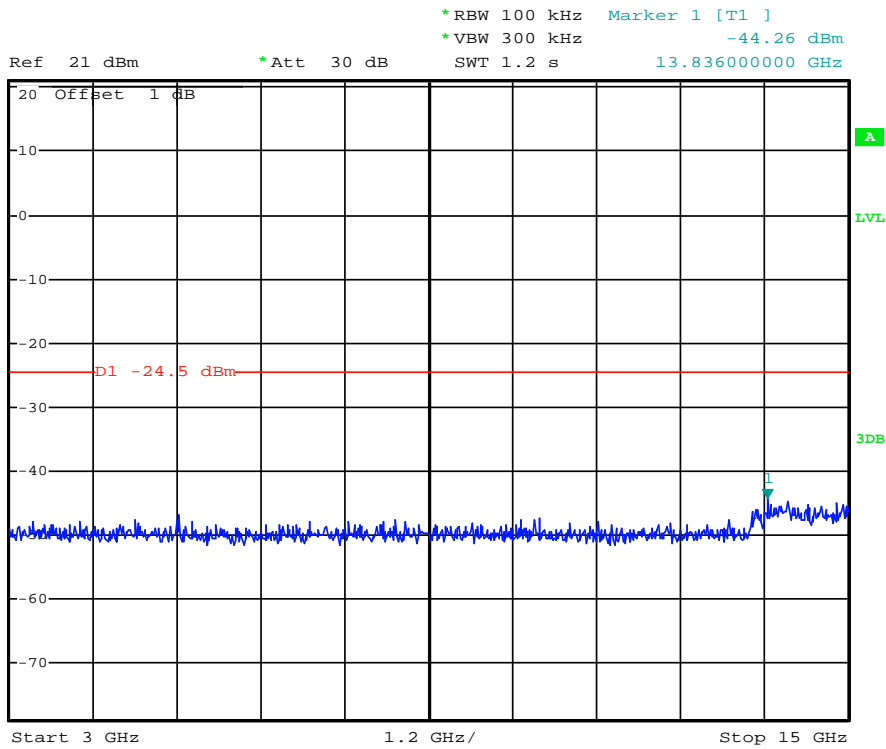

Date: 11.MAR.2014 13:03:11

(Plot 4.6.1 A2: Channel 1: 2412MHz @ 802.11b)



*RBW 100 kHz Marker 1 [T1]
*VBW 300 kHz -42.71 dBm
SWT 1 s 23.21000000 GHz

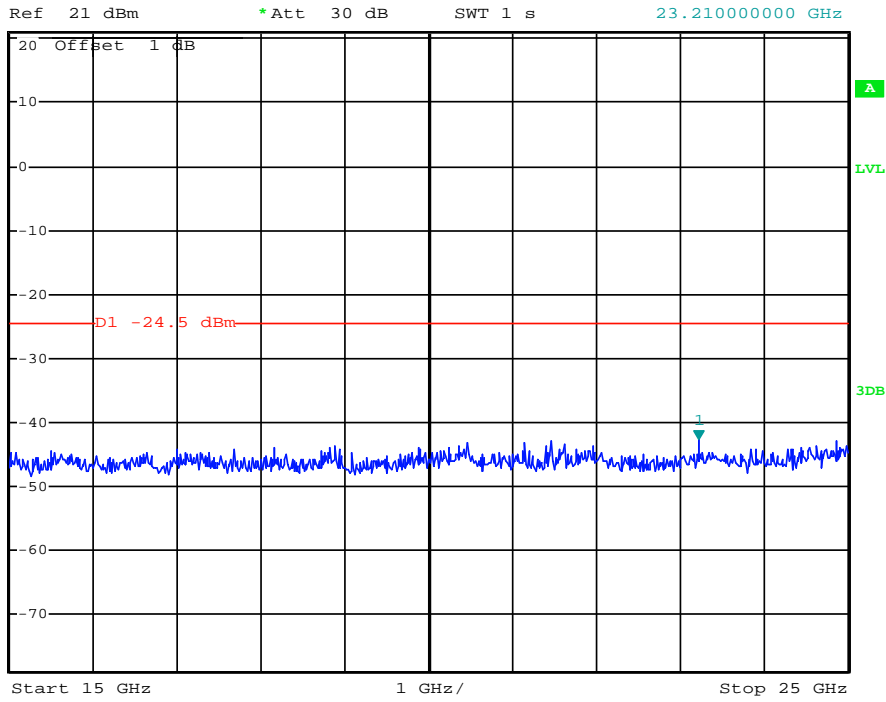

Date: 11.MAR.2014 13:03:24

(Plot 4.6.1 A3: Channel 1: 2412MHz @ 802.11b)



*RBW 100 kHz Marker 1 [T1]
*VBW 300 kHz -3.98 dBm
SWT 300 ms 2.438670000 GHz

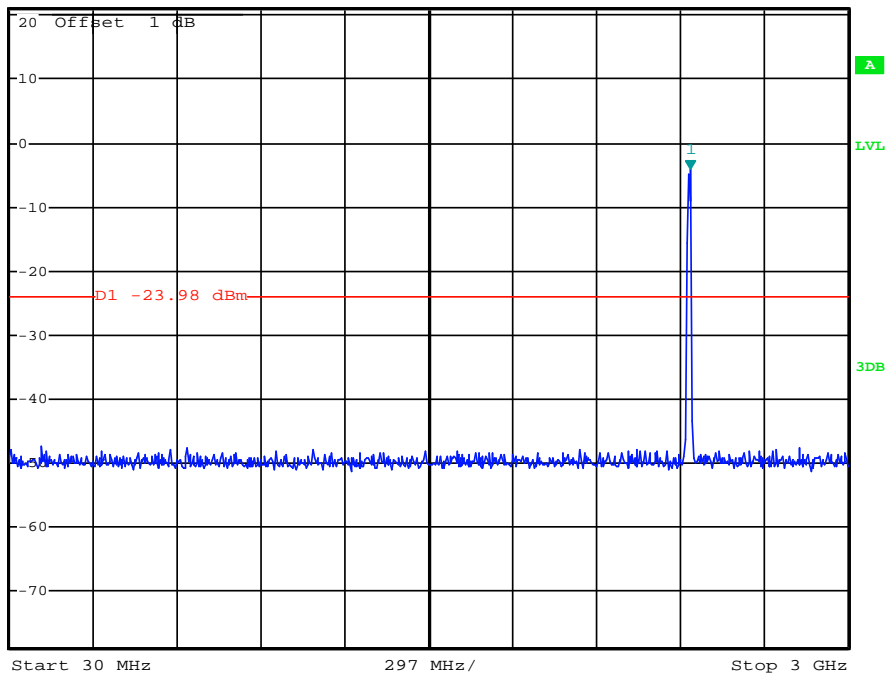

Date: 11.MAR.2014 13:04:17

(Plot 4.6.1 B1: Channel 6: 2437MHz @ 802.11b)



*RBW 100 kHz Marker 1 [T1]
*VBW 300 kHz -44.88 dBm
SWT 1.2 s 14.184000000 GHz

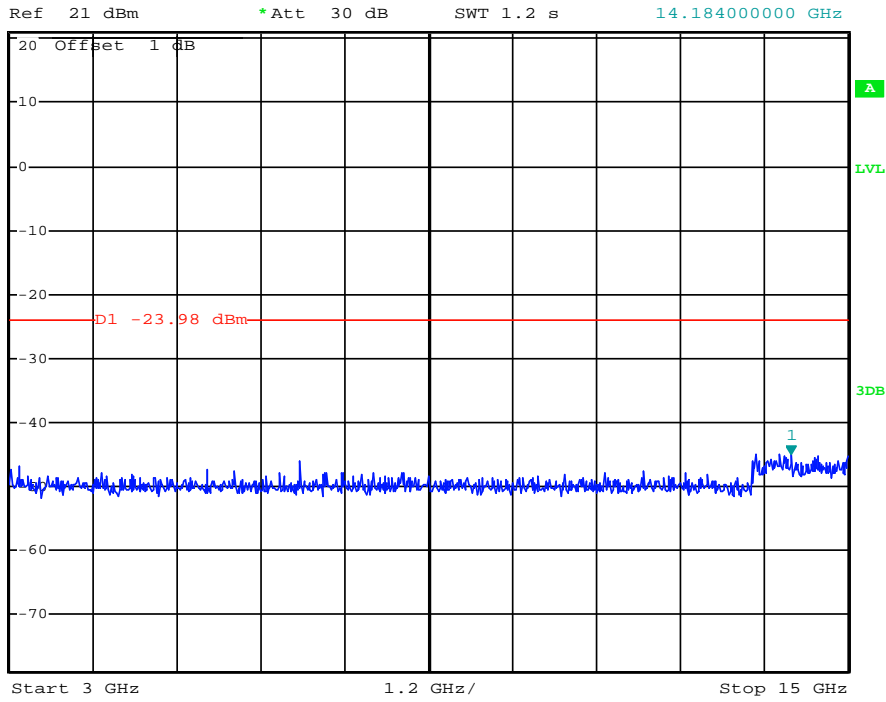

Date: 11.MAR.2014 13:04:29

(Plot 4.6.1 B2: Channel 6: 2437MHz @ 802.11b)



*RBW 100 kHz Marker 1 [T1]
*VBW 300 kHz -42.60 dBm
SWT 1 s 21.610000000 GHz

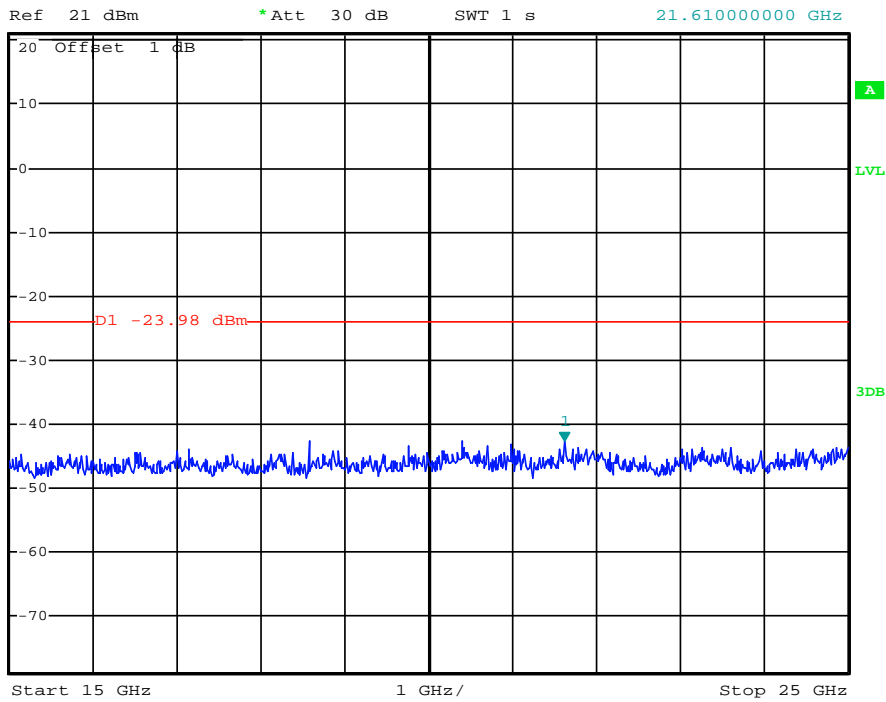

Date: 11.MAR.2014 13:04:41

(Plot 4.6.1 B3: Channel 6: 2437MHz @ 802.11b)

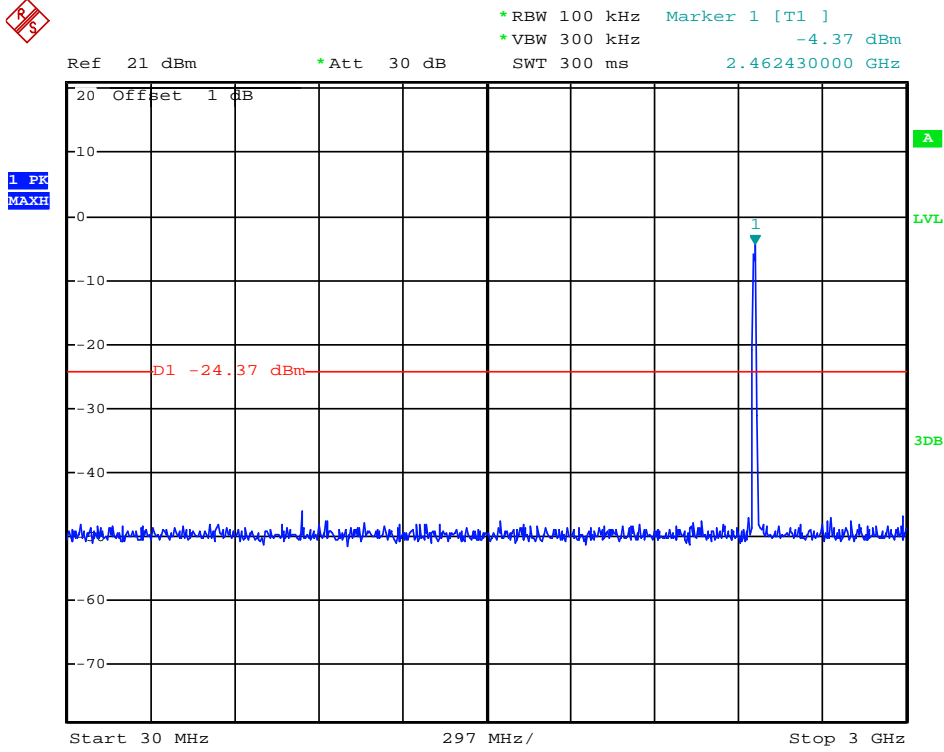

Date: 11.MAR.2014 13:05:27

(Plot 4.6.1 C1: Channel 11: 2462MHz @ 802.11b)

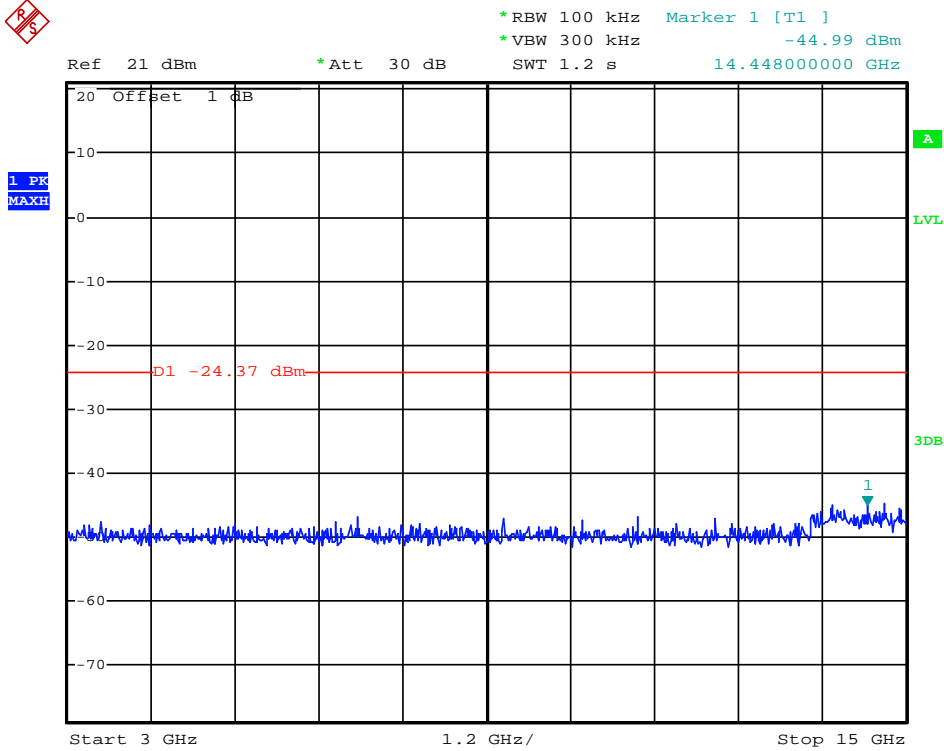

Date: 11.MAR.2014 13:05:43

(Plot 4.6.1 C2: Channel 11: 2462MHz @ 802.11b)

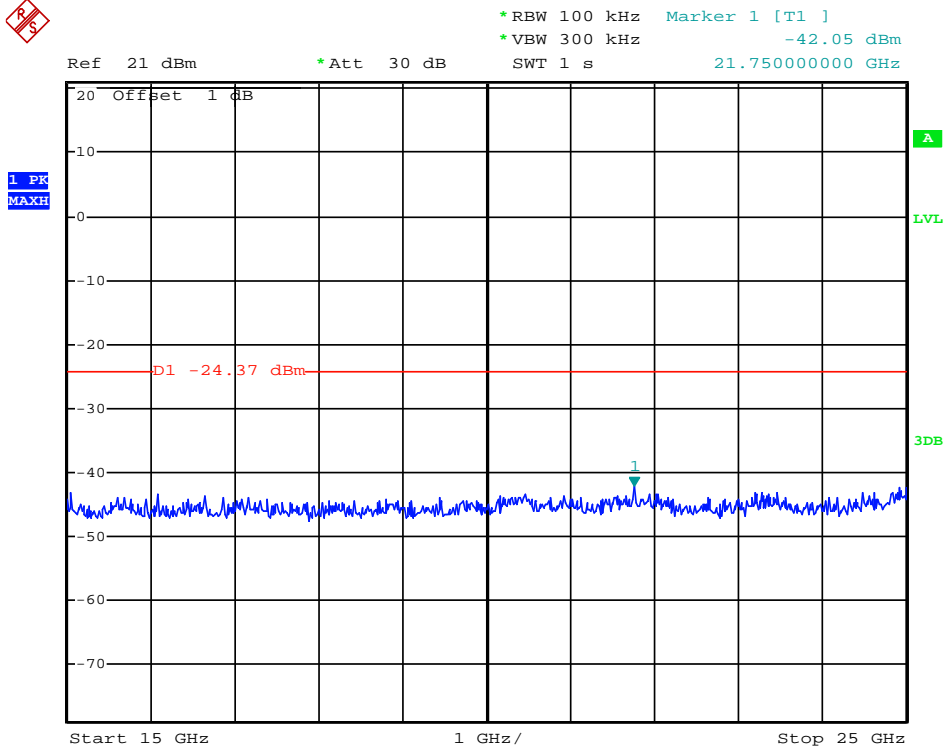

Date: 11.MAR.2014 13:06:08

(Plot 4.6.1 C3: Channel 11: 2462MHz @ 802.11b)

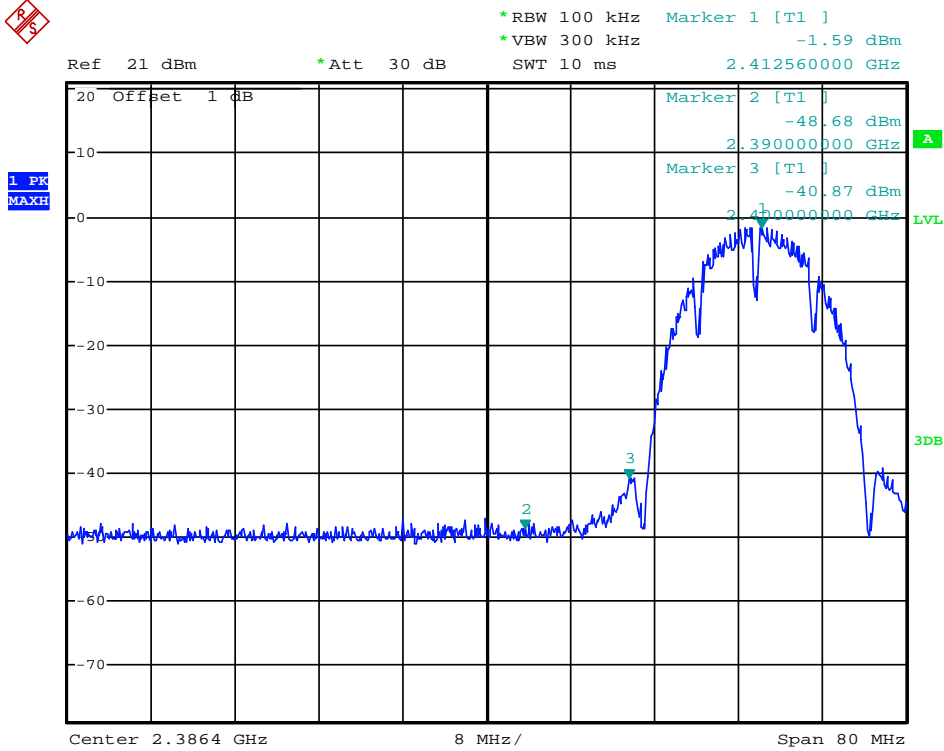

Date: 11.MAR.2014 13:23:28

(Plot 4.6.1 D: Channel 1: 2412MHz @ 802.11b)



*RBW 100 kHz Marker 1 [T1]
 *VBW 300 kHz -0.17 dBm
 Ref 21 dBm *Att 30 dB SWI 10 ms 2.461520000 GHz

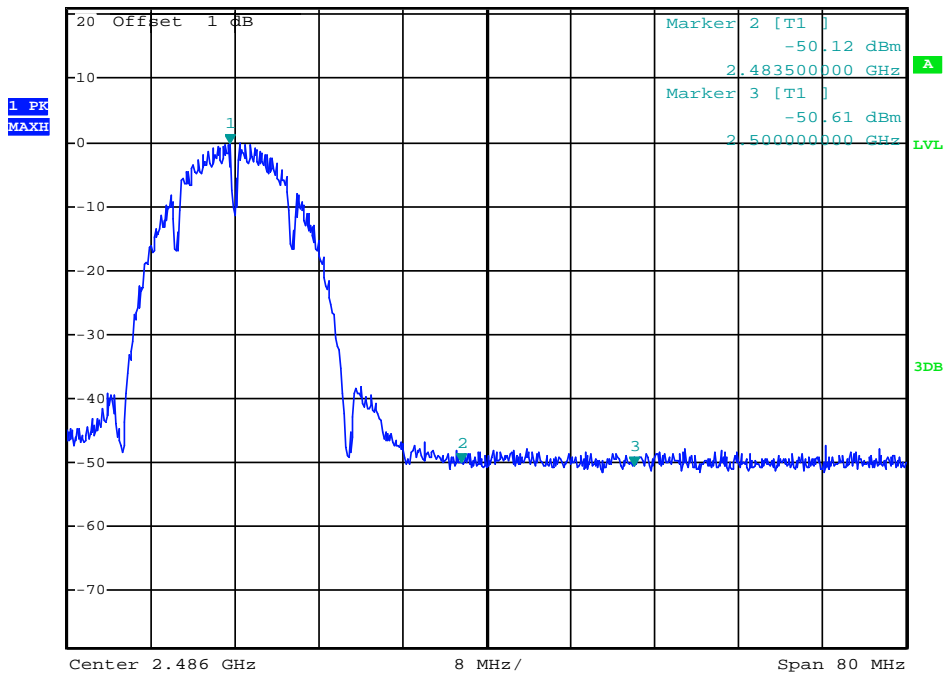

Date: 11.MAR.2014 13:32:33

(Plot 4.6.1 E: Channel 11: 2462MHz @ 802.11b)

4.6.2 802.11g Test Mode

A. Test Verdict

Channel	Frequency (MHz)	Frequency Range	Refer to Plot	Limit (dBc)	Verdict
1	2412	30MHz-3GHz	Plot 4.6.2 A1	20	PASS
		3GHz-15GHz	Plot 4.6.2 A2	20	PASS
		15GHz-25GHz	Plot 4.6.2 A3	20	PASS
6	2437	30MHz-3GHz	Plot 4.6.2 B1	20	PASS
		3GHz-15GHz	Plot 4.6.2 B2	20	PASS
		15GHz-25GHz	Plot 4.6.2 B3	20	PASS
11	2462	30MHz-3GHz	Plot 4.6.2 C1	20	PASS
		3GHz-15GHz	Plot 4.6.2 C2	20	PASS
		15GHz-25GHz	Plot 4.6.2 C3	20	PASS

Frequency (MHz)	Delta Peak to Band emission (dBc)	Detector	Limit (dBc)	Refer to Plot	Verdict
2400.00	-33.11	Peak	-20	Plot 4.6.2 D	PASS
2483.50	-42.48	Peak	-20	Plot 4.6.2 E	PASS

Note: 1. For 802.11g mode at final test to get the worst-case emission at 6Mbps.
 2. The test results including the cable lose.

B. Test Plots

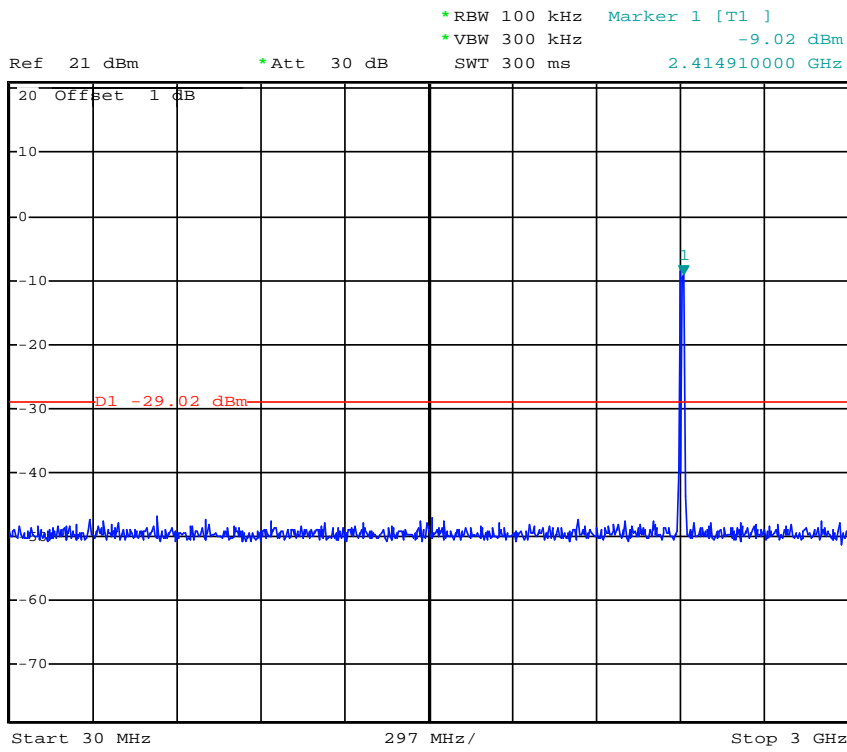

Date: 11.MAR.2014 13:07:49

(Plot 4.6.2 A1: Channel 1: 2412MHz @ 802.11g)

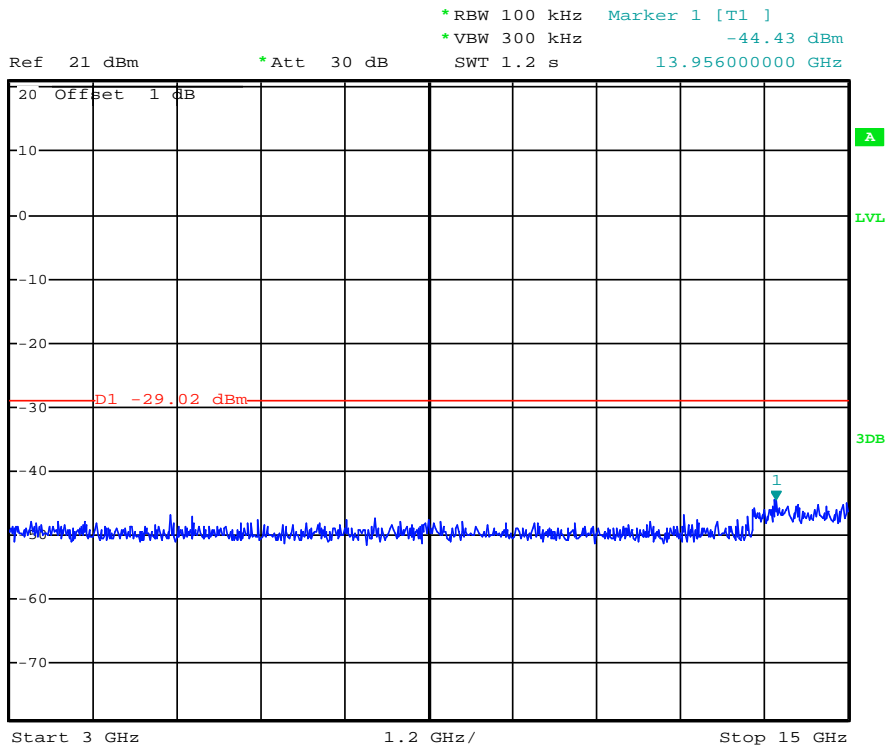

Date: 11.MAR.2014 13:08:14

(Plot 4.6.2 A2: Channel 2: 2412MHz @ 802.11g)

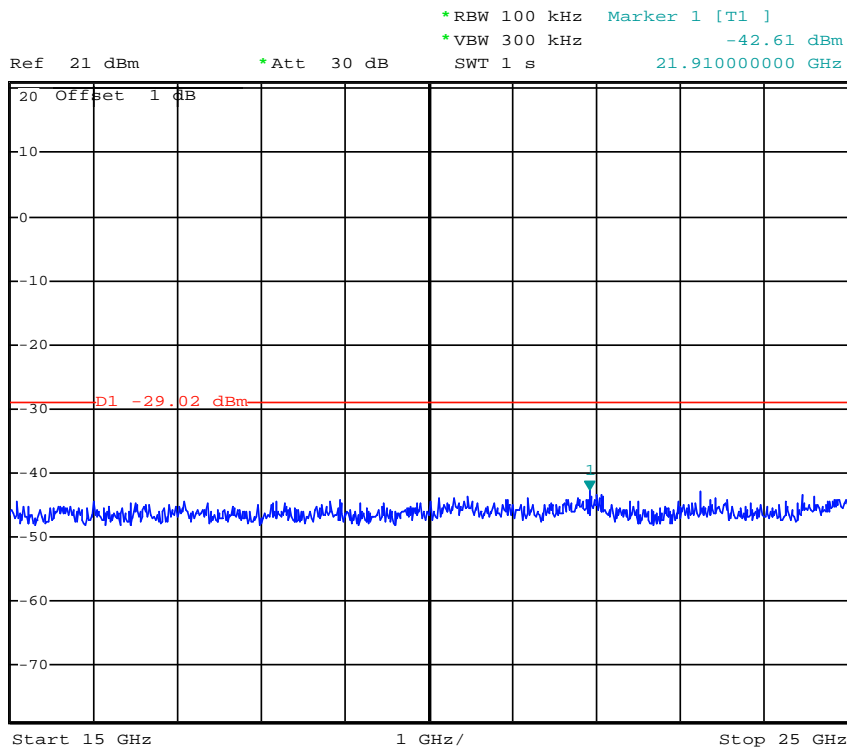

Date: 11.MAR.2014 13:08:26

(Plot 4.6.2 A3: Channel 1: 2412MHz @ 802.11g)

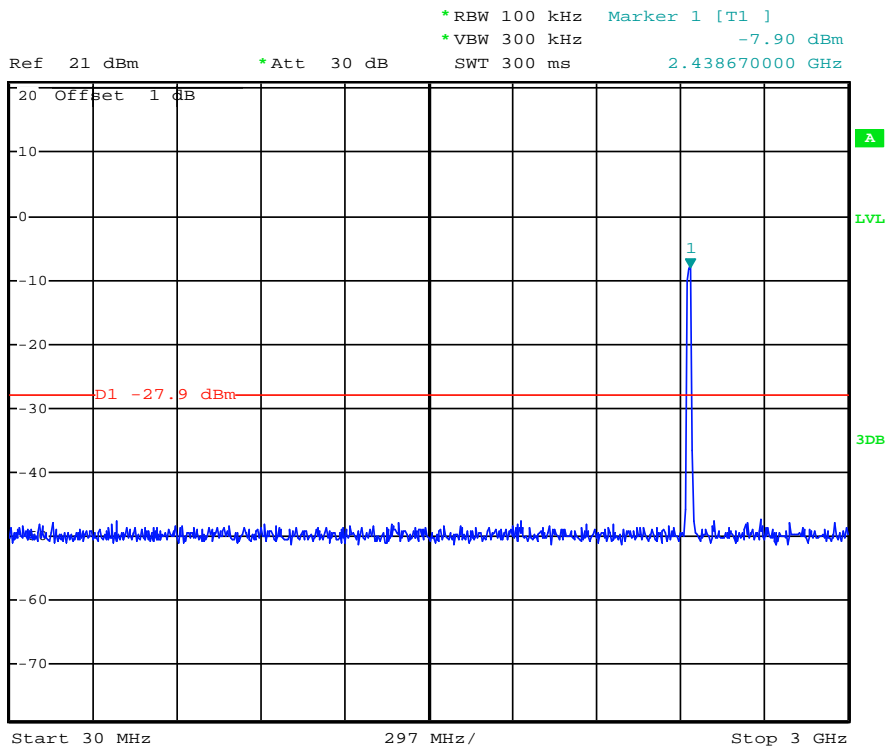

Date: 11.MAR.2014 13:09:49

(Plot 4.6.2 B1: Channel 6: 2437MHz @ 802.11g)



*RBW 100 kHz Marker 1 [T1]
*VBW 300 kHz -44.15 dBm
SWT 1.2 s 14.52000000 GHz

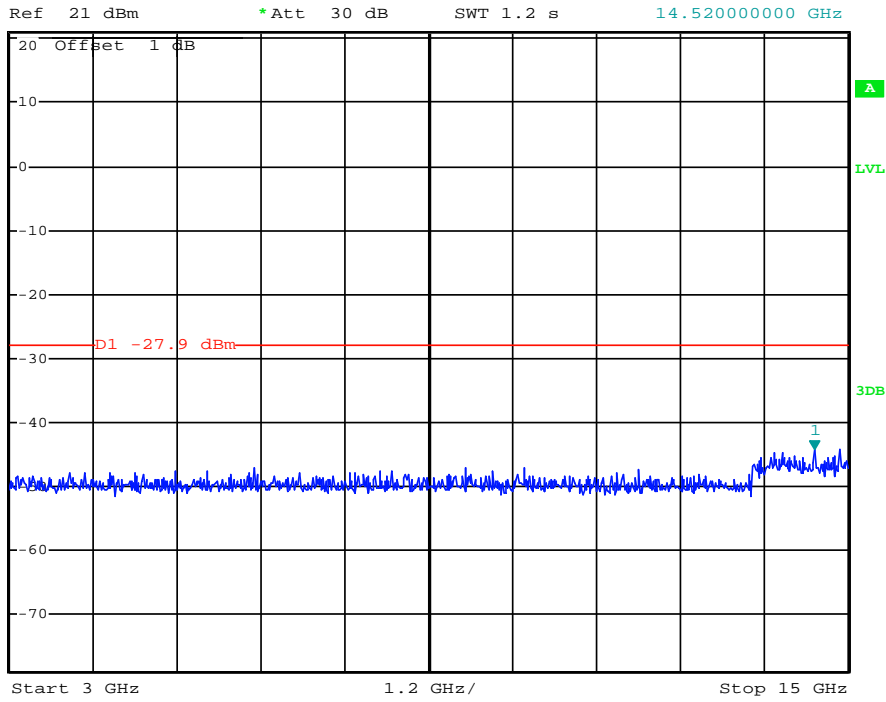

Date: 11.MAR.2014 13:10:06

(Plot 4.6.2 B2: Channel 6: 2437MHz @ 802.11g)



*RBW 100 kHz Marker 1 [T1]
*VBW 300 kHz -42.32 dBm
SWT 1 s 21.90000000 GHz

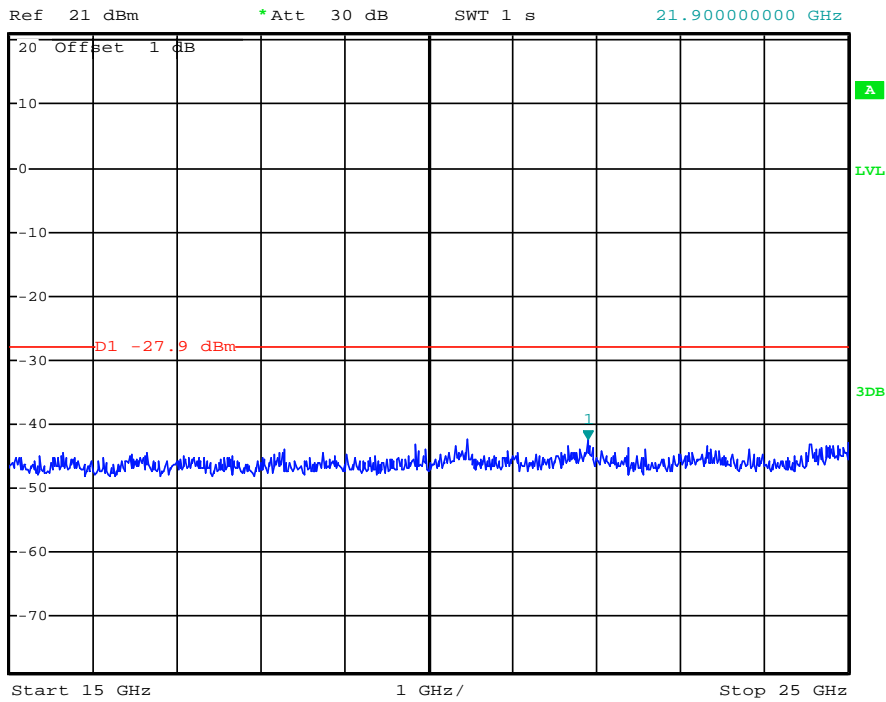

Date: 11.MAR.2014 13:10:19

(Plot 4.6.2 B3: Channel 6: 2437MHz @ 802.11g)

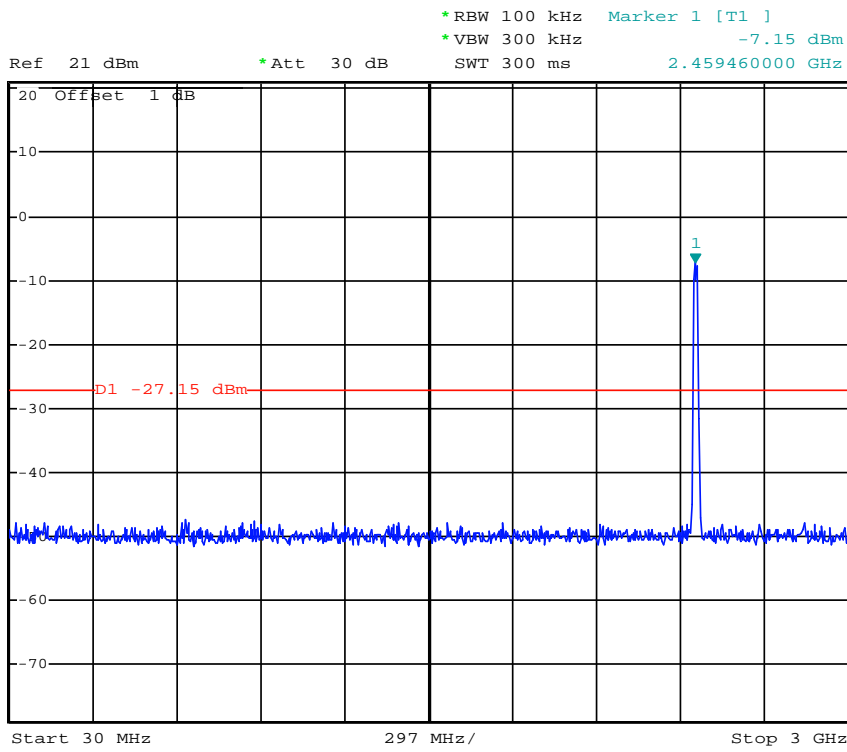

Date: 11.MAR.2014 13:10:56

(Plot 4.6.2 C1: Channel 11: 2462MHz @ 802.11g)

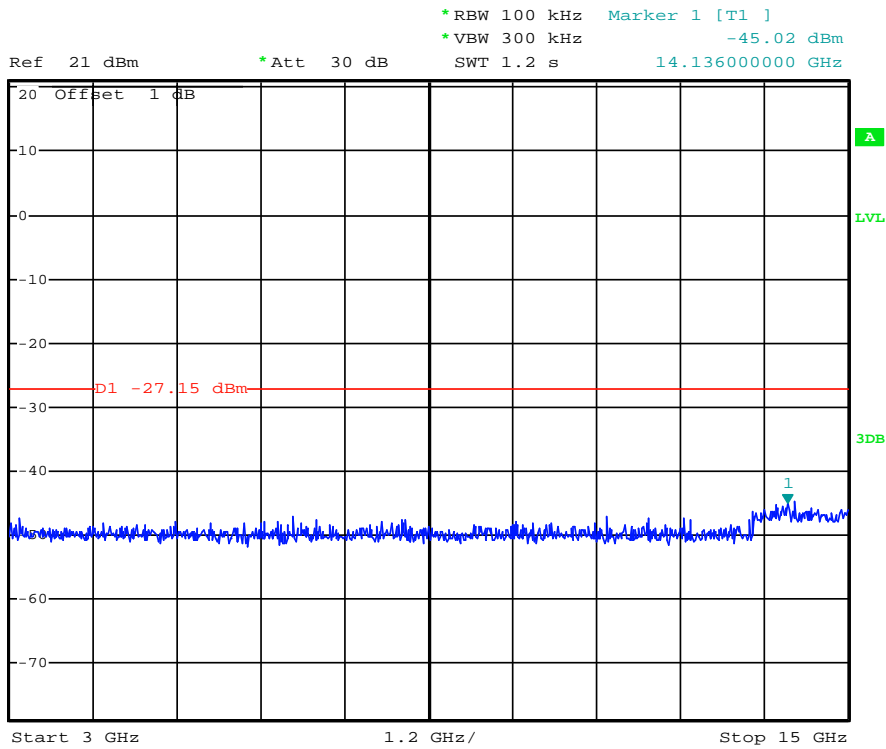

Date: 11.MAR.2014 13:11:52

(Plot 4.6.2 C2: Channel 11: 2462MHz @ 802.11g)



*RBW 100 kHz Marker 1 [T1]
*VBW 300 kHz -42.61 dBm
SWT 1 s 24.88000000 GHz

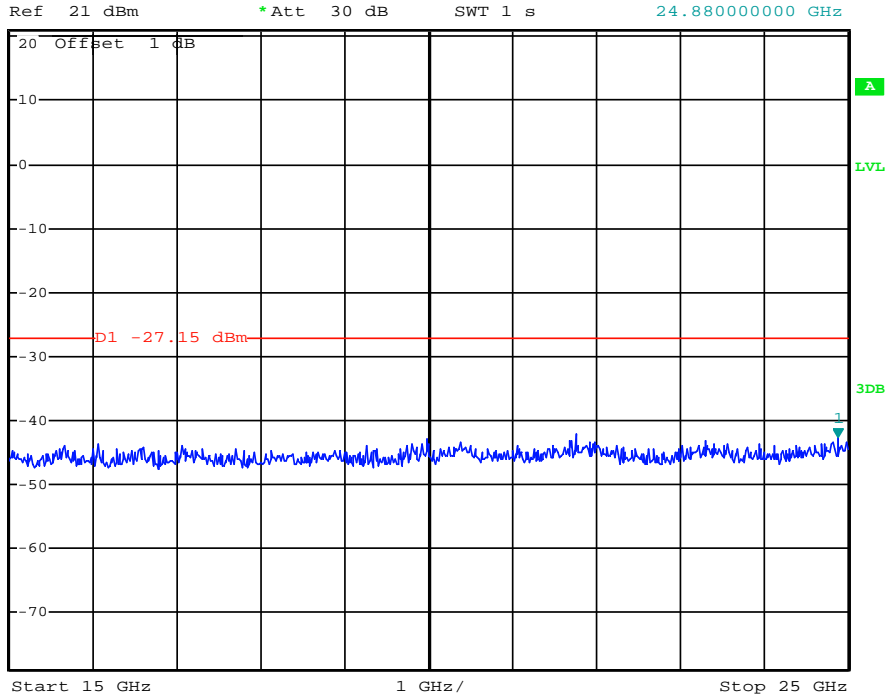

Date: 11.MAR.2014 13:11:31

(Plot 4.6.2 C3: Channel 11: 2462MHz @ 802.11g)



*RBW 100 kHz Marker 1 [T1]
*VBW 300 kHz -8.66 dBm
SWT 10 ms 2.416400000 GHz

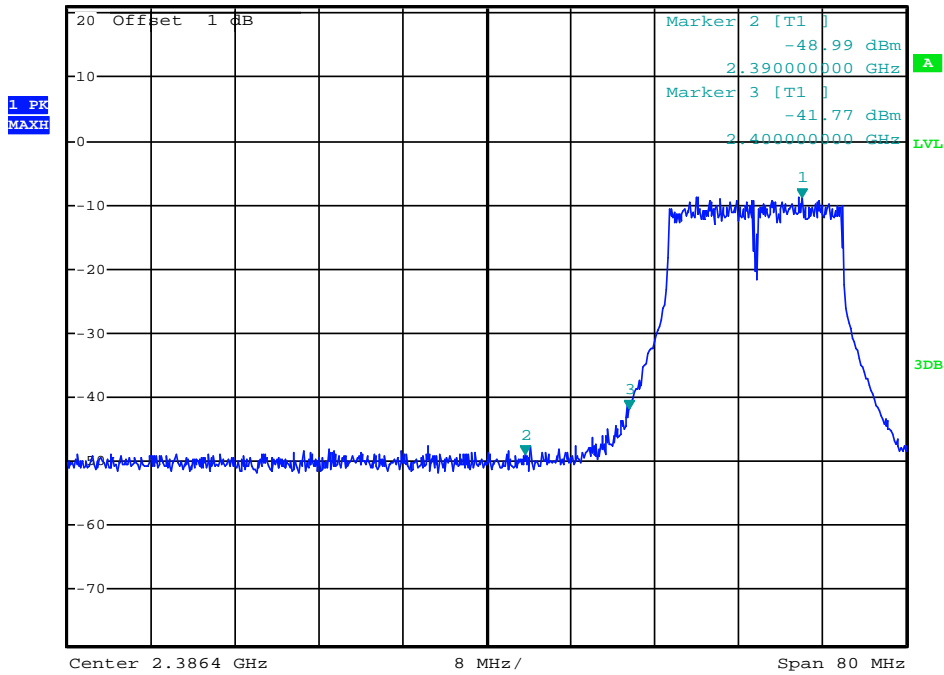

Date: 11.MAR.2014 13:26:32

(Plot 4.6.2 D: Channel 1: 2412MHz @ 802.11g)

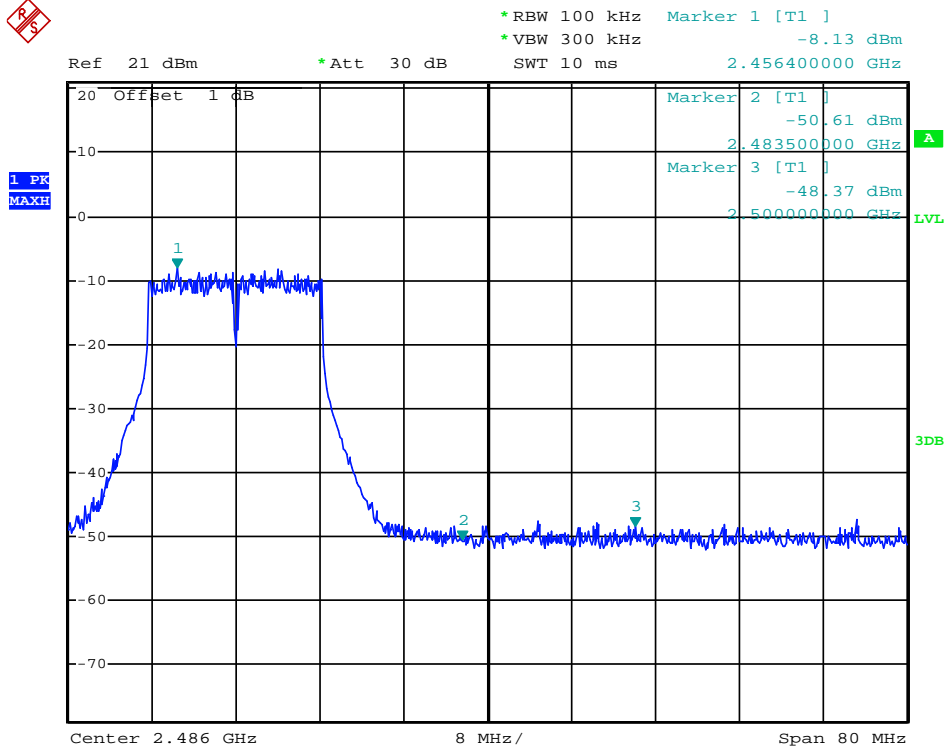

Date: 11.MAR.2014 13:33:59

(Plot 4.6.2 E: Channel 11: 2462MHz @ 802.11g)

4.6.3 802.11n(20MHz) Test Mode

A. Test Verdict

Channel	Frequency (MHz)	Frequency Range	Refer to Plot	Limit (dBc)	Verdict
1	2412	30MHz-3GHz	Plot 4.6.3 A1	20	PASS
		3GHz-15GHz	Plot 4.6.3 A2	20	PASS
		15GHz-25GHz	Plot 4.6.3 A3	20	PASS
6	2437	30MHz-3GHz	Plot 4.6.3 B1	20	PASS
		3GHz-15GHz	Plot 4.6.3 B2	20	PASS
		15GHz-25GHz	Plot 4.6.3 B3	20	PASS
11	2462	30MHz-3GHz	Plot 4.6.3 C1	20	PASS
		3GHz-15GHz	Plot 4.6.3 C2	20	PASS
		15GHz-25GHz	Plot 4.6.3 C3	20	PASS

Frequency (MHz)	Delta Peak to Band emission (dBc)	Detector	Limit (dBc)	Refer to Plot	Verdict
2400.00	-38.98	Peak	-20	Plot 4.6.3 D	PASS
2483.50	-40.50	Peak	-20	Plot 4.6.3 E	PASS

Note: 1. For 802.11n(20MHz) mode at final test to get the worst-case emission at 6.5Mbps.
 2. The test results including the cable loss.

B. Test Plots

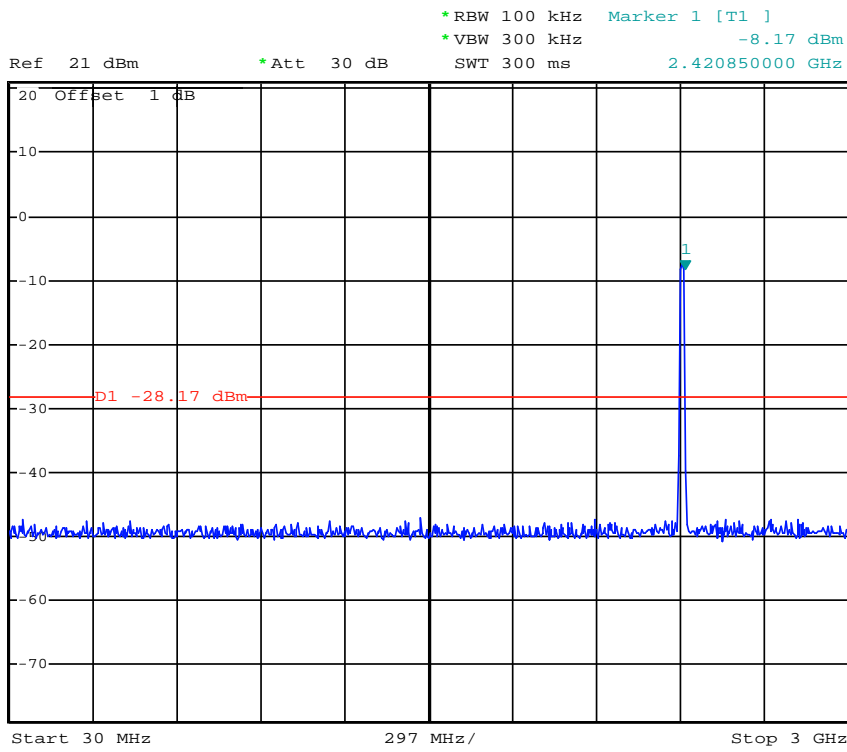

Date: 11.MAR.2014 13:13:15

(Plot 4.6.3 A1: Channel 1: 2412MHz @ 802.11n(20MHz))

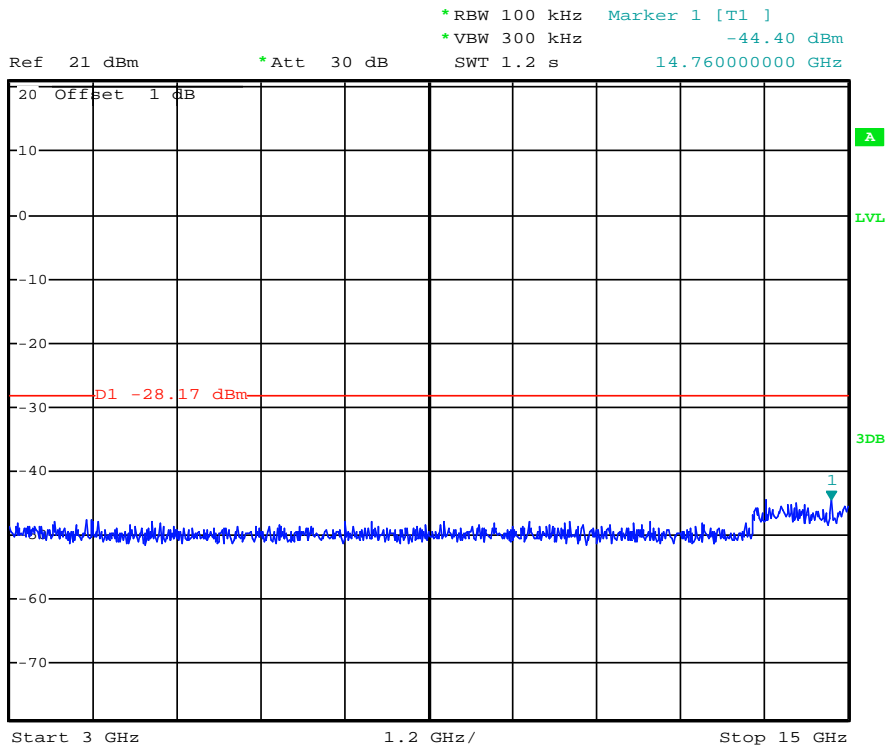

Date: 11.MAR.2014 13:13:29

(Plot 4.6.3 A2: Channel 1: 2412MHz @ 802.11n(20MHz))

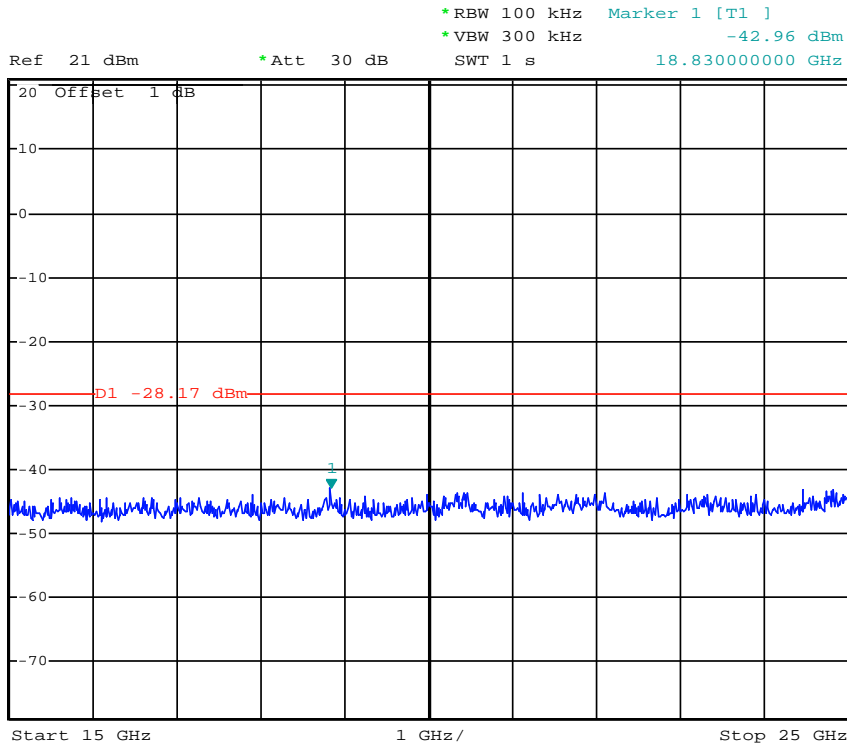

Date: 11.MAR.2014 13:13:41

(Plot 4.6.3 A3: Channel 1: 2412MHz @ 802.11n(20MHz))

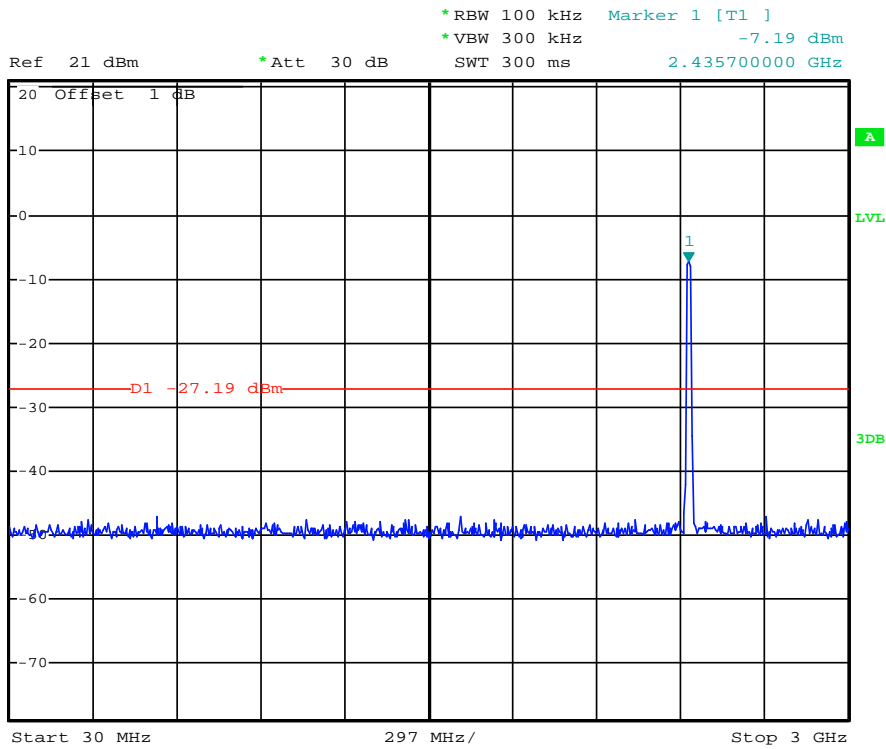

Date: 11.MAR.2014 13:14:39

(Plot 4.6.3 B1: Channel 6: 2437MHz @ 802.11n(20MHz))



*RBW 100 kHz Marker 1 [T1]
*VBW 300 kHz -43.72 dBm
SWT 1.2 s 14.076000000 GHz

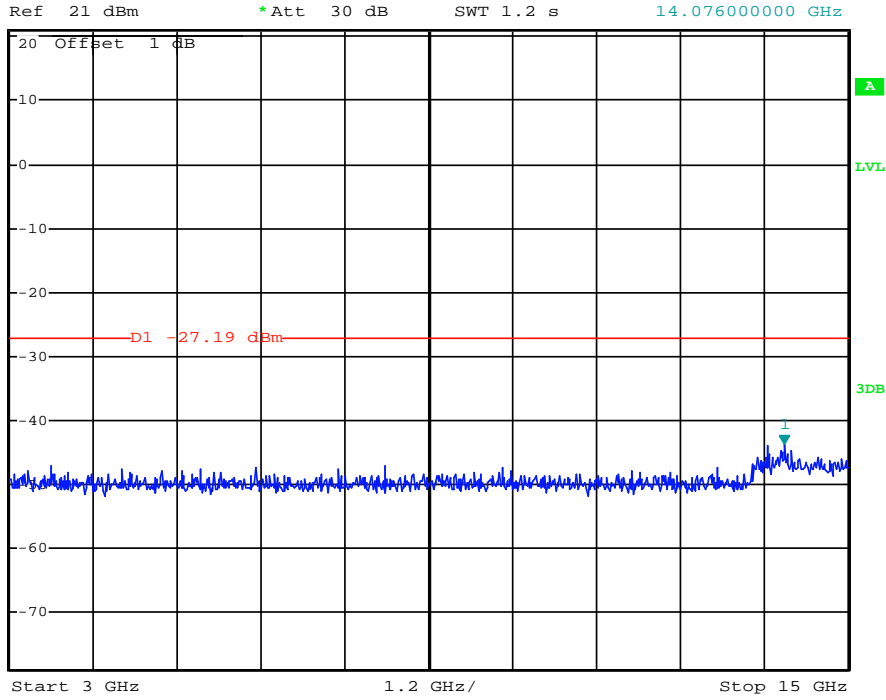

Date: 11.MAR.2014 13:14:52

(Plot 4.6.3 B2: Channel 6: 2437MHz @ 802.11n(20MHz))



*RBW 100 kHz Marker 1 [T1]
*VBW 300 kHz -43.04 dBm
SWT 1 s 19.890000000 GHz

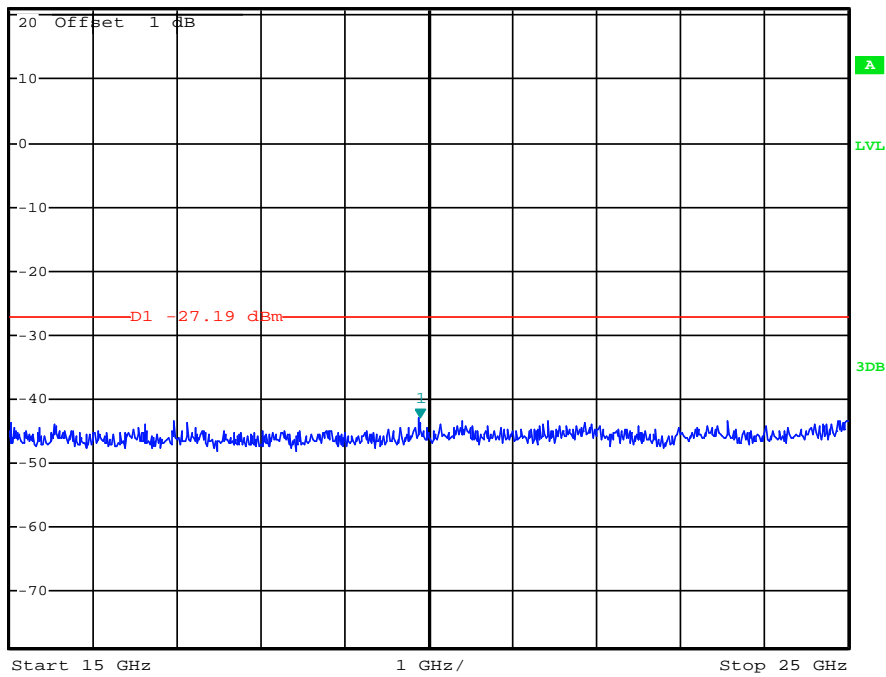

Date: 11.MAR.2014 13:15:08

(Plot 4.6.3 B3: Channel 6: 2437MHz @ 802.11n(20MHz))



*RBW 100 kHz Marker 1 [T1]
*VBW 300 kHz -7.28 dBm
SWT 300 ms 2.468370000 GHz

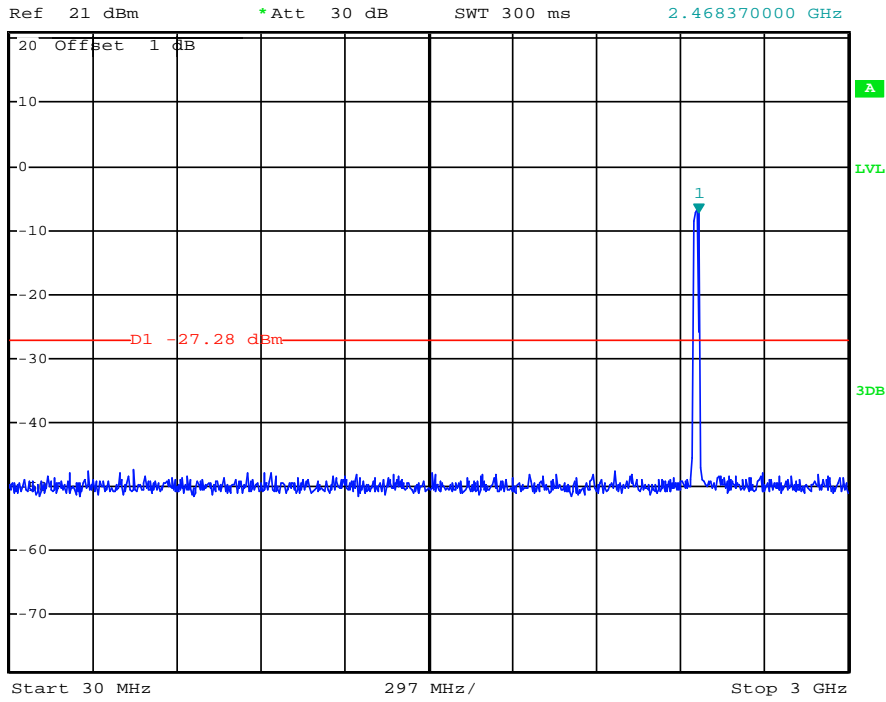

Date: 11.MAR.2014 13:15:49

(Plot 4.6.3 C1: Channel 11: 2462MHz @ 802.11n(20MHz))



*RBW 100 kHz Marker 1 [T1]
*VBW 300 kHz -43.10 dBm
SWT 1.2 s 13.992000000 GHz

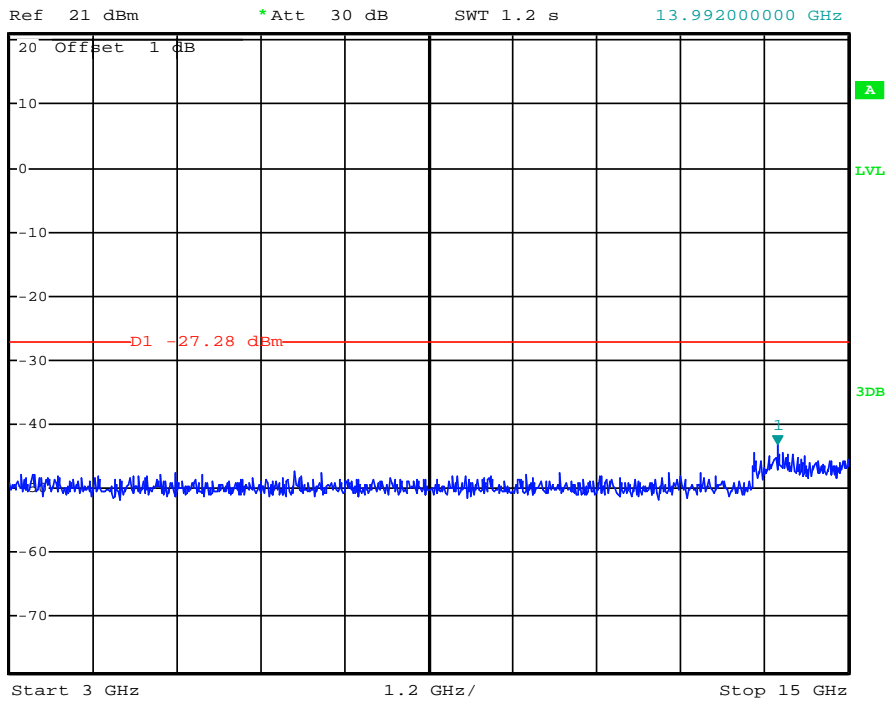

Date: 11.MAR.2014 13:16:09

(Plot 4.6.3 C2: Channel 11: 2462MHz @ 802.11n(20MHz))



*RBW 100 kHz Marker 1 [T1]
*VBW 300 kHz -43.10 dBm
SWT 1 s 24.16000000 GHz

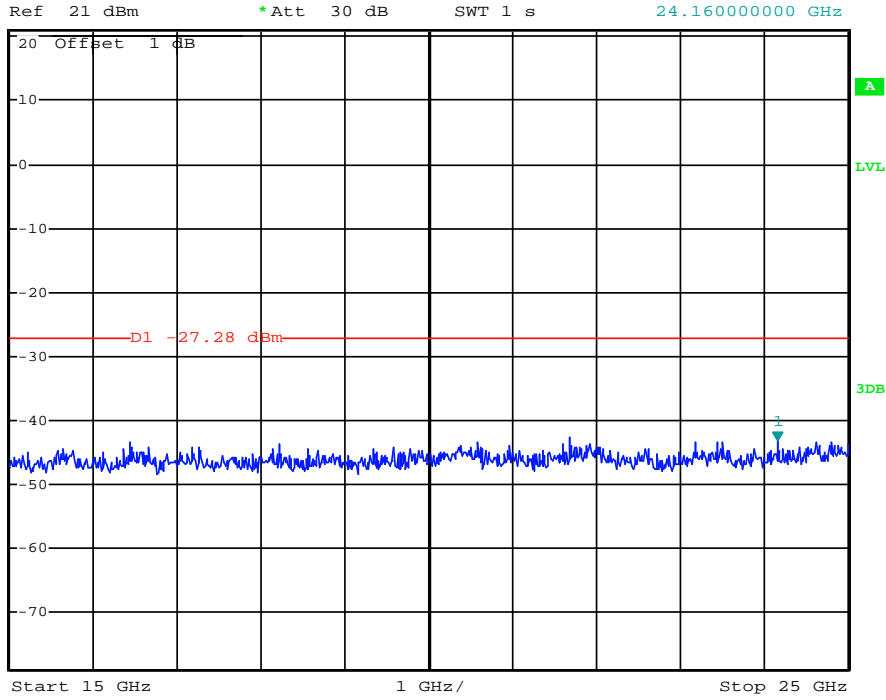

Date: 11.MAR.2014 13:16:21

(Plot 4.6.3 C3: Channel 11: 2462MHz @ 802.11n(20MHz))



*RBW 100 kHz Marker 1 [T1]
*VBW 300 kHz -11.26 dBm
SWT 10 ms 2.406640000 GHz

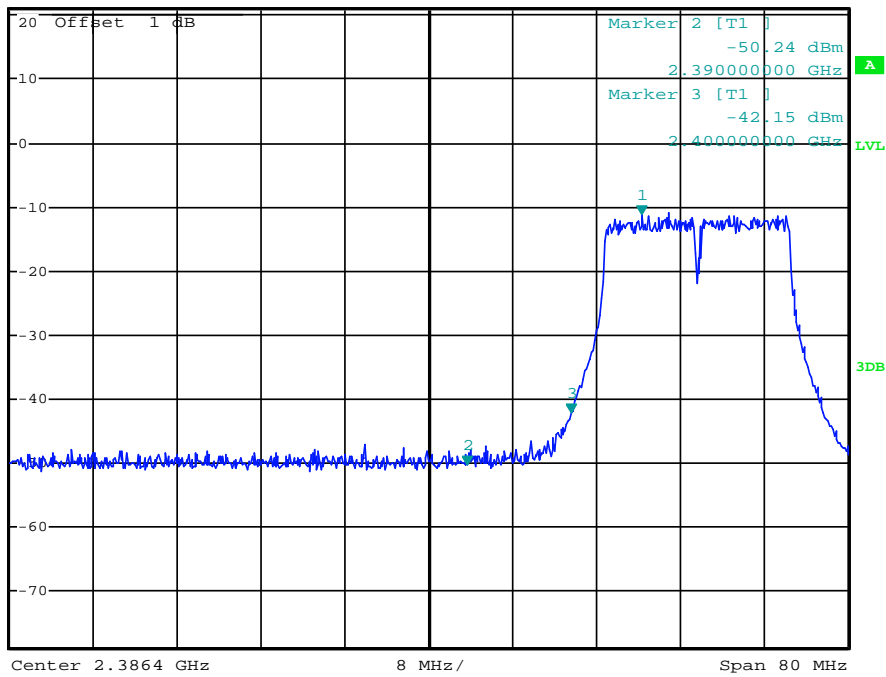

Date: 11.MAR.2014 13:28:04

(Plot 4.6.3 D: Channel 1: 2412MHz @ 802.11n(20MHz))

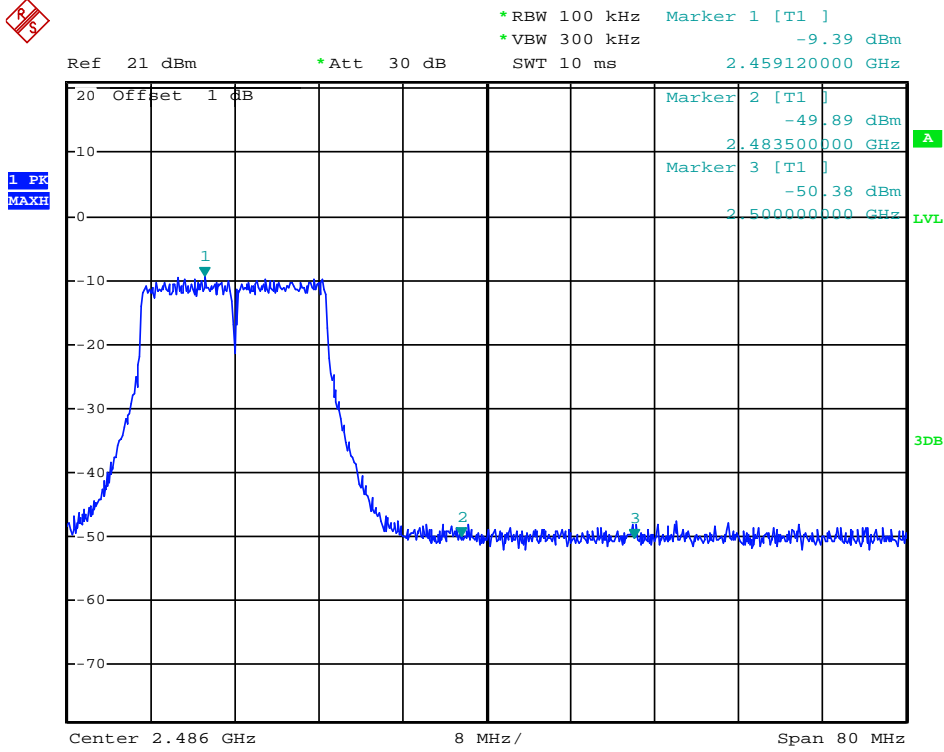

Date: 11.MAR.2014 13:30:49

(Plot 4.6.3 E: Channel 11: 2462MHz @ 802.11n(20MHz))

4.6.4 802.11n(40MHz) Test Mode

A. Test Verdict

Channel	Frequency (MHz)	Frequency Range	Refer to Plot	Limit (dBc)	Verdict
3	2422	30MHz-3GHz	Plot 4.6.4 A1	20	PASS
		3GHz-15GHz	Plot 4.6.4 A2	20	PASS
		15GHz-25GHz	Plot 4.6.4 A3	20	PASS
6	2437	30MHz-3GHz	Plot 4.6.4 B1	20	PASS
		3GHz-15GHz	Plot 4.6.4 B2	20	PASS
		15GHz-25GHz	Plot 4.6.4 B3	20	PASS
9	2452	30MHz-3GHz	Plot 4.6.4 C1	20	PASS
		3GHz-15GHz	Plot 4.6.4 C2	20	PASS
		15GHz-25GHz	Plot 4.6.4 C3	20	PASS

Frequency (MHz)	Delta Peak to Band emission (dBc)	Detector	Limit (dBc)	Refer to Plot	Verdict
2400.00	-31.77	Peak	-20	Plot 4.6.3 D	PASS
2483.50	-33.99	Peak	-20	Plot 4.6.3 E	PASS

Note: 1. For 802.11n(20MHz) mode at final test to get the worst-case emission at 6.5Mbps.
 2. The test results including the cable loss.

B. Test Plots



*RBW 100 kHz Marker 1 [T1]
*VBW 300 kHz -10.63 dBm
SWT 300 ms 2.417880000 GHz

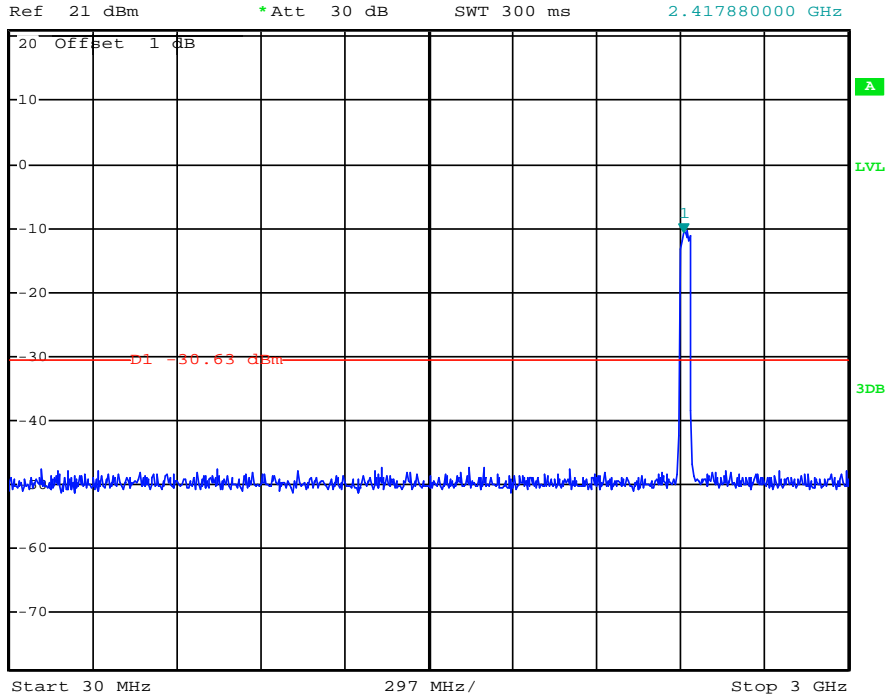

Date: 11.MAR.2014 13:17:05

(Plot 4.6.4 A1: Channel 3: 2422MHz @ 802.11n(20MHz))



*RBW 100 kHz Marker 1 [T1]
*VBW 300 kHz -44.73 dBm
SWT 1.2 s 14.100000000 GHz

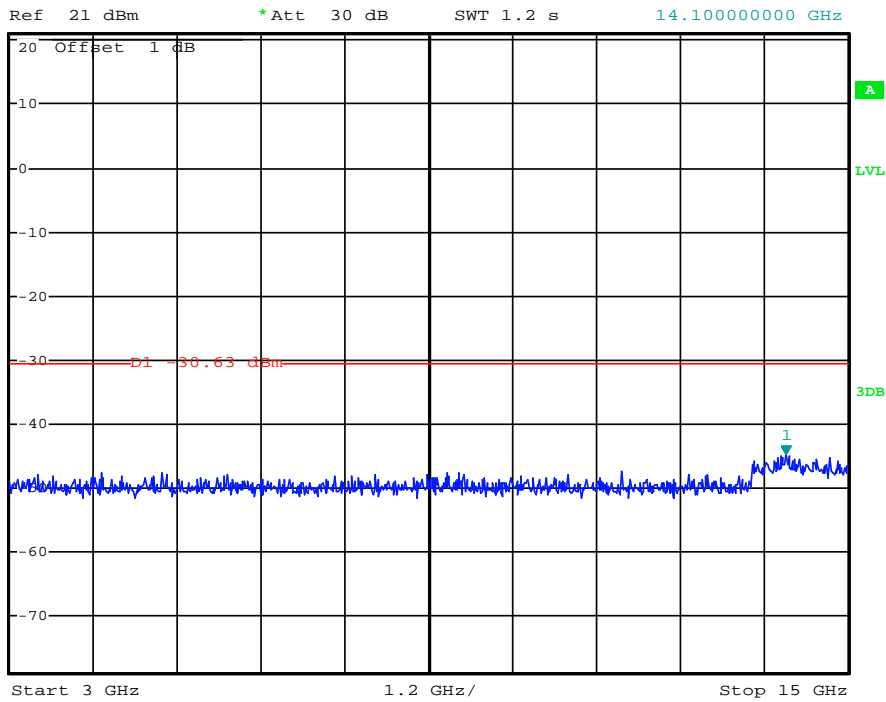

Date: 11.MAR.2014 13:17:21

(Plot 4.6.4 A2: Channel 3: 2422MHz @ 802.11n(20MHz))



*RBW 100 kHz Marker 1 [T1]
*VBW 300 kHz -42.75 dBm
SWT 1 s 25.00000000 GHz

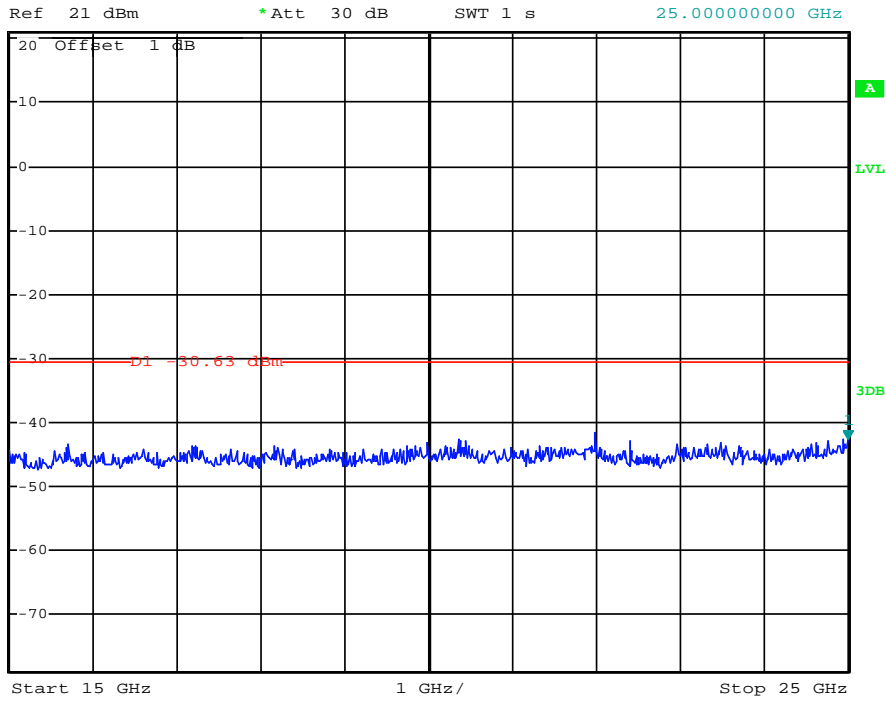

Date: 11.MAR.2014 13:17:47

(Plot 4.6.3 A4: Channel 3: 2422MHz @ 802.11n(20MHz))



*RBW 100 kHz Marker 1 [T1]
*VBW 300 kHz -10.48 dBm
SWT 300 ms 2.444610000 GHz

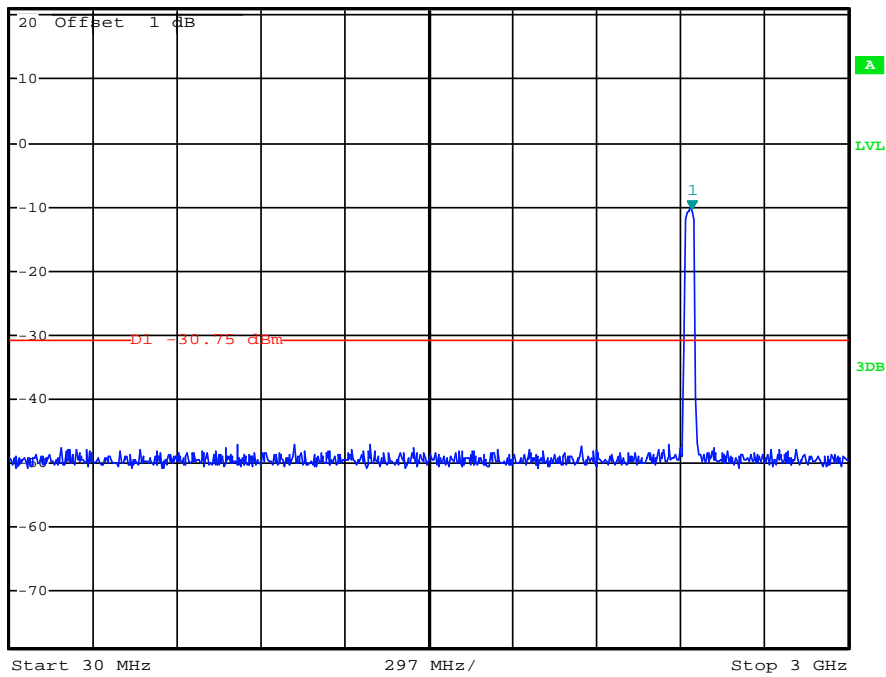

Date: 11.MAR.2014 13:18:53

(Plot 4.6.3 B1: Channel 6: 2437MHz @ 802.11n(20MHz))



*RBW 100 kHz Marker 1 [T1]
*VBW 300 kHz -45.06 dBm
SWT 1.2 s 13.956000000 GHz

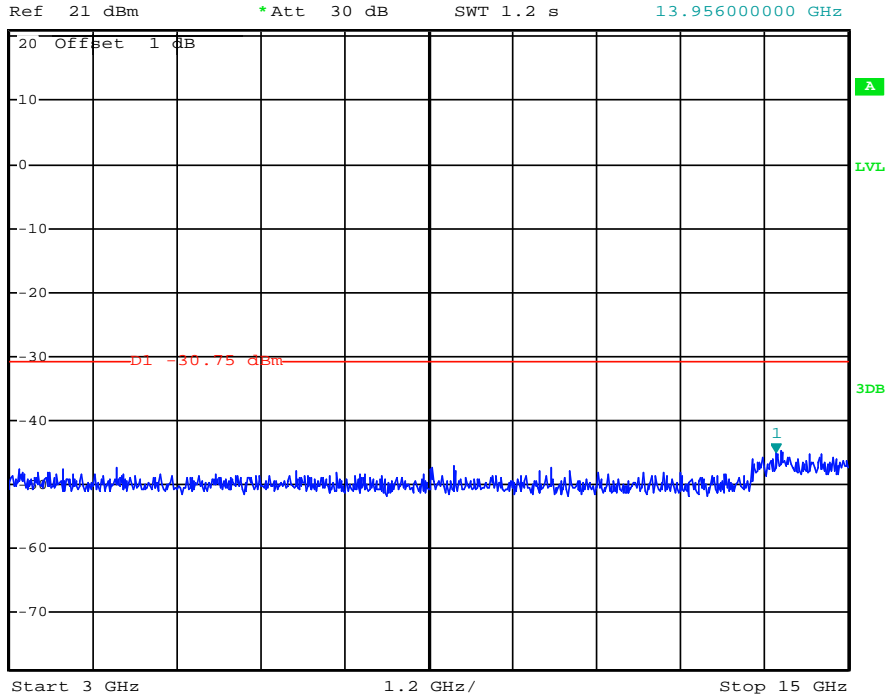

Date: 11.MAR.2014 13:19:05

(Plot 4.6.3 B2: Channel 6: 2437MHz @ 802.11n(20MHz))



*RBW 100 kHz Marker 1 [T1]
*VBW 300 kHz -42.51 dBm
SWT 1 s 23.430000000 GHz

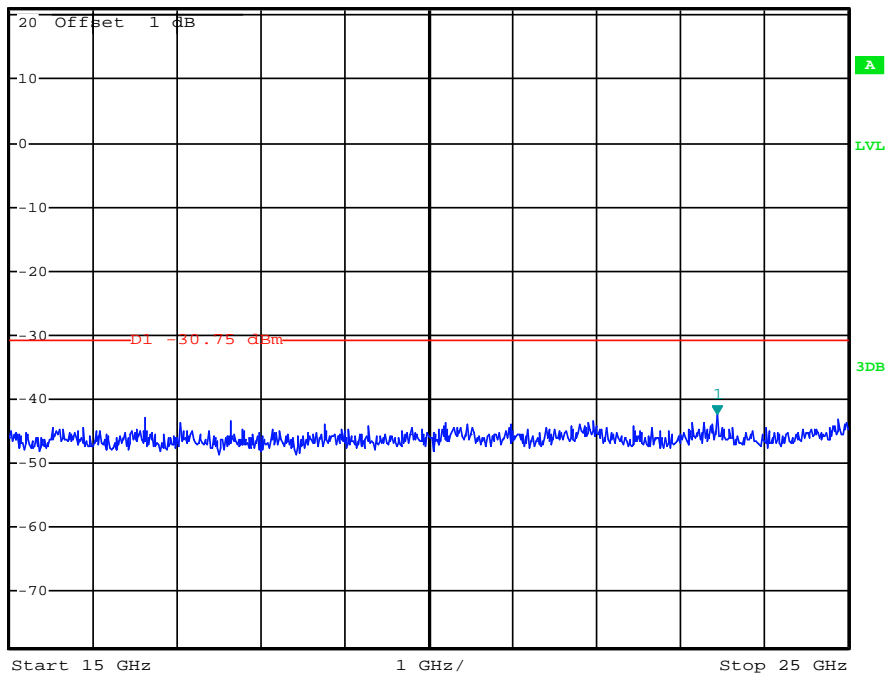

Date: 11.MAR.2014 13:19:19

(Plot 4.6.3 B3: Channel 6: 2437MHz @ 802.11n(20MHz))



*RBW 100 kHz Marker 1 [T1]
*VBW 300 kHz -10.36 dBm
SWT 300 ms 2.456490000 GHz

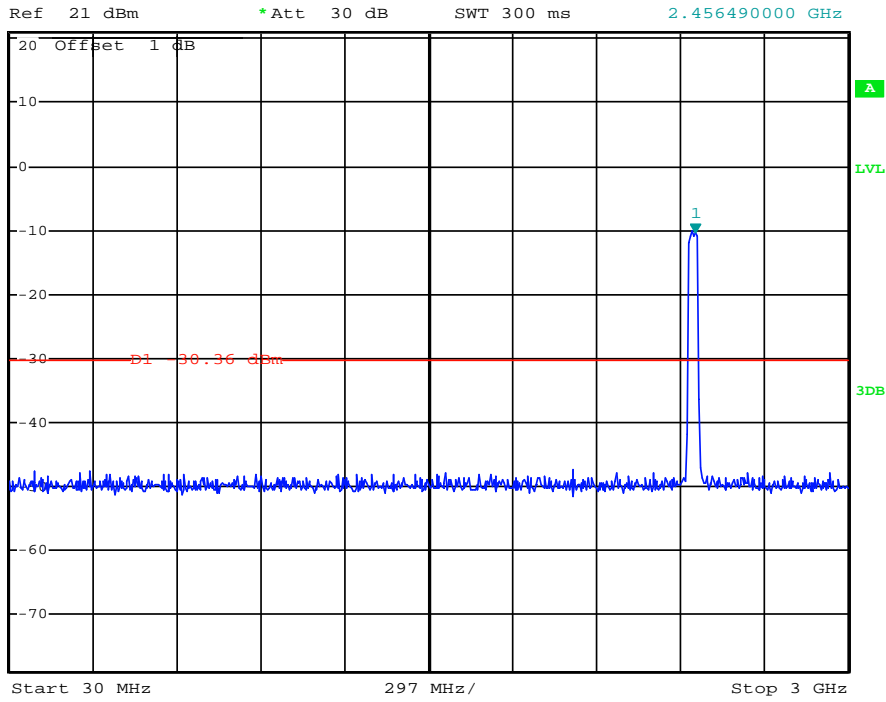

Date: 11.MAR.2014 13:20:07

(Plot 4.6.4 C1: Channel 9: 2452MHz @ 802.11n(20MHz))



*RBW 100 kHz Marker 1 [T1]
*VBW 300 kHz -44.33 dBm
SWT 1.2 s 14.976000000 GHz

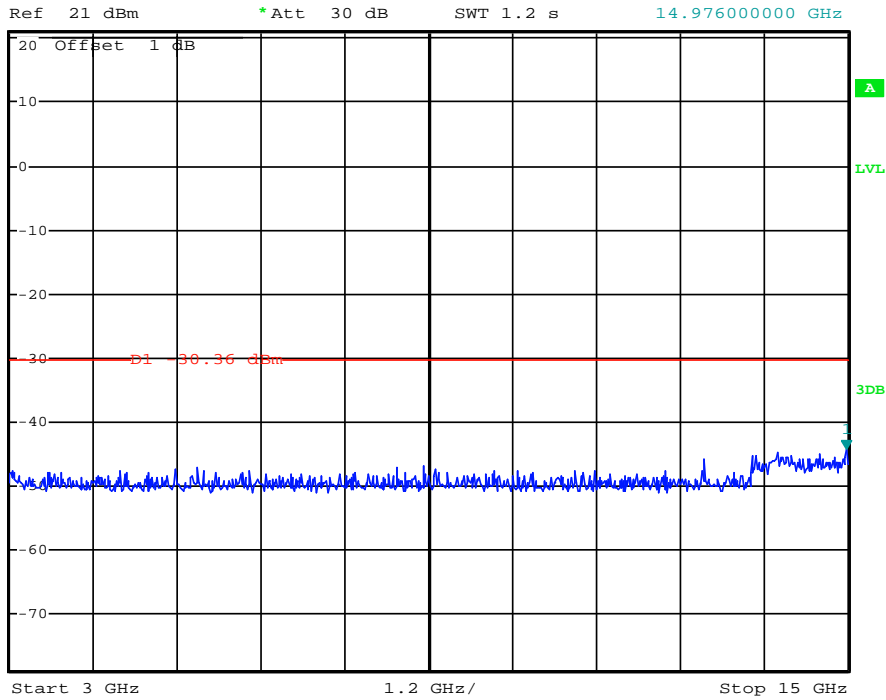

Date: 11.MAR.2014 13:20:25

(Plot 4.6.4 C2: Channel 9: 2452MHz @ 802.11n(20MHz))

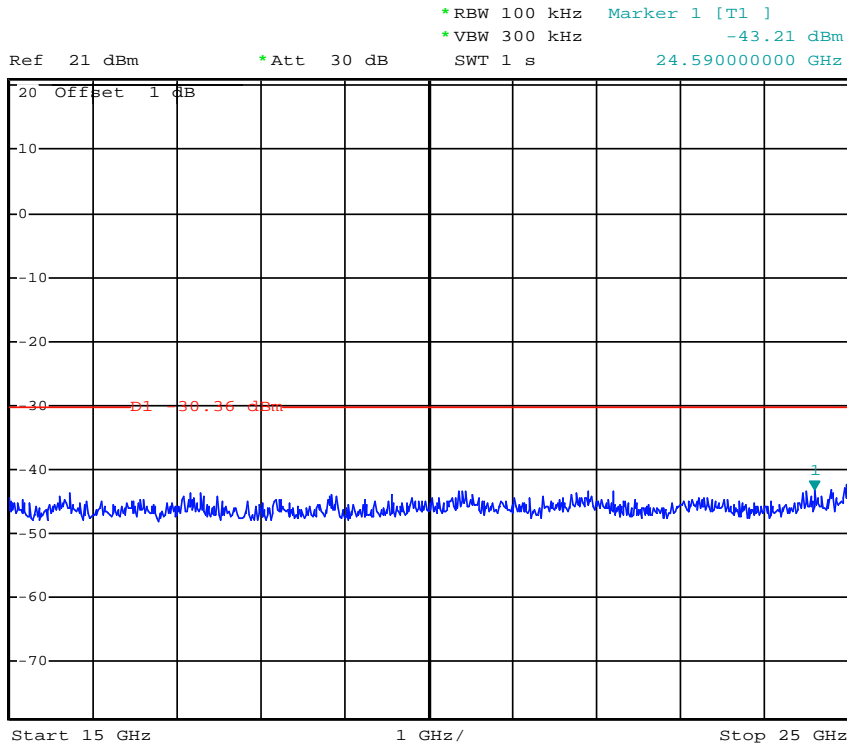

Date: 11.MAR.2014 13:20:40

(Plot 4.6.4 C3: Channel 9: 2452MHz @ 802.11n(20MHz))

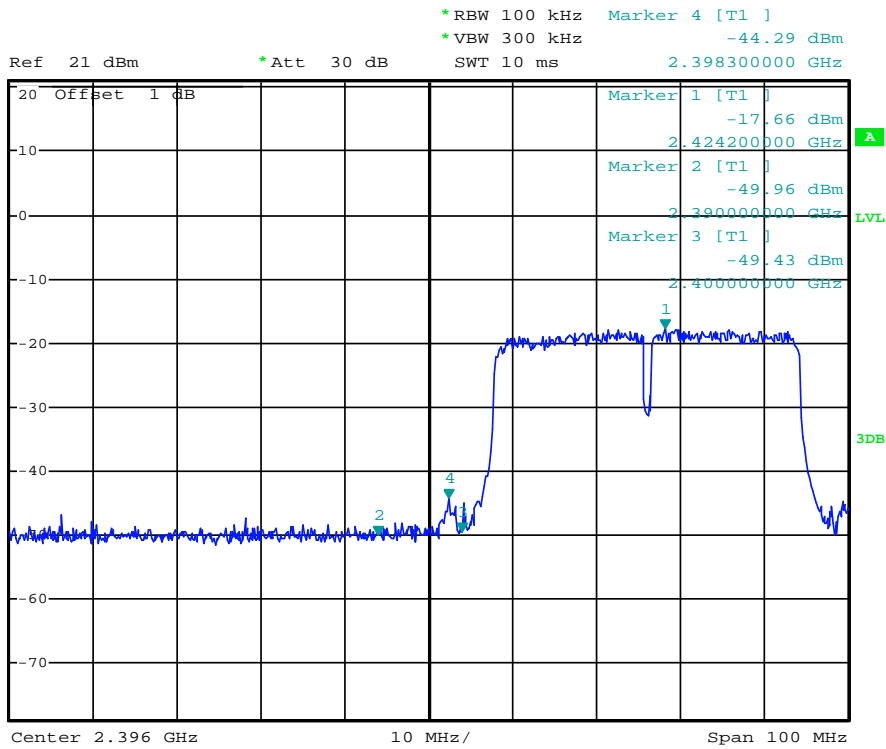

Date: 11.MAR.2014 13:37:03

(Plot 4.6.3 D: Channel 3: 2422MHz @ 802.11n(20MHz))



*RBW 100 kHz Marker 1 [T1]
*VBW 300 kHz -17.45 dBm
SWT 10 ms 2.447300000 GHz

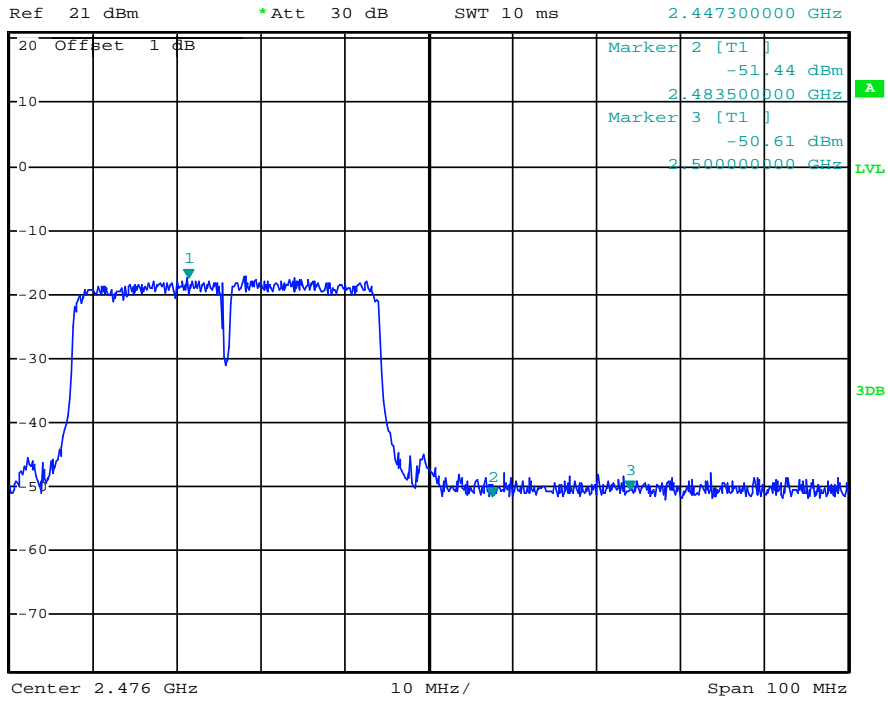

Date: 11.MAR.2014 13:38:55

(Plot 4.6.3 E: Channel 9: 2452MHz @ 802.11n(20MHz))

4.7. 6dB Bandwidth

TEST CONFIGURATION

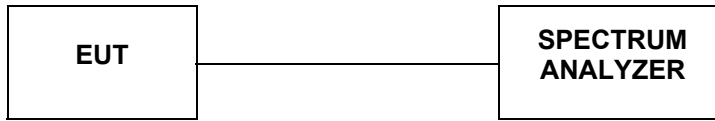

TEST PROCEDURE

The transmitter output was connected to the spectrum analyzer through an attenuator. The bandwidth of the fundamental frequency was measured by spectrum analyzer with 100 KHz RBW and 300KHz VBW. The 6dB bandwidth is defined as the total spectrum the power of which is higher than peak power minus 6dB. According to KDB558074 D01 V03 for one of the following procedures may be used to determine the modulated DTS device signal bandwidth.

1. Set RBW = 100 kHz.
2. Set the video bandwidth (VBW) ≥ 3 RBW.
3. Detector = Peak.
4. Trace mode = max hold.
5. Sweep = auto couple.
6. Allow the trace to stabilize.
7. Measure the maximum width of the emission that is constrained by the frequencies associated with the two outermost amplitude points (upper and lower frequencies) that are attenuated by 6 dB relative to the maximum level measured in the fundamental emission.

LIMIT

For digital modulation systems, the minimum 6 dB bandwidth shall be at least 500 kHz.

TEST RESULTS

4.7.1 801.11b Test Mode

A. Test Verdict

Channel	Frequency (MHz)	6 dB Bandwidth (MHz)	Refer to Plot	Limits (kHz)	Verdict
1	2412	10.08	Plot 4.7.1 A	≥500	PASS
6	2437	10.11	Plot 4.7.1 B	≥500	PASS
11	2462	10.08	Plot 4.7.1 C	≥500	PASS

- Note: 1. For 802.11b mode at final test to get the worst-case emission at 1Mbps.
 2. The test results including the cable loss.

B. Test Plots

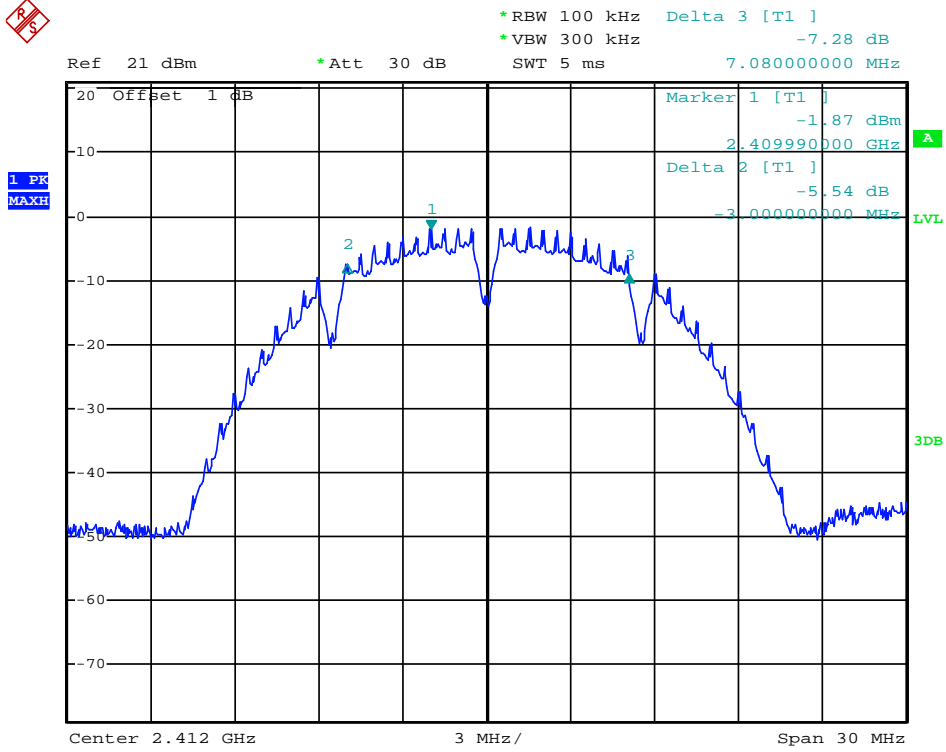

Date: 11.MAR.2014 10:18:32

(Plot 4.7.1 A: Channel 1: 2412MHz @ 802.11b)

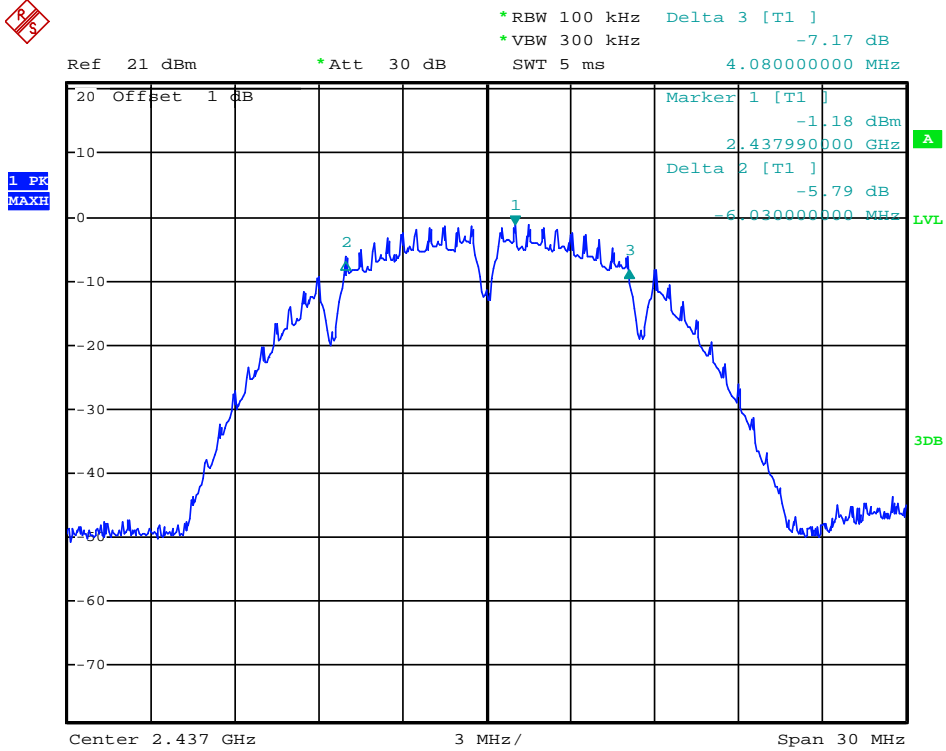

Date: 11.MAR.2014 10:21:04

(Plot 4.7.1 B: Channel 6: 2437MHz @ 802.11b)

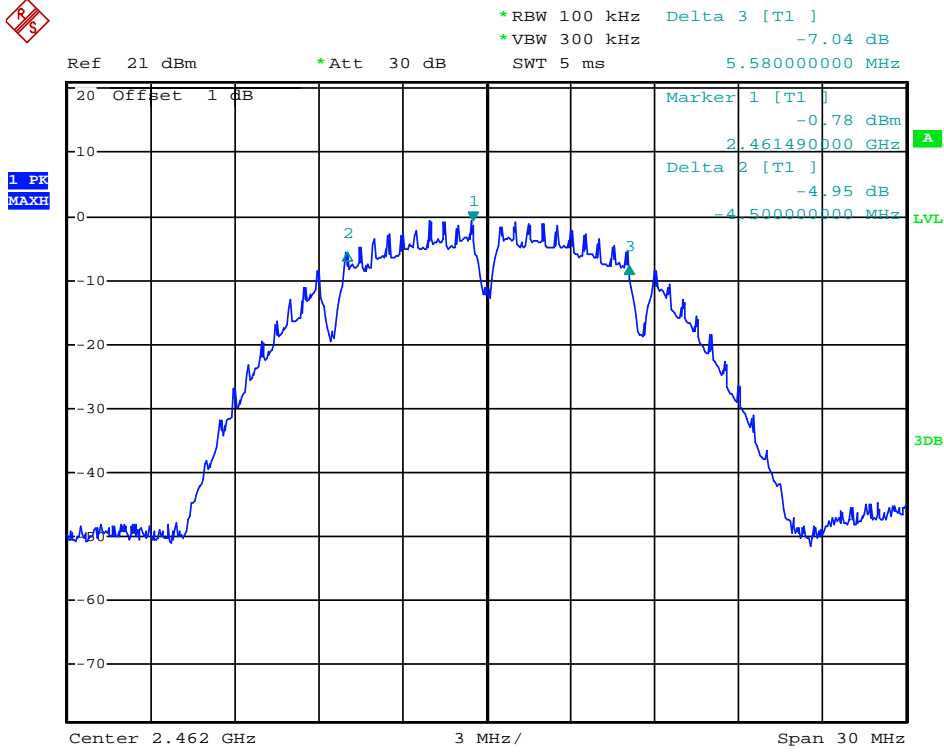

Date: 11.MAR.2014 10:22:14

(Plot 4.7.1 C: Channel 11: 2462MHz @ 802.11b)

4.7.2 801.11g Test Mode

A. Test Verdict

Channel	Frequency (MHz)	6 dB Bandwidth (MHz)	Refer to Plot	Limits (kHz)	Verdict
1	2412	16.56	Plot 4.7.2 A	≥500	PASS
6	2437	15.59	Plot 4.7.2 B	≥500	PASS
11	2462	16.56	Plot 4.7.2 C	≥500	PASS

Note: 1. For 802.11g mode at final test to get the worst-case emission at 6Mbps.
 2. The test results including the cable lose.

B. Test Plots



*RBW 100 kHz Delta 3 [T1]
*VBW 300 kHz -8.38 dB
SWT 5 ms 3.930000000 MHz

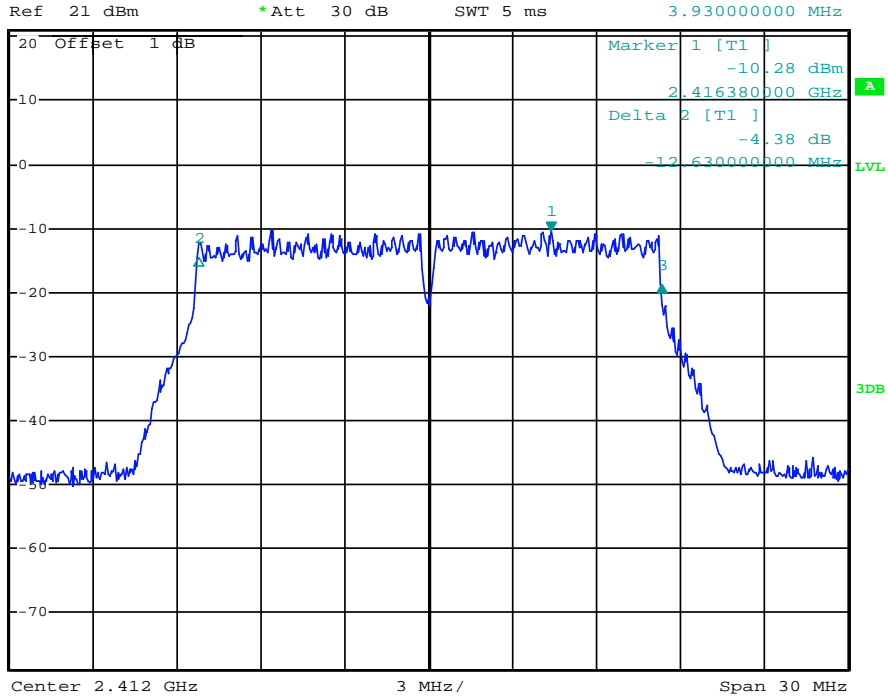

Date: 11.MAR.2014 10:28:51

(Plot 4.7.2 A: Channel 1: 2412MHz @ 802.11g)



*RBW 100 kHz Delta 2 [T1]
*VBW 300 kHz -7.62 dB
SWT 5 ms -2.700000000 MHz

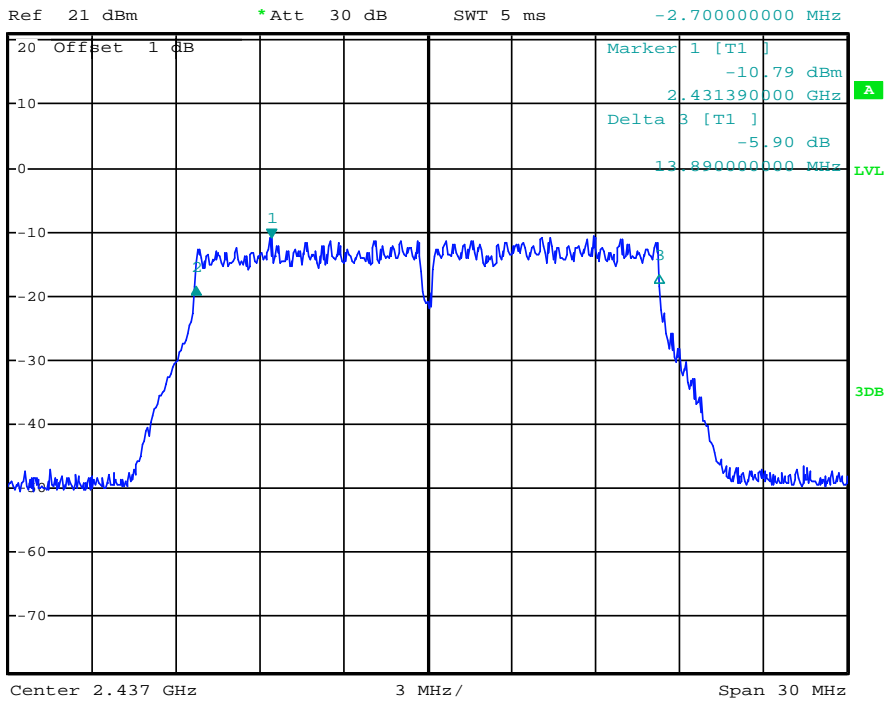

Date: 11.MAR.2014 10:30:07

(Plot 4.7.2 B: Channel 6: 2437MHz @ 802.11g)

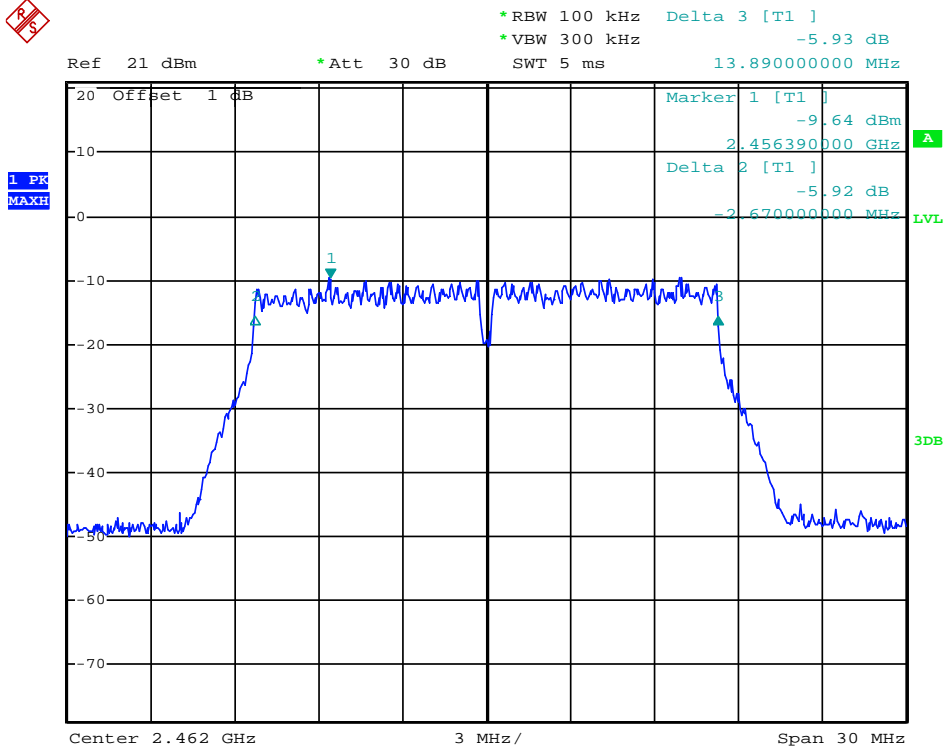

Date: 11.MAR.2014 10:31:54

(Plot 4.7.2 C: Channel 11: 2462MHz @ 802.11g)

4.7.3 801.11n(20MHz) Test Mode

A. Test Verdict

Channel	Frequency (MHz)	6 dB Bandwidth (MHz)	Refer to Plot	Limits (kHz)	Verdict
1	2412	17.82	Plot 4.7.3 A	≥500	PASS
6	2437	17.85	Plot 4.7.3 B	≥500	PASS
11	2462	17.82	Plot 4.7.3 C	≥500	PASS

Note: 1. For 802.11n(20MHz) mode at final test to get the worst-case emission at 6.5Mbps.
 2. The test results including the cable lose.

B. Test Plots

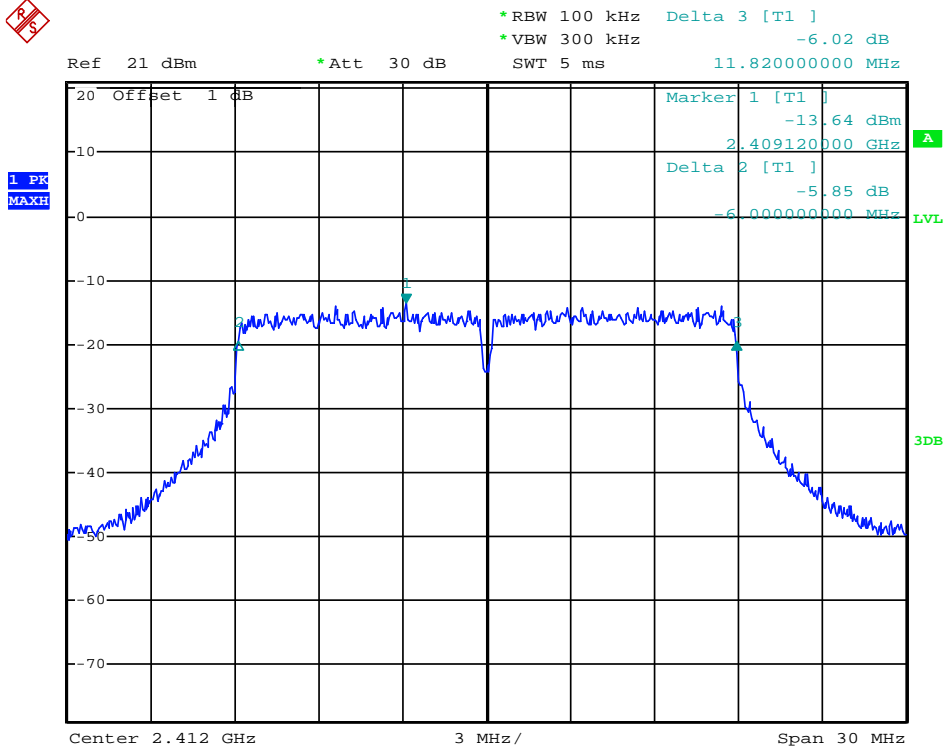

Date: 11.MAR.2014 10:44:52

(Plot 4.7.3 A: Channel 1: 2412MHz @ 802.11n(20MHz))

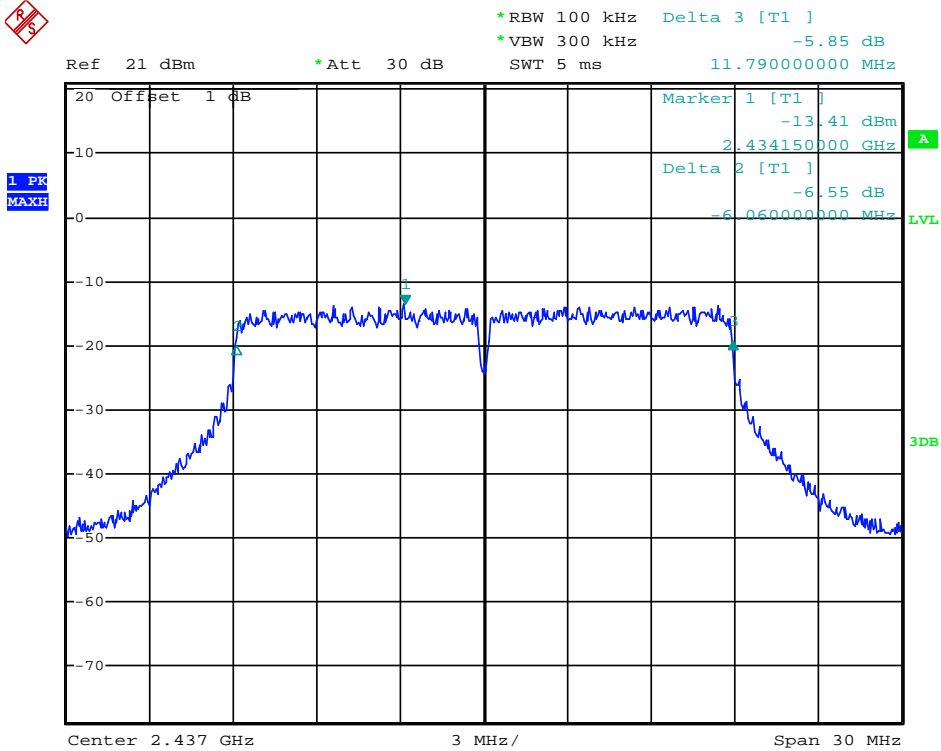

Date: 11.MAR.2014 10:46:10

(Plot 4.7.3 B: Channel 6: 2437MHz @ 802.11n(20MHz))

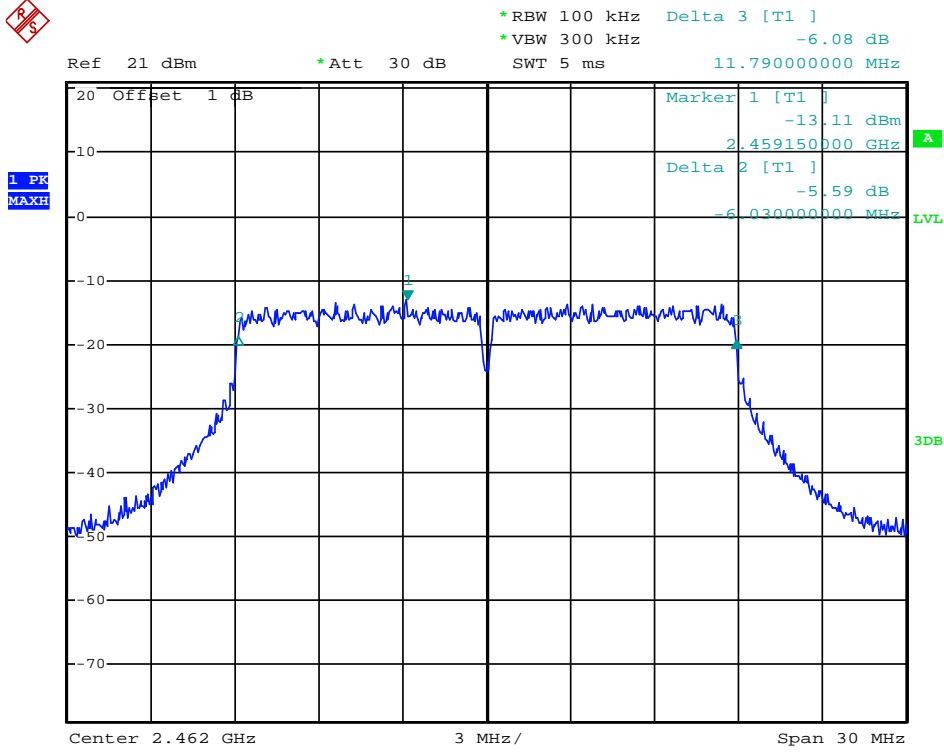

Date: 11.MAR.2014 10:47:19

(Plot 4.7.3 C: Channel 11: 2462MHz @ 802.11n(20MHz))

4.7.4 801.11n(40MHz) Test Mode

A. Test Verdict

Channel	Frequency (MHz)	6 dB Bandwidth (MHz)	Refer to Plot	Limits (kHz)	Verdict
3	2422	36.50	Plot 4.7.3 A	≥500	PASS
6	2437	36.50	Plot 4.7.3 B	≥500	PASS
9	2452	36.50	Plot 4.7.3 C	≥500	PASS

Note: 1. For 802.11n(20MHz) mode at final test to get the worst-case emission at 13.5Mbps.
 2. The test results including the cable lose.

B. Test Plots

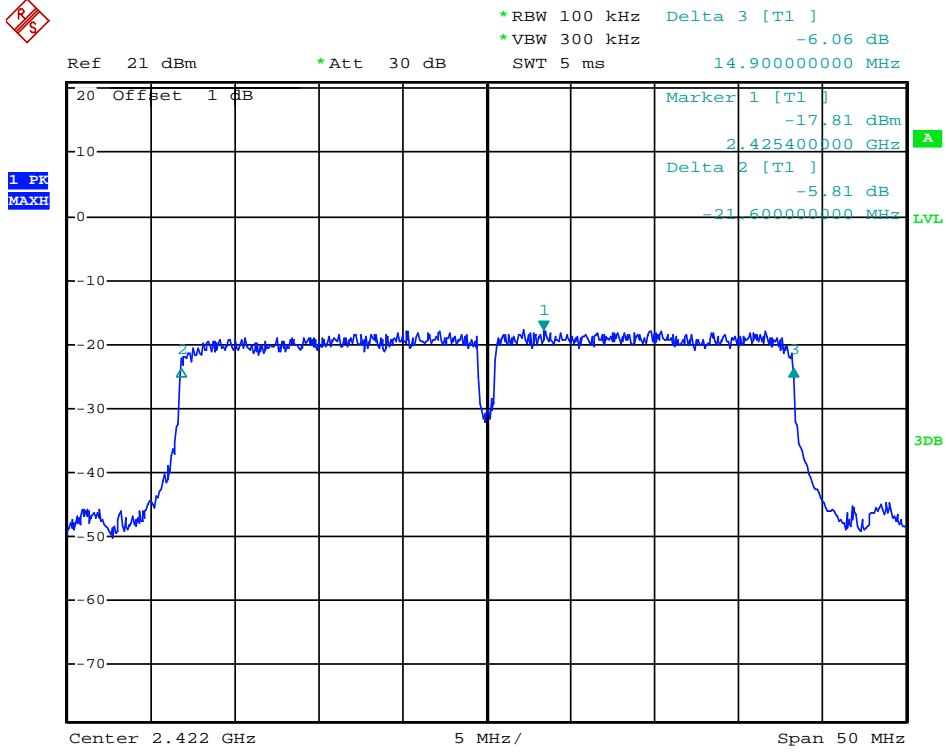

Date: 11.MAR.2014 10:50:38

(Plot 4.7.4 A: Channel 3: 2422MHz @ 802.11n(20MHz))

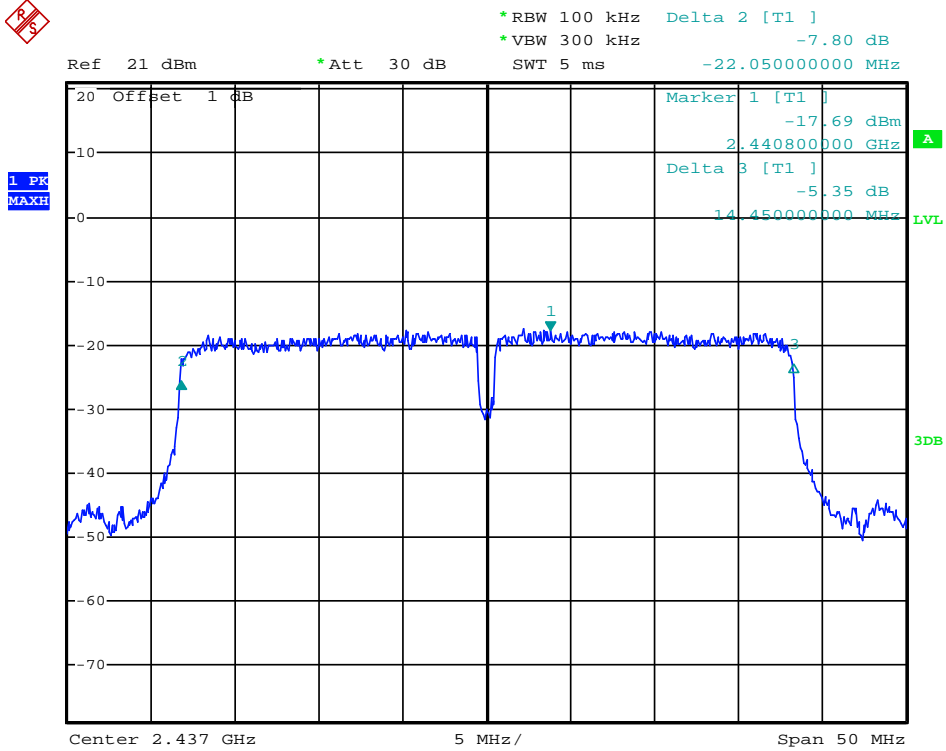

Date: 11.MAR.2014 10:51:49

(Plot 4.7.4 B: Channel 6: 2437MHz @ 802.11n(20MHz))



*RBW 100 kHz Delta 3 [T1]
*VBW 300 kHz -6.86 dB
SWT 5 ms 16.100000000 MHz

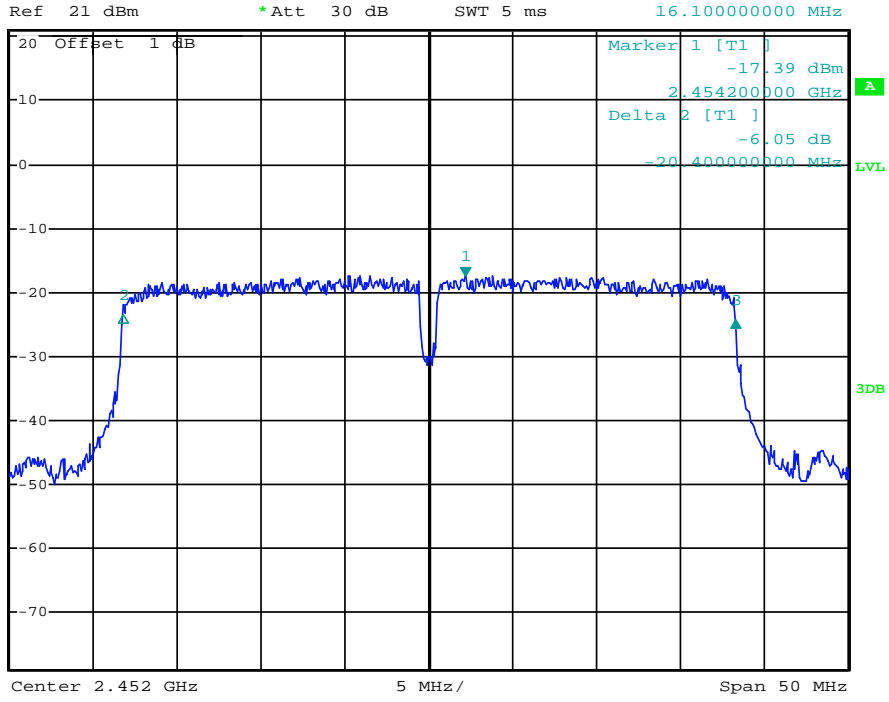

Date: 11.MAR.2014 10:52:44

(Plot 4.7.4 C: Channel 9: 2452MHz @ 802.11n(20MHz))

4.8. Antenna Requirement

Standard Applicable

For intentional device, according to FCC 47 CFR Section 15.203, an intentional radiator shall be designed to ensure that no antenna other than that furnished by the responsible party shall be used with the device.

And according to FCC 47 CFR Section 15.247 (c), if transmitting antennas of directional gain greater than 6dBi are used, the power shall be reduced by the amount in dB that the directional gain of the antenna exceeds 6dBi.

Refer to statement below for compliance

The manufacturer may design the unit so that the user can replace a broken antenna, but the use of a standard antenna jack or electrical connector is prohibited. Further, this requirement does not apply to intentional radiators that must be professionally installed.

Antenna Connected Construction

The maximum antenna gain of WLAN used was 1.28 dBi.

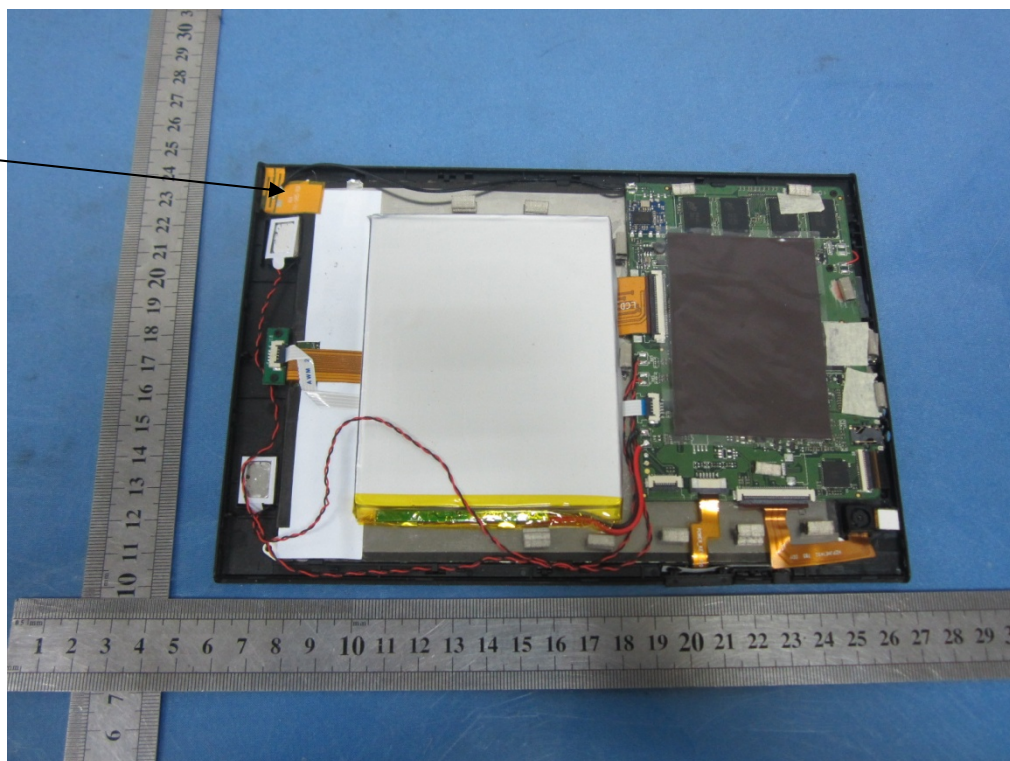

5. Test Setup Photos of the EUT

Radiated Emission (30MHz-1GHz)



Radiated Emission (above 1GHz)

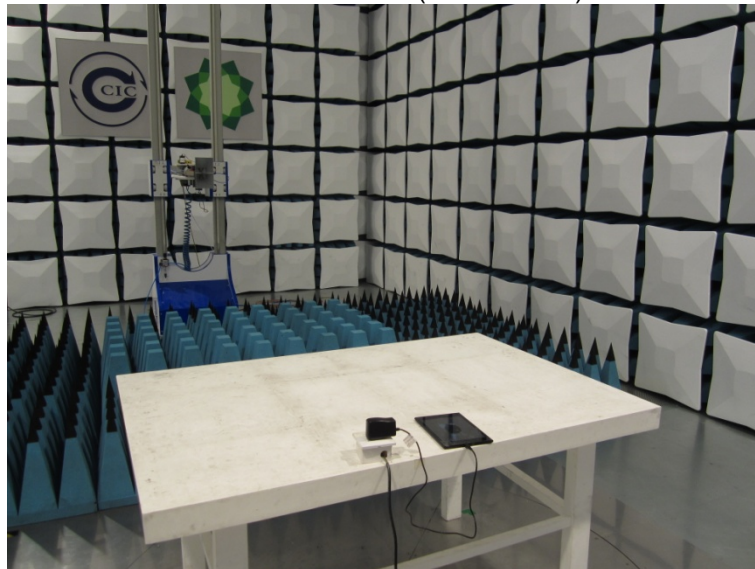

Radiated Emission (Below 30MHz)

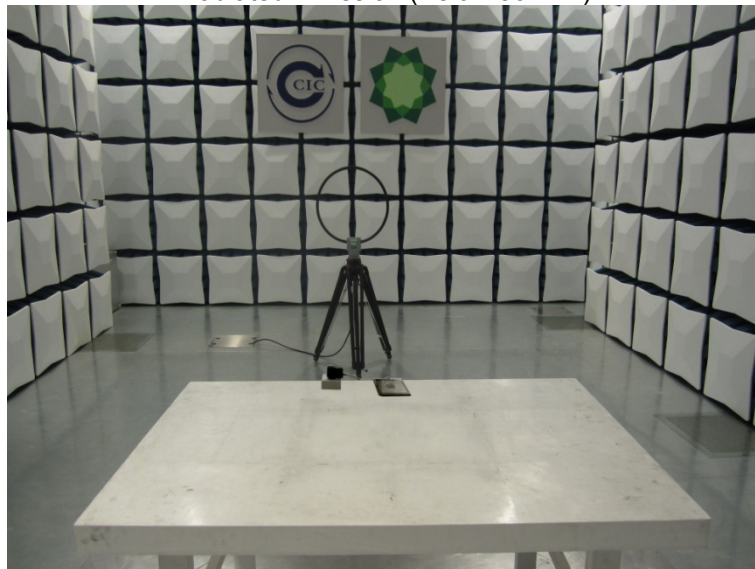

Conducted Emission (AC Mains)



6. External and Internal Photos of the EUT

External Photos



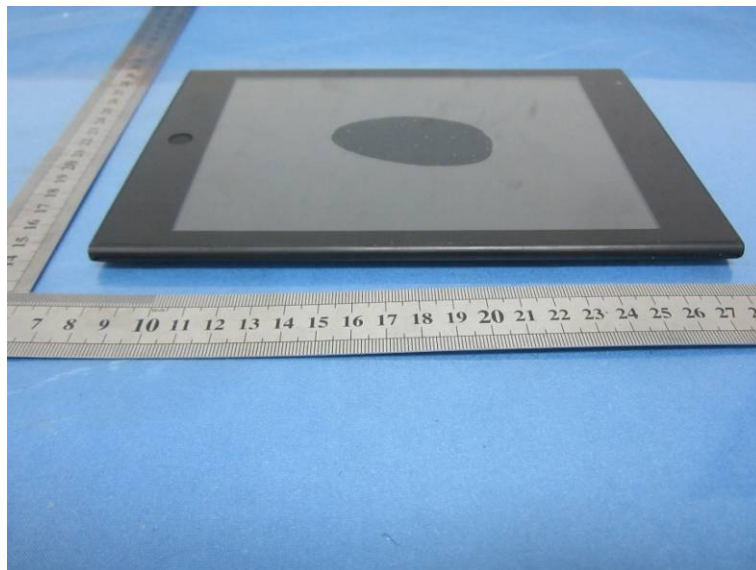
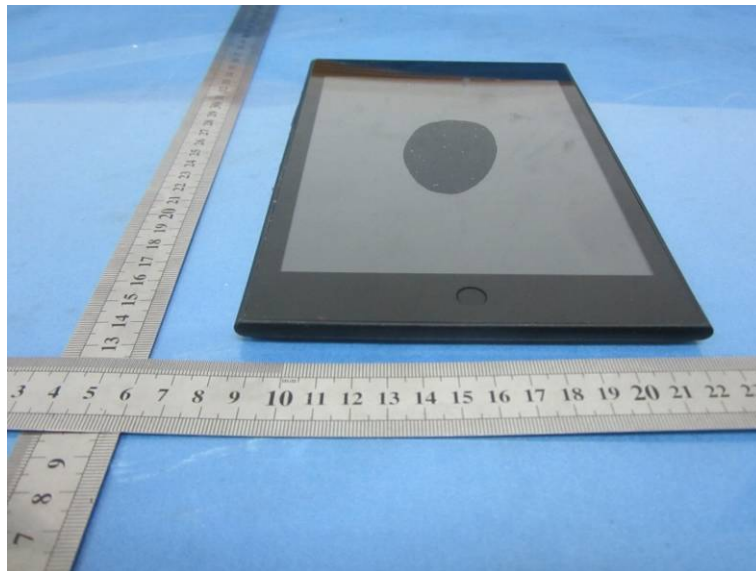
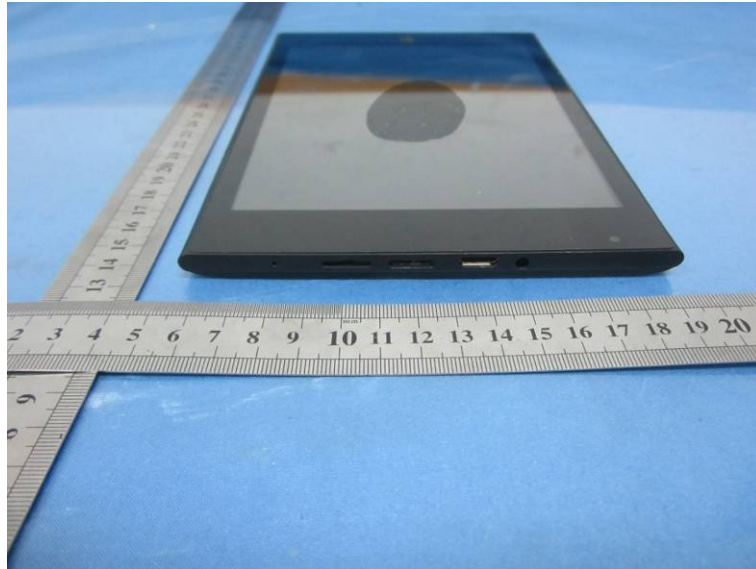

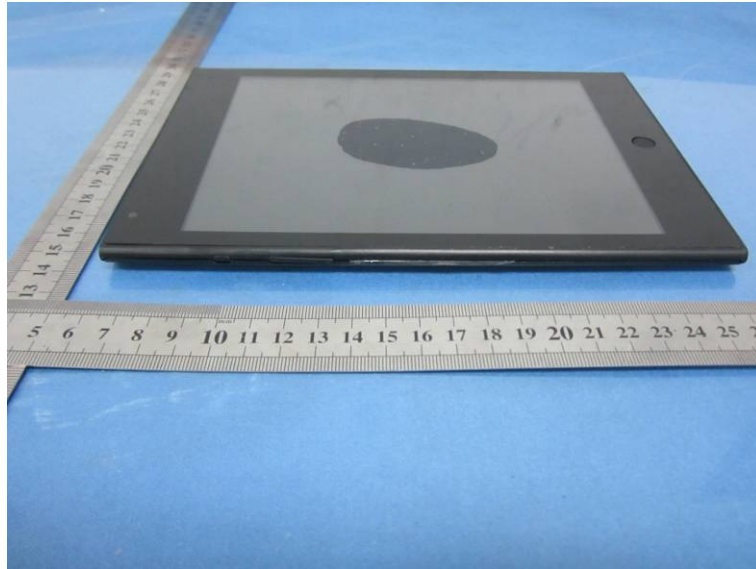

Internal Photos

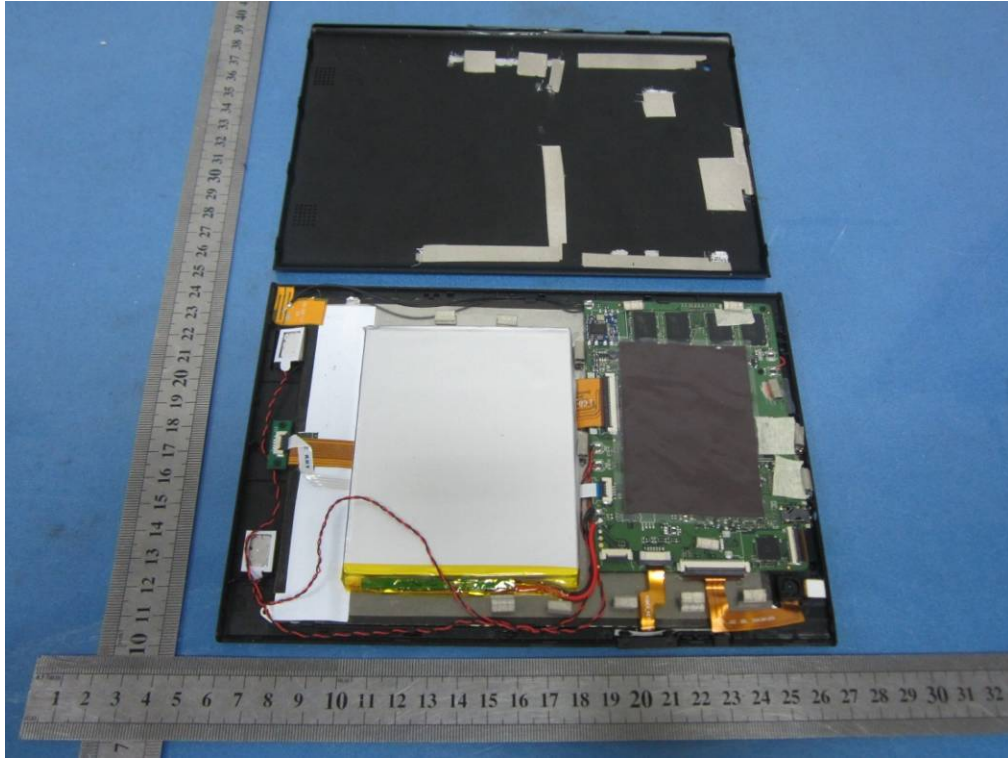

WLAN Antenna

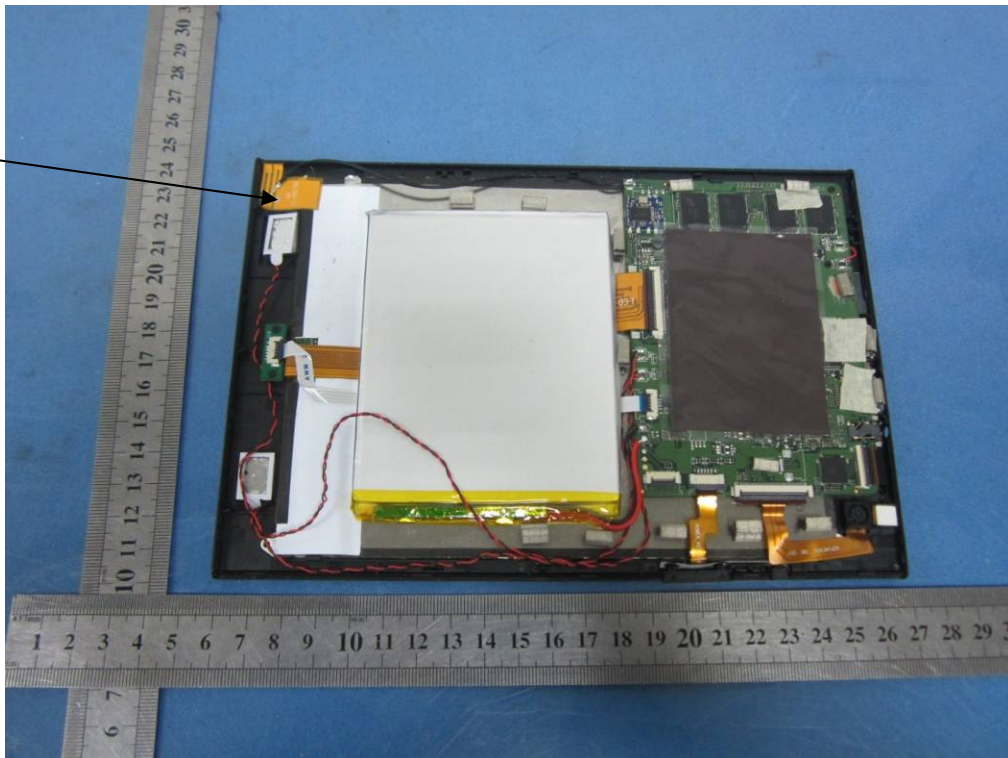

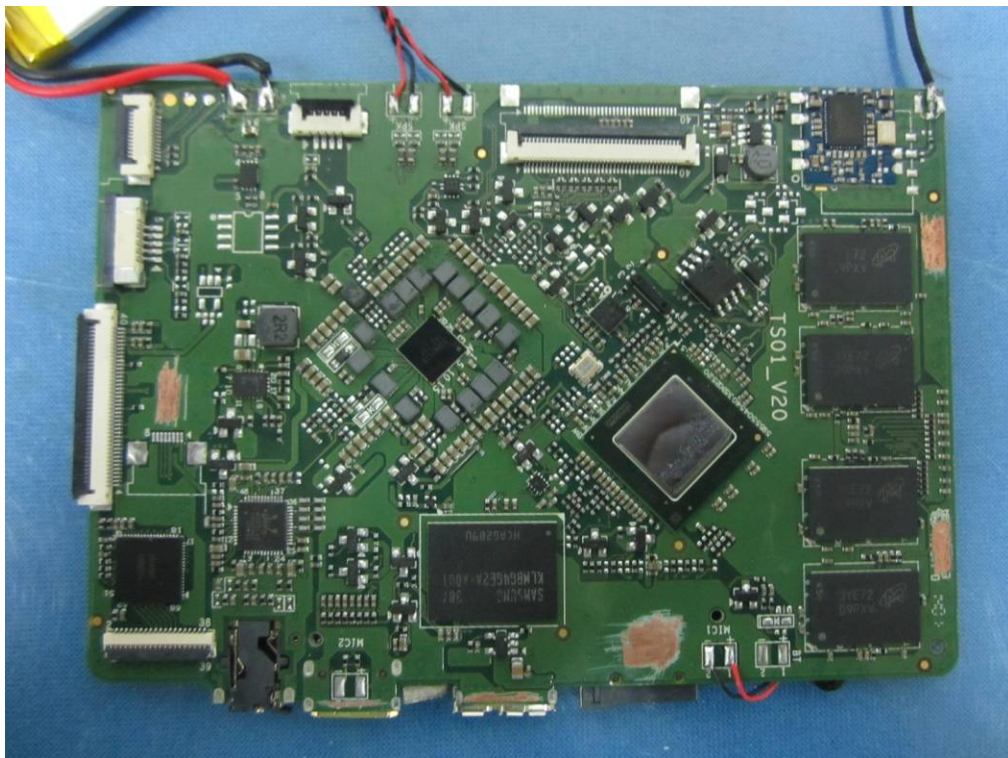
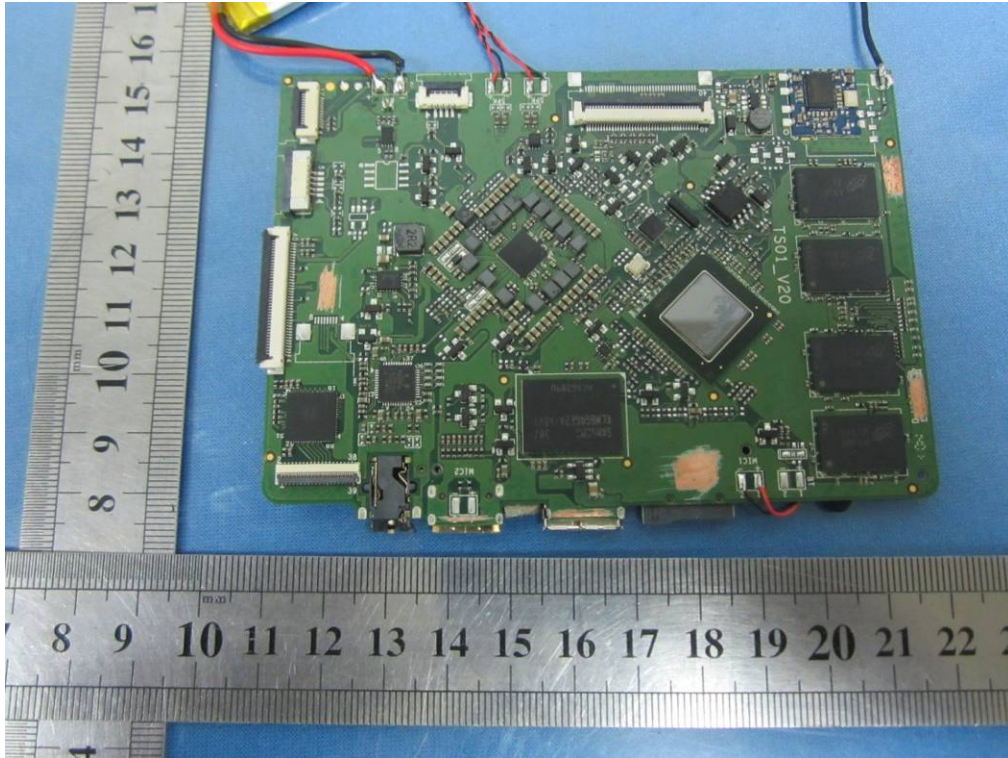

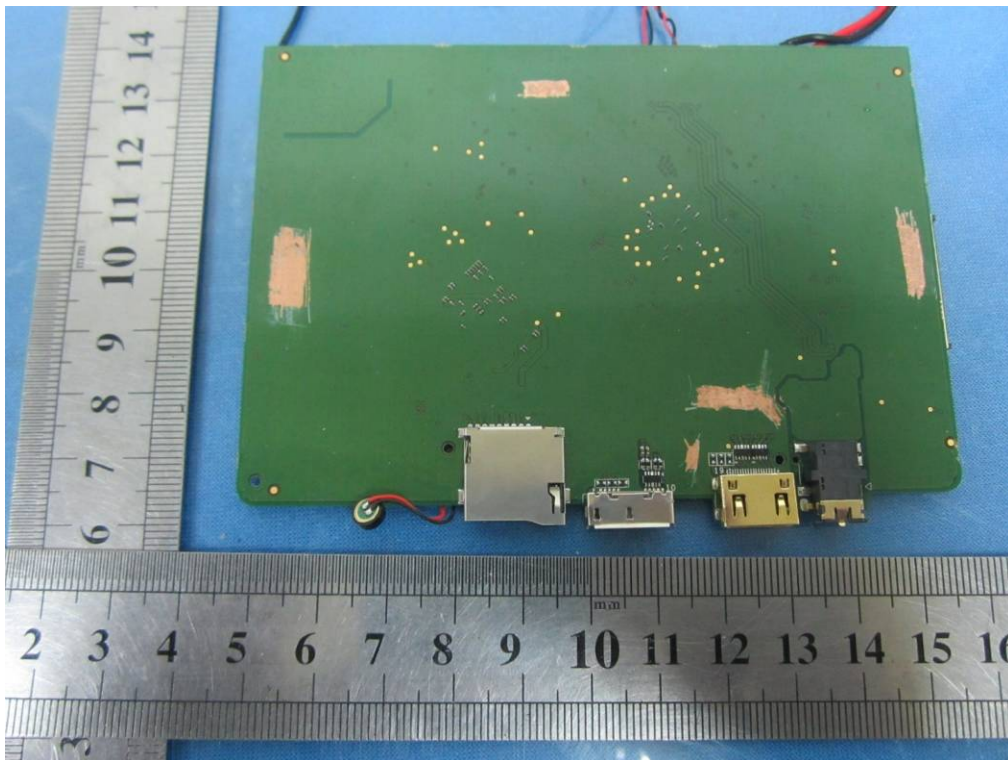
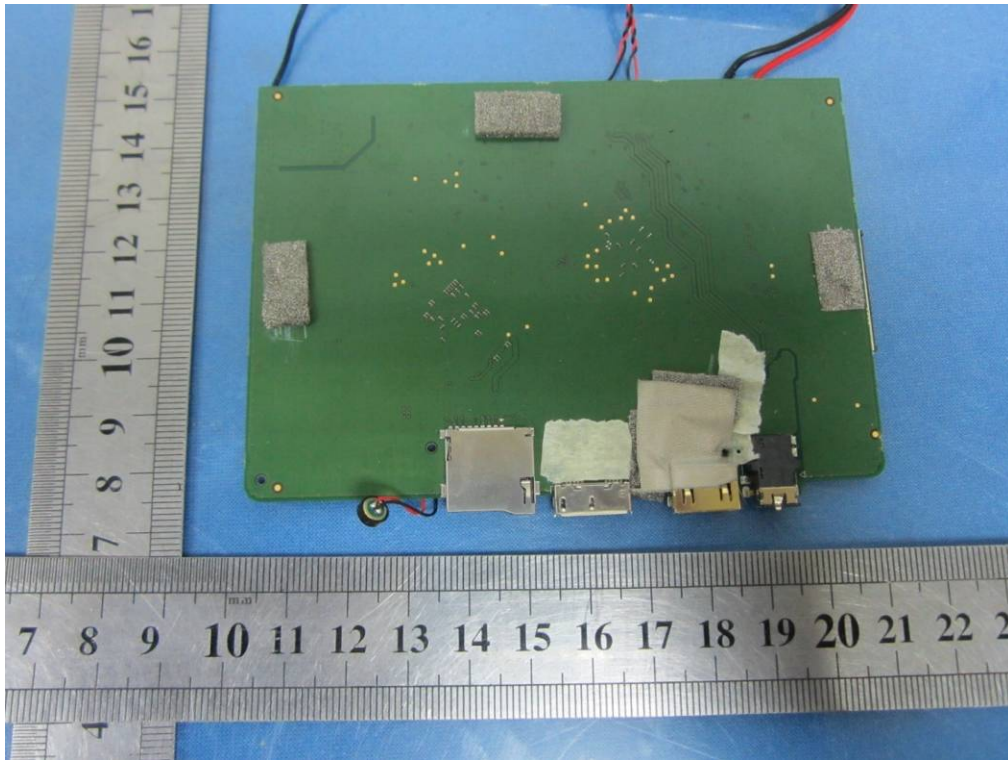

.....End of Report.....