



**CFR 47 FCC PART 15 SUBPART C
ISED RSS-247 ISSUE 2**

CERTIFICATION TEST REPORT

For

Lighting

MODEL NUMBER: 8Zy-A806ST-Q4R

**FCC ID: 2AB2Q8ZA806STQ4R
IC :10256A-8ZA806STQ4R**

REPORT NUMBER: 4788910050.1-3

ISSUE DATE: March 15, 2019

Prepared for

**LEEDARSON LIGHTING CO., LTD.
Xingtai Industrial Zone, Economic Development Zone, Changtai County, Zhangzhou
City, Fujian Province, P.R.China**

Prepared by

**UL Verification Services (Guangzhou) Co., Ltd, Song Shan Lake Branch
Building 10, Innovation Technology Park, No. 1, Li Bin Road,
Song Shan Lake Hi-Tech Development Zone, Dongguan, People's Republic of China
Tel: +86 769-22038881
Fax: +86 769 33244054
Website: www.ul.com**

The results reported herein have been performed in accordance with the laboratory's terms of accreditation. This report shall not be reproduced except in full without the written approval of the Laboratory. The results in this report apply to the test sample(s) mentioned above at the time of the testing period only and are not to be used to indicate applicability to other similar products. This report does not imply that the product(s) has met the criteria for certification.



Revision History

| <u>Rev.</u> | <u>Issue Date</u> | <u>Revisions</u> | <u>Revised By</u> |
|-------------|-------------------|------------------|-------------------|
| V0 | 3/15/2019 | Initial Issue | |



| Summary of Test Results | | | |
|-------------------------|---|---|--------------|
| Clause | Test Items | FCC/IC Rules | Test Results |
| 1 | 6dB Bandwidth and 99% Occupied Bandwidth | FCC Part 15.247 (a) (2) RSS-247 Clause 5.2 (a) ISED RSS-Gen Clause 6.7 | Pass |
| 2 | Peak Conducted Output Power | FCC Part 15.247 (b) (3) RSS-247 Clause 5.4 (e) | Pass |
| 3 | Power Spectral Density | FCC Part 15.247 (e) RSS-247 Clause 5.2 (b) | Pass |
| 4 | Conducted Bandedge and Spurious Emission | FCC Part 15.247 (d) RSS-247 Clause 5.5 | Pass |
| 5 | Radiated Bandedge and Spurious Emission | FCC Part 15.247 (d) FCC Part 15.209 FCC Part 15.205 RSS-247 Clause 5.5 RSS-GEN Clause 8.9 | Pass |
| 6 | Conducted Emission Test For AC Power Port | FCC Part 15.207 RSS-GEN Clause 8.8 | Pass |
| 7 | Antenna Requirement | FCC Part 15.203 RSS-GEN Clause 8.3 | Pass |



TABLE OF CONTENTS

| | |
|--|-----------|
| 1. ATTESTATION OF TEST RESULTS | 6 |
| 2. TEST METHODOLOGY | 7 |
| 3. FACILITIES AND ACCREDITATION | 7 |
| 4. CALIBRATION AND UNCERTAINTY | 8 |
| 4.1. <i>MEASURING INSTRUMENT CALIBRATION</i> | <i>8</i> |
| 4.2. <i>MEASUREMENT UNCERTAINTY.....</i> | <i>8</i> |
| 5. EQUIPMENT UNDER TEST | 9 |
| 5.1. <i>DESCRIPTION OF EUT</i> | <i>9</i> |
| 5.2. <i>MAXIMUM OUTPUT POWER.....</i> | <i>9</i> |
| 5.3. <i>CHANNEL LIST</i> | <i>9</i> |
| 5.4. <i>TEST CHANNEL CONFIGURATION.....</i> | <i>10</i> |
| 5.5. <i>THE WORSE CASE POWER SETTING PARAMETER.....</i> | <i>10</i> |
| 5.6. <i>DESCRIPTION OF AVAILABLE ANTENNAS</i> | <i>10</i> |
| 5.7. <i>TEST ENVIRONMENT</i> | <i>10</i> |
| 5.8. <i>DESCRIPTION OF TEST SETUP.....</i> | <i>11</i> |
| 5.9. <i>MEASURING INSTRUMENT AND SOFTWARE USED.....</i> | <i>12</i> |
| 6. MEASUREMENT METHODS | 13 |
| 7. ANTENNA PORT TEST RESULTS | 14 |
| 7.1. <i>ON TIME AND DUTY CYCLE.....</i> | <i>14</i> |
| 7.2. <i>6 dB DTS BANDWIDTH AND 99% BANDWIDTH</i> | <i>16</i> |
| 7.3. <i>PEAK CONDUCTED OUTPUT POWER.....</i> | <i>22</i> |
| 7.4. <i>POWER SPECTRAL DENSITY</i> | <i>23</i> |
| 7.5. <i>CONDUCTED BANDEDGE AND SPURIOUS EMISSIONS.....</i> | <i>27</i> |
| 8. RADIATED TEST RESULTS..... | 36 |
| 8.1. <i>RESTRICTED BANDEDGE</i> | <i>41</i> |
| 8.2. <i>SPURIOUS EMISSIONS (1~3GHz)</i> | <i>51</i> |
| 8.3. <i>SPURIOUS EMISSIONS (3~18GHz)</i> | <i>59</i> |
| 8.4. <i>SPURIOUS EMISSIONS 18G ~ 26GHz.....</i> | <i>67</i> |
| 8.5. <i>SPURIOUS EMISSIONS 30M ~ 1 GHz</i> | <i>69</i> |
| 8.6. <i>SPURIOUS EMISSIONS BELOW 30M.....</i> | <i>71</i> |
| 9. AC POWER LINE CONDUCTED EMISSIONS | 77 |



10. ANTENNA REQUIREMENTS80



1. ATTESTATION OF TEST RESULTS

Applicant Information

Company Name: LEEDARSON LIGHTING CO., LTD.
Address: Xingtai Industrial Zone, Economic Development Zone, Changtai County, Zhangzhou City, Fujian Province, P.R.China

Manufacturer Information

Company Name: LEEDARSON LIGHTING CO., LTD.
Address: Xingtai Industrial Zone, Economic Development Zone, Changtai County, Zhangzhou City, Fujian Province, P.R.China

EUT Information

EUT Name: Lighting
Model: 8Zy-A806ST-Q4R
Series Model: AE 260
Model Difference: All the same except for the model name.
Sample Status: Normal
Sample Received Date: January 23, 2019
Date of Tested: January 24 ~ March 15, 2019

| APPLICABLE STANDARDS | |
|------------------------------|--------------|
| STANDARD | TEST RESULTS |
| CFR 47 FCC PART 15 SUBPART C | PASS |
| ISED RSS-247 Issue 2 | PASS |
| ISED RSS-GEN Issue 5 | PASS |

Tested By:

Checked By:

Kebo Zhang
Engineer Project Associate

Shawn Wen
Laboratory Leader

Approved By:

Stephen Guo
Laboratory Manager



2. TEST METHODOLOGY

The tests documented in this report were performed in accordance with KDB 558074 D01 15.247 Meas Guidance v05r01, KDB 414788 D01 Radiated Test Site v01r01, CFR 47 FCC Part 2, CFR 47 FCC Part 15, ANSI C63.10-2013, ISED RSS-247 Issue 2 and ISED RSS-GEN Issue 5.

3. FACILITIES AND ACCREDITATION

| | |
|---------------------------|---|
| Accreditation Certificate | <p>A2LA (Certificate No.: 4102.01) UL Verification Services (Guangzhou) Co., Ltd. Song Shan Lake Branch. has been assessed and proved to be in compliance with A2LA.</p> <p>FCC (FCC Designation No.: CN1187) UL Verification Services (Guangzhou) Co., Ltd. Song Shan Lake Branch. Has been recognized to perform compliance testing on equipment subject to the Commission's Declaration of Conformity (DoC) and Certification rules</p> <p>IC(Company No.: 21320) UL Verification Services (Guangzhou) Co., Ltd. Song Shan Lake Branch. has been registered and fully described in a report filed with ISED. The Company Number is 21320.</p> <p>VCCI (Registration No.: G-20019, R-20004, C-20012 and T-20011) UL Verification Services (Guangzhou) Co., Ltd. Song Shan Lake Branch. has been assessed and proved to be in compliance with VCCI, the Membership No. is 3793. Facility Name: Chamber D, the VCCI registration No. is G-20019 and R-20004 Shielding Room B , the VCCI registration No. is C-20012 and T-20011</p> |
|---------------------------|---|

Note 1: All tests measurement facilities use to collect the measurement data are located at Building 10, Innovation Technology Park, Song Shan Lake Hi tech Development Zone, Dongguan, 523808, China

Note 2: The test anechoic chamber in UL Verification Services (Guangzhou) Co., Ltd. Song Shan Lake Branch had been calibrated and compared to the open field sites and the test anechoic chamber is shown to be equivalent to or worst case from the open field site.

Note 3: For below 30MHz, lab had performed measurements at test anechoic chamber and comparing to measurements obtained on an open field site. And these measurements below 30MHz had been correlated to measurements performed on an OFS.



4. CALIBRATION AND UNCERTAINTY

4.1. MEASURING INSTRUMENT CALIBRATION

The measuring equipment utilized to perform the tests documented in this report has been calibrated in accordance with the manufacturer's recommendations, and is traceable to recognize national standards.

4.2. MEASUREMENT UNCERTAINTY

Where relevant, the following measurement uncertainty levels have been estimated for tests performed on the apparatus:

| Test Item | Uncertainty |
|---|---------------------|
| Conduction emission | 3.62dB |
| Radiation Emission test(include Fundamental emission) (9kHz-30MHz) | 2.2dB |
| Radiation Emission test(include Fundamental emission) (30MHz-1GHz) | 4.00dB |
| Radiation Emission test (1GHz to 26GHz)(include Fundamental emission) | 5.78dB (1GHz-18Gz) |
| | 5.23dB (18GHz-26Gz) |
| Note: This uncertainty represents an expanded uncertainty expressed at approximately the 95% confidence level using a coverage factor of k=2. | |



5. EQUIPMENT UNDER TEST

5.1. DESCRIPTION OF EUT

| | | | |
|---------------------|---|---------------------|--|
| EUT Name | Lighting | | |
| Model | 8Zy-A806ST-Q4R | | |
| Series Model: | AE 260 | | |
| Model Difference: | All the same except for the model name. | | |
| Product Description | Operation Frequency | 2405 MHz ~ 2480 MHz | |
| | Modulation Type | Data Rate | |
| | O-QPSK | 250kbps | |
| Power supply | AC 120V,60Hz | | |

5.2. MAXIMUM OUTPUT POWER

| Mode | Frequency (MHz) | Channel Number | Max Output Power (dBm) |
|--------|-----------------|----------------|------------------------|
| ZigBee | 2405-2480 | 11-26 [16] | 11.29 |

5.3. CHANNEL LIST

| Channel | Frequency (MHz) | Channel | Frequency (MHz) | Channel | Frequency (MHz) | Channel | Frequency (MHz) |
|---------|-----------------|---------|-----------------|---------|-----------------|---------|-----------------|
| 11 | 2405 | 15 | 2425 | 19 | 2445 | 23 | 2465 |
| 12 | 2410 | 16 | 2430 | 20 | 2450 | 24 | 2470 |
| 13 | 2415 | 17 | 2435 | 21 | 2455 | 25 | 2475 |
| 14 | 2420 | 18 | 2440 | 22 | 2460 | 26 | 2480 |



5.4. TEST CHANNEL CONFIGURATION

| Test Mode | Test Channel | Frequency |
|-----------|----------------------------|------------------------------------|
| ZigBee | CH 11, CH 19, CH 25, CH 26 | 2405MHz, 2445MHz, 2475MHz, 2480MHz |

5.5. THE WORSE CASE POWER SETTING PARAMETER

| The Worst Case Power Setting Parameter under 2400 ~ 2483.5MHz Band | | | | | |
|--|-------------------------|--------------|-------|-------|-------|
| Test Software | | UartAssis | | | |
| Modulation Type | Transmit Antenna Number | Test Channel | | | |
| | | CH 11 | CH 19 | CH 25 | CH 26 |
| O-QPSK | 1 | 10 | 10 | 10 | 7 |

5.6. DESCRIPTION OF AVAILABLE ANTENNAS

| Ant. | Frequency (MHz) | Antenna Type | Antenna Gain (dBi) |
|------|-----------------|------------------|--------------------|
| 1 | 2405-2480 | Internal Antenna | -0.8 |

| Test Mode | Transmit and Receive Mode | Description |
|-----------|--|--|
| ZigBee | <input checked="" type="checkbox"/> 1TX, 1RX | Chain 1 can be used as transmitting/receiving antenna. |

5.7. TEST ENVIRONMENT

| Environment Parameter | Selected Values During Tests | |
|-----------------------|------------------------------|--------------|
| Relative Humidity | 40 ~ 60% | |
| Atmospheric Pressure: | 1025Pa | |
| Temperature | TN | 22 ~ 28°C |
| Voltage : | VL | N/A |
| | VN | AC 120V,60Hz |
| | VH | N/A |

Note: VL= Lower Extreme Test Voltage
VN= Nominal Voltage
VH= Upper Extreme Test Voltage
TN= Normal Temperature

5.8. DESCRIPTION OF TEST SETUP

SUPPORT EQUIPMENT

| Item | Equipment | Brand Name | Model Name | P/N |
|------|--------------|------------|------------|---------------|
| 1 | Laptop | ThinkPad | T460S | SL10K24796 JS |
| 2 | USB TO RS232 | / | / | / |

I/O CABLES

| Cable No | Port | Connector Type | Cable Type | Cable Length(m) | Remarks |
|----------|------|----------------|------------|-----------------|---------|
| 1 | USB | N/A | N/A | 1 | N/A |

ACCESSORY

| Item | Accessory | Brand Name | Model Name | Description |
|------|-----------|------------|------------|-------------|
| 1 | N/A | N/A | N/A | N/A |

TEST SETUP

The EUT can work in an engineer mode with a software through a PC.

SETUP DIAGRAM FOR TEST

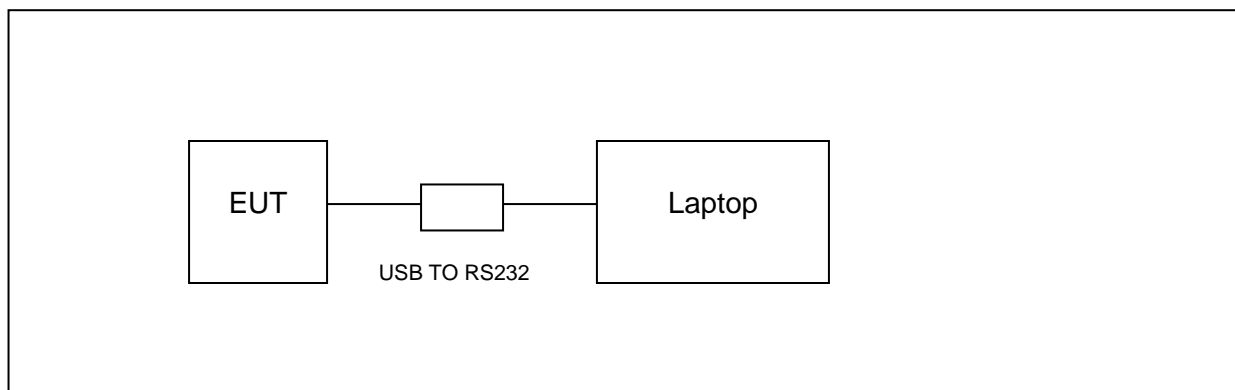



5.9. MEASURING INSTRUMENT AND SOFTWARE USED

| Conducted Emissions | | | | | | |
|-------------------------------------|---|--------------|---|-------------------|--------------|--------------|
| Instrument | | | | | | |
| Used | Equipment | Manufacturer | Model No. | Serial No. | Last Cal. | Next Cal. |
| <input checked="" type="checkbox"/> | EMI Test Receiver | R&S | ESR3 | 101961 | Dec.10,2018 | Dec.10,2019 |
| <input checked="" type="checkbox"/> | Two-Line V- Network | R&S | ENV216 | 101983 | Dec.10,2018 | Dec.10,2019 |
| <input checked="" type="checkbox"/> | Artificial Mains Networks | Schwarzbeck | NSLK 8126 | 8126465 | Dec.10,2018 | Dec.10,2019 |
| Software | | | | | | |
| Used | Description | Manufacturer | Name | Version | | |
| <input checked="" type="checkbox"/> | Test Software for Conducted disturbance | Farad | EZ-EMC | Ver. UL-3A1 | | |
| Radiated Emissions | | | | | | |
| Instrument | | | | | | |
| Used | Equipment | Manufacturer | Model No. | Serial No. | Last Cal. | Next Cal. |
| <input checked="" type="checkbox"/> | MXE EMI Receiver | KESIGHT | N9038A | MY56400036 | Dec.10,2018 | Dec.10,2019 |
| <input checked="" type="checkbox"/> | Hybrid Log Periodic Antenna | TDK | HLP-3003C | 130960 | Sep.17, 2018 | Sep.17, 2021 |
| <input checked="" type="checkbox"/> | Preamplifier | HP | 8447D | 2944A09099 | Dec.10,2018 | Dec.10,2019 |
| <input checked="" type="checkbox"/> | EMI Measurement Receiver | R&S | ESR26 | 101377 | Dec.10,2018 | Dec.10,2019 |
| <input checked="" type="checkbox"/> | Horn Antenna | TDK | HRN-0118 | 130939 | Sep.17, 2018 | Sep.17, 2021 |
| <input checked="" type="checkbox"/> | High Gain Horn Antenna | Schwarzbeck | BBHA-9170 | 691 | Aug.11, 2018 | Aug.11, 2021 |
| <input checked="" type="checkbox"/> | Preamplifier | TDK | PA-02-0118 | TRS-305- 00066 | Dec.10,2018 | Dec.10,2019 |
| <input checked="" type="checkbox"/> | Preamplifier | TDK | PA-02-2 | TRS-307- 00003 | Dec.10,2018 | Dec.10,2019 |
| <input checked="" type="checkbox"/> | Loop antenna | Schwarzbeck | 1519B | 00008 | Mar.26,2016 | Mar.25, 2019 |
| <input checked="" type="checkbox"/> | Band Reject Filter | Wainwright | WRCJV8- 2350-2400- 2483.5- 2533.5- 40SS | 4 | Dec.10, 2018 | Dec.10, 2019 |
| <input checked="" type="checkbox"/> | High Pass Filter | Wi | WHKX10- 2700-3000- 18000-40SS | 23 | Dec.10,2018 | Dec.10,2019 |
| Software | | | | | | |
| Used | Description | Manufacturer | Name | Version | | |
| <input checked="" type="checkbox"/> | Test Software for Radiated disturbance | Farad | EZ-EMC | Ver. UL-3A1 | | |



| Other instruments | | | | | | |
|-------------------------------------|-------------------|--------------|-----------|------------|-------------|-------------|
| Used | Equipment | Manufacturer | Model No. | Serial No. | Last Cal. | Next Cal. |
| <input checked="" type="checkbox"/> | Spectrum Analyzer | Keysight | N9030A | MY55410512 | Dec.10,2018 | Dec.10,2019 |
| <input checked="" type="checkbox"/> | Power Meter | Keysight | N9031A | MY55416024 | Dec.10,2018 | Dec.10,2019 |
| <input checked="" type="checkbox"/> | Power Sensor | Keysight | N9323A | MY55440013 | Dec.10,2018 | Dec.10,2019 |

6. MEASUREMENT METHODS

| No. | Test Item | KDB Name | Section |
|-----|---|--|---------|
| 1 | 6 dB Bandwidth | KDB 558074 D01 15.247 Meas Guidance v05r01 | 8.2 |
| 2 | Peak Output Power | KDB 558074 D01 15.247 Meas Guidance v05r01 | 8.3.1.3 |
| 3 | Power Spectral Density | KDB 558074 D01 15.247 Meas Guidance v05r01 | 8.4 |
| 4 | Out-of-band emissions in non-restricted bands | KDB 558074 D01 15.247 Meas Guidance v05r01 | 8.5 |
| 5 | Out-of-band emissions in restricted bands | KDB 558074 D01 15.247 Meas Guidance v05r01 | 8.6 |
| 6 | Band-edge | KDB 558074 D01 15.247 Meas Guidance v05r01 | 8.7 |
| 7 | Conducted Emission Test For AC Power Port | ANSI C63.10-2013 | 6.2 |
| 8 | 99% Bandwidth | ANSI C63.10-2013 | 6.9.3 |



7. ANTENNA PORT TEST RESULTS

7.1. ON TIME AND DUTY CYCLE

LIMITS

None; for reporting purposes only

PROCEDURE

KDB 558074 Zero-Span Spectrum Analyzer Method

TEST SETUP

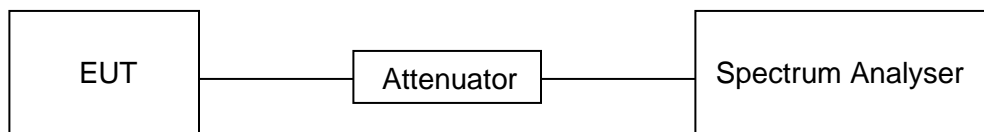

TEST ENVIRONMENT

| | | | |
|---------------------|--------|-------------------|--------------|
| Temperature | 23.5°C | Relative Humidity | 57% |
| Atmosphere Pressure | 101kPa | Test Voltage | AC 120V,60HZ |

RESULTS

| Mode | On Time (msec) | Period (msec) | Duty Cycle x (Linear) | Duty Cycle (%) | Duty Cycle Correction Factor (db) | 1/T Minimum VBW (kHz) | Final setting For VBW (kHz) |
|--------|----------------|---------------|-----------------------|----------------|-----------------------------------|-----------------------|-----------------------------|
| ZigBee | 2.80 | 21.12 | 0.133 | 13.3 | 8.761 | 0.357 | 0.500 |

Note:

Duty Cycle Correction Factor=10log(1/x).

Where: x is Duty Cycle(Linear)

Where: T is On Time (transmit duration)

If that calculated VBW is not available on the analyzer then the next higher value should be used.



ON TIME AND DUTY CYCLE MID CH

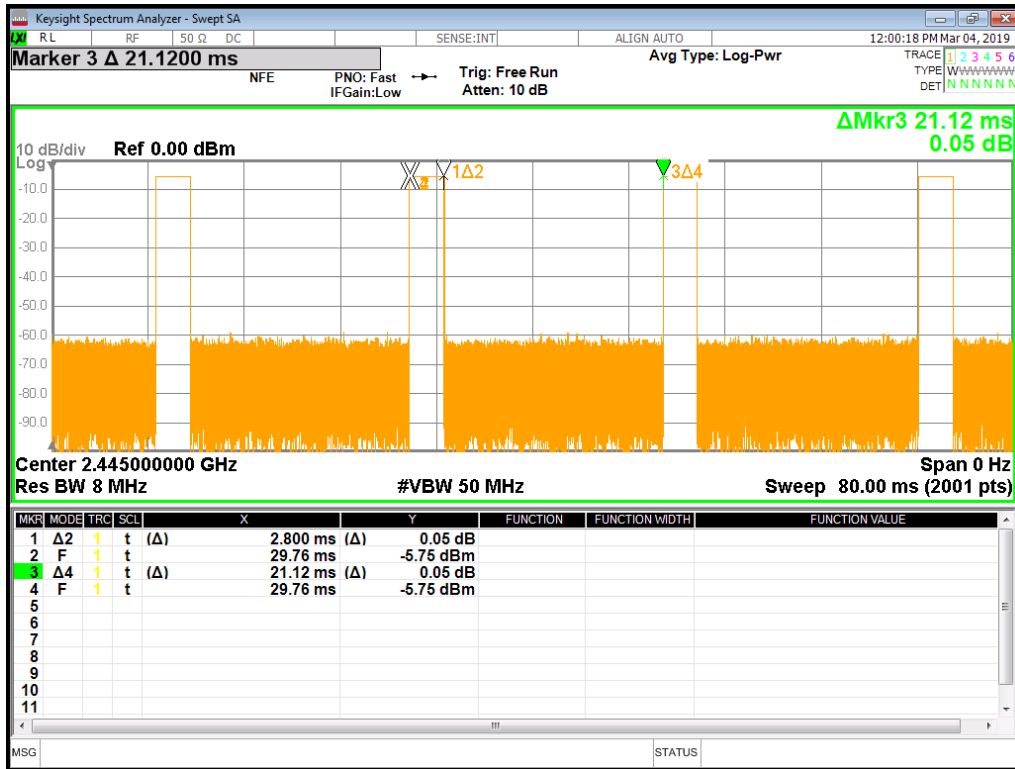

7.2. 6 dB DTS BANDWIDTH AND 99% BANDWIDTH

LIMITS

| CFR 47FCC Part15 (15.247) Subpart C ISED RSS-247 ISSUE 2 | | | |
|---|------------------------|------------------------------|-----------------------|
| Section | Test Item | Limit | Frequency Range (MHz) |
| CFR 47 FCC 15.247(a)(2) ISED RSS-247 5.2 (a) | 6dB Bandwidth | $\geq 500\text{kHz}$ | 2400-2483.5 |
| ISED RSS-Gen Clause 6.7 | 99% Occupied Bandwidth | For reporting purposes only. | 2400-2483.5 |

TEST PROCEDURE

Connect the UUT to the spectrum analyser and use the following settings:

| | |
|------------------|--|
| Center Frequency | The center frequency of the channel under test |
| Detector | Peak |
| RBW | For 6 dB Bandwidth :100K For 99% Occupied Bandwidth :1% to 5% of the occupied bandwidth |
| VBW | For 6dB Bandwidth : $\geq 3 \times \text{RBW}$ For 99% Occupied Bandwidth : approximately $3 \times \text{RBW}$ |
| Trace | Max hold |
| Sweep | Auto couple |

Allow the trace to stabilize and measure the maximum width of the emission that is constrained by the frequencies associated with the two outermost amplitude points (upper and lower frequencies) that are attenuated by 6 dB/99% relative to the maximum level measured in the fundamental emission.

TEST SETUP

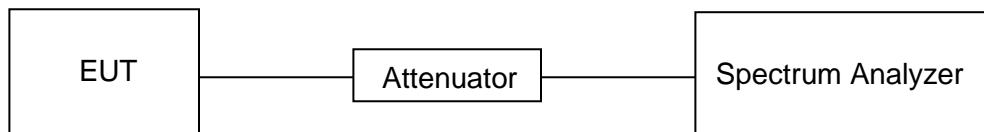



TEST ENVIRONMENT

| | | | |
|---------------------|--------|-------------------|--------------|
| Temperature | 23.5°C | Relative Humidity | 57% |
| Atmosphere Pressure | 101kPa | Test Voltage | AC 120V,60HZ |

RESULTS

| Channel | Frequency (MHz) | 6dB bandwidth (MHz) | 99% bandwidth (MHz) | Limit (kHz) | Result |
|---------|-----------------|---------------------|---------------------|-------------|--------|
| Low | 2405 | 1.607 | 2.2370 | 500 | Pass |
| Middle | 2445 | 1.408 | 2.2191 | 500 | Pass |
| High | 2475 | 1.444 | 2.2487 | 500 | Pass |
| CH26 | 2480 | 1.611 | 2.2381 | 500 | Pass |

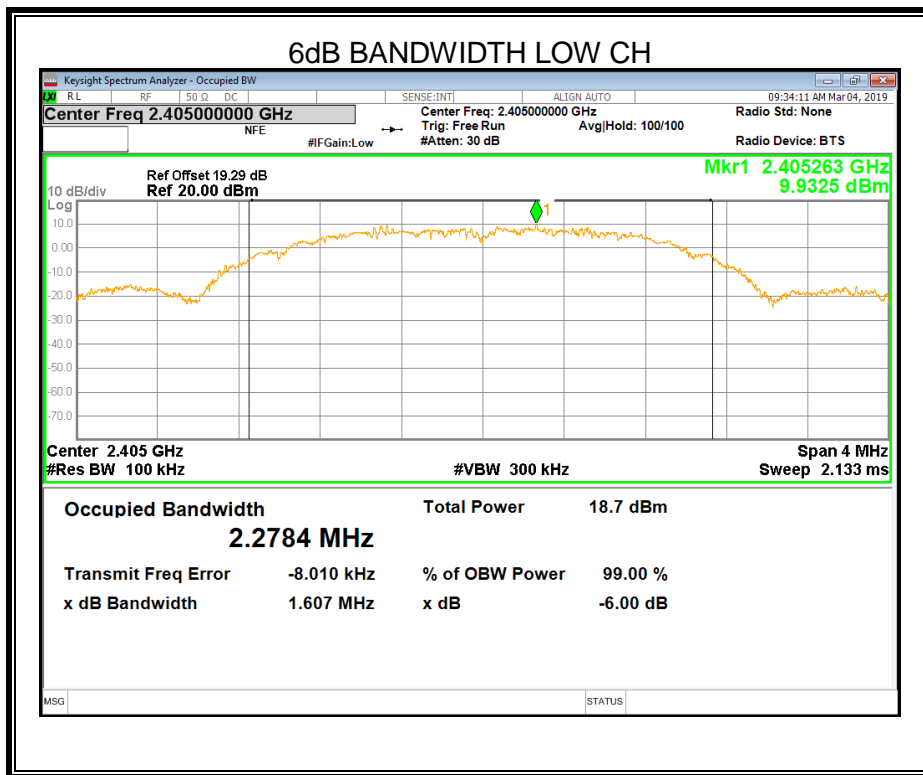

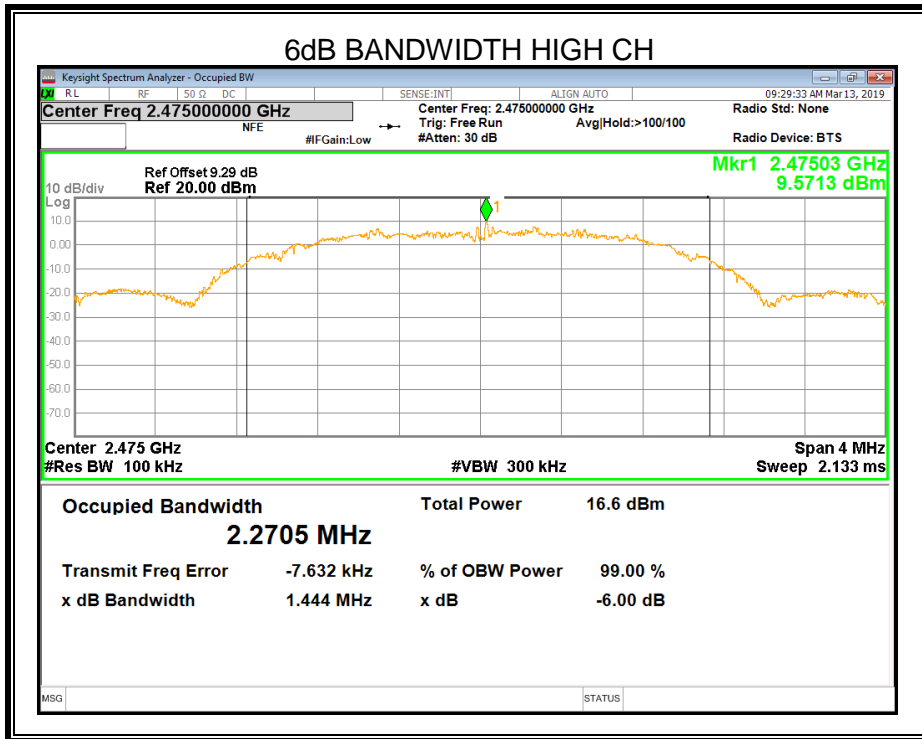
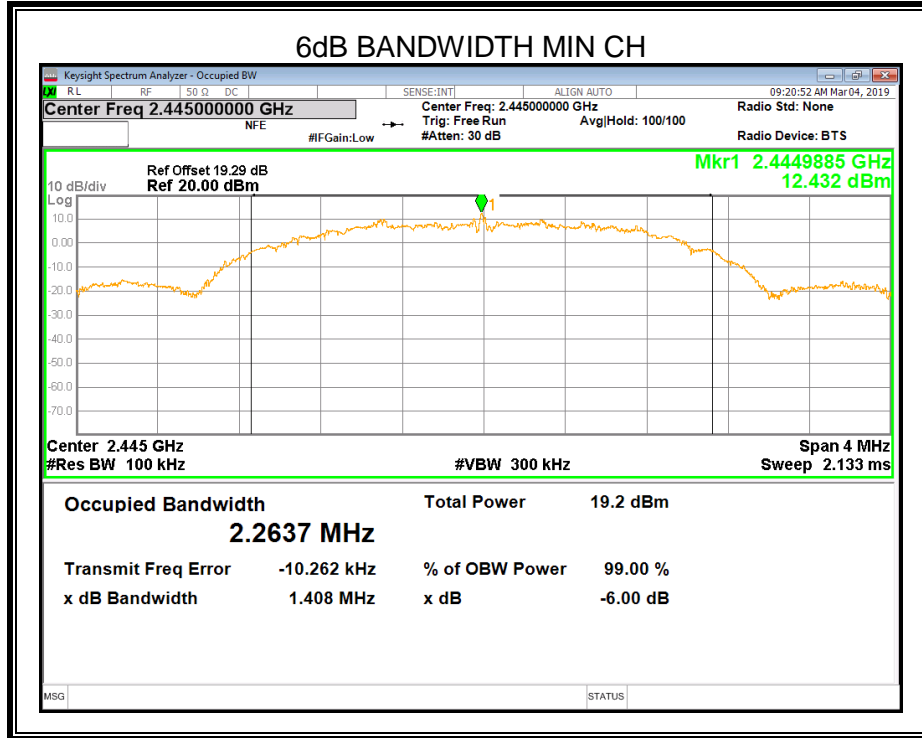

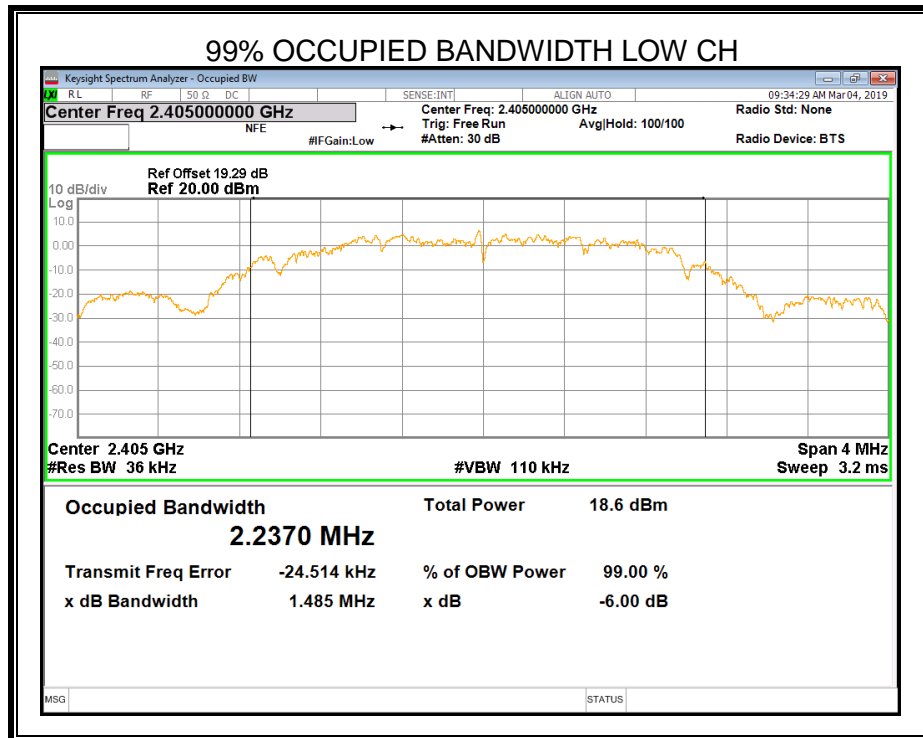
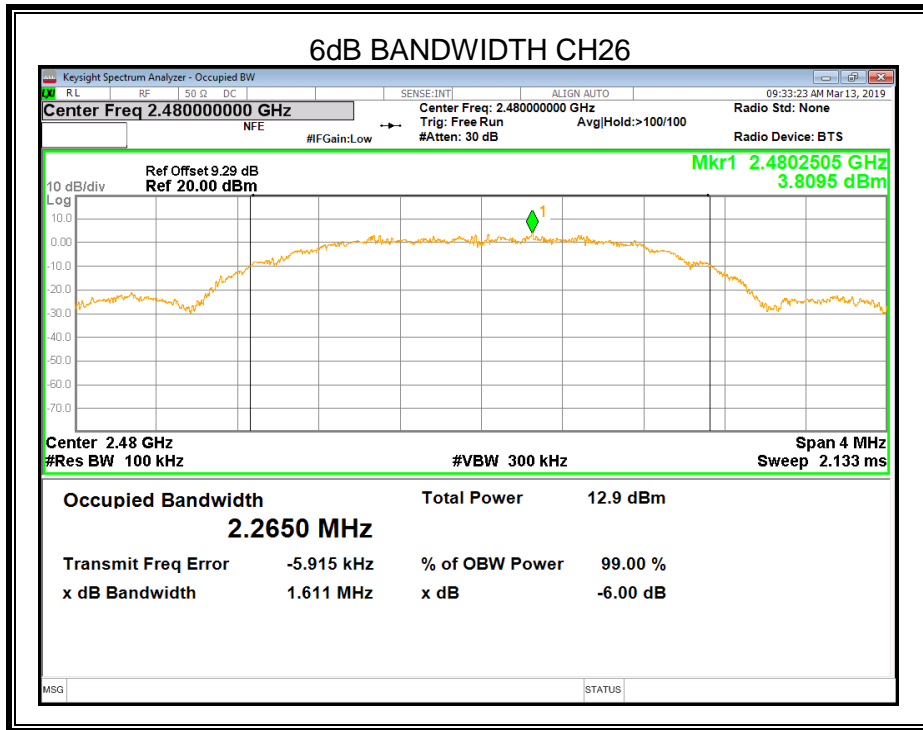

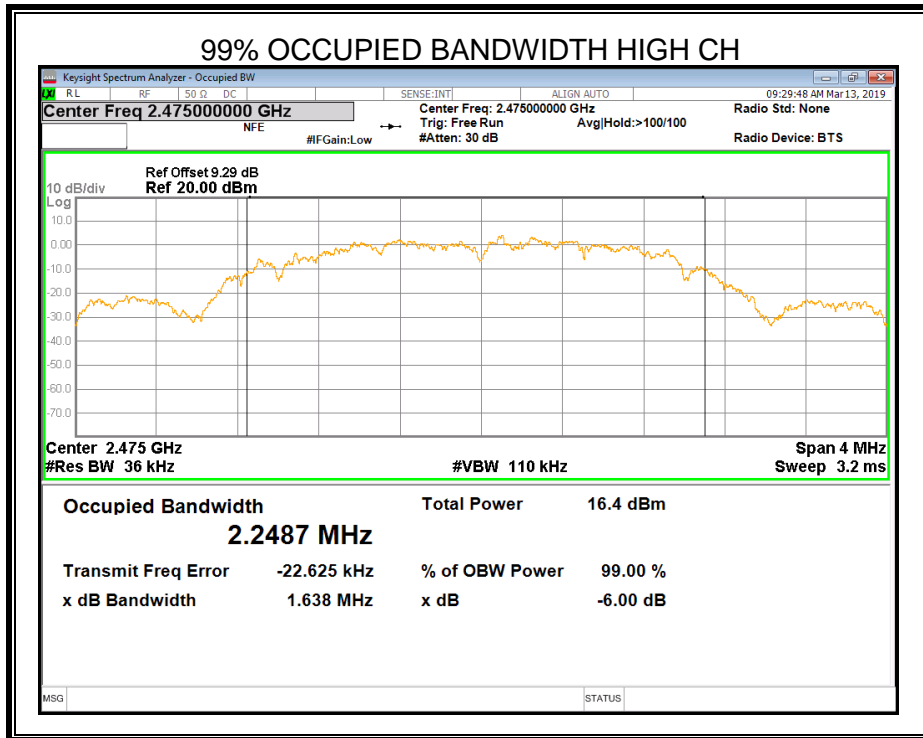
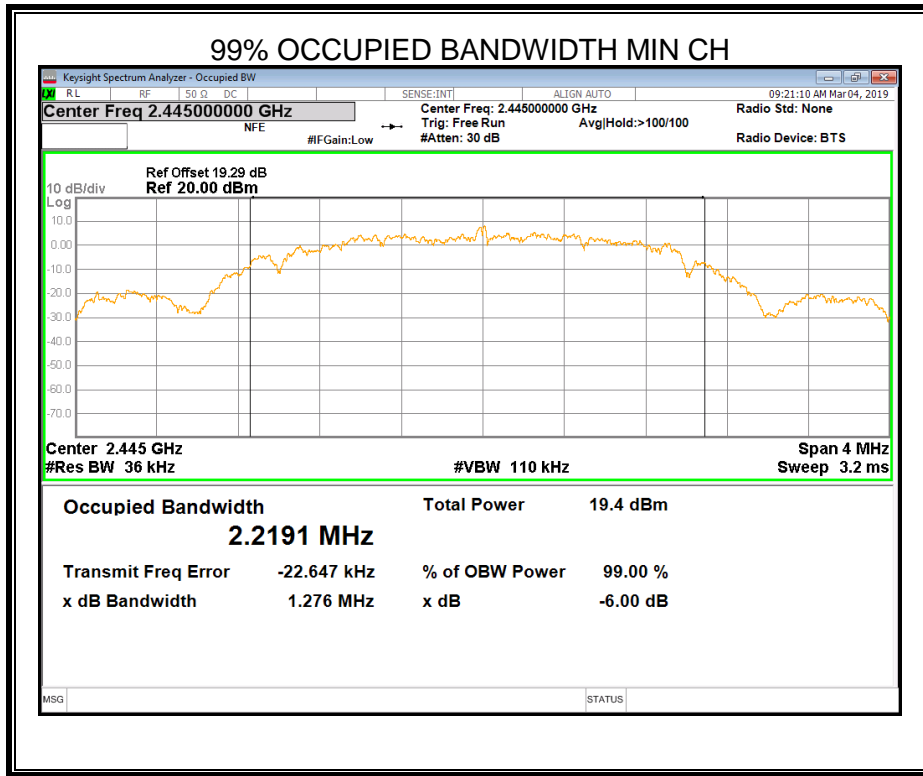

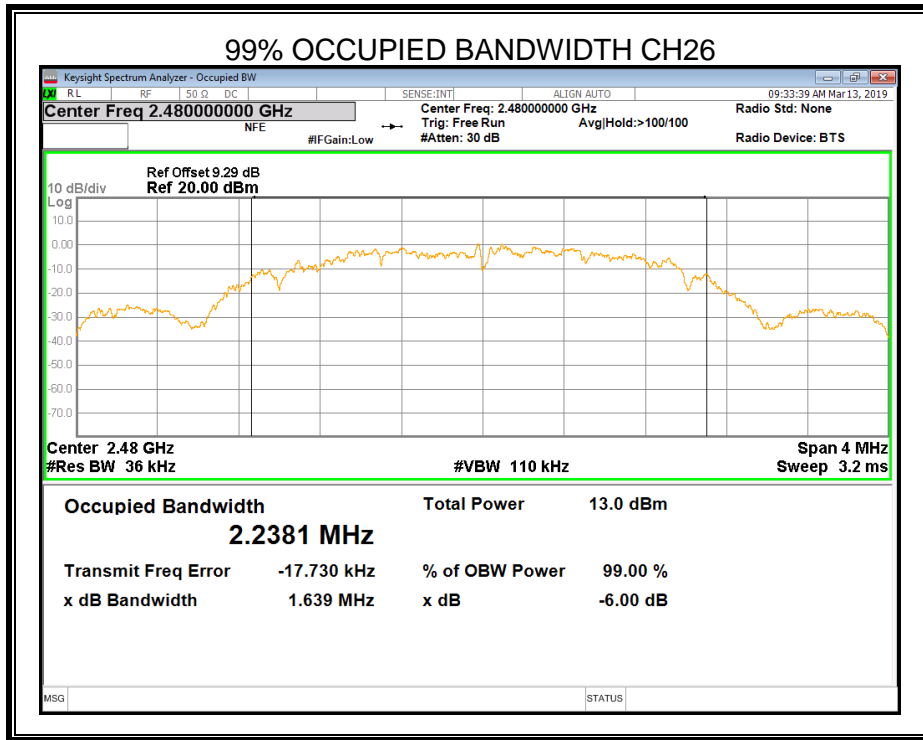



7.3. PEAK CONDUCTED OUTPUT POWER

LIMITS

| CFR 47 FCC Part15 (15.247) Subpart C ISED RSS-247 ISSUE 2 | | | |
|--|-------------------|-----------------|-----------------------|
| Section | Test Item | Limit | Frequency Range (MHz) |
| CFR 47 FCC 15.247(b)(3) ISED RSS-247 5.4 (e) | Peak Output Power | 1 watt or 30dBm | 2400-2483.5 |

TEST PROCEDURE

Place the EUT on the table and set it in the transmitting mode.
Remove the antenna from the EUT and then connect a low loss RF cable from the antenna port to the Power sensor.
Measure peak power each channel.

TEST SETUP

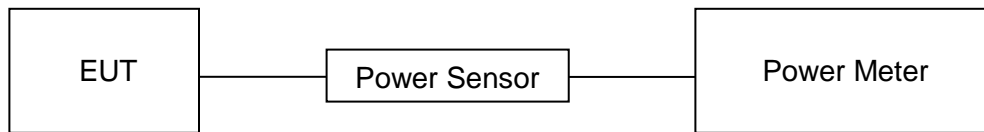

TEST ENVIRONMENT

| | | | |
|---------------------|--------|-------------------|--------------|
| Temperature | 23.5°C | Relative Humidity | 57% |
| Atmosphere Pressure | 101kPa | Test Voltage | AC 120V,60HZ |

RESULTS

| Test Channel | Frequency | Maximum Conducted Output Power(PK) | EIRP | LIMIT |
|--------------|-----------|------------------------------------|-------|-------|
| | (MHz) | (dBm) | (dBm) | dBm |
| Low | 2405 | 10.53 | 9.73 | 30 |
| Middle | 2445 | 10.30 | 9.5 | 30 |
| High | 2475 | 11.29 | 10.49 | 30 |
| CH 26 | 2480 | 7.65 | 6.85 | 30 |

Note: EIRP=Maximum Conducted Output Power(PK) + Antenna Gain

7.4. POWER SPECTRAL DENSITY

LIMITS

| CFR 47 FCC Part15 (15.247) Subpart C ISED RSS-247 ISSUE 2 | | | |
|--|------------------------|-------------------------|-----------------------|
| Section | Test Item | Limit | Frequency Range (MHz) |
| CFR 47 FCC §15.247 (e) ISED RSS-247 5.2 (b) | Power Spectral Density | 8 dBm in any 3 kHz band | 2400-2483.5 |

TEST PROCEDURE

Connect the UUT to the spectrum analyser and use the following settings:

| | |
|------------------|--|
| Center Frequency | The center frequency of the channel under test |
| Detector | Peak |
| RBW | $3 \text{ kHz} \leq \text{RBW} \leq 100 \text{ kHz}$ |
| VBW | $\geq 3 \times \text{RBW}$ |
| Span | 1.5 x DTS bandwidth |
| Trace | Max hold |
| Sweep time | Auto couple. |

Allow trace to fully stabilize and use the peak marker function to determine the maximum amplitude level within the RBW.

If measured value exceeds limit, reduce RBW (no less than 3 kHz) and repeat.

TEST SETUP

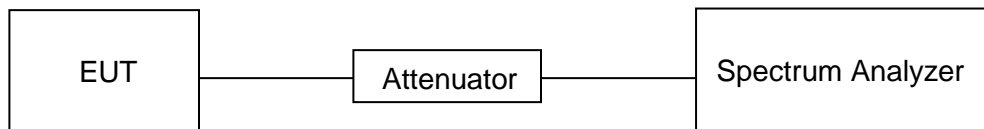



| | | | |
|---------------------|--------|-------------------|--------------|
| Temperature | 23.5°C | Relative Humidity | 57% |
| Atmosphere Pressure | 101kPa | Test Voltage | AC 120V,60HZ |

RESULTS

| Frequency | Power Spectral Density (dBm/3kHz) | Limit (dBm/3kHz) | Result |
|-----------|-----------------------------------|------------------|--------|
| 2405 MHz | -0.021 | 8 | PASS |
| 2445 MHz | 0.746 | 8 | PASS |
| 2475 MHz | -2.044 | 8 | PASS |
| 2480 MHz | -5.298 | 8 | PASS |

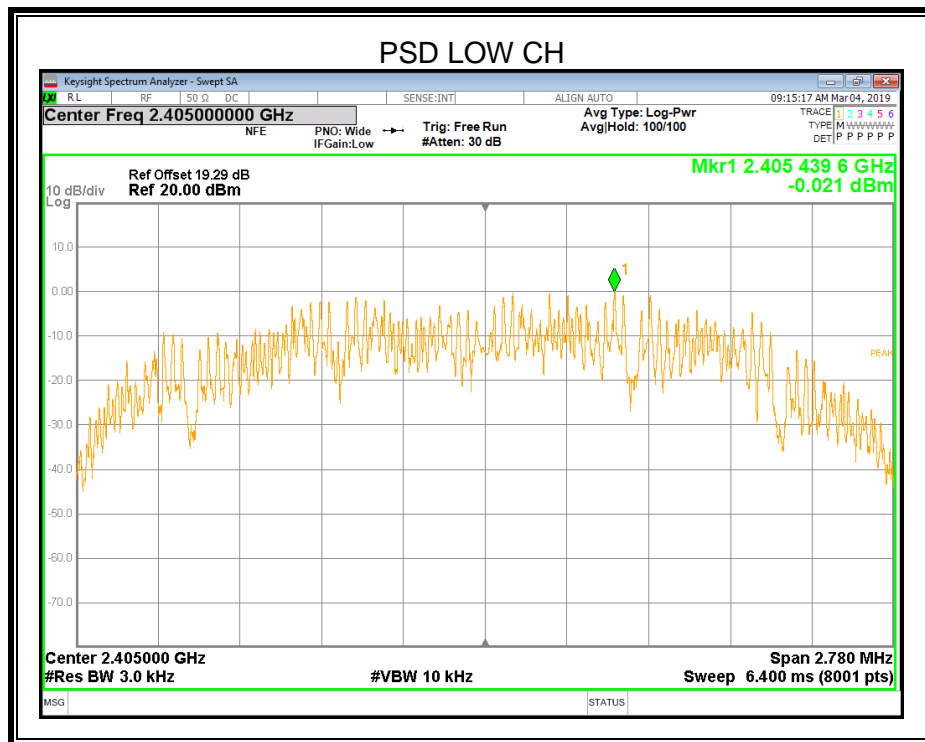

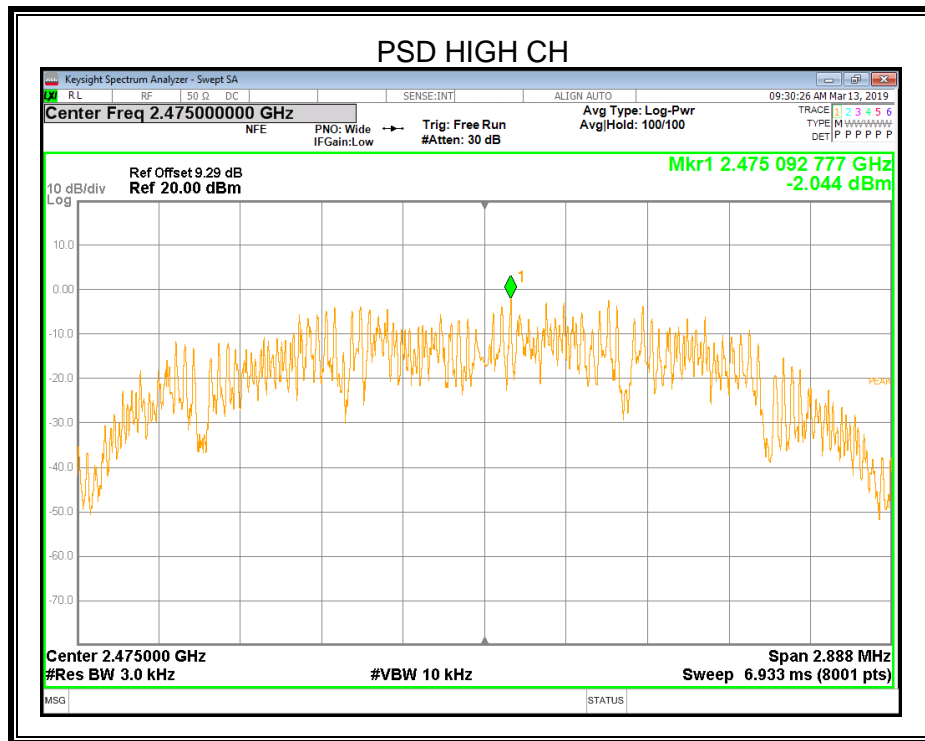
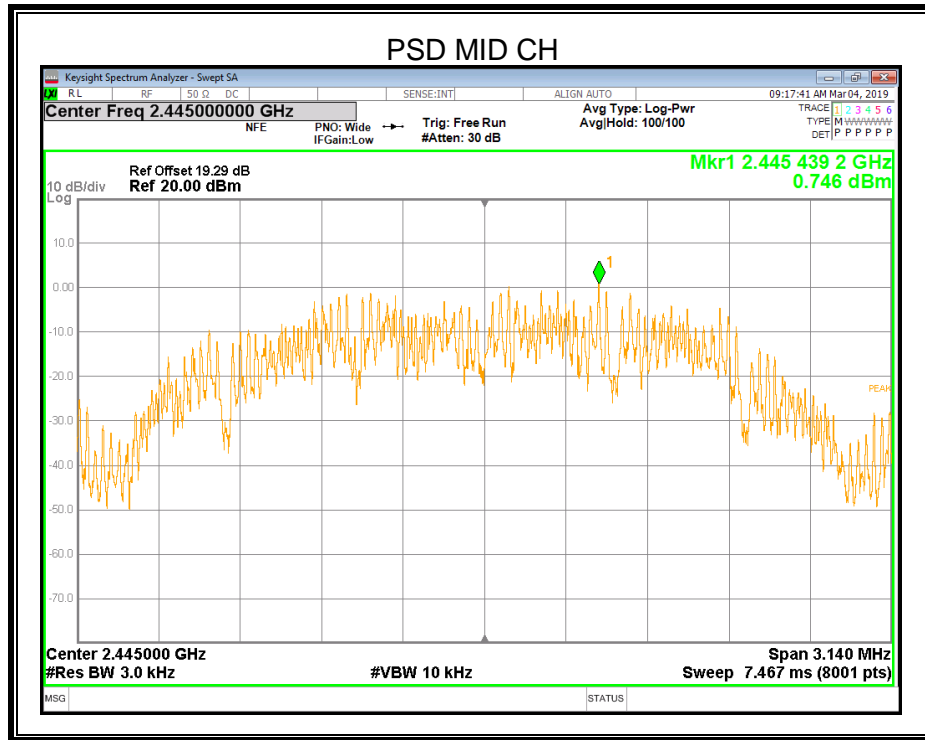

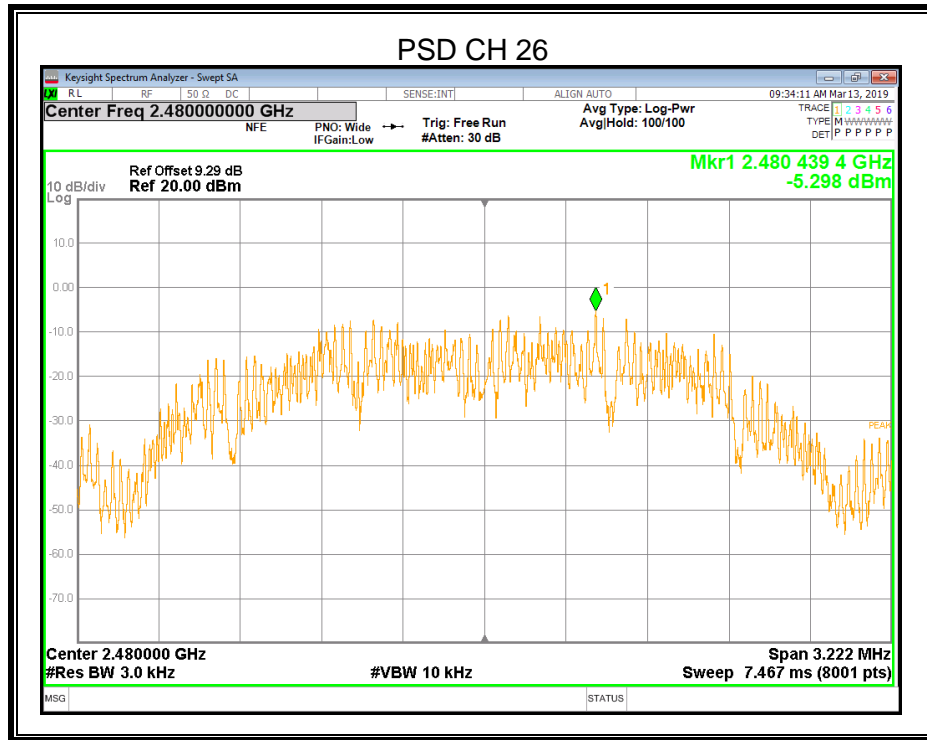

7.5. CONDUCTED BANDEGE AND SPURIOUS EMISSIONS

LIMITS

| CFR 47 FCC Part15 (15.247) Subpart C ISED RSS-247 ISSUE 2 | | |
|--|---|---|
| Section | Test Item | Limit |
| CFR 47 FCC §15.247 (d) ISED RSS-247 5.5 | Conducted Bandedge and Spurious Emissions | at least 20 dB below that in the 100 kHz bandwidth within the band that contains the highest level of the desired power |

TEST PROCEDURE

Connect the UUT to the spectrum analyser and use the following settings:

| | |
|------------------|--|
| Center Frequency | The center frequency of the channel under test |
| Detector | Peak |
| RBW | 100kHz |
| VBW | $\geq 3 \times \text{RBW}$ |
| Span | 1.5 x DTS bandwidth |
| Trace | Max hold |
| Sweep time | Auto couple. |

Use the peak marker function to determine the maximum PSD level.

| | |
|--------------------|---|
| Span | Set the center frequency and span to encompass frequency range to be measured |
| Detector | Peak |
| RBW | 100kHz |
| VBW | $\geq 3 \times \text{RBW}$ |
| measurement points | $\geq \text{span}/\text{RBW}$ |
| Trace | Max hold |
| Sweep time | Auto couple. |

Use the peak marker function to determine the maximum amplitude level.

TEST SETUP

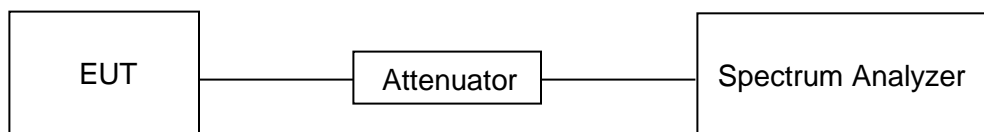



TEST ENVIRONMENT

| | | | |
|---------------------|--------|-------------------|--------------|
| Temperature | 23.5°C | Relative Humidity | 57% |
| Atmosphere Pressure | 101kPa | Test Voltage | AC 120V,60HZ |

RESULTS

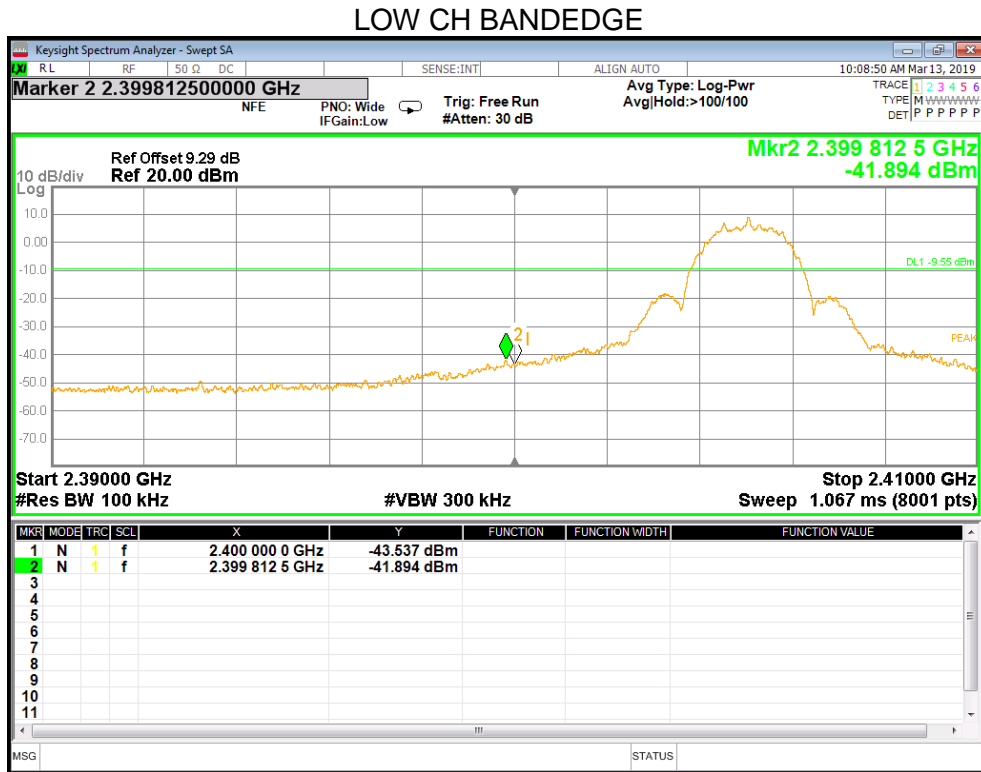



LOW CH SPURIOUS EMISSIONS REFERENCE

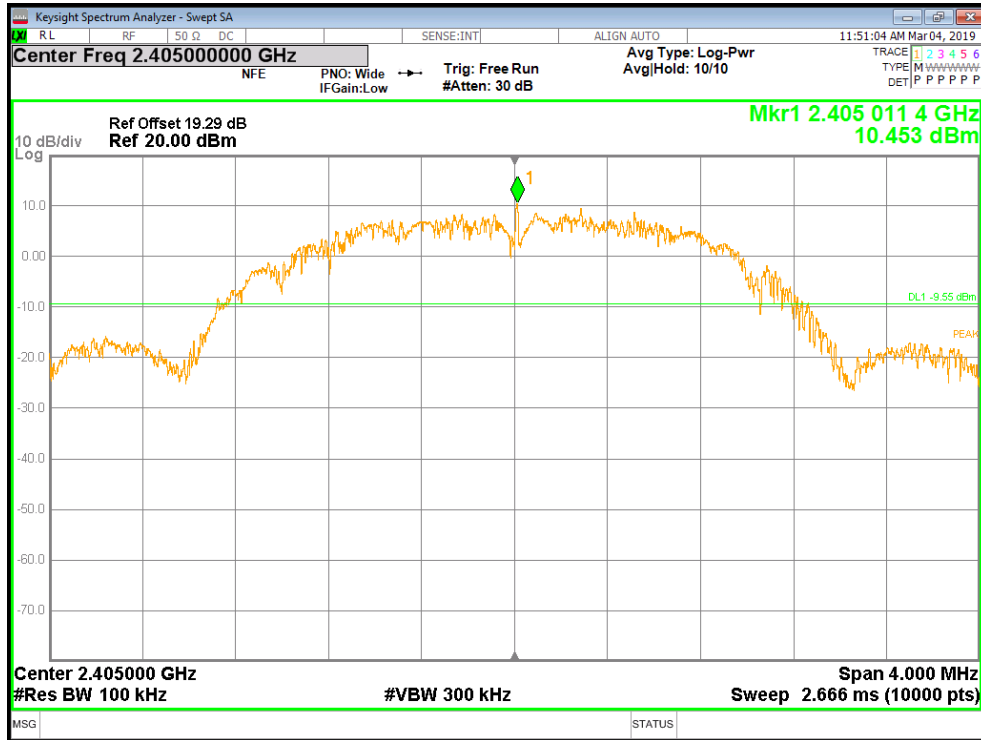

LOW CH SPURIOUS EMISSIONS 30M-10G

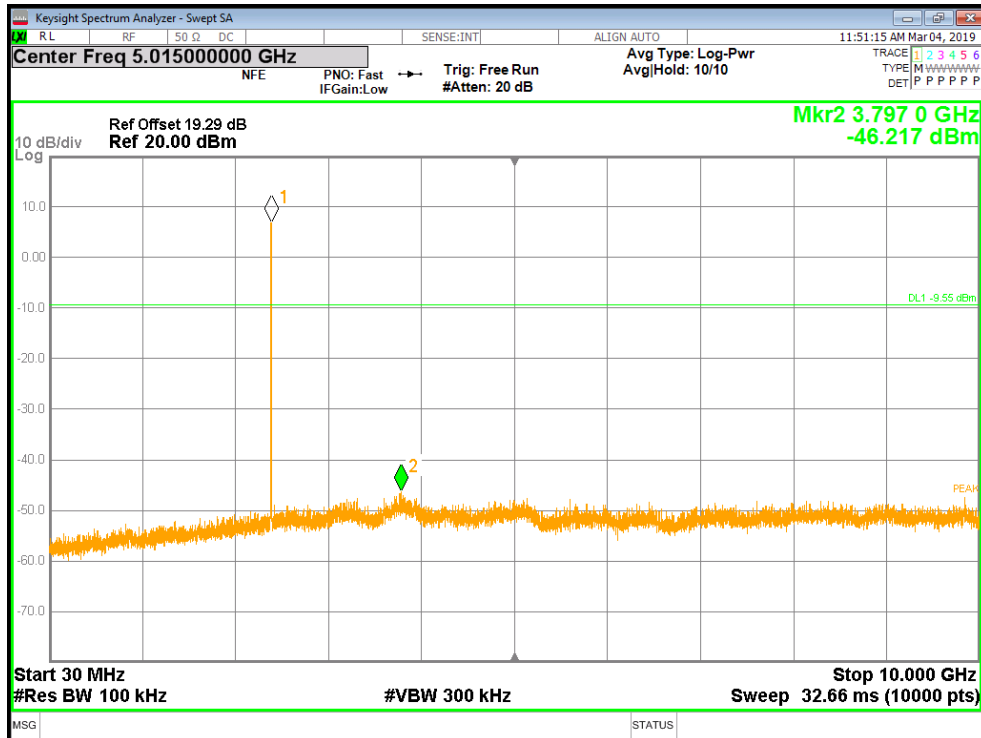



LOW CH SPURIOUS EMISSIONS 10G-26G

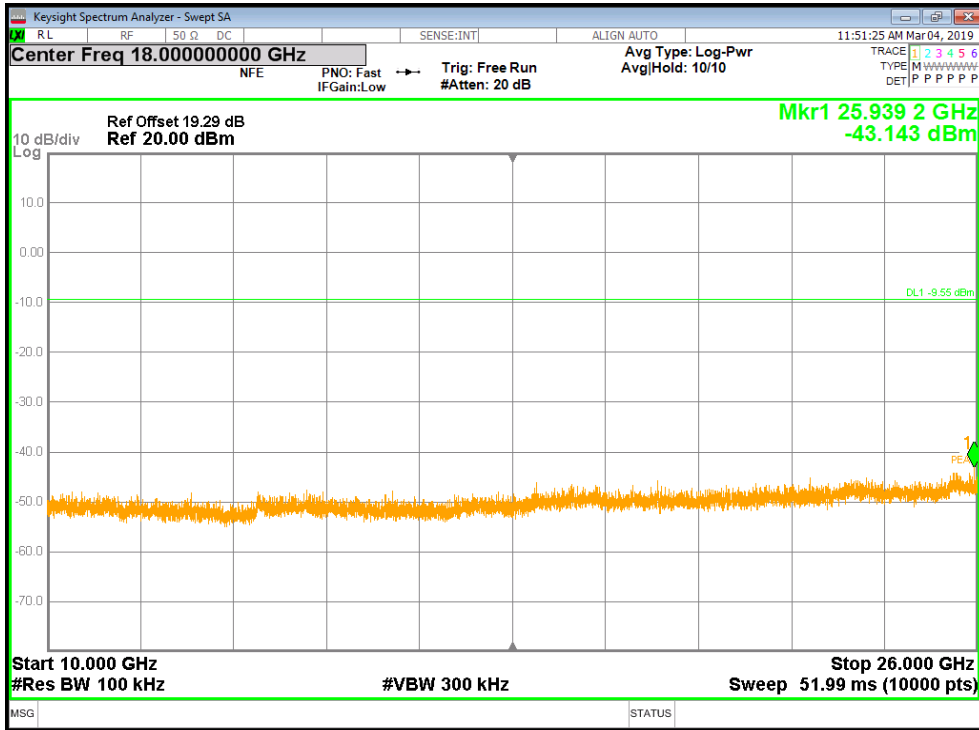

MID CH SPURIOUS EMISSIONS REFERENCE

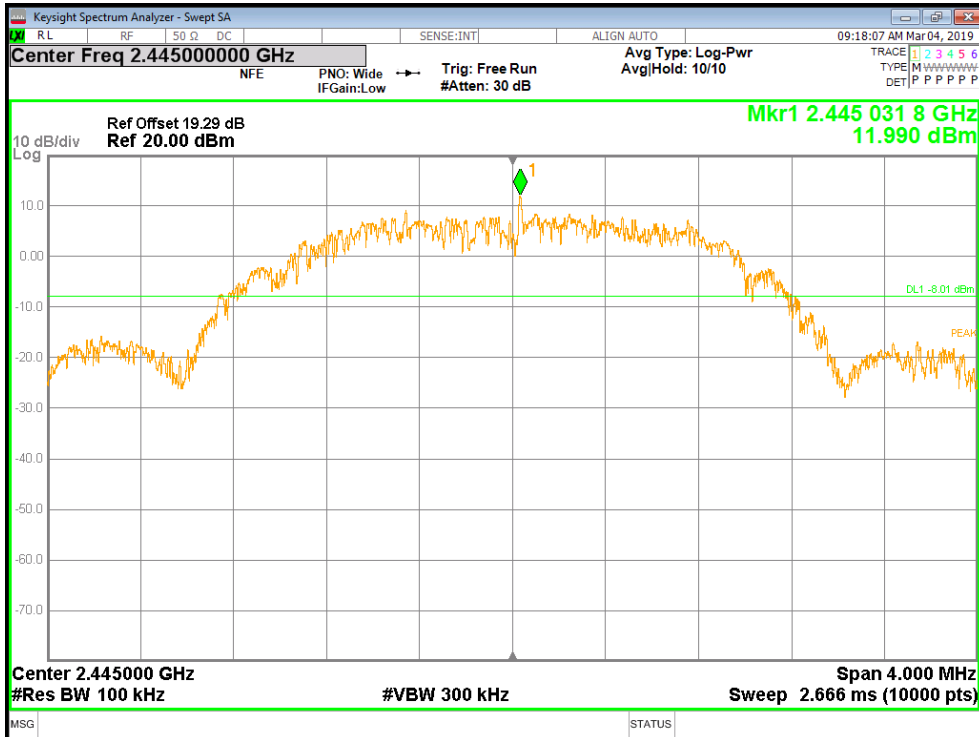



MID CH SPURIOUS EMISSIONS 30M-10G

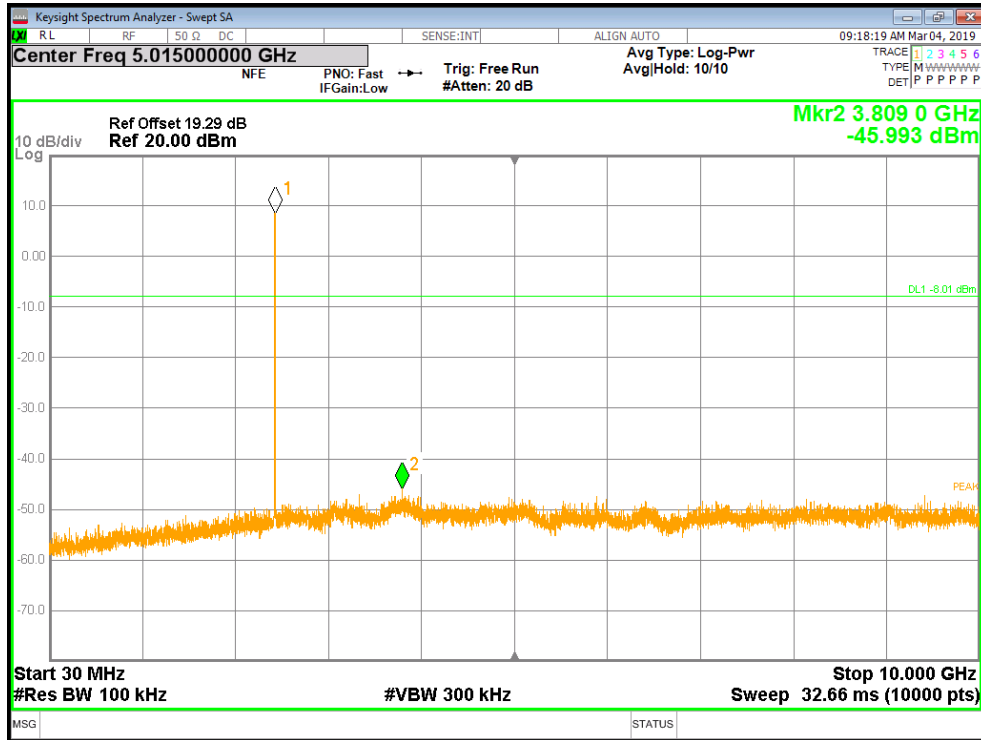

MID CH SPURIOUS EMISSIONS 10G-26G

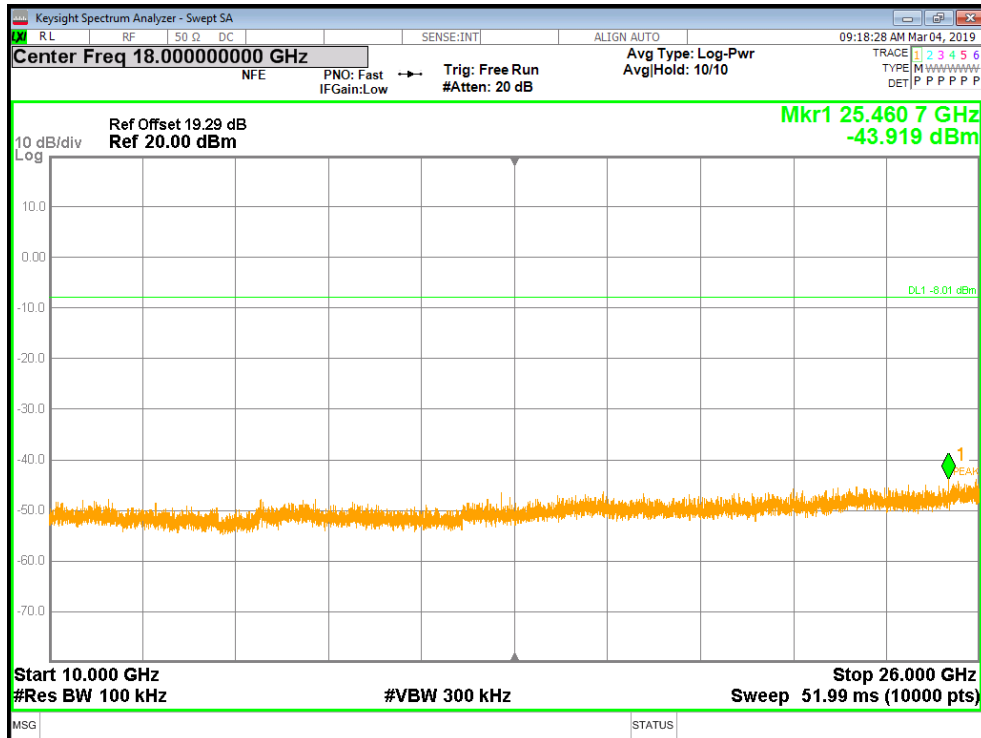



HIGH CH BANDEDGE

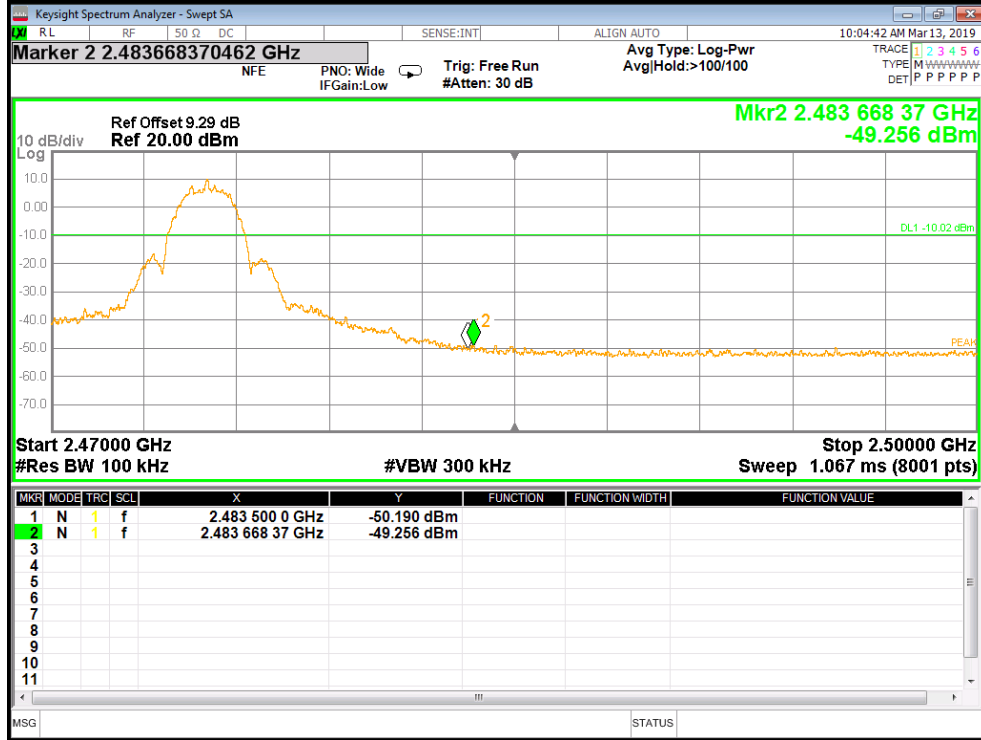

HIGH CH SPURIOUS EMISSIONS REFERENCE

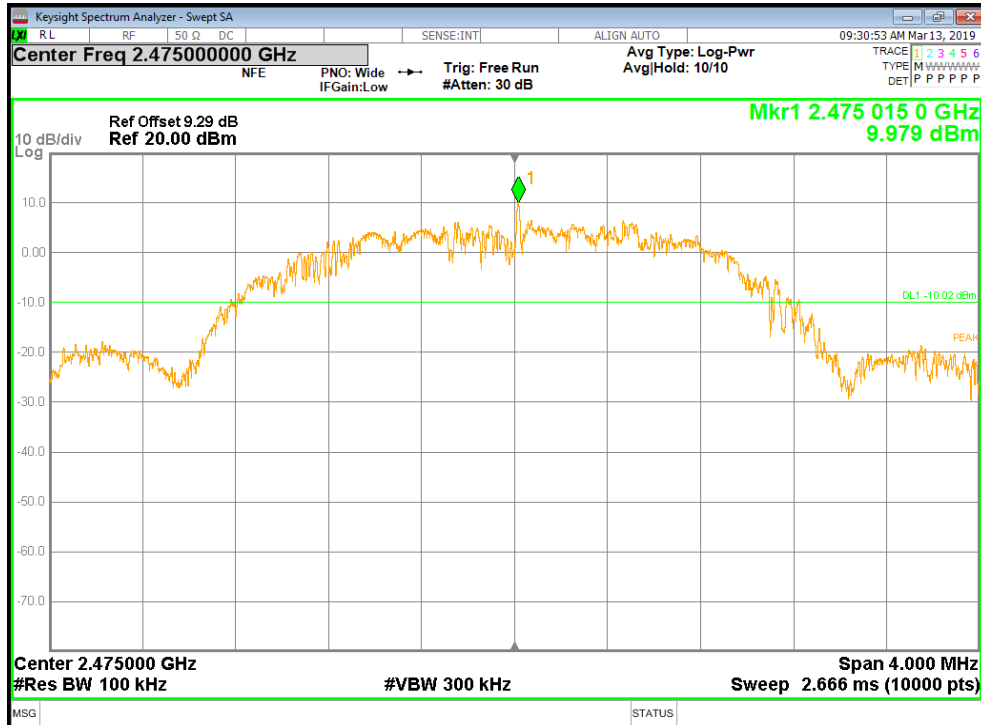



HIGH CH SPURIOUS EMISSIONS 30M-10G

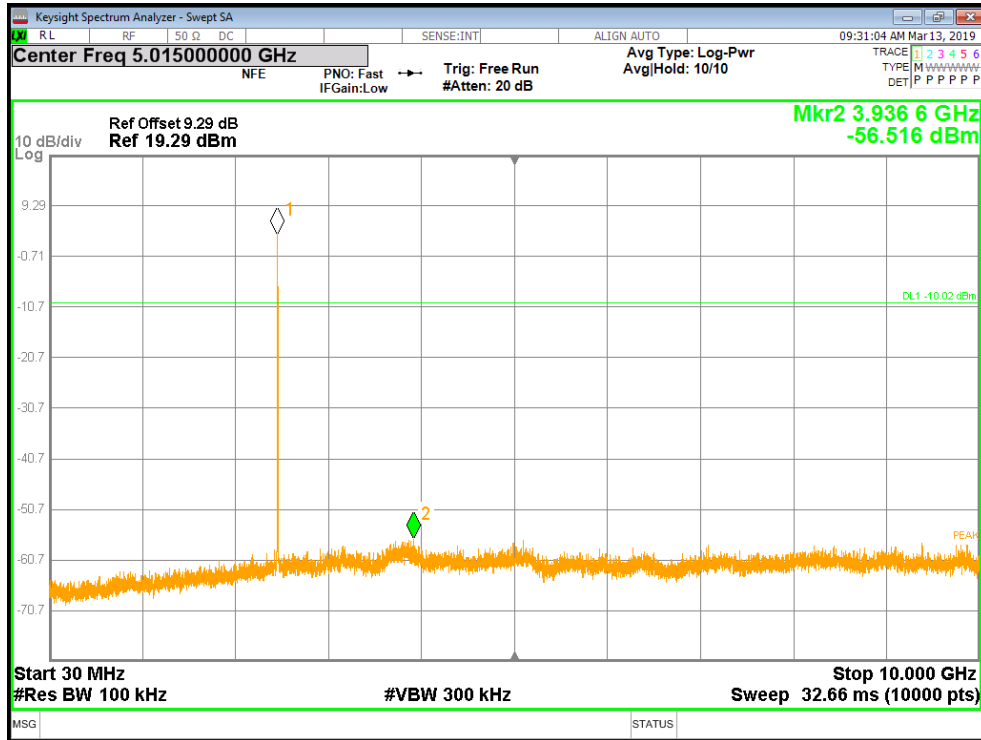

HIGH CH SPURIOUS EMISSIONS 10G-26G

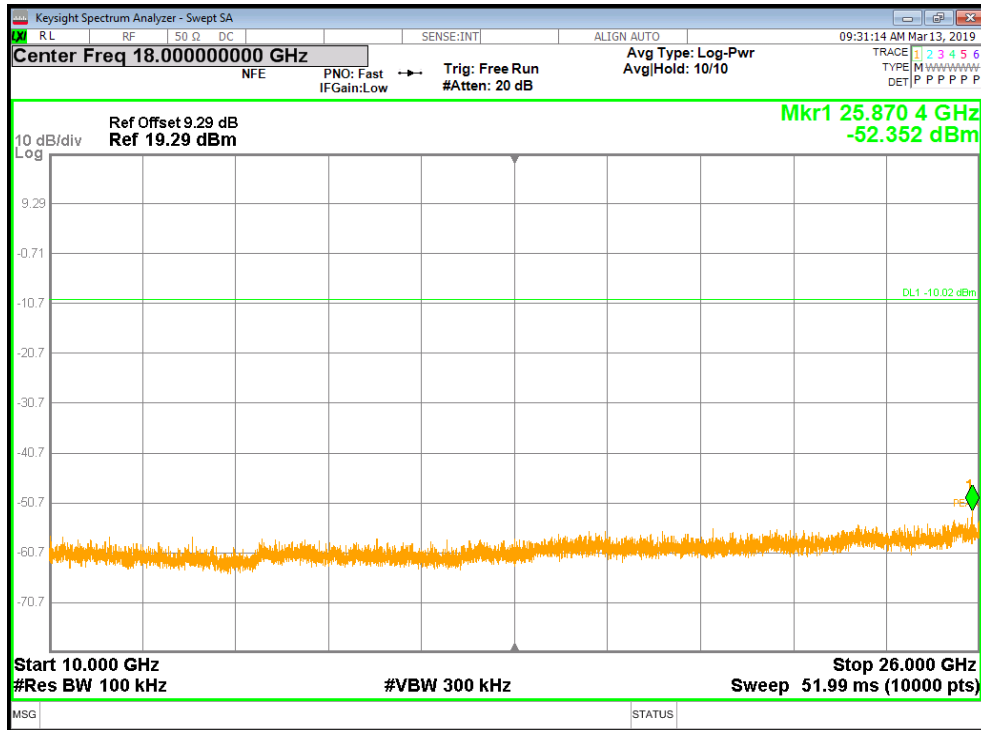



CH 26 BANDEDAGE

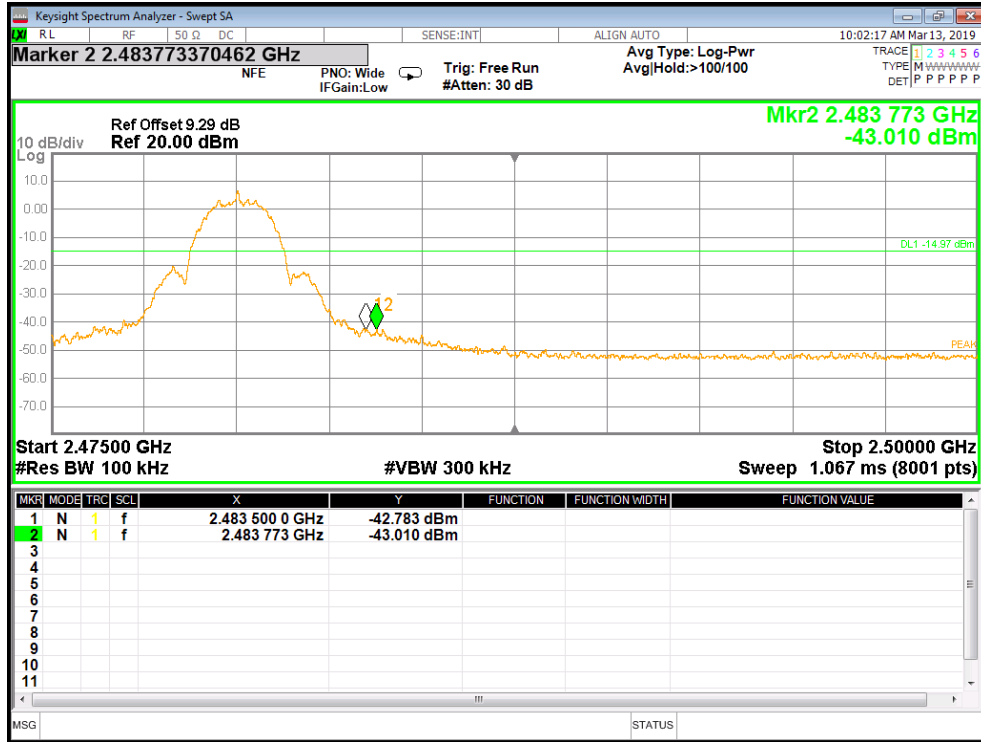

CH 26 SPURIOUS EMISSIONS REFERENCE

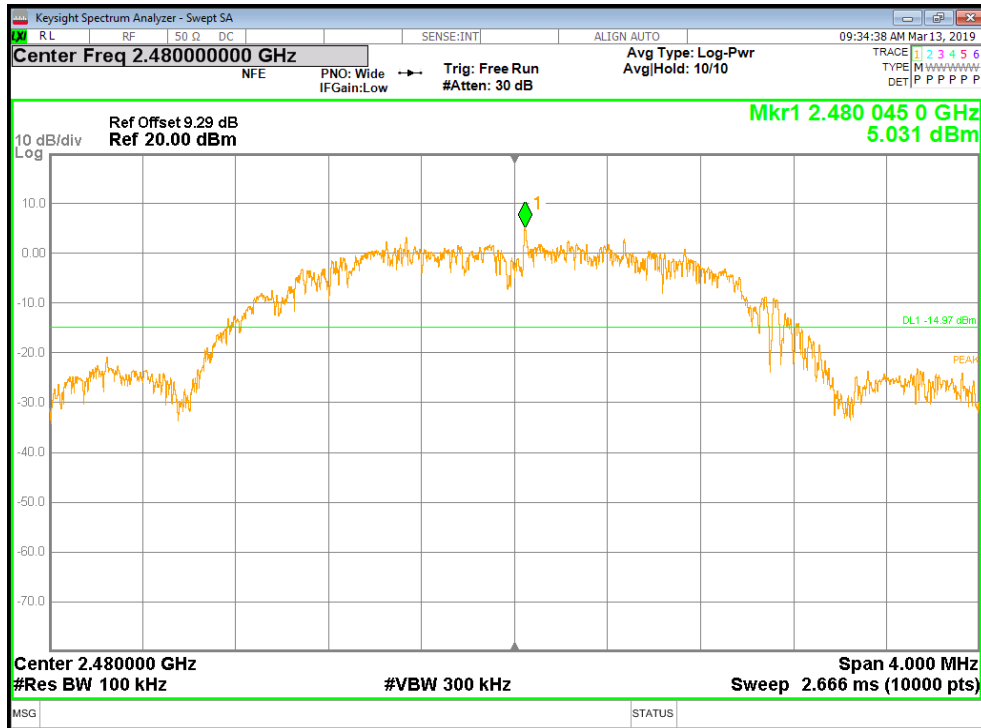



CH 26 SPURIOUS EMISSIONS 30M-10G

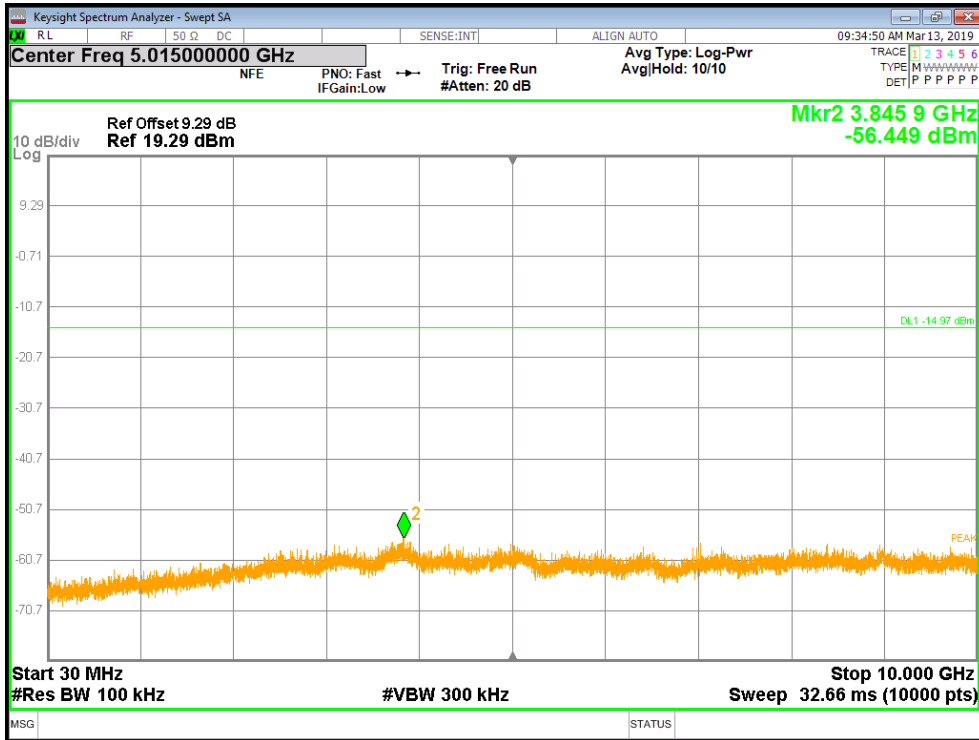

CH 26 SPURIOUS EMISSIONS 10G-26G

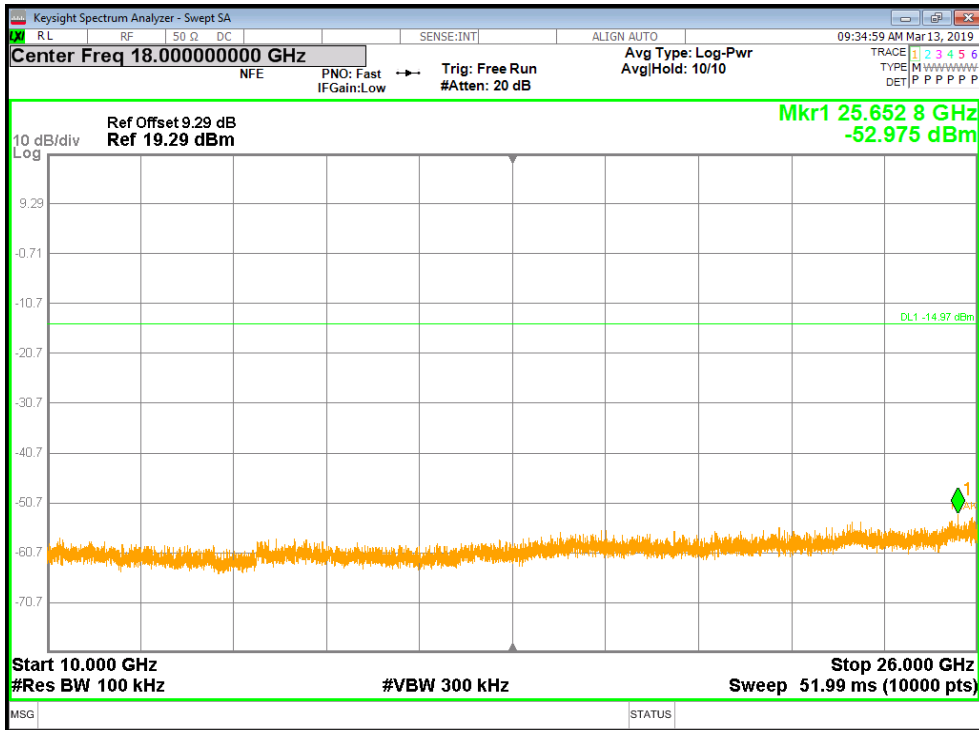



8. RADIATED TEST RESULTS

LIMITS

Please refer to FCC §15.205 and §15.209

Please refer to ISED RSS-GEN Clause 8.9 and Clause 8.10

Radiation Disturbance Test Limit for FCC (Class B) (9kHz-1GHz)

| Frequency (MHz) | Field Strength (microvolts/meter) | Measurement Distance (meters) |
|-----------------|-----------------------------------|-------------------------------|
| 0.009~0.490 | 2400/F(kHz) | 300 |
| 0.490~1.705 | 24000/F(kHz) | 30 |
| 1.705~30.0 | 30 | 30 |
| 30~88 | 100 | 3 |
| 88~216 | 150 | 3 |
| 216~960 | 200 | 3 |
| 960~1000 | 500 | 3 |

Note: 1) At frequencies at or above 30 MHz, measurements may be performed at a distance other than what is specified provided: measurements are not made in the near field except where it can be shown that near field measurements are appropriate due to the characteristics of the device; and it can be demonstrated that the signal levels needed to be measured at the distance employed can be detected by the measurement equipment. Measurements shall not be performed at a distance greater than 30 meters unless it can be further demonstrated that measurements at a distance of 30 meters or less are impractical. When performing measurements at a distance other than that specified, the results shall be extrapolated to the specified distance using an extrapolation factor of 20 dB/decade (inverse linear-distance for field strength measurements; inverse-linear-distance-squared for power density measurements).

(2) At frequencies below 30 MHz, measurements may be performed at a distance closer than that specified in the regulations; however, an attempt should be made to avoid making measurements in the near field. Pending the development of an appropriate measurement procedure for measurements performed below 30 MHz, when performing measurements at a closer distance than specified, the results shall be extrapolated to the specified distance by either making measurements at a minimum of two distances on at least one radial to determine the proper extrapolation factor or by using the square of an inverse linear distance extrapolation factor (40 dB/decade). This paragraph (f) shall not apply to Access BPL devices operating below 30 MHz.

Note: The test anechoic chamber in UL Verification Services (Guangzhou) Co., Ltd. Song Shan Lake Branch had been calibrated and compared to the open field sites.

Radiation Disturbance Test Limit for FCC (Above 1G)

| Frequency (MHz) | dB(uV/m) (at 3 meters) | |
|-----------------|------------------------|---------|
| | Peak | Average |
| Above 1000 | 74 | 54 |

About Restricted bands of operation please refer to RSS-Gen section 8.10 and FCC §15.205 (a)

TEST SETUP AND PROCEDURE

Below 30MHz

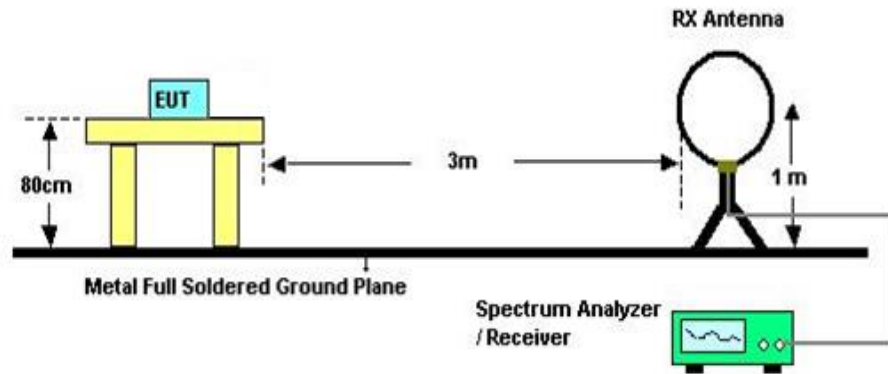

The setting of the spectrum analyser

| | |
|----------|--|
| RBW | 200Hz (From 9kHz to 0.15MHz)/ 9kHz (From 0.15MHz to 30MHz) |
| VBW | 200Hz (From 9kHz to 0.15MHz)/ 9kHz (From 0.15MHz to 30MHz) |
| Sweep | Auto |
| Detector | Peak/QP |
| Trace | Max hold |

1. The testing follows the guidelines in ANSI C63.10-2013
2. The EUT was arranged to its worst case and then turntable (from 0 degree to 360 degrees) to find the maximum reading. A pre-amp and a high pass filter are used for the test in order to get better signal level. Both horizontal and vertical polarizations of the antenna are set to make the measurement.
3. The EUT was placed on a turntable with 80cm above ground.
4. The EUT was set 3 meters from the interference receiving antenna, which was mounted on the top of a variable height antenna tower.
5. The radiated emission limits are based on measurements employing a CISPR quasi-peak detector except for the frequency bands 9-90 kHz, 110-490 kHz and above 1000 MHz. Radiated emission limits in these three bands are based on measurements employing an average detector.
6. For measurement below 1GHz, the initial step in collecting conducted emission data is a spectrum analyzer peak detector mode pre-scanning the measurement frequency range. Significant peaks are then marked and then Quasi Peak and average detector mode re-measured. If the emission level of the EUT measured by the peak detector is 3 dB lower than the applicable limit, the peak emission level will be reported. Otherwise, the emission measurement will be repeated using the quasi-peak and average detector and reported.
7. Although these tests were performed other than open field site, adequate comparison measurements were confirmed against 30m open are test site. Therefore sufficient tests were made to demonstrate that the alternative site produces results that correlate with the ones of tests made in an open field based on KDB 414788.

Below 1G and above 30MHz

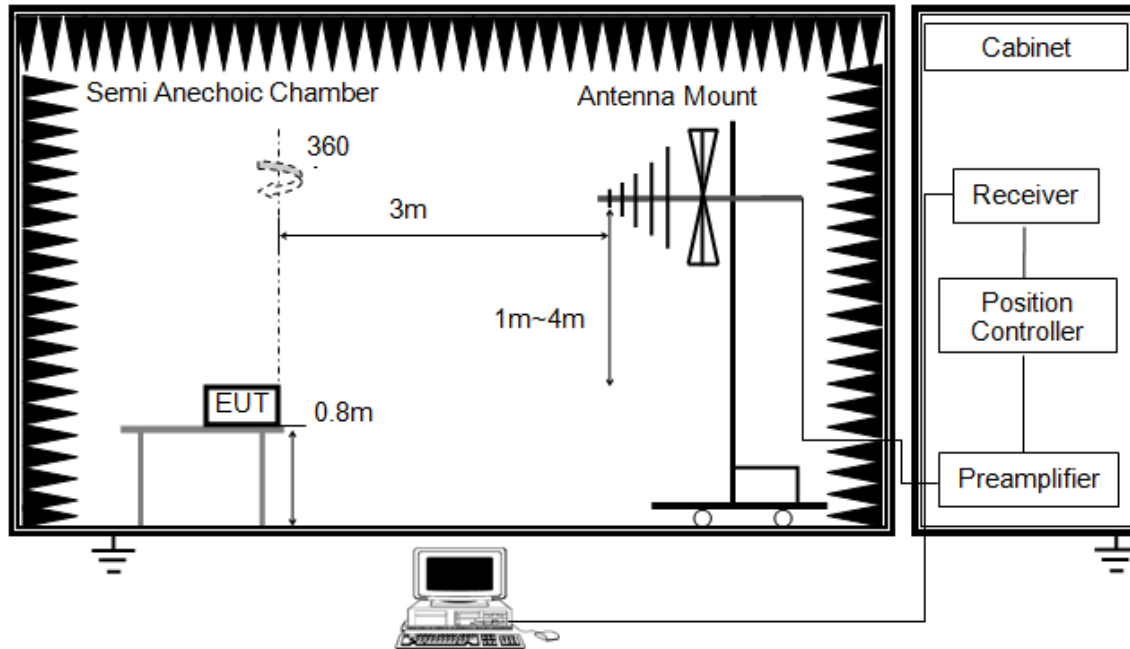

The setting of the spectrum analyser

| | |
|----------|----------|
| RBW | 120K |
| VBW | 300K |
| Sweep | Auto |
| Detector | Peak/QP |
| Trace | Max hold |

1. The testing follows the guidelines in ANSI C63.10-2013.
2. The EUT was arranged to its worst case and then tune the antenna tower (from 1 m to 4 m) and turntable (from 0 degree to 360 degrees) to find the maximum reading. A pre-amp and a high pass filter are used for the test in order to get better signal level. Both horizontal and vertical polarizations of the antenna are set to make the measurement.
3. The EUT was placed on a turntable with 80cm above ground.
4. The EUT was set 3 meters from the interference receiving antenna, which was mounted on the top of a variable height antenna tower.
5. For measurement below 1GHz, the initial step in collecting conducted emission data is a spectrum analyzer peak detector mode pre-scanning the measurement frequency range. Significant peaks are then marked and then Quasi Peak detector mode re-measured. If the emission level of the EUT measured by the peak detector is 3 dB lower than the applicable limit, the peak emission level will be reported. Otherwise, the emission measurement will be repeated using the quasi-peak detector and reported.

Above 1G

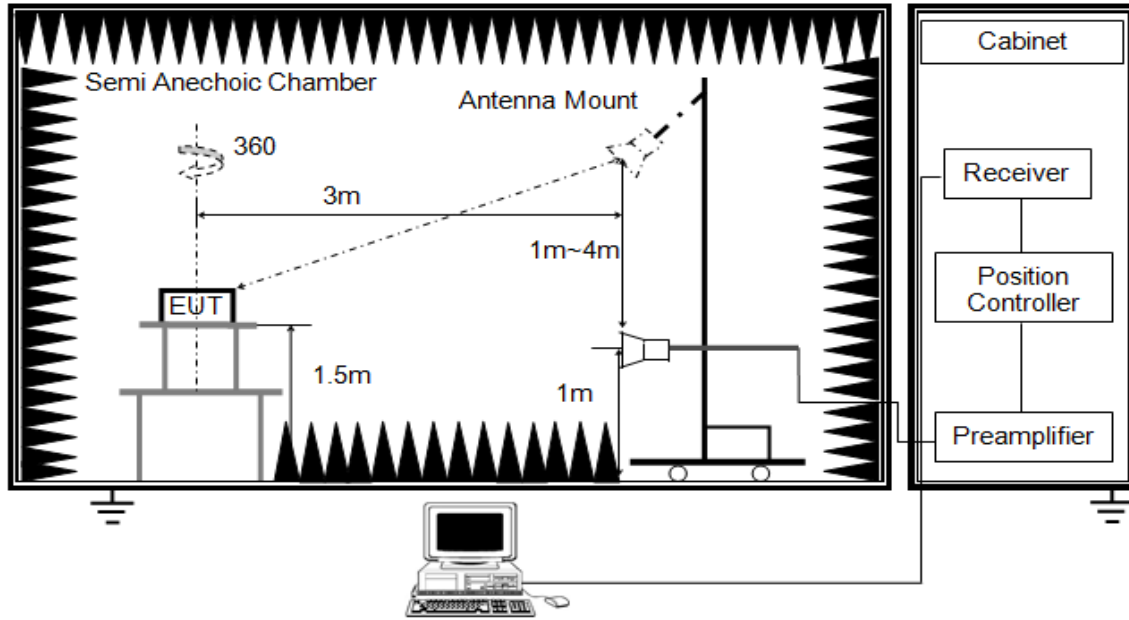

The setting of the spectrum analyser

| | |
|----------|-----------------------------|
| RBW | 1M |
| VBW | PEAK: 3M AVG: see note 6 |
| Sweep | Auto |
| Detector | Peak |
| Trace | Max hold |

1. The testing follows the guidelines in ANSI C63.10-2013.
2. The EUT was arranged to its worst case and then tune the antenna tower (1.5 m) and turntable (from 0 degree to 360 degrees) to find the maximum reading. A pre-amp and a high pass filter are used for the test in order to get better signal level. Both horizontal and vertical polarizations of the antenna are set to make the measurement.
3. The EUT was placed on a turntable with 1.5m above ground.
4. The EUT was set 3 meters from the interference receiving antenna, which was mounted on the top of a variable height antenna tower.
5. For measurement above 1GHz, the emission measurement will be measured by the peak detector. This peak level, once corrected, must comply with the limit specified in Section 15.209.
6. For measurements above 1 GHz the resolution bandwidth is set to 1 MHz, then the video bandwidth is set to 3 MHz for peak measurements and 1 MHz resolution bandwidth with 1/T video bandwidth with peak detector for average measurements. For the Duty Cycle and Correction Factor please refer to clause 7.1.ON TIME AND DUTY CYCLE.

X axis, Y axis, Z axis positions:

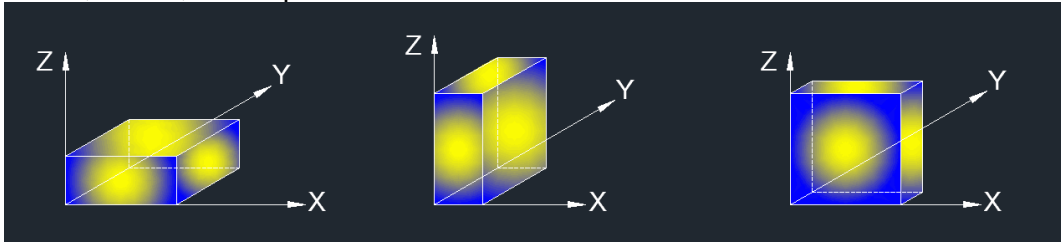

Note 1: For all radiated test, EUT in each of three orthogonal axis emissions had been tested, but only the worst case (X axis) data recorded in the report.

TEST ENVIRONMENT

| | | | |
|---------------------|--------|-------------------|--------------|
| Temperature | 22.7°C | Relative Humidity | 58% |
| Atmosphere Pressure | 101kPa | Test Voltage | AC 120V,60HZ |

RESULTS



8.1. RESTRICTED BANDEGE

RESTRICTED BANDEGE (LOW CHANNEL, HORIZONTAL)

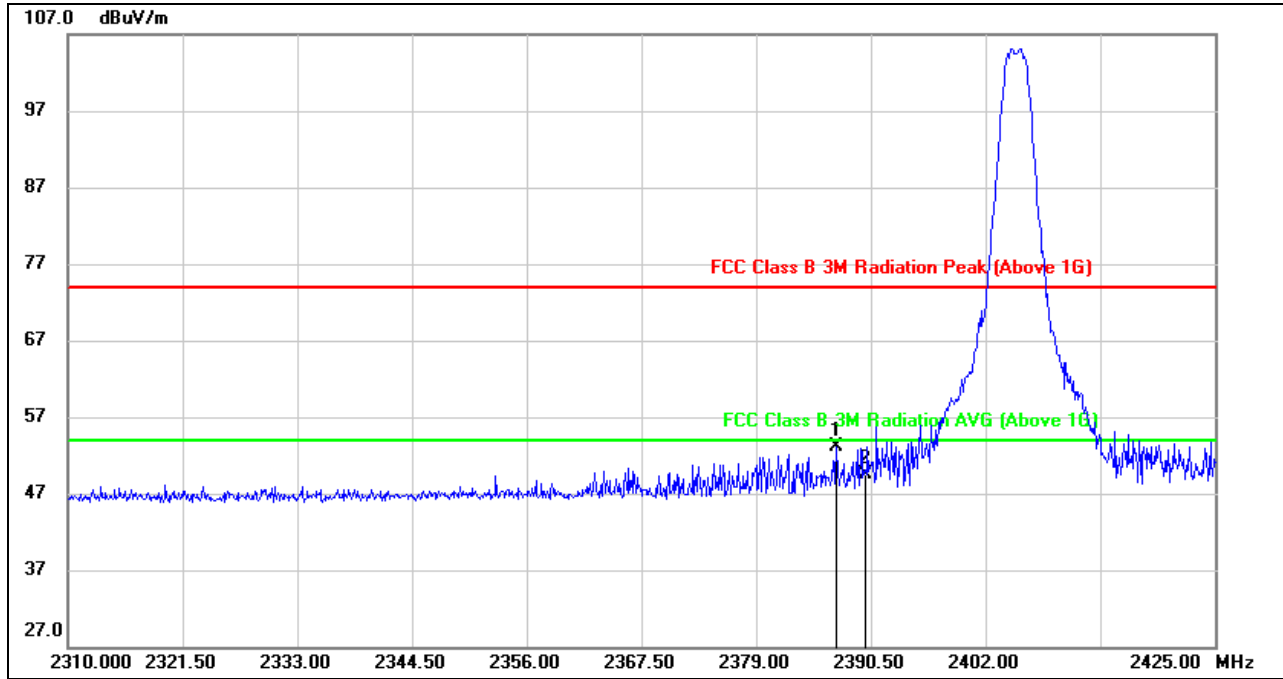

| No. | Frequency (MHz) | Reading (dBuV) | Correct (dB/m) | Result (dBuV/m) | Limit (dBuV/m) | Margin (dB) | Remark |
|-----|-----------------|----------------|----------------|-----------------|----------------|-------------|--------|
| 1 | 2387.050 | 20.07 | 32.94 | 53.01 | 74.00 | -20.99 | peak |
| 2 | 2390.000 | 16.60 | 32.94 | 49.54 | 74.00 | -24.46 | peak |

- Note: 1. Measurement = Reading Level + Correct Factor.
 2. If Peak Result complies with AV limit, AV Result is deemed to comply with AV limit.
 3. Peak: Peak detector.
 4. Only the worst case emission will be recorder, if it complies with the limit, the other emissions deemed to comply with the limit.



RESTRICTED BANDEDGE (LOW CHANNEL, VERTICAL)

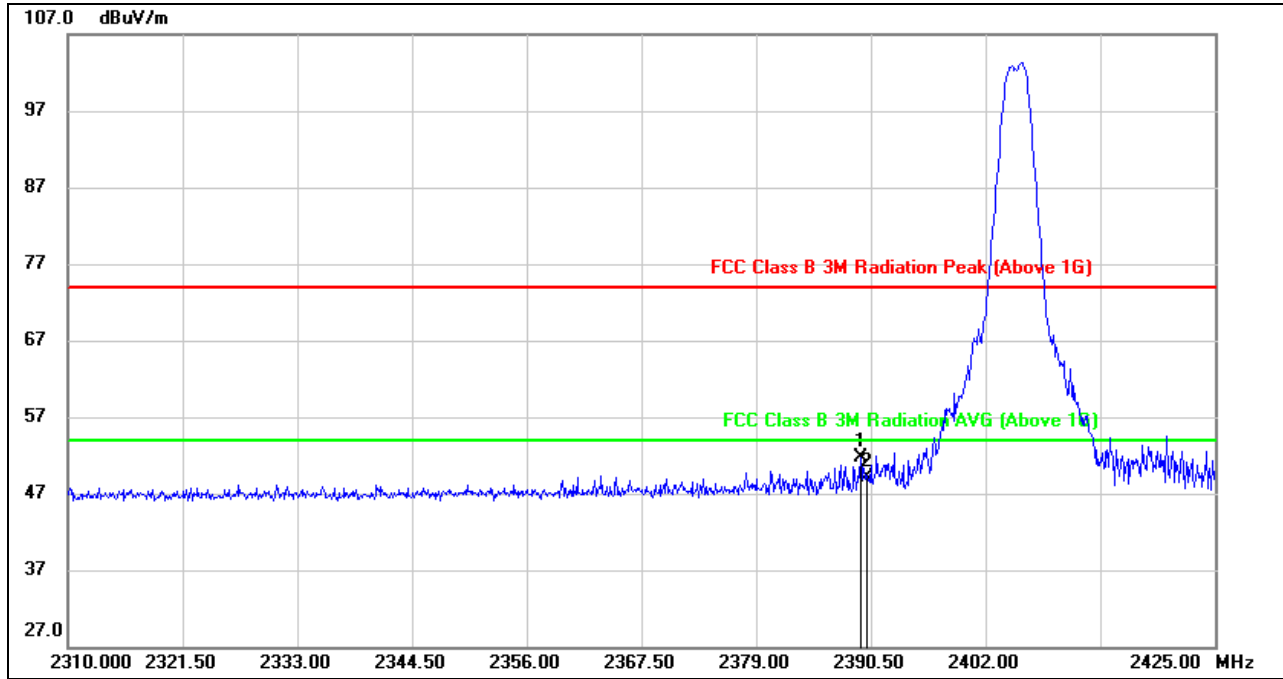

| No. | Frequency (MHz) | Reading (dBuV) | Correct (dB/m) | Result (dBuV/m) | Limit (dBuV/m) | Margin (dB) | Remark |
|-----|-----------------|----------------|----------------|-----------------|----------------|-------------|--------|
| 1 | 2389.465 | 18.71 | 32.94 | 51.65 | 74.00 | -22.35 | peak |
| 2 | 2390.000 | 16.14 | 32.94 | 49.08 | 74.00 | -24.92 | peak |

- Note:
1. Measurement = Reading Level + Correct Factor.
 2. If Peak Result complies with AV limit, AV Result is deemed to comply with AV limit.
 3. Peak: Peak detector.
 4. Only the worst case emission will be recorder, if it complies with the limit, the other emissions deemed to comply with the limit.



RESTRICTED BANDEDGE (HIGH CHANNEL, HORIZONTAL)
PEAK

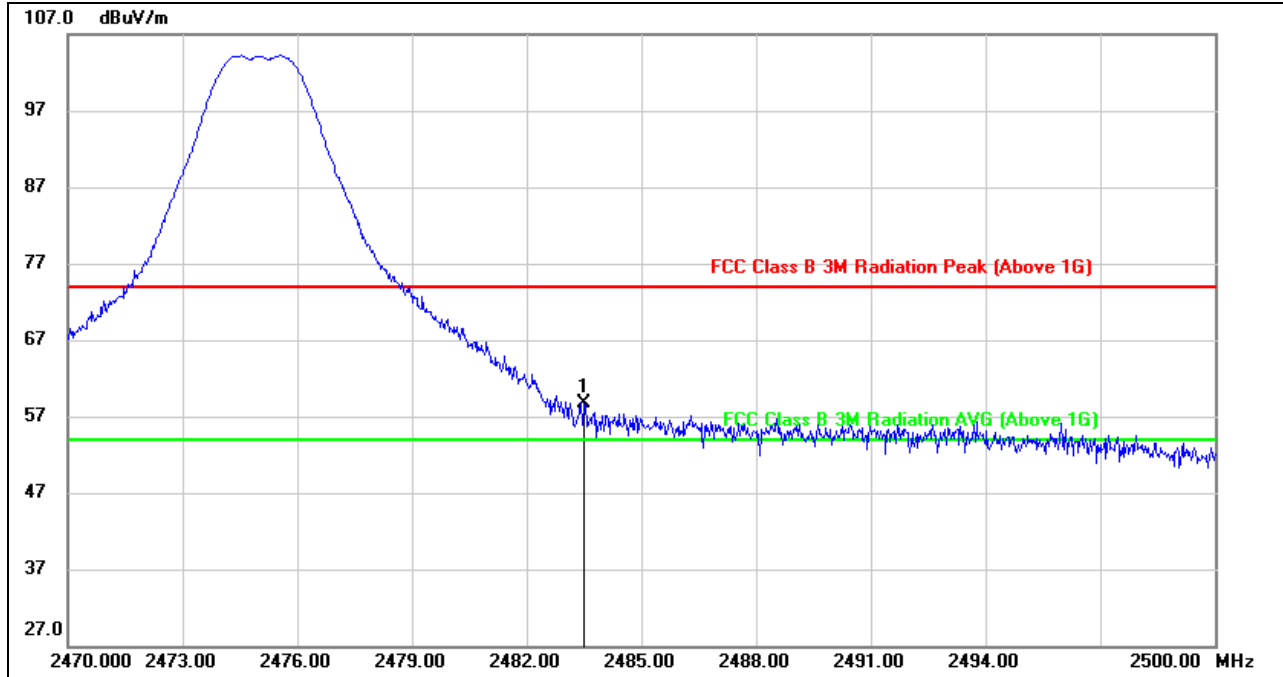

| No. | Frequency (MHz) | Reading (dBuV) | Correct (dB/m) | Result (dBuV/m) | Limit (dBuV/m) | Margin (dB) | Remark |
|-----|-----------------|----------------|----------------|-----------------|----------------|-------------|--------|
| 1 | 2483.500 | 25.03 | 33.58 | 58.61 | 74.00 | -15.39 | peak |

- Note: 1. Measurement = Reading Level + Correct Factor.
 2. If Peak Result complies with AV limit, AV Result is deemed to comply with AV limit.
 3. Peak: Peak detector.
 4. Only the worst case emission will be recorder, if it complies with the limit, the other emissions deemed to comply with the limit.



AVG

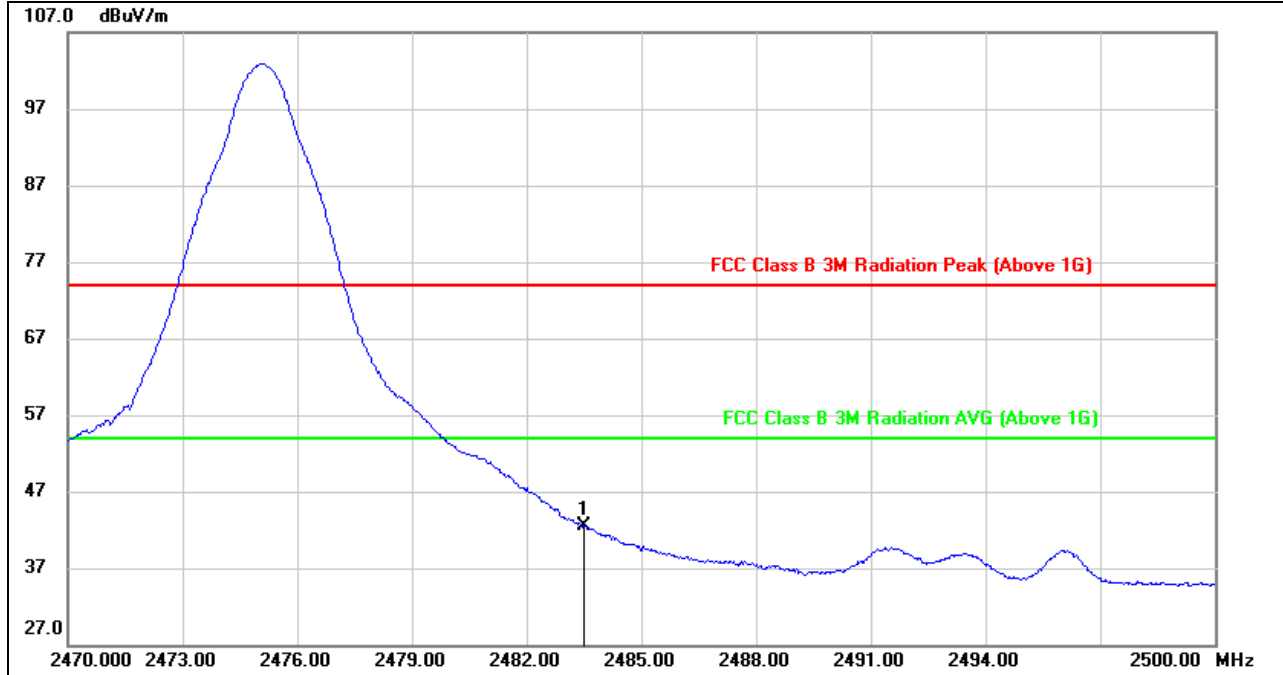

| No. | Frequency (MHz) | Reading (dBuV) | Correct (dB/m) | Result (dBuV/m) | Limit (dBuV/m) | Margin (dB) | Remark |
|-----|-----------------|----------------|----------------|-----------------|----------------|-------------|--------|
| 1 | 2483.500 | 8.90 | 33.58 | 42.48 | 54.00 | -11.52 | AVG |

- Note:
1. Measurement = Reading Level + Correct Factor.
 2. AVG: VBW=1/Ton where: ton is transmit duration.
 3. For duty cycle, please refer to clause 7.1.
 4. Only the worst case emission will be recorder, if it complies with the limit, the other emissions deemed to comply with the limit.



RESTRICTED BANDEDGE (HIGH CHANNEL, VERTICAL)
PEAK

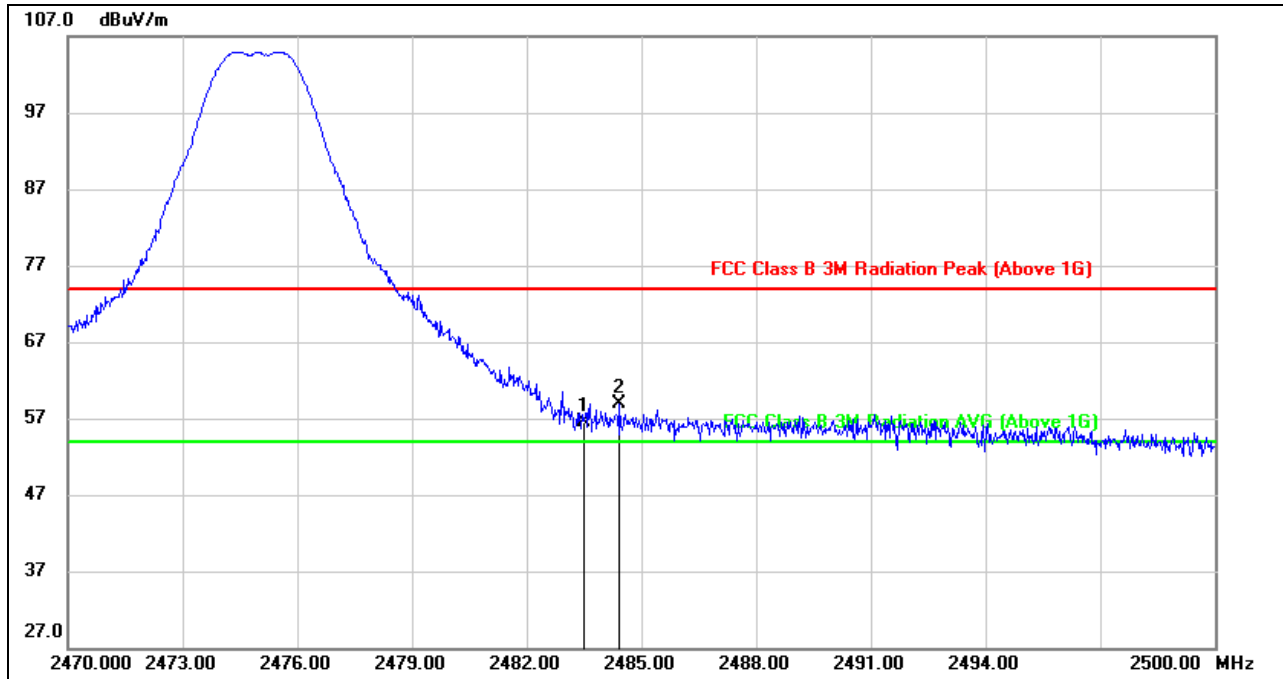

| No. | Frequency (MHz) | Reading (dBuV) | Correct (dB/m) | Result (dBuV/m) | Limit (dBuV/m) | Margin (dB) | Remark |
|-----|-----------------|----------------|----------------|-----------------|----------------|-------------|--------|
| 1 | 2483.500 | 23.02 | 33.58 | 56.60 | 74.00 | -17.40 | peak |
| 2 | 2484.430 | 25.32 | 33.59 | 58.91 | 74.00 | -15.09 | peak |

- Note: 1. Measurement = Reading Level + Correct Factor.
 2. If Peak Result complies with AV limit, AV Result is deemed to comply with AV limit.
 3. Peak: Peak detector.
 4. Only the worst case emission will be recorder, if it complies with the limit, the other emissions deemed to comply with the limit.



AVG

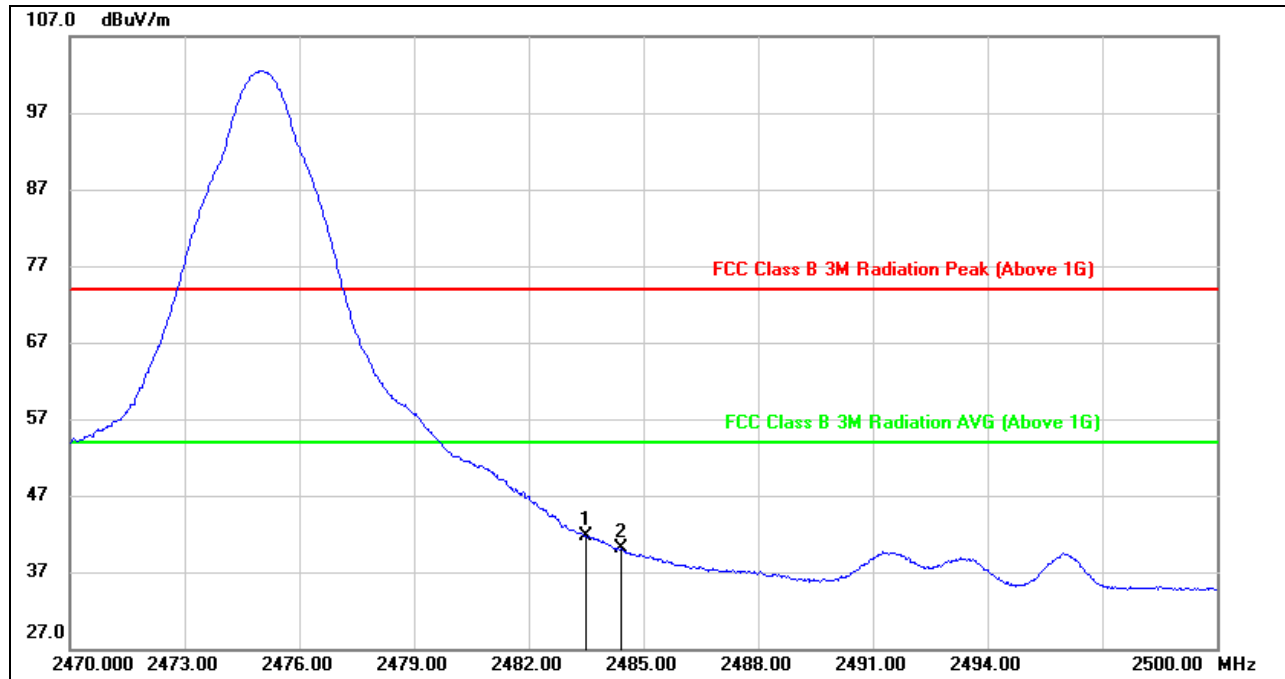

| No. | Frequency (MHz) | Reading (dBuV) | Correct (dB/m) | Result (dBuV/m) | Limit (dBuV/m) | Margin (dB) | Remark |
|-----|-----------------|----------------|----------------|-----------------|----------------|-------------|--------|
| 1 | 2483.500 | 8.12 | 33.58 | 41.70 | 54.00 | -12.30 | AVG |
| 2 | 2484.430 | 6.53 | 33.59 | 40.12 | 54.00 | -13.88 | AVG |

- Note: 1. Measurement = Reading Level + Correct Factor.
 2. AVG: VBW=1/Ton where: ton is transmit duration.
 3. For duty cycle, please refer to clause 7.1.
 4. Only the worst case emission will be recorder, if it complies with the limit, the other emissions deemed to comply with the limit.



RESTRICTED BANDEDGE (CHANNEL 26, HORIZONTAL)

PEAK

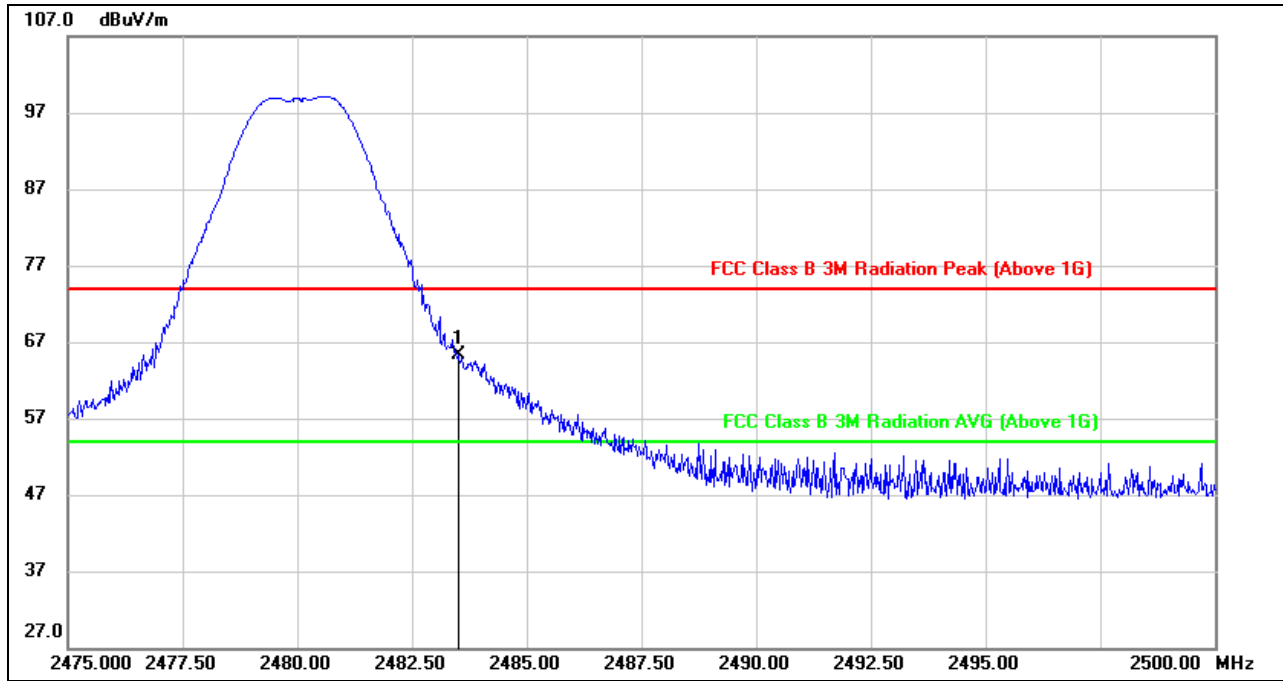

| No. | Frequency (MHz) | Reading (dBuV) | Correct (dB/m) | Result (dBuV/m) | Limit (dBuV/m) | Margin (dB) | Remark |
|-----|-----------------|----------------|----------------|-----------------|----------------|-------------|--------|
| 1 | 2483.500 | 31.80 | 33.58 | 65.38 | 74.00 | -8.62 | peak |

- Note:
1. Measurement = Reading Level + Correct Factor.
 2. If Peak Result complies with AV limit, AV Result is deemed to comply with AV limit.
 3. Peak: Peak detector.
 4. Only the worst case emission will be recorder, if it complies with the limit, the other emissions deemed to comply with the limit.



AVG

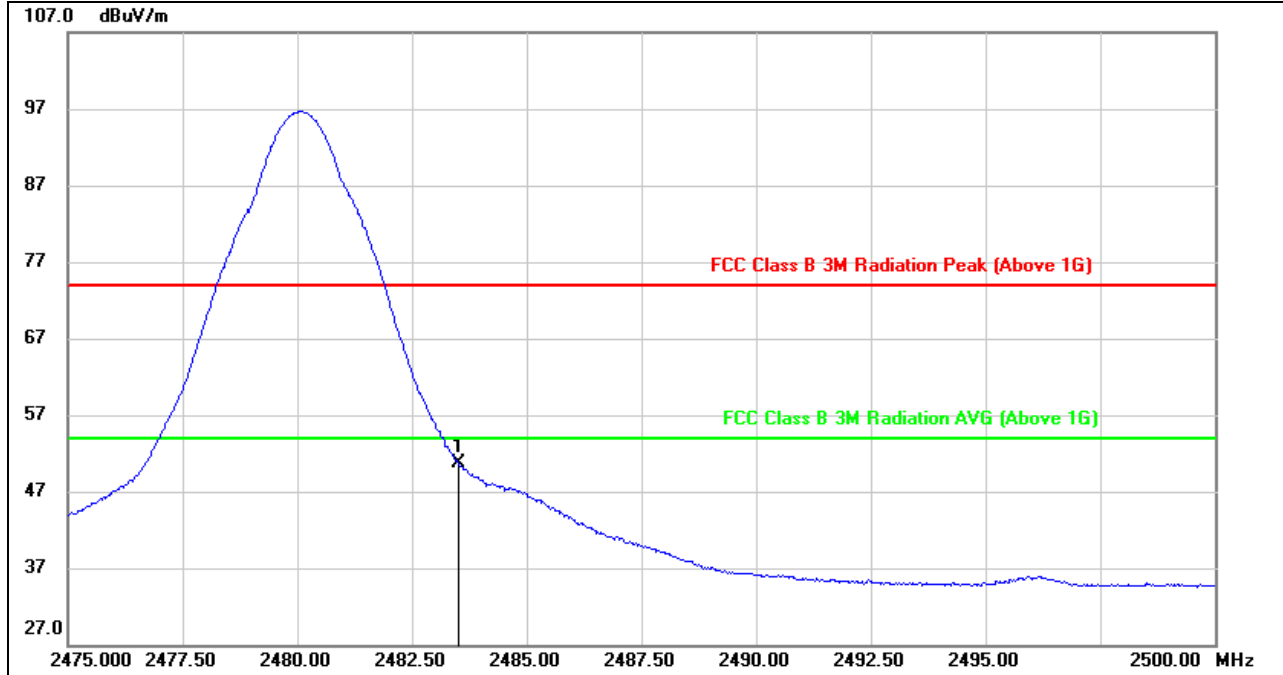

| No. | Frequency (MHz) | Reading (dBuV) | Correct (dB/m) | Result (dBuV/m) | Limit (dBuV/m) | Margin (dB) | Remark |
|-----|-----------------|----------------|----------------|-----------------|----------------|-------------|--------|
| 1 | 2483.500 | 17.07 | 33.58 | 50.65 | 54.00 | -3.35 | AVG |

- Note:
1. Measurement = Reading Level + Correct Factor.
 2. AVG: $VBW=1/Ton$ where: ton is transmit duration.
 3. For duty cycle, please refer to clause 7.1.
 4. Only the worst case emission will be recorder, if it complies with the limit, the other emissions deemed to comply with the limit.



RESTRICTED BANDEDGE (CHANNEL 26, VERTICAL)
PEAK

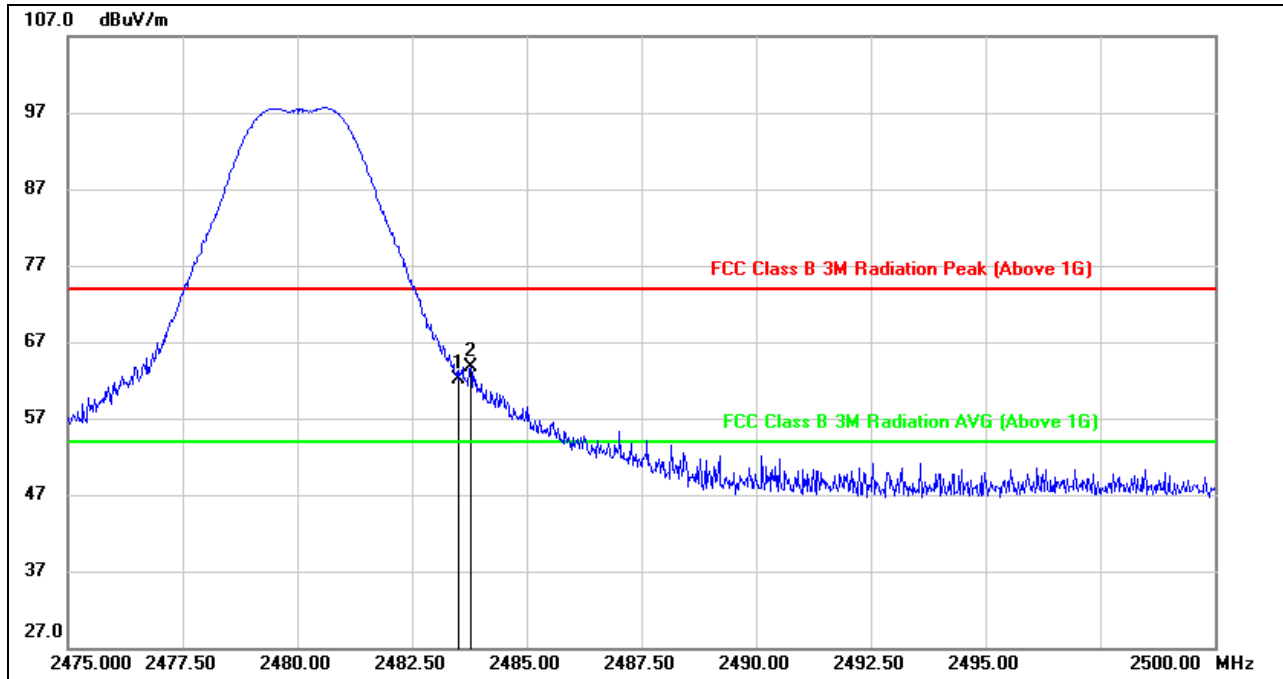

| No. | Frequency (MHz) | Reading (dBuV) | Correct (dB/m) | Result (dBuV/m) | Limit (dBuV/m) | Margin (dB) | Remark |
|-----|-----------------|----------------|----------------|-----------------|----------------|-------------|--------|
| 1 | 2483.500 | 28.50 | 33.58 | 62.08 | 74.00 | -11.92 | peak |
| 2 | 2483.775 | 30.09 | 33.58 | 63.67 | 74.00 | -10.33 | peak |

- Note: 1. Measurement = Reading Level + Correct Factor.
 2. If Peak Result complies with AV limit, AV Result is deemed to comply with AV limit.
 3. Peak: Peak detector.
 4. Only the worst case emission will be recorder, if it complies with the limit, the other emissions deemed to comply with the limit.



AVG

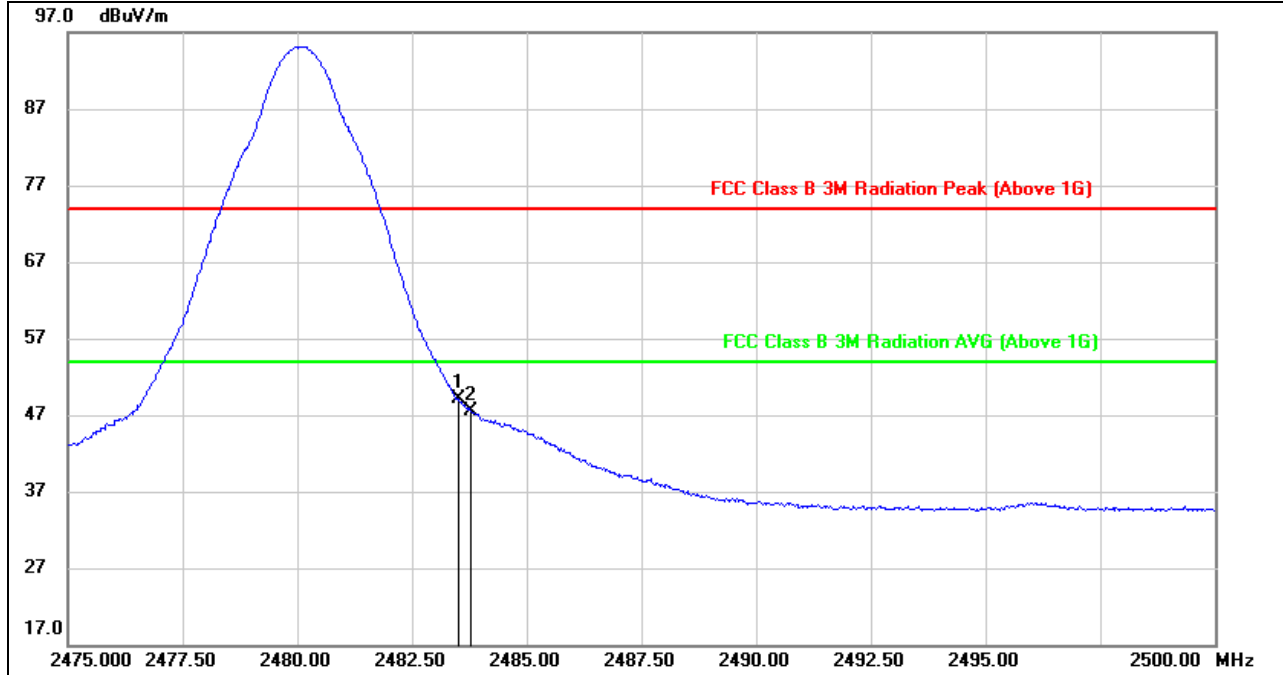

| No. | Frequency (MHz) | Reading (dBuV) | Correct (dB/m) | Result (dBuV/m) | Limit (dBuV/m) | Margin (dB) | Remark |
|-----|-----------------|----------------|----------------|-----------------|----------------|-------------|--------|
| 1 | 2483.500 | 15.46 | 33.58 | 49.04 | 54.00 | -4.96 | AVG |
| 2 | 2483.775 | 13.96 | 33.58 | 47.54 | 54.00 | -6.46 | AVG |

- Note: 1. Measurement = Reading Level + Correct Factor.
 2. AVG: $VBW=1/Ton$ where: ton is transmit duration.
 3. For duty cycle, please refer to clause 7.1.
 4. Only the worst case emission will be recorder, if it complies with the limit, the other emissions deemed to comply with the limit.



8.2. SPURIOUS EMISSIONS (1~3GHz)

HARMONICS AND SPURIOUS EMISSIONS (LOW CHANNEL, HORIZONTAL)

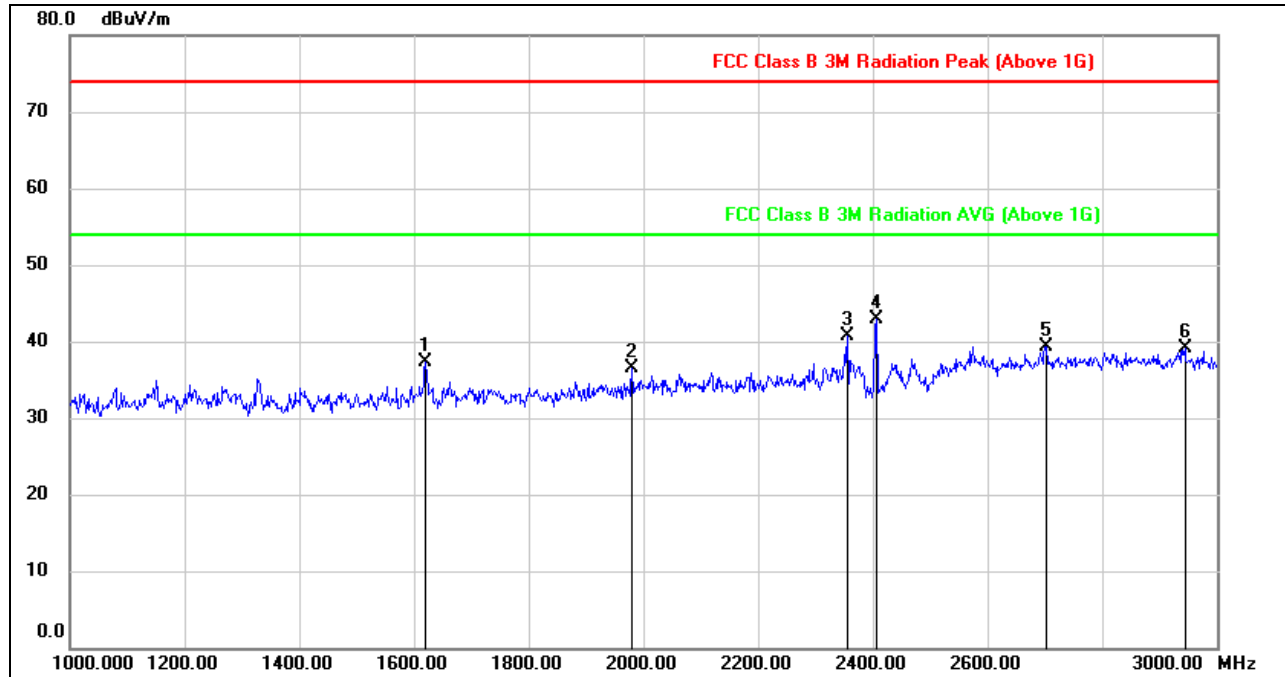

| No. | Frequency (MHz) | Reading (dBuV) | Correct (dB/m) | Result (dBuV/m) | Limit (dBuV/m) | Margin (dB) | Remark |
|-----|-----------------|----------------|----------------|-----------------|----------------|-------------|--------|
| 1 | 1620.000 | 48.00 | -10.62 | 37.38 | 74.00 | -36.62 | peak |
| 2 | 1980.000 | 46.18 | -9.69 | 36.49 | 74.00 | -37.51 | peak |
| 3 | 2356.000 | 47.97 | -7.28 | 40.69 | 74.00 | -33.31 | peak |
| 4 | 2406.000 | 50.01 | -7.06 | 42.95 | 74.00 | -31.05 | peak |
| 5 | 2702.000 | 46.69 | -7.37 | 39.32 | 74.00 | -34.68 | peak |
| 6 | 2944.000 | 43.93 | -4.90 | 39.03 | 74.00 | -34.97 | peak |

- Note: 1. Measurement = Reading Level + Correct Factor.
 2. If Peak Result complies with AV limit, AV Result is deemed to comply with AV limit.
 3. Peak: Peak detector.
 4. Filter losses were only considered in then spurious frequency bands and the authorized band was not corrected for BRF losses.
 5. Proper operation of the transmitter prior to adding the filter to the measurement chain.



HARMONICS AND SPURIOUS EMISSIONS (LOW CHANNEL, VERTICAL)

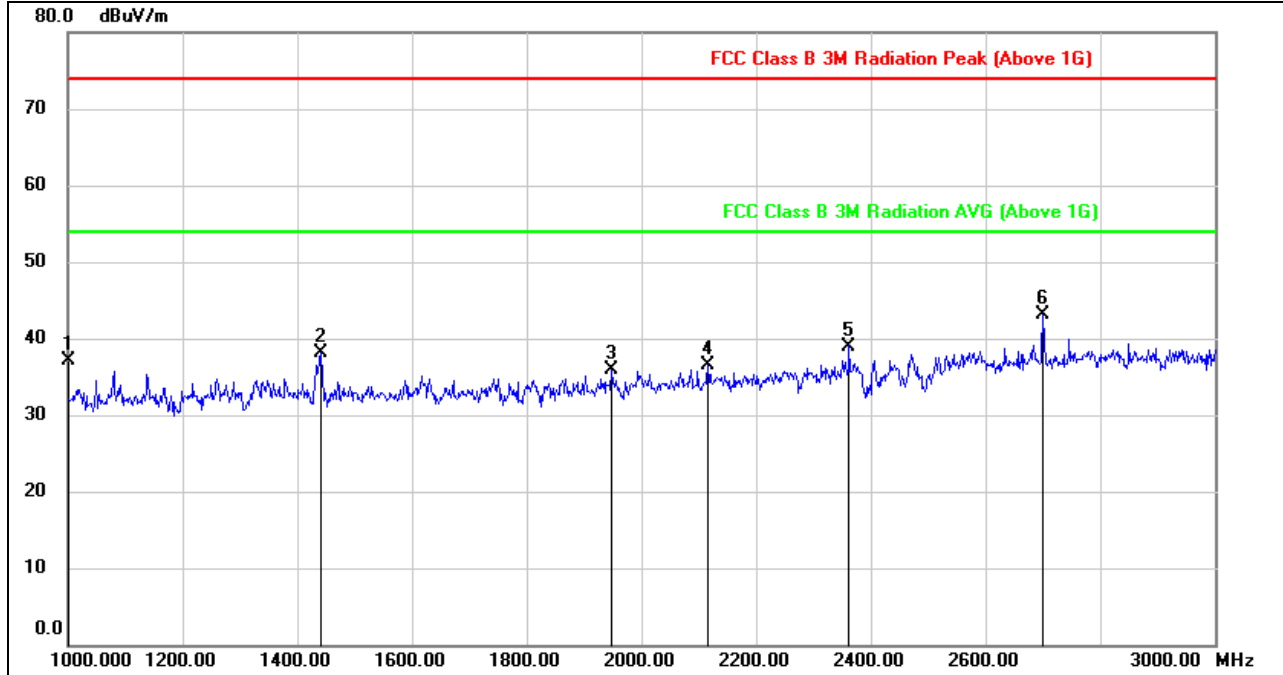

| No. | Frequency (MHz) | Reading (dBuV) | Correct (dB/m) | Result (dBuV/m) | Limit (dBuV/m) | Margin (dB) | Remark |
|-----|-----------------|----------------|----------------|-----------------|----------------|-------------|--------|
| 1 | 1000.0000 | 50.28 | -13.11 | 37.17 | 74.00 | -36.83 | peak |
| 2 | 1440.000 | 49.92 | -11.79 | 38.13 | 74.00 | -35.87 | peak |
| 3 | 1948.000 | 45.49 | -9.53 | 35.96 | 74.00 | -38.04 | peak |
| 4 | 2116.000 | 44.90 | -8.34 | 36.56 | 74.00 | -37.44 | peak |
| 5 | 2362.000 | 46.26 | -7.26 | 39.00 | 74.00 | -35.00 | peak |
| 6 | 2700.000 | 50.55 | -7.42 | 43.13 | 74.00 | -30.87 | peak |

- Note: 1. Measurement = Reading Level + Correct Factor.
 2. If Peak Result complies with AV limit, AV Result is deemed to comply with AV limit.
 3. Peak: Peak detector.
 4. Filter losses were only considered in then spurious frequency bands and the authorized band was not corrected for BRF losses.
 5. Proper operation of the transmitter prior to adding the filter to the measurement chain.



HARMONICS AND SPURIOUS EMISSIONS (MID CHANNEL, HORIZONTAL)

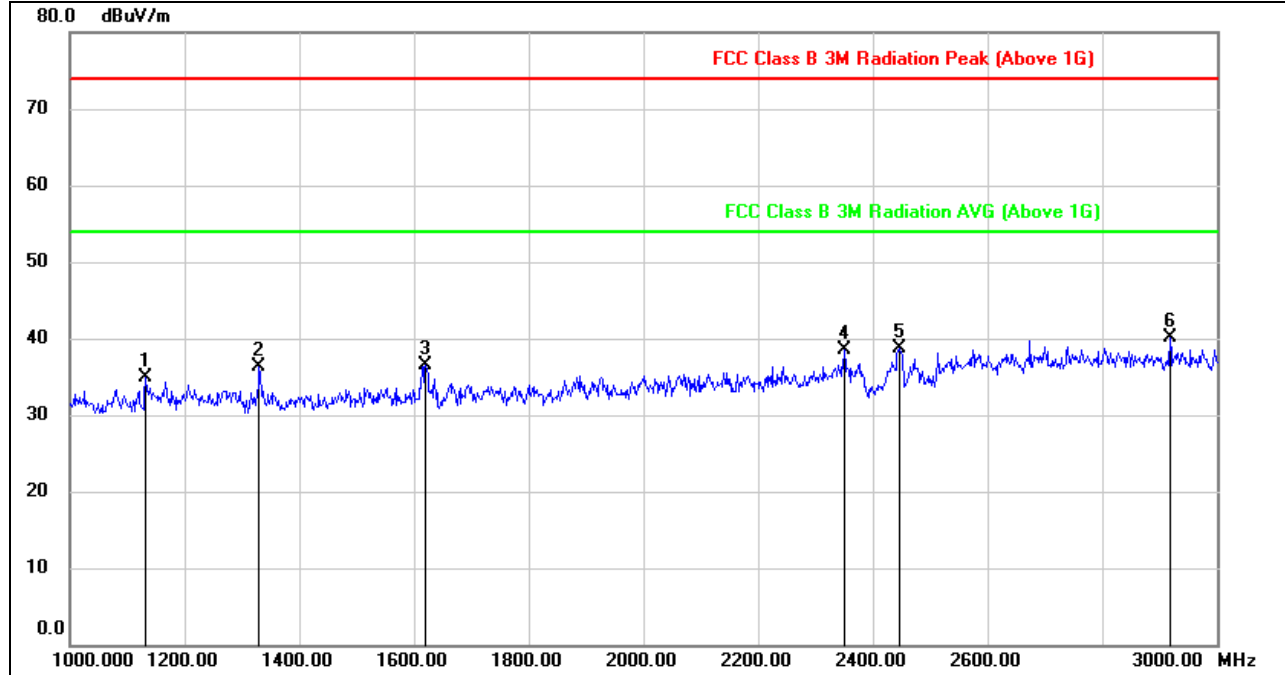

| No. | Frequency (MHz) | Reading (dBuV) | Correct (dB/m) | Result (dBuV/m) | Limit (dBuV/m) | Margin (dB) | Remark |
|-----|-----------------|----------------|----------------|-----------------|----------------|-------------|--------|
| 1 | 1132.000 | 47.35 | -12.54 | 34.81 | 74.00 | -39.19 | peak |
| 2 | 1330.000 | 47.80 | -11.42 | 36.38 | 74.00 | -37.62 | peak |
| 3 | 1620.000 | 47.09 | -10.62 | 36.47 | 74.00 | -37.53 | peak |
| 4 | 2350.000 | 45.71 | -7.30 | 38.41 | 74.00 | -35.59 | peak |
| 5 | 2446.000 | 45.38 | -6.75 | 38.63 | 74.00 | -35.37 | peak |
| 6 | 2918.000 | 45.22 | -5.05 | 40.17 | 74.00 | -33.83 | peak |

- Note: 1. Measurement = Reading Level + Correct Factor.
 2. If Peak Result complies with AV limit, AV Result is deemed to comply with AV limit.
 3. Peak: Peak detector.
 4. Filter losses were only considered in then spurious frequency bands and the authorized band was not corrected for BRF losses.
 5. Proper operation of the transmitter prior to adding the filter to the measurement chain.



HARMONICS AND SPURIOUS EMISSIONS (MID CHANNEL, VERTICAL)

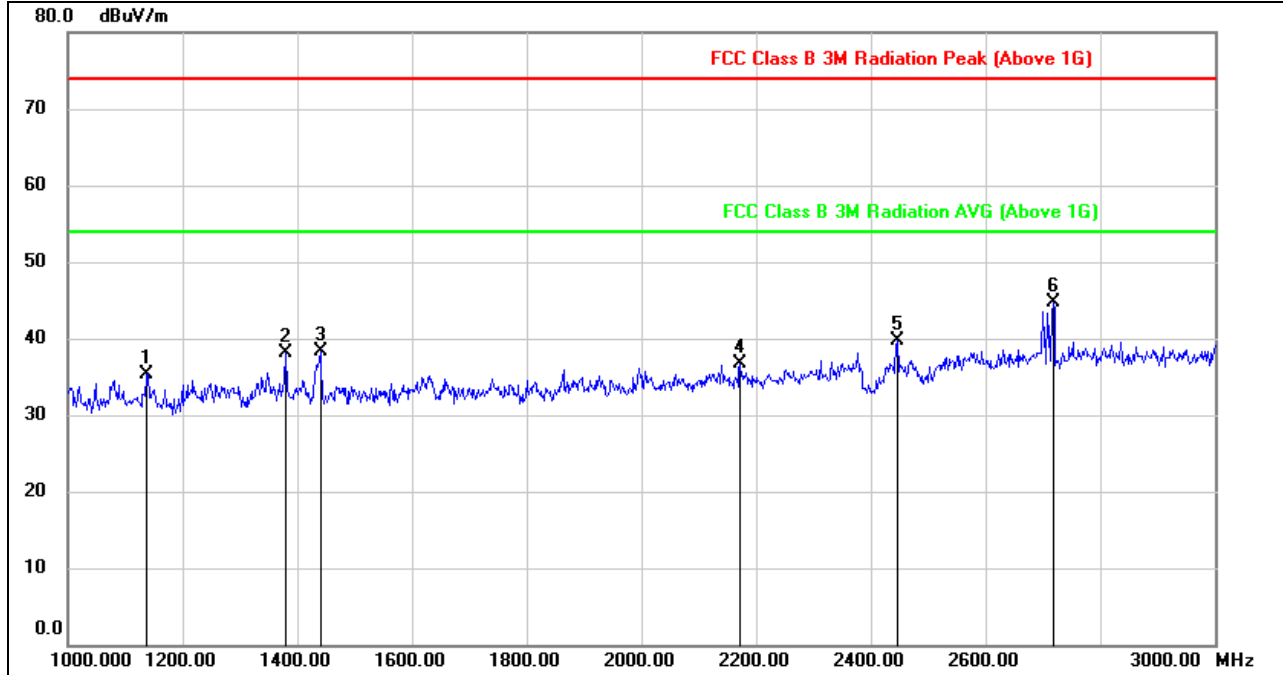

| No. | Frequency (MHz) | Reading (dBuV) | Correct (dB/m) | Result (dBuV/m) | Limit (dBuV/m) | Margin (dB) | Remark |
|-----|-----------------|----------------|----------------|-----------------|----------------|-------------|--------|
| 1 | 1138.000 | 47.80 | -12.53 | 35.27 | 74.00 | -38.73 | peak |
| 2 | 1380.000 | 49.86 | -11.78 | 38.08 | 74.00 | -35.92 | peak |
| 3 | 1440.000 | 50.10 | -11.79 | 38.31 | 74.00 | -35.69 | peak |
| 4 | 2172.000 | 45.12 | -8.40 | 36.72 | 74.00 | -37.28 | peak |
| 5 | 2446.000 | 46.52 | -6.75 | 39.77 | 74.00 | -34.23 | peak |
| 6 | 2718.000 | 51.82 | -7.03 | 44.79 | 74.00 | -29.21 | peak |

- Note: 1. Measurement = Reading Level + Correct Factor.
 2. If Peak Result complies with AV limit, AV Result is deemed to comply with AV limit.
 3. Peak: Peak detector.
 4. Filter losses were only considered in then spurious frequency bands and the authorized band was not corrected for BRF losses.
 5. Proper operation of the transmitter prior to adding the filter to the measurement chain.



HARMONICS AND SPURIOUS EMISSIONS (HIGH CHANNEL, HORIZONTAL)

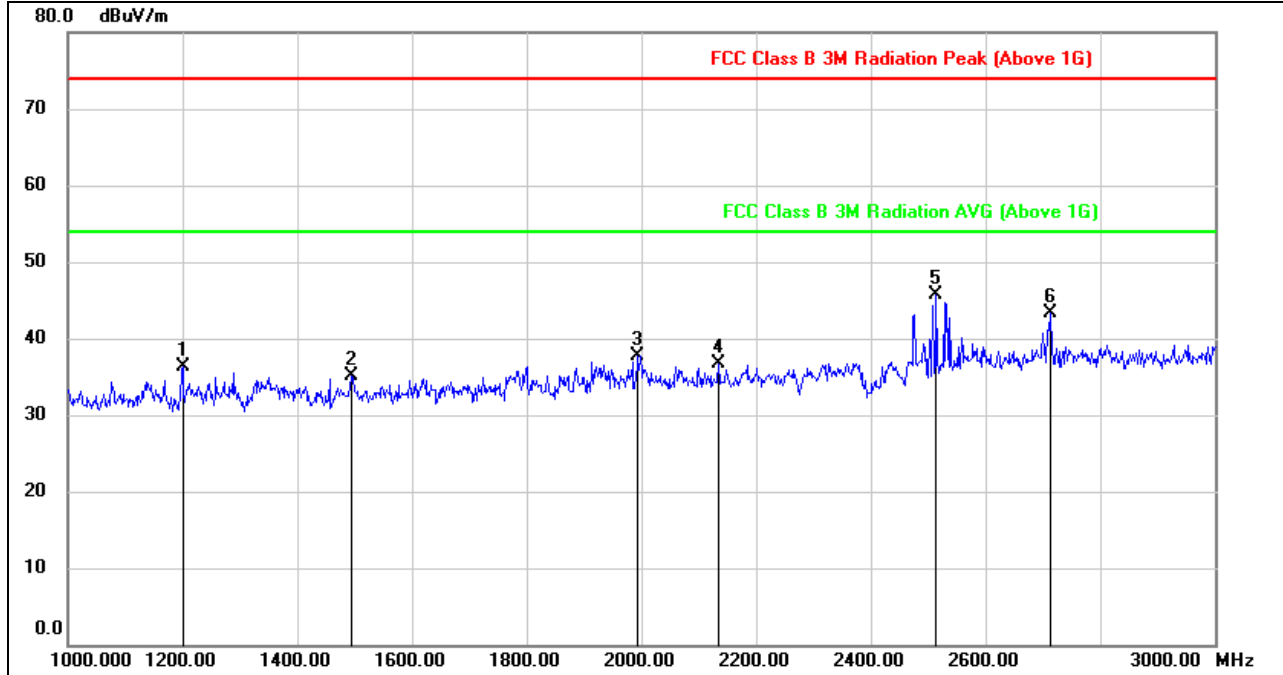

| No. | Frequency (MHz) | Reading (dBuV) | Correct (dB/m) | Result (dBuV/m) | Limit (dBuV/m) | Margin (dB) | Remark |
|-----|-----------------|----------------|----------------|-----------------|----------------|-------------|--------|
| 1 | 1200.000 | 48.70 | -12.44 | 36.26 | 74.00 | -37.74 | peak |
| 2 | 1494.000 | 46.66 | -11.62 | 35.04 | 74.00 | -38.96 | peak |
| 3 | 1994.000 | 47.53 | -9.75 | 37.78 | 74.00 | -36.22 | peak |
| 4 | 2134.000 | 45.08 | -8.36 | 36.72 | 74.00 | -37.28 | peak |
| 5 | 2514.000 | 52.07 | -6.40 | 45.67 | 74.00 | -28.33 | peak |
| 6 | 2714.000 | 50.34 | -7.11 | 43.23 | 74.00 | -30.77 | peak |

- Note: 1. Measurement = Reading Level + Correct Factor.
 2. If Peak Result complies with AV limit, AV Result is deemed to comply with AV limit.
 3. Peak: Peak detector.
 4. Filter losses were only considered in then spurious frequency bands and the authorized band was not corrected for BRF losses.
 5. Proper operation of the transmitter prior to adding the filter to the measurement chain.



HARMONICS AND SPURIOUS EMISSIONS (HIGH CHANNEL, VERTICAL)

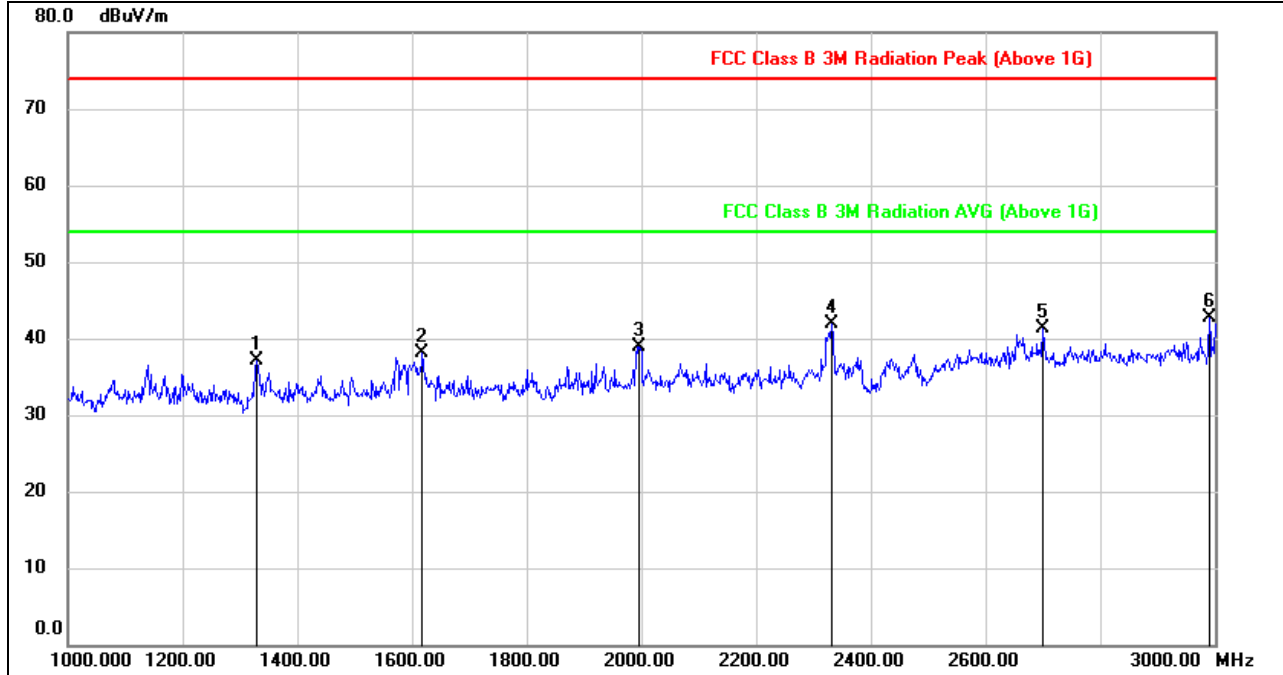

| No. | Frequency (MHz) | Reading (dBuV) | Correct (dB/m) | Result (dBuV/m) | Limit (dBuV/m) | Margin (dB) | Remark |
|-----|-----------------|----------------|----------------|-----------------|----------------|-------------|--------|
| 1 | 1328.000 | 48.56 | -11.41 | 37.15 | 74.00 | -36.85 | peak |
| 2 | 1618.000 | 48.64 | -10.62 | 38.02 | 74.00 | -35.98 | peak |
| 3 | 1996.000 | 48.68 | -9.77 | 38.91 | 74.00 | -35.09 | peak |
| 4 | 2332.000 | 49.27 | -7.37 | 41.90 | 74.00 | -32.10 | peak |
| 5 | 2700.000 | 48.75 | -7.42 | 41.33 | 74.00 | -32.67 | peak |
| 6 | 2990.000 | 47.29 | -4.65 | 42.64 | 74.00 | -31.36 | peak |

- Note: 1. Measurement = Reading Level + Correct Factor.
 2. If Peak Result complies with AV limit, AV Result is deemed to comply with AV limit.
 3. Peak: Peak detector.
 4. Filter losses were only considered in then spurious frequency bands and the authorized band was not corrected for BRF losses.
 5. Proper operation of the transmitter prior to adding the filter to the measurement chain.



HARMONICS AND SPURIOUS EMISSIONS (CHANNEL26, HORIZONTAL)

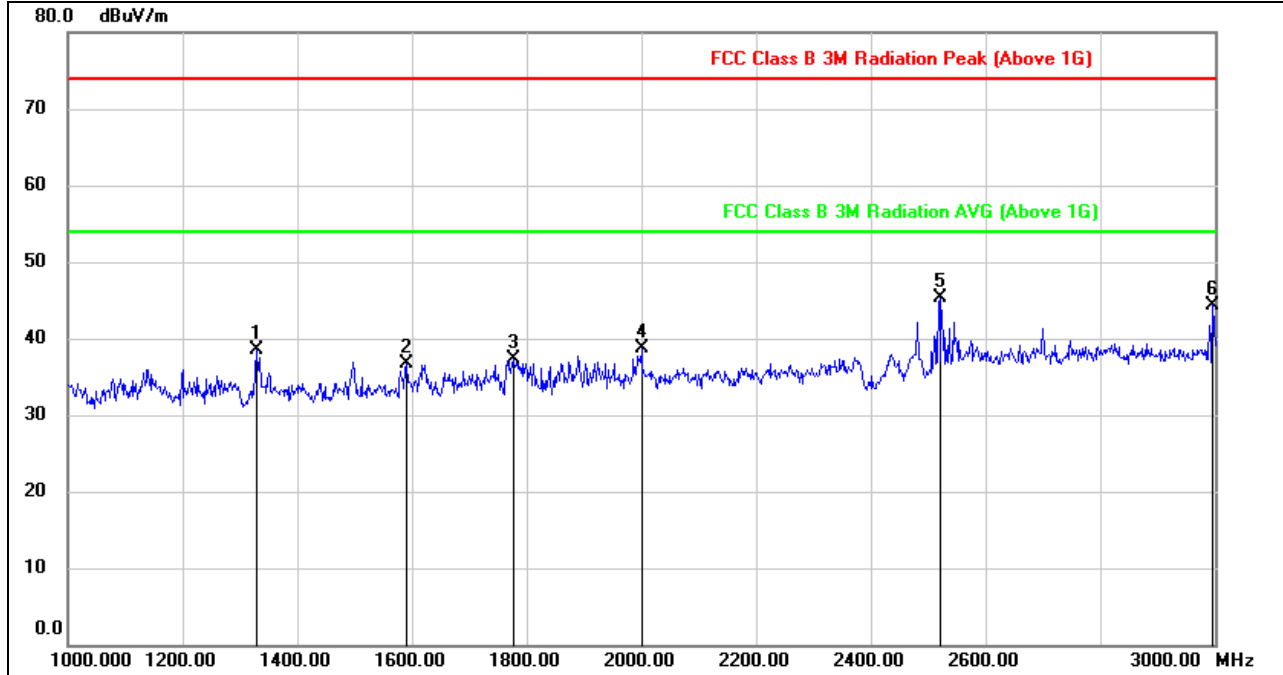

| No. | Frequency (MHz) | Reading (dBuV) | Correct (dB/m) | Result (dBuV/m) | Limit (dBuV/m) | Margin (dB) | Remark |
|-----|-----------------|----------------|----------------|-----------------|----------------|-------------|--------|
| 1 | 1328.000 | 49.82 | -11.41 | 38.41 | 74.00 | -35.59 | peak |
| 2 | 1590.000 | 47.40 | -10.71 | 36.69 | 74.00 | -37.31 | peak |
| 3 | 1776.000 | 46.98 | -9.73 | 37.25 | 74.00 | -36.75 | peak |
| 4 | 2000.000 | 48.54 | -9.78 | 38.76 | 74.00 | -35.24 | peak |
| 5 | 2522.000 | 51.73 | -6.44 | 45.29 | 74.00 | -28.71 | peak |
| 6 | 2996.000 | 49.00 | -4.60 | 44.40 | 74.00 | -29.60 | peak |

- Note: 1. Measurement = Reading Level + Correct Factor.
 2. If Peak Result complies with AV limit, AV Result is deemed to comply with AV limit.
 3. Peak: Peak detector.
 4. Filter losses were only considered in then spurious frequency bands and the authorized band was not corrected for BRF losses.
 5. Proper operation of the transmitter prior to adding the filter to the measurement chain.



HARMONICS AND SPURIOUS EMISSIONS (CHANNEL26, VERTICAL)

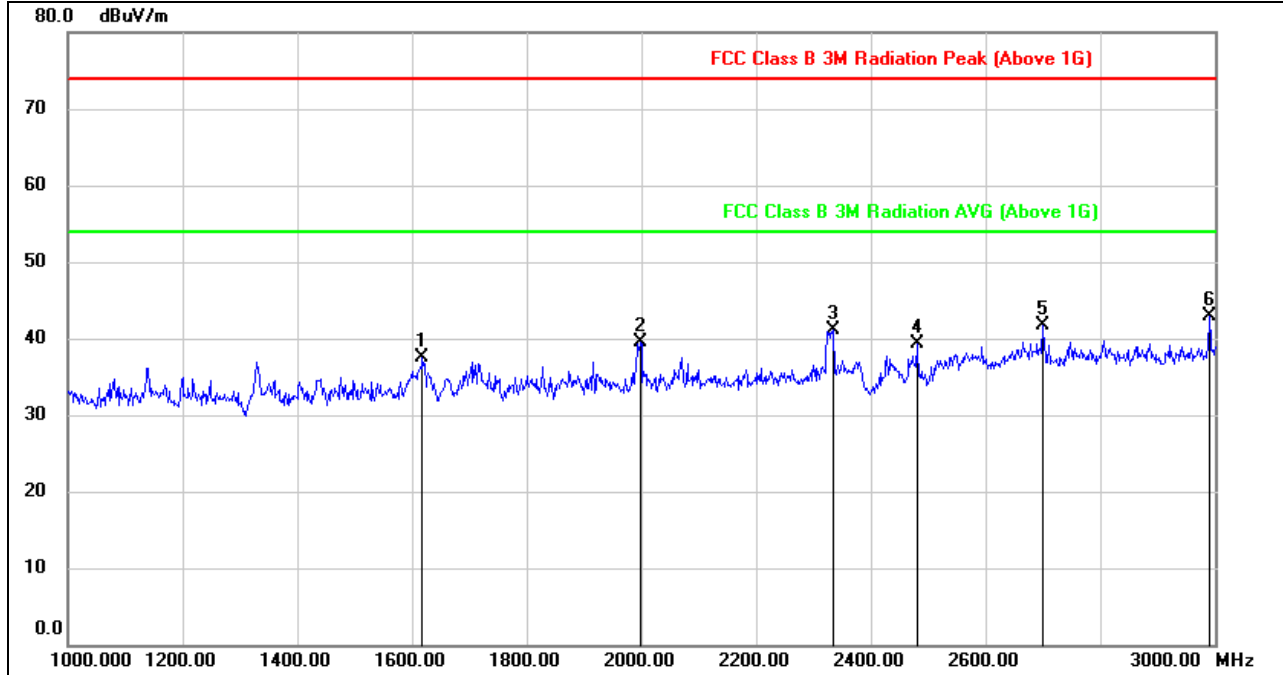

| No. | Frequency (MHz) | Reading (dBuV) | Correct (dB/m) | Result (dBuV/m) | Limit (dBuV/m) | Margin (dB) | Remark |
|-----|-----------------|----------------|----------------|-----------------|----------------|-------------|--------|
| 1 | 1618.000 | 48.20 | -10.62 | 37.58 | 74.00 | -36.42 | peak |
| 2 | 1998.000 | 49.31 | -9.77 | 39.54 | 74.00 | -34.46 | peak |
| 3 | 2334.000 | 48.49 | -7.37 | 41.12 | 74.00 | -32.88 | peak |
| 4 | 2480.000 | 45.74 | -6.49 | 39.25 | 74.00 | -34.75 | peak |
| 5 | 2700.000 | 49.15 | -7.42 | 41.73 | 74.00 | -32.27 | peak |
| 6 | 2990.000 | 47.58 | -4.65 | 42.93 | 74.00 | -31.07 | peak |

- Note: 1. Measurement = Reading Level + Correct Factor.
 2. If Peak Result complies with AV limit, AV Result is deemed to comply with AV limit.
 3. Peak: Peak detector.
 4. Filter losses were only considered in then spurious frequency bands and the authorized band was not corrected for BRF losses.
 5. Proper operation of the transmitter prior to adding the filter to the measurement chain.



8.3. SPURIOUS EMISSIONS (3~18GHz)

HARMONICS AND SPURIOUS EMISSIONS (LOW CHANNEL, HORIZONTAL)

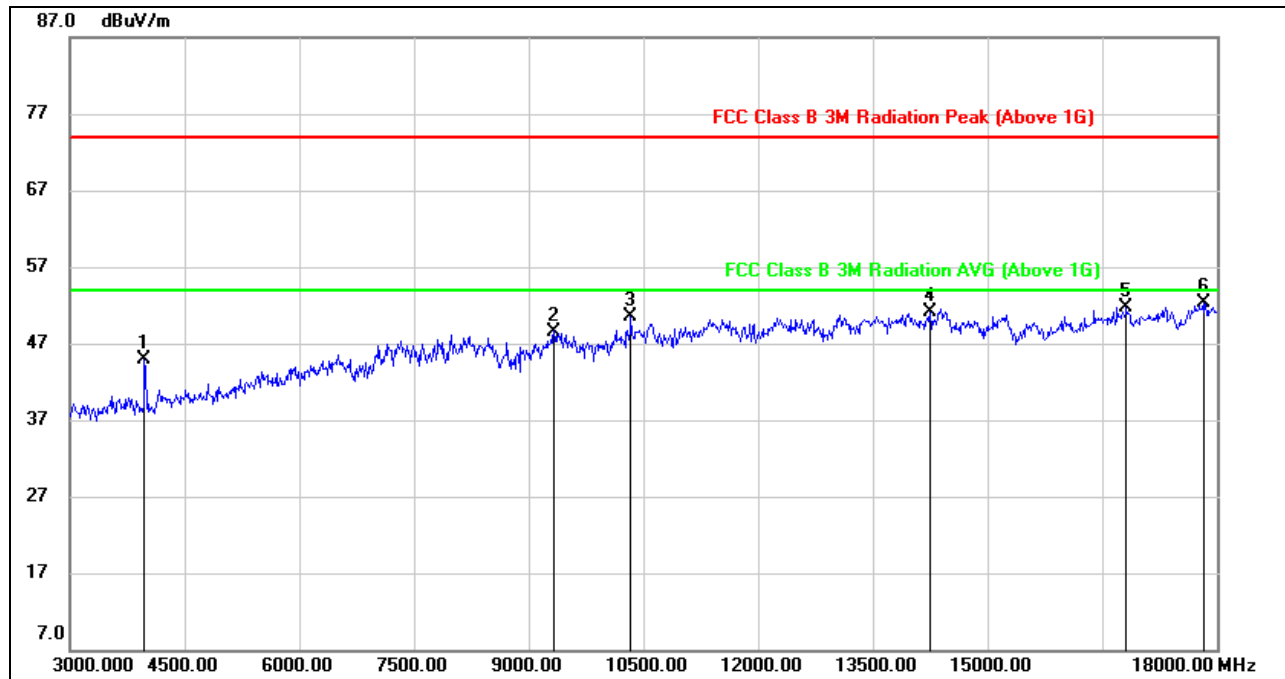

| No. | Frequency (MHz) | Reading (dBuV) | Correct (dB/m) | Result (dBuV/m) | Limit (dBuV/m) | Margin (dB) | Remark |
|-----|-----------------|----------------|----------------|-----------------|----------------|-------------|--------|
| 1 | 3975.000 | 47.89 | -2.98 | 44.91 | 74.00 | -29.09 | peak |
| 2 | 9330.000 | 38.75 | 9.85 | 48.60 | 74.00 | -25.40 | peak |
| 3 | 10335.000 | 38.89 | 11.57 | 50.46 | 74.00 | -23.54 | peak |
| 4 | 14250.000 | 34.62 | 16.39 | 51.01 | 74.00 | -22.99 | peak |
| 5 | 16815.000 | 31.78 | 19.92 | 51.70 | 74.00 | -22.30 | peak |
| 6 | 17820.000 | 29.12 | 23.21 | 52.33 | 74.00 | -21.67 | peak |

- Note: 1. Measurement = Reading Level + Correct Factor.
 2. If Peak Result complies with AV limit, AV Result is deemed to comply with AV limit.
 3. Peak: Peak detector.
 4. The High Pass filter loss factor already add into the correct factor.
 5. Proper operation of the transmitter prior to adding the filter to the measurement chain.



HARMONICS AND SPURIOUS EMISSIONS (LOW CHANNEL, VERTICAL)

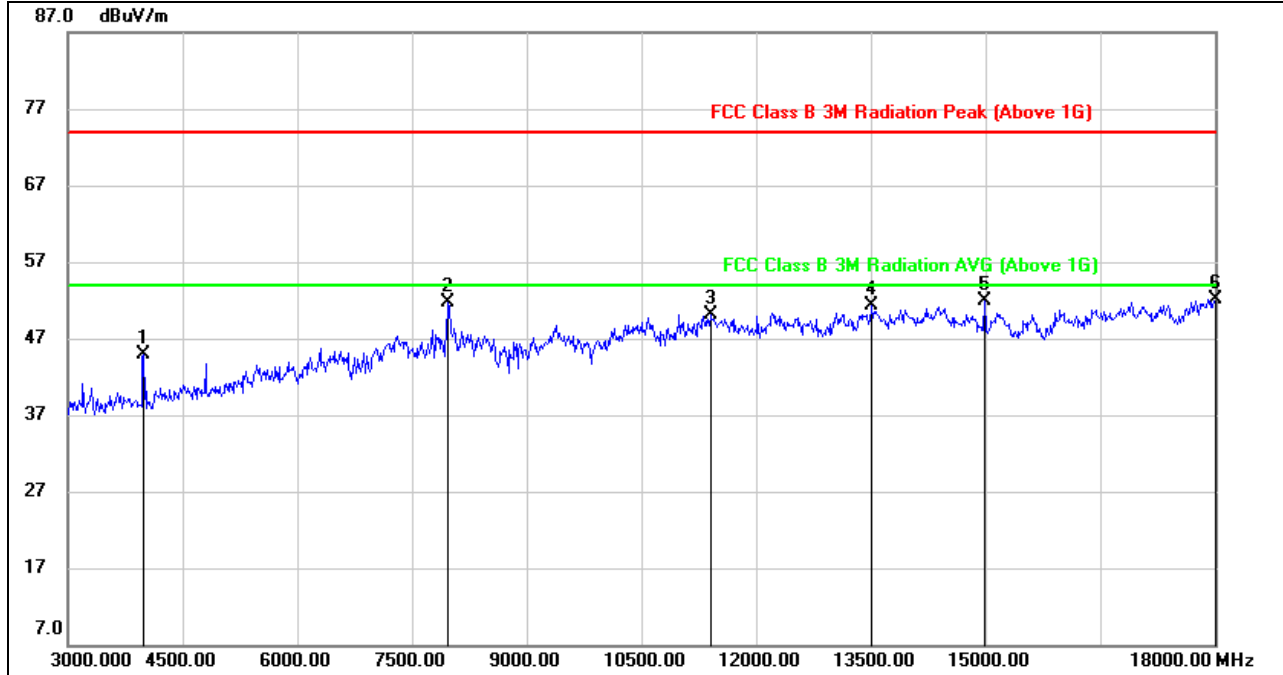

| No. | Frequency (MHz) | Reading (dBuV) | Correct (dB/m) | Result (dBuV/m) | Limit (dBuV/m) | Margin (dB) | Remark |
|-----|-----------------|----------------|----------------|-----------------|----------------|-------------|--------|
| 1 | 3990.000 | 47.89 | -2.95 | 44.94 | 74.00 | -29.06 | peak |
| 2 | 7965.000 | 43.37 | 8.26 | 51.63 | 74.00 | -22.37 | peak |
| 3 | 11400.000 | 36.80 | 13.36 | 50.16 | 74.00 | -23.84 | peak |
| 4 | 13515.000 | 35.51 | 15.72 | 51.23 | 74.00 | -22.77 | peak |
| 5 | 14985.000 | 36.35 | 15.47 | 51.82 | 74.00 | -22.18 | peak |
| 6 | 18000.000 | 28.93 | 23.27 | 52.20 | 74.00 | -21.80 | peak |

- Note: 1. Measurement = Reading Level + Correct Factor.
 2. If Peak Result complies with AV limit, AV Result is deemed to comply with AV limit.
 3. Peak: Peak detector.
 4. The High Pass filter loss factor already add into the correct factor.
 5. Proper operation of the transmitter prior to adding the filter to the measurement chain.



HARMONICS AND SPURIOUS EMISSIONS (MID CHANNEL, HORIZONTAL)

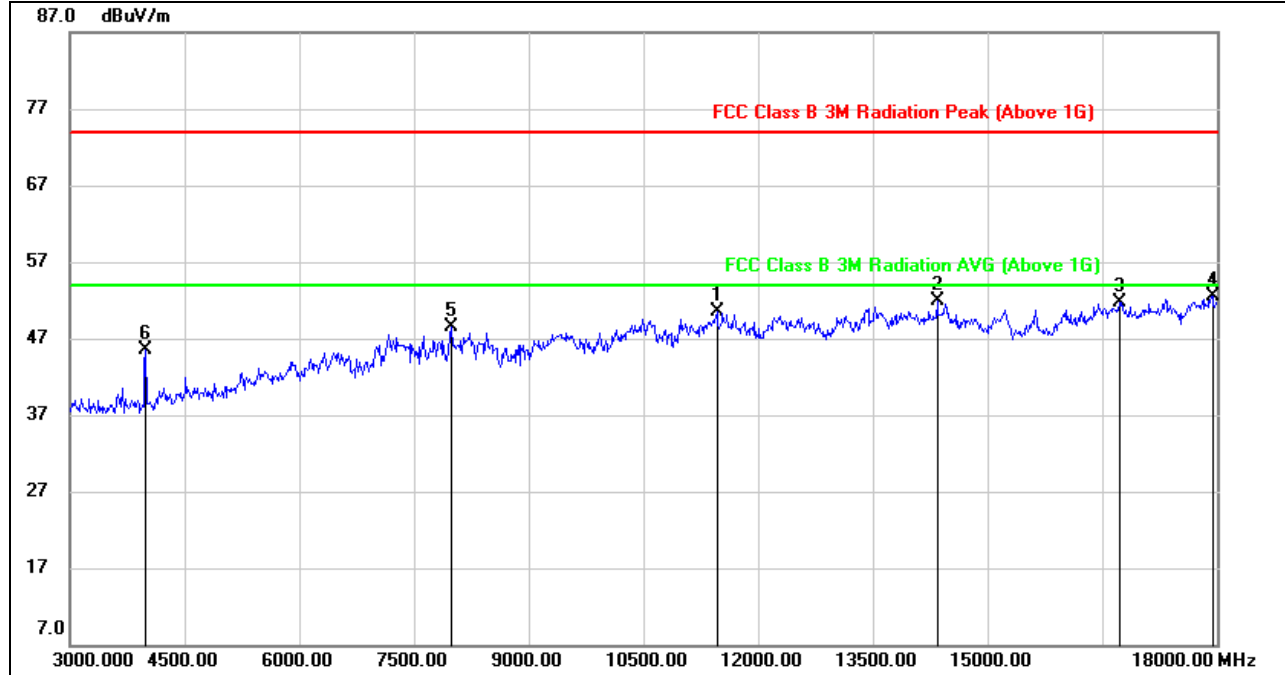

| No. | Frequency (MHz) | Reading (dBuV) | Correct (dB/m) | Result (dBuV/m) | Limit (dBuV/m) | Margin (dB) | Remark |
|-----|-----------------|----------------|----------------|-----------------|----------------|-------------|--------|
| 1 | 11460.000 | 36.75 | 13.79 | 50.54 | 74.00 | -23.46 | peak |
| 2 | 14340.000 | 35.47 | 16.36 | 51.83 | 74.00 | -22.17 | peak |
| 3 | 16725.000 | 31.91 | 19.85 | 51.76 | 74.00 | -22.24 | peak |
| 4 | 17940.000 | 29.23 | 23.21 | 52.44 | 74.00 | -21.56 | peak |
| 5 | 7995.000 | 40.43 | 8.16 | 48.59 | 74.00 | -25.41 | peak |
| 6 | 3990.000 | 48.47 | -2.95 | 45.52 | 74.00 | -28.48 | peak |

- Note: 1. Measurement = Reading Level + Correct Factor.
 2. If Peak Result complies with AV limit, AV Result is deemed to comply with AV limit.
 3. Peak: Peak detector.
 4. The High Pass filter loss factor already add into the correct factor.
 5. Proper operation of the transmitter prior to adding the filter to the measurement chain.



HARMONICS AND SPURIOUS EMISSIONS (MID CHANNEL, VERTICAL)

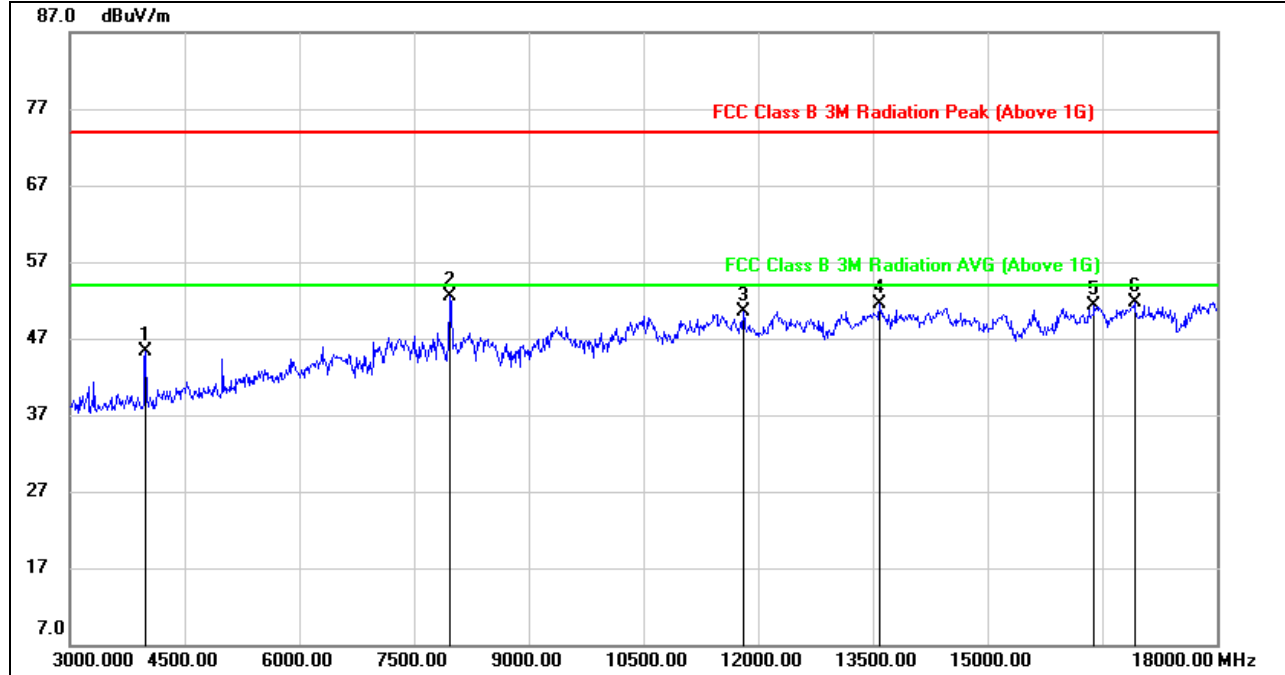

| No. | Frequency (MHz) | Reading (dBuV) | Correct (dB/m) | Result (dBuV/m) | Limit (dBuV/m) | Margin (dB) | Remark |
|-----|-----------------|----------------|----------------|-----------------|----------------|-------------|--------|
| 1 | 3990.000 | 48.25 | -2.95 | 45.30 | 74.00 | -28.70 | peak |
| 2 | 7965.000 | 44.17 | 8.26 | 52.43 | 74.00 | -21.57 | peak |
| 3 | 11805.000 | 36.83 | 13.66 | 50.49 | 74.00 | -23.51 | peak |
| 4 | 13590.000 | 35.45 | 16.04 | 51.49 | 74.00 | -22.51 | peak |
| 5 | 16395.000 | 32.81 | 18.55 | 51.36 | 74.00 | -22.64 | peak |
| 6 | 16920.000 | 31.64 | 20.01 | 51.65 | 74.00 | -22.35 | peak |

- Note: 1. Measurement = Reading Level + Correct Factor.
 2. If Peak Result complies with AV limit, AV Result is deemed to comply with AV limit.
 3. Peak: Peak detector.
 4. The High Pass filter loss factor already add into the correct factor.
 5. Proper operation of the transmitter prior to adding the filter to the measurement chain.



HARMONICS AND SPURIOUS EMISSIONS (HIGH CHANNEL, HORIZONTAL)

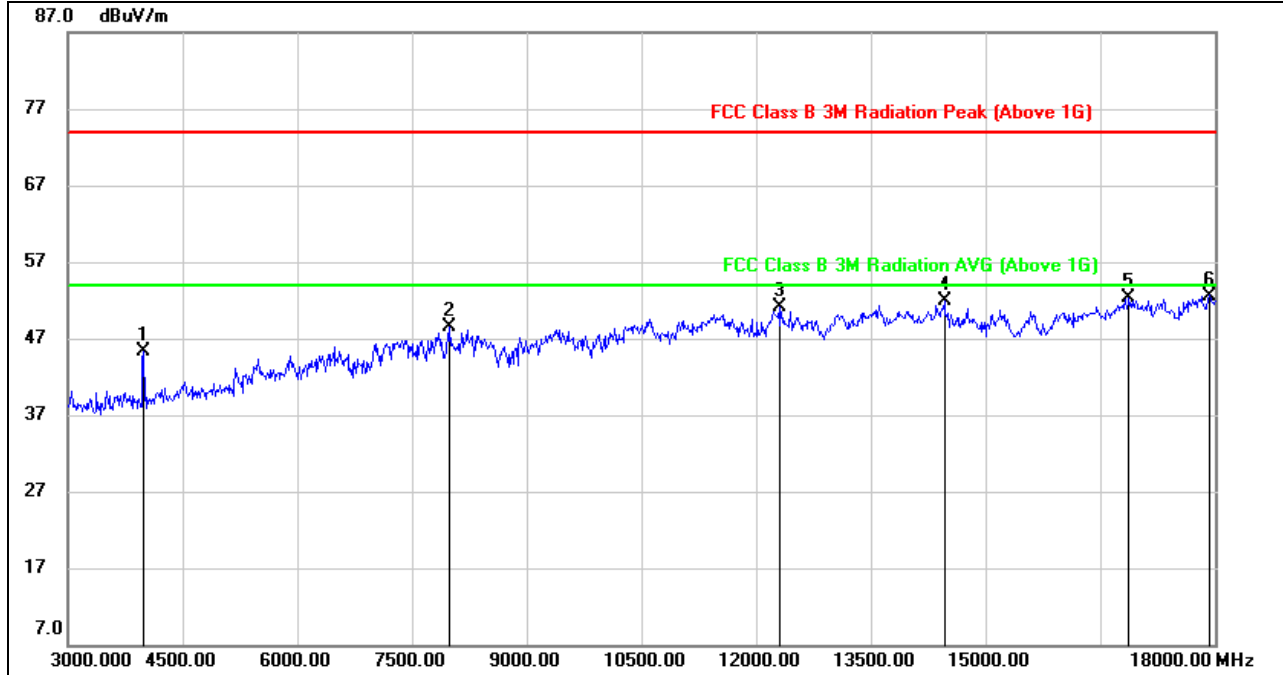

| No. | Frequency (MHz) | Reading (dBuV) | Correct (dB/m) | Result (dBuV/m) | Limit (dBuV/m) | Margin (dB) | Remark |
|-----|-----------------|----------------|----------------|-----------------|----------------|-------------|--------|
| 1 | 3990.000 | 48.22 | -2.95 | 45.27 | 74.00 | -28.73 | peak |
| 2 | 7995.000 | 40.41 | 8.16 | 48.57 | 74.00 | -25.43 | peak |
| 3 | 12300.000 | 36.69 | 14.39 | 51.08 | 74.00 | -22.92 | peak |
| 4 | 14460.000 | 35.53 | 16.35 | 51.88 | 74.00 | -22.12 | peak |
| 5 | 16875.000 | 32.33 | 19.93 | 52.26 | 74.00 | -21.74 | peak |
| 6 | 17925.000 | 29.42 | 23.18 | 52.60 | 74.00 | -21.40 | peak |

- Note: 1. Measurement = Reading Level + Correct Factor.
 2. If Peak Result complies with AV limit, AV Result is deemed to comply with AV limit.
 3. Peak: Peak detector.
 4. The High Pass filter loss factor already add into the correct factor.
 5. Proper operation of the transmitter prior to adding the filter to the measurement chain.



HARMONICS AND SPURIOUS EMISSIONS (HIGH CHANNEL, VERTICAL)

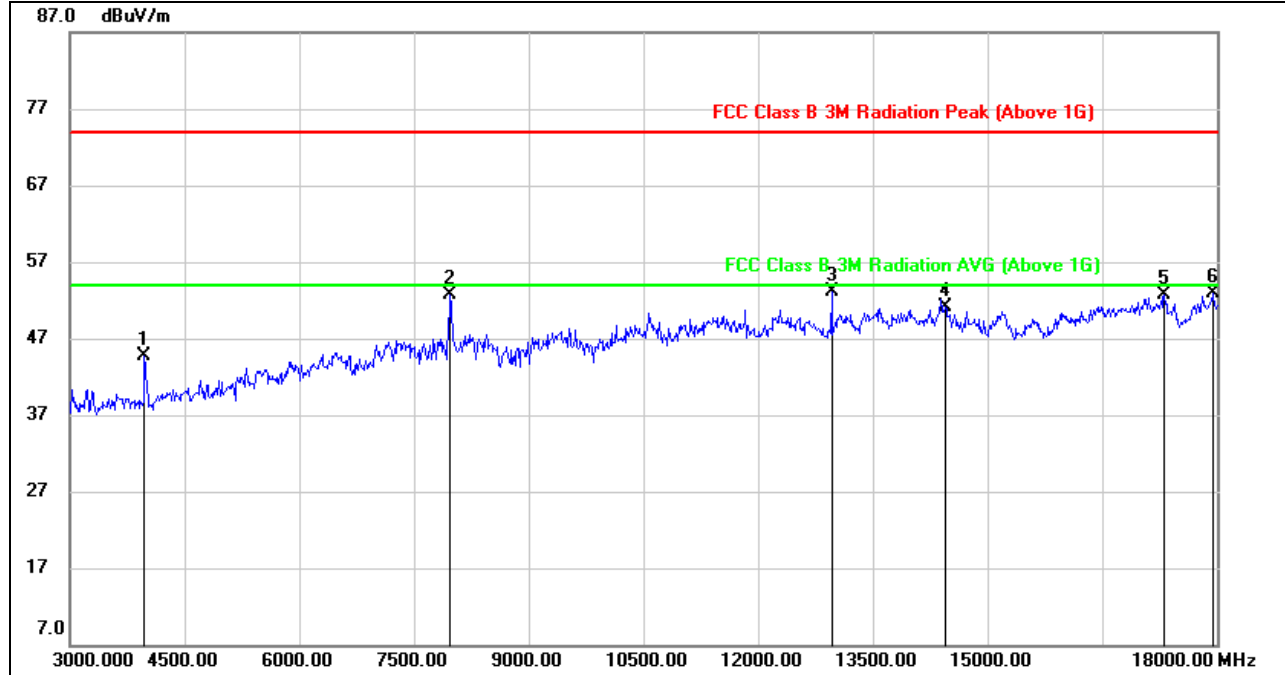

| No. | Frequency (MHz) | Reading (dBuV) | Correct (dB/m) | Result (dBuV/m) | Limit (dBuV/m) | Margin (dB) | Remark |
|-----|-----------------|----------------|----------------|-----------------|----------------|-------------|--------|
| 1 | 3975.000 | 47.76 | -2.98 | 44.78 | 74.00 | -29.22 | peak |
| 2 | 7965.000 | 44.40 | 8.26 | 52.66 | 74.00 | -21.34 | peak |
| 3 | 12960.000 | 38.34 | 14.71 | 53.05 | 74.00 | -20.95 | peak |
| 4 | 14445.000 | 34.75 | 16.37 | 51.12 | 74.00 | -22.88 | peak |
| 5 | 17310.000 | 30.84 | 21.86 | 52.70 | 74.00 | -21.30 | peak |
| 6 | 17940.000 | 29.76 | 23.21 | 52.97 | 74.00 | -21.03 | peak |

- Note: 1. Measurement = Reading Level + Correct Factor.
 2. If Peak Result complies with AV limit, AV Result is deemed to comply with AV limit.
 3. Peak: Peak detector.
 4. The High Pass filter loss factor already add into the correct factor.
 5. Proper operation of the transmitter prior to adding the filter to the measurement chain.



HARMONICS AND SPURIOUS EMISSIONS (CHANNEL26, HORIZONTAL)

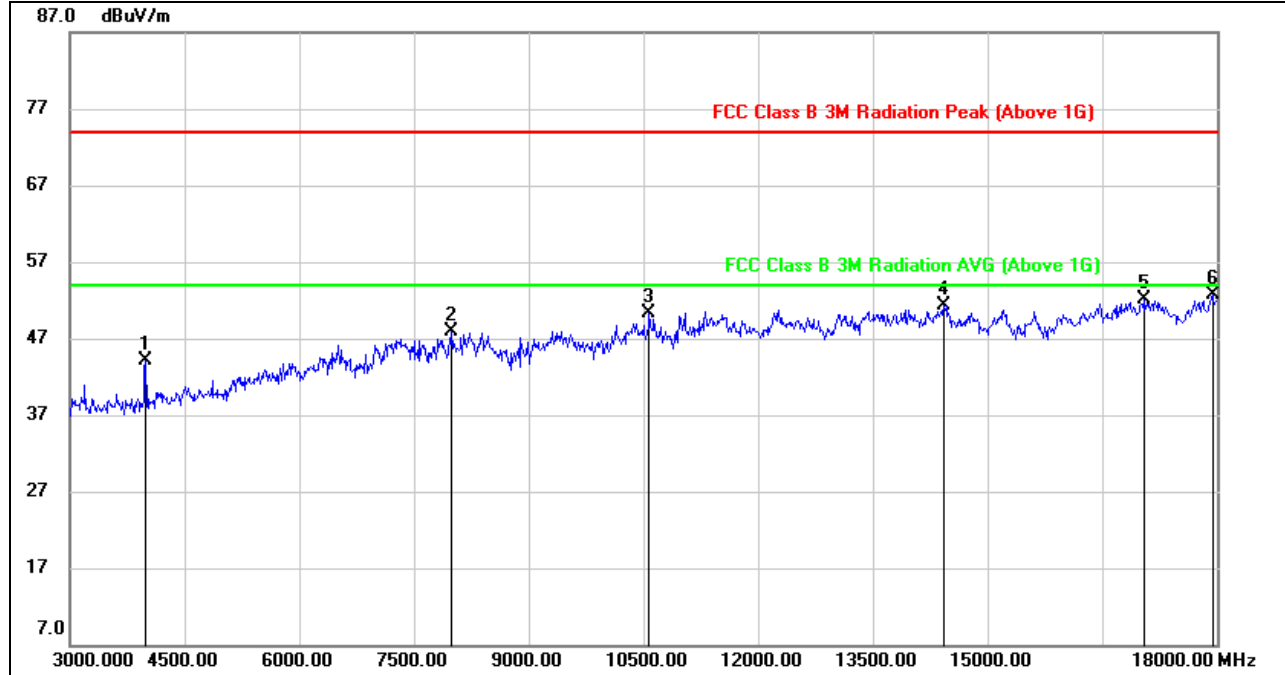

| No. | Frequency (MHz) | Reading (dBuV) | Correct (dB/m) | Result (dBuV/m) | Limit (dBuV/m) | Margin (dB) | Remark |
|-----|-----------------|----------------|----------------|-----------------|----------------|-------------|--------|
| 1 | 3990.000 | 46.97 | -2.95 | 44.02 | 74.00 | -29.98 | peak |
| 2 | 7995.000 | 39.70 | 8.16 | 47.86 | 74.00 | -26.14 | peak |
| 3 | 10575.000 | 37.83 | 12.52 | 50.35 | 74.00 | -23.65 | peak |
| 4 | 14430.000 | 34.95 | 16.39 | 51.34 | 74.00 | -22.66 | peak |
| 5 | 17055.000 | 31.62 | 20.57 | 52.19 | 74.00 | -21.81 | peak |
| 6 | 17940.000 | 29.55 | 23.21 | 52.76 | 74.00 | -21.24 | peak |

- Note: 1. Measurement = Reading Level + Correct Factor.
 2. If Peak Result complies with AV limit, AV Result is deemed to comply with AV limit.
 3. Peak: Peak detector.
 4. The High Pass filter loss factor already add into the correct factor.
 5. Proper operation of the transmitter prior to adding the filter to the measurement chain.



HARMONICS AND SPURIOUS EMISSIONS (CHANNEL26, VERTICAL)

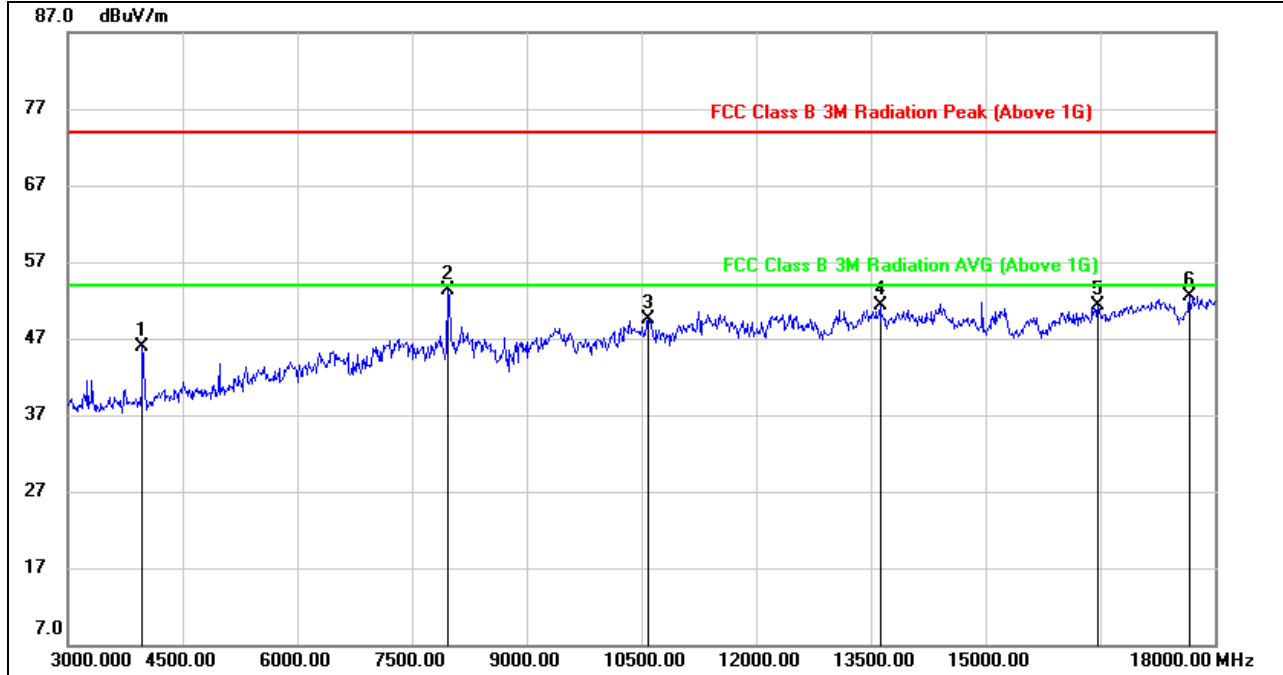

| No. | Frequency (MHz) | Reading (dBuV) | Correct (dB/m) | Result (dBuV/m) | Limit (dBuV/m) | Margin (dB) | Remark |
|-----|-----------------|----------------|----------------|-----------------|----------------|-------------|--------|
| 1 | 3975.000 | 48.83 | -2.98 | 45.85 | 74.00 | -28.15 | peak |
| 2 | 7965.000 | 44.96 | 8.26 | 53.22 | 74.00 | -20.78 | peak |
| 3 | 10590.000 | 36.89 | 12.68 | 49.57 | 74.00 | -24.43 | peak |
| 4 | 13620.000 | 35.23 | 16.04 | 51.27 | 74.00 | -22.73 | peak |
| 5 | 16470.000 | 32.49 | 18.80 | 51.29 | 74.00 | -22.71 | peak |
| 6 | 17670.000 | 30.51 | 21.98 | 52.49 | 74.00 | -21.51 | peak |

- Note: 1. Measurement = Reading Level + Correct Factor.
 2. If Peak Result complies with AV limit, AV Result is deemed to comply with AV limit.
 3. Peak: Peak detector.
 4. The High Pass filter loss factor already add into the correct factor.
 5. Proper operation of the transmitter prior to adding the filter to the measurement chain.



8.4. SPURIOUS EMISSIONS 18G ~ 26GHz

SPURIOUS EMISSIONS (MID CHANNEL, WORST-CASE CONFIGURATION, HORIZONTAL)

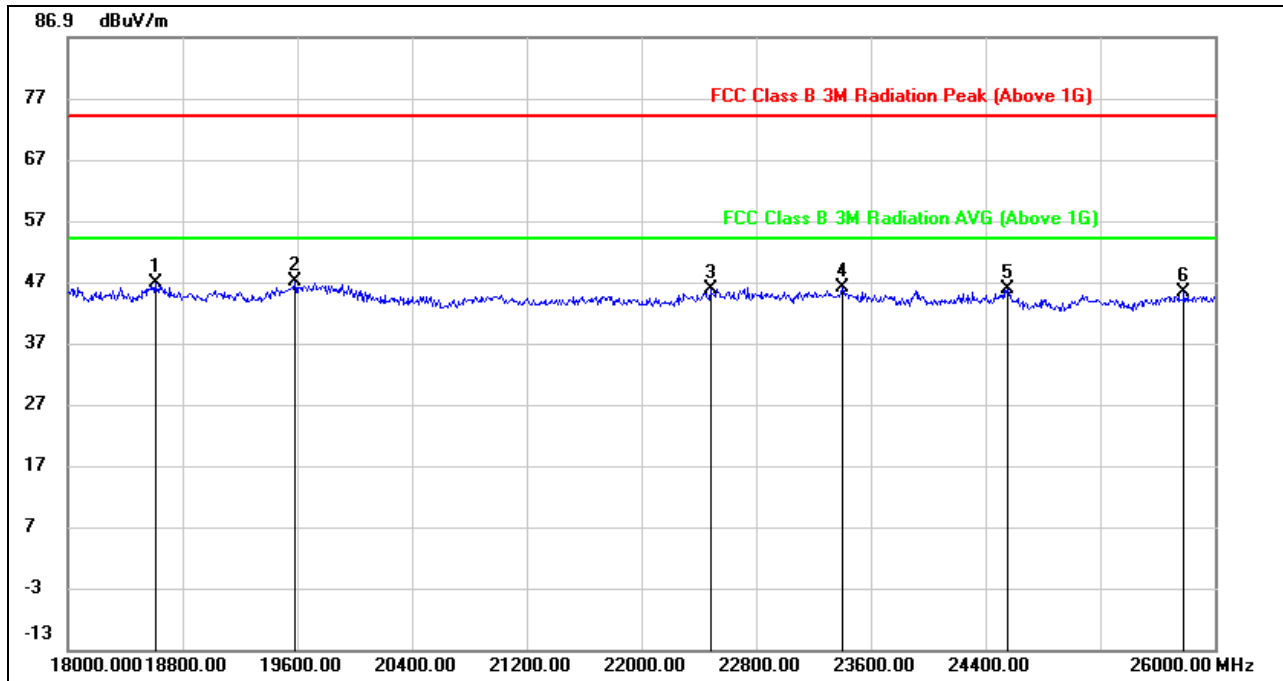

| No. | Frequency (MHz) | Reading (dBuV) | Correct (dB/m) | Result (dBuV/m) | Limit (dBuV/m) | Margin (dB) | Remark |
|-----|-----------------|----------------|----------------|-----------------|----------------|-------------|--------|
| 1 | 18608.000 | 51.36 | -4.58 | 46.78 | 74.00 | -27.22 | peak |
| 2 | 19584.000 | 51.67 | -4.64 | 47.03 | 74.00 | -26.97 | peak |
| 3 | 22480.000 | 51.48 | -5.82 | 45.66 | 74.00 | -28.34 | peak |
| 4 | 23400.000 | 50.92 | -4.96 | 45.96 | 74.00 | -28.04 | peak |
| 5 | 24552.000 | 48.14 | -2.46 | 45.68 | 74.00 | -28.32 | peak |
| 6 | 25784.000 | 46.73 | -1.49 | 45.24 | 74.00 | -28.76 | peak |

- Note: 1. Measurement = Reading Level + Correct Factor.
 2. If Peak Result complies with AV limit, AV Result is deemed to comply with AV limit.
 3. Peak: Peak detector.
 4. Proper operation of the transmitter prior to adding the filter to the measurement chain.



SPURIOUS EMISSIONS (MID CHANNEL, WORST-CASE CONFIGURATION, VERTICAL)

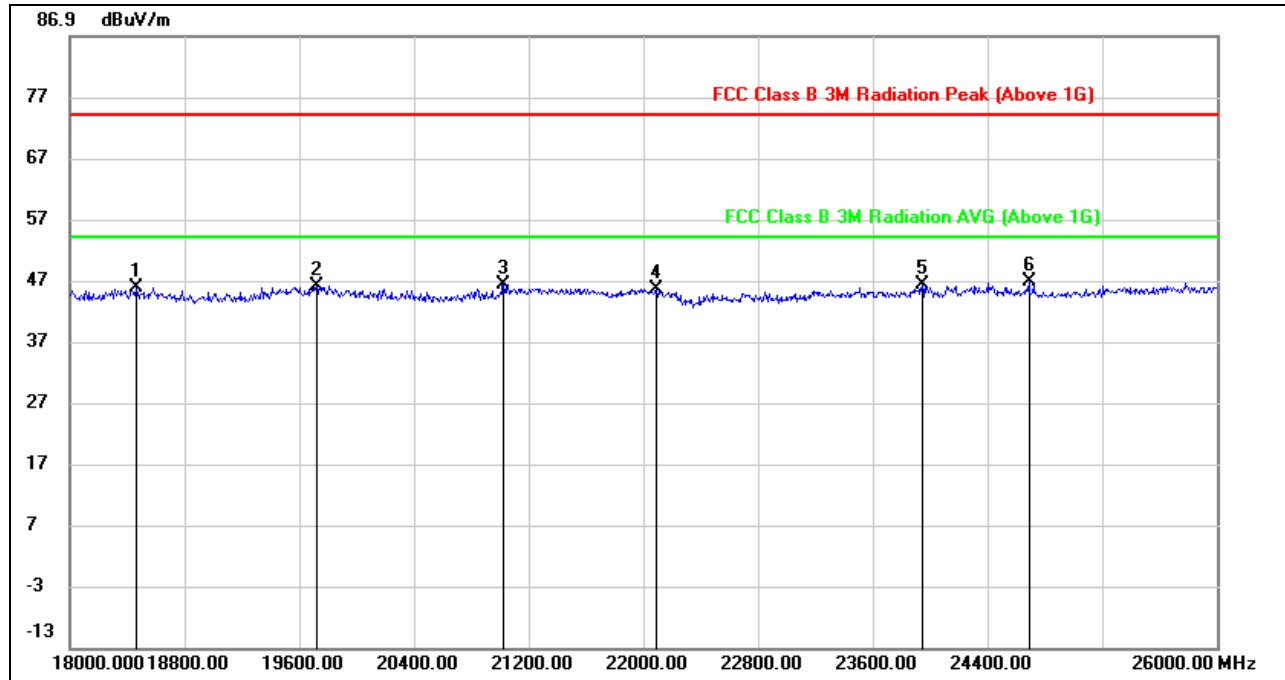

| No. | Frequency (MHz) | Reading (dBuV) | Correct (dB/m) | Result (dBuV/m) | Limit (dBuV/m) | Margin (dB) | Remark |
|-----|-----------------|----------------|----------------|-----------------|----------------|-------------|--------|
| 1 | 18464.000 | 50.20 | -4.39 | 45.81 | 74.00 | -28.19 | peak |
| 2 | 19720.000 | 50.50 | -4.39 | 46.11 | 74.00 | -27.89 | peak |
| 3 | 21024.000 | 51.64 | -5.30 | 46.34 | 74.00 | -27.66 | peak |
| 4 | 22088.000 | 51.81 | -6.18 | 45.63 | 74.00 | -28.37 | peak |
| 5 | 23944.000 | 50.45 | -4.14 | 46.31 | 74.00 | -27.69 | peak |
| 6 | 24688.000 | 48.89 | -2.11 | 46.78 | 74.00 | -27.22 | peak |

- Note: 1. Measurement = Reading Level + Correct Factor.
 2. If Peak Result complies with AV limit, AV Result is deemed to comply with AV limit.
 3. Peak: Peak detector.
 4. Proper operation of the transmitter prior to adding the filter to the measurement chain.

Note: All the modes had been tested, but only the worst data were recorded in the report.



8.5. SPURIOUS EMISSIONS 30M ~ 1 GHz

SPURIOUS EMISSIONS (MID CHANNEL, WORST-CASE CONFIGURATION, HORIZONTAL)

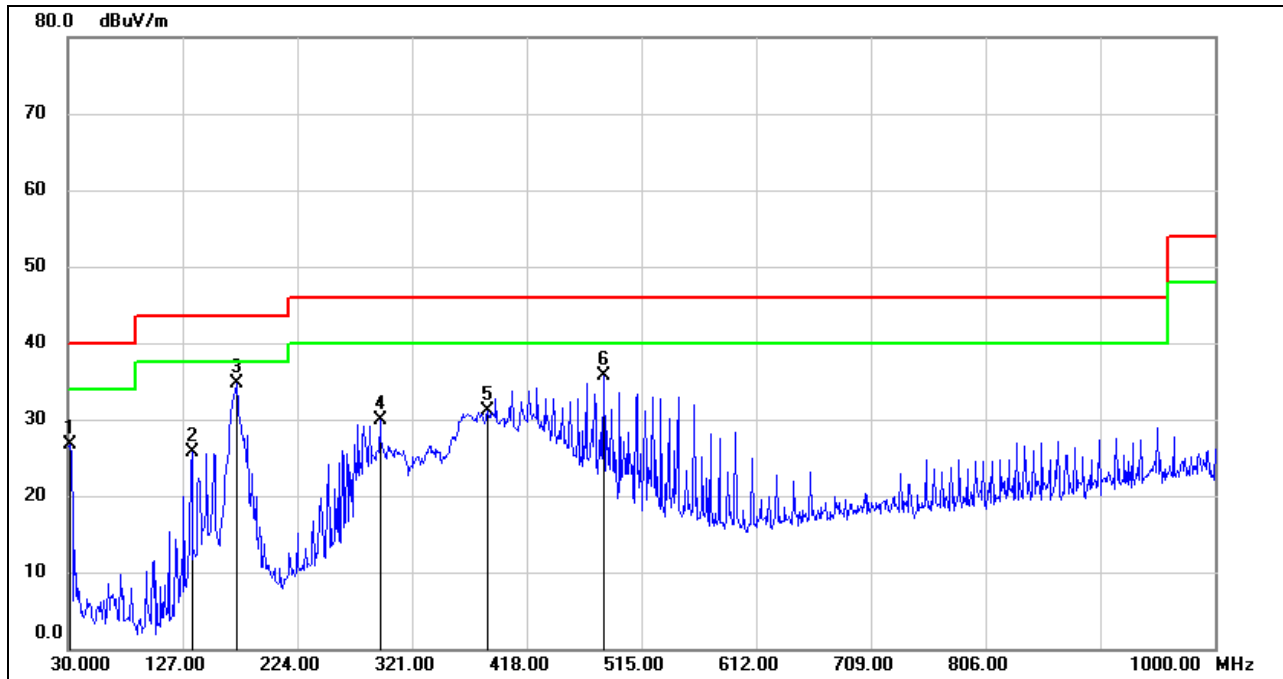

| No. | Frequency (MHz) | Reading (dBuV) | Correct (dB/m) | Result (dBuV/m) | Limit (dBuV/m) | Margin (dB) | Remark |
|-----|-----------------|----------------|----------------|-----------------|----------------|-------------|--------|
| 1 | 31.9400 | 43.78 | -17.09 | 26.69 | 40.00 | -13.31 | QP |
| 2 | 134.7600 | 44.85 | -19.24 | 25.61 | 43.50 | -17.89 | QP |
| 3 | 172.5900 | 51.47 | -16.82 | 34.65 | 43.50 | -8.85 | QP |
| 4 | 293.8400 | 43.73 | -13.86 | 29.87 | 46.00 | -16.13 | QP |
| 5 | 385.0200 | 43.38 | -12.22 | 31.16 | 46.00 | -14.84 | QP |
| 6 | 482.9900 | 46.10 | -10.42 | 35.68 | 46.00 | -10.32 | QP |

- Note: 1. Result Level = Read Level + Correct Factor.
 2. If Peak Result complies with QP limit, QP Result is deemed to comply with QP limit.
 3. Test setup: RBW: 120 kHz, VBW: 300 kHz, Sweep time: auto.



SPURIOUS EMISSIONS (MID CHANNEL, WORST-CASE CONFIGURATION, VERTICAL)

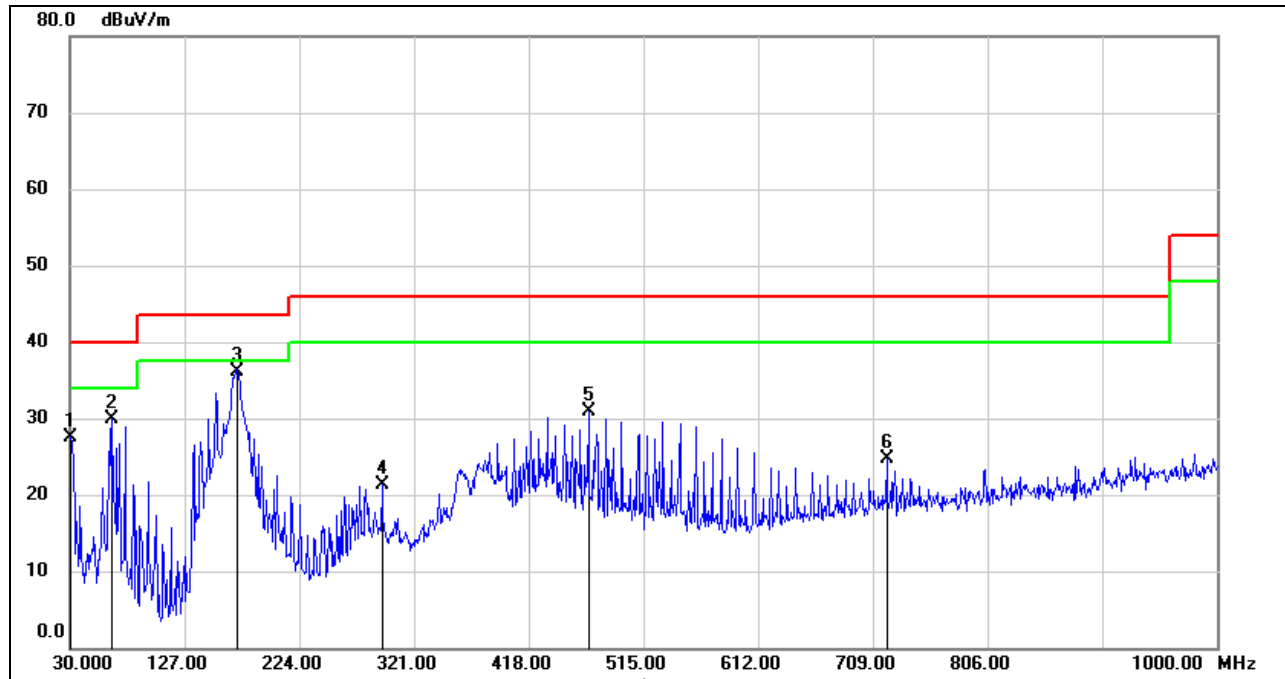

| No. | Frequency (MHz) | Reading (dBuV) | Correct (dB/m) | Result (dBuV/m) | Limit (dBuV/m) | Margin (dB) | Remark |
|-----|-----------------|----------------|----------------|-----------------|----------------|-------------|--------|
| 1 | 30.9700 | 44.38 | -16.94 | 27.44 | 40.00 | -12.56 | QP |
| 2 | 65.8900 | 49.51 | -19.60 | 29.91 | 40.00 | -10.09 | QP |
| 3 | 171.6200 | 53.02 | -16.82 | 36.20 | 43.50 | -7.30 | QP |
| 4 | 293.8400 | 35.18 | -13.86 | 21.32 | 46.00 | -24.68 | QP |
| 5 | 468.4400 | 41.61 | -10.70 | 30.91 | 46.00 | -15.09 | QP |
| 6 | 720.6400 | 30.50 | -5.74 | 24.76 | 46.00 | -21.24 | QP |

- Note: 1. Result Level = Read Level + Correct Factor.
 2. If Peak Result complies with QP limit, QP Result is deemed to comply with QP limit.
 3. Test setup: RBW: 120 kHz, VBW: 300 kHz, Sweep time: auto

Note: All the modes had been tested, but only the worst data were recorded in the report.



8.6. SPURIOUS EMISSIONS BELOW 30M

SPURIOUS EMISSIONS (MID CHANNEL, WORST-CASE CONFIGURATION, VERTICAL)

9kHz~ 150kHz

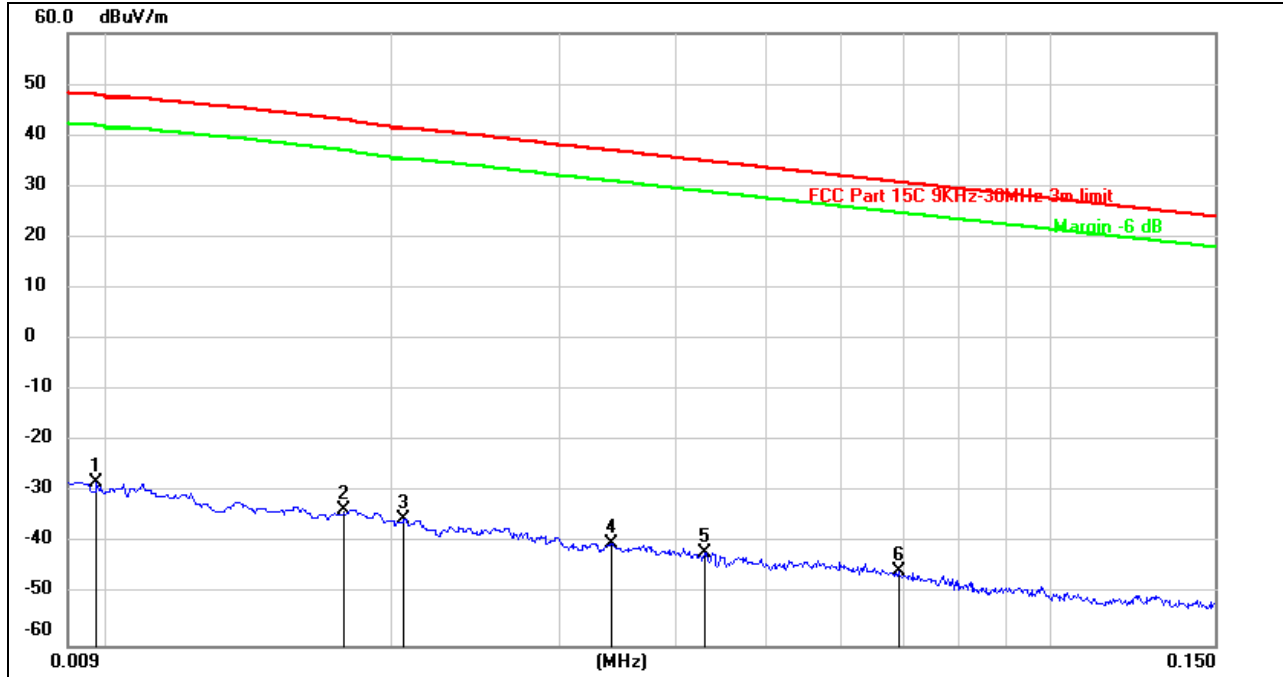

| No. | Frequency (MHz) | Reading (dBuV) | Correct (dB/m) | Result (dBuV/m) | Limit (dBuV/m) | Margin (dB) | Remark |
|-----|-----------------|----------------|----------------|-----------------|----------------|-------------|--------|
| 1 | 0.0097 | 73.29 | -101.38 | -28.09 | 47.83 | -75.92 | peak |
| 2 | 0.0177 | 67.85 | -101.35 | -33.50 | 42.96 | -76.46 | peak |
| 3 | 0.0205 | 65.97 | -101.35 | -35.38 | 41.40 | -76.78 | peak |
| 4 | 0.0342 | 61.43 | -101.41 | -39.98 | 37.01 | -76.99 | peak |
| 5 | 0.0429 | 59.75 | -101.45 | -41.70 | 35.00 | -76.70 | peak |
| 6 | 0.0690 | 56.04 | -101.56 | -45.52 | 30.83 | -76.35 | peak |

Note: 1. Measurement = Reading Level + Correct Factor.

2. If Peak Result complies with AV and QP limit, AV and QP Result are deemed to comply with AV limit.



150kHz ~ 490kHz

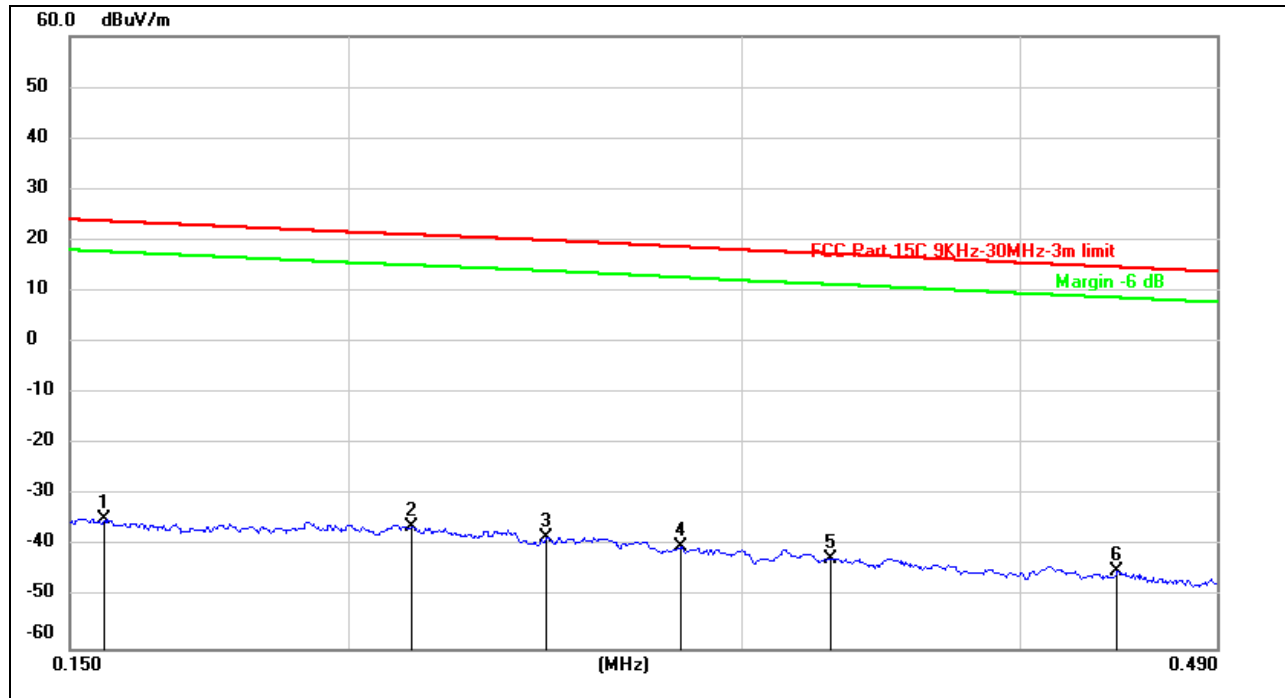

| No. | Frequency (MHz) | Reading (dBuV) | Correct (dB/m) | Result (dBuV/m) | Limit (dBuV/m) | Margin (dB) | Remark |
|-----|-----------------|----------------|----------------|-----------------|----------------|-------------|--------|
| 1 | 0.1556 | 67.02 | -101.65 | -34.63 | 23.77 | -58.40 | peak |
| 2 | 0.2136 | 65.69 | -101.74 | -36.05 | 21.10 | -57.15 | peak |
| 3 | 0.2452 | 63.59 | -101.80 | -38.21 | 19.99 | -58.20 | peak |
| 4 | 0.2816 | 61.67 | -101.83 | -40.16 | 18.71 | -58.87 | peak |
| 5 | 0.3291 | 59.52 | -101.88 | -42.36 | 17.33 | -59.69 | peak |
| 6 | 0.4424 | 57.04 | -102.01 | -44.97 | 14.73 | -59.70 | peak |

Note: 1. Measurement = Reading Level + Correct Factor.
2. If Peak Result complies with AV and QP limit, AV and QP Result are deemed to comply with AV limit.



490kHz ~ 30MHz

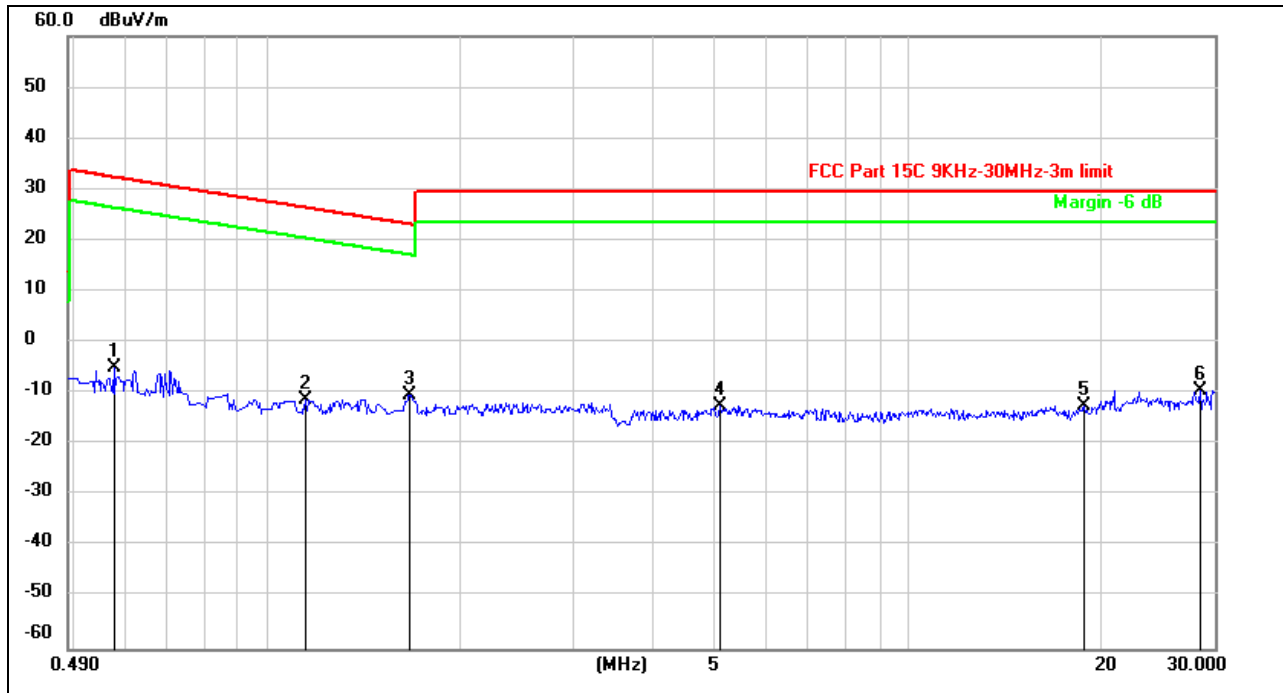

| No. | Frequency (MHz) | Reading (dBuV) | Correct (dB/m) | Result (dBuV/m) | Limit (dBuV/m) | Margin (dB) | Remark |
|-----|-----------------|----------------|----------------|-----------------|----------------|-------------|--------|
| 1 | 0.5785 | 57.05 | -62.08 | -5.03 | 32.38 | -37.41 | peak |
| 2 | 1.1484 | 51.11 | -62.21 | -11.10 | 26.41 | -37.51 | peak |
| 3 | 1.6704 | 51.72 | -61.97 | -10.25 | 23.15 | -33.40 | peak |
| 4 | 5.0936 | 48.98 | -61.48 | -12.50 | 29.54 | -42.04 | peak |
| 5 | 18.7862 | 48.47 | -60.88 | -12.41 | 29.54 | -41.95 | peak |
| 6 | 28.4650 | 50.69 | -60.11 | -9.42 | 29.54 | -38.96 | peak |

Note: 1. Measurement = Reading Level + Correct Factor.

2. If Peak Result complies with AV and QP limit, AV and QP Result are deemed to comply with AV limit.



SPURIOUS EMISSIONS (MID CHANNEL, WORST-CASE CONFIGURATION, HORIZONTAL)

9kHz~ 150kHz

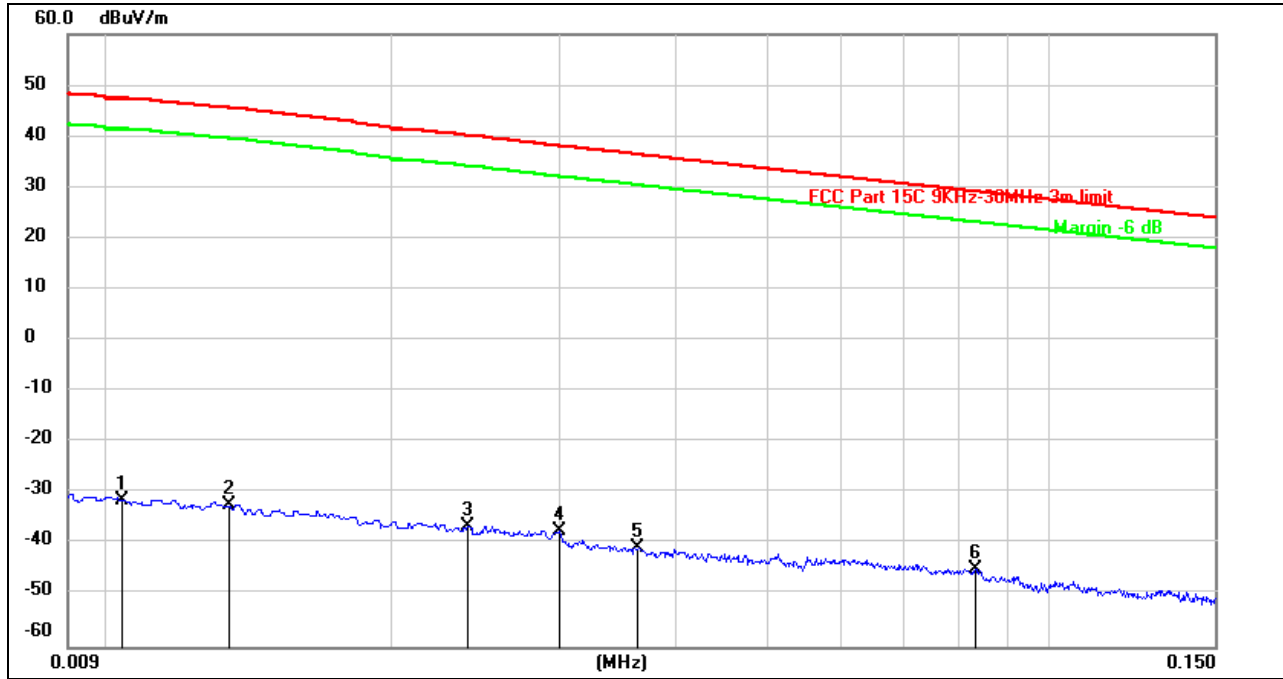

| No. | Frequency (MHz) | Reading (dBuV) | Correct (dB/m) | Result (dBuV/m) | Limit (dBuV/m) | Margin (dB) | Remark |
|-----|-----------------|----------------|----------------|-----------------|----------------|-------------|--------|
| 1 | 0.0103 | 70.14 | -101.40 | -31.26 | 47.42 | -78.68 | peak |
| 2 | 0.0134 | 69.23 | -101.39 | -32.16 | 45.55 | -77.71 | peak |
| 3 | 0.0240 | 64.82 | -101.36 | -36.54 | 40.17 | -76.71 | peak |
| 4 | 0.0300 | 64.18 | -101.39 | -37.21 | 38.06 | -75.27 | peak |
| 5 | 0.0364 | 60.69 | -101.42 | -40.73 | 36.46 | -77.19 | peak |
| 6 | 0.0834 | 56.78 | -101.66 | -44.88 | 29.19 | -74.07 | peak |

Note: 1. Measurement = Reading Level + Correct Factor.

2. If Peak Result complies with AV and QP limit, AV and QP Result are deemed to comply with AV limit.



150kHz ~ 490kHz

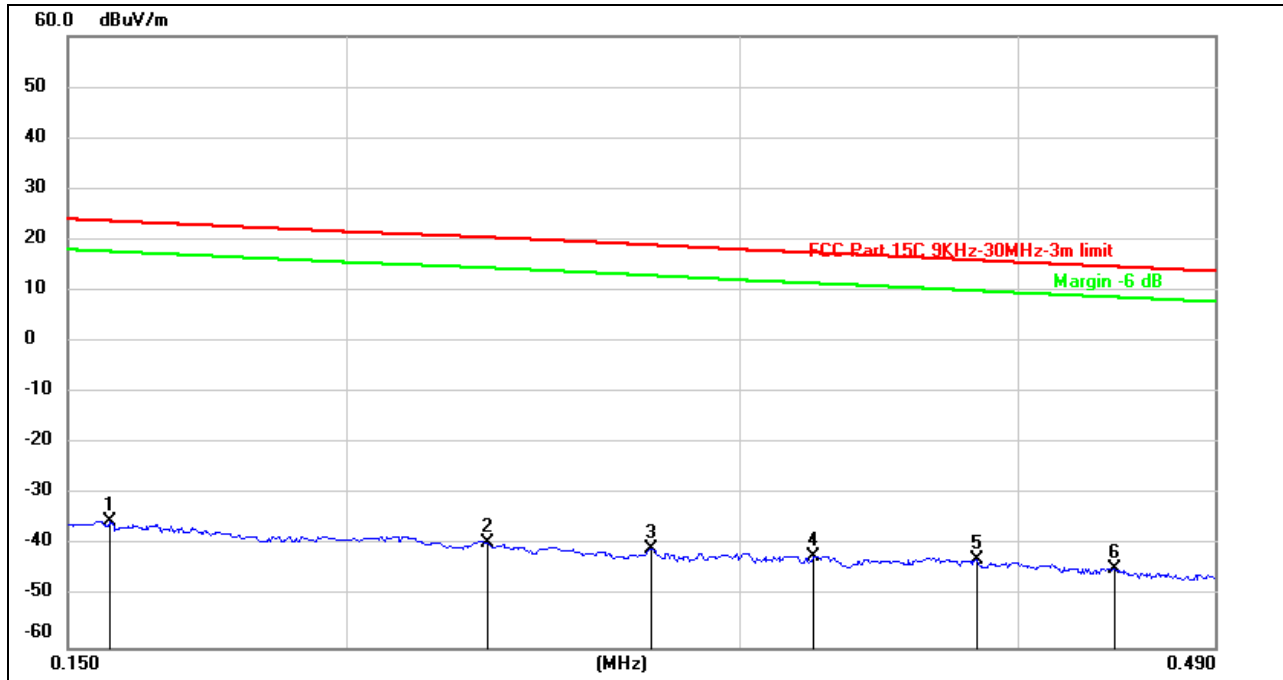

| No. | Frequency (MHz) | Reading (dBuV) | Correct (dB/m) | Result (dBuV/m) | Limit (dBuV/m) | Margin (dB) | Remark |
|-----|-----------------|----------------|----------------|-----------------|----------------|-------------|--------|
| 1 | 0.1565 | 66.53 | -101.65 | -35.12 | 23.72 | -58.84 | peak |
| 2 | 0.2313 | 62.19 | -101.77 | -39.58 | 20.48 | -60.06 | peak |
| 3 | 0.2736 | 61.08 | -101.83 | -40.75 | 18.99 | -59.74 | peak |
| 4 | 0.3240 | 59.87 | -101.88 | -42.01 | 17.46 | -59.47 | peak |
| 5 | 0.3830 | 59.20 | -101.94 | -42.74 | 15.98 | -58.72 | peak |
| 6 | 0.4420 | 57.33 | -102.01 | -44.68 | 14.74 | -59.42 | peak |

Note: 1. Measurement = Reading Level + Correct Factor.
2. If Peak Result complies with AV and QP limit, AV and QP Result are deemed to comply with AV limit.



490kHz ~ 30MHz

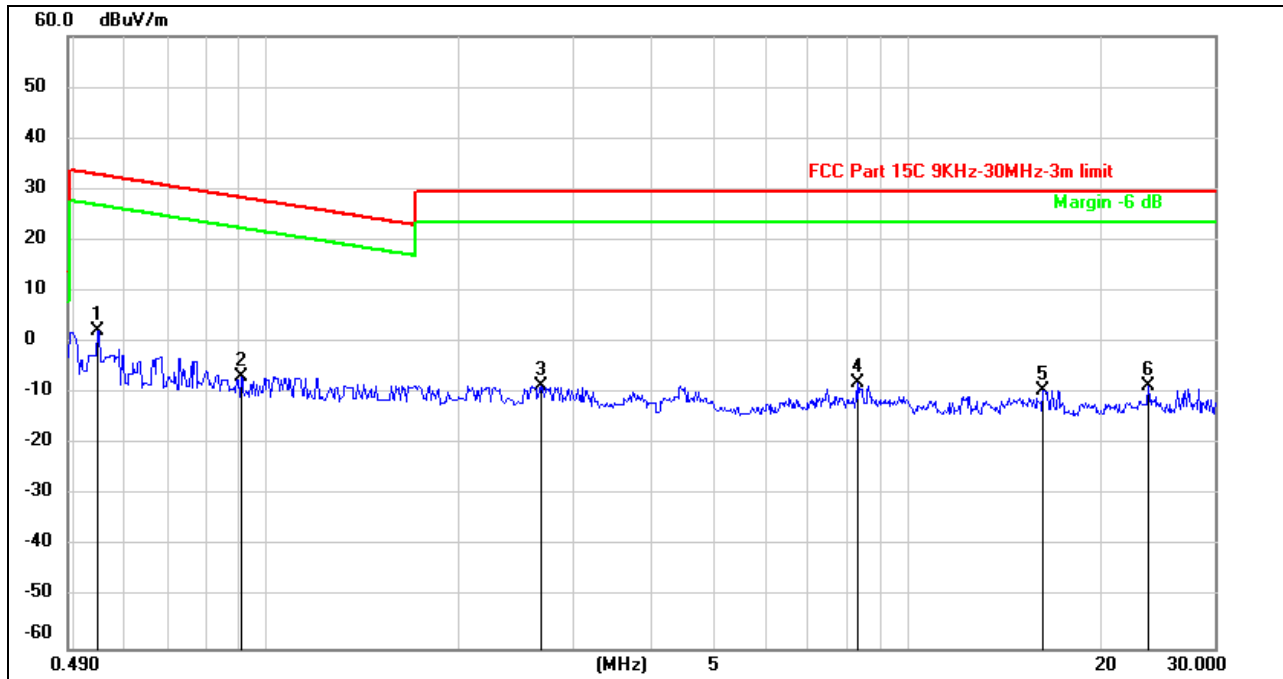

| No. | Frequency (MHz) | Reading (dBuV) | Correct (dB/m) | Result (dBuV/m) | Limit (dBuV/m) | Margin (dB) | Remark |
|-----|-----------------|----------------|----------------|-----------------|----------------|-------------|--------|
| 1 | 0.5453 | 64.37 | -62.08 | 2.29 | 32.92 | -30.63 | peak |
| 2 | 0.9121 | 55.44 | -62.21 | -6.77 | 28.41 | -35.18 | peak |
| 3 | 2.6737 | 53.14 | -61.65 | -8.51 | 29.54 | -38.05 | peak |
| 4 | 8.3397 | 53.19 | -61.03 | -7.84 | 29.54 | -37.38 | peak |
| 5 | 16.1890 | 51.45 | -60.97 | -9.52 | 29.54 | -39.06 | peak |
| 6 | 23.6554 | 52.02 | -60.56 | -8.54 | 29.54 | -38.08 | peak |

Note: 1. Measurement = Reading Level + Correct Factor.
2. If Peak Result complies with AV and QP limit, AV and QP Result are deemed to comply with AV limit.

Note: All the modes had been tested, but only the worst data were recorded in the report.

9. AC POWER LINE CONDUCTED EMISSIONS

LIMITS

Please refer to CFR 47 FCC §15.207 (a) and ISED RSS-Gen Clause 8.8

| FREQUENCY (MHz) | Quasi-peak | Average |
|-----------------|------------|-----------|
| 0.15 -0.5 | 66 - 56 * | 56 - 46 * |
| 0.50 -5.0 | 56.00 | 46.00 |
| 5.0 -30.0 | 60.00 | 50.00 |

TEST SETUP AND PROCEDURE

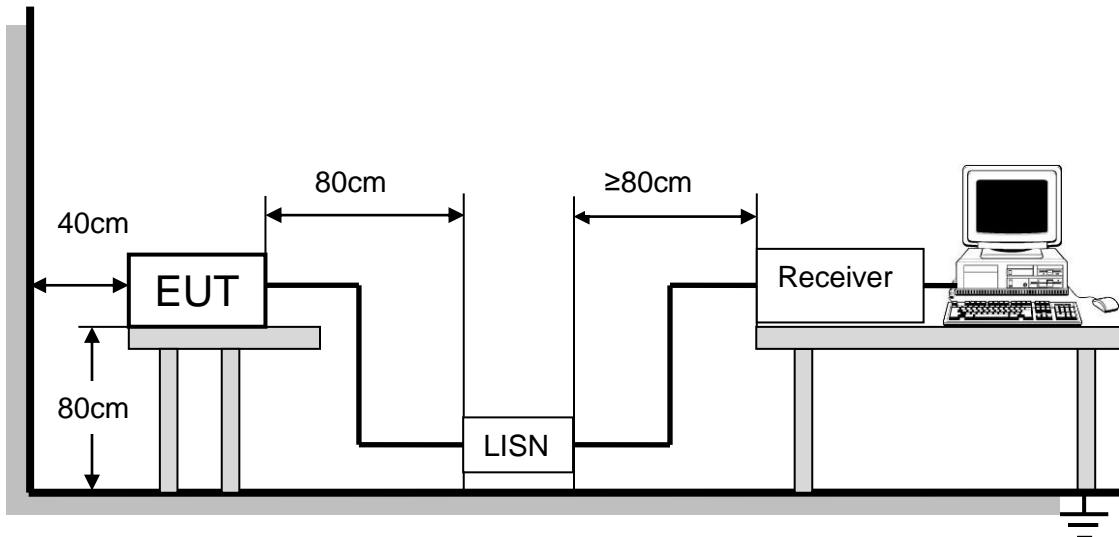

The EUT is put on a table of non-conducting material that is 80cm high. The vertical conducting wall of shielding is located 40cm to the rear of the EUT. The power line of the EUT is connected to the AC mains through a Artificial Mains Network (A.M.N.). A EMI Measurement Receiver (R&S Test Receiver ESR3) is used to test the emissions from both sides of AC line. According to the requirements in Section 6.2 of ANSI C63.10 -2013. Conducted emissions from the EUT measured in the frequency range between 0.15 MHz and 30MHz using CISPR Quasi-Peak and average detector mode. The bandwidth of EMI test receiver is set at 9kHz.

The arrangement of the equipment is installed to meet the standards and operating in a manner, which tends to maximize its emission characteristics in a normal application.



TEST RESULTS

LINE N RESULTS (LOW CHANNEL, WORST-CASE CONFIGURATION)

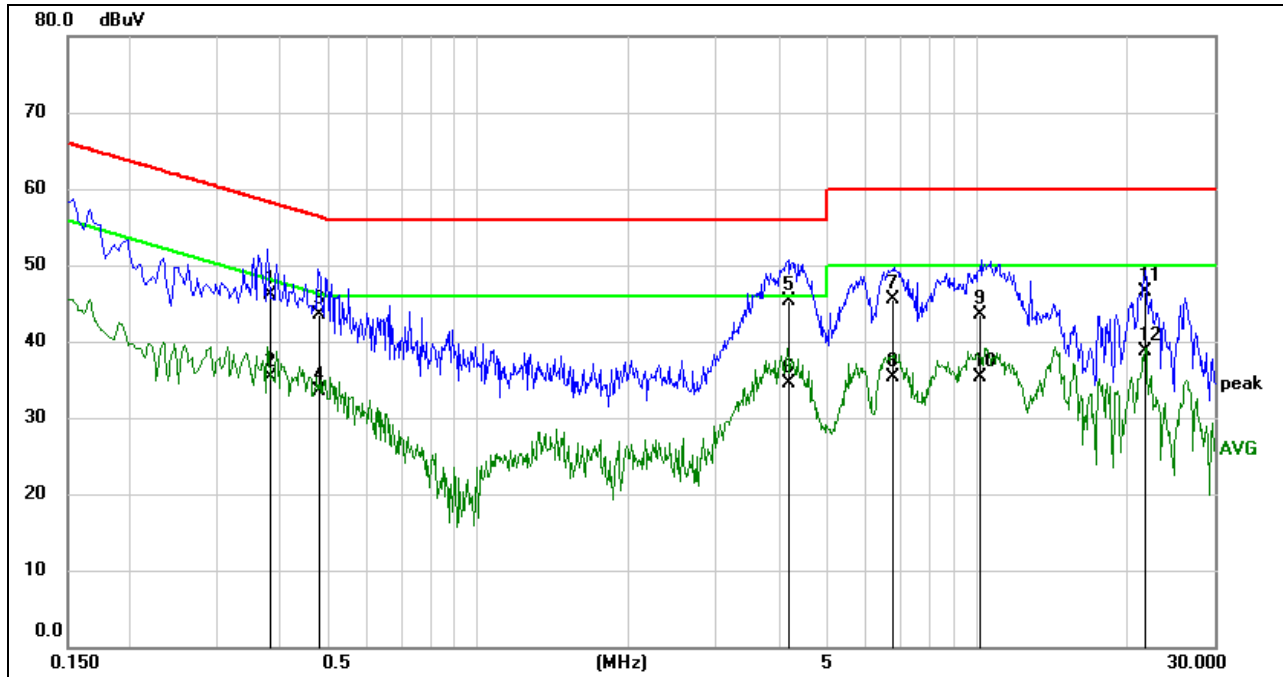

| No. | Frequency (MHz) | Reading (dBuV) | Correct (dB) | Result (dBuV) | Limit (dBuV) | Margin (dB) | Remark |
|-----|-----------------|----------------|--------------|---------------|--------------|-------------|--------|
| 1 | 0.3826 | 36.43 | 9.60 | 46.03 | 58.22 | -12.19 | QP |
| 2 | 0.3826 | 25.72 | 9.60 | 35.32 | 48.22 | -12.90 | AVG |
| 3 | 0.4809 | 33.95 | 9.60 | 43.55 | 56.32 | -12.77 | QP |
| 4 | 0.4809 | 23.88 | 9.60 | 33.48 | 46.32 | -12.84 | AVG |
| 5 | 4.1627 | 35.67 | 9.66 | 45.33 | 56.00 | -10.67 | QP |
| 6 | 4.1627 | 24.83 | 9.66 | 34.49 | 46.00 | -11.51 | AVG |
| 7 | 6.7727 | 35.73 | 9.71 | 45.44 | 60.00 | -14.56 | QP |
| 8 | 6.7727 | 25.63 | 9.71 | 35.34 | 50.00 | -14.66 | AVG |
| 9 | 10.1206 | 33.66 | 9.76 | 43.42 | 60.00 | -16.58 | QP |
| 10 | 10.1206 | 25.57 | 9.76 | 35.33 | 50.00 | -14.67 | AVG |
| 11 | 21.7599 | 36.27 | 10.18 | 46.45 | 60.00 | -13.55 | QP |
| 12 | 21.7599 | 28.62 | 10.18 | 38.80 | 50.00 | -11.20 | AVG |

- Note: 1. Result = Reading +Correct Factor.
 2. If QP Result complies with AV limit, AV Result is deemed to comply with AV limit.
 3. Test setup: RBW: 200 Hz (9 kHz—150 kHz), 9 kHz (150 kHz—30 MHz).
 4. Step size: 80Hz (0.009MHz-0.15MHz), 4 kHz (0.15MHz-30MHz), Scan time: auto.



LINE L RESULTS (LOW CHANNEL, WORST-CASE CONFIGURATION)

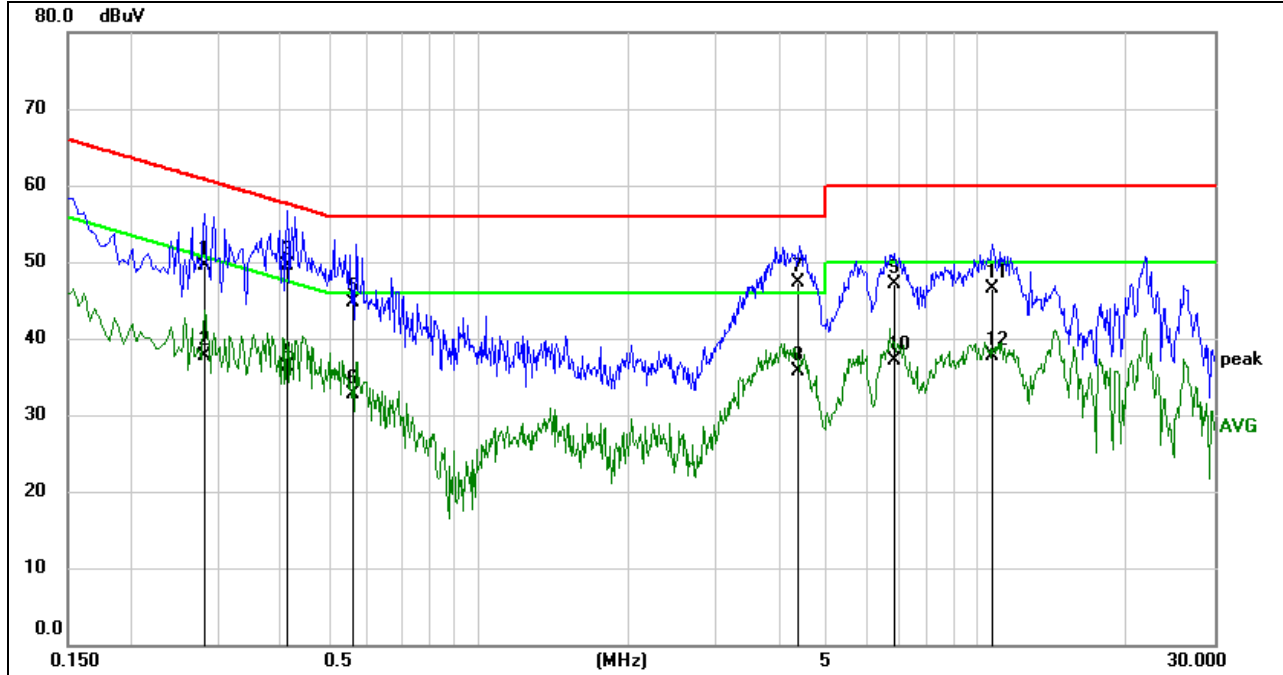

| No. | Frequency (MHz) | Reading (dBuV) | Correct (dB) | Result (dBuV) | Limit (dBuV) | Margin (dB) | Remark |
|-----|-----------------|----------------|--------------|---------------|--------------|-------------|--------|
| 1 | 0.2813 | 39.93 | 9.60 | 49.53 | 60.78 | -11.25 | QP |
| 2 | 0.2813 | 28.16 | 9.60 | 37.76 | 50.78 | -13.02 | AVG |
| 3 | 0.4120 | 39.89 | 9.60 | 49.49 | 57.61 | -8.12 | QP |
| 4 | 0.4120 | 26.72 | 9.60 | 36.32 | 47.61 | -11.29 | AVG |
| 5 | 0.5635 | 35.04 | 9.60 | 44.64 | 56.00 | -11.36 | QP |
| 6 | 0.5635 | 23.17 | 9.60 | 32.77 | 46.00 | -13.23 | AVG |
| 7 | 4.3610 | 37.71 | 9.66 | 47.37 | 56.00 | -8.63 | QP |
| 8 | 4.3610 | 26.07 | 9.66 | 35.73 | 46.00 | -10.27 | AVG |
| 9 | 6.8283 | 37.47 | 9.71 | 47.18 | 60.00 | -12.82 | QP |
| 10 | 6.8283 | 27.44 | 9.71 | 37.15 | 50.00 | -12.85 | AVG |
| 11 | 10.7596 | 36.70 | 9.76 | 46.46 | 60.00 | -13.54 | QP |
| 12 | 10.7596 | 27.98 | 9.76 | 37.74 | 50.00 | -12.26 | AVG |

- Note: 1. Result = Reading +Correct Factor.
 2. If QP Result complies with AV limit, AV Result is deemed to comply with AV limit.
 3. Test setup: RBW: 200 Hz (9 kHz—150 kHz), 9 kHz (150 kHz—30 MHz).
 4. Step size: 80Hz (0.009MHz-0.15MHz), 4 kHz (0.15MHz-30MHz), Scan time: auto.

Note: All test mode has been tested, only the worst data record in the report.



10. ANTENNA REQUIREMENTS

Applicable requirements

Please refer to FCC §15.203

An intentional radiator shall be designed to ensure that no antenna other than that furnished by the responsible party shall be used with the device. The use of a permanently attached antenna or of an antenna that uses a unique coupling to the intentional radiator shall be considered sufficient to comply with the provisions of this section. The manufacturer may design the unit so that a broken antenna can be replaced by the user, but the use of a standard antenna jack or electrical connector is prohibited.

Please refer to FCC §15.247(b)(4)

The conducted output power limit specified in paragraph (b) of this section is based on the use of antennas with directional gains that do not exceed 6 dBi. Except as shown in paragraph (c) of this section, if transmitting antennas of directional gain greater than 6 dBi are used, the conducted output power from the intentional radiator shall be reduced below the stated values in paragraphs (b)(1), (b)(2), and (b)(3) of this section, as appropriate, by the amount in dB that the directional gain of the antenna exceeds 6 dBi.

RESULTS

Complies

END OF REPORT