



FCC - TEST REPORT

Report Number : **68.912.19.0003.01** Date of Issue: April 17, 2019

Model : **8B-SS-ZF-H0**

Product Type : Water leak sensor

Applicant : LEEDARSON LIGHTING CO., LTD

Address : Xingda Road, Xingtai Industrial Zone, Changtai County, Zhangzhou,
Fujian, China

Production Facility : LEEDARSON LIGHTING CO., LTD

Address : Xingda Road, Xingtai Industrial Zone, Changtai County, Zhangzhou,
Fujian, China

Test Result : Positive Negative

Total pages including Appendices : 27

TÜV SÜD Certification and Testing (China) Co., Ltd. Shenzhen Branch is a subcontractor to TÜV SÜD Product Service GmbH according to the principles outlined in ISO 17025.

TÜV SÜD Certification and Testing (China) Co., Ltd. Shenzhen Branch reports apply only to the specific samples tested under stated test conditions. Construction of the actual test samples has been documented. It is the manufacturer's responsibility to assure that additional production units of this model are manufactured with identical electrical and mechanical components. The manufacturer/importer is responsible to the Competent Authorities in Europe for any modifications made to the production units which result in non-compliance to the relevant regulations. TÜV SÜD Certification and Testing (China) Co., Ltd. Shenzhen Branch shall have no liability for any deductions, inferences or generalizations drawn by the client or others from TÜV SÜD Certification and Testing (China) Co., Ltd. Shenzhen Branch issued reports.

This report is the confidential property of the client. As a mutual protection to our clients, the public and ourselves, extracts from the test report shall not be reproduced except in full without our written approval.



1 Table of Contents

1	Table of Contents	2
2	Details about the Test Laboratory.....	3
3	Description of the Equipment under Test	4
4	Summary of Test Standards.....	5
5	Summary of Test Results.....	6
6	General Remarks	7
7	Test Setups	8
8	Systems test configuration.....	9
9	Technical Requirement	10
9.1	Conducted peak output power.....	10
9.2	6dB bandwidth	13
9.3	Power spectral density.....	15
9.4	Spurious RF conducted emissions	17
9.5	Band edge	21
9.6	Spurious radiated emissions for transmitter	23
10	Test Equipment List.....	27
11	System Measurement Uncertainty	28

2 Details about the Test Laboratory

Details about the Test Laboratory

Test Site 1

Company name: TÜV SÜD Certification and Testing (China) Co., Ltd. Shenzhen Branch
Building 12&13, Zhiheng Wisdomland Business Park,
Nantou Checkpoint Road 2, Nanshan District,
Shenzhen City, 518052,
P. R. China

FCC Registration Number: 514049

Telephone: 86 755 8828 6998
Fax: 86 755 8828 5299

3 Description of the Equipment under Test

Product:	Water leak sensor
Model no.:	8B-SS-ZF-H0
FCC ID:	2AB2Q8BSSZFH0
Rated Input:	3V DC (Battery AAA X 2)
RF Transmission Frequency:	2405MHz-2480MHz
No. of Operated Channel:	16
Modulation:	OQPSK
Antenna Type:	Integrated Antenna
Antenna Gain:	2.25dBi
Description of the EUT:	The Equipment Under Test (EUT) is a Water leak sensor supports 2.4GHz Zigbee function.

4 Summary of Test Standards

Test Standards	
FCC Part 15 Subpart C 10-1-2017 Edition	PART 15 - RADIO FREQUENCY DEVICES Subpart C - Intentional Radiators

All the test methods were according to KDB558074 D01 DTS Meas Guidance v05r02 and ANSI C63.10 (2013).

5 Summary of Test Results

Technical Requirements				
FCC Part 15 Subpart C				
Test Condition		Pages	Test Result	Test Site
§15.207	Conducted emission AC power port	See note 1	N/A	--
§15.247(b)(1)	Conducted peak output power for FHSS	--	N/A	--
§15.247(b)(3)	Conducted peak output power for DTS	13	Pass	Site 1
§15.247(e)	Power spectral density	17	Pass	Site 1
§15.247(a)(2)	6dB bandwidth	15	Pass	Site 1
§15.247(a)(1)	20dB Occupied bandwidth	--	N/A	--
§15.247(a)(1)	Carrier frequency separation	--	N/A	--
§15.247(a)(1)(iii)	Number of hopping frequencies	--	N/A	--
§15.247(a)(1)(iii)	Dwell Time	--	N/A	--
§15.247(d)	Spurious RF conducted emissions	19	Pass	Site 1
§15.247(d)	Band edge	23	Pass	Site 1
§15.247(d) & §15.209 & §15.205	Spurious radiated emissions for transmitter	25	Pass	Site 1
§15.203	Antenna requirement	See note 2	Pass	--

Remark: N/A – Not Applicable.

Note 1: Not apply for battery operated device;

Note 2: The EUT uses an Integrated Antenna 2.25dBi max. According to §15.203, it is considered sufficiently to comply with the provisions of this section;



6 General Remarks

Remarks

This submittal(s) (test report) is intended for FCC ID:2AB2Q8BSSZFH0 complies with Section 15.205, 15.209, 15.247 of the FCC Part 15, Subpart C Rules;

SUMMARY:

All tests according to the regulations cited on page 5 were

- Performed

- **Not** Performed

The Equipment under Test

- **Fulfills** the general approval requirements.

- **Does not** fulfill the general approval requirements.

Sample Received Date: January 30, 2019

Testing Start Date: January 30, 2019

Testing End Date: February 01, 2019

- TÜV SÜD Certification and Testing (China) Co., Ltd. Shenzhen Branch -

Reviewed by:

Prepared by:

Tested by:

Laurent Yuan
EMC Project Manager



Henry Chen
EMC Project Engineer

Louise Liu
EMC Test Engineer

7 Test Setups

7.1 Radiated test setups

Below 1GHz

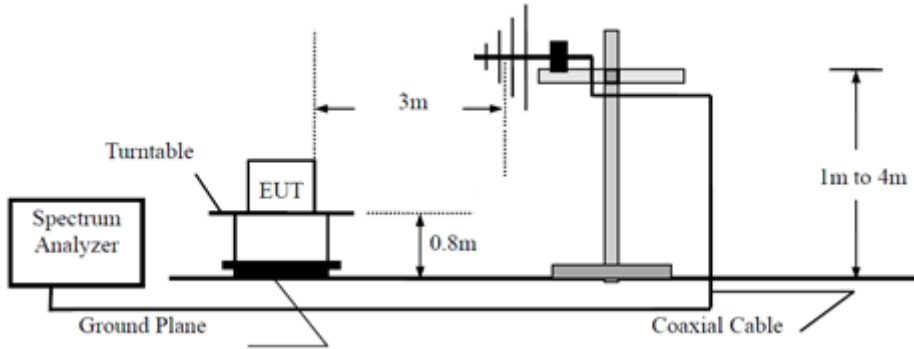

Above 1GHz

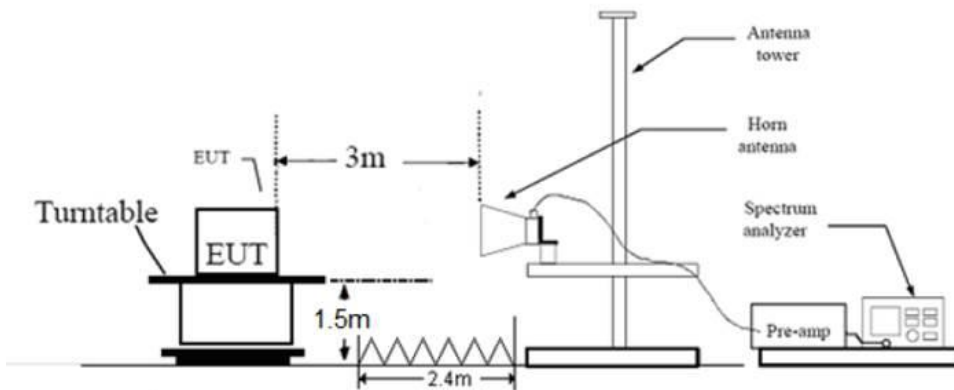

7.2 Conducted RF test setups

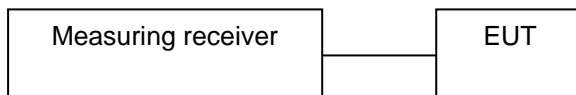

8 Systems test configuration

Auxiliary Equipment Used during Test:

DESCRIPTION	MANUFACTURER	MODEL NO.	S/N
Laptop	DELL	Latitude 7480	---

Test software information:

Test Software Version	UartAssis V3.8.3		
Modulation	Setting TX Power	Packet Type	
OQPSK	5dBm	---	

The system was configured to channel 11, 19, and 26 for the test.

9 Technical Requirement

9.1 Conducted peak output power

Test Method

1. The EUT was placed on 0.8m height table, the RF output of EUT was connected to the test receiver by RF cable. The path loss was compensated to the results for each measurement.
2. Use the following spectrum analyzer settings:
 RBW \geq DTS bandwidth, VBW \geq 3RBW, Sweep = auto, allow trace to fully stabilize.
 Detector function = peak, Trace = max hold
3. Repeat above procedure until other frequencies measured were completed.

Test Setup

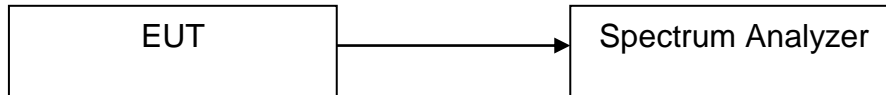

Limits

According to §15.247 (b) (3), conducted output power limit as below:

Frequency Range MHz	Limit W	Limit dBm
2400-2483.5	≤ 1	≤ 30

Test result as below table

Frequency MHz	Conducted peak Output Power dBm	Result
Top channel 2405MHz	4.56	Pass
Middle channel 2445MHz	4.70	Pass
Bottom channel 2480MHz	4.81	Pass

Test Graphs

Zigbee_Ant1_2405

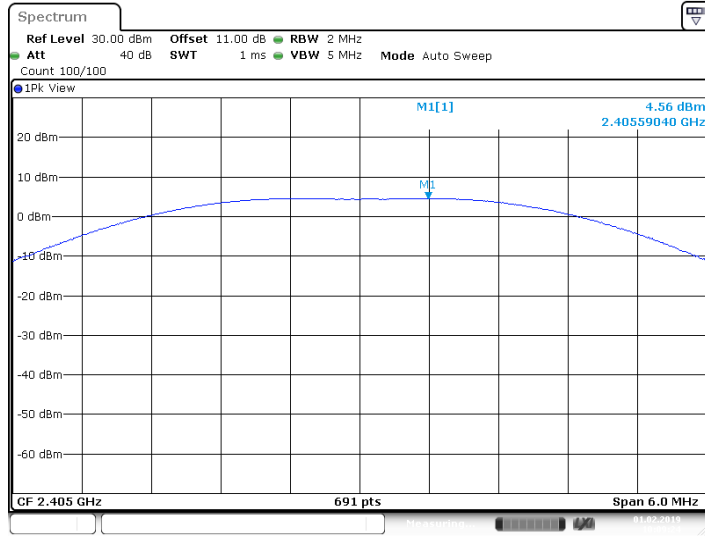

Date: 1.FEB.2019 10:09:25

Zigbee_Ant1_2445

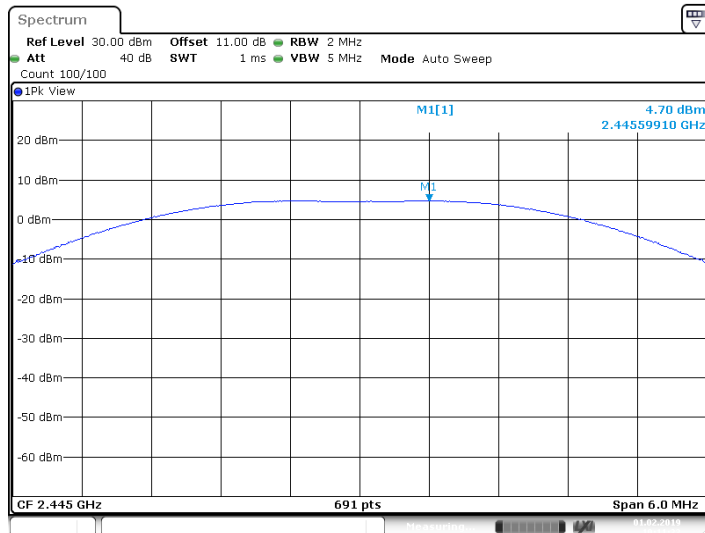

Date: 1.FEB.2019 10:11:33

Zigbee_Ant1_2480

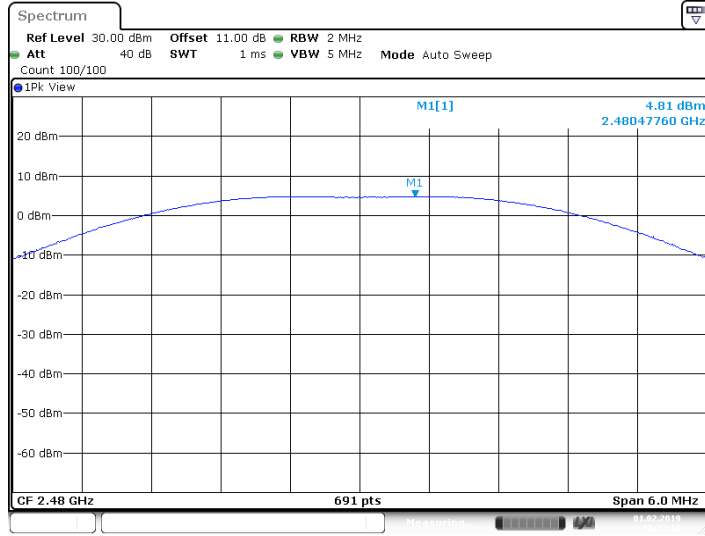

9.2 6dB bandwidth

Test Method

1. The EUT was placed on 0.8m height table, the RF output of EUT was connected to the test receiver by RF cable. The path loss was compensated to the results for each measurement.
1. Use the following spectrum analyzer settings:
RBW=100K, VBW≥3RBW, Sweep = auto, Detector function = peak, Trace = max hold
2. Use the automatic bandwidth measurement capability of an instrument, may be employed using the X dB bandwidth mode with X set to 6 dB, care shall be taken so that the bandwidth measurement is not influenced by any intermediate power nulls in the fundamental emission that might be ≥ 6 dB.
3. Allow the trace to stabilize, record the X dB Bandwidth value.
4. [Repeat above procedures until other frequencies measured were completed.](#)

Limit

Limit [kHz]

≥500

Test result

Test Mode	Channel (MHz)	Result (MHz)	Limit (KHz)	Verdict
Zigbee	2405	1.464	≥500	PASS
Zigbee	2445	1.468	≥500	PASS
Zigbee	2480	1.464	≥500	PASS

Test Graphs

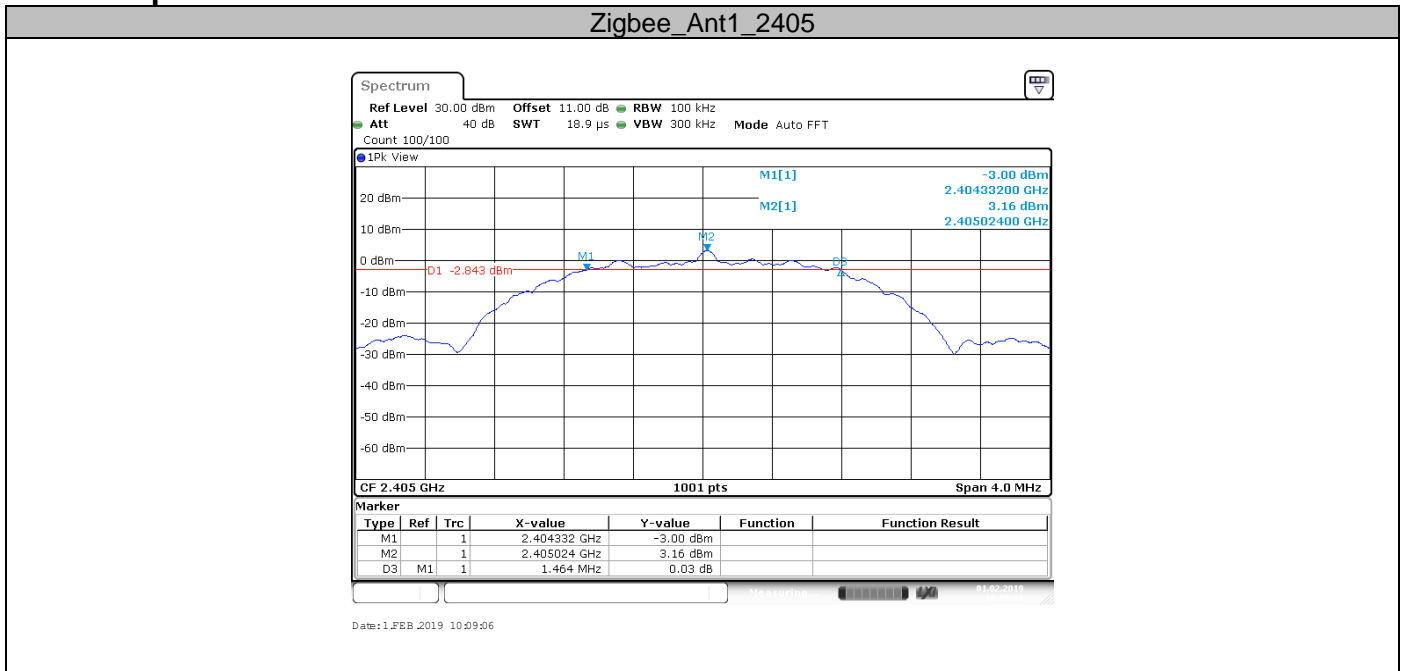

Zigbee_Ant1_2445

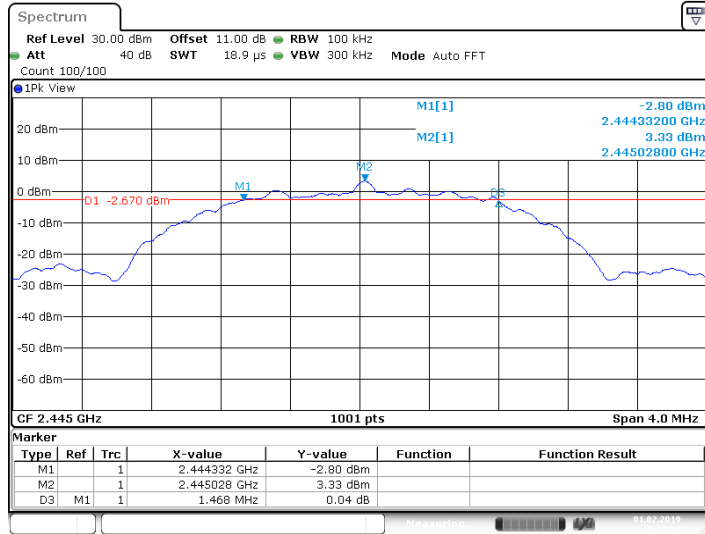

Date: 1.FEB.2019 10:11:15

Zigbee_Ant1_2480

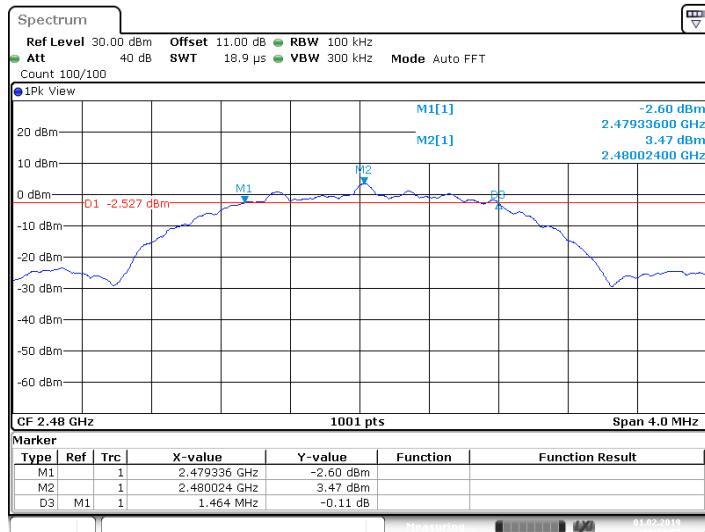

Date: 1.FEB.2019 10:12:58

9.3 Power spectral density

Test Method

This procedure shall be used if maximum peak conducted output power was used to demonstrate compliance:

1. The EUT was placed on 0.8m height table, the RF output of EUT was connected to the test receiver by RF cable. The path loss was compensated to the results for each measurement.
2. Set analyzer center frequency to DTS channel center frequency. Set the RBW to 3 kHz $\leq RBW \leq 100$ kHz., $VBW \geq 3RBW$, Span=1.5 times DTS bandwidth, Detector=Peak, Sweep=auto, Trace= max hold.
3. Allow trace to fully stabilize, use the peak marker function to determine the maximum amplitude level within the RBW.
4. Repeat above procedures until other frequencies measured were completed.

Limit

Limit [dBm]

≤ 8

Test result

Test Mode	Channel (MHz)	Result (dBm)	Limit	Verdict
Zigbee	2405	-5.99	8	PASS
Zigbee	2445	-5.53	8	PASS
Zigbee	2480	-5.62	8	PASS

Test Graphs

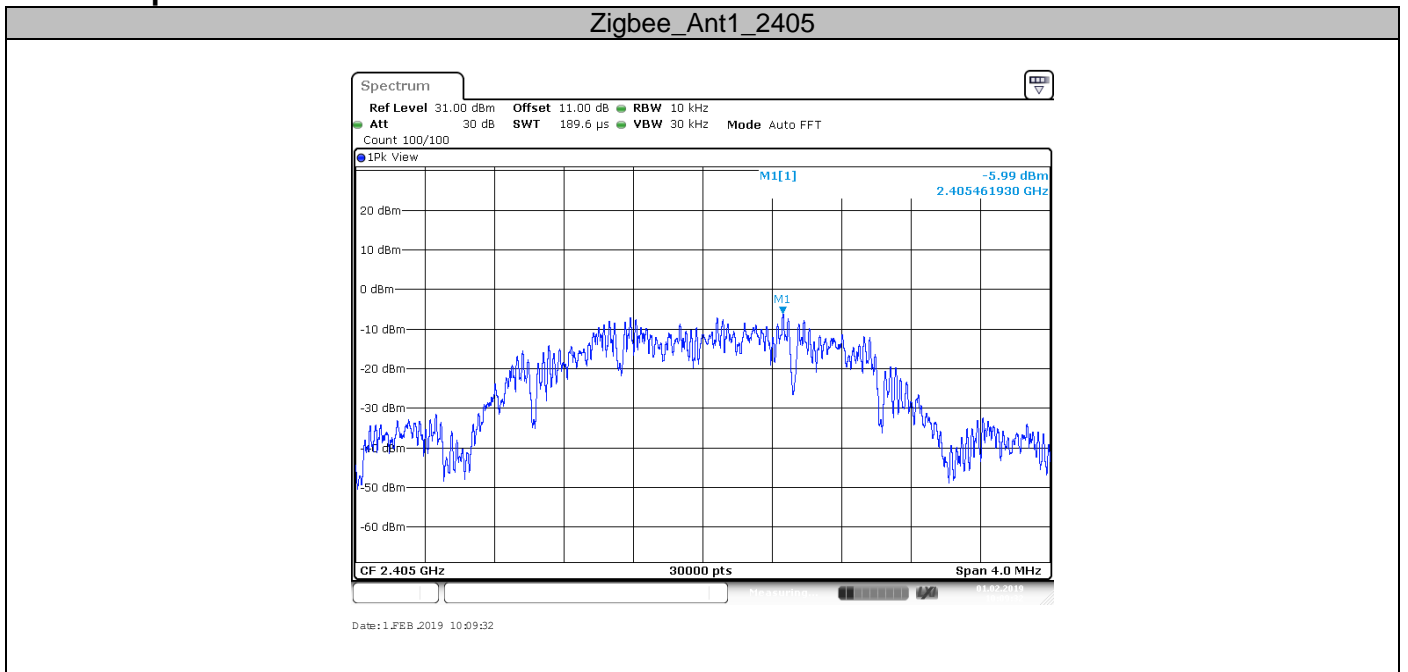

Zigbee_Ant1_2445

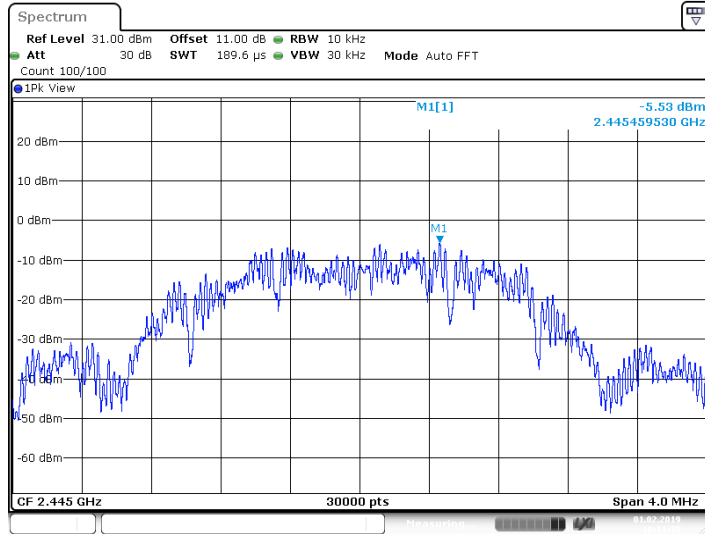

Zigbee_Ant1_2480

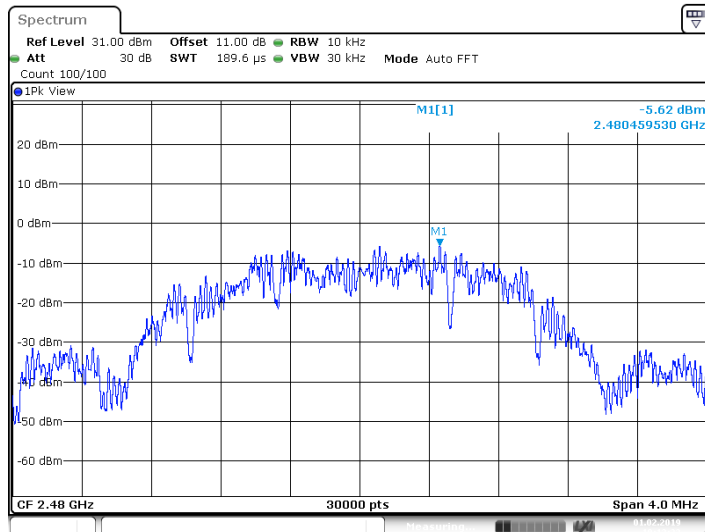

9.4 Spurious RF conducted emissions

Test Method

1. The EUT was placed on 0.8m height table, the RF output of EUT was connected to the test receiver by RF cable. The path loss was compensated to the results for each measurement.
2. Establish a reference level by using the following procedure:
 - a. Set RBW=100 kHz. VBW \geq 3RBW. Detector =peak, Sweep time = auto couple, Trace mode = max hold.
 - b. Allow trace to fully stabilize, use the peak marker function to determine the maximum PSD level.
3. Use the maximum PSD level to establish the reference level.
 - a. Set the center frequency and span to encompass frequency range to be measured.
 - b. Use the peak marker function to determine the maximum amplitude level. Ensure that the amplitude of all unwanted emissions outside of the authorized frequency band (excluding restricted frequency bands) are attenuated by at least the minimum requirements, report the three highest emissions relative to the limit.
4. Repeat above procedures until other frequencies measured were completed.

Limit

Frequency Range MHz	Limit (dBc)
30-25000	-20

Test Result

Test Mode	Channel (MHz)	Freq Range (MHz)	Result (dBm)	Limit (dBm)	Verdict
Zigbee	2405	30~1000	-58.69	-17.18	PASS
Zigbee	2405	1000~26500	-43.09	-17.18	PASS
Zigbee	2445	30~1000	-58.41	-18.6	PASS
Zigbee	2445	1000~26500	-43.59	-18.6	PASS
Zigbee	2480	30~1000	-58.79	-17.07	PASS
Zigbee	2480	1000~26500	-42.55	-17.07	PASS

Test Graphs

Zigbee_Ant1_2405_0~Reference

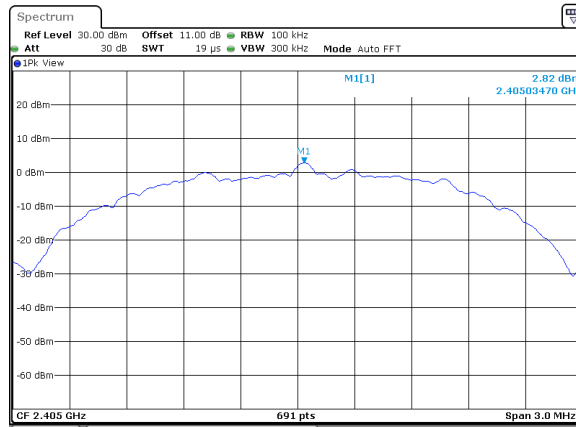

Date: 1.FEB.2019 10:29:48

Zigbee_Ant1_2405_30~1000

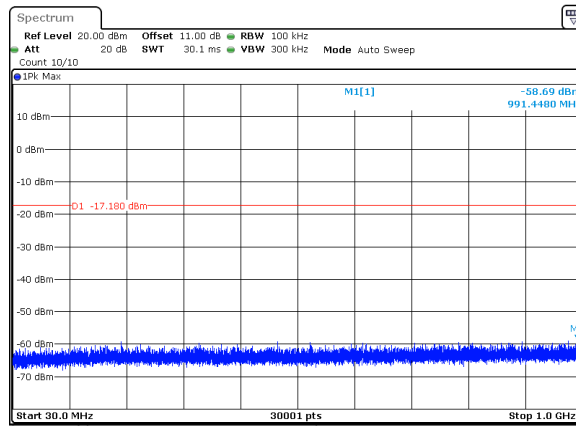

Date: 1.FEB.2019 10:29:57

Zigbee_Ant1_2405_1000~26500

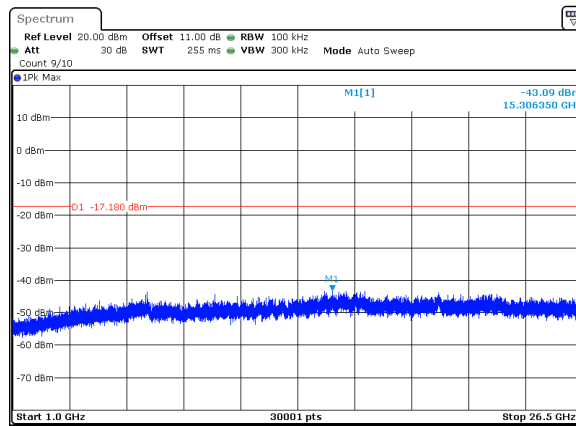

Date: 1.FEB.2019 10:30:09

Zigbee_Ant1_2445_0~Reference

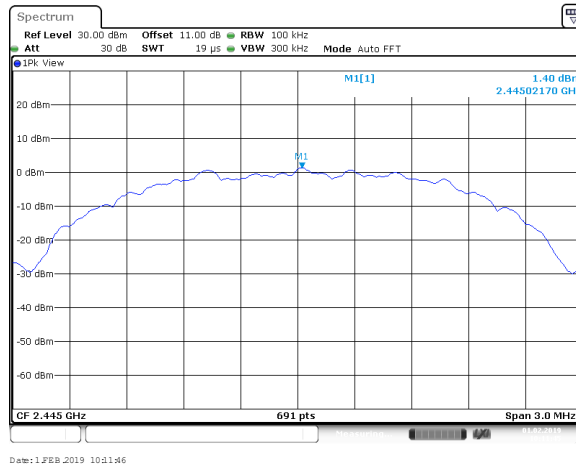

Zigbee_Ant1_2445_30~1000

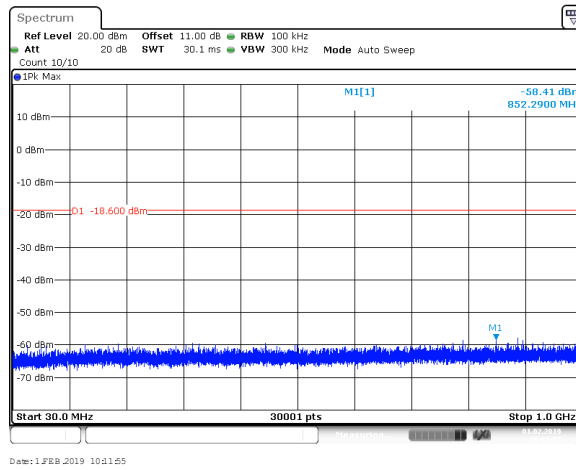

Zigbee_Ant1_2445_1000~26500

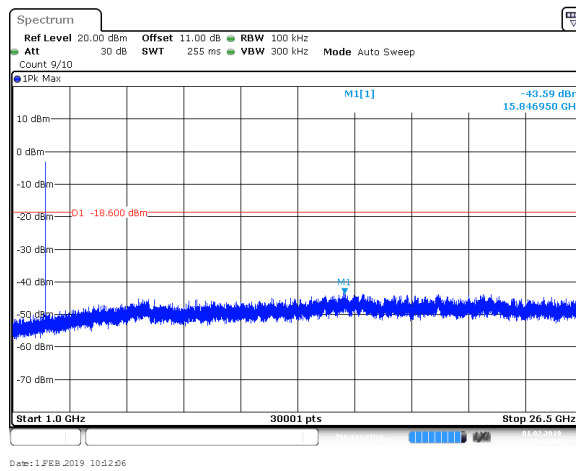

Zigbee_Ant1_2480_0~Reference

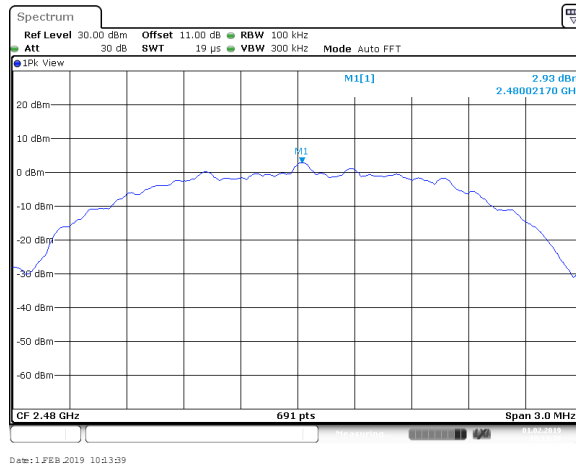

Zigbee_Ant1_2480_30~1000

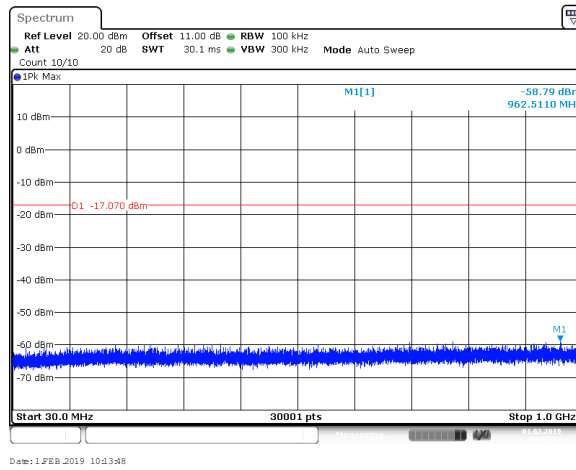

Zigbee_Ant1_2480_1000~26500

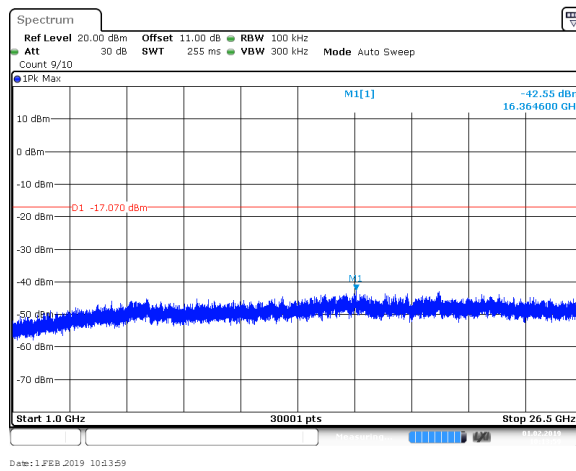

9.5 Band edge

Test Method

1. The EUT was placed on 0.8m height table, the RF output of EUT was connected to the test receiver by RF cable. The path loss was compensated to the results for each measurement.
2. Use the following spectrum analyzer settings:
Span = wide enough to capture the peak level of the in-band emission and all spurious
RBW = 100 kHz, VBW ≥ RBW, Sweep = auto, Detector function = peak, Trace = max hold.
- 3 Allow the trace to stabilize, use the peak and delta measurement to record the result.
- 4 The level displayed must comply with the limit specified in this Section.

Limit

Frequency Range MHz	Limit (dBc)
30-25000	-20

Test result

Test Mode	Ch Name	Channel (MHz)	Result (dBm)	Limit	Verdict
Zigbee	Low	2405	-49.89	-17.7	PASS
Zigbee	High	2480	-44.04	-16.55	PASS

Test Graphs

Zigbee_Ant1_Low_2405

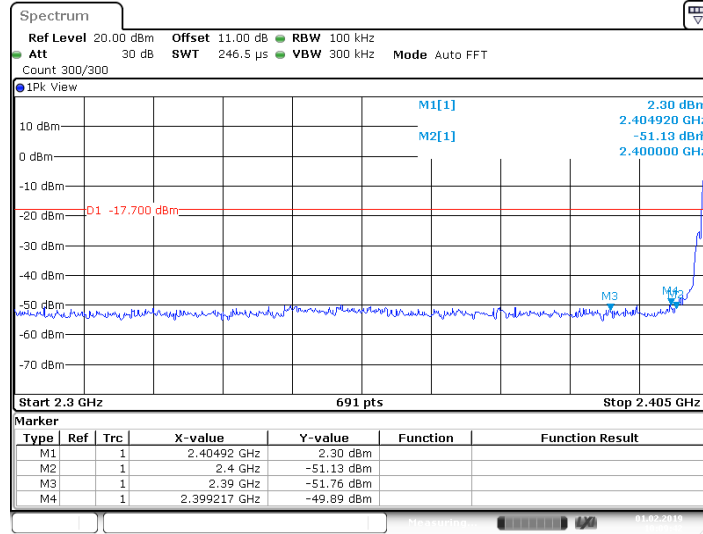

Zigbee_Ant1_High_2480

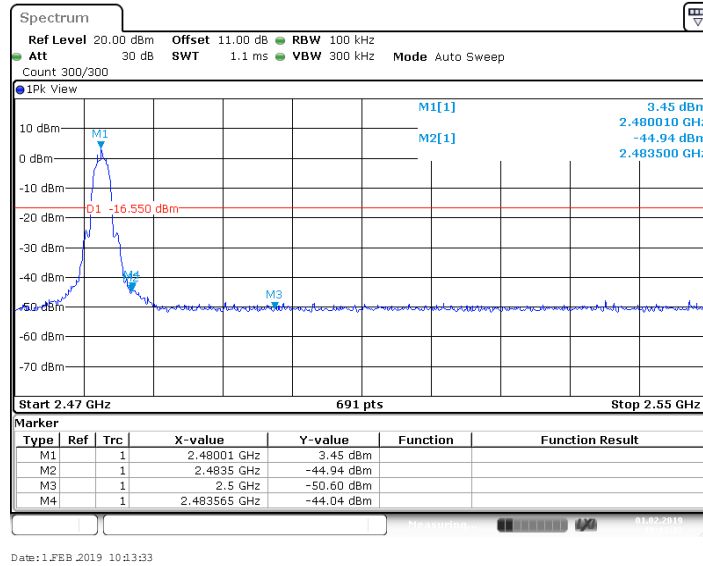

9.6 Spurious radiated emissions for transmitter

Test Method

- 1: The EUT was placed on a turn table which is 1.5m above ground plane for above 1GHz and 0.8m above ground for below 1GHz at 3 meter chamber room for test. The table was rotated 360 degrees to determine the position of the highest radiation.
- 2: The EUT was set 3 meters away from the interference – receiving antenna, which was mounted on the top of a variable – height antenna tower.
- 3: The height of antenna is varied from one meter to four meters above the ground to determine the maximum value of the field strength. Both horizontal and vertical polarizations of the antenna are set to make the measurement.
- 4: For each suspected emission, the EUT was arranged to its worst case and then the antenna was tuned to heights from 1 meter to 4 meters and the rotatable table was turned from 0 degrees to 360 degrees to find the maximum reading.
- 5: Use the following spectrum analyzer settings According to C63.10:
For Above 1GHz
Span = wide enough to capture the peak level of the in-band emission and all spurious
RBW = 1MHz, VBW \geq RBW for peak measurement and VBW = 10Hz for average measurement, Sweep = auto, Detector function = peak, Trace = max hold.
For Below 1GHz
Use the following spectrum analyzer settings:
Span = wide enough to capture the peak level of the in-band emission and all spurious
RBW = 100 KHz, VBW \geq RBW for peak measurement, Sweep = auto, Detector function = peak, Trace = max hold.

Note:

- 1: The resolution bandwidth and video bandwidth of test receiver/spectrum analyzer is 120 KHz for Quasi-peak detection (QP) at frequency below 1GHz.
- 2: The resolution bandwidth of test receiver/spectrum analyzer is 1MHz and the video bandwidth is 3MHz for peak detection (PK) at frequency above 1GHz.
- 3: The resolution bandwidth of test receiver/spectrum analyzer is 1MHz and the video bandwidth is 3MHz for RMS Average ((duty cycle < 98%) for Average detection (AV) at frequency above 1GHz, then the measurement results was added to a correction factor (20log(1/duty cycle)).
- 4: The resolution bandwidth of test receiver/spectrum analyzer is 1MHz and the video bandwidth is 10Hz (duty cycle > 98%) for Average detection (AV) at frequency above 1GHz.

Limit

The radio emission outside the operating frequency band shall be at least 20 dB below that in the 100kHz bandwidth within the band that contains the highest level of the desired power. Radiated emissions which fall in the restricted bands, as defined in section 15.205, must comply with the radiated emission limits specified in section 15.209.

Frequency MHz	Field Strength uV/m	Field Strength dBµV/m	Detector
30-88	100	40	QP
88-216	150	43.5	QP
216-960	200	46	QP
960-1000	500	54	QP
Above 1000	500	54	AV
Above 1000	5000	74	PK

Spurious radiated emissions for transmitter

According to C63.10, if the peak (or quasi-peak) measured value complies with the average limit, it is unnecessary to perform an average measurement, so AV emission value did not show in below table if the peak value complies with average limit.

Transmitting spurious emission test result as below:

2405MHz (30MHz – 1GHz)

Frequency MHz	Emission Level dBuV/m	Polarization	Limit dB μ V/m	Margin dB	Detector	Corr. dB	Result
870.936111	30.14	Horizontal	46.00	15.86	QP	-15.9	Pass
884.085000	28.54	Vertical	46.00	17.46	QP	-15.8	Pass

2405MHz (Above 1GHz)

Frequency MHz	Emission Level dBuV/m	Polarization	Limit dB μ V/m	Margin dB	Detector	Corr. dB/m	Result
7637.812500*	42.11	Horizontal	74.00	31.89	PK	9.7	Pass
10657.500000*	41.70	Vertical	74.00	32.30	PK	10.4	Pass

2445MHz (30MHz – 1GHz)

Frequency MHz	Emission Level dBuV/m	Polarization	Limit dB μ V/m	Margin dB	Detector	Corr. dB	Result
--	--	Horizontal	--	--	QP	--	Pass
--	--	Vertical	--	--	QP	--	Pass

2445MHz (Above 1GHz)

Frequency MHz	Emission Level dBuV/m	Polarization	Limit dB μ V/m	Margin dB	Detector	Corr. dB/m	Result
4880.156250*	50.18	Horizontal	74.00	23.82	PK	3.8	Pass
4880.156250*	49.34	Vertical	74.00	24.66	PK	3.8	Pass

2480MHz (30MHz – 1GHz)

Frequency MHz	Emission Level dBuV/m	Polarization	Limit dB μ V/m	Margin dB	Detector	Corr. dB	Result
--	--	Horizontal	--	--	QP	--	Pass
--	--	Vertical	--	--	QP	--	Pass

2480MHz (Above 1GHz)

Frequency MHz	Emission Level dBuV/m	Polarization	Limit dB μ V/m	Margin dB	Detector	Corr. dB/m	Result
4960.312500*	51.30	Horizontal	74.00	22.70	PK	4.3	Pass
4960.312500*	51.62	Vertical	74.00	22.38	PK	4.3	Pass

Remark:

- (1) “*” means the emission(s) appear within the restrict bands shall follow the requirement of section 15.205.
- (2) Data of measurement within this frequency range shown “--” in the table above means the reading of emissions are the noise floor or attenuated more than 10dB below the permissible limits or the field strength is too small to be measured.
- (3) Above 1GHz: Corrector factor = Antenna Factor + Cable Loss- Amplifier Gain.
- (4) Below 1GHz: Corrector factor = Antenna Factor + Cable Loss.

10 Test Equipment List

Radiated Emission Test

DESCRIPTION	MANUFACTURER	MODEL NO.	SERIAL NO.	CAL. DUE DATE
EMI Test Receiver	Rohde & Schwarz	ESR 26	101269	2019-7-6
Trilog Super Broadband Test Antenna	Schwarzbeck	VULB 9163	707	2019-6-28
Horn Antenna	Rohde & Schwarz	HF907	102294	2019-6-28
Pre-amplifier	Rohde & Schwarz	SCU 18	102230	2019-7-6
Signal Generator	Rohde & Schwarz	SMY01	839369/005	2019-7-6
Attenuator	Agilent	8491A	MY39264334	2019-7-6
3m Semi-anechoic chamber	TDK	9X6X6	----	2020-7-7
Test software	Rohde & Schwarz	EMC32	Version 9.15.00	N/A

RF conducted Test

DESCRIPTION	MANUFACTURER	MODEL NO.	SERIAL NO.	CAL. DUE DATE
Signal Generator	Rohde & Schwarz	SMB100A	108272	2019-7-6
Vector Signal Generator	Rohde & Schwarz	SMBV100A	262825	2019-7-6
Communication Synthetic Test Instrument	Rohde & Schwarz	CMW 270	101251	2019-5-31
Signal Analyzer	Rohde & Schwarz	FSV40	101030	2019-7-6
Vector Signal Generator	Rohde & Schwarz	SMU 200A	105324	2019-7-6
RF Switch Module	Rohde & Schwarz	OSP120/OSP-B157	101226/100851	2019-7-6
Power Splitter	Weinschel	1580	SC319	2019-7-5
10dB Attenuator	Weinschel	56-10	58764	2019-7-6
10dB Attenuator	R&S	DNF	DNF-001	2019-7-6
10dB Attenuator	R&S	DNF	DNF-002	2019-7-6
10dB Attenuator	R&S	DNF	DNF-003	2019-7-6
10dB Attenuator	R&S	DNF	DNF-004	2019-7-6
Test software	Rohde & Schwarz	EMC32	Version 10.38.00	N/A
Test software	Tonscend	System for BT/WIFI	Version 2.6	N/A

11 System Measurement Uncertainty

For a 95% confidence level, the measurement expanded uncertainties for defined systems, in accordance with the recommendations of ISO 17025 were:

System Measurement Uncertainty	
Items	Extended Uncertainty
Uncertainty for Radiated Emission in 3m chamber 30MHz-1000MHz	Horizontal: 4.91dB; Vertical: 4.89dB;
Uncertainty for Radiated Emission in 3m chamber 1000MHz-18000MHz	Horizontal: 4.80dB; Vertical: 4.79dB;
Uncertainty for Conducted RF test with TS 8997	RF Power Conducted: 1.16dB Frequency test involved: 0.6x10 ⁻⁷ or 1%