

FCC - TEST REPORT

Report Number : **68.950.18.0505.01** Date of Issue: January 29, 2019

Model : **7A-SS-ZABC-H0**

Product Type : **Sensors (4-in-1 Multi-Sensor)**

Applicant : **LEEDARSON LIGHTING CO., LTD**

Address : **Xingda Road, Xingtai Industrial Zone, Changtai County, Zhangzhou,**
Fujian, China

Production Facility : **LEEDARSON LIGHTING CO., LTD**

Address : **Xingda Road, Xingtai Industrial Zone, Changtai County, Zhangzhou,**
Fujian, China

Test Result : **Positive** **Negative**

Total pages including Appendices : **30**

TÜV SÜD Certification and Testing (China) Co., Ltd. Shenzhen Branch is a subcontractor to TÜV SÜD Product Service GmbH according to the principles outlined in ISO 17025.

TÜV SÜD Certification and Testing (China) Co., Ltd. Shenzhen Branch reports apply only to the specific samples tested under stated test conditions. Construction of the actual test samples has been documented. It is the manufacturer's responsibility to assure that additional production units of this model are manufactured with identical electrical and mechanical components. The manufacturer/importer is responsible to the Competent Authorities in Europe for any modifications made to the production units which result in non-compliance to the relevant regulations. TÜV SÜD Certification and Testing (China) Co., Ltd. Shenzhen Branch shall have no liability for any deductions, inferences or generalizations drawn by the client or others from TÜV SÜD Certification and Testing (China) Co., Ltd. Shenzhen Branch issued reports.

This report is the confidential property of the client. As a mutual protection to our clients, the public and ourselves, extracts from the test report shall not be reproduced except in full without our written approval.



1 Table of Contents

1	Table of Contents	2
2	Details about the Test Laboratory.....	3
3	Description of the Equipment under Test	4
4	Summary of Test Standards.....	5
5	Summary of Test Results.....	6
6	General Remarks	7
7	Test Setups	8
8	Systems test configuration.....	9
9	Technical Requirement	10
9.1	Conducted Emission	10
9.2	Conducted Peak output power	13
9.3	6dB bandwidth	15
9.4	Power spectral density.....	17
9.5	Spurious RF conducted emissions	19
9.6	Band edge	23
9.7	Spurious radiated emissions for transmitter	25
10	Test Equipment List.....	29
11	System Measurement Uncertainty	30

2 Details about the Test Laboratory

Details about the Test Laboratory

Test Site 1

Company name: TÜV SÜD Certification and Testing (China) Co., Ltd. Shenzhen Branch
Building 12&13, Zhiheng Wisdomland Business Park,
Nantou Checkpoint Road 2, Nanshan District,
Shenzhen City, 518052,
P. R. China

FCC Registration Number: 514049

Telephone: 86 755 8828 6998
Fax: 86 755 8828 5299

3 Description of the Equipment under Test

Product:	Sensors (4-in-1 Multi-Sensor)
Model no.:	7A-SS-ZABC-H0
FCC ID:	2AB2Q7ASSZABCH
Rated Input:	DC 3V (Supplied by CR123A Battery) DC 5V (Supplied by USB port)
RF Transmission Frequency:	2405MHz-2480MHz
No. of Operated Channel:	16
Modulation:	OQPSK
Antenna Type:	Integrated Antenna
Antenna Gain:	3dBi
Description of the EUT:	The Equipment Under Test (EUT) is a Sensors (4-in-1 Multi-Sensor) supports 2.4GHz Zigbee function.

4 Summary of Test Standards

Test Standards	
FCC Part 15 Subpart C 10-1-2017 Edition	PART 15 - RADIO FREQUENCY DEVICES Subpart C - Intentional Radiators

All the test methods were according to KDB558074 D01 DTS Meas Guidance v05 and ANSI C63.10 (2013).

5 Summary of Test Results

Technical Requirements				
FCC Part 15 Subpart C				
Test Condition		Pages	Test Result	Test Site
§15.207	Conducted emission AC power port	10	Pass	Site 1
§15.247(b)(1)	Conducted AV output power for FHSS	--	N/A	--
§15.247(b)(3)	Conducted AV output power for DTS	13	Pass	Site 1
§15.247(e)	Power spectral density	17	Pass	Site 1
§15.247(a)(2)	6dB bandwidth	15	Pass	Site 1
§15.247(a)(1)	20dB Occupied bandwidth	--	N/A	--
§15.247(a)(1)	Carrier frequency separation	--	N/A	--
§15.247(a)(1)(iii)	Number of hopping frequencies	--	N/A	--
§15.247(a)(1)(iii)	Dwell Time	--	N/A	--
§15.247(d)	Spurious RF conducted emissions	19	Pass	Site 1
§15.247(d)	Band edge	23	Pass	Site 1
§15.247(d) & §15.209 & §15.205	Spurious radiated emissions for transmitter	25	Pass	Site 1
§15.203	Antenna requirement	See note 1	Pass	--

Remark 1: N/A – Not Applicable.

Note 1: The EUT uses an Integrated Metal Antenna 3.0dBi max. According to §15.203, it is considered sufficiently to comply with the provisions of this section.



6 General Remarks

Remarks

This submittal(s) (test report) is intended for FCC ID:2AB2Q7ASSZABCH complies with Section 15.207, 15.205, 15.209, 15.247 of the FCC Part 15, Subpart C Rules;

SUMMARY:

All tests according to the regulations cited on page 5 were

- Performed

- **Not** Performed

The Equipment under Test

- **Fulfills** the general approval requirements.

- **Does not** fulfill the general approval requirements.

Sample Received Date: January 22, 2019

Testing Start Date: January 22, 2019

Testing End Date: January 23, 2019

- TÜV SÜD Certification and Testing (China) Co., Ltd. Shenzhen Branch -

Reviewed by:

Prepared by:

Tested by:



Laurent Yuan
EMC Project Manager

Henry Chen
EMC Project Engineer

Louise Liu
EMC Test Engineer

7 Test Setups

7.1 Radiated test setups

Below 1GHz

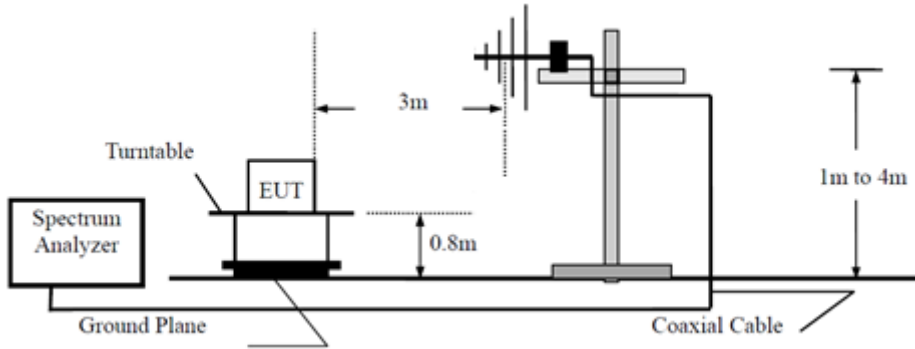

Above 1GHz

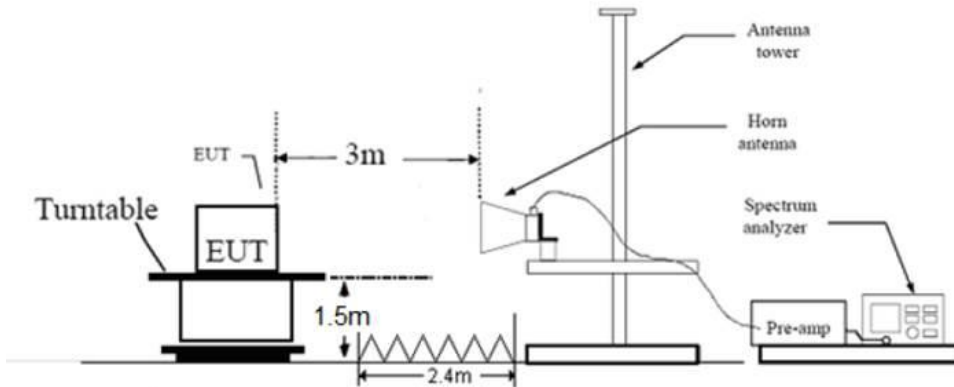

7.2 Conducted RF test setups

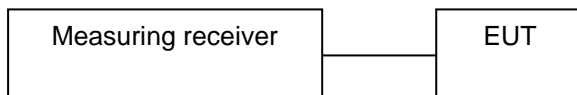

7.3 AC Power Line Conducted Emission test setups

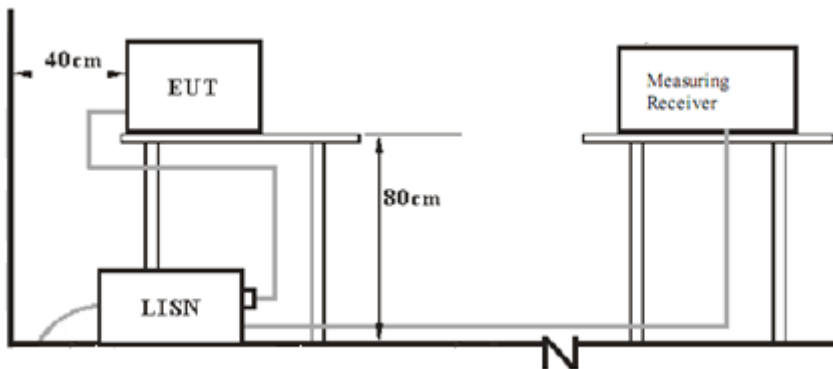

8 Systems test configuration

Auxiliary Equipment Used during Test:

DESCRIPTION	MANUFACTURER	MODEL NO.	S/N
Laptop	Lenovo	T410	---

Test software information:

Test Software Version	UartAssis V3.8.3		
Modulation	Setting TX Power	Packet Type	
OQPSK	4dBm	---	

The system was configured to channel 11, 19, and 26 for the test.

9 Technical Requirement

9.1 Conducted Emission

Test Method

1. The EUT was placed on a table, which is 0.8m above ground plane
2. The power line of the EUT is connected to the AC mains through an Artificial Mains Network (A.M.N.).
3. Maximum procedure was performed to ensure EUT compliance
4. A EMI test receiver is used to test the emissions from both sides of AC line

Limit

Frequency MHz	QP Limit dB μ V	AV Limit dB μ V
0.150-0.500	66-56*	56-46*
0.500-5	56	46
5-30	60	50

Note: “*” means Decreasing line;

Conducted Emission

Product Type : Sensors (4-in-1 Multi-Sensor)
 M/N : 7A-SS-ZABC-H0
 Operating Condition : Normal working with transmitting
 Test Specification : Power Line, Live
 Comment : AC 120V/60Hz

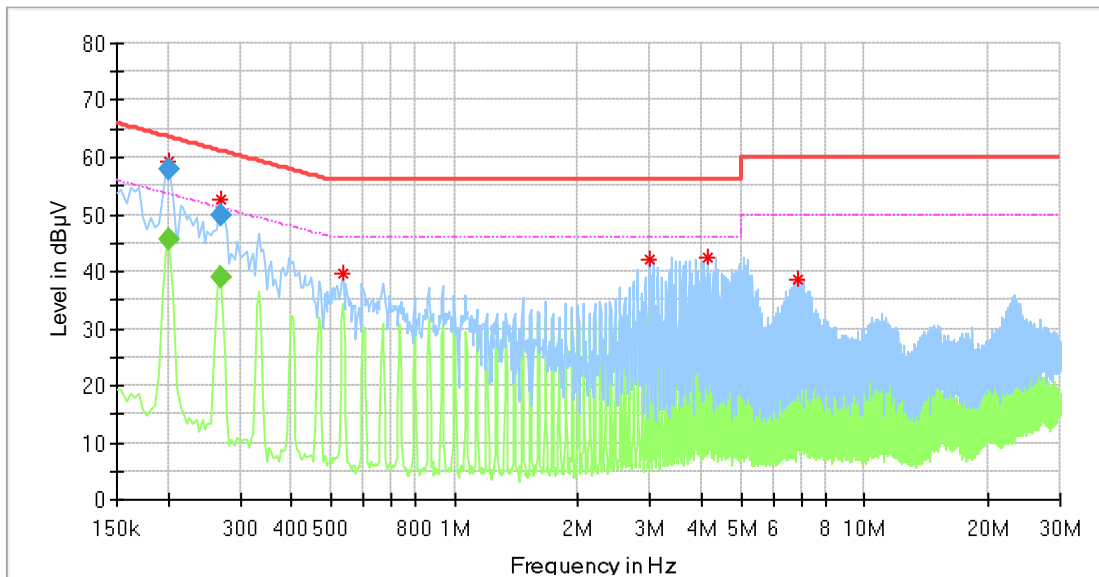

Critical Freqs

Frequency (MHz)	MaxPeak (dBµV)	Average (dBµV)	Limit (dBµV)	Margin (dB)	Line	Corr. (dB)
0.201500	59.35	---	63.69	4.34	L1	10.2
0.269500	52.46	---	61.24	8.78	L1	10.2
0.534000	39.81	---	56.00	16.19	L1	10.3
3.002000	42.23	---	56.00	13.77	L1	10.4
4.138000	42.49	---	56.00	13.51	L1	10.4
6.874000	38.52	---	60.00	21.48	L1	10.5

Final Result

Frequency (MHz)	QuasiPeak (dBµV)	Average (dBµV)	Limit (dBµV)	Margin (dB)	Line	Corr. (dB)
0.201500	---	45.64	53.55	7.91	L1	10.2
0.201500	57.82	---	63.55	5.73	L1	10.2
0.269500	---	39.09	51.13	12.04	L1	10.2
0.269500	49.72	---	61.13	11.41	L1	10.2

Remark: Correct factor=cable loss + LISN factor

Conducted Emission

Product Type : Sensors (4-in-1 Multi-Sensor)
 M/N : 7A-SS-ZABC-H0
 Operating Condition : Normal working with transmitting
 Test Specification : Power Line, Neutral
 Comment : AC 120V/60Hz

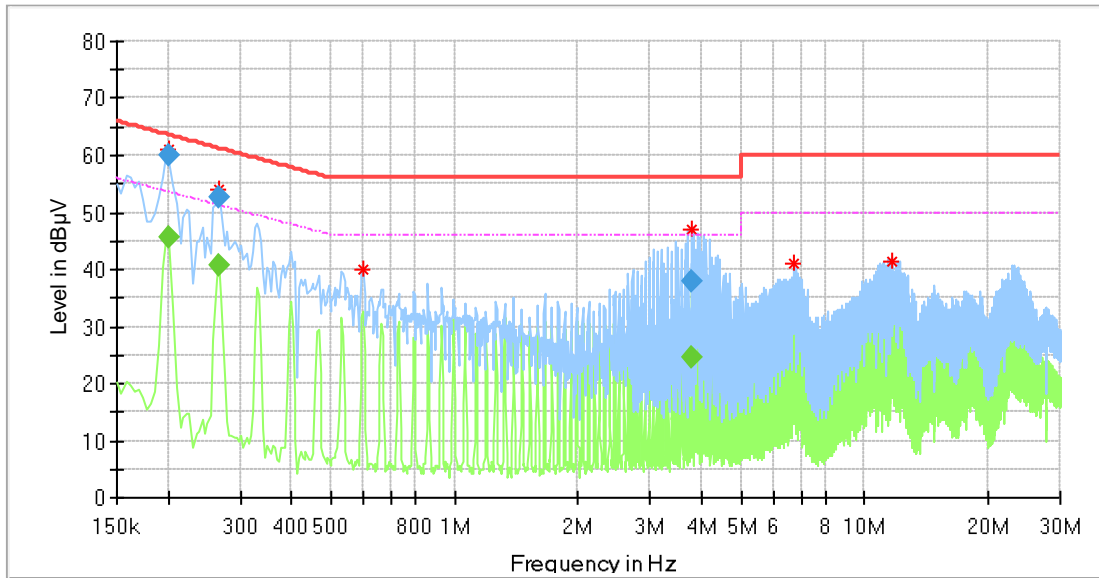

Critical Freqs

Frequency (MHz)	MaxPeak (dBµV)	Average (dBµV)	Limit (dBµV)	Margin (dB)	Line	Corr. (dB)
0.201500	61.17	---	63.69	2.52	N	10.2
0.265500	54.19	---	61.24	7.06	N	10.2
0.598000	40.17	---	56.00	15.83	N	10.3
3.785500	46.93	---	56.00	9.07	N	10.4
6.702000	41.10	---	60.00	18.90	N	10.6
11.618000	41.44	---	60.00	18.56	N	10.7

Final Result

Frequency (MHz)	QuasiPeak (dBµV)	Average (dBµV)	Limit (dBµV)	Margin (dB)	Line	Corr. (dB)
0.201500	---	45.46	53.55	8.09	N	10.2
0.201500	59.83	---	63.55	3.72	N	10.2
0.265500	---	40.62	51.26	10.64	N	10.2
0.265500	52.75	---	61.26	8.51	N	10.2
3.785500	---	24.42	46.00	21.58	N	10.4
3.785500	37.85	---	56.00	18.15	N	10.4

Remark: Correct factor=cable loss + LISN factor

9.2 Conducted Peak output power

Test Method

1. Setting the highest output power level of the EUT:
2. Connect to gated spectrum analyzer.

Test Setup

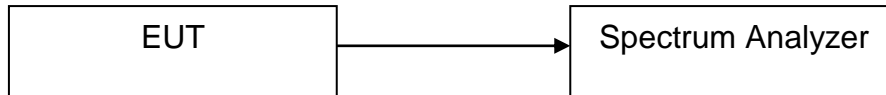

Limits

According to §15.247 (b) (3), conducted peak output power limit as below:

Frequency Range MHz	Limit W	Limit dBm
2400-2483.5	≤1	≤30

Test result as below table

Frequency MHz	Conducted peak Output Power dBm	Result
Top channel 2405MHz	3.64	Pass
Middle channel 2445MHz	3.86	Pass
Bottom channel 2480MHz	3.95	Pass

Test Graphs

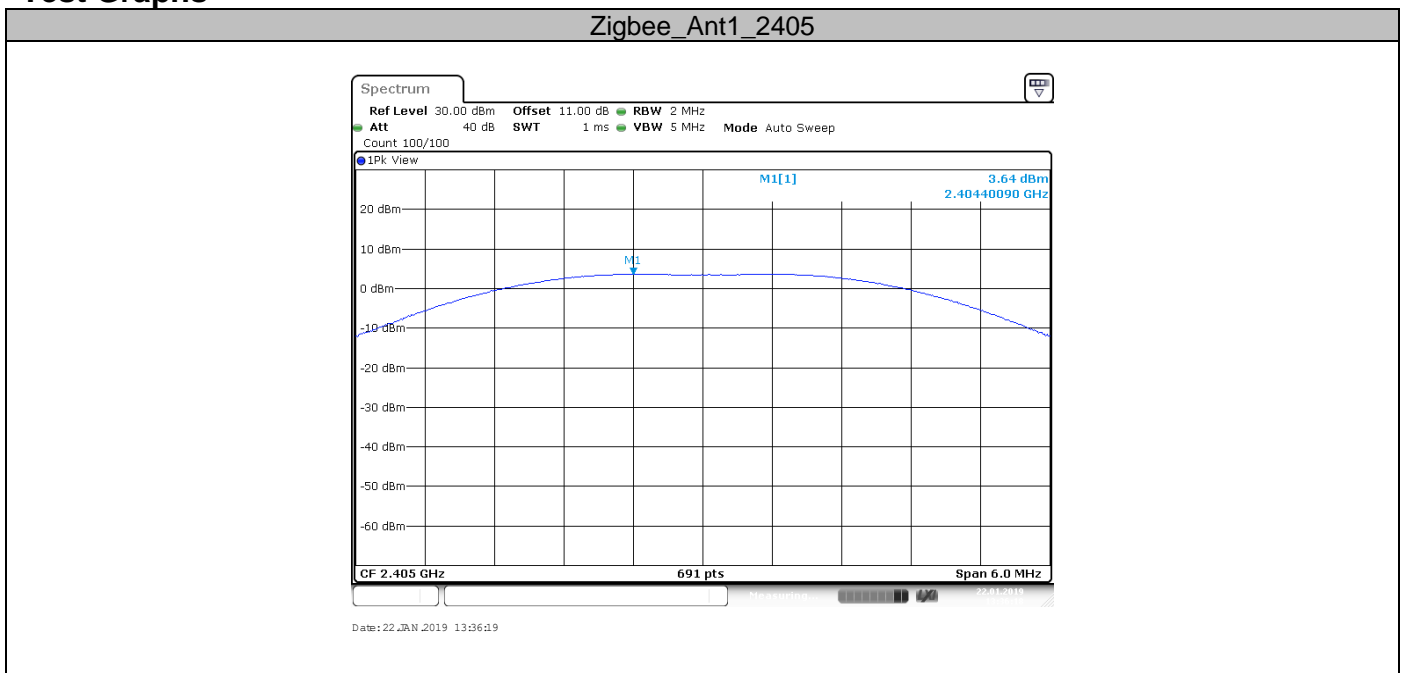

Zigbee_Ant1_2445

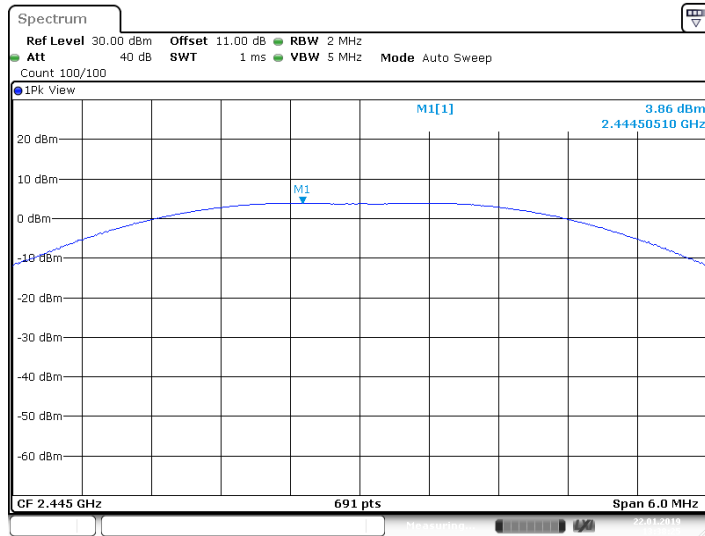

Date: 22_JAN_2019 13:38:25

Zigbee_Ant1_2480

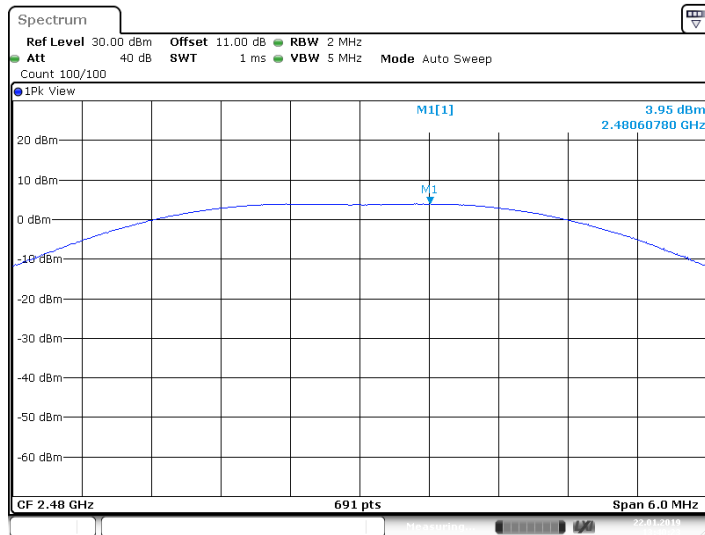

Date: 22_JAN_2019 13:40:24

9.3 6dB bandwidth

Test Method

1. Use the following spectrum analyzer settings:
RBW=100K, VBW≥3RBW, Sweep = auto, Detector function = peak, Trace = max hold
2. Use the automatic bandwidth measurement capability of an instrument, may be employed using the X dB bandwidth mode with X set to 6 dB, care shall be taken so that the bandwidth measurement is not influenced by any intermediate power nulls in the fundamental emission that might be ≥ 6 dB.
3. Allow the trace to stabilize, record the X dB Bandwidth value.

Limit

Limit [kHz]

≥500

Test result

Test Mode	Channel (MHz)	Result (MHz)	Limit (KHz)	Verdict
Zigbee	2405	0.832	≥500	PASS
Zigbee	2445	0.916	≥500	PASS
Zigbee	2480	1.024	≥500	PASS

Test Graphs

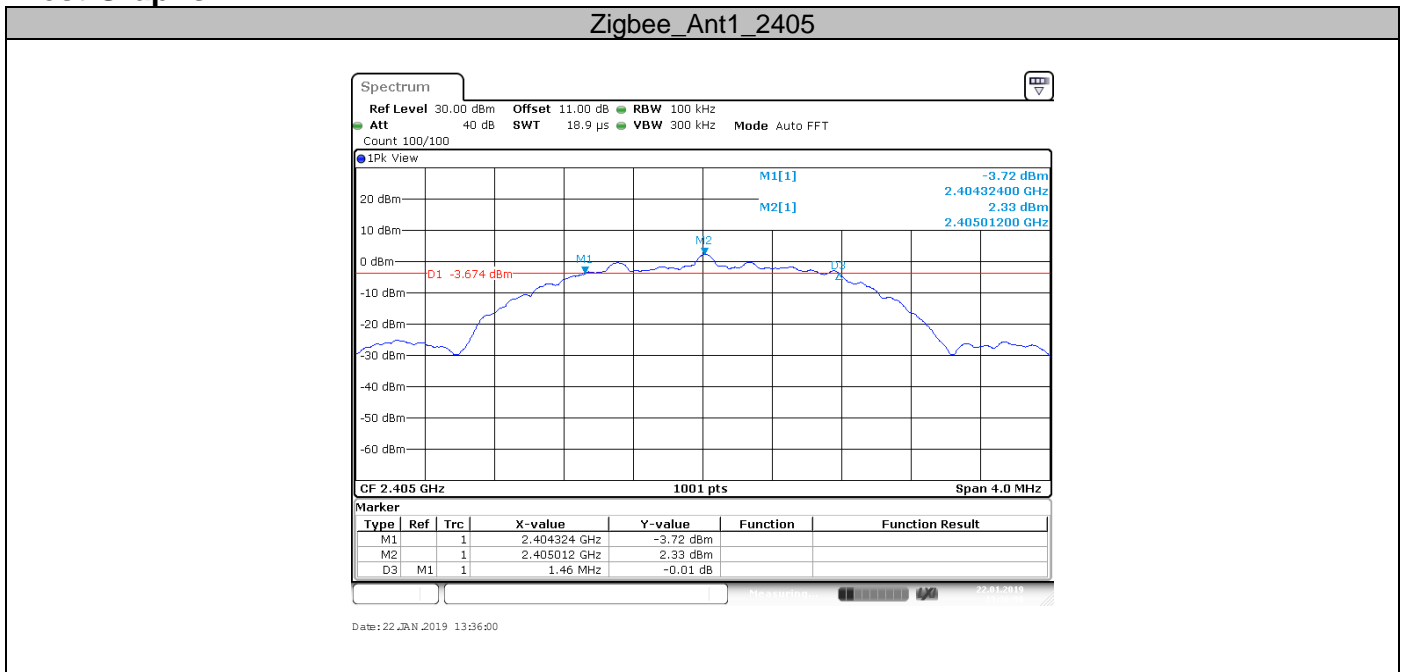

Zigbee_Ant1_2445

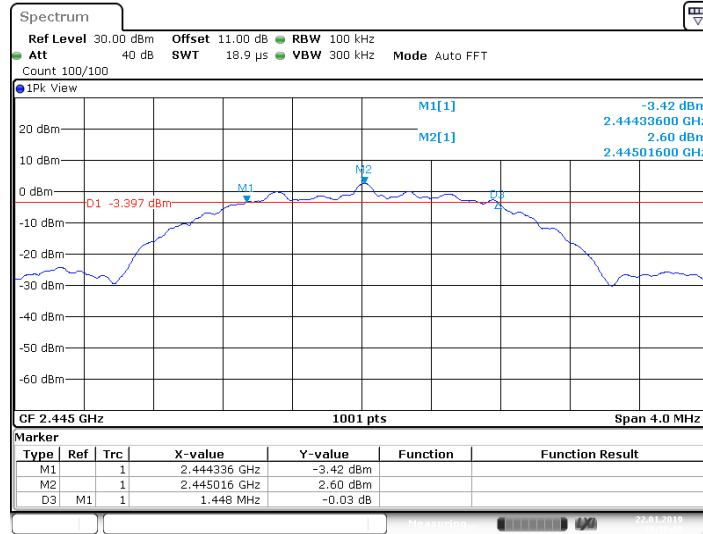

Zigbee_Ant1_2480

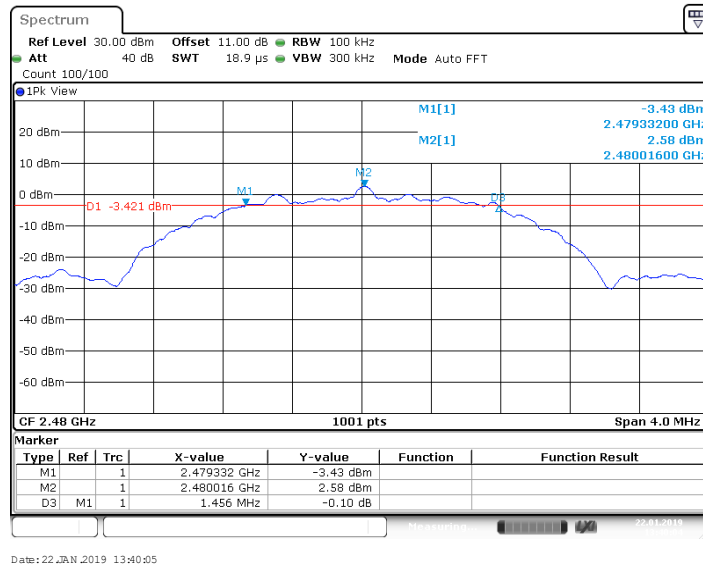

9.4 Power spectral density

Test Method

This procedure shall be used if maximum peak conducted output power was used to demonstrate compliance:

1. Set analyzer center frequency to DTS channel center frequency. RBW=100kHz, VBW≥3RBW, Span=1.5 times DTS bandwidth, Detector=Peak, Sweep=auto, Trace= max hold.
2. Allow trace to fully stabilize, use the peak marker function to determine the maximum amplitude level within the RBW.
3. Repeat above procedures until other frequencies measured were completed.

Limit

Limit [dBm]

≤8

Test result

Test Mode	Channel (MHz)	Result (dBm)	Limit	Verdict
Zigbee	2405	-6.81	8	PASS
Zigbee	2445	-6.39	8	PASS
Zigbee	2480	-6.47	8	PASS

Test Graphs

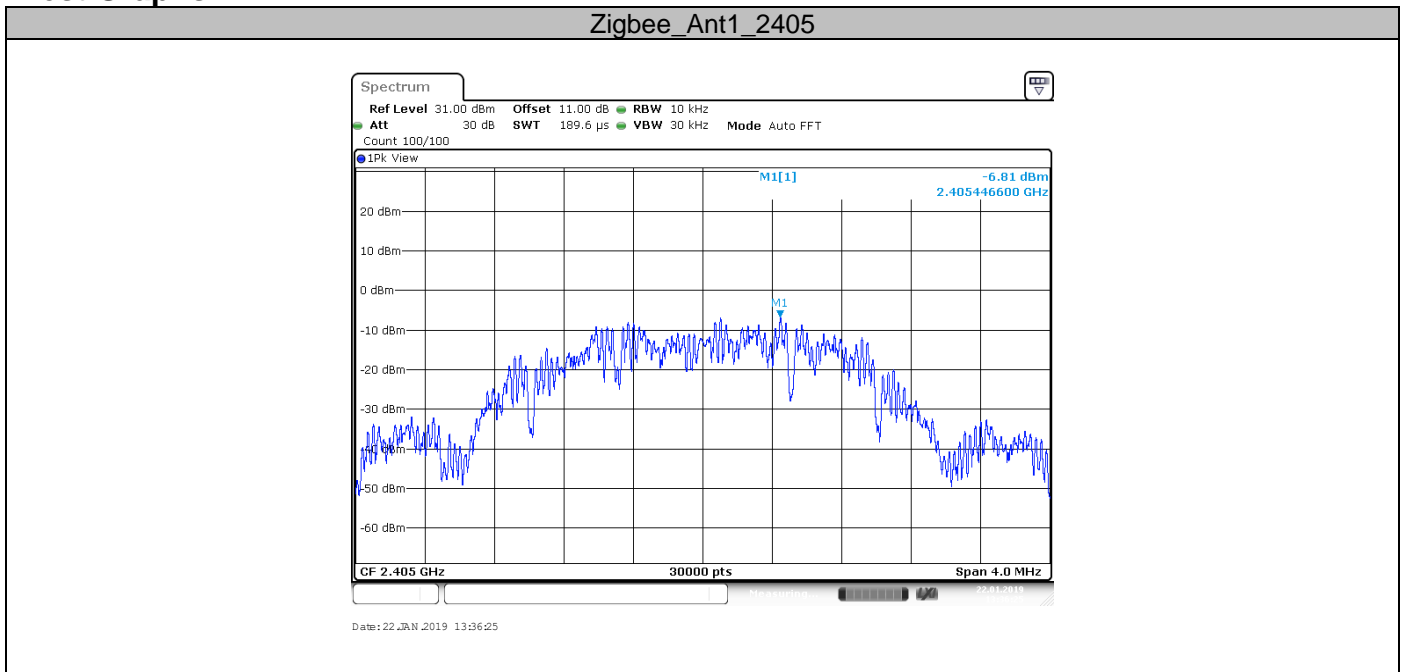

Zigbee_Ant1_2445

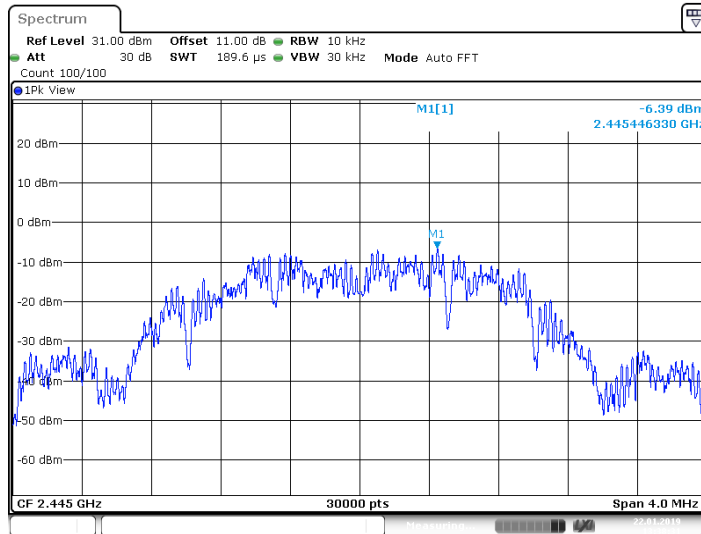

Date: 22_JAN_2019 13:38:31

Zigbee_Ant1_2480

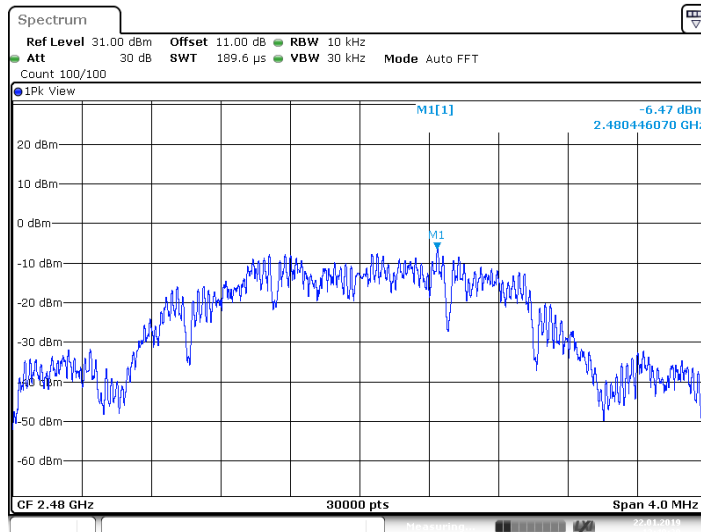

Date: 22_JAN_2019 13:40:30

9.5 Spurious RF conducted emissions

Test Method

1. Establish a reference level by using the following procedure:
 - a. Set RBW=100 kHz. VBW≥3RBW. Detector =peak, Sweep time = auto couple, Trace mode = max hold.
 - b. Allow trace to fully stabilize, use the peak marker function to determine the maximum PSD level.
2. Use the maximum PSD level to establish the reference level.
 - a. Set the center frequency and span to encompass frequency range to be measured.
 - b. Use the peak marker function to determine the maximum amplitude level. Ensure that the amplitude of all unwanted emissions outside of the authorized frequency band (excluding restricted frequency bands) are attenuated by at least the minimum requirements, report the three highest emissions relative to the limit.
3. Repeat above procedures until other frequencies measured were completed.

Limit

Frequency Range MHz	Limit (dBc)
30-25000	-20

Test Result

Test Mode	Channel (MHz)	Freq Range (MHz)	Result (dBm)	Limit (dBm)	Verdict
Zigbee	2405	30~1000	0.88	-58.72	-19.12
Zigbee	2405	1000~26500	0.88	-43.09	-19.12
Zigbee	2445	30~1000	2.12	-59.04	-17.88
Zigbee	2445	1000~26500	2.12	-43.06	-17.88
Zigbee	2480	30~1000	2.66	-59.11	-17.34
Zigbee	2480	1000~26500	2.66	-41.67	-17.34

Test Graphs

Zigbee_Ant1_2405_0~Reference

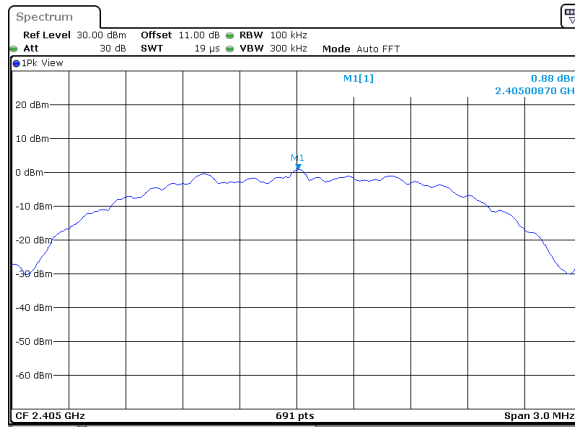

Date: 22.Jun.2019 13:36:42

Zigbee_Ant1_2405_30~1000

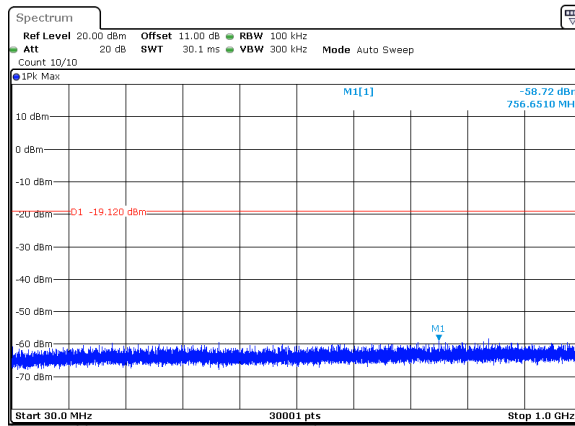

Date: 22.Jun.2019 13:36:50

Zigbee_Ant1_2405_1000~26500

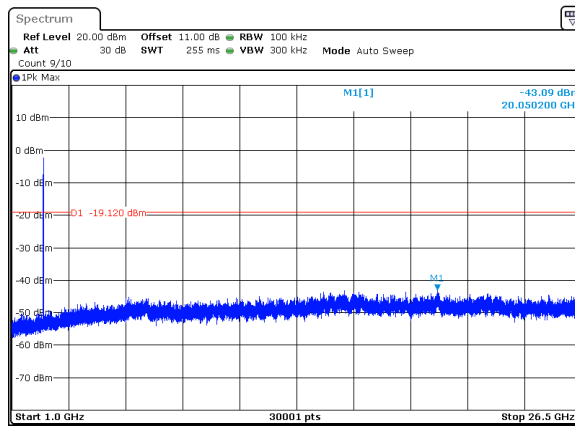

Date: 22.Jun.2019 13:37:52

Zigbee_Ant1_2445_0~Reference

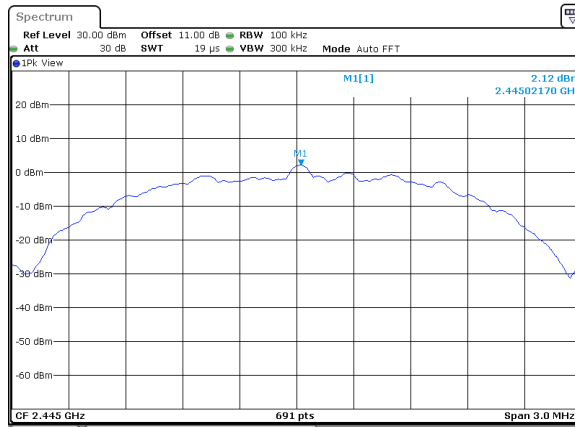

Zigbee_Ant1_2445_30~1000

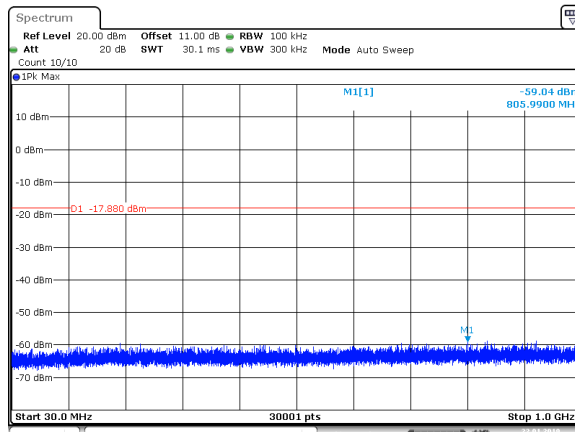

Zigbee_Ant1_2445_1000~26500

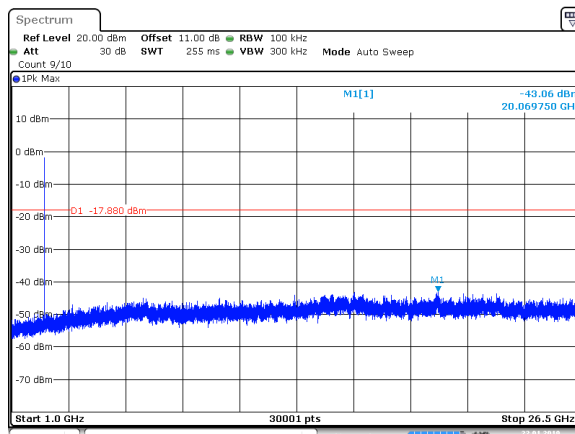

Zigbee_Ant1_2480_0~Reference

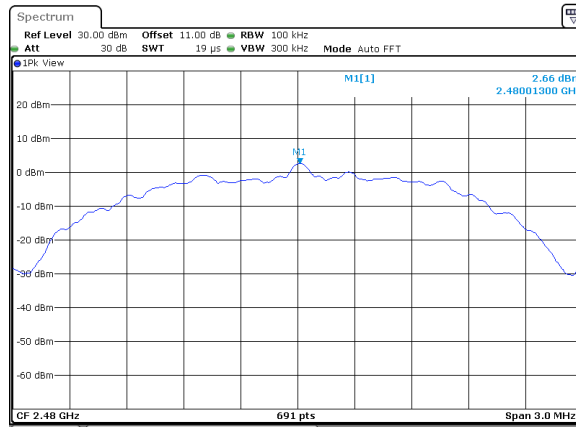

Date: 22.Jun.2019 13:40:47

Zigbee_Ant1_2480_30~1000

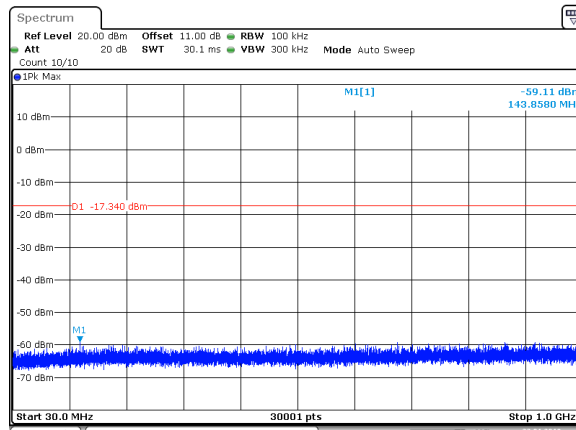

Date: 22.Jun.2019 13:40:55

Zigbee_Ant1_2480_1000~26500

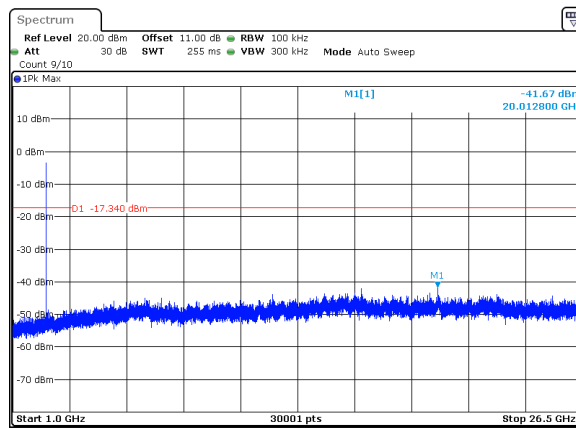

Date: 22.Jun.2019 13:41:27

9.6 Band edge

Test Method

- 1 Use the following spectrum analyzer settings:
Span = wide enough to capture the peak level of the in-band emission and all spurious
RBW = 100 kHz, VBW \geq RBW, Sweep = auto, Detector function = peak, Trace = max hold.
- 2 Allow the trace to stabilize, use the peak and delta measurement to record the result.
- 3 The level displayed must comply with the limit specified in this Section.

Limit

Frequency Range MHz	Limit (dBc)
30-25000	-20

Test result

Test Mode	Ch Name	Channel (MHz)	Result (dBm)	Limit	Verdict
Zigbee	Low	2405	-49.33	-19.18	PASS
Zigbee	High	2480	-46.14	-17.26	PASS

Test Graphs

Zigbee_Ant1_Low_2405

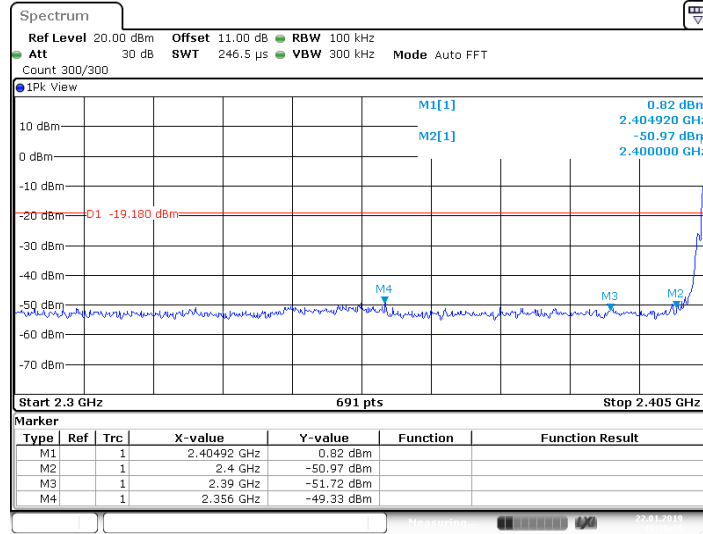

Zigbee_Ant1_High_2480

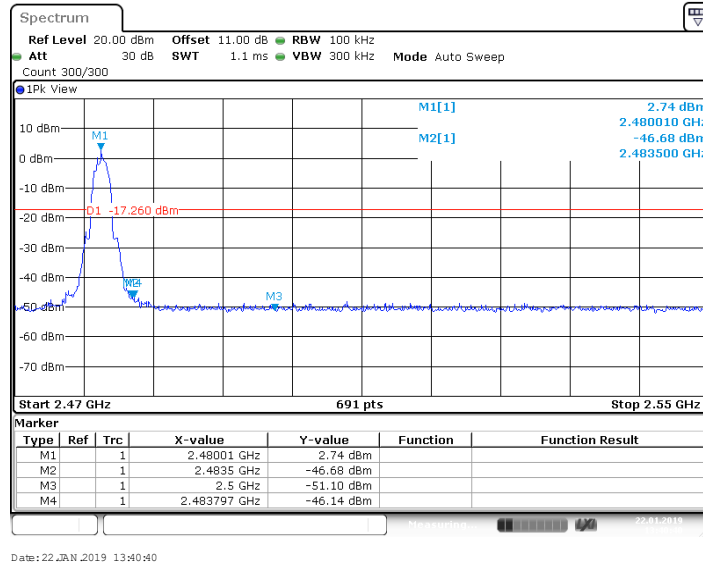

9.7 Spurious radiated emissions for transmitter

Test Method

- 1: The EUT was placed on a turn table which is 1.5m above ground plane for above 1GHz and 0.8m above ground for below 1GHz at 3 meter chamber room for test. The table was rotated 360 degrees to determine the position of the highest radiation.
- 2: The EUT was set 3 meters away from the interference – receiving antenna, which was mounted on the top of a variable – height antenna tower.
- 3: The height of antenna is varied from one meter to four meters above the ground to determine the maximum value of the field strength. Both horizontal and vertical polarizations of the antenna are set to make the measurement.
- 4: For each suspected emission, the EUT was arranged to its worst case and then the antenna was tuned to heights from 1 meter to 4 meters and the rotatable table was turned from 0 degrees to 360 degrees to find the maximum reading.
- 5: Use the following spectrum analyzer settings According to C63.10:
For Above 1GHz
Span = wide enough to capture the peak level of the in-band emission and all spurious
RBW = 1MHz, VBW \geq RBW for peak measurement and VBW = 10Hz for average measurement, Sweep = auto, Detector function = peak, Trace = max hold.
For Below 1GHz
Use the following spectrum analyzer settings:
Span = wide enough to capture the peak level of the in-band emission and all spurious
RBW = 100 KHz, VBW \geq RBW for peak measurement, Sweep = auto, Detector function = peak, Trace = max hold.

Note:

- 1: The resolution bandwidth and video bandwidth of test receiver/spectrum analyzer is 120 KHz for Quasi-peak detection (QP) at frequency below 1GHz.
- 2: The resolution bandwidth of test receiver/spectrum analyzer is 1MHz and the video bandwidth is 3MHz for peak detection (PK) at frequency above 1GHz.
- 3: The resolution bandwidth of test receiver/spectrum analyzer is 1MHz and the video bandwidth is 3MHz for RMS Average ((duty cycle < 98%) for Average detection (AV) at frequency above 1GHz, then the measurement results was added to a correction factor (20log(1/duty cycle)).
- 4: The resolution bandwidth of test receiver/spectrum analyzer is 1MHz and the video bandwidth is 10Hz (duty cycle > 98%) for Average detection (AV) at frequency above 1GHz.

Limit

The radio emission outside the operating frequency band shall be at least 20 dB below that in the 100kHz bandwidth within the band that contains the highest level of the desired power. Radiated emissions which fall in the restricted bands, as defined in section 15.205, must comply with the radiated emission limits specified in section 15.209.

Frequency MHz	Field Strength uV/m	Field Strength dBµV/m	Detector
30-88	100	40	QP
88-216	150	43.5	QP
216-960	200	46	QP
960-1000	500	54	QP
Above 1000	500	54	AV
Above 1000	5000	74	PK

Spurious radiated emissions for transmitter

According to C63.10, if the peak (or quasi-peak) measured value complies with the average limit, it is unnecessary to perform an average measurement, so AV emission value did not show in below table if the peak value complies with average limit.

Transmitting spurious emission test result as below:

2405MHz (30MHz – 1GHz)

Frequency MHz	Emission Level dBuV/m	Polarization	Limit dB μ V/m	Margin dB	Detector	Corr. dB	Result
175.877222	12.23	Horizontal	43.50	31.27	QP	-29.7	Pass
49.938889	13.29	Vertical	40.00	26.71	QP	-24.9	Pass

2405MHz (Above 1GHz)

Frequency MHz	Emission Level dBuV/m	Polarization	Limit dB μ V/m	Margin dB	Detector	Corr. dB/m	Result
7533.750000*	41.72	Horizontal	74.00	32.28	PK	9.8	Pass
11829.843750*	43.90	Vertical	74.00	30.10	PK	11.7	Pass

2445MHz (30MHz – 1GHz)

Frequency MHz	Emission Level dBuV/m	Polarization	Limit dB μ V/m	Margin dB	Detector	Corr. dB	Result
--	--	Horizontal	--	--	QP	--	Pass
--	--	Vertical	--	--	QP	--	Pass

2445MHz (Above 1GHz)

Frequency MHz	Emission Level dBuV/m	Polarization	Limit dB μ V/m	Margin dB	Detector	Corr. dB/m	Result
7657.031250*	41.78	Horizontal	74.00	32.22	PK	9.3	Pass
7479.843750*	42.25	Vertical	74.00	31.75	PK	9.0	Pass

2480MHz (30MHz – 1GHz)

Frequency MHz	Emission Level dBuV/m	Polarization	Limit dB μ V/m	Margin dB	Detector	Corr. dB	Result
--	--	Horizontal	--	--	QP	--	Pass
--	--	Vertical	--	--	QP	--	Pass

2480MHz (Above 1GHz)

Frequency MHz	Emission Level dBuV/m	Polarization	Limit dB μ V/m	Margin dB	Detector	Corr. dB/m	Result
7609.218750*	41.59	Horizontal	74.00	32.41	PK	9.9	Pass
12517.500000*	45.70	Vertical	74.00	28.30	PK	-14.5	Pass

Remark:

- (1) “*” means the emission(s) appear within the restrict bands shall follow the requirement of section 15.205.
- (2) Data of measurement within this frequency range shown “--” in the table above means the reading of emissions are the noise floor or attenuated more than 10dB below the permissible limits or the field strength is too small to be measured.
- (3) Above 1GHz: Corrector factor = Antenna Factor + Cable Loss- Amplifier Gain.
- (4) Below 1GHz: Corrector factor = Antenna Factor + Cable Loss.

10 Test Equipment List

Radiated Emission Test

DESCRIPTION	MANUFACTURER	MODEL NO.	SERIAL NO.	CAL. DUE DATE
EMI Test Receiver	Rohde & Schwarz	ESR 26	101269	2019-7-6
Trilog Super Broadband Test Antenna	Schwarzbeck	VULB 9163	707	2019-6-28
Horn Antenna	Rohde & Schwarz	HF907	102294	2019-6-28
Pre-amplifier	Rohde & Schwarz	SCU 18	102230	2019-7-6
Signal Generator	Rohde & Schwarz	SMY01	839369/005	2019-7-6
Attenuator	Agilent	8491A	MY39264334	2019-7-6
3m Semi-anechoic chamber	TDK	9X6X6	----	2020-7-7
Test software	Rohde & Schwarz	EMC32	Version 9.15.00	N/A

Conducted Emission Test

DESCRIPTION	MANUFACTURER	MODEL NO.	SERIAL NO.	CAL. DUE DATE
EMI Test Receiver	Rohde & Schwarz	ESR 3	101782	2019-7-6
LISN	Rohde & Schwarz	ENV4200	100249	2019-7-6
LISN	Rohde & Schwarz	ENV432	101318	2019-7-6
LISN	Rohde & Schwarz	ENV216	100326	2019-7-6
ISN	Rohde & Schwarz	ENY81	100177	2019-7-6
ISN	Rohde & Schwarz	ENY81-CA6	101664	2019-7-6
High Voltage Probe	Rohde & Schwarz	TK9420(VT94 20)	9420-584	2019-6-30
RF Current Probe	Rohde & Schwarz	EZ-17	100816	2019-6-30
Attenuator	Shanghai Huaxiang	TS2-26-3	080928189	2019-7-6
Test software	Rohde & Schwarz	EMC32	Version9.15.00	N/A

RF Conducted Test

DESCRIPTION	MANUFACTURER	MODEL NO.	SERIAL NO.	CAL. DUE DATE
Signal Analyzer	Rohde & Schwarz	FSV40	101030	2019-7-6

11 System Measurement Uncertainty

For a 95% confidence level, the measurement expanded uncertainties for defined systems, in accordance with the recommendations of ISO 17025 were:

System Measurement Uncertainty	
Items	Extended Uncertainty
Uncertainty for Radiated Spurious Emission 25MHz-3000MHz	Horizontal: 4.80dB; Vertical: 4.87dB;
Uncertainty for Radiated Spurious Emission 3000MHz-18000MHz	Horizontal: 4.59dB; Vertical: 4.58dB;
Uncertainty for Radiated Spurious Emission 18000MHz-40000MHz	Horizontal: 5.05dB; Vertical: 5.04dB;
Uncertainty for Conducted Emission 150kHz-30MHz (for test using AMN ENV432 or ENV4200)	3.21dB
Uncertainty for Conducted RF test with TS 8997	RF Power Conducted: 1.16dB Frequency test involved: 0.6x10 ⁻⁷ or 1%