



**FCC 47 CFR PART 15 SUBPART C
ISED RSS-210 ISSUE 10**

CERTIFICATION TEST REPORT

For

Outdoor contact sensor

MODEL NUMBER: 5F49E9

FCC ID: 2AB2Q5F49E9

IC: 10256A-5F49E9

REPORT NUMBER: 4790026122.1-1

ISSUE DATE: September 02, 2021

Prepared for

LEEDARSON LIGHTING CO., LTD.

Xingda Road, Xingtai Industrial Zone, Changtai County, Zhangzhou, Fujian, China

Prepared by

UL Verification Services (Guangzhou) Co., Ltd, Song Shan Lake Branch

Room 101, Building 10, Innovation Technology Park,

Song Shan Lake Hi tech Development Zone, Dongguan, 523808, China

Tel: +86 769 33817100

Fax: +86 769 33244054

Website: www.ul.com



Revision History

<u>Rev.</u>	<u>Issue Date</u>	<u>Revisions</u>	<u>Revised By</u>
V0	09/02/2021	Initial Issue	



TABLE OF CONTENTS

1. ATTESTATION OF TEST RESULTS	4
2. TEST METHODOLOGY	5
3. FACILITIES AND ACCREDITATION	5
4. CALIBRATION AND UNCERTAINTY	6
4.1. <i>MEASURING INSTRUMENT CALIBRATION</i>	6
4.2. <i>MEASUREMENT UNCERTAINTY</i>	6
5. EQUIPMENT UNDER TEST	7
5.1. <i>DESCRIPTION OF EUT</i>	7
5.2. <i>MAXIMUM EMISSIONS FIELD STRENGTH</i>	7
5.3. <i>THE WORSE CASE POWER SETTING PARAMETER</i>	8
5.4. <i>TEST ENVIRONMENT</i>	8
5.5. <i>TEST CHANNEL CONFIGURATION</i>	8
5.6. <i>DESCRIPTION OF AVAILABLE ANTENNAS</i>	9
5.7. <i>DESCRIPTION OF TEST SETUP</i>	10
5.8. <i>MEASURING INSTRUMENT AND SOFTWARE USED</i>	11
6. SUMMARY OF TEST RESULTS	13
7. ANTENNA PORT TEST RESULTS	14
7.1. <i>ON TIME AND DUTY CYCLE</i>	14
7.2. <i>20 dB AND 99% BANDWIDTH</i>	15
8. RADIATED TEST RESULTS	18
8.1. <i>LIMITS AND PROCEDURE</i>	18
8.2. <i>FIELD STRENGTH OF INTENTIONAL EMISSIONS</i>	24
8.3. <i>SPURIOUS EMISSIONS BELOW 30M</i>	30
8.4. <i>SPURIOUS EMISSIONS BELOW 1 GHz</i>	33
8.5. <i>SPURIOUS EMISSIONS 1 ~ 10GHz</i>	35
9. ANTENNA REQUIREMENTS	41



1. ATTESTATION OF TEST RESULTS

Applicant Information

Company Name: LEEDARSON LIGHTING CO., LTD.
Address: Xingda Road, Xingtai Industrial Zone, Changtai County, Zhangzhou, Fujian, China

Manufacturer Information

Company Name: Ring LLC
Address: 1523 26th Street, Santa Monica CA 90404, USA

EUT Information

EUT Name: Outdoor contact sensor
Model: 5F49E9
Brand: ring
Sample Received Date: July 15, 2021
Sample Status: Normal
Sample ID: 4072704
Date of Tested: July 15, 2021~ August 30, 2021

APPLICABLE STANDARDS	
STANDARD	TEST RESULTS
CFR 47 Part 15 Subpart C	PASS
ISED RSS-210 Issue 10	PASS
ISED RSS-GEN Issue 5	PASS

Prepared By:

Checked By:

Kebo Zhang
Project Engineer

Shawn Wen
Laboratory Leader

Approved By:

Stephen Guo
Laboratory Manager



2. TEST METHODOLOGY

The tests documented in this report were performed in accordance with FCC CFR 47 Part 2, FCC CFR 47 Part 15, ANSI C63.10-2013, ISED RSS-210 Issue 10 and RSS-GEN Issue 5

3. FACILITIES AND ACCREDITATION

Accreditation Certificate	<p>A2LA (Certificate No.: 4102.01) UL Verification Services (Guangzhou) Co., Ltd. Song Shan Lake Branch. has been assessed and proved to be in compliance with A2LA.</p> <p>FCC (FCC Designation No.: CN1187) UL Verification Services (Guangzhou) Co., Ltd. Song Shan Lake Branch. Has been recognized to perform compliance testing on equipment subject to the Commission's Declaration of Conformity (DoC) and Certification rules</p> <p>ISED (Company No.: 21320) UL Verification Services (Guangzhou) Co., Ltd. Song Shan Lake Branch. has been registered and fully described in a report filed with ISED. Body Identifier (CABID) is CN0046.</p> <p>VCCI (Registration No.: G-20019, R-20004, C-20012 and T-20011) UL Verification Services (Guangzhou) Co., Ltd. Song Shan Lake Branch. has been assessed and proved to be in compliance with VCCI, the Membership No. is 3793. Facility Name: Chamber D, the VCCI registration No. is G-20019 and R-20004 Shielding Room B, the VCCI registration No. is C-20012 and T-20011</p>
---------------------------	---

Note 1: All tests measurement facilities use to collect the measurement data are located at Building 10, Innovation Technology Park, Song Shan Lake Hi tech Development Zone, Dongguan, 523808, China

Note 2: The test anechoic chamber in UL Verification Services (Guangzhou) Co., Ltd. Song Shan Lake Branch had been calibrated and compared to the open field sites and the test anechoic chamber is shown to be equivalent to or worst case from the open field site.

Note 3: For below 30MHz, lab had performed measurements at test anechoic chamber and comparing to measurements obtained on an open field site. And these measurements below 30MHz had been correlated to measurements performed on an OFS.



4. CALIBRATION AND UNCERTAINTY

4.1. MEASURING INSTRUMENT CALIBRATION

The measuring equipment utilized to perform the tests documented in this report has been calibrated in accordance with the manufacturer's recommendations and is traceable to recognized national standards.

4.2. MEASUREMENT UNCERTAINTY

Where relevant, the following measurement uncertainty levels have been estimated for tests performed on the apparatus:

Test Item	Uncertainty
Conduction emission	3.62 dB
Radiated Emission (Included Fundamental Emission) (9 kHz ~ 30 MHz)	2.2 dB
Radiated Emission (Included Fundamental Emission) (30 MHz ~ 1 GHz)	4.00 dB
Radiated Emission (Included Fundamental Emission) (1 GHz to 26 GHz)	5.78 dB (1 GHz ~ 18 GHz)
	5.23 dB (18 GHz ~ 26 GHz)
Note: This uncertainty represents an expanded uncertainty expressed at approximately the 95 % confidence level using a coverage factor of k=2.	



5. EQUIPMENT UNDER TEST

5.1. DESCRIPTION OF EUT

Equipment	Outdoor contact sensor	
Model Name	5F49E9	
Data Rates	908.4 MHz	
	908.42 MHz	
	916.0 MHz	
Transmit Channel Tested:	Channel ID	Channel Frequency(MHz)
	1	908.40
	2	908.42
	3	916.00
Battery	1.5 Vdc X 2	

5.2. MAXIMUM EMISSIONS FIELD STRENGTH

Operation Frequency (MHz)	Number of Transmit Chains (NTX)	Channel Number	Max. Emissions Field Strength (dB μ V/m)
908.4-916	1	[1~3]	93.62



5.3. THE WORSE CASE POWER SETTING PARAMETER

The Worse Case Power Setting Parameter under 908.4~916MHz				
Test Software		UartAssis		
Modulation Type	Transmit Antenna Number	Test Channel		
		916MHz	908.42MHz	908.4MHz
Z-wave	1	20(raw)	20(raw)	20(raw)

Note:

1. raw is the test software setting description provide by customer.
2. All tests executed under maximum input levels.

5.4. TEST ENVIRONMENT

Environment Parameter	Selected Values During Tests	
Relative Humidity	55 ~ 65%	
Atmospheric Pressure:	1025Pa	
Temperature	TN	23 ~ 28°C
Voltage :	VL	N/A
	VN	DC 3V
	VH	N/A

Note: VL= Lower Extreme Test Voltage
 VN= Nominal Voltage
 VH= Upper Extreme Test Voltage
 TN= Normal Temperature

5.5. TEST CHANNEL CONFIGURATION

Test Mode	Test Channel Number	Test Channel
Z-wave	CH 1, CH 2, CH 3/ Low, Middle, High	908.4MHz, 908.42MHz, 916MHz

**5.6. DESCRIPTION OF AVAILABLE ANTENNAS**

Ant.	Frequency (MHz)	Antenna Type	Antenna Gain (dBi)
1	908.4~916	Built-in	1.67

Test Mode	Transmit and Receive Mode	Description
Z-wave	<input checked="" type="checkbox"/> 1TX, 1RX	Antenna 1 can be used as transmitting/receiving antenna.

Note: 1. The value of the antenna gain was declared by customer.

5.7. DESCRIPTION OF TEST SETUP

SUPPORT EQUIPMENT

Item	Equipment	Brand Name	Model Name	Remarks
1	Laptop	Lenovo	TP00094A	/
2	UART	/	/	/

I/O PORT

Cable No	Port	Connector Type	Cable Type	Cable Length(m)	Remarks
1	USB	/	/	1.0	/

ACCESSORY

Item	Accessory	Brand Name	Model Name	Description
/	/	/	/	/

TEST SETUP

The EUT can work in an engineering mode though the laptop before the testing.

SETUP DIAGRAM FOR TESTS

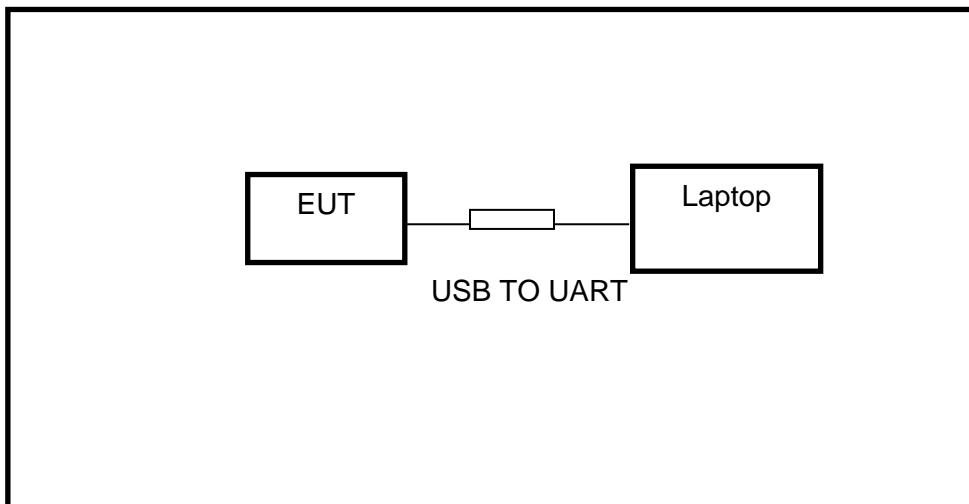

**5.8. MEASURING INSTRUMENT AND SOFTWARE USED**

Conducted Emissions					
Equipment	Manufacturer	Model No.	Serial No.	Last Cal.	Due Date
EMI Test Receiver	R&S	ESR3	101961	Nov. 12, 2020	Nov. 11, 2021
Two-Line V-Network	R&S	ENV216	101983	Nov. 12, 2020	Nov. 11, 2021
Artificial Mains Networks	Schwarzbeck	NSLK 8126	8126465	Nov. 12, 2020	Nov. 11, 2021
Software					
Description			Manufacturer	Name	Version
Test Software for Conducted Emissions			Farad	EZ-EMC	Ver. UL-3A1

Radiated Emissions					
Equipment	Manufacturer	Model No.	Serial No.	Last Cal.	Due Date
MXE EMI Receiver	KESIGHT	N9038A	MY56400036	Nov. 12, 2020	Nov. 11, 2021
Hybrid Log Periodic Antenna	TDK	HLP-3003C	130959	April 24, 2020	April 23, 2023
Preamplifier	HP	8447D	2944A09099	Nov. 12, 2020	Nov. 11, 2021
EMI Measurement Receiver	R&S	ESR26	101377	Nov. 12, 2020	Nov. 11, 2021
Horn Antenna	TDK	HRN-0118	130939	Sept. 17, 2018	Sept. 17, 2021
Preamplifier	TDK	PA-02-0118	TRS-305-00067	Nov. 20, 2020	Nov. 19, 2021
Horn Antenna	Schwarzbeck	BBHA9170	#697	July 20, 2021	July 19, 2024
Preamplifier	TDK	PA-02-2	TRS-307-00003	Nov. 12, 2020	Nov. 11, 2021
Preamplifier	TDK	PA-02-3	TRS-308-00002	Nov. 12, 2020	Nov. 11, 2021
Loop antenna	Schwarzbeck	1519B	00008	Jan.17, 2019	Jan.17,2022
Preamplifier	TDK	PA-02-001-3000	TRS-302-00050	Nov. 12, 2020	Nov. 11, 2021
Preamplifier	Mini-Circuits	ZX60-83LN-S+	SUP01201941	Nov. 20, 2020	Nov. 19, 2021
Software					
Description			Manufacturer	Name	Version
Test Software for Radiated Emissions			Farad	EZ-EMC	Ver. UL-3A1



Other instruments					
Equipment	Manufacturer	Model No.	Serial No.	Last Cal.	Next Cal.
Spectrum Analyzer	Keysight	N9030A	MY55410512	Nov. 20, 2020	Nov. 19, 2021
Dual Channel Power Meter	Keysight	N1912A	MY55416024	Nov. 20, 2020	Nov. 19, 2021
Power Sensor	Keysight	USB Wideband Power Sensor	MY5100022	Nov. 20, 2020	Nov. 19, 2021



6. SUMMARY OF TEST RESULTS

Summary of Test Results			
Clause	Test Items	FCC/IC Rules	Test Results
1	20dB Bandwidth	FCC Part 15.215(c)	Pass
2	99%dB Bandwidth	RSS-Gen Clause 6.7	Pass
3	TX Spurious Emission	FCC 15.249 (a)(d)(e) FCC 15.209 FCC 15.205 RSS-GEN Clause 8.9 RSS-GEN Clause 8.10	Pass
4	Antenna Requirement	FCC Part 15.203 RSS-GEN Clause 6.8	Pass

7. ANTENNA PORT TEST RESULTS

7.1. ON TIME AND DUTY CYCLE

LIMITS

None; for reporting purposes only

TEST SETUP

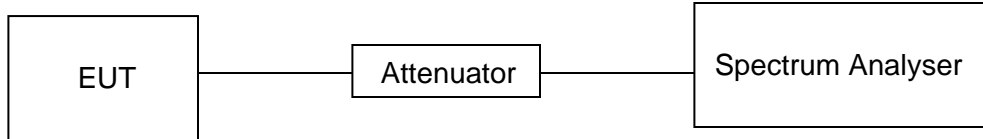

RESULTS

Test Channel	On Time (msec)	Period (msec)	Duty Cycle x (Linear)	Duty Cycle (%)	Duty Cycle Correction Factor (db)	minimum VBW 1/T (KHz)
MID	1	1	1	100%	0	0.01

Note: Duty Cycle Correction Factor=10log(1/x).

Where: x is Duty Cycle (Linear)

Where: T is On Time (transmit duration)

All test modes have been tested and the results are the same, so only one mode test data record in this report.

ON TIME AND DUTY CYCLE MID

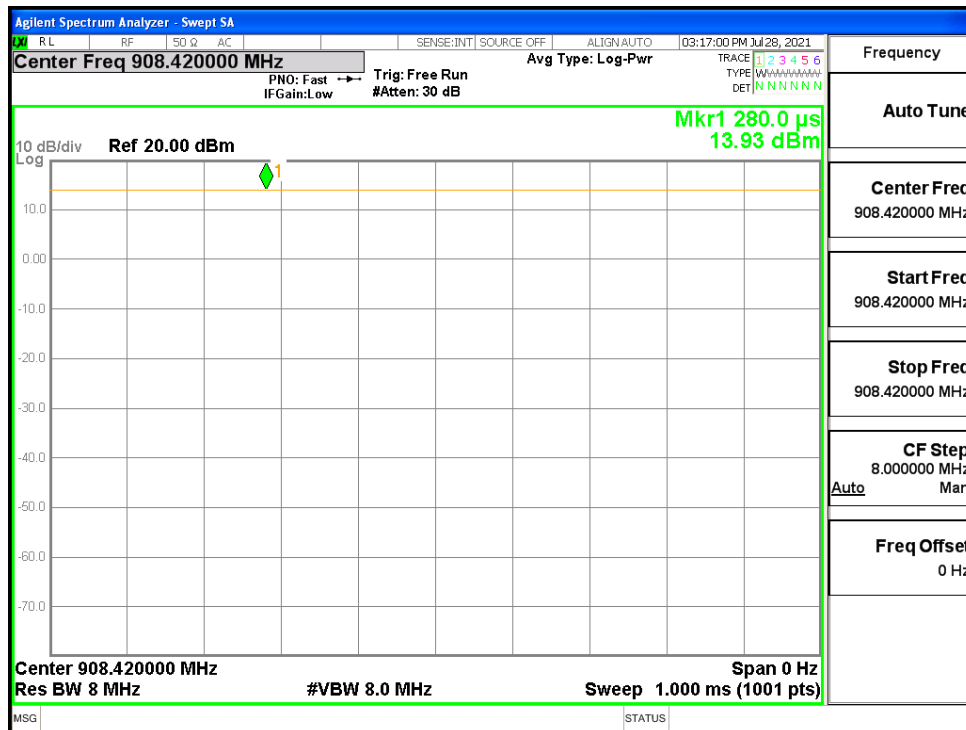

7.2. 20 dB AND 99% BANDWIDTH

LIMITS

FCC Part15 (15.249) , Subpart C			
Section	Test Item	Limit	Frequency Range (MHz)
FCC 15.215(c)	Bandwidth	for reporting purposes only	902-928 MHz
RSS-Gen Clause 6.7	99% Bandwidth	N/A	902-928MHz

TEST PROCEDURE

Connect the UUT to the spectrum analyser and use the following settings:

Center Frequency	The center frequency of the channel under test
Detector	Peak
RBW	1% to 5% of the occupied bandwidth
VBW	$\geq 3 \times \text{RBW}$
Trace	Max hold
Sweep	Auto couple

Allow the trace to stabilize and measure the maximum width of the emission that is constrained by the frequencies associated with the two outermost amplitude points (upper and lower frequencies) that are attenuated by 20 dB relative to the maximum level measured in the fundamental emission.

TEST SETUP

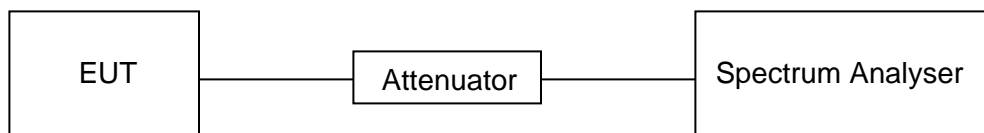



RESULTS

Channel	20dB bandwidth (KHz)	99% bandwidth (KHz)	Result
Low	71.10	78.745	Pass
Middle	89.14	90.989	Pass
High	108.6	108.11	Pass

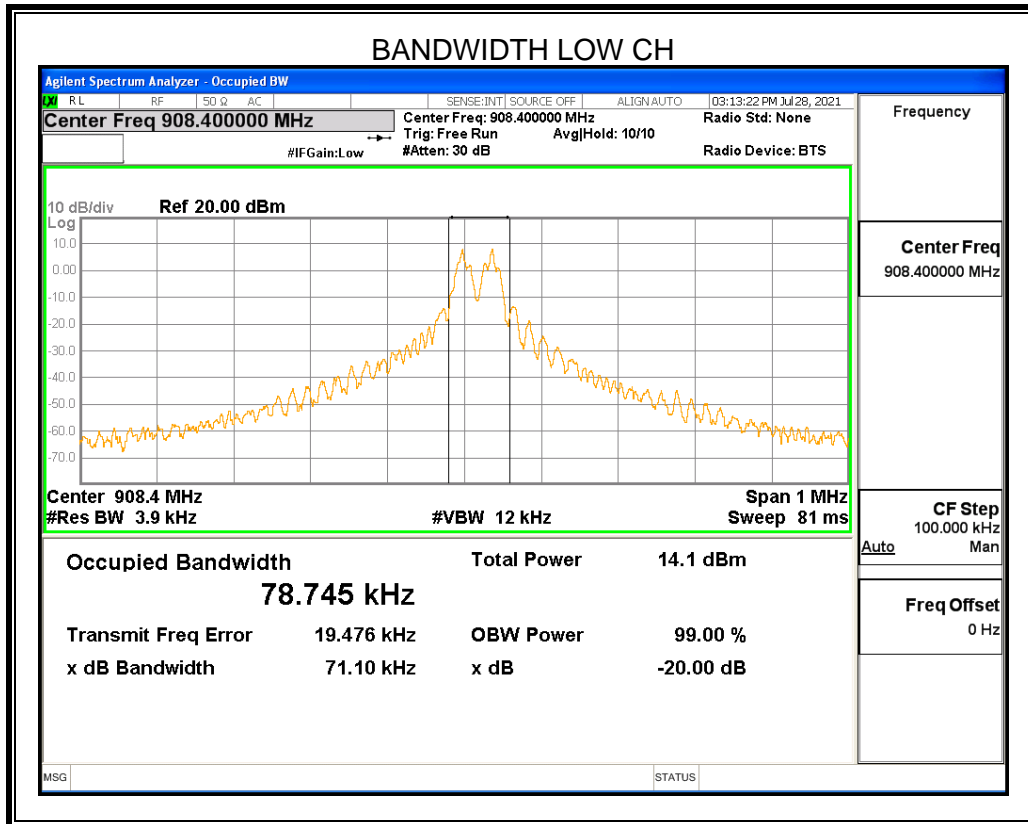

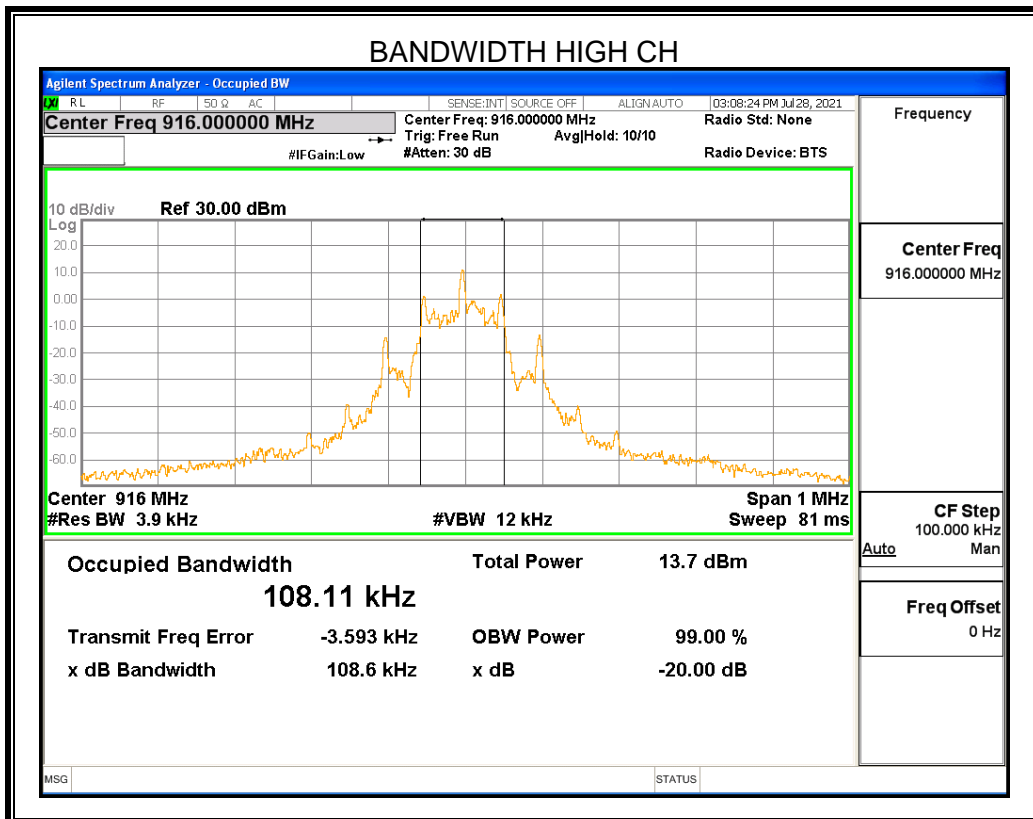
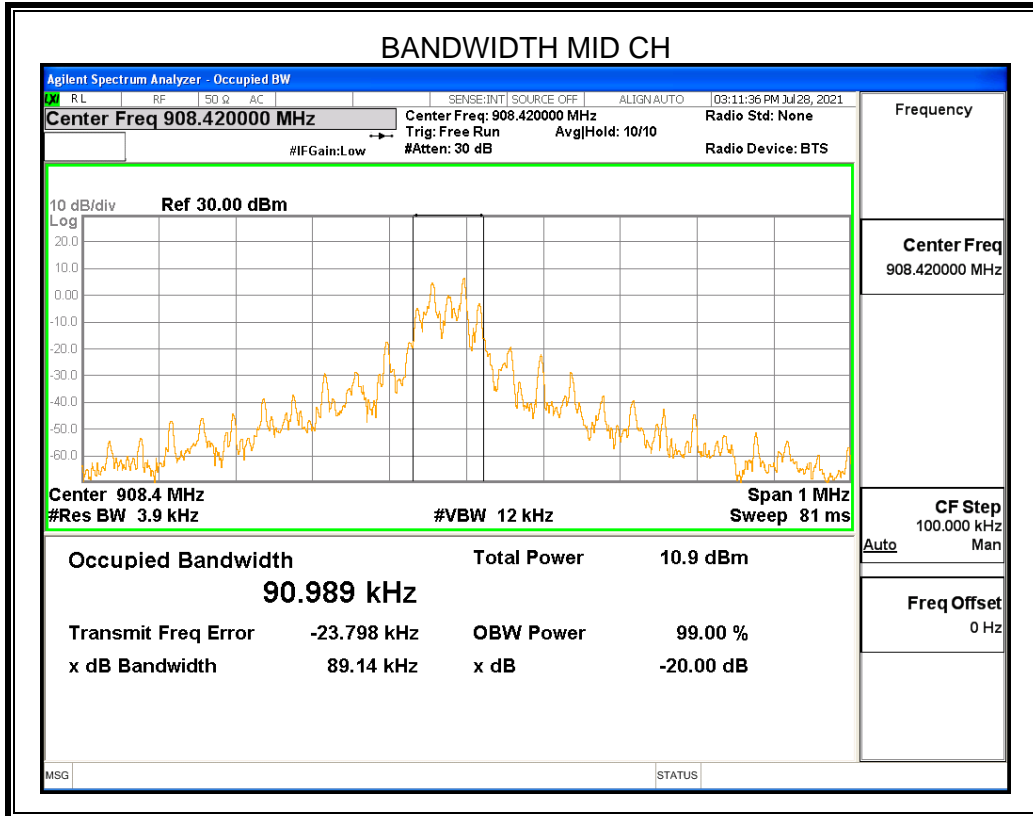



8. RADIATED TEST RESULTS

8.1. LIMITS AND PROCEDURE

LIMITS

Please refer to FCC §15.205 and §15.209

Please refer to FCC §15.249 (a)(d)(e)

RSS-210 Issue 10 Clause Annex B B.10

Please refer to ISED RSS-GEN Clause 8.9 and Clause 8.10

The field strength of emissions from intentional radiators operated within these frequency bands			
Frequency (MHz)	Field strength of Fundamental	Field strength of Harmonics	Distance (m)
902 - 928	50 mV/m (94 dBuV/m)	500 uV/m (54d BuV/m)	3
2400 – 2483.5	50 mV/m (94 dBuV/m)	500 uV/m (54d BuV/m)	3
5725 – 5875	50 mV/m (94 dBuV/m)	500 uV/m (54 dBuV/m)	3

Radiation Disturbance Test Limit for FCC (Class B)(9 kHz-1 GHz)

Frequency (MHz)	Field Strength (microvolts/meter)	Measurement Distance (meters)
0.009~0.490	2400/F (kHz)	300
0.490~1.705	24000/F (kHz)	30
1.705~30.0	30	30
30~88	100	3
88~216	150	3
216~960	200	3
960~1000	500	3

Note:

(1) At frequencies at or above 30 MHz, measurements may be performed at a distance other than what is specified provided: measurements are not made in the near field except where it can be shown that near field measurements are appropriate due to the characteristics of the device; and it can be demonstrated that the signal levels needed to be measured at the distance employed can be detected by the measurement equipment. Measurements shall not be performed at a distance greater than 30 meters unless it can be further demonstrated that measurements at a distance of 30 meters or less are impractical. When performing measurements at a distance other than that specified, the results shall be extrapolated to the specified distance using an extrapolation factor of 20 dB/decade (inverse linear-distance for field strength measurements; inverse-linear-distance-squared for power density measurements).



(2) At frequencies below 30 MHz, measurements may be performed at a distance closer than that specified in the regulations; however, an attempt should be made to avoid making measurements in the near field. Pending the development of an appropriate measurement procedure for measurements performed below 30 MHz, when performing measurements at a closer distance than specified, the results shall be extrapolated to the specified distance by either making measurements at a minimum of two distances on at least one radial to determine the proper extrapolation factor or by using the square of an inverse linear distance extrapolation factor (40 dB/decade). This paragraph (f) shall not apply to Access BPL devices operating below 30 MHz.

Radiation Disturbance Test Limit for FCC (Above 1GHz)

Frequency (MHz)	dB (uV/m) (at 3 meters)	
	Peak	Average
Above 1000	74	54

About Restricted bands of operation please refer to RSS-Gen section 8.10 and FCC §15.205 (a)

TEST SETUP AND PROCEDURE

Below 30 MHz

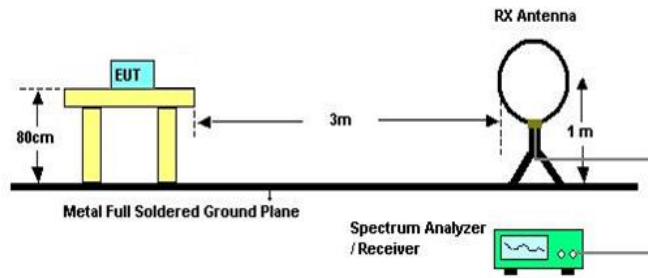

The setting of the spectrum analyser

RBW	200 Hz (From 9 kHz to 0.15 MHz)/ 9 kHz (From 0.15 MHz to 30 MHz)
VBW	200 Hz (From 9 kHz to 0.15 MHz)/ 9 kHz (From 0.15 MHz to 30 MHz)
Sweep	Auto
Trace	Max hold

1. The testing follows the guidelines in ANSI C63.10-2013 clause 6.4.
2. The EUT was arranged to its worst case and then turntable (from 0 degree to 360 degrees) to find the maximum reading. A pre-amp and a high pass filter are used for the test in order to get better signal level. Both Horizontal, Face-on and Face-off polarizations of the antenna are set to make the measurement.
3. The EUT was placed on a turntable with 80 cm above ground.
4. The EUT was set 3 meters from the interference receiving antenna, which was mounted on the top of a 1 m height antenna tower.
5. The radiated emission limits are based on measurements employing a CISPR quasi-peak detector except for the frequency bands 9-90 kHz, 110-490 kHz and above 1000 MHz. Radiated emission limits in these three bands are based on measurements employing an average detector.
6. For measurement below 1 GHz, the initial step in collecting conducted emission data is a spectrum analyzer peak detector mode pre-scanning the measurement frequency range. Significant peaks are then marked and then Quasi Peak and average detector mode re-measured. If the emission level of the EUT measured by the peak detector is 3 dB lower than the applicable limit, the peak emission level will be reported. Otherwise, the emission measurement will be repeated using the quasi-peak and average detector and reported.
7. Although these tests were performed other than open field site, adequate comparison measurements were confirmed against 30m open field site. Therefore sufficient tests were made to demonstrate that the alternative site produces results that correlate with the ones of tests made in an open field site based on KDB 414788.
8. The limits in CFR 47, Part 15, Subpart C, paragraph 15.209 (a), are identical to those in RSS-GEN Section 8.9, Table 6, since the measurements are performed in terms of magnetic field strength and converted to electric field strength levels (as reported in the table) using the free space impedance of 377Ω. For example, the measurement frequency X KHz resulted in a level of Y dBuV/m, which is equivalent to $Y-51.5 = Z$ dBuA/m, which has the same margin, W dB, to the corresponding RSS-GEN Table 6 limit as it has to be 15.209(a) limit.

Below 1G

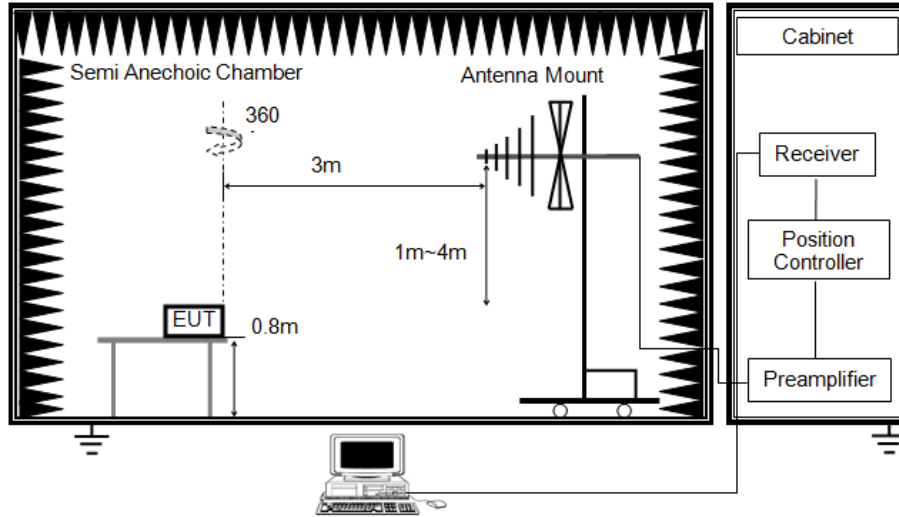

The setting of the spectrum analyser

RBW	120K
VBW	300K
Sweep	Auto
Detector	Peak/QP
Trace	Max hold

1. The testing follows the guidelines in ANSI C63.10-2013 clause 6.5.
2. The EUT was arranged to its worst case and then tune the antenna tower (from 1 m to 4 m) and turntable (from 0 degree to 360 degrees) to find the maximum reading. A pre-amp and a high pass filter are used for the test in order to get better signal level. Both horizontal and vertical polarizations of the antenna are set to make the measurement.
3. The EUT was placed on a turntable with 0.8 meter above ground.
4. The EUT was set 3 meters from the interference receiving antenna, which was mounted on the top of a variable height antenna tower.
5. Measurement = Reading Level + Correct Factor
6. For measurement below 1GHz, the initial step in collecting conducted emission data is a spectrum analyzer peak detector mode pre-scanning the measurement frequency range. Significant peaks are then marked and then Quasi Peak detector mode re-measured. If the emission level of the EUT measured by the peak detector is 3 dB lower than the applicable limit, the peak emission level will be reported. Otherwise, the emission measurement will be repeated using the quasi-peak detector and reported.
7. For the actual test configuration, please refer to the related Item in this test report (Photographs of the Test Configuration)

ABOVE 1G

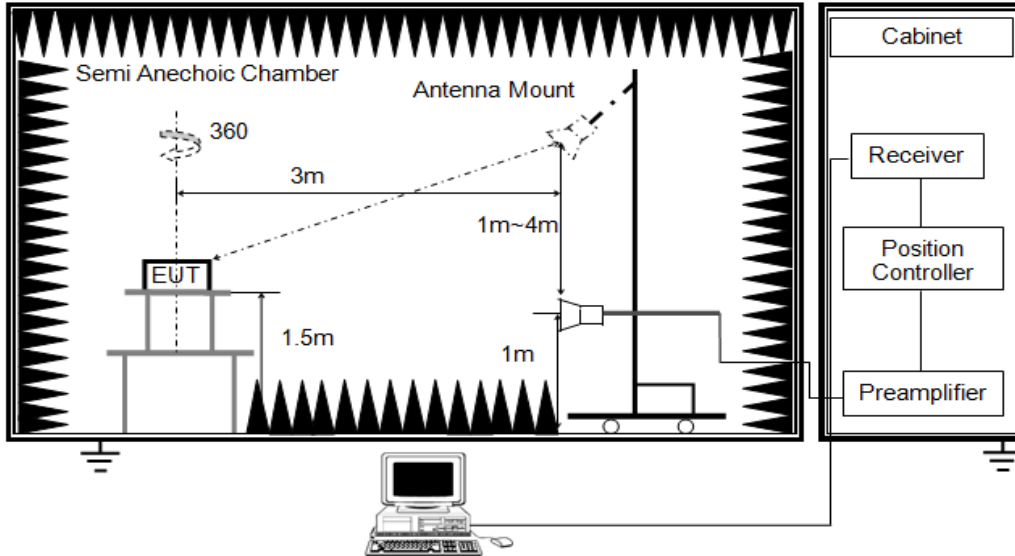

The setting of the spectrum analyser

RBW	1M MHz
VBW	PEAK: 3M AVG: See Note 6
Sweep	Auto
Detector	Peak
Trace	Max hold

1. The testing follows the guidelines in ANSI C63.10-2013 clause 6.6.
2. The EUT was arranged to its worst case and then tune the antenna tower (from 1 m to 4 m) and turntable (from 0 degree to 360 degrees) to find the maximum reading. A pre-amp and a high pass filter are used for the test in order to get better signal level. Both horizontal and vertical polarizations of the antenna are set to make the measurement.
3. The EUT was placed on a turntable with 1.5m above ground.
4. The EUT was set 3 meters from the interference receiving antenna, which was mounted on the top of a variable height antenna tower.
5. For measurement above 1GHz, the emission measurement will be measured by the peak detector. This peak level, once corrected, must comply with the limit specified in Section 15.209.
6. For average power measurement, set the detector to AVG, while maintaining all of the other instrument settings, if the duty cycle of the EUT is less than 98%, the Duty Cycle Correction Factor shall be added to the measured emission levels. For the Duty Cycle and Correction Factor please refer to clause 7.1.ON TIME AND DUTY CYCLE.
7. For the actual test configuration, please refer to the related item in this test report (Photographs of the Test Configuration)

X axis, Y axis, Z axis positions:

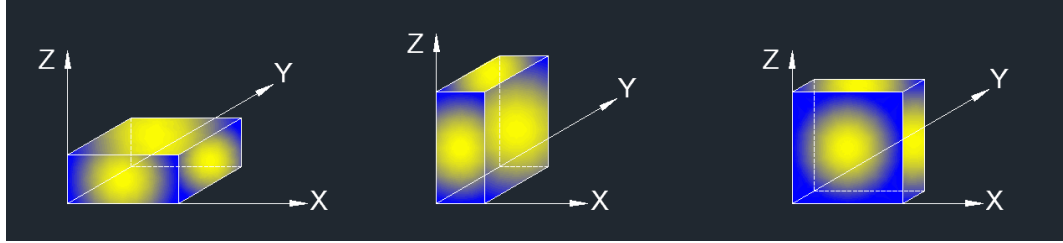

Note 1: For all radiated test, EUT in each of three orthogonal axis emissions had been tested, but only the worst case (X axis) data recorded in the report.



8.2. FIELD STRENGTH OF INTENTIONAL EMISSIONS

FIELD STRENGTH OF INTENTIONAL EMISSIONS (LOW CHANNEL, HORIZONTAL)

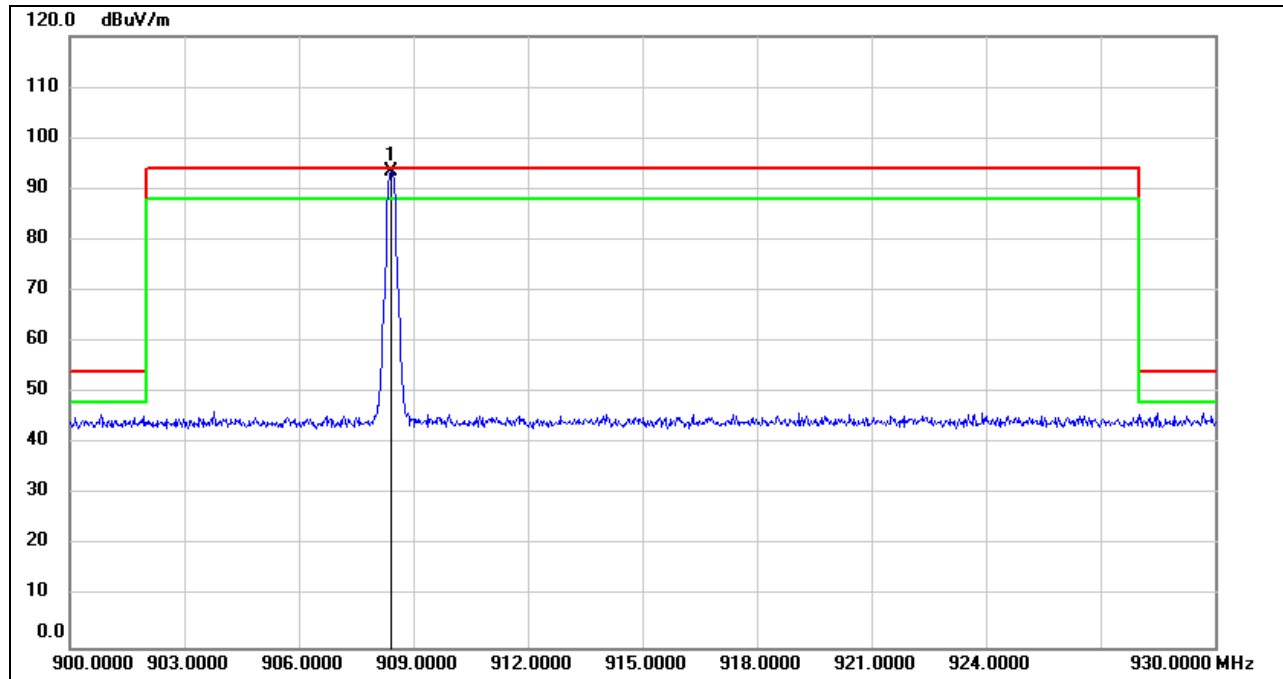

No.	Frequency (MHz)	Reading (dBuV)	Correct (dB/m)	Result (dBuV/m)	Limit (dBuV/m)	Margin (dB)	Remark
1	908.4000	98.51	-5.01	93.50	94.00	-0.50	peak

Note: 1. Measurement = Reading Level + Correct Factor.
 2. QP detector.



FIELD STRENGTH OF INTENTIONAL EMISSIONS (LOW CHANNEL, VERTICAL)

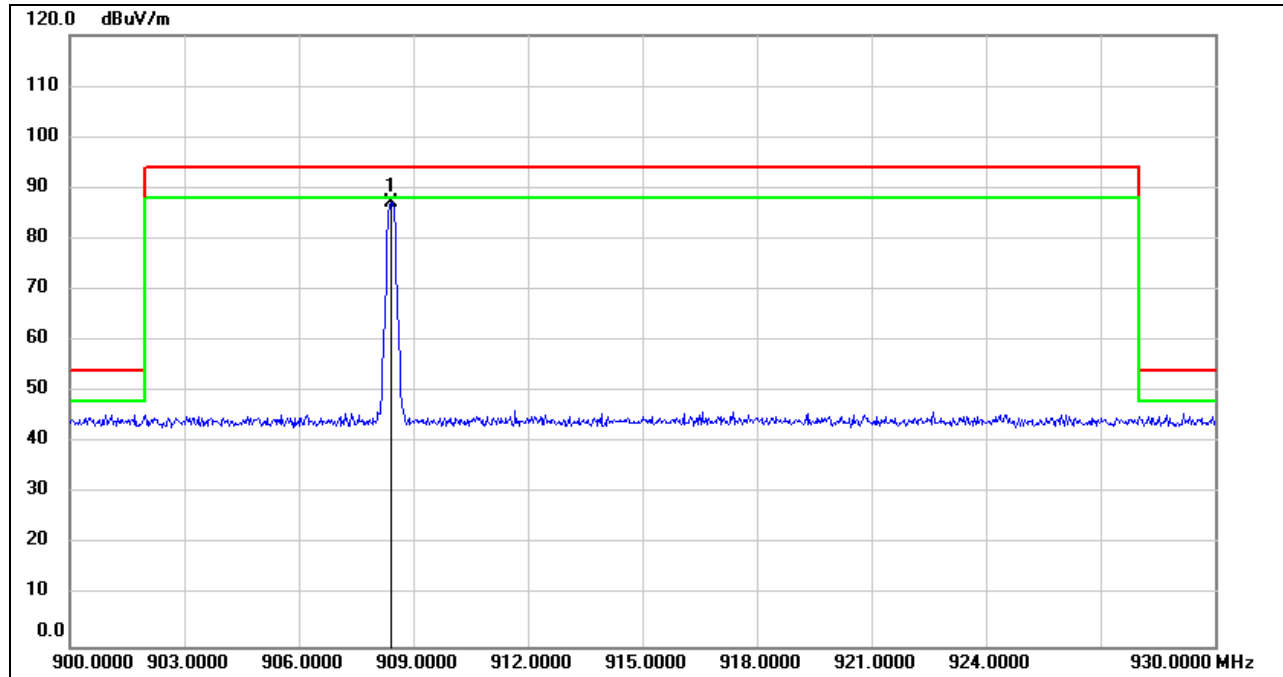

No.	Frequency (MHz)	Reading (dBuV)	Correct (dB/m)	Result (dBuV/m)	Limit (dBuV/m)	Margin (dB)	Remark
1	908.4000	92.30	-5.01	87.29	94.00	-6.71	peak

Note: 1. Measurement = Reading Level + Correct Factor.
 2. QP detector.



FIELD STRENGTH OF INTENTIONAL EMISSIONS (MIDDLE CHANNEL, HORIZONTAL)

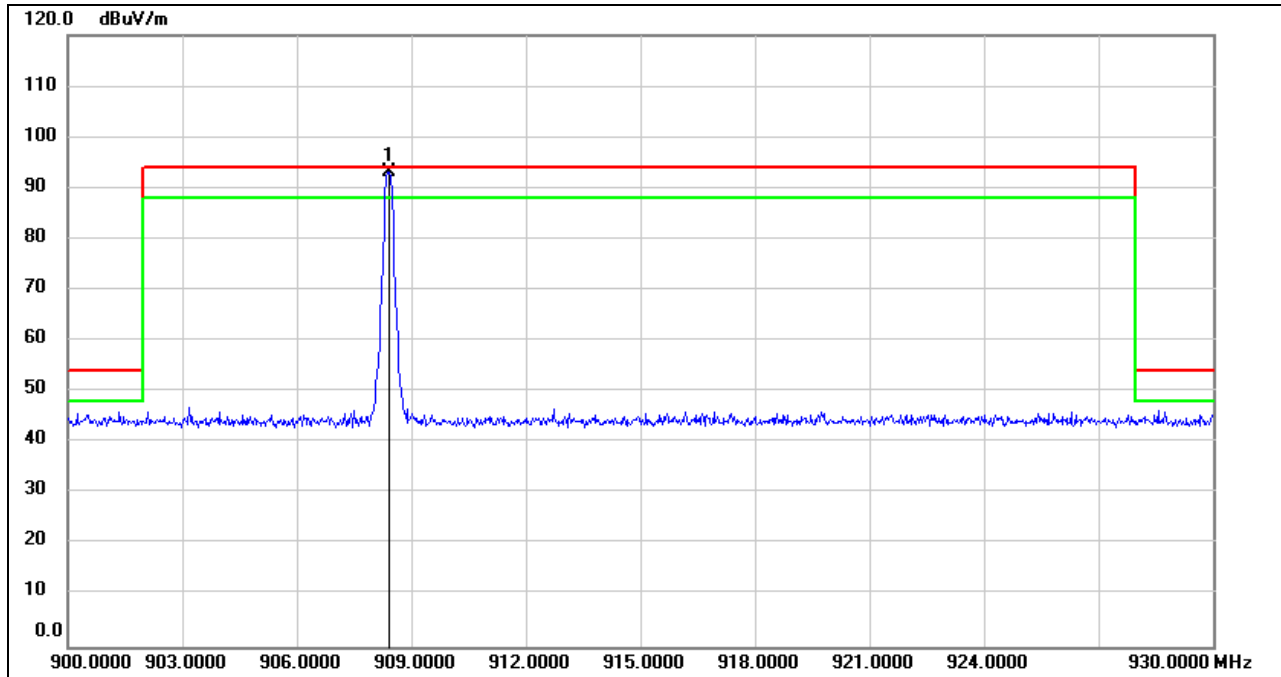

No.	Frequency (MHz)	Reading (dBuV)	Correct (dB/m)	Result (dBuV/m)	Limit (dBuV/m)	Margin (dB)	Remark
1	908.4300	98.02	-5.01	93.01	94.00	-0.99	peak

Note: 1. Measurement = Reading Level + Correct Factor.
2. QP detector.



FIELD STRENGTH OF INTENTIONAL EMISSIONS (MIDDLE CHANNEL, VERTICAL)

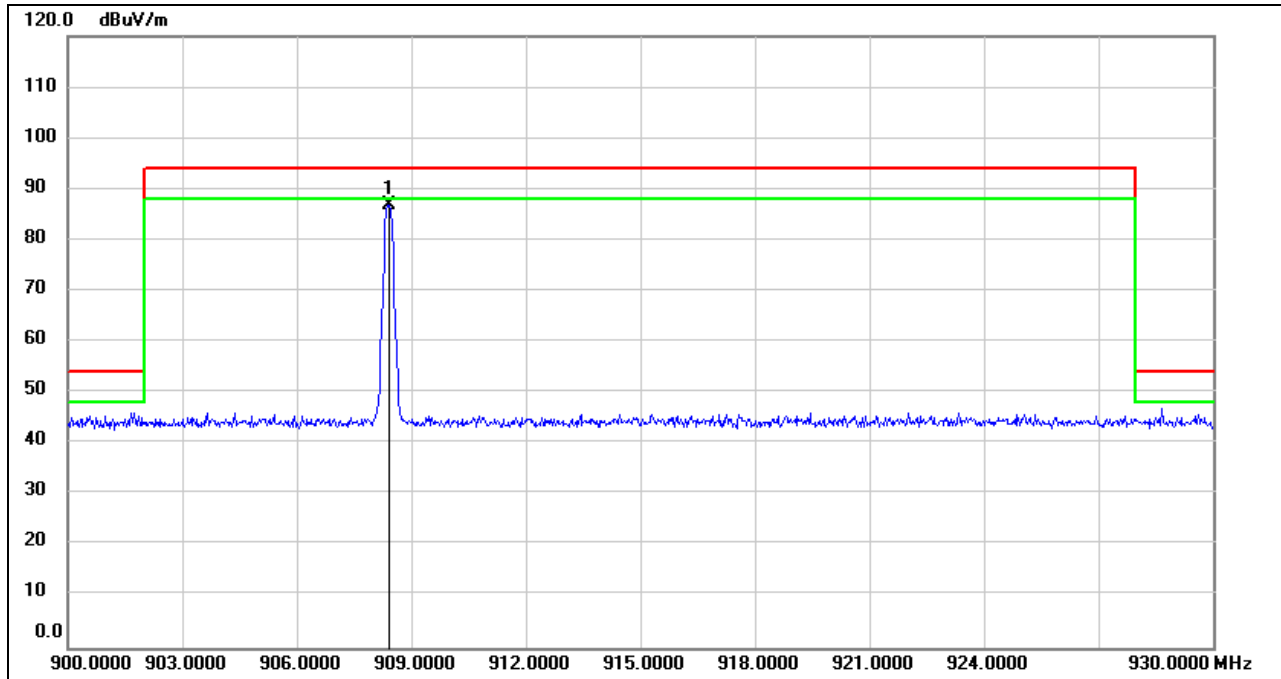

No.	Frequency (MHz)	Reading (dBuV)	Correct (dB/m)	Result (dBuV/m)	Limit (dBuV/m)	Margin (dB)	Remark
1	908.4300	91.99	-5.01	86.98	94.00	-7.02	peak

Note: 1. Measurement = Reading Level + Correct Factor.
2. QP detector.



FIELD STRENGTH OF INTENTIONAL EMISSIONS (HIGH CHANNEL, HORIZONTAL)

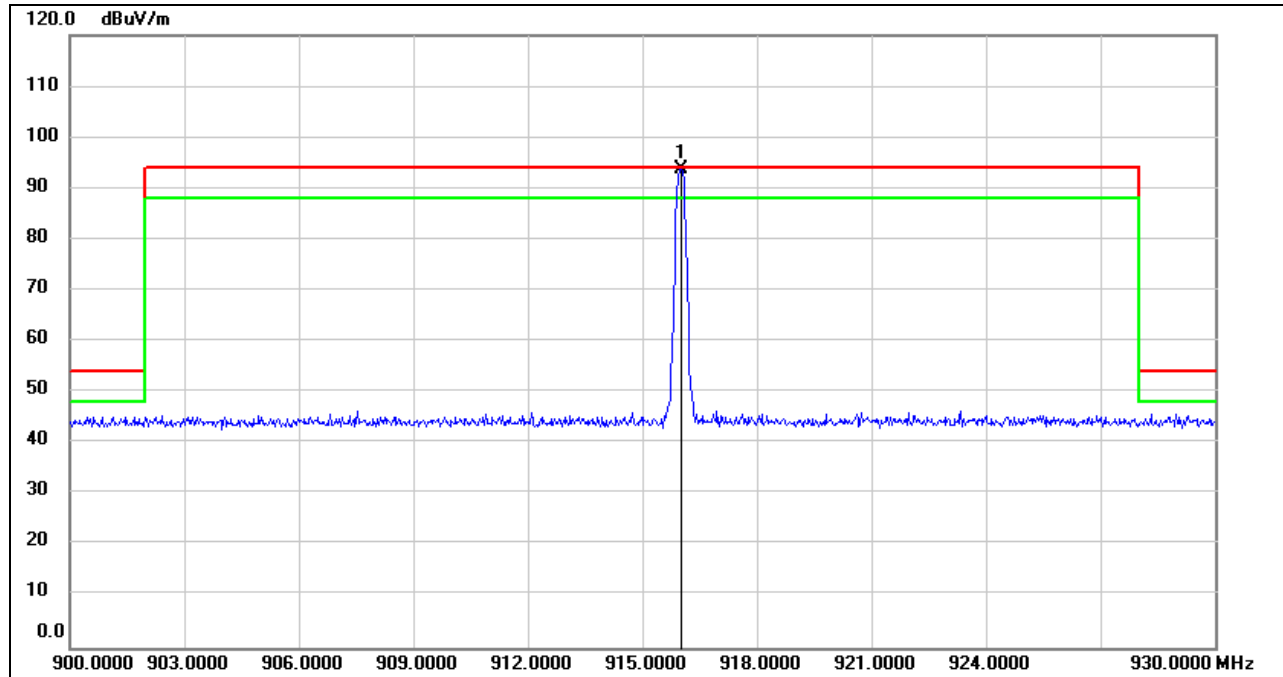

No.	Frequency (MHz)	Reading (dBuV)	Correct (dB/m)	Result (dBuV/m)	Limit (dBuV/m)	Margin (dB)	Remark
1	916.0200	98.46	-4.84	93.62	94.00	-0.38	peak

Note: 1. Measurement = Reading Level + Correct Factor.
 2. QP detector.



FIELD STRENGTH OF INTENTIONAL EMISSIONS (HIGH CHANNEL, VERTICAL)

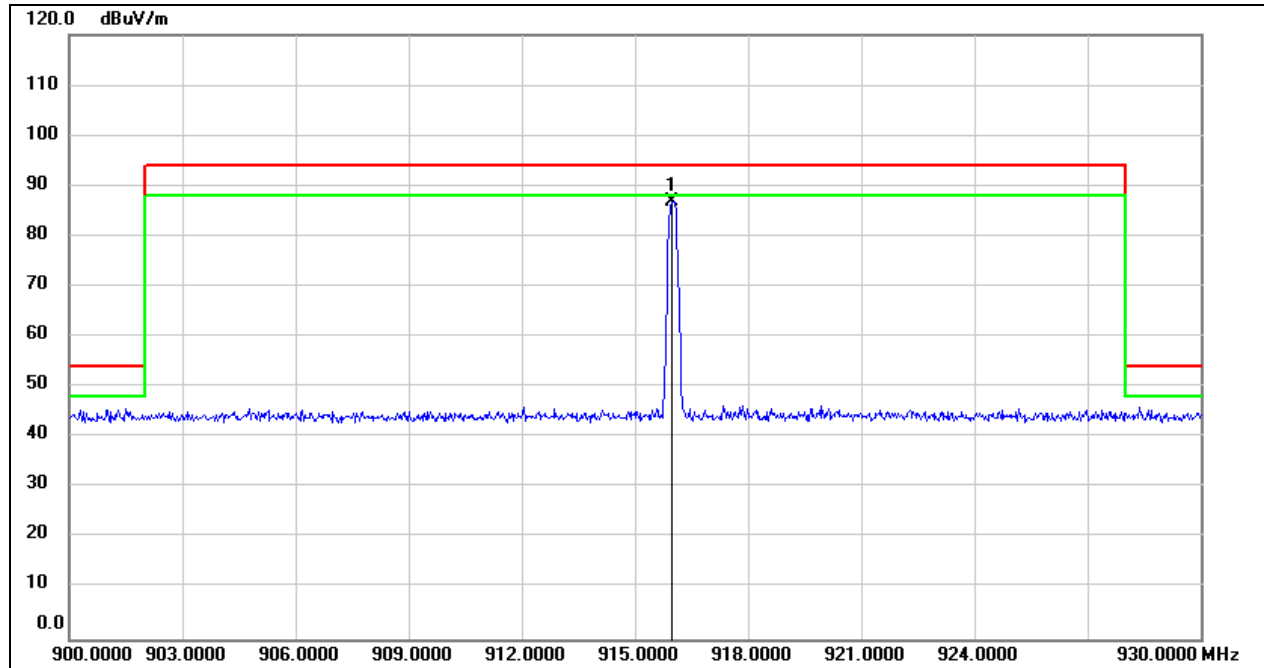

No.	Frequency (MHz)	Reading (dBuV)	Correct (dB/m)	Result (dBuV/m)	Limit (dBuV/m)	Margin (dB)	Remark
1	915.9600	91.73	-4.84	86.89	94.00	-7.11	peak

Note: 1. Measurement = Reading Level + Correct Factor.
 2. QP detector.

8.3. SPURIOUS EMISSIONS BELOW 30M

SPURIOUS EMISSIONS

(LOW CHANNEL, LOOP ANTENNA FACE ON TO THE EUT, WORST-CASE CONFIGURATION)

9kHz~ 150kHz

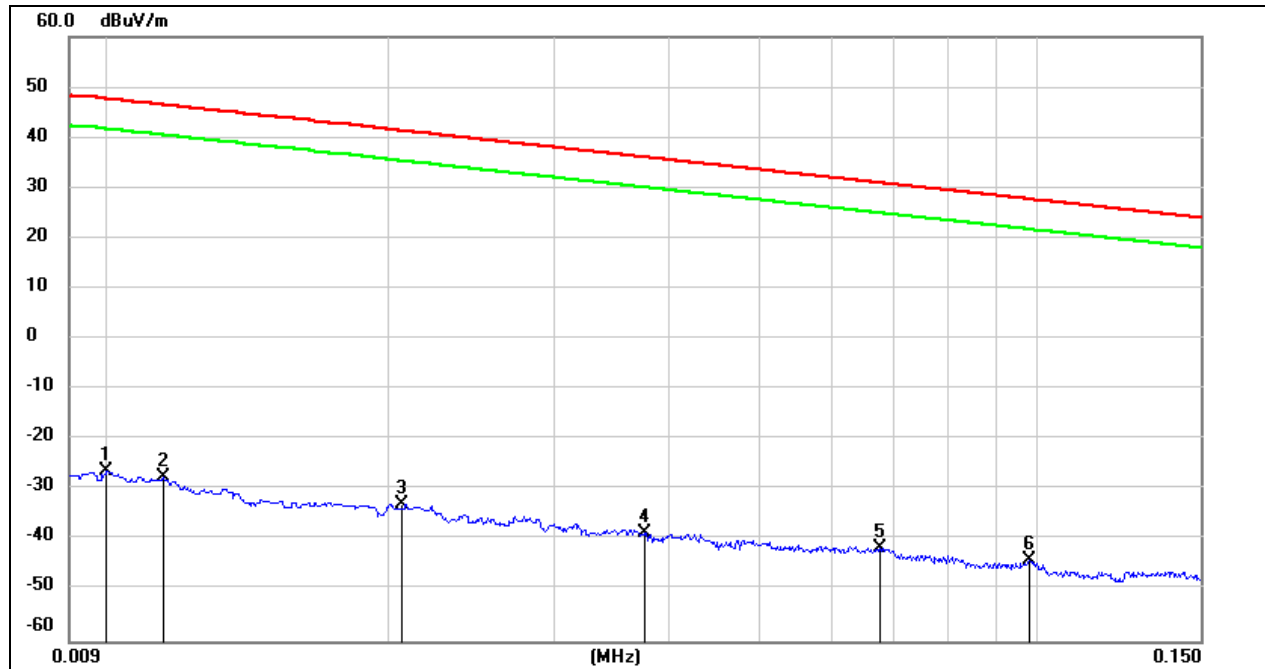

No.	Frequency	Reading	Correct	FCC Result	FCC Limit	ISED Result	ISED Limit	Margin	Remark
	(MHz)	(dBuV)	(dB/m)	(dBuV/m)	(dBuV/m)	(dBuA/m)	(dBuA/m)	(dB)	
1	0.0100	75.22	-101.40	-26.18	47.6	-77.68	-3.90	-73.78	peak
2	0.0114	73.88	-101.40	-27.52	46.46	-79.02	-5.04	-73.98	peak
3	0.0206	68.42	-101.35	-32.93	41.32	-84.43	-10.18	-74.25	peak
4	0.0376	62.75	-101.42	-38.67	36.1	-90.17	-15.40	-74.77	peak
5	0.0675	60.14	-101.56	-41.42	31.02	-92.92	-20.48	-72.44	peak
6	0.0981	57.77	-101.78	-44.01	27.77	-95.51	-23.73	-71.78	peak

Note: 1. Measurement = Reading Level + Correct Factor (dBuA/m= dBuV/m- 20Log₁₀[120π] = dBuV/m- 51.5).

2. If Peak Result complies with AV and QP limit, AV and QP Result are deemed to comply with AV limit.

3. All 3 polarizations (Horizontal, Face-on and Face-off) of the loop antenna had been tested, but only the worst data recorded in the report.



150kHz ~ 490kHz

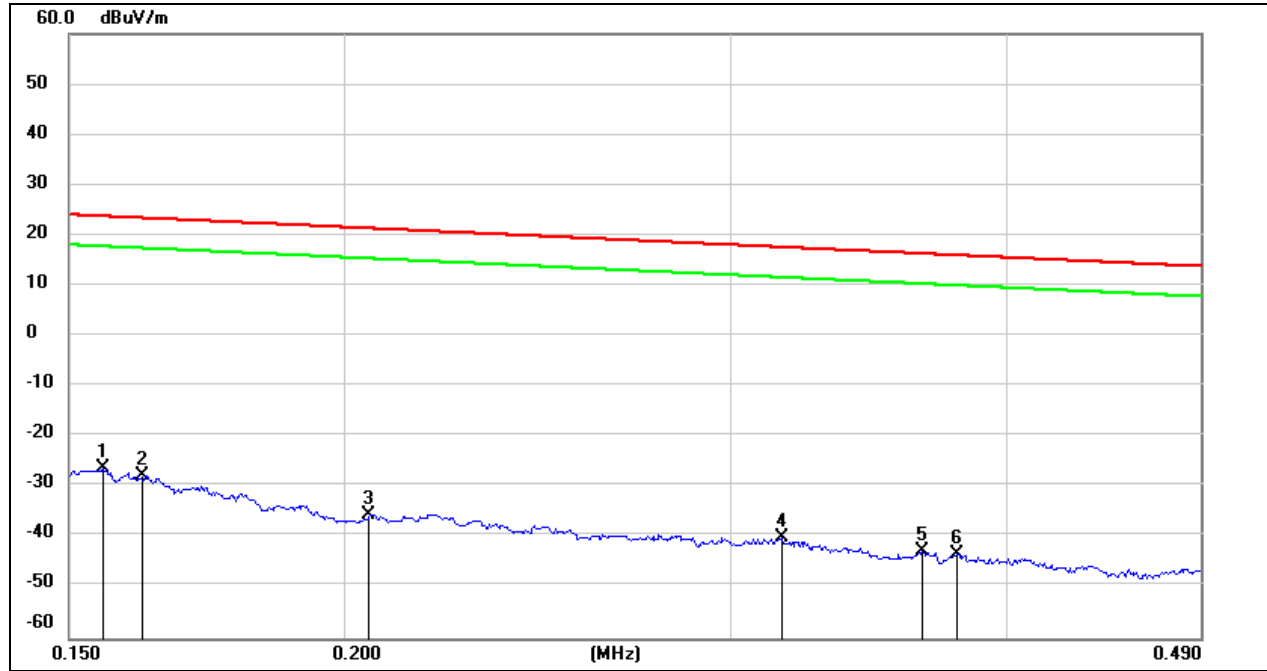

No.	Frequency (MHz)	Reading (dBuV)	Correct (dB/m)	FCC Result (dBuV/m)	FCC Limit (dBuV/m)	ISED Result (dBuA/m)	ISED Limit (dBuA/m)	Margin (dB)	Remark
1	0.1554	75.27	-101.65	-26.38	23.77	-77.88	-27.73	-50.15	peak
2	0.1621	73.92	-101.65	-27.73	23.41	-79.23	-28.09	-51.14	peak
3	0.2053	66.29	-101.73	-35.44	21.35	-86.94	-30.15	-56.79	peak
4	0.3163	61.70	-101.87	-40.17	17.6	-91.67	-33.90	-57.77	peak
5	0.3662	59.08	-101.93	-42.85	16.33	-94.35	-35.17	-59.18	peak
6	0.3800	58.52	-101.94	-43.42	16.01	-94.92	-35.49	-59.43	peak

Note: 1. Measurement = Reading Level + Correct Factor (dBuA/m= dBuV/m- 20Log10[120π] = dBuV/m- 51.5).

2. If Peak Result complies with AV and QP limit, AV and QP Result are deemed to comply with AV limit.

3. All 3 polarizations (Horizontal, Face-on and Face-off) of the loop antenna had been tested, but only the worst data recorded in the report.

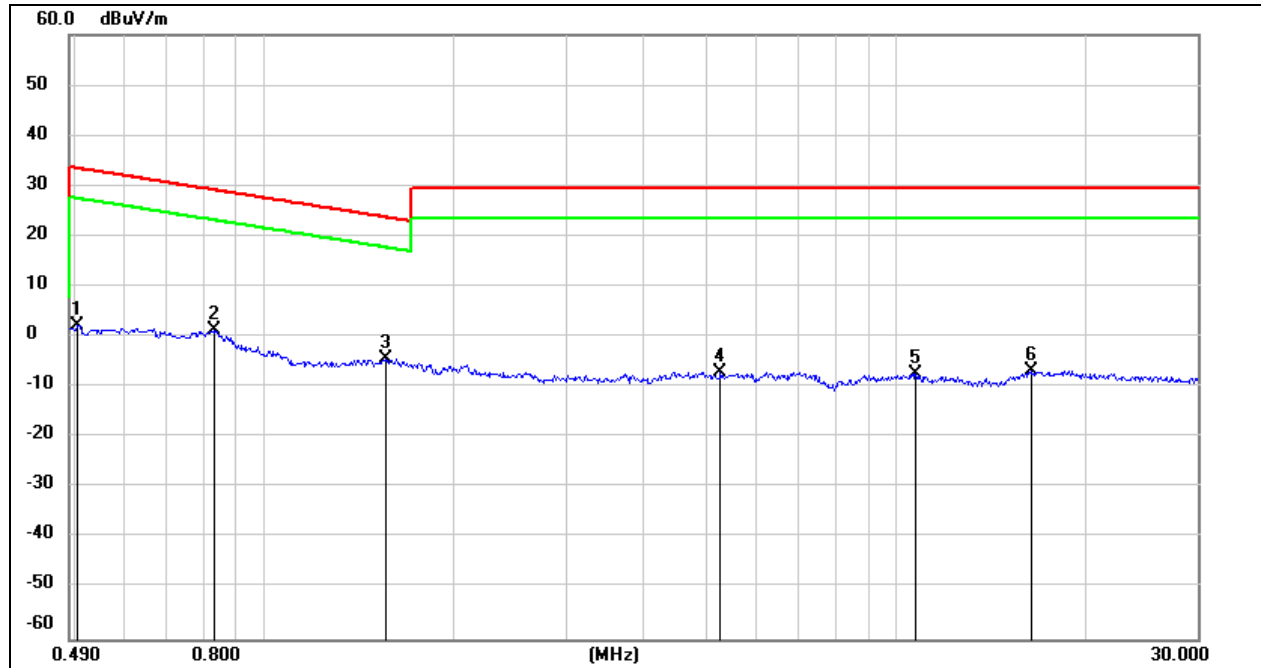
490kHz ~ 30MHz

No.	Frequency (MHz)	Reading (dBuV)	Correct (dB/m)	FCC Result (dBuV/m)	FCC Limit (dBuV/m)	ISED Result (dBuA/m)	ISED Limit (dBuA/m)	Margin (dB)	Remark
1	0.5039	64.44	-62.07	2.37	33.56	-49.13	-17.94	-31.19	peak
2	0.8296	63.44	-62.17	1.27	29.23	-50.23	-22.27	-27.96	peak
3	1.5564	57.68	-62.02	-4.34	23.76	-55.84	-27.74	-28.10	peak
4	5.2705	54.54	-61.45	-6.91	29.54	-58.41	-21.96	-36.45	peak
5	10.7299	53.48	-60.83	-7.35	29.54	-58.85	-21.96	-36.89	peak
6	16.3959	54.17	-60.96	-6.79	29.54	-58.29	-21.96	-36.33	peak

Note: 1. Measurement = Reading Level + Correct Factor (dBuA/m= dBuV/m- 20Log10[120π] = dBuV/m- 51.5).

2. If Peak Result complies with AV and QP limit, AV and QP Result are deemed to comply with AV limit.

3. All 3 polarizations (Horizontal, Face-on and Face-off) of the loop antenna had been tested, but only the worst data recorded in the report.

Note: All the modes and channels had been tested, but only the worst data recorded in the report.

8.4. SPURIOUS EMISSIONS BELOW 1 GHz

SPURIOUS EMISSIONS BELOW 1GHz (WORST-CASE MID CHANNEL, HORIZONTAL)

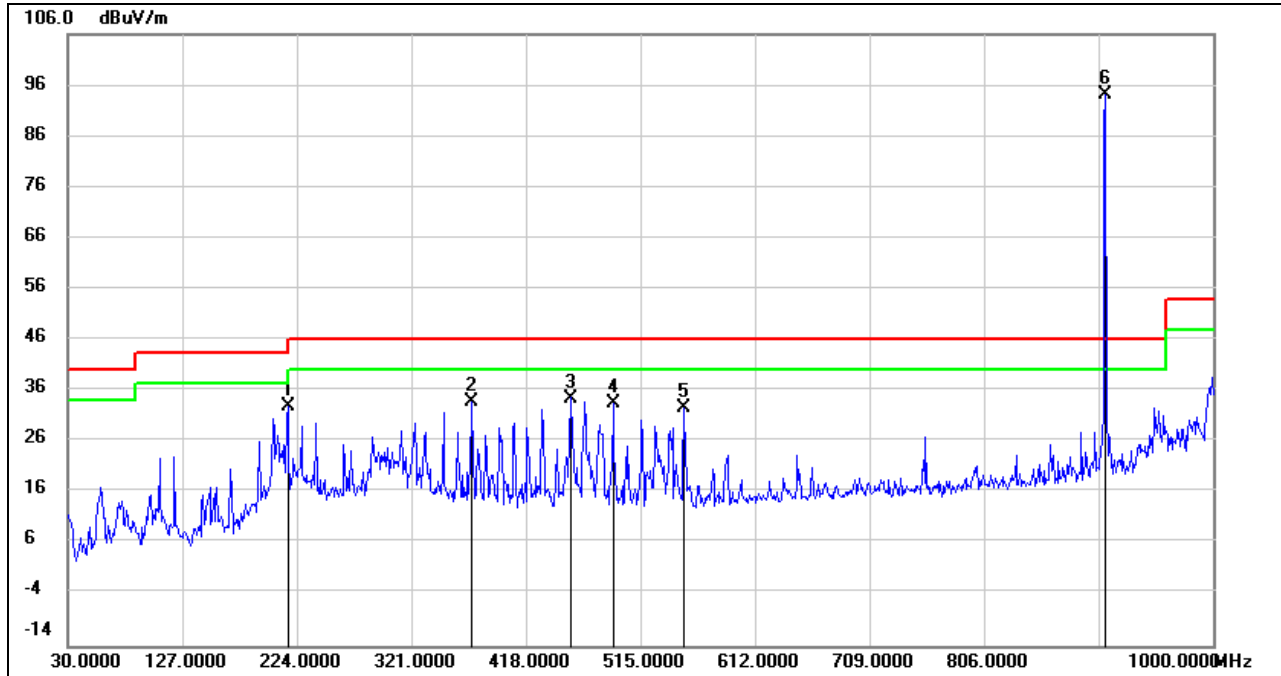

No.	Frequency (MHz)	Reading (dBuV)	Correct (dB/m)	Result (dBuV/m)	Limit (dBuV/m)	Margin (dB)	Remark
1	216.2400	50.81	-17.84	32.97	46.00	-13.03	peak
2	372.4100	47.63	-13.87	33.76	46.00	-12.24	peak
3	455.8300	46.87	-12.27	34.60	46.00	-11.40	peak
4	491.7200	45.08	-11.66	33.42	46.00	-12.58	peak
5	551.8600	43.13	-10.46	32.67	46.00	-13.33	peak
6	908.4200	99.19	-5.01	94.18	/	/	fundamental

- Note: 1. Result Level = Read Level + Antenna Factor + Cable loss.
 2. If Peak Result complies with QP limit, QP Result is deemed to comply with QP limit.
 3. Test setup: RBW: 120 kHz, VBW: 300 kHz, Sweep time: auto.
 4. About the Fundamental emission test result please refer to section 8.2.

SPURIOUS EMISSIONS BELOW 1GHz (WORST-CASE MID CHANNEL, VERTICAL)

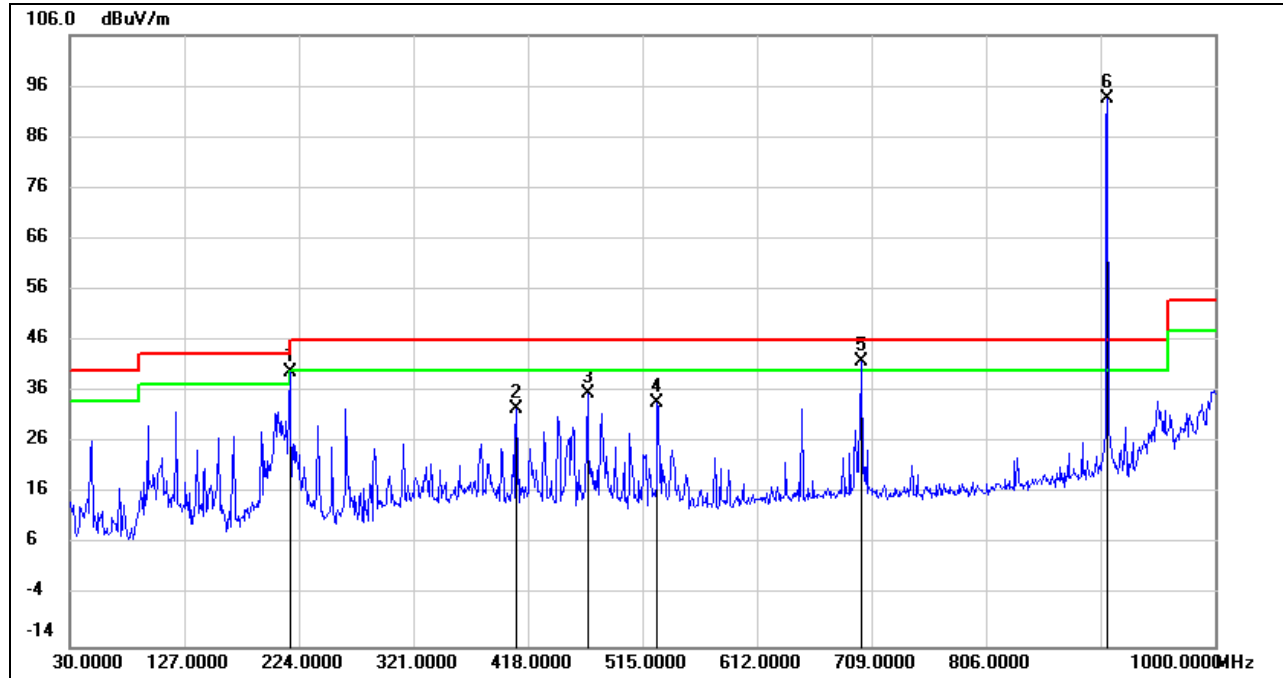

No.	Frequency (MHz)	Reading (dBuV)	Correct (dB/m)	Result (dBuV/m)	Limit (dBuV/m)	Margin (dB)	Remark
1	216.2400	57.73	-17.84	39.89	46.00	-6.11	peak
2	408.3000	45.86	-13.17	32.69	46.00	-13.31	peak
3	468.4400	47.73	-12.04	35.69	46.00	-10.31	peak
4	527.6100	44.84	-10.88	33.96	46.00	-12.04	peak
5	700.2700	50.13	-8.31	41.82	46.00	-4.18	peak
6	908.4200	98.58	-5.01	93.57	/	/	fundamental

- Note: 1. Result Level = Read Level + Antenna Factor + Cable loss.
 2. If Peak Result complies with QP limit, QP Result is deemed to comply with QP limit.
 3. Test setup: RBW: 120 kHz, VBW: 300 kHz, Sweep time: auto
 4. About the Fundamental emission test result please refer to section 8.2.

Note: All the modes and channels had been tested, but only the worst data recorded in the report.



8.5. SPURIOUS EMISSIONS 1 ~ 10GHz

HARMONICS AND SPURIOUS EMISSIONS (LOW CHANNEL, HORIZONTAL)

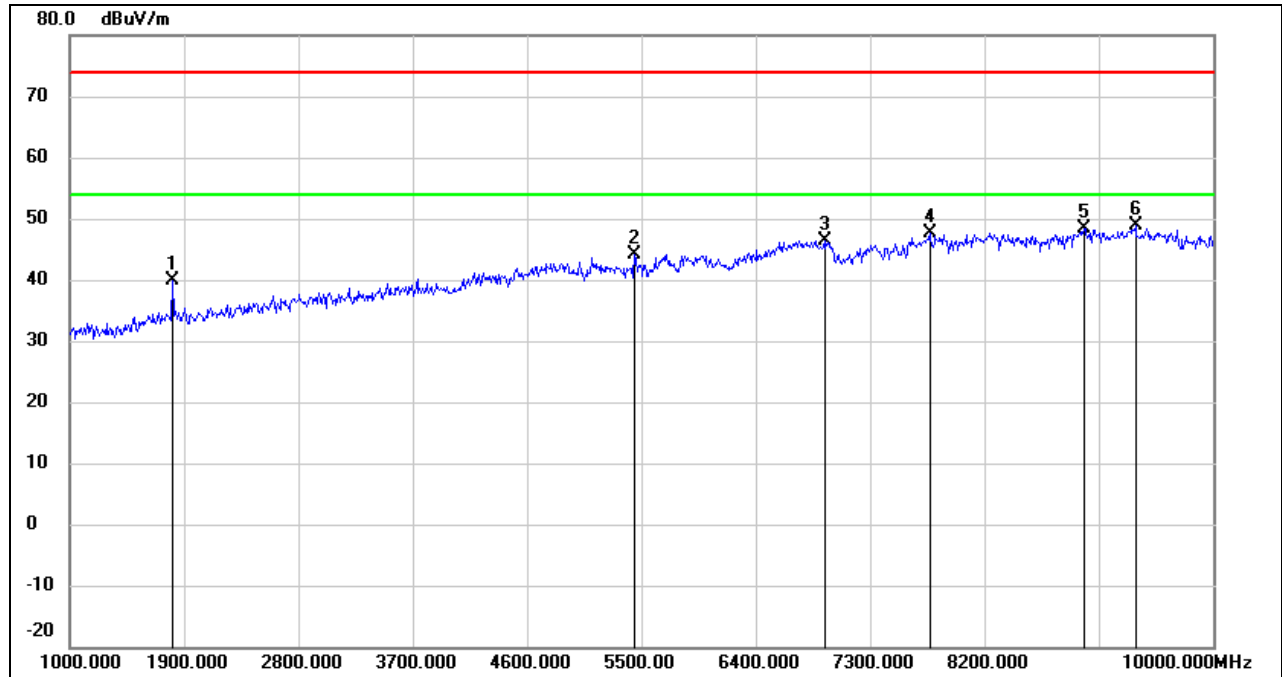

No.	Frequency (MHz)	Reading (dBuV)	Correct (dB/m)	Result (dBuV/m)	Limit (dBuV/m)	Margin (dB)	Remark
1	1810.000	49.95	-10.05	39.90	74.00	-34.10	peak
2	5446.000	42.24	2.01	44.25	74.00	-29.75	peak
3	6940.000	40.51	5.97	46.48	74.00	-27.52	peak
4	7768.000	39.51	8.12	47.63	74.00	-26.37	peak
5	8983.000	37.95	10.45	48.40	74.00	-25.60	peak
6	9388.000	38.63	10.25	48.88	74.00	-25.12	peak

Note: 1. Result = Reading + Correct Factor.

2. If Peak Result complies with AV limit, AV Result is deemed to comply with AV limit.

3. Test setup: RBW: 1 MHz, VBW: 3 MHz, Sweep time: auto.

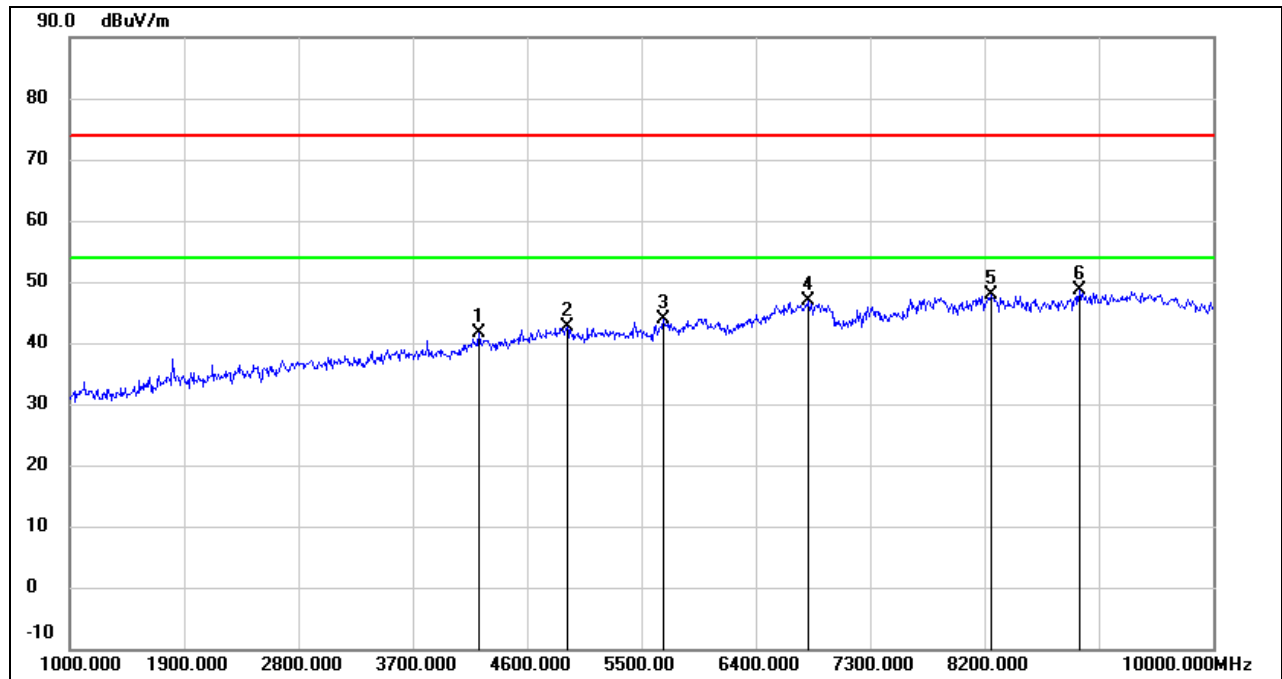
**HARMONICS AND SPURIOUS EMISSIONS (LOW CHANNEL, VERTICAL)**

No.	Frequency (MHz)	Reading (dBuV)	Correct (dB/m)	Result (dBuV/m)	Limit (dBuV/m)	Margin (dB)	Remark
1	4222.000	43.21	-1.69	41.52	74.00	-32.48	peak
2	4915.000	41.79	0.76	42.55	74.00	-31.45	peak
3	5671.000	41.35	2.48	43.83	74.00	-30.17	peak
4	6814.000	41.38	5.62	47.00	74.00	-27.00	peak
5	8254.000	38.66	9.15	47.81	74.00	-26.19	peak
6	8947.000	38.64	10.07	48.71	74.00	-25.29	peak

Note: 1. Result = Reading + Correct Factor.

2. If Peak Result complies with AV limit, AV Result is deemed to comply with AV limit.

3. Test setup: RBW: 1 MHz, VBW: 3 MHz, Sweep time: auto.

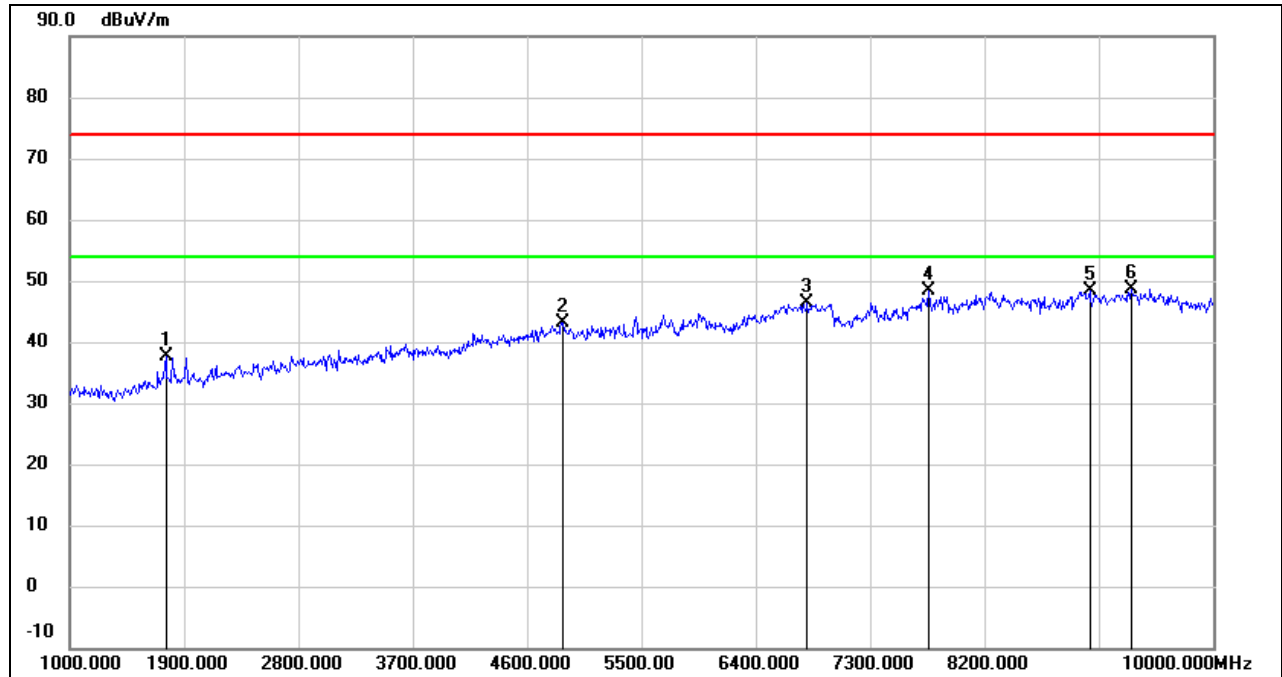
HARMONICS AND SPURIOUS EMISSIONS (MIDDLE CHANNEL, HORIZONTAL)

No.	Frequency (MHz)	Reading (dBuV)	Correct (dB/m)	Result (dBuV/m)	Limit (dBuV/m)	Margin (dB)	Remark
1	1756.000	48.00	-10.38	37.62	74.00	-36.38	peak
2	4879.000	42.51	0.71	43.22	74.00	-30.78	peak
3	6805.000	40.83	5.59	46.42	74.00	-27.58	peak
4	7759.000	40.33	8.09	48.42	74.00	-25.58	peak
5	9028.000	37.99	10.44	48.43	74.00	-25.57	peak
6	9352.000	38.55	10.06	48.61	74.00	-25.39	peak

Note: 1. Result = Reading + Correct Factor.

2. If Peak Result complies with AV limit, AV Result is deemed to comply with AV limit.

3. Test setup: RBW: 1 MHz, VBW: 3 MHz, Sweep time: auto.

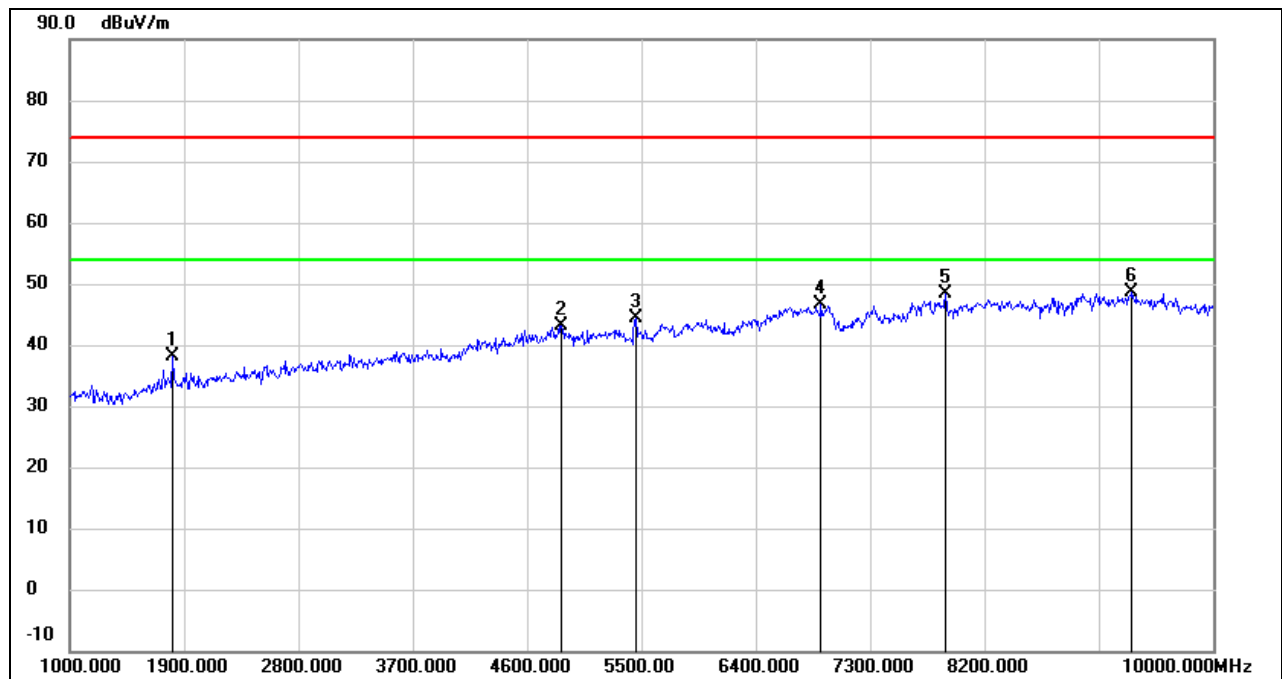
HARMONICS AND SPURIOUS EMISSIONS (MIDDLE CHANNEL, VERTICAL)

No.	Frequency (MHz)	Reading (dBuV)	Correct (dB/m)	Result (dBuV/m)	Limit (dBuV/m)	Margin (dB)	Remark
1	1810.000	48.22	-10.05	38.17	74.00	-35.83	peak
2	4870.000	42.47	0.69	43.16	74.00	-30.84	peak
3	5455.000	42.41	2.04	44.45	74.00	-29.55	peak
4	6913.000	40.79	5.89	46.68	74.00	-27.32	peak
5	7894.000	40.42	7.98	48.40	74.00	-25.60	peak
6	9361.000	38.57	10.12	48.69	74.00	-25.31	peak

Note: 1. Result = Reading + Correct Factor.

2. If Peak Result complies with AV limit, AV Result is deemed to comply with AV limit.

3. Test setup: RBW: 1 MHz, VBW: 3 MHz, Sweep time: auto.

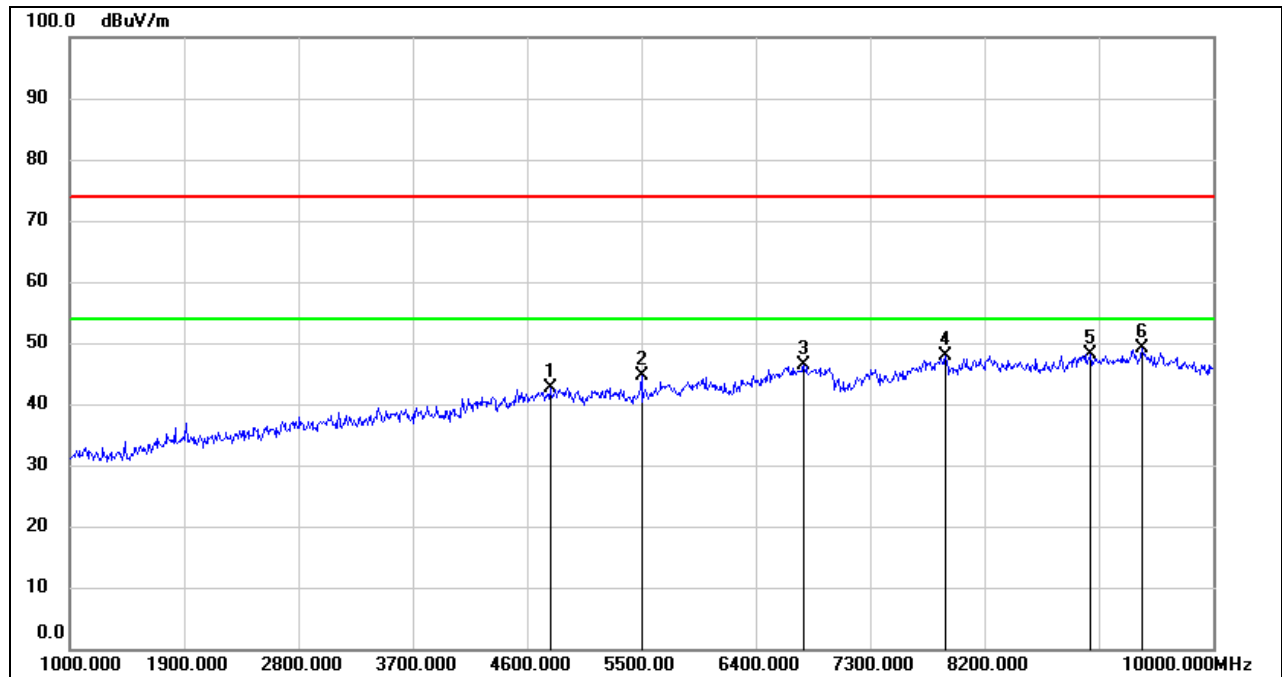
**HARMONICS AND SPURIOUS EMISSIONS (HIGH CHANNEL, HORIZONTAL)**

No.	Frequency (MHz)	Reading (dBuV)	Correct (dB/m)	Result (dBuV/m)	Limit (dBuV/m)	Margin (dB)	Remark
1	4780.000	42.20	0.48	42.68	74.00	-31.32	peak
2	5500.000	42.48	2.17	44.65	74.00	-29.35	peak
3	6778.000	40.84	5.56	46.40	74.00	-27.60	peak
4	7894.000	39.87	7.98	47.85	74.00	-26.15	peak
5	9037.000	37.86	10.38	48.24	74.00	-25.76	peak
6	9442.000	38.88	10.37	49.25	74.00	-24.75	peak

Note: 1. Result = Reading + Correct Factor.

2. If Peak Result complies with AV limit, AV Result is deemed to comply with AV limit.

3. Test setup: RBW: 1 MHz, VBW: 3 MHz, Sweep time: auto.

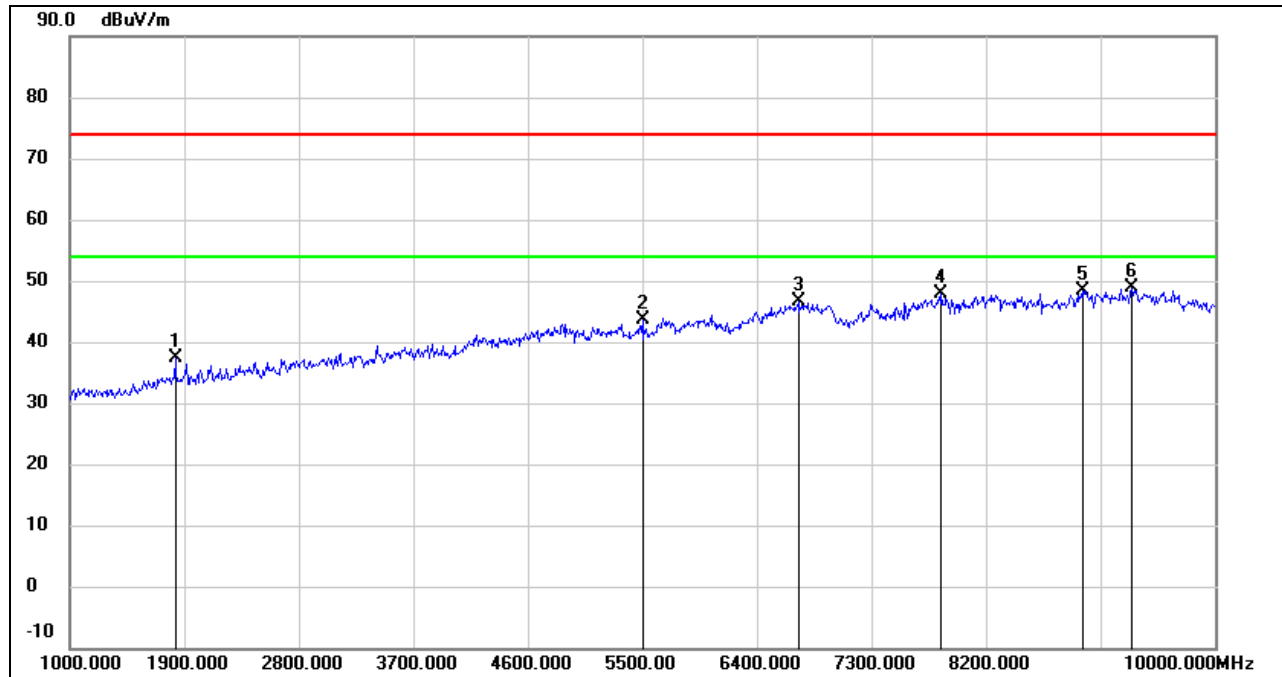
**HARMONICS AND SPURIOUS EMISSIONS (HIGH CHANNEL, VERTICAL)**

No.	Frequency (MHz)	Reading (dBuV)	Correct (dB/m)	Result (dBuV/m)	Limit (dBuV/m)	Margin (dB)	Remark
1	1828.000	47.36	-10.06	37.30	74.00	-36.70	peak
2	5500.000	41.52	2.17	43.69	74.00	-30.31	peak
3	6724.000	41.12	5.54	46.66	74.00	-27.34	peak
4	7849.000	39.69	8.11	47.80	74.00	-26.20	peak
5	8956.000	38.17	10.16	48.33	74.00	-25.67	peak
6	9343.000	38.83	10.02	48.85	74.00	-25.15	peak

Note: 1. Result = Reading + Correct Factor.

2. If Peak Result complies with AV limit, AV Result is deemed to comply with AV limit.

3. Test setup: RBW: 1 MHz, VBW: 3 MHz, Sweep time: auto.



9. ANTENNA REQUIREMENTS

APPLICABLE REQUIREMENTS

Please refer to FCC §15.203

An intentional radiator shall be designed to ensure that no antenna other than that furnished by the responsible party shall be used with the device. The use of a permanently attached antenna or of an antenna that uses a unique coupling to the intentional radiator shall be considered sufficient to comply with the provisions of this section. The manufacturer may design the unit so that a broken antenna can be replaced by the user, but the use of a standard antenna jack or electrical connector is prohibited.

RESULTS

Complies

END OF REPORT