



FCC PART 15 SUBPART C TEST REPORT

FCC PART 15.247

Report Reference No..... : MTEB23060137-R2

FCC ID..... : 2AB2Q-A800SG-G1T

Compiled by

(position+printed name+signature)..: File administrators Alisa Luo



Supervised by

(position+printed name+signature)..: Test Engineer Sunny Deng



Approved by

(position+printed name+signature)..: Manager Yvette Zhou



Date of issue..... : **June 19,2023**

Representative Laboratory Name. : Shenzhen Most Technology Service Co., Ltd.

Address..... : No.5, 2nd Langshan Road, North District, Hi-tech Industrial Park,
Nanshan, Shenzhen, Guangdong, China.

Applicant's name..... : LEEDARSON LIGHTING CO., LTD.

Address..... : Xingda Road, Xingtai Industrial Zone, Changtai County, Zhangzhou,
Fujian, China

Test specification..... :

Standard..... : **FCC Part 15.247**

TRF Originator..... : Shenzhen Most Technology Service Co., Ltd.

Shenzhen Most Technology Service Co., Ltd. All rights reserved.

This publication may be reproduced in whole or in part for non-commercial purposes as long as the Shenzhen Most Technology Service Co., Ltd. is acknowledged as copyright owner and source of the material. Shenzhen Most Technology Service Co., Ltd. takes no responsibility for and will not assume liability for damages resulting from the reader's interpretation of the reproduced material due to its placement and context.

Test item description..... : Smart LED Lamp

Trade Mark..... : LEEDARSON

Manufacturer..... : 1:LEEDARSON LIGHTING CO., LTD.

2:LEEDARSON IOT TECHNOLOGY (THAILAND) CO., LTD.

Model/Type reference..... : 12CFA1960WRGB01

Listed Models : 13aFS-A800SG-G1T-xx, 12CFA1960WRGBxx

13aFS-ST800SG-G1T-xx, 12CFST1960RGBxx

13aFA-G800SG-G1T-xx, 12CFG2560WRGBxx

(Where "y" may be "A" to "Z", which designates for different enclosure pattern design; "xx" may be "00" to "99", which designates for different beam angle, color of eyelet contact, different package of style and CCT.)

Modulation Type..... : CCK/DSSS/ OFDM

Operation Frequency..... : From 2412 - 2462MHz

Rating..... : 120V, 60Hz, 117mA, 8.5W

Hardware version..... : wifi 2.4G+ble 4.2

Software version : Hubspace

Result..... : PASS

TEST REPORT

Equipment under Test : Smart LED Lamp

Model /Type : 12CFA1960WRGB01

Listed Models : 13aFS-A800SG-G1T-xx, 12CFA1960WRGBxx
 13aFS-ST800SG-G1T-xx, 12CFST1960RGBxx
 13aFA-G800SG-G1T-xx, 12CFG2560WRGBxx
 (Where “y” may be “A” to “Z”, which designates for different enclosure pattern design; “xx” may be “00” to “99”, which designates for different beam angle, color of eyelet contact, different package of style and CCT.)

Remark : Their electrical circuit design,layout components used and internal wiring are identical,Only the beam angle, color of eyelet contact, package of style and CCT are different.

Applicant : LEEDARSON LIGHTING CO., LTD.

Address : Xingda Road, Xingtai Industrial Zone, Changtai County, Zhangzhou, Fujian, China

Manufacturer(1) : LEEDARSON LIGHTING CO., LTD.

Address(1) : Xingtai Industrial Zone, Economic Development Zone, Changtai County, Zhangzhou City, Fujian Province, P.R.China

Manufacturer(2) : LEEDARSON IOT TECHNOLOGY (THAILAND) CO., LTD.

Address(2) : 71, Moo5,Wellgrow Industrial Easte. Bang Samak, Bang Pakong District, Chachoengsao 24130

Test Result:	PASS
---------------------	-------------

The test report merely corresponds to the test sample.
 It is not permitted to copy extracts of these test result without the written permission of the test laboratory.

Contents

1 REVISION HISTORY	4
2 TEST STANDARDS	5
3 SUMMARY	6
3.1 General Remarks	6
3.2 Product Description	6
3.3 Equipment Under Test	6
3.4 Short description of the Equipment under Test (EUT)	6
3.5 EUT operation mode	7
3.6 Block Diagram of Test Setup	7
3.7 Test Item (Equipment Under Test) Description*	7
3.8 Auxiliary Equipment (AE) Description	7
3.9 Antenna Information*	7
3.10 Related Submittal(s) / Grant (s)	8
3.11 Modifications	8
3.12 Additional Instructions	8
4 TEST ENVIRONMENT	9
4.1 Address of the test laboratory	9
4.2 Test Facility	9
4.3 Environmental conditions	9
4.4 Test Description	10
4.5 Statement of the measurement uncertainty	10
4.6 Equipments Used during the Test	11
5 TEST CONDITIONS AND RESULTS	12
5.1 AC Power Conducted Emission	12
5.2 Radiated Emission	15
5.3 Maximum Conducted Output Power	36
5.4 Power Spectral Density	37
5.5 6dB Bandwidth	38
5.6 Out-of-band Emissions	39
5.7 Duty Cycle Information	40
5.8 Antenna Requirement	41
6 TEST SETUP PHOTOS OF THE EUT	42
7 PHOTOS OF THE EUT	43
APPENDIX I. Conducted Peak Output Power	44
APPENDIX II.99% Bandwidth	45
APPENDIX III.6dB Bandwidth	48
APPENDIX IV. Conducted Out Of Band Emission	51
APPENDIX V. Duty Cycle	57
APPENDIX VI. Power Spectral Density	59

1 Revision History

Revision	Issue Date	Revisions	Revised By
00	2023.06.19	Initial Issue	Alisa Luo

2 TEST STANDARDS

The tests were performed according to following standards:

[FCC Rules Part 15.247](#): Frequency Hopping, Direct Spread Spectrum and Hybrid Systems that are in operation within the bands of 902-928 MHz, 2400-2483.5 MHz, and 5725-5850 MHz.

[ANSI C63.10-2013](#): American National Standard for Testing Unlicensed Wireless Devices

[KDB558074 D01 v05r02](#): Guidance for Compliance Measurements on Digital Transmission Systems (DTS) ,Frequency Hopping Spread Spectrum System(HFSS), and Hybrid System Devices Operating Under §15.247 of The FCC rules.

3 SUMMARY

3.1 General Remarks

Date of receipt of test sample	:	2023.06.07
Testing commenced on	:	2023.06.08
Testing concluded on	:	2023.06.11

3.2 Product Description

Product Name:	Smart LED Lamp
Model/Type reference:	12CFA1960WRGB01
Power Supply:	120V, 60Hz, 117mA, 8.5W
Testing sample ID:	MTYP01635
WIFI :	
Supported type:	802.11b/802.11g/802.11n(H20)/ 802.11n(HT40)
Modulation:	802.11b: DSSS 802.11g/802.11n(H20)/ 802.11n(HT40): OFDM
Operation frequency:	802.11b/802.11g/802.11n(H20)/ 802.11n(HT40): 2412MHz~2462MHz 802.11n(HT40): 2422MHz~2452MHz
Channel number:	802.11b/802.11g/802.11n(H20):11 802.11n(HT40): 7
Channel separation:	5MHz
Antenna type:	Internal monopole antenna
Antenna gain:	-3.45dBi

3.3 Equipment Under Test

Power supply system utilised

Power supply voltage	:	<input type="radio"/> 230V / 50 Hz	<input checked="" type="radio"/> 120V / 60Hz
		<input type="radio"/> 12 V DC	<input type="radio"/> 24 V DC
		<input type="radio"/> Other (specified in blank below)	

3.4 Short description of the Equipment under Test (EUT)

This is a Smart LED Lamp For more details, refer to the user's manual of the EUT.

3.5 EUT operation mode

The application provider specific test software(AT command) to control sample in continuous TX and RX for testing meet KDB558074 test requirement

IEEE 802.11b/g/n: Thirteen channels are provided to the EUT.

Channel	Frequency(MHz)	Channel	Frequency(MHz)
1	2412	8	2447
2	2417	9	2452
3	2422	10	2457
4	2427	11	2462
5	2432		
6	2437		
7	2442		

3.6 Block Diagram of Test Setup

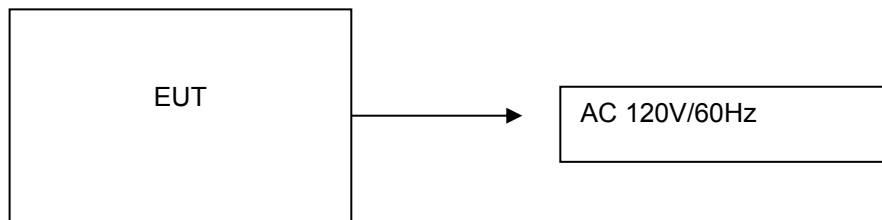

3.7 Test Item (Equipment Under Test) Description*

Short designation	EUT Name	EUT Description	Serial number	Hardware status	Software status
EUT A	/	/	/	/	/
EUT B	/	/	/	/	/

*: declared by the applicant. According to customers information EUTs A and B are the same devices.

3.8 Auxiliary Equipment (AE) Description

AE short designation	EUT Name (if available)	EUT Description	Serial number (if available)	Software (if used)
AE 1	/	/	/	/
AE 2	/	/	/	/

3.9 Antenna Information*

Short designation	Antenna Name	Antenna Type	Frequency Range	Serial number	Antenna Peak Gain
Antenna 1	---	Internal monopole antenna	2.4 – 2.5 GHz	---	-3.45dbi
Antenna 2					

*: declared by the applicant.

3.10 Related Submittal(s) / Grant (s)

This submittal(s) (test report) is intended for **FCC ID: 2AB2Q-A800SG-G1T** filing to comply with Section 15.247 of the FCC Part 15, Subpart C Rules.

3.11 Modifications

No modifications were implemented to meet testing criteria.

3.12 Additional Instructions

EUT Power level: Class 0

Use key of EUT to set the lowest frequency, the middle frequency and the highest frequency keep transmitting of the EUT.

4 TEST ENVIRONMENT

4.1 Address of the test laboratory

Shenzhen Most Technology Service Co., Ltd.

No.5, 2nd Langshan Road, North District, Hi-tech Industrial Park, Nanshan, Shenzhen, Guangdong, China.
The 3m-Semi anechoic test site fulfils CISPR 16-1-4 according to ANSI C63.4:2014 and CISPR 16-1-4:2010 SVSWR requirement for radiated emission above 1GHz.

4.2 Test Facility

The test facility is recognized, certified, or accredited by the following organizations:

FCC-Registration No.: 0031192610

Shenzhen Most Technology Service Co., Ltd. EMC Laboratory has been registered and fully described in a report filed with the (FCC) Federal Communications Commission. The acceptance letter from the FCC is maintained in our files.

A2LA-Lab Cert. No.: 6343.01

Shenzhen Most Technology Service Co., Ltd. EMC Laboratory has been accredited by A2LA for technical competence in the field of electrical testing, and proved to be in compliance with ISO/IEC 17025: 2005 General Requirements for the Competence of Testing and Calibration Laboratories and any additional program requirements in the identified field of testing.

4.3 Environmental conditions

Radiated Emission:

Temperature:	24 ° C
Humidity:	48 %
Atmospheric pressure:	950-1050mbar

AC Main Conducted testing:

Temperature:	24 ° C
Humidity:	45 %
Atmospheric pressure:	950-1050mbar

Conducted testing:

Temperature:	24 ° C
Humidity:	45 %
Atmospheric pressure:	950-1050mbar

4.4 Test Description

FCC PART 15.247		
FCC Part 15.207	AC Power Conducted Emission	PASS
FCC Part 15.247(a)(2)	6dB Bandwidth	PASS
FCC Part 15.247(d)	Spurious RF Conducted Emission	PASS
FCC Part 15.247(b)	Maximum Conducted Output Power	PASS
FCC Part 15.247(e)	Power Spectral Density	PASS
FCC Part 15.109/ 15.205/ 15.209	Radiated Emissions	PASS
FCC Part 15.247(d)	Band Edge	PASS
FCC Part 15.203/15.247 (b)	Antenna Requirement	PASS

Data Rate Used:

Preliminary tests were performed in different data rate to find the worst radiated emission. The data rate shown in the table below is the worst-case rate with respect to the specific test item. Investigation has been done on all the possible configurations for searching the worst cases. The following table is a list of the test modes shown in this test report.

Test Items	Mode	Data Rate	Channel
Maximum Peak Conducted Output Power Power Spectral Density 6dB Bandwidth Spurious RF conducted emission Radiated Emission 9KHz~1GHz& Radiated Emission 1GHz~10 th Harmonic	11b/DSSS	1 Mbps	1/6/11
	11g/OFDM	6 Mbps	1/6/11
	11n(20MHz)/OFDM	6.5Mbps	1/6/11
	/	/	/
Band Edge	11b/DSSS	1 Mbps	1/11
	11g/OFDM	6 Mbps	1/11
	11n(20MHz)/OFDM	6.5Mbps	1/11
	11n(40MHz)/OFDM	6.5Mbps	1/11

4.5 Statement of the measurement uncertainty

The data and results referenced in this document are true and accurate. The reader is cautioned that there may be errors within the calibration limits of the equipment and facilities. The measurement uncertainty was calculated for all measurements listed in this test report acc. to CISPR 16 - 4 „Specification for radio disturbance and immunity measuring apparatus and methods – Part 4: Uncertainty in EMC Measurements“ and is documented in the Shenzhen Most Technology Service Co., Ltd. quality system acc. to DIN EN ISO/IEC 17025. Furthermore, component and process variability of devices similar to that tested may result in additional deviation. The manufacturer has the sole responsibility of continued compliance of the device.

Hereafter the best measurement capability for Shenzhen Most Technology Service Co., Ltd. is reported:

Test	Range	Measurement Uncertainty	Notes
Radiated Emission	30~1000MHz	4.10 dB	(1)
Radiated Emission	1~18GHz	4.32 dB	(1)
Radiated Emission	18-40GHz	5.54 dB	(1)
Conducted Disturbance	0.15~30MHz	3.12 dB	(1)

- (1) This uncertainty represents an expanded uncertainty expressed at approximately the 95% confidence level using a coverage factor of k=2.

4.6 Equipments Used during the Test

Item	Equipment	Manufacturer	Model No.	Serial No.	Firmware versions	Last Cal.	Cal. Interval
1.	L.I.S.N.	R&S	ENV216	100093	/	2023/03/17	1 Year
2	Three-phase artificial power network	Schwarzback Mess	NNLK8129	8129178	/	2023/03/17	1 Year
3.	Receiver	R&S	ESCI	100492	V3.0-10-2	2023/03/17	1 Year
4	Receiver	R&S	ESPI	101202	V3.0-10-2	2023/03/17	1 Year
5	Spectrum analyzer	Agilent	9020A	MT-E306	A14.16	2023/03/17	1 Year
6	Bilong Antenna	Sunol Sciences	JB3	A121206	/	2023/03/17	1 Year
7	Horn antenna	HF Antenna	HF Antenna	MT-E158	/	2023/03/17	1 Year
8	Loop antenna	Beijing Daze	ZN30900B	/	/	2023/03/17	1 Year
9	Horn antenna	R&S	OBH100400	26999002	/	2023/03/17	1 Year
10	Wireless Communication Test Set	R&S	CMW500	/	CMW-BASE-3.7.21	2023/03/17	1 Year
11	Spectrum analyzer	R&S	FSP	100019	V4.40 SP2	2023/03/17	1 Year
12	High gain antenna	Schwarzbeck	LB-180400KF	MT-E389	/	2023/03/17	1 Year
13	Preamplifier	Schwarzbeck	BBV 9743	MT-E390	/	2023/03/17	1 Year
14	Pre-amplifier	EMCI	EMC051845S E	MT-E391	/	2023/03/17	1 Year
15	Pre-amplifier	Agilent	83051A	MT-E392	/	2023/03/17	1 Year
16	High pass filter unit	Tonscend	JS0806-F	MT-E393	/	2023/03/17	1 Year
17	RF Cable(below1GHz)	Times	9kHz-1GHz	MT-E394	/	2023/03/17	1 Year
18	RF Cable(above 1GHz)	Times	1-40G	MT-E395	/	2023/03/17	1 Year
19	RF Cable (9KHz-40GHz)	Tonscend	170660	N/A	/	2023/03/17	1 Year

Note: The Cal.Interval was one year.

5 TEST CONDITIONS AND RESULTS

5.1 AC Power Conducted Emission

TEST CONFIGURATION

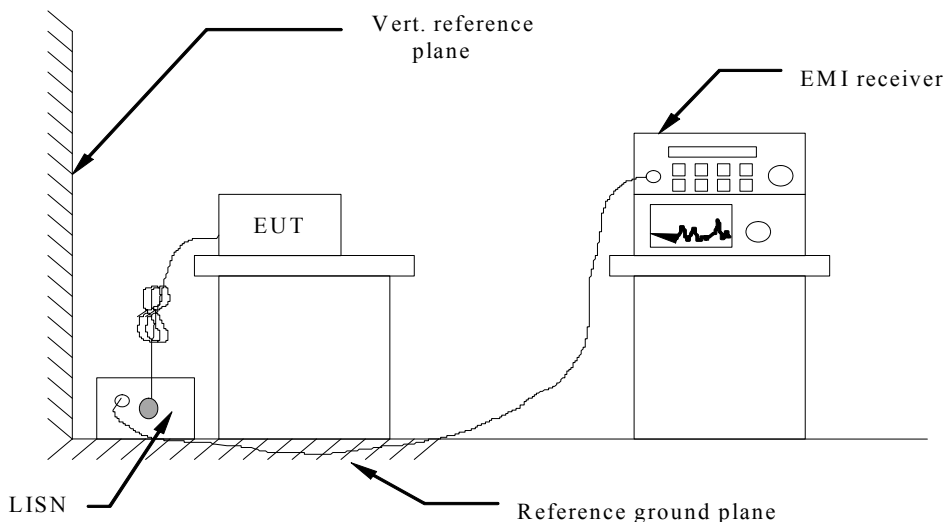

TEST PROCEDURE

- 1 The equipment was set up as per the test configuration to simulate typical actual usage per the user's manual. The EUT is a tabletop system, a wooden table with a height of 0.8 meters is used and is placed on the ground plane as per ANSI C63.10-2013.
- 2 Support equipment, if needed, was placed as per ANSI C63.10-2013
- 3 All I/O cables were positioned to simulate typical actual usage as per ANSI C63.10-2013
- 4 The EUT received 120V, 60HZ, 75MA, 5.8W power from adapter, the adapter received AC120V/60Hz and AC 240V/60Hz power through a Line Impedance Stabilization Network (LISN) which supplied power source and was grounded to the ground plane.
- 5 All support equipments received AC power from a second LISN, if any.
- 6 The EUT test program was started. Emissions were measured on each current carrying line of the EUT using a spectrum Analyzer / Receiver connected to the LISN powering the EUT. The LISN has two monitoring points: Line 1 (Hot Side) and Line 2 (Neutral Side). Two scans were taken: one with Line 1 connected to Analyzer / Receiver and Line 2 connected to a 50 ohm load; the second scan had Line 1 connected to a 50 ohm load and Line 2 connected to the Analyzer / Receiver.
- 7 Analyzer / Receiver scanned from 150 KHz to 30MHz for emissions in each of the test modes.
- 8 During the above scans, the emissions were maximized by cable manipulation.

AC Power Conducted Emission Limit

For intentional device, according to § 15.207(a) AC Power Conducted Emission Limits is as following :

Frequency range (MHz)	Limit (dBuV)	
	Quasi-peak	Average
0.15-0.5	66 to 56*	56 to 46*
0.5-5	56	46
5-30	60	50

* Decreases with the logarithm of the frequency.

TEST RESULTS

Remark:

1. WIFI modes were test at 802.11b/802.11g/802.11n (H20) /802.11n (H40) (Low, Middle, and High channel); only the worst result of 802.11b Middle Channel was reported as below:

Power supply:

AC 120V/60Hz

Polarization

L

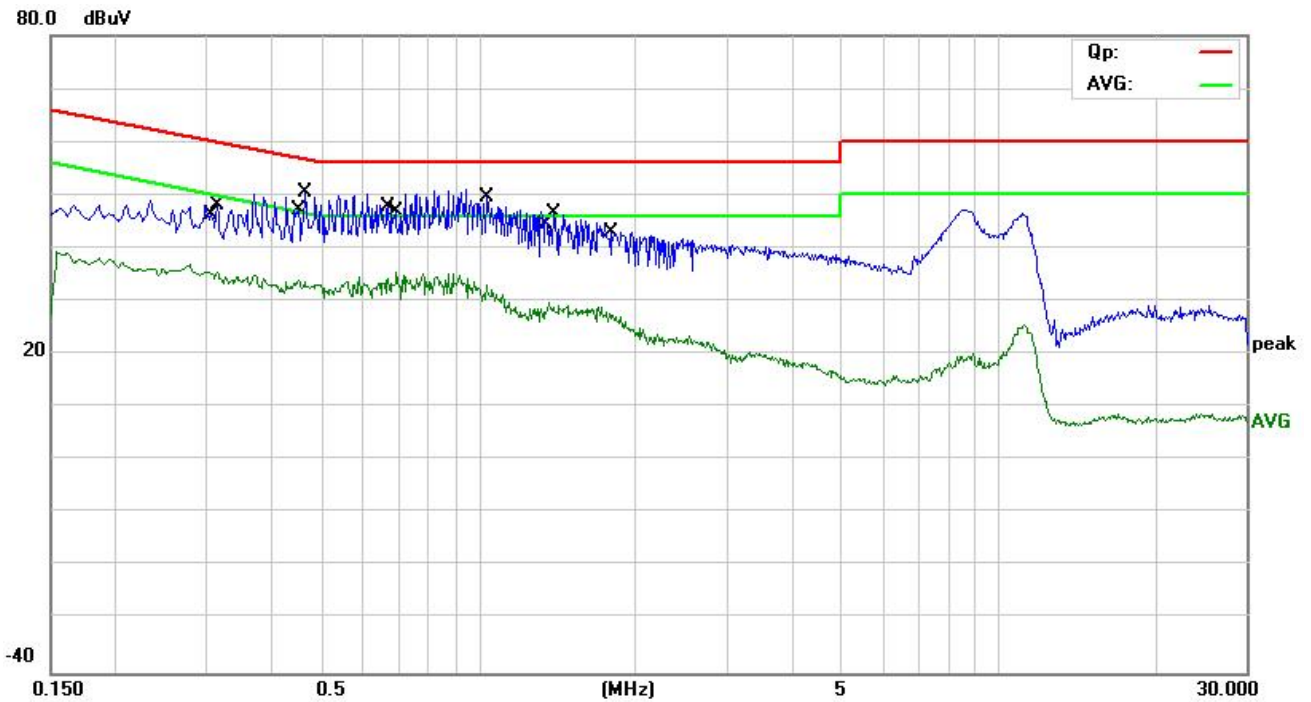

No.	Mk.	Freq. MHz	Reading Level dBuV	Correct Factor dB	Measure- ment dBuV	Limit dBuV	Over dB	Detector	Comment
1		0.3020	25.99	9.59	35.58	50.19	-14.61	AVG	
2		0.3140	38.53	9.59	48.12	59.86	-11.74	QP	
3		0.4500	24.22	9.59	33.81	46.88	-13.07	AVG	
4	*	0.4660	40.83	9.59	50.42	56.58	-6.16	QP	
5		0.6700	38.25	9.60	47.85	56.00	-8.15	QP	
6		0.6940	25.79	9.60	35.39	46.00	-10.61	AVG	
7		1.0340	40.05	9.60	49.65	56.00	-6.35	QP	
8		1.0340	23.41	9.60	33.01	46.00	-12.99	AVG	
9		1.3620	20.04	9.60	29.64	46.00	-16.36	AVG	
10		1.3900	37.05	9.60	46.65	56.00	-9.35	QP	
11		1.7820	18.03	9.60	27.63	46.00	-18.37	AVG	
12		1.8020	33.40	9.60	43.00	56.00	-13.00	QP	

*:Maximum data x:Over limit !:over margin

Power supply:

AC 120V/60Hz

Polarization

N

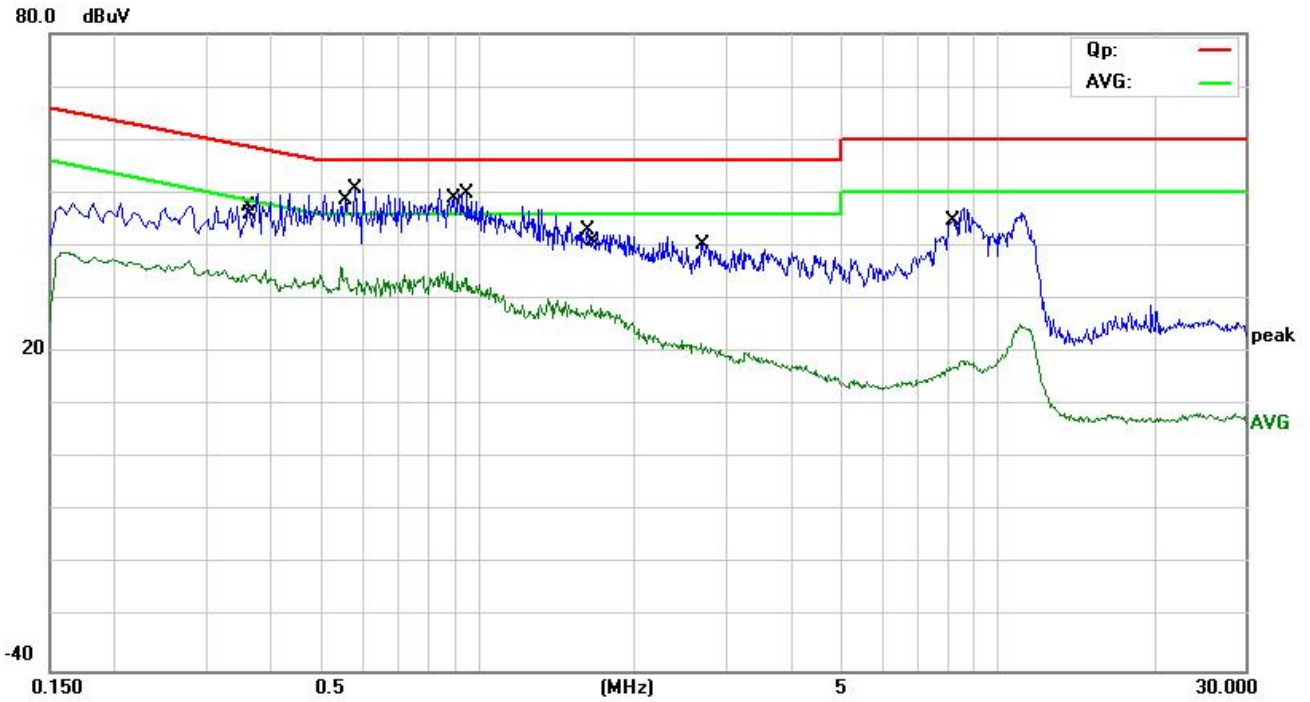

No.	Mk.	Freq. MHz	Reading Level dBuV	Correct Factor dB	Measure- ment dBuV	Limit dB	Over dB	Detector	Comment
1		0.3620	37.81	9.59	47.40	58.68	-11.28	QP	
2		0.3660	25.05	9.59	34.64	48.59	-13.95	AVG	
3		0.5580	24.47	9.59	34.06	46.00	-11.94	AVG	
4	*	0.5820	41.23	9.59	50.82	56.00	-5.18	QP	
5		0.8940	25.15	9.60	34.75	46.00	-11.25	AVG	
6		0.9540	40.14	9.60	49.74	56.00	-6.26	QP	
7		1.6300	33.36	9.60	42.96	56.00	-13.04	QP	
8		1.6620	19.26	9.60	28.86	46.00	-17.14	AVG	
9		2.7020	12.17	9.61	21.78	46.00	-24.22	AVG	
10		2.7180	30.64	9.61	40.25	56.00	-15.75	QP	
11		8.2260	35.12	9.67	44.79	60.00	-15.21	QP	
12		8.2260	7.60	9.67	17.27	50.00	-32.73	AVG	

*:Maximum data x:Over limit !:over margin

5.2 Radiated Emission

TEST CONFIGURATION

Frequency range 9 KHz – 30MHz

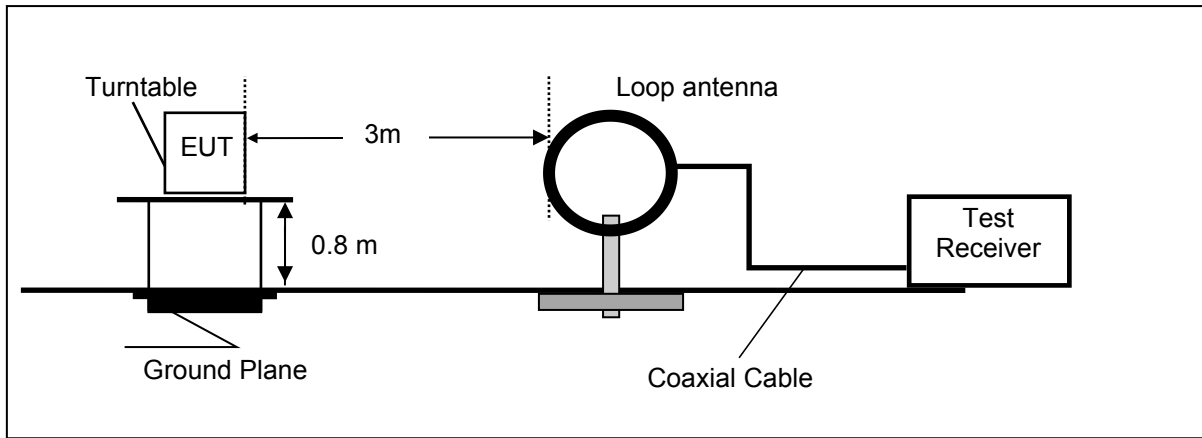

Frequency range 30MHz – 1000MHz

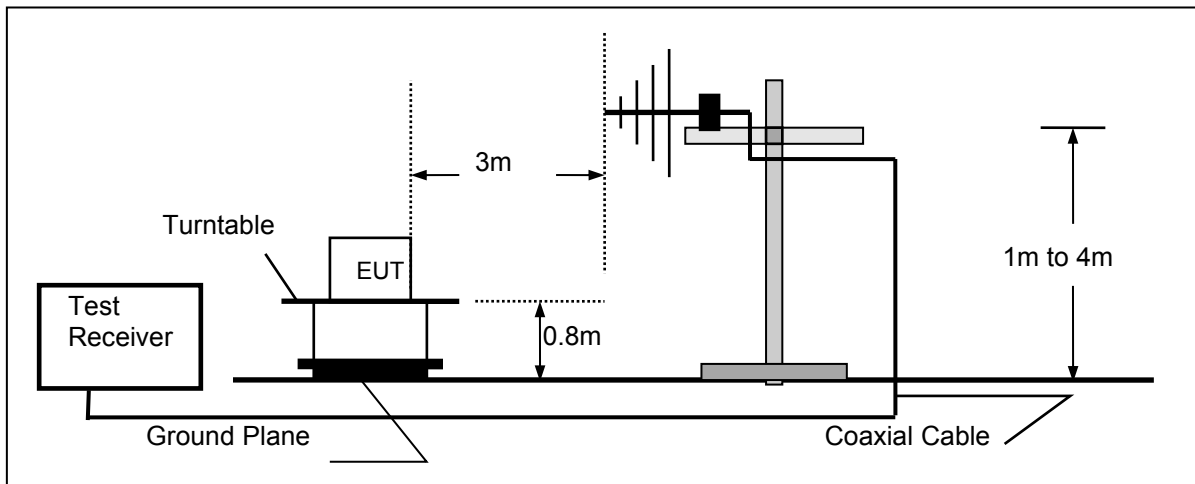

Frequency range above 1GHz-25GHz

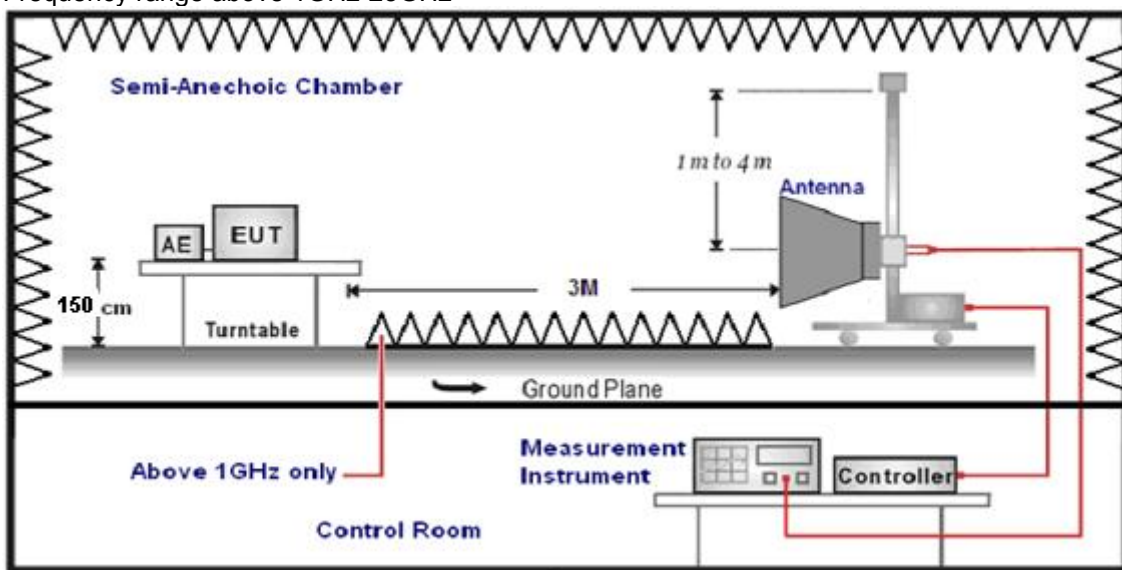

TEST PROCEDURE

1. The EUT was placed on a turn table which is 0.8m above ground plane when testing frequency range 9 KHz –1GHz;the EUT was placed on a turn table which is 1.5m above ground plane when testing frequency range 1GHz – 25GHz.
2. Maximum procedure was performed by raising the receiving antenna from 1m to 4m and rotating the turn table from 0° to 360° to acquire the highest emissions from EUT.
3. And also, each emission was to be maximized by changing the polarization of receiving antenna both horizontal and vertical.
4. Repeat above procedures until all frequency measurements have been completed.
5. Radiated emission test frequency band from 9KHz to 25GHz.
6. The distance between test antenna and EUT as following table states:

Test Frequency range	Test Antenna Type	Test Distance
9KHz-30MHz	Active Loop Antenna	3
30MHz-1GHz	Ultra-Broadband Antenna	3
1GHz-18GHz	Double Ridged Horn Antenna	3
18GHz-25GHz	Horn Antenna	1

7. Setting test receiver/spectrum as following table states:

Test Frequency range	Test Receiver/Spectrum Setting	Detector
9KHz-150KHz	RBW=200Hz/VBW=3KHz,Sweep time=Auto	QP
150KHz-30MHz	RBW=9KHz/VBW=100KHz,Sweep time=Auto	QP
30MHz-1GHz	RBW=120KHz/VBW=1000KHz,Sweep time=Auto	QP
1GHz-40GHz	Peak Value: RBW=1MHz/VBW=3MHz, Sweep time=Auto Average Value: RBW=1MHz/VBW=10Hz, Sweep time=Auto	Peak

Field Strength Calculation

The field strength is calculated by adding the Antenna Factor and Cable Factor and subtracting the Amplifier Gain and Duty Cycle Correction Factor(if any) from the measured reading. The basic equation with a sample calculation is as follows:

FS = RA + AF + CL - AG

Where	FS = Field Strength	CL = Cable Attenuation Factor (Cable Loss)
	RA = Reading Amplitude	AG = Amplifier Gain
	AF = Antenna Factor	

Transd=AF +CL-AG

RADIATION LIMIT

For intentional device, according to § 15.209(a), the general requirement of field strength of radiated emission from intentional radiators at a distance of 3 meters shall not exceed the following table. According to § 15.247(d), in any 100kHz bandwidth outside the frequency band in which the EUT is operating, the radio frequency power that is produced by the intentional radiator shall be at least 20dB below that in the100kHz bandwidth within the band that contains the highest level of desired power.

The pre-test have done for the EUT in three axes and found the worst emission at position shown in test setup photos.

Frequency (MHz)	Distance (Meters)	Radiated (dBµV/m)	Radiated (µV/m)
0.009-0.49	3	20log(2400/F(KHz))+40log(300/3)	2400/F(KHz)
0.49-1.705	3	20log(24000/F(KHz))+ 40log(30/3)	24000/F(KHz)
1.705-30	3	20log(30)+ 40log(30/3)	30
30-88	3	40.0	100
88-216	3	43.5	150
216-960	3	46.0	200
Above 960	3	54.0	500

TEST RESULTS

Remark:

1. This test was performed with EUT in X, Y, Z position and the worse case was found when EUT in X position.
2. All three channels (lowest/middle/highest) of each mode were measured below 1GHz and recorded worst case at 802.11b low channel.
3. Radiated emission test from 9 KHz to 10th harmonic of fundamental was verified, and no emission found except system noise floor in 9 KHz to 30MHz and not recorded in this report.
4. Remark: Result=Reading value+Factor

For 30MHz-1GHz

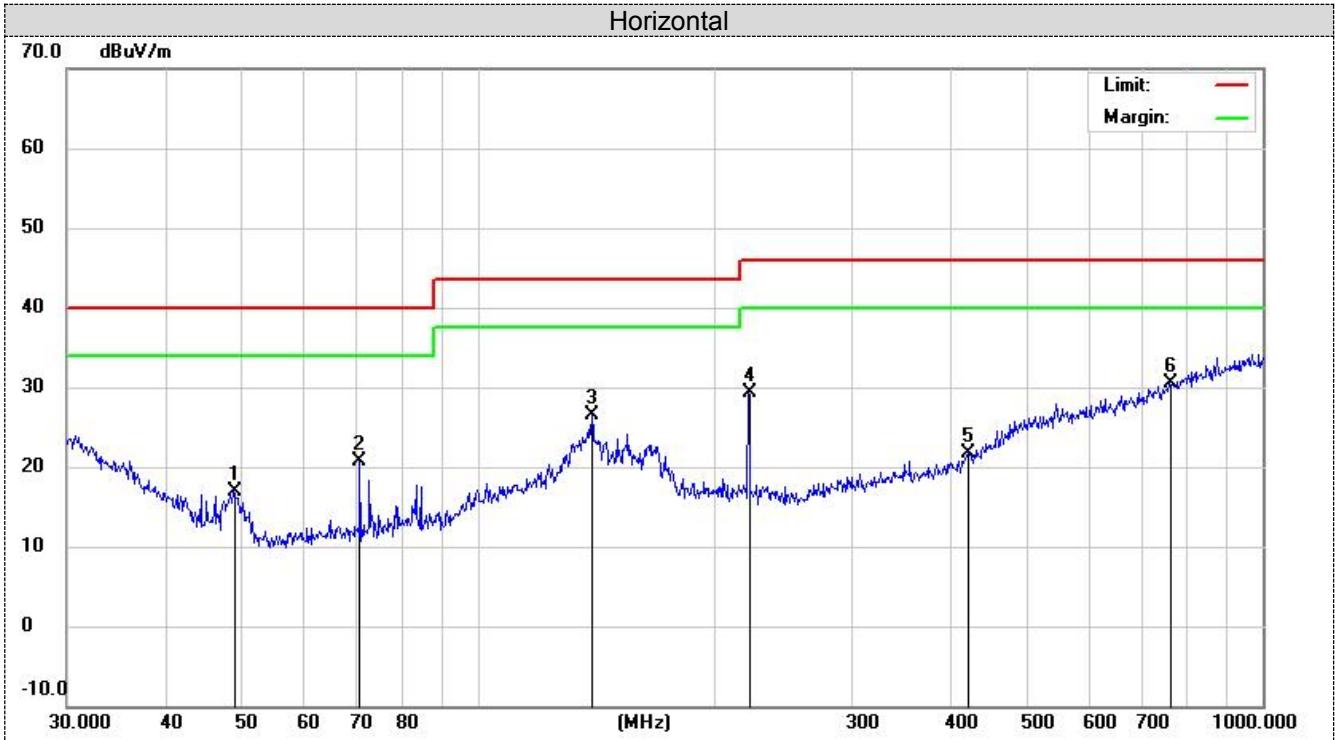

No.	Mk.	Freq. MHz	Reading Level dBuV	Correct Factor dB	Measure- ment dBuV/m	Limit dBuV/m	Over dB	Detector	Antenna Height cm	Table Degree	Comment
1		48.8429	8.28	8.66	16.94	40.00	-23.06	QP	200	24	
2		70.8315	11.36	9.37	20.73	40.00	-19.27	QP	200	102	
3		139.8508	10.02	16.40	26.42	43.50	-17.08	QP	200	186	
4		221.3921	14.70	14.60	29.30	46.00	-16.70	QP	200	254	
5		422.0577	3.23	18.57	21.80	46.00	-24.20	QP	200	299	
6	*	760.7036	3.75	26.80	30.55	46.00	-15.45	QP	200	332	

*:Maximum data x:Over limit !:over margin

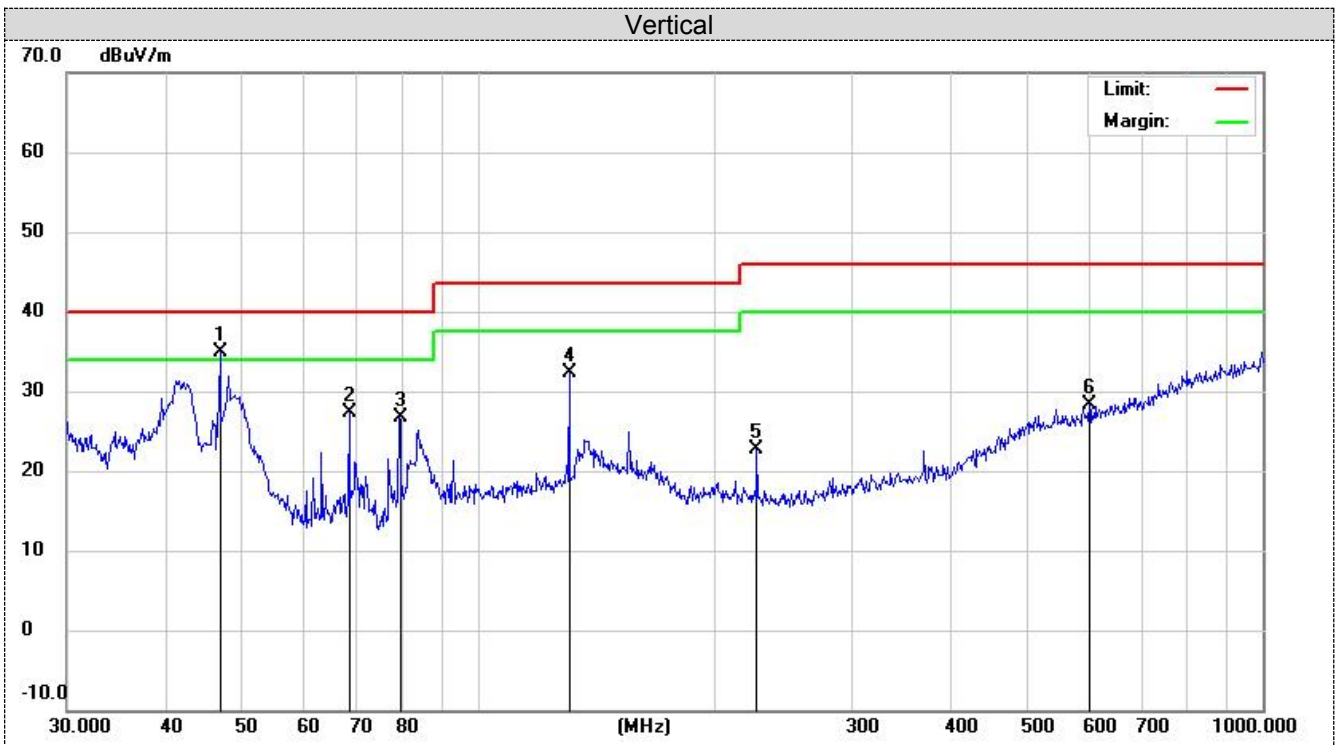

No.	Mk.	Freq. MHz	Reading Level dBuV	Correct Factor dB	Measure- ment dBuV/m	Limit dBuV/m	Over dB	Detector	Antenna Height cm	Table Degree	Comment
1	*	46.9948	25.42	9.54	34.96	40.00	-5.04	QP	100	24	
2		68.6310	18.16	9.20	27.36	40.00	-12.64	QP	100	102	
3		79.5209	16.71	10.06	26.77	40.00	-13.23	QP	100	186	
4		130.8369	16.15	16.16	32.31	43.50	-11.19	QP	100	232	
5		226.8936	8.23	14.45	22.68	46.00	-23.32	QP	100	299	
6		601.4265	4.39	23.82	28.21	46.00	-17.79	QP	100	331	

*:Maximum data x:Over limit !:over margin

For 1GHz to 25GHz

Note: 802.11b/802.11g/802.11n (H20) /802.11n (H40) all have been tested, only worse case 802.11b mode is reported

Polar (H/V)	Frequency	Meter Reading	Antenna Factor	Cable loss	Preamp factor	Emission Level	Limits	Margin	Detector Type
	(MHz)	(dBuV)	(dB)	(dB)	(dB)	(dBuV/m)	(dBuV/m)	(dB)	
802.11b-2412MHz									
V	4824	54.62	30.28	7.01	36.5	55.41	74	18.59	PK
V	4824	44.61	30.28	7.01	36.5	45.4	54	8.6	AV
H	4824	54.72	30.28	7.01	36.5	55.51	74	18.49	PK
H	4824	40.69	30.28	7.01	36.5	41.48	54	12.52	AV
V	7236	43.38	36.59	8.91	35.3	53.58	74	20.42	PK
V	7236	30.46	36.59	8.91	35.3	40.66	54	13.34	AV
H	7236	44.87	36.59	8.91	35.3	55.07	74	18.93	PK
H	7236	31.44	36.59	8.91	35.3	41.64	54	12.36	AV
802.11b -2437MHz									
V	4874	56.5	30.36	7.62	36.5	57.98	74	16.02	PK
V	4874	44.84	30.36	7.62	36.5	46.32	54	7.68	AV
H	4874	57.11	30.36	7.62	36.5	58.59	74	15.41	PK
H	4874	42.9	30.36	7.62	36.5	44.38	54	9.62	AV
V	7311	43.42	36.61	8.84	35.3	53.57	74	20.43	PK
V	7311	29.31	36.61	8.84	35.3	39.46	54	14.54	AV
H	7311	42.2	36.61	8.84	35.3	52.35	74	21.65	PK
H	7311	31.03	36.61	8.84	35.3	41.18	54	12.82	AV
802.11b -2462MHz									
V	4924	55.97	30.43	7.94	36.2	58.14	74	15.86	PK
V	4924	42.9	30.43	7.94	36.2	45.07	54	8.93	AV
H	4924	56.74	30.43	7.94	36.2	58.91	74	15.09	PK
H	4924	41.9	30.43	7.94	36.2	44.07	54	9.93	AV
V	7386	39.66	36.78	8.45	35.3	49.59	74	24.41	PK
V	7386	29.86	36.78	8.45	35.3	39.79	54	14.21	AV
H	7386	41.41	36.78	8.45	35.3	51.34	74	22.66	PK
H	7386	29.14	36.78	8.45	35.3	39.07	54	14.93	AV

Note:

- 1) Emission level (dBuV/m) = Meter Reading+ antenna Factor+ cable loss- preamp factor.
- 2) Margin value = Limits-Emission level.
- 3) -- Mean the PK detector measured value is below average limit.
- 4) The other emission levels were very low against the limit.
- 5) RBW1MHz VBW3MHz Peak detector is for PK value; RBW 1MHz VBW10Hz Peak detector is for AV value.

Results of Band Edges Test (Radiated)

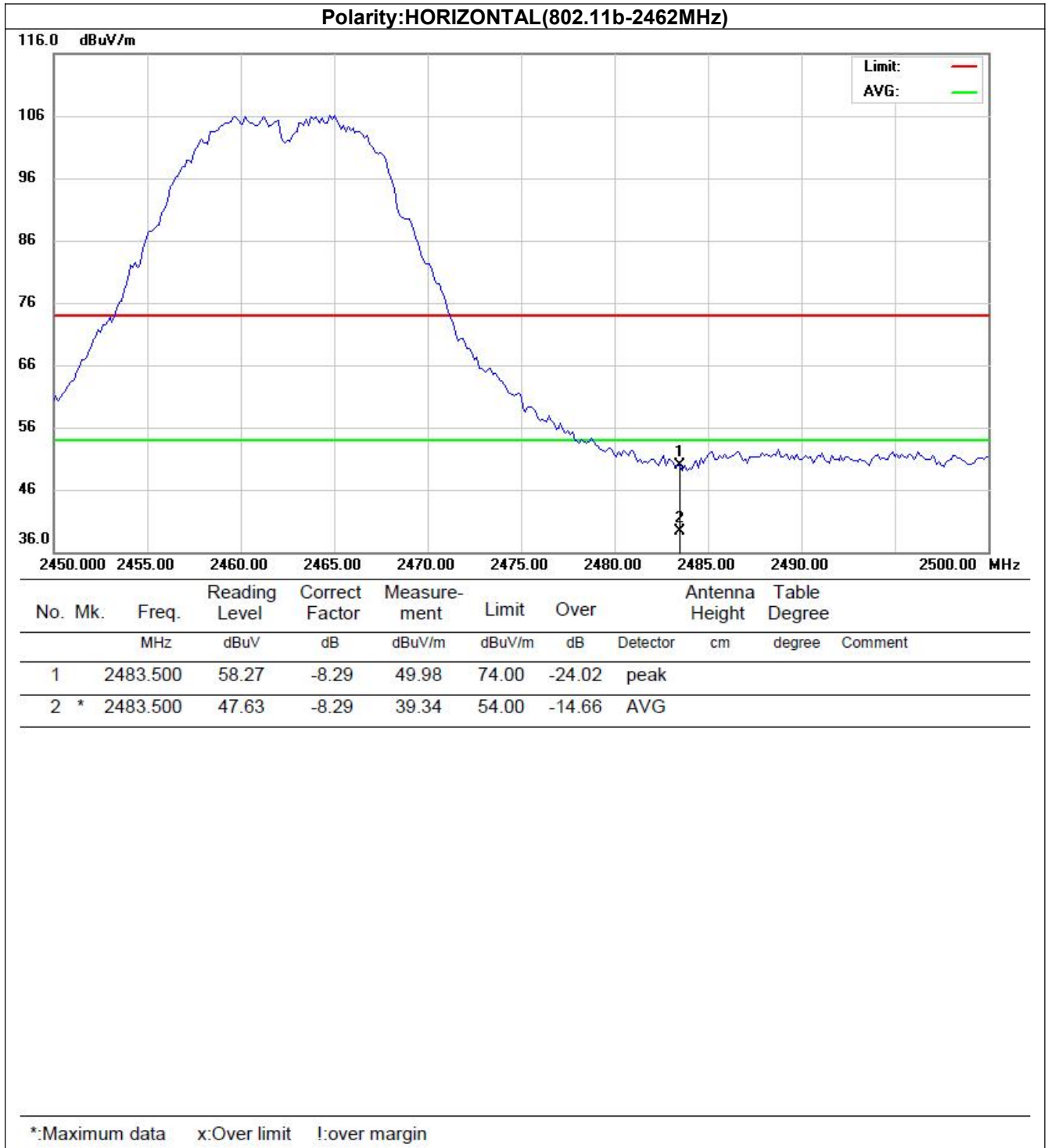

Polarity: VERTICAL(802.11b-2462MHz)

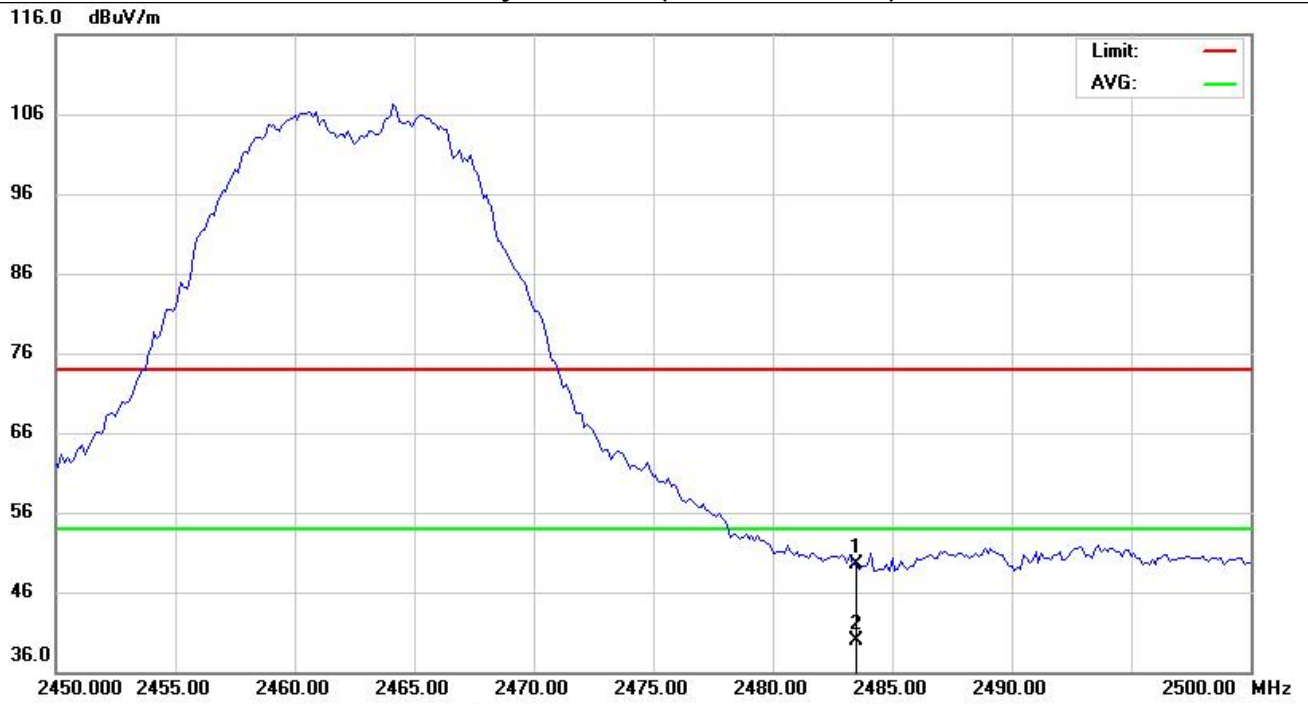

No.	Mk.	Freq. MHz	Reading Level dBuV	Correct Factor dB	Measure- ment dBuV/m	Limit dBuV/m	Over dB	Antenna Height cm	Table Degree degree	Comment
1		2483.500	57.77	-8.29	49.48	74.00	-24.52			peak
2	*	2483.500	48.10	-8.29	39.81	54.00	-14.19			AVG

*:Maximum data x:Over limit !:over margin

Polarity:HORIZONTAL(802.11b-2412MHz)

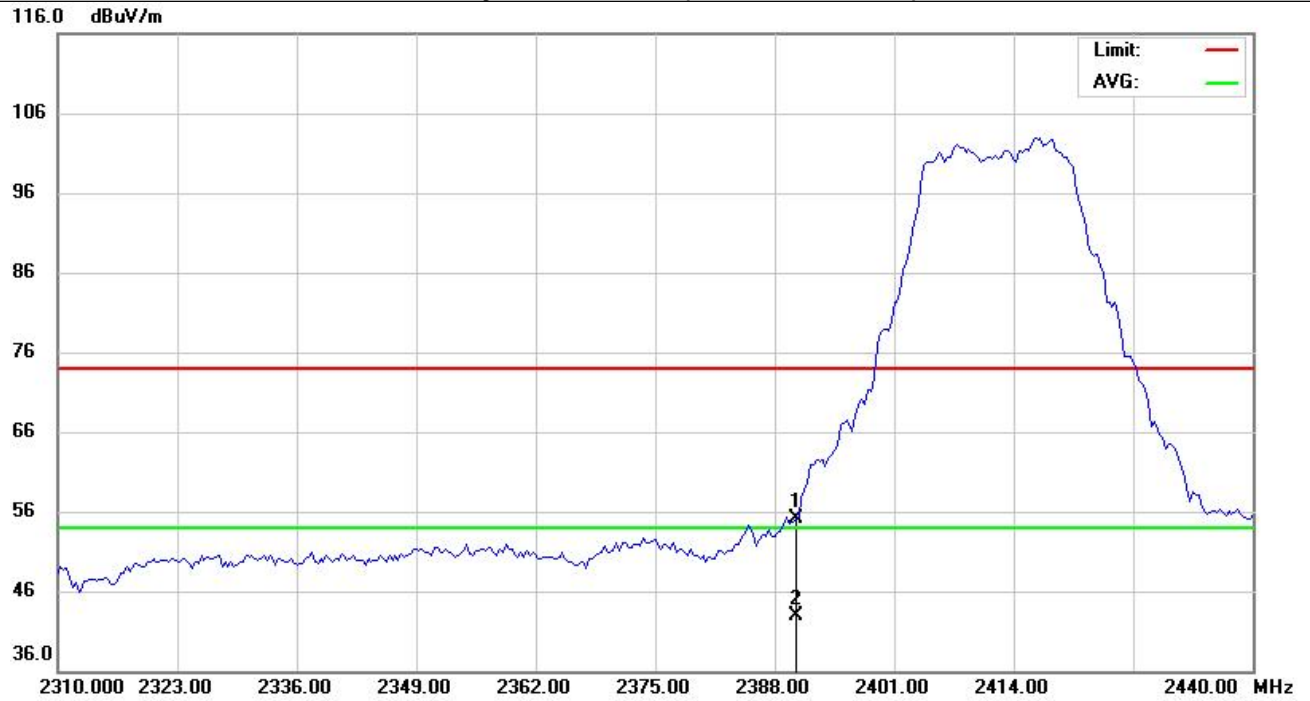

No.	Mk.	Freq. MHz	Reading Level dBuV	Correct Factor dB	Measure- ment dBuV/m	Limit dBuV/m	Over dB	Detector	Antenna Height cm	Table Degree degree	Comment
1		2390.000	63.62	-8.43	55.19	74.00	-18.81	peak			
2	*	2390.000	51.26	-8.43	42.83	54.00	-11.17	AVG			

*:Maximum data x:Over limit !:over margin

Polarity:VERTICAL(802.11b-2412MHz)



No.	Mk.	Freq. MHz	Reading Level dBuV	Correct Factor dB	Measure- ment dBuV/m	Limit dBuV/m	Over dB	Detector	Antenna Height cm	Table Degree	Comment
1		2390.000	65.91	-8.43	57.48	74.00	-16.52	peak			
2	*	2390.000	50.12	-8.43	41.69	54.00	-12.31	AVG			

*:Maximum data x:Over limit !:over margin

Polarity:HORIZONTAL(802.11g-2462MHz)

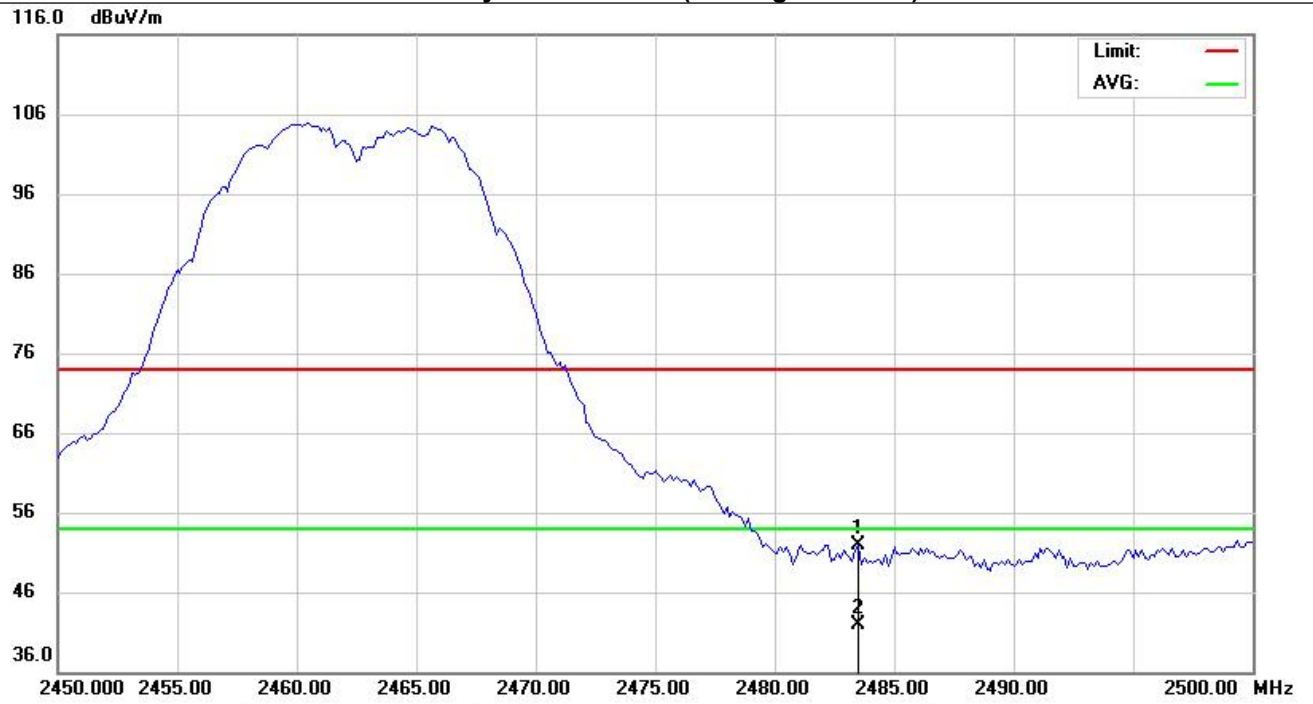

No.	Mk.	Freq. MHz	Reading Level dBuV	Correct Factor dB	Measure- ment dBuV/m	Limit dBuV/m	Over dB	Detector	Antenna Height cm	Table Degree	Comment
1		2483.500	60.27	-8.29	51.98	74.00	-22.02	peak			
2	*	2483.500	50.14	-8.29	41.85	54.00	-12.15	AVG			

*:Maximum data x:Over limit !:over margin

Polarity:VERTICAL(802.11g-2462MHz)

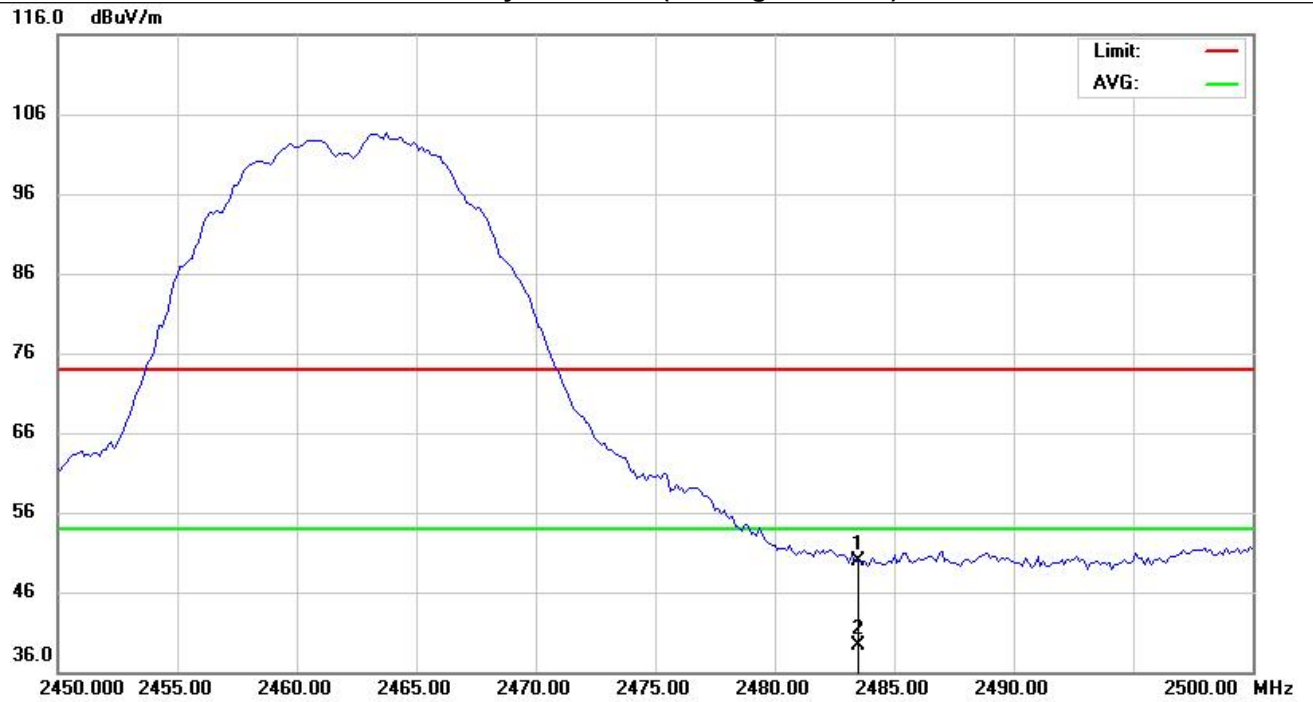

No.	Mk.	Freq. MHz	Reading Level dBuV	Correct Factor dB	Measure- ment dBuV/m	Limit dBuV/m	Over dB	Detector	Antenna Height cm	Table Degree	Comment
1		2483.500	58.27	-8.29	49.98	74.00	-24.02	peak			
2	*	2483.500	47.63	-8.29	39.34	54.00	-14.66	AVG			

*:Maximum data x:Over limit !:over margin

Polarity:HORIZONTAL(802.11g-2412MHz)

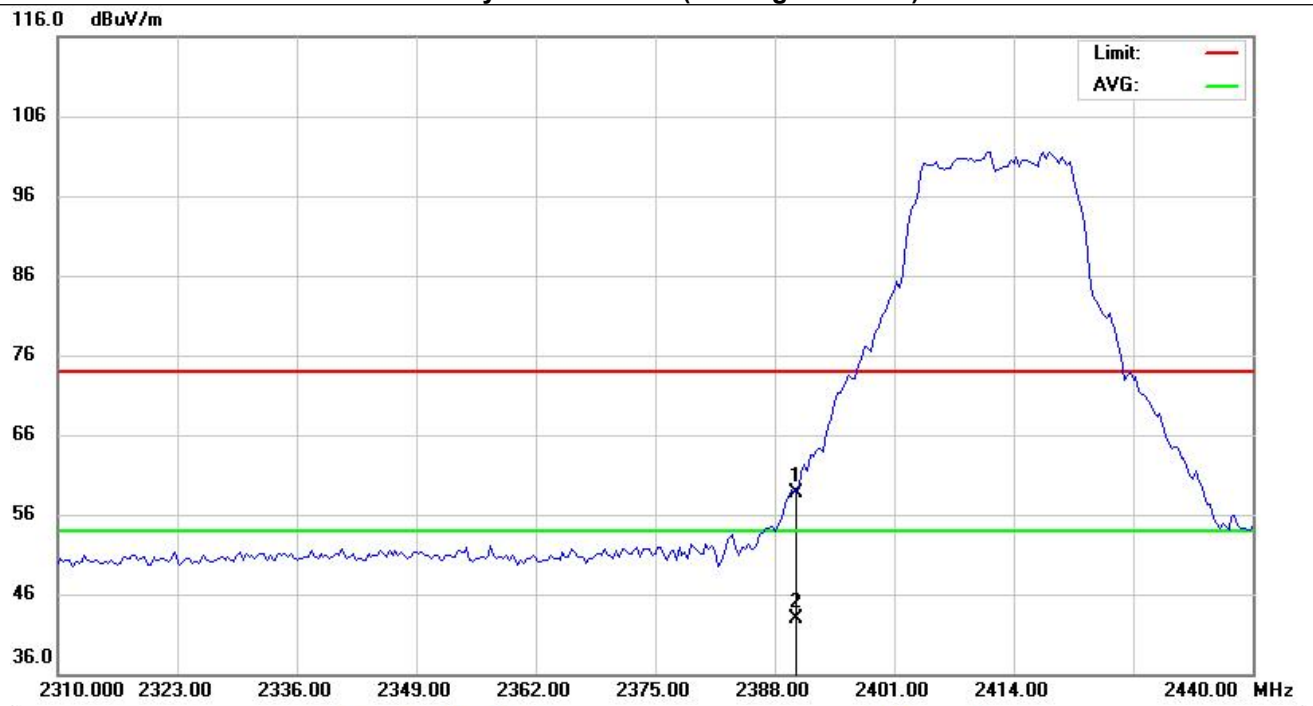

No.	Mk.	Freq. MHz	Reading Level dBuV	Correct Factor dB	Measure- ment dBuV/m	Limit dBuV/m	Over dB	Detector	Antenna Height cm	Table Degree	Comment
1		2390.000	67.12	-8.43	58.69	74.00	-15.31	peak			
2	*	2390.000	51.41	-8.43	42.98	54.00	-11.02	AVG			

*:Maximum data x:Over limit !:over margin

Polarity:VERTICAL(802.11g-2412MHz)

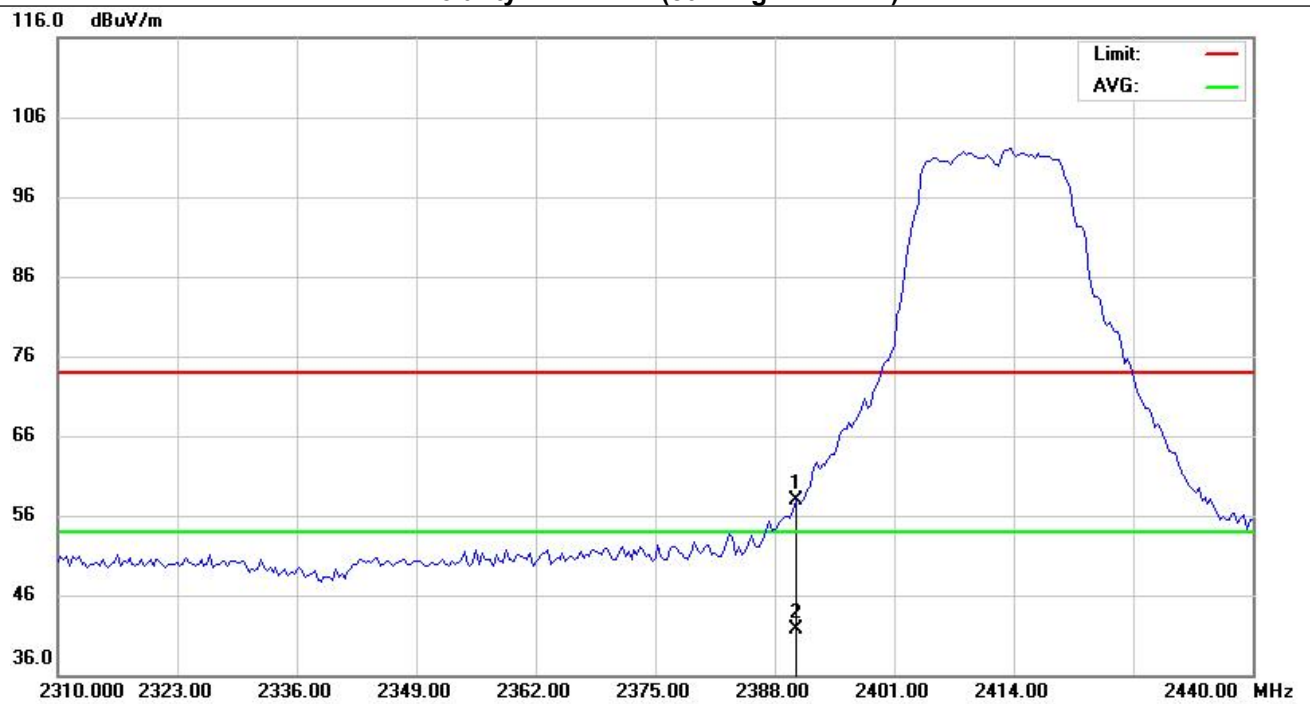

No.	Mk.	Freq. MHz	Reading Level dBuV	Correct Factor dB	Measure- ment dBuV/m	Limit dBuV/m	Over dB	Detector	Antenna Height cm	Table Degree	Comment
1		2390.000	66.41	-8.43	57.98	74.00	-16.02	peak			
2	*	2390.000	50.12	-8.43	41.69	54.00	-12.31	AVG			

*:Maximum data x:Over limit !:over margin

Polarity:HORIZONTAL(802.11n-2462MHz)

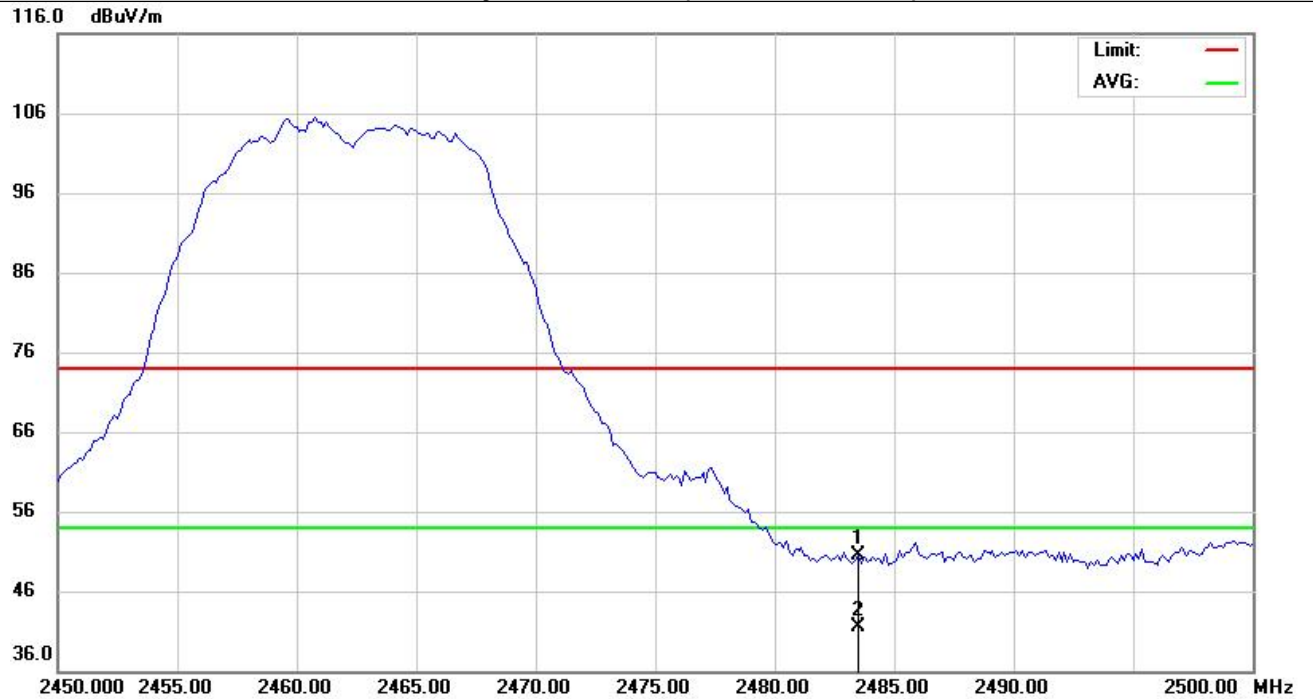

No.	Mk.	Freq. MHz	Reading Level dBuV	Correct Factor dB	Measure- ment dBuV/m	Limit dBuV/m	Over dB	Detector	Antenna Height cm	Table Degree	Comment
1		2483.500	58.77	-8.29	50.48	74.00	-23.52	peak			
2	*	2483.500	49.74	-8.29	41.45	54.00	-12.55	AVG			

*:Maximum data x:Over limit !:over margin

Polarity:VERTICAL(802.11n-2462MHz)



No.	Mk.	Freq. MHz	Reading Level dBuV	Correct Factor dB	Measure- ment dBuV/m	Limit dBuV/m	Over dB	Detector	Antenna Height cm	Table Degree	Comment
1		2483.500	58.27	-8.29	49.98	74.00	-24.02	peak			
2	*	2483.500	49.04	-8.29	40.75	54.00	-13.25	AVG			

*:Maximum data x:Over limit !:over margin

Polarity:HORIZONTAL(802.11n-2412MHz)

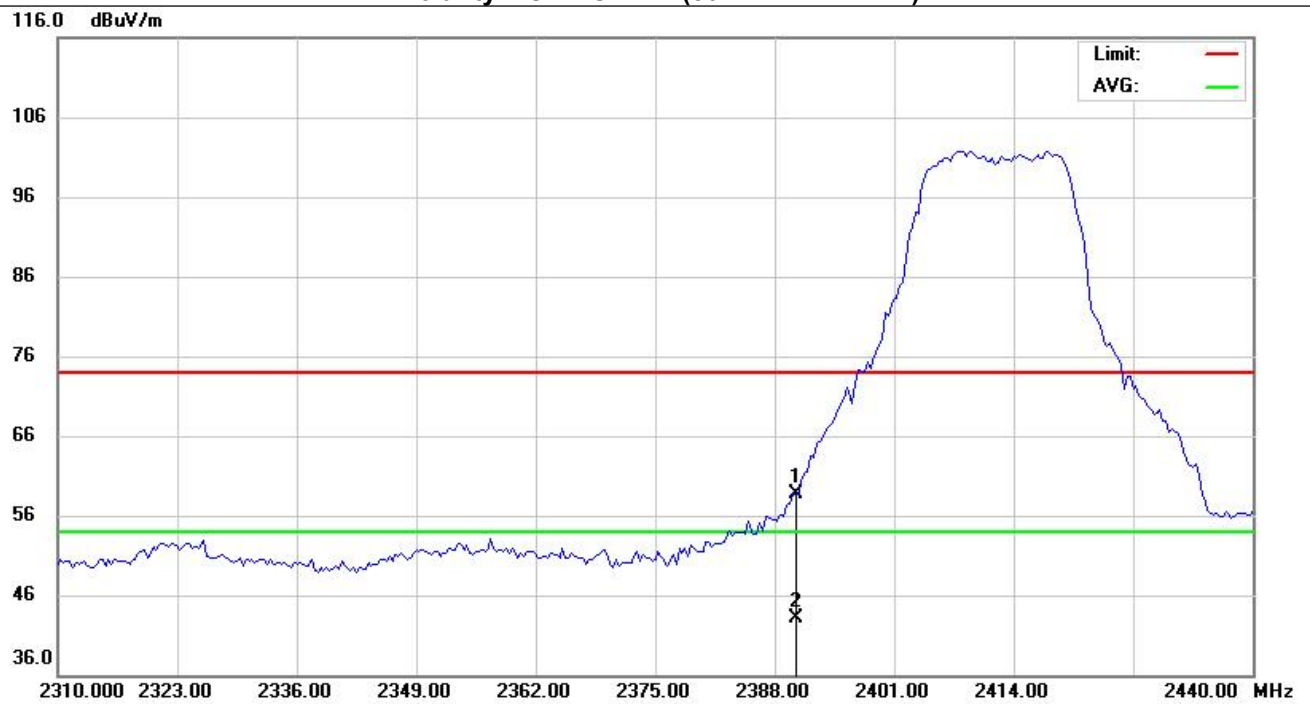

No.	Mk.	Freq. MHz	Reading Level dBuV	Correct Factor dB	Measure- ment dBuV/m	Limit dBuV/m	Over dB	Antenna Height cm	Table Degree degree	Comment
1		2390.000	67.12	-8.43	58.69	74.00	-15.31			peak
2	*	2390.000	51.47	-8.43	43.04	54.00	-10.96			AVG

*:Maximum data x:Over limit !:over margin

Polarity: VERTICAL (802.11n-2412MHz)

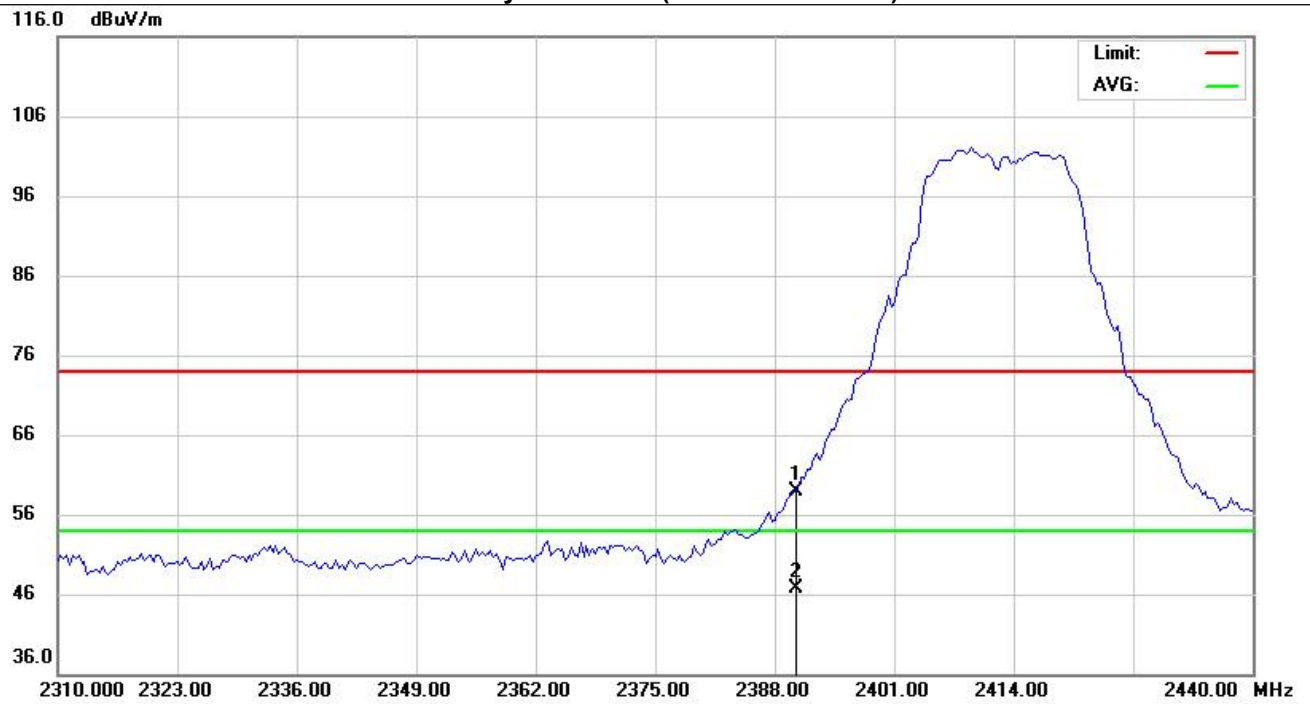

No.	Mk.	Freq. MHz	Reading Level dBuV	Correct Factor dB	Measure- ment dBuV/m	Limit dBuV/m	Over dB	Detector	Antenna Height cm	Table Degree degree	Comment
1		2390.000	67.41	-8.43	58.98	74.00	-15.02	peak			
2	*	2390.000	55.10	-8.43	46.67	54.00	-7.33	AVG			

*:Maximum data x:Over limit !:over margin

Polarity:HORIZONTAL(802.11n40-2452MHz)

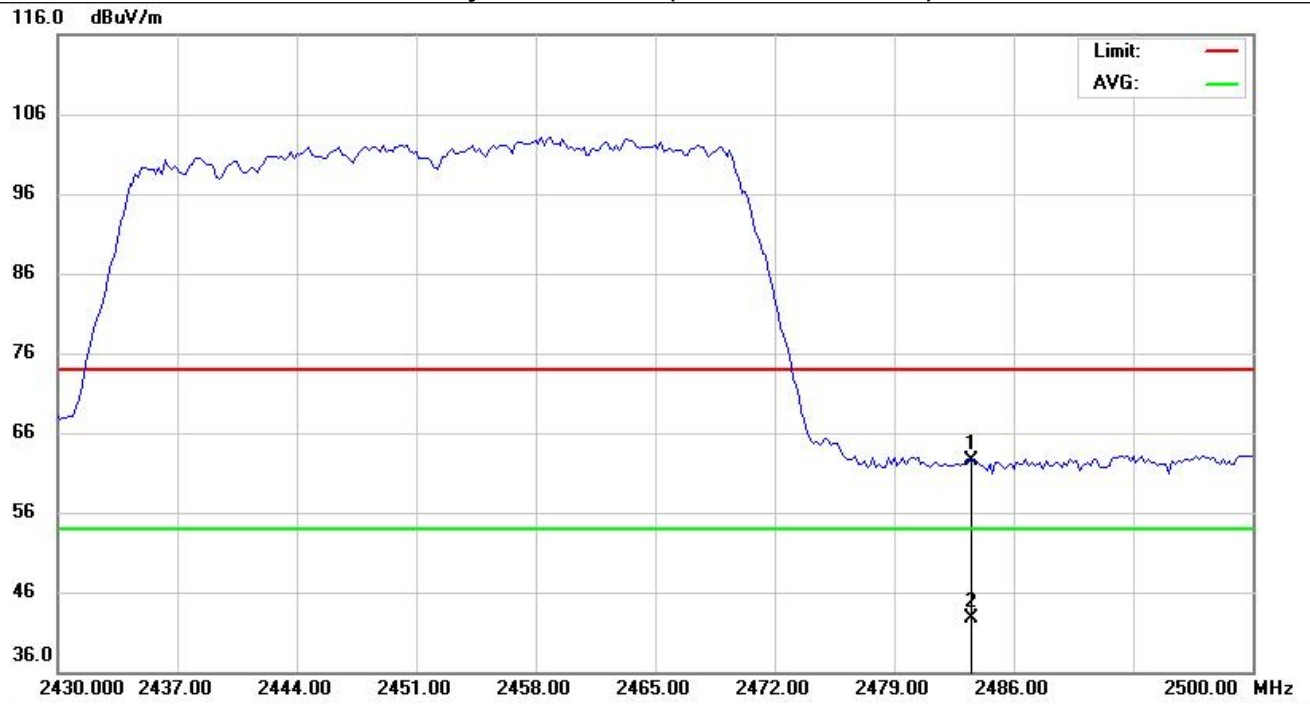

No.	Mk.	Freq. MHz	Reading Level dBuV	Correct Factor dB	Measure- ment dBuV/m	Limit dBuV/m	Over dB	Detector	Antenna Height cm	Table Degree	Comment
1		2483.500	70.75	-8.29	62.46	74.00	-11.54	peak			
2	*	2483.500	51.03	-8.29	42.74	54.00	-11.26	AVG			

*:Maximum data x:Over limit !:over margin

Polarity:VERTICAL(802.11n40-2452MHz)



No.	Mk.	Freq. MHz	Reading Level dBuV	Correct Factor dB	Measure- ment dBuV/m	Limit dBuV/m	Over dB	Detector	Antenna Height cm	Table Degree	Comment
1		2483.500	69.22	-8.29	60.93	74.00	-13.07	peak			
2	*	2483.500	55.23	-8.29	46.94	54.00	-7.06	AVG			

*:Maximum data x:Over limit !:over margin

Polarity:HORIZONTAL(802.11n40-2422MHz)

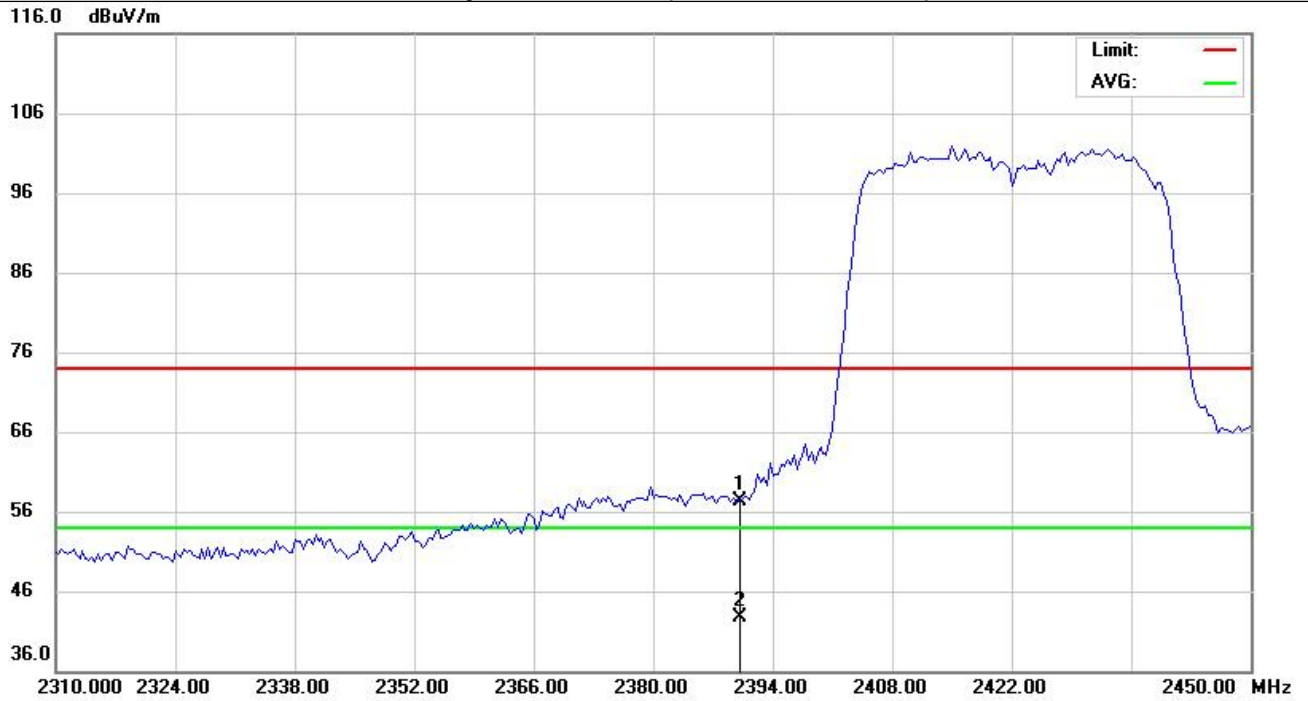

No.	Mk.	Freq. MHz	Reading Level dBuV	Correct Factor dB	Measure- ment dBuV/m	Limit dBuV/m	Over dB	Detector	Antenna Height cm	Table Degree	Comment
1		2390.000	65.69	-8.43	57.26	74.00	-16.74	peak			
2	*	2390.000	51.23	-8.43	42.80	54.00	-11.20	AVG			

*:Maximum data x:Over limit !:over margin

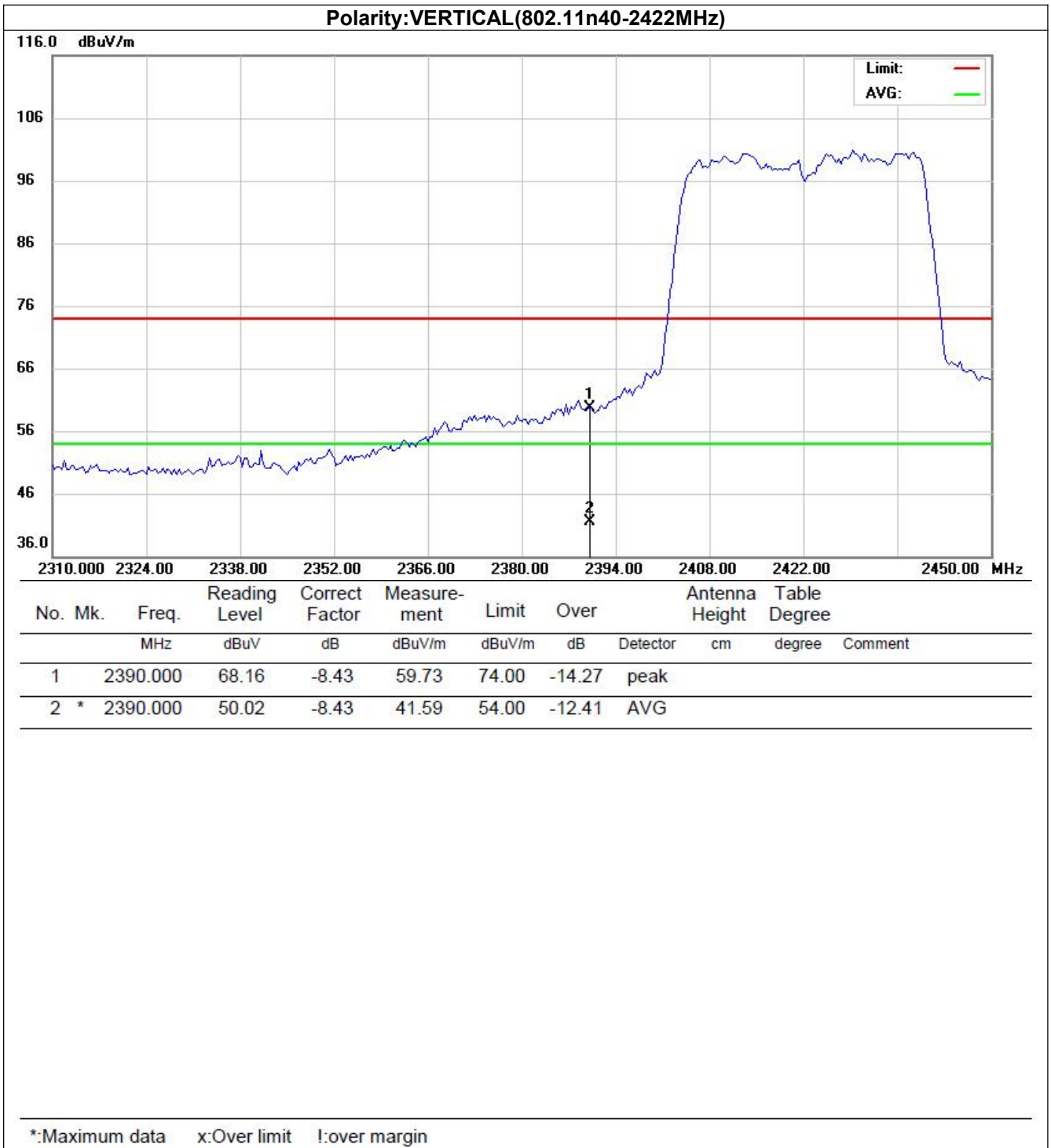

5.3 Maximum Conducted Output Power

Limit

The Maximum Peak Output Power Measurement is 30dBm.

Test Procedure

Remove the antenna from the EUT and then connect a low loss RF cable from the antenna port to the power sensor.

Test Configuration

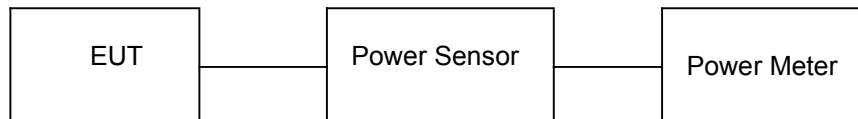

Test Results

See Appendix I

5.4 Power Spectral Density

Limit

For digitally modulated systems, the power spectral density conducted from the intentional radiator to the antenna shall not be greater than 8 dBm in any 3 kHz band during any time interval of continuous transmission.

Test Procedure

1. Use this procedure when the maximum peak conducted output power in the fundamental emission is used to demonstrate compliance.
2. Set the RBW \geq 3 kHz.
3. Set the VBW \geq 3 \times RBW.
4. Set the span to 1.5 times the DTS channel bandwidth.
5. Detector = peak.
6. Sweep time = auto couple.
7. Trace mode = max hold.
8. Allow trace to fully stabilize.
9. Use the peak marker function to determine the maximum power level.
10. If measured value exceeds limit, reduce RBW (no less than 3 kHz) and repeat.
11. The resulting peak PSD level must be 8dBm.

Test Configuration



Test Results

See APPENDIX VI

5.5 6dB Bandwidth

Limit

For digital modulation systems, the minimum 6 dB bandwidth shall be at least 500 kHz

Test Procedure

The transmitter output was connected to the spectrum analyzer through an attenuator. The bandwidth of the fundamental frequency was measured by spectrum analyzer with 100 KHz RBW and 300 KHz VBW. The 6dB bandwidth is defined as the total spectrum the power of which is higher than peak power minus 6dB.

Test Configuration



Test Results

See APPENDIX III

5.6 Out-of-band Emissions

Limit

In any 100 kHz bandwidth outside the frequency band in which the spread spectrum or digitally modulated intentional radiator is operating, the radio frequency power that is produced by the intentional radiator shall be at least 20 dB below that in the 100 kHz bandwidth within the band that contains the highest level of the desired power, based on either an RF conducted or a radiated measurement, provided the transmitter demonstrates compliance with the peak conducted power limits. If the transmitter complies with the conducted power limits based on the use of RMS averaging over a time interval, as permitted under paragraph (b)(3) of this section, the attenuation required under this paragraph shall be 30 dB instead of 20 dB. Attenuation below the general limits specified in §15.209(a) is not required.

Test Procedure

Connect the transmitter output to spectrum analyzer using a low loss RF cable, and set the spectrum analyzer to RBW=100 kHz, VBW= 300 kHz, peak detector, and max hold. Measurements utilizing these settings are made of the in-band reference level, band edge and out-of-band emissions.

Test Configuration



Test Results

See APPENDIX IV

5.7 Duty Cycle Information

See APPENDIX V

5.8 Antenna Requirement

Standard Applicable

For intentional device, according to FCC 47 CFR Section 15.203:

An intentional radiator shall be designed to ensure that no antenna other than that furnished by the responsible party shall be used with the device. The use of a permanently attached antenna or of an antenna that uses a unique coupling to the intentional radiator, the manufacturer may design the unit so that a broken antenna can be replaced by the user, but the use of a standard antenna jack or electrical connector is prohibited

FCC CFR Title 47 Part 15 Subpart C Section 15.247(c) (1) (I):

(i) Systems operating in the 2400-2483.5 MHz band that is used exclusively for fixed. Point-to-point operations may employ transmitting antennas with directional gain greater than 6dBi provided the maximum conducted output power of the intentional radiator is reduced by 1 dB for every 3 dB that the directional gain of the antenna exceeds 6dBi.

Test Result:

The directional gains of antenna used for transmitting is -3.45dBi, and the antenna is an internal monopole antenna and no consideration of replacement. Please see EUT photo for details.

Results: Compliance.

6 Test Setup Photos of the EUT

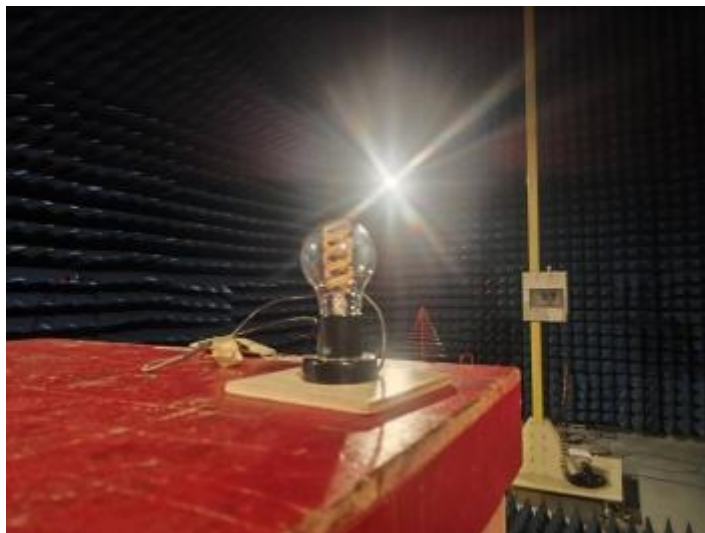

7 Photos of the EUT

See related photo report.