

FCC- TEST REPORT

Report Number : **68.950.19.0529.01** Date of Issue: June 18, 2019

Model : **7B-GW-BWA-H0-01**

Product Type : Mini Gateway

Applicant : LEEDARSON LIGHTING CO., LTD

Address : Xingda Road, Xingtai Industrial Zone, Changtai County, Zhangzhou,
Fujian, China

Production Facility : LEEDARSON LIGHTING CO., LTD

Address : Xingda Road, Xingtai Industrial Zone, Changtai County, Zhangzhou,
Fujian, China

Test Result : **Positive** **Negative**

Total pages including Appendices : 49

TÜV SÜD Certification and Testing (China) Co., Ltd. Shenzhen Branch is a subcontractor to TÜV SÜD Product Service GmbH according to the principles outlined in ISO 17025.

TÜV SÜD Certification and Testing (China) Co., Ltd. Shenzhen Branch reports apply only to the specific samples tested under stated test conditions. Construction of the actual test samples has been documented. It is the manufacturer's responsibility to assure that additional production units of this model are manufactured with identical electrical and mechanical components. The manufacturer/importer is responsible to the Competent Authorities in Europe for any modifications made to the production units which result in non-compliance to the relevant regulations. TÜV SÜD Certification and Testing (China) Co., Ltd. Shenzhen Branch shall have no liability for any deductions, inferences or generalizations drawn by the client or others from TÜV SÜD Certification and Testing (China) Co., Ltd. Shenzhen Branch issued reports.

This report is the confidential property of the client. As a mutual protection to our clients, the public and ourselves, extracts from the test report shall not be reproduced except in full without our written approval.



1 Table of Contents

1	Table of Contents.....	2
2	Details about the Test Laboratory	3
3	Description of the Equipment under Test	4
4	Summary of Test Standards.....	5
5	Summary of Test Results	6
6	General Remarks.....	7
7	Test Setups.....	8
8	Systems test configuration	9
9	Technical Requirement.....	10
9.1	Conducted Emission	10
9.2	Conducted peak output power.....	13
9.3	6dB and 99% bandwidth	15
9.4	Power spectral density.....	20
9.5	Spurious RF conducted emissions	25
9.6	Spurious radiated emissions for transmitter	39
10	Test Equipment List.....	48
11	System Measurement Uncertainty	49

2 Details about the Test Laboratory

Details about the Test Laboratory

Test Site 1

Company name: TÜV SÜD Certification and Testing (China) Co., Ltd. Shenzhen Branch
Building 12&13, Zhiheng Wisdomland Business Park,
Nantou Checkpoint Road 2, Nanshan District,
Shenzhen City, 518052,
P. R. China

FCC Registration Number: 514049

Telephone: 86 755 8828 6998
Fax: 86 755 8828 5299

3 Description of the Equipment under Test

Description of the Equipment Under Test

Product:	Mini Gateway
Model no.:	7B-GW-BWA-H0-01
FCC ID:	2AB2Q-7BGWBWAH0
Options and accessories:	NIL
Rated Input:	5VDC, 1A
Adapter:	Input: 100-240VAC, 50/60Hz, 0.2A Output: 5VDC, 1A
RF Transmission Frequency:	2412-2462MHz
No. of Operated Channel:	11
Modulation:	CCK, DQPSK, DBPSK for 802.11b QPSK,BPSK for 802.11g/n
Duty Cycle:	100%
Antenna Type:	Integral Antenna
Antenna Gain:	2dBi
Description of the EUT:	The Equipment Under Test (EUT) is a Mini Gateway supports 2.4GHz WI-FI function.



4 Summary of Test Standards

Test Standards	
FCC Part 15 Subpart C 10-1-2018 Edition	PART 15 - RADIO FREQUENCY DEVICES Subpart C - Intentional Radiators

All the test methods were according to KDB558074 D01 DTS Meas Guidance v05r02 and ANSI C63.10 (2013).

5 Summary of Test Results

Technical Requirements				
FCC Part 15 Subpart C				
Test Condition		Pages	Test Result	Test Site
§15.207	Conducted emission AC power port	---	N/A	--
§15.247(b)(1)	Conducted peak output power	13	Pass	Site 1
§15.247(e)	Power spectral density*	20	Pass	Site 1
§15.247(a)(2)	6dB bandwidth	15	Pass	Site 1
§15.247(a)(1)	Carrier frequency separation	--	N/A	--
§15.247(a)(1)(iii)	Number of hopping frequencies	--	N/A	--
§15.247(a)(1)(iii)	Dwell Time	--	N/A	--
§15.247(d)	Spurious RF conducted emissions	25	Pass	Site 1
§15.247(d)	Band edge	38	Pass	Site 1
§15.247(d) & §15.209 & §15.203	Spurious radiated emissions for transmitter	42	Pass	Site 1
§15.203	Antenna requirement	See note 2	Pass	--

Remark 1: N/A – Not Applicable.

Note 1: The EUT uses an Integrated Metal Antenna 2.0dBi max. According to §15.203, it is considered sufficiently to comply with the provisions of this section.

6 General Remarks

Remarks

This submittal(s) (test report) is intended for FCC ID: 2AB2Q-7BGWBWAH0 complies with Section 15.207, 15.209, 15.205, 15.247 of the FCC Part 15, Subpart C rules.

SUMMARY:

All tests according to the regulations cited on page 5 were

- Performed

- **Not** Performed

The Equipment under Test

- **Fulfills** the general approval requirements.

- **Does not** fulfill the general approval requirements.

Sample Received Date: March 22, 2019

Testing Start Date: March 22, 2019

Testing End Date: March 25, 2019

- TÜV SÜD Certification and Testing (China) Co., Ltd. Shenzhen Branch -

Reviewed by:

Prepared by:

Tested by:

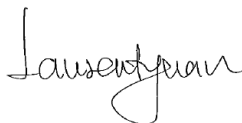

Laurent Yuan
EMC Project Manager



Henry Chen
EMC Project Engineer



Louise Liu
EMC Test Engineer

7 Test Setups

7.1 Radiated test setups

Below 1GHz

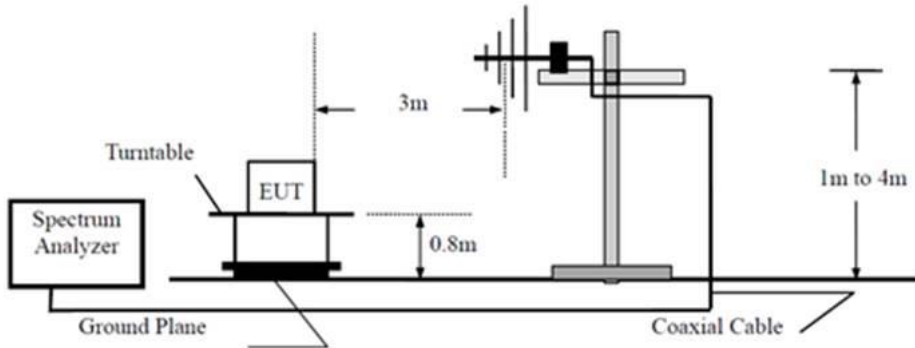

Above 1GHz

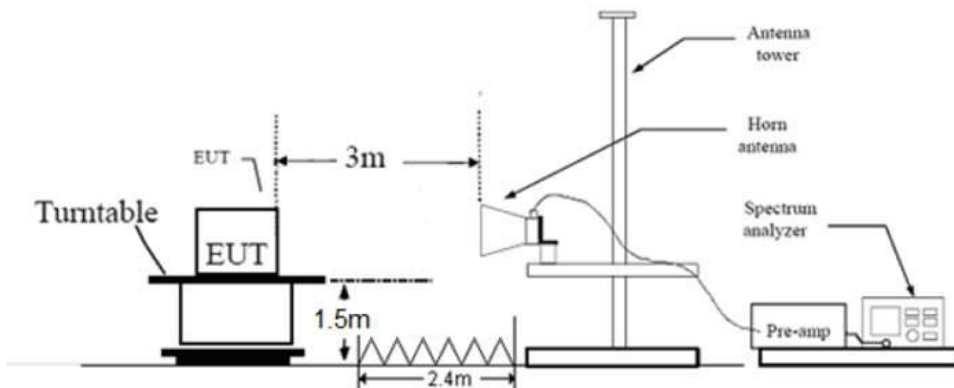

7.2 Conducted RF test setups

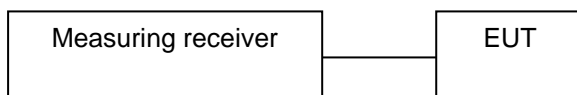

7.3 AC Power Line Conducted Emission test setups

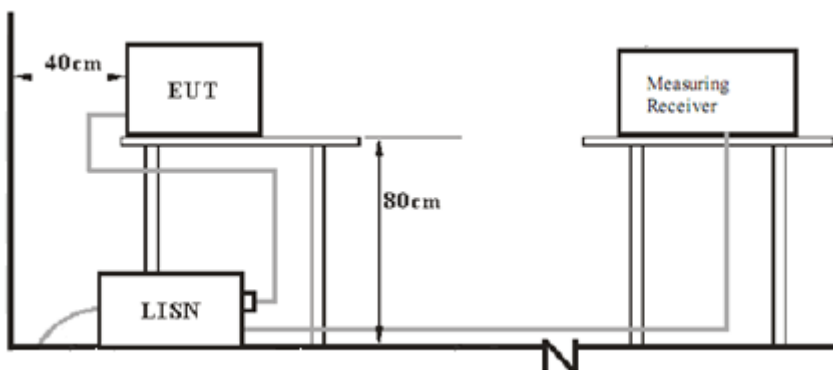

8 Systems test configuration

Auxiliary Equipment Used during Test:

DESCRIPTION	MANUFACTURER	MODEL NO.	S/N
---	---	---	---

Test software information:

Test Software Version	UI_mptool	
Modulation	Setting TX Power	Packet Type
802.11b	42	---
802.11g	46	---
802.11nHT20	46	---
802.11Nht40	46	---

The system was configured to channel 1, 6 and 11 for the test.

9 Technical Requirement

9.1 Conducted Emission

Test Method

1. The EUT was placed on a table, which is 0.8m above ground plane
2. The power line of the EUT is connected to the AC mains through an Artificial Mains Network (A.M.N.).
3. Maximum procedure was performed to ensure EUT compliance
4. A EMI test receiver is used to test the emissions from both sides of AC line

Limit

Frequency MHz	QP Limit dB μ V	AV Limit dB μ V
0.150-0.500	66-56*	56-46*
0.500-5	56	46
5-30	60	50

Note: “*” means Decreasing line;

Conducted Emission

Product Type : Mini Gateway
 M/N : 7B-GW-BWA-H0-01
 Operating Condition : Normal working with transmitting
 Test Specification : Power Line, Live
 Comment : AC 120V/60Hz

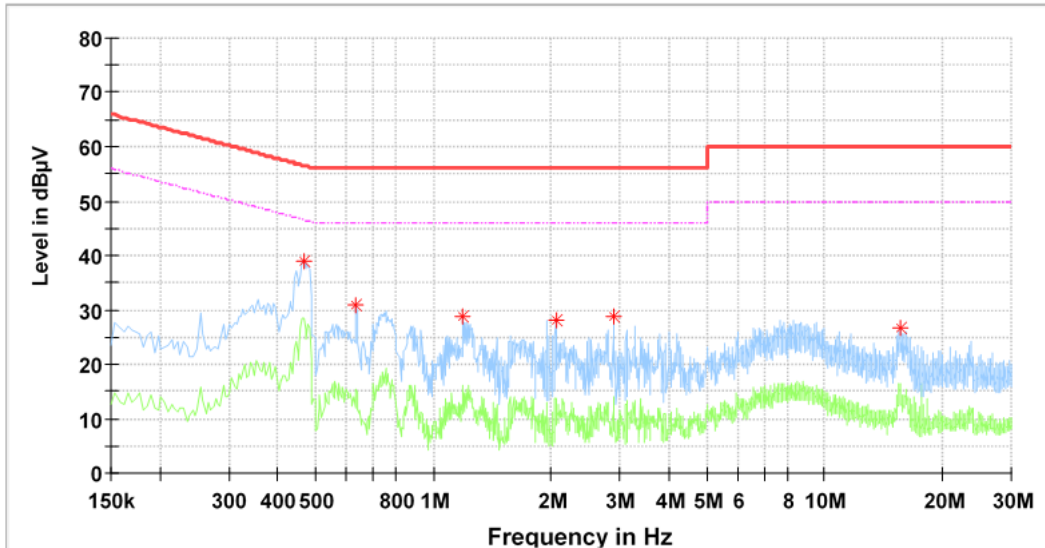

Critical Freqs

Frequency (MHz)	MaxPeak (dBµV)	Average (dBµV)	Limit (dBµV)	Margin (dB)	Line	Corr. (dB)
0.466000	39.05	---	56.58	17.53	L1	10.3
0.634000	30.75	---	56.00	25.25	L1	10.3
1.194000	28.62	---	56.00	27.38	L1	10.3
2.054000	28.07	---	56.00	27.93	L1	10.3
2.890000	28.65	---	56.00	27.35	L1	10.3
15.570000	26.74	---	60.00	33.26	L1	10.8

Remark :

Level=Reading Level + Correction Factor

Correction Factor=Cable Loss + LISN Factor

(The Reading Level is recorded by software which is not shown in the sheet)

Conducted Emission

Product Type : Mini Gateway
 M/N : 7B-GW-BWA-H0-01
 Operating Condition : Normal working with transmitting
 Test Specification : Power Line, Neutral
 Comment : AC 120V/60Hz

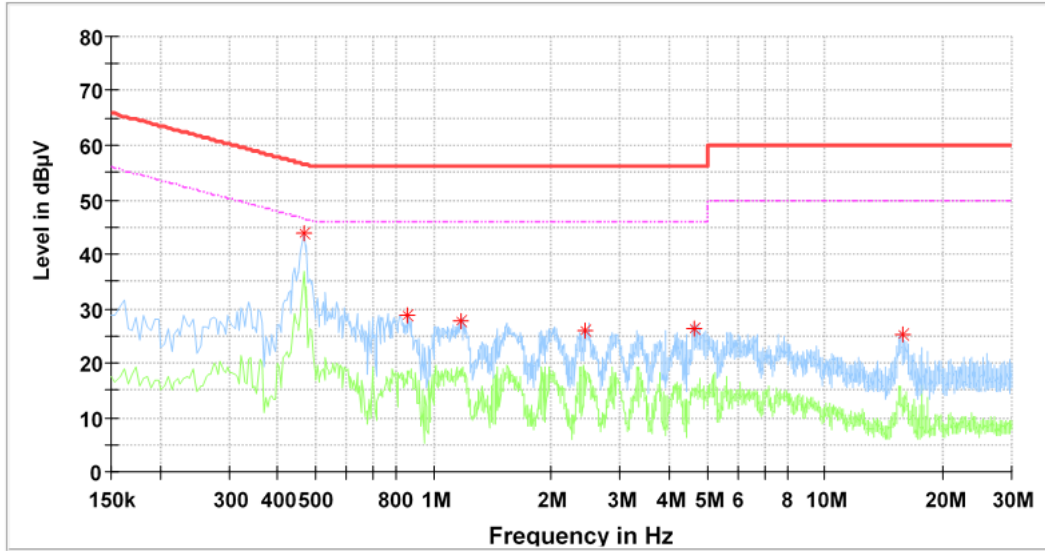

Critical Freqs

Frequency (MHz)	MaxPeak (dBµV)	Average (dBµV)	Limit (dBµV)	Margin (dB)	Line	Corr. (dB)
0.466000	44.03	---	56.58	12.56	N	10.3
0.858000	28.71	---	56.00	27.29	N	10.3
1.170000	27.83	---	56.00	28.17	N	10.3
2.446000	26.02	---	56.00	29.98	N	10.3
4.622000	26.20	---	56.00	29.80	N	10.4
15.750000	25.44	---	60.00	34.56	N	10.9

Remark :

Level=Reading Level + Correction Factor

Correction Factor=Cable Loss + LISN Factor

(The Reading Level is recorded by software which is not shown in the sheet)

9.2 Conducted peak output power

Test Method

1. Connect the power meter to the EUT
 - a) The EUT is configured to transmit continuously, or to transmit with a constant duty factor.
 - b) At all times the EUT is transmitting at its maximum power control level.
 - c) The integration period of the power meter exceeds the repetition period of the transmitted signal by at least a factor of five.
2. Measure the average power of the transmitter. This measurement is an average over both the on and off periods of the transmitter.
3. Adjust the measurement in dBm by adding $10\log(1/x)$, where x is the duty cycle to the measurement result.

Limits

According to §15.247 (b) (1), conducted peak output power limit as below:

Frequency Range MHz	Limit W	Limit dBm
2400-2483.5	≤1	≤30

Test result

802.11b

Frequency MHz	Conducted Peak Output Power dBm	Result
Top channel 2412MHz	15.0	Pass
Middle channel 2437MHz	15.1	Pass
Bottom channel 2462MHz	13.9	Pass

802.11g

Frequency MHz	Conducted Peak Output Power dBm	Result
Top channel 2412MHz	10.6	Pass
Middle channel 2437MHz	10.7	Pass
Bottom channel 2462MHz	9.6	Pass

802.11nHT20

Frequency MHz	Conducted Peak Output Power dBm	Result
Top channel 2412MHz	10.6	Pass
Middle channel 2437MHz	10.7	Pass
Bottom channel 2462MHz	9.4	Pass

802.11nHT40

Frequency MHz	Conducted Peak Output Power dBm	Result
Top channel 2422MHz	10.7	Pass
Middle channel 2437MHz	10.6	Pass
Bottom channel 2452MHz	10.0	Pass

9.3 6dB bandwidth

Test Method

1. Use the following spectrum analyzer settings:
RBW=100K, VBW \geq 3RBW, Sweep = auto, Detector function = peak, Trace = max hold
2. Use the automatic bandwidth measurement capability of an instrument, may be employed using the X dB bandwidth mode with X set to 6 dB, care shall be taken so that the bandwidth measurement is not influenced by any intermediate power nulls in the fundamental emission that might be \geq 6 dB.
3. Allow the trace to stabilize, record the X dB Bandwidth value.

Limit

Limit [kHz]

≥ 500

Test result

802.11b

Frequency MHz	6dB bandwidth MHz	Result
Bottom channel 2412MHz	9.160	Pass
Middle channel 2437MHz	9.160	Pass
Top channel 2462MHz	9.160	Pass

802.11g

Frequency MHz	6dB bandwidth MHz	Result
Bottom channel 2412MHz	16.640	Pass
Middle channel 2437MHz	16.640	Pass
Top channel 2462MHz	16.640	Pass

802.11nHT20

Frequency MHz	6dB bandwidth MHz	Result
Bottom channel 2412MHz	17.800	Pass
Middle channel 2437MHz	17.800	Pass
Top channel 2462MHz	17.800	Pass

802.11nHT40

Frequency MHz	6dB bandwidth MHz	Result
Bottom channel 2422MHz	36.560	Pass
Middle channel 2437MHz	36.640	Pass
Top channel 2452MHz	36.560	Pass

Test Graphs

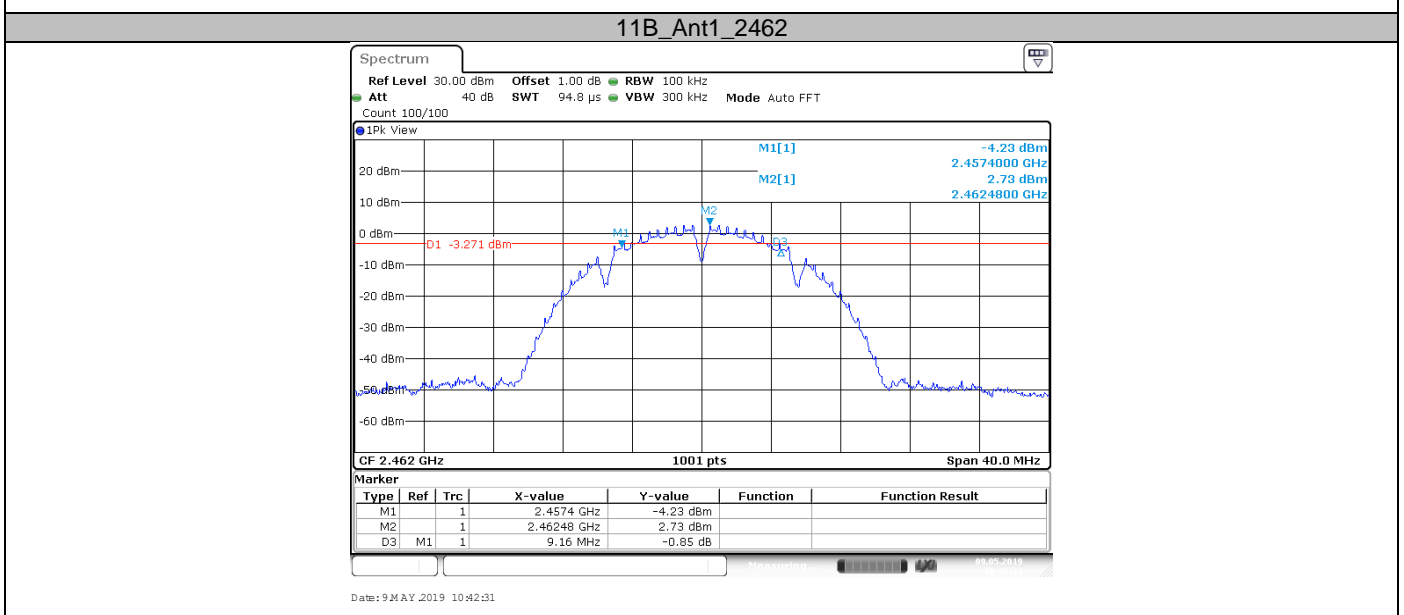
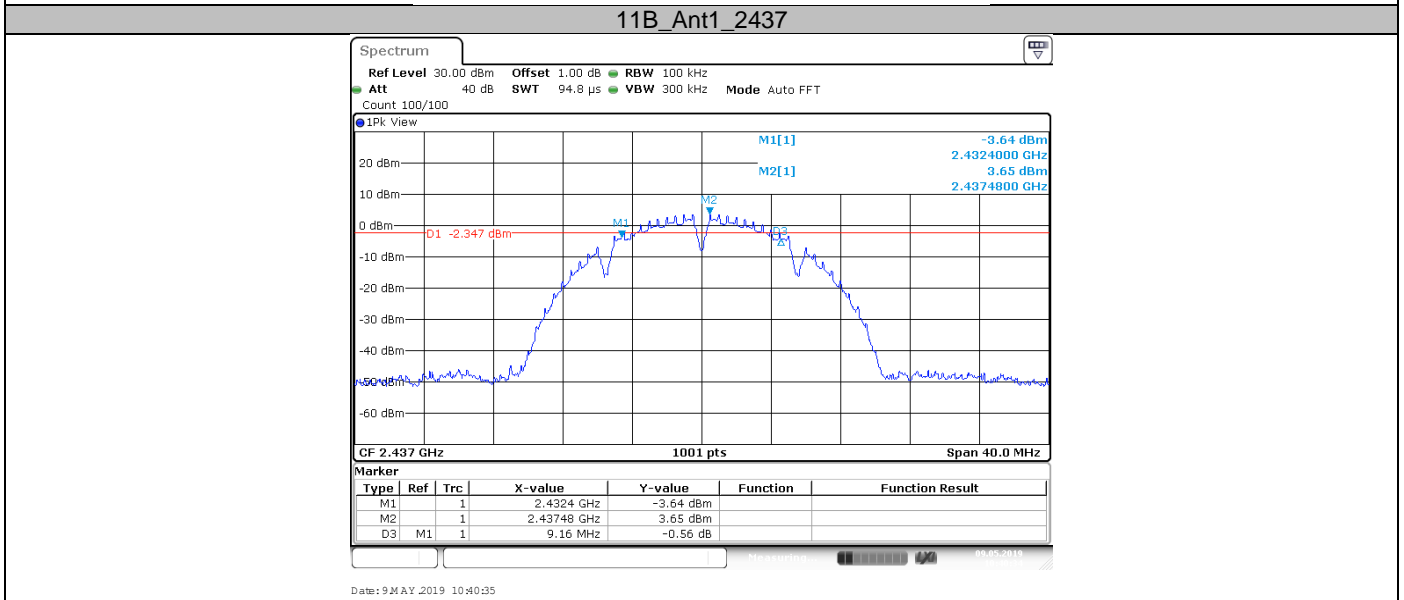
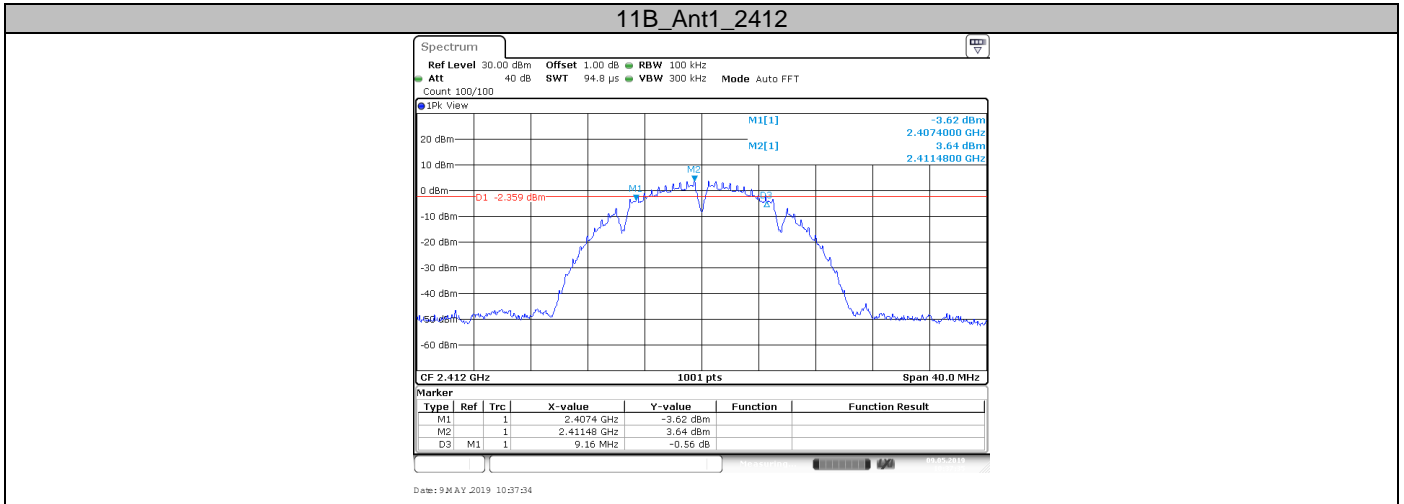

11G_Ant1_2412

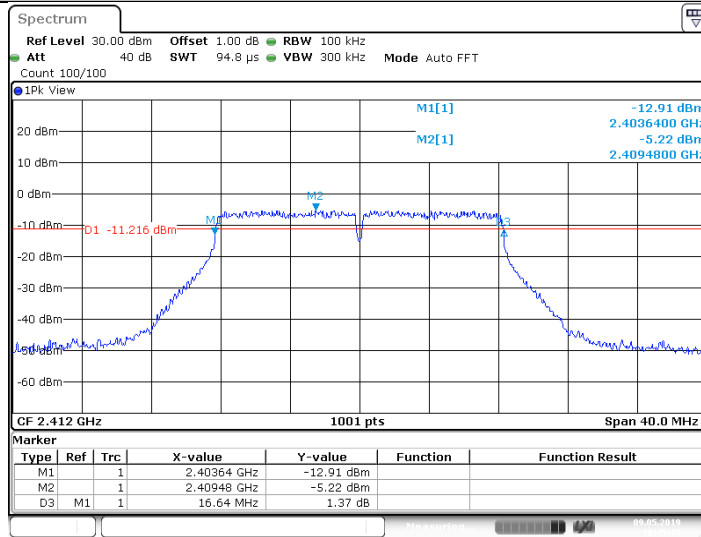

Date: 9 MAY 2019 10:45:44

11G_Ant1_2437

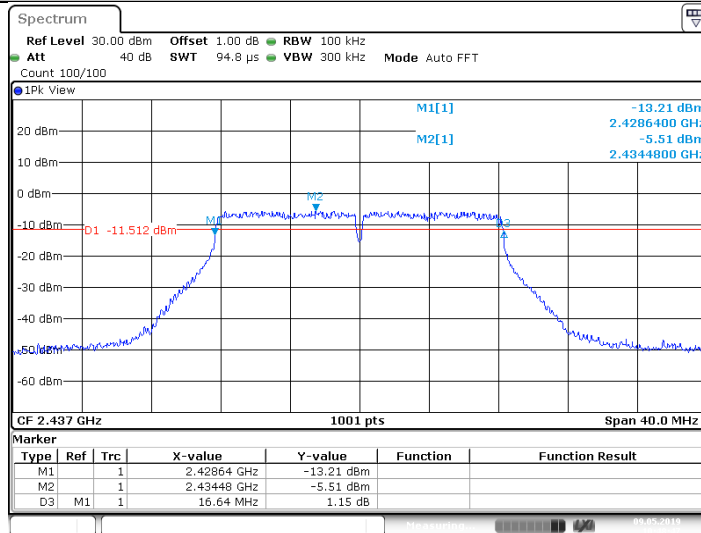

Date: 9 MAY 2019 10:48:47

11G_Ant1_2462

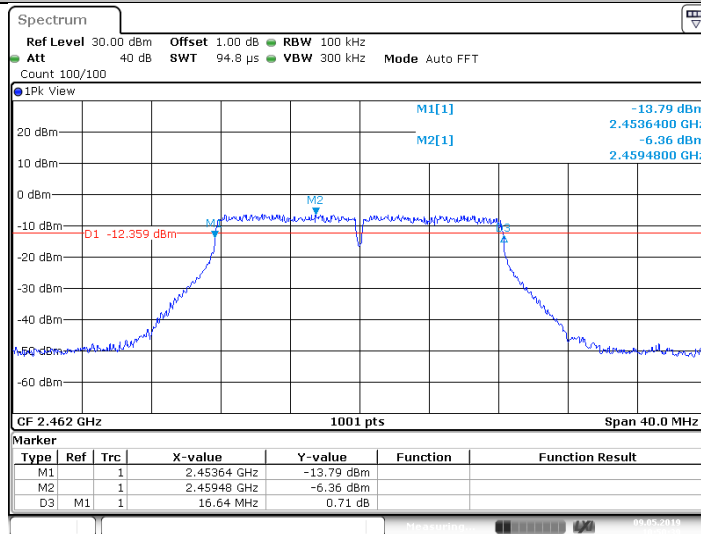

Date: 9 MAY 2019 10:50:40

11N20SISO_Ant1_2412

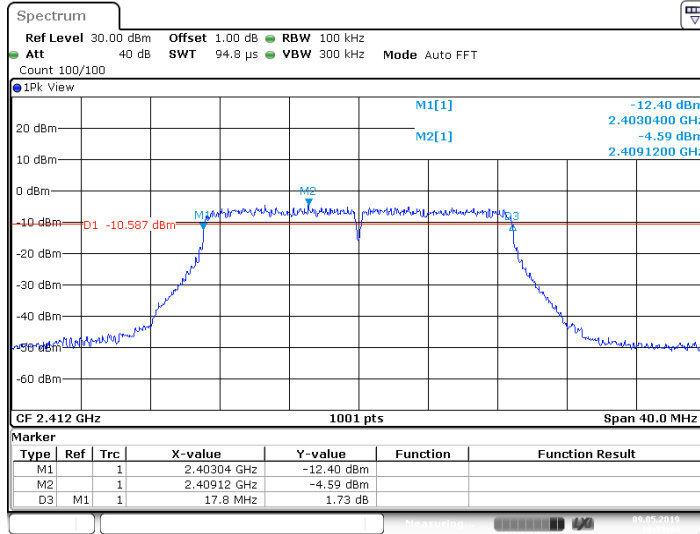

Date: 9 MAY 2019 10:53:45

11N20SISO_Ant1_2437

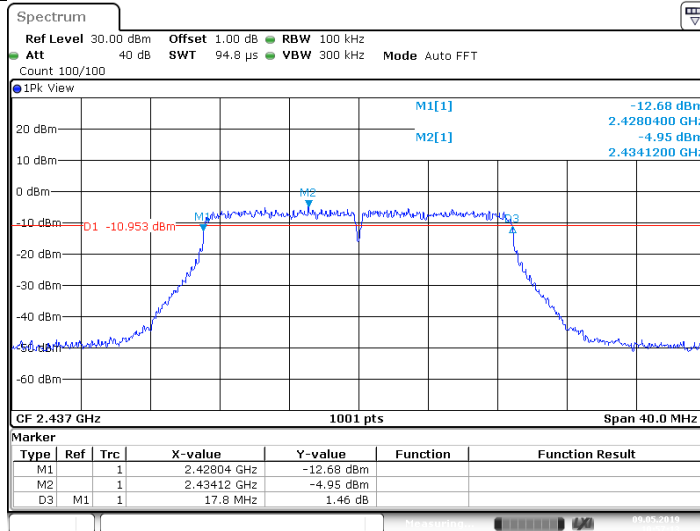

Date: 9 MAY 2019 10:57:13

11N20SISO_Ant1_2462

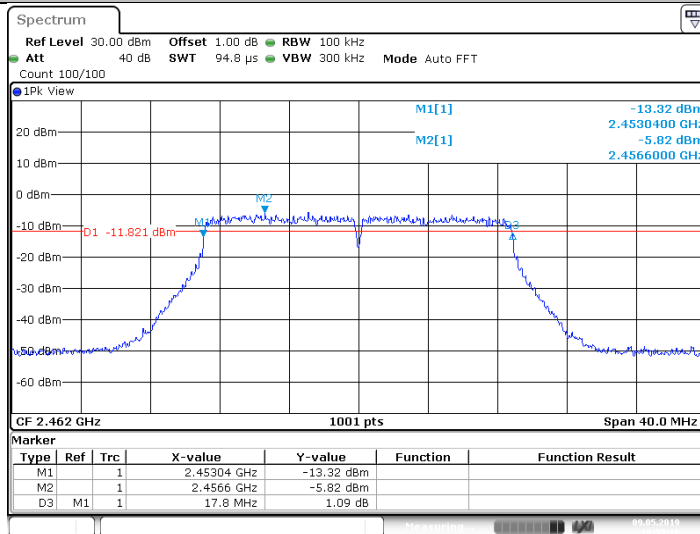

Date: 9 MAY 2019 10:59:16

11N40SISO_Ant1_2422

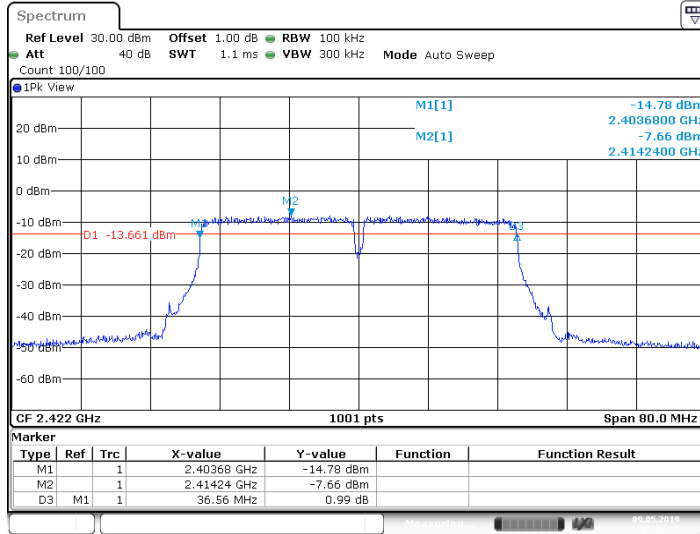

11N40SISO_Ant1_2437

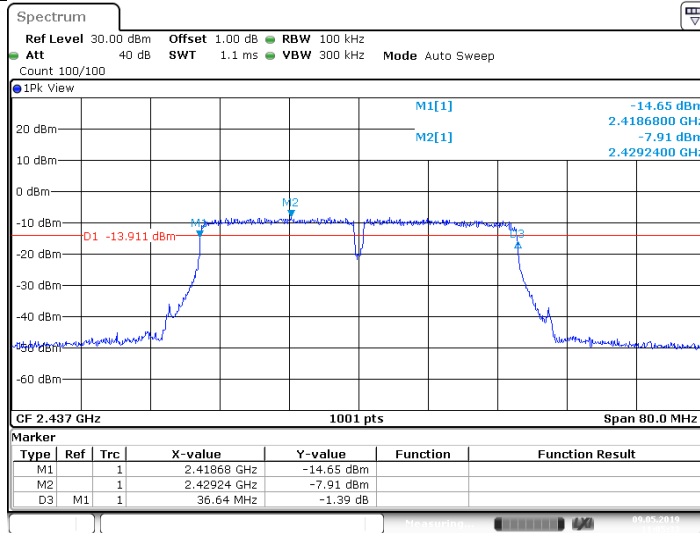

11N40SISO_Ant1_2452

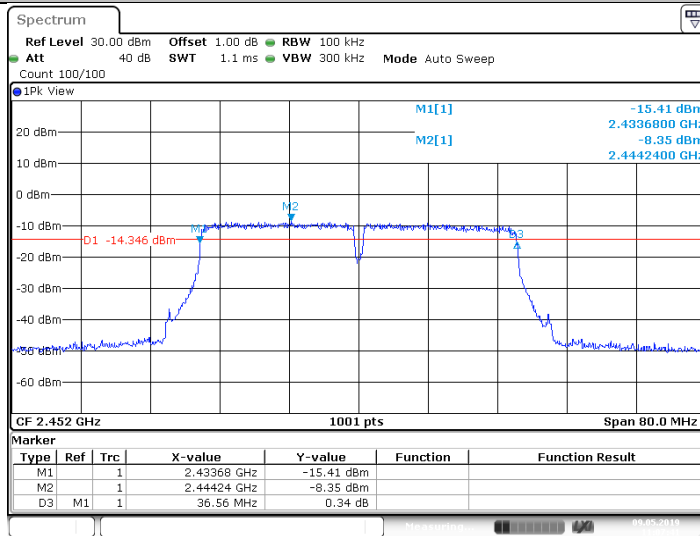

9.4 Power spectral density

Test Method

This procedure shall be used if maximum peak conducted output power was used to demonstrate compliance:

1. Set analyzer center frequency to DTS channel center frequency. RBW=3kHz, VBW \geq 3RBW, Span=1.5 times DTS bandwidth, Detector=Peak, Sweep=auto, Trace= max hold.
2. Allow trace to fully stabilize, use the peak marker function to determine the maximum amplitude level within the RBW.
3. Repeat above procedures until other frequencies measured were completed.

Limit

Limit [dBm/3KHz]

≤ 8

Test result

802.11b

Frequency MHz	Power spectral density dBm/3KHz	Result
Top channel 2412MHz	-16.8	Pass
Middle channel 2437MHz	-16.87	Pass
Bottom channel 2462MHz	-17.89	Pass

802.11g

Frequency MHz	Power spectral density dBm/3KHz	Result
Top channel 2412MHz	-19.49	Pass
Middle channel 2437MHz	-19.57	Pass
Bottom channel 2462MHz	-20.66	Pass

802.11nHT20

Frequency MHz	Power spectral density dBm/3KHz	Result
Top channel 2412MHz	-19.41	Pass
Middle channel 2437MHz	-19.56	Pass
Bottom channel 2462MHz	-21.09	Pass

802.11nHT40

Frequency MHz	Power spectral density dBm/3KHz	Result
Top channel 2422MHz	-19.34	Pass
Middle channel 2437MHz	-19.47	Pass
Bottom channel 2452MHz	-19.98	Pass

Test Graphs

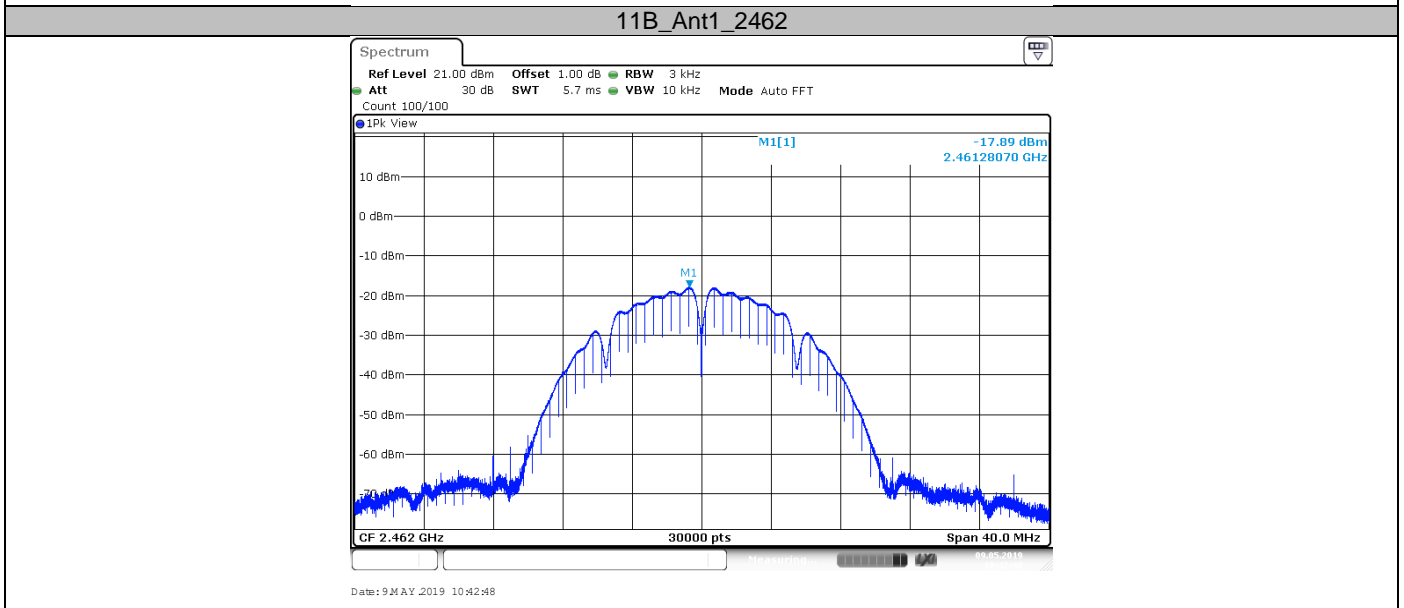
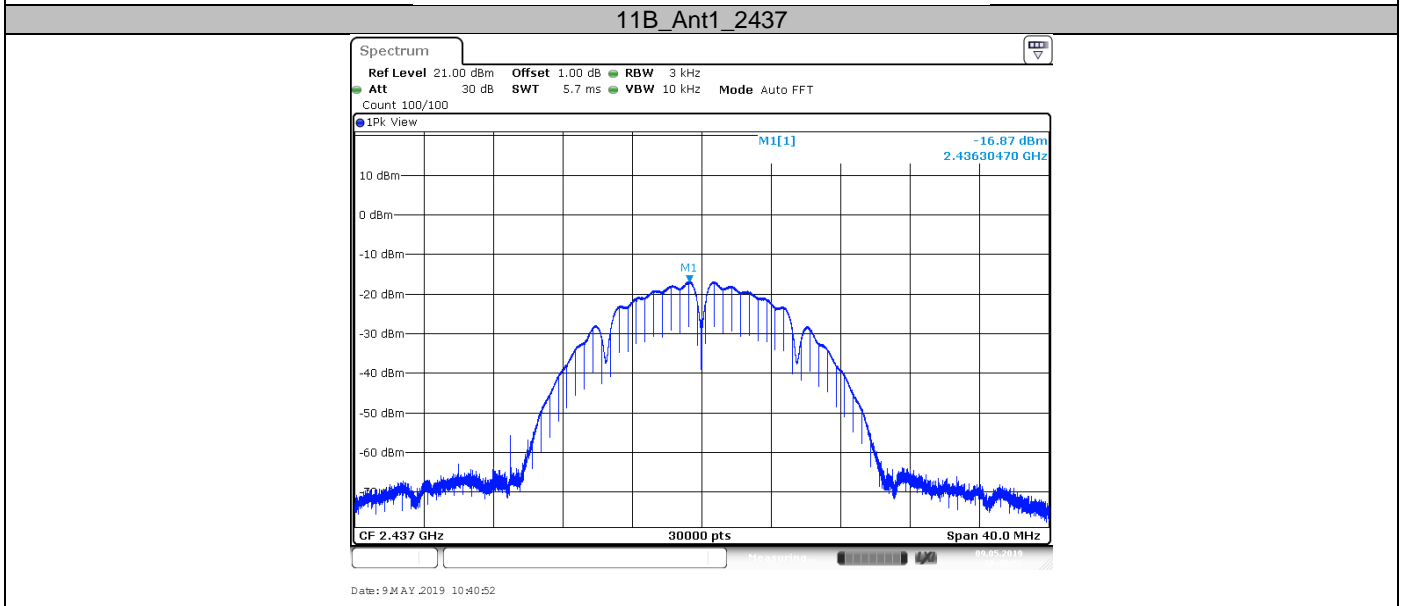
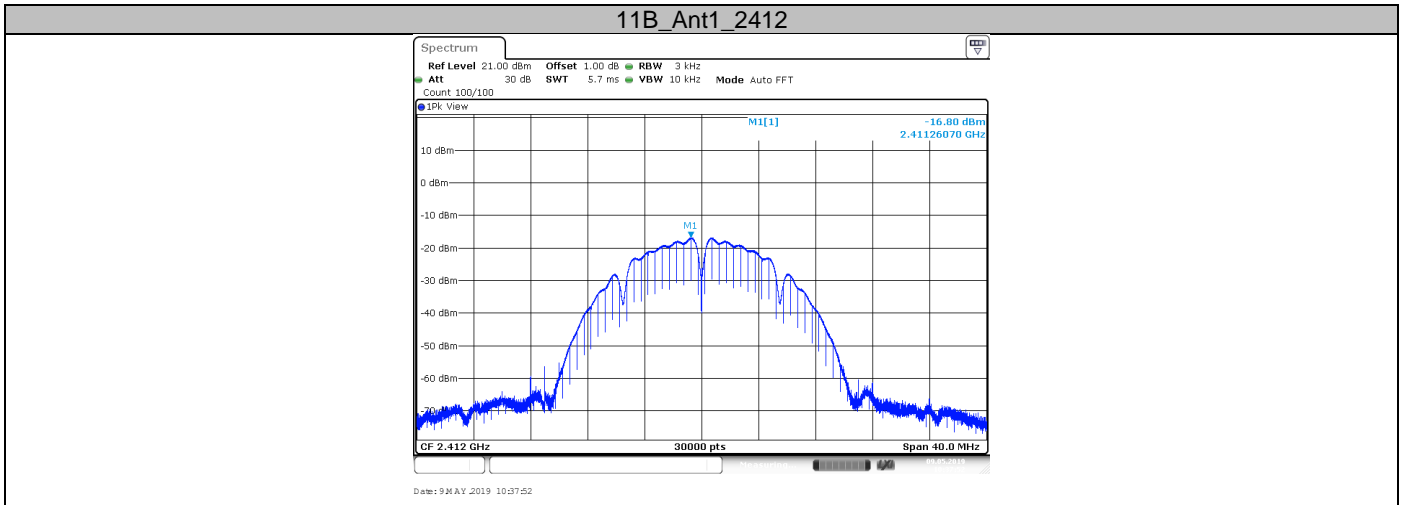

11G_Ant1_2412

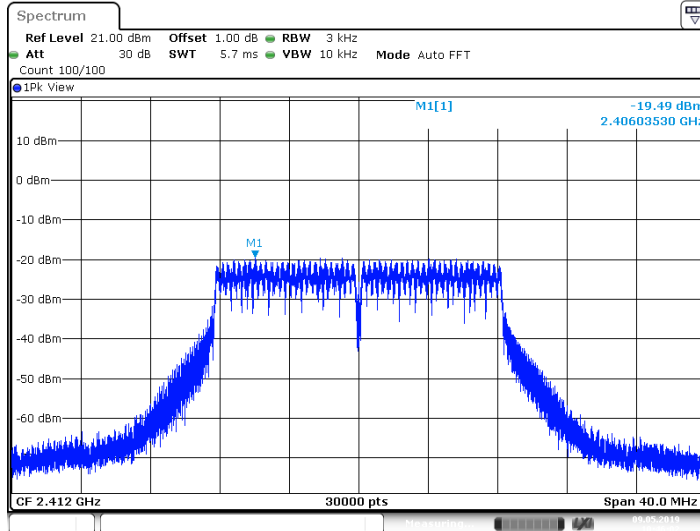

Date: 9 MAY 2019 10:46:02

11G_Ant1_2437

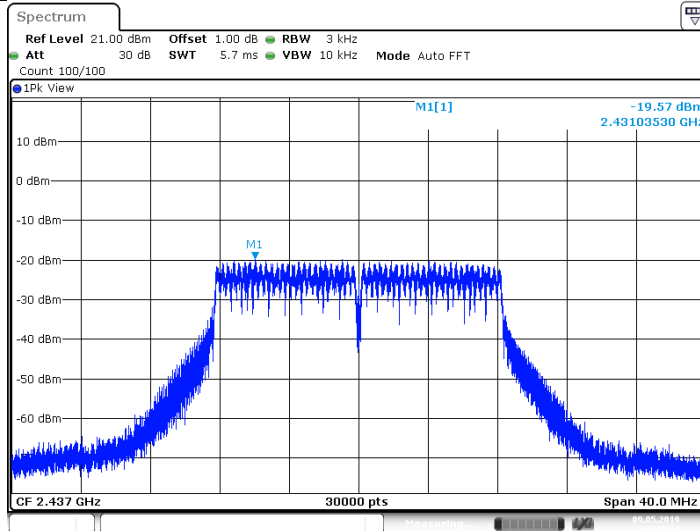

Date: 9 MAY 2019 10:49:04

11G_Ant1_2462

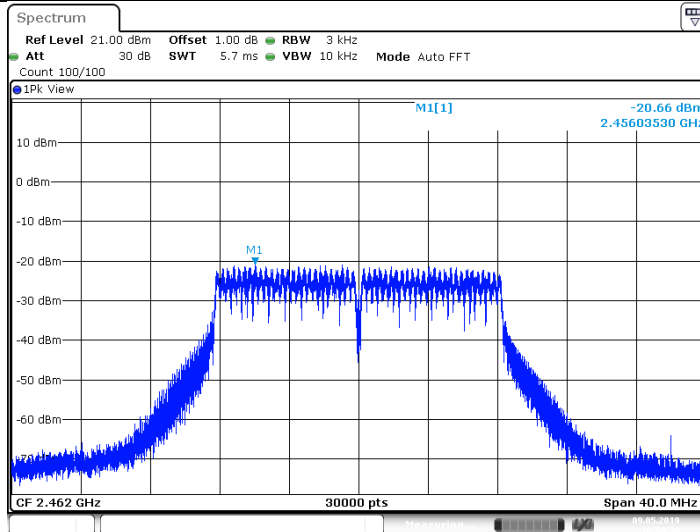

Date: 9 MAY 2019 10:50:57

11N20SISO_Ant1_2412

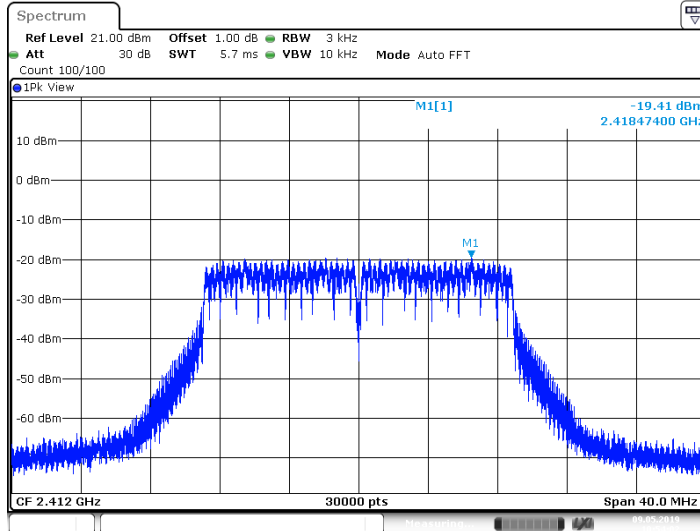

Date: 9 MAY 2019 10:54:02

11N20SISO_Ant1_2437

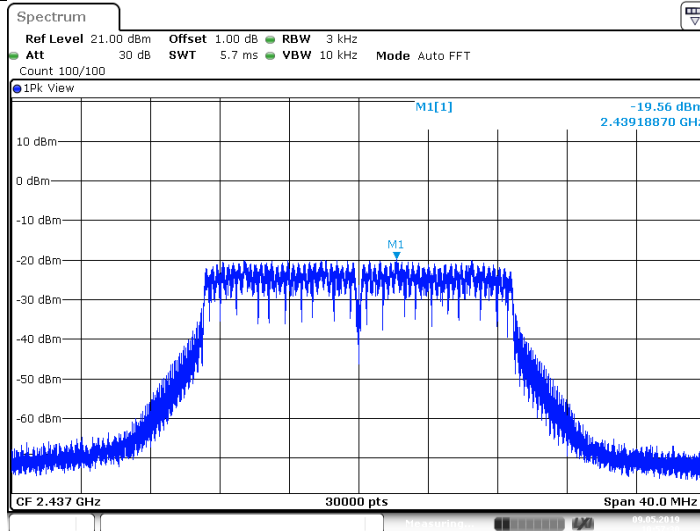

Date: 9 MAY 2019 10:57:30

11N20SISO_Ant1_2462

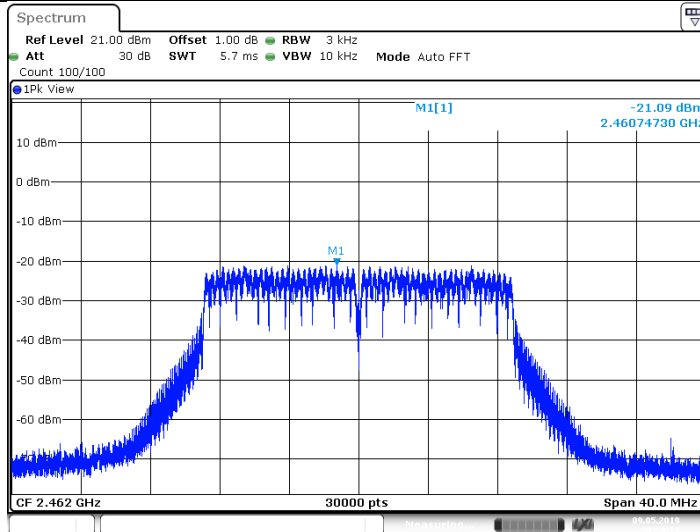

Date: 9 MAY 2019 10:59:34

11N40SISO_Ant1_2422

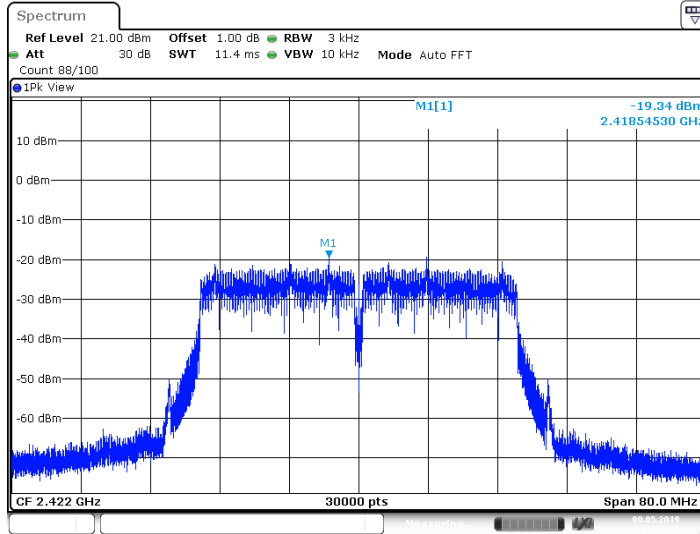

11N40SISO_Ant1_2437

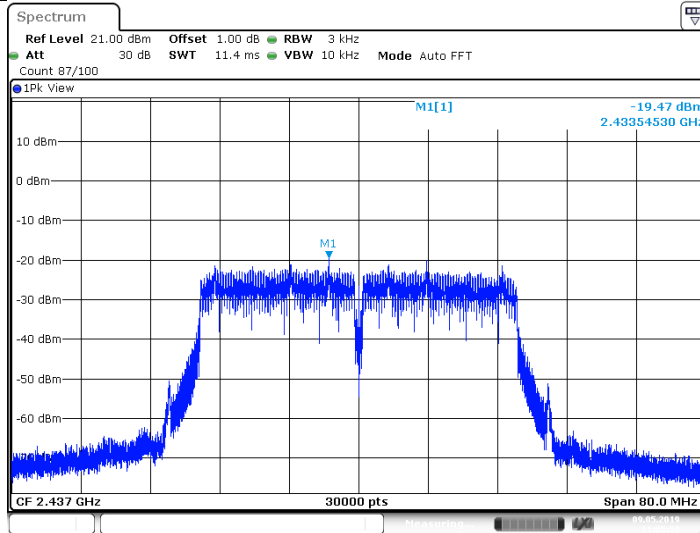

11N40SISO_Ant1_2452

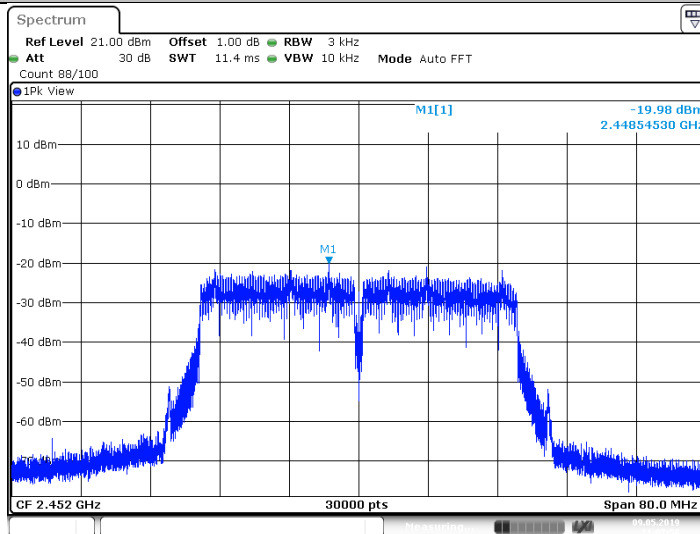

9.5 Spurious RF conducted emissions

Test Method

1. Establish a reference level by using the following procedure:
 - a. Set RBW=100 kHz. VBW \geq 3RBW. Detector =peak, Sweep time = auto couple, Trace mode = max hold.
 - b. Allow trace to fully stabilize, use the peak marker function to determine the maximum PSD level.
2. Use the maximum PSD level to establish the reference level.
 - a. Set the center frequency and span to encompass frequency range to be measured.
 - b. Use the peak marker function to determine the maximum amplitude level. Ensure that the amplitude of all unwanted emissions outside of the authorized frequency band (excluding restricted frequency bands) are attenuated by at least the minimum requirements, report the three highest emissions relative to the limit.
3. Repeat above procedures until other frequencies measured were completed.

Limit

Frequency Range MHz	Limit (dBc)
30-25000	-20

Test result

Test Mode	Antenna	Channel	Freq Range	Ref Level	Result	Limit	Verdict
11B	Ant1	2412	30~1000	30~1000	-68.9	\leq -16.15	PASS
		2412	1000~26500	1000~26500	-38.95	\leq -16.15	PASS
		2437	30~1000	30~1000	-68.19	\leq -16.29	PASS
		2437	1000~26500	1000~26500	-39.04	\leq -16.29	PASS
		2462	30~1000	30~1000	-69.22	\leq -17.22	PASS
		2462	1000~26500	1000~26500	-41.14	\leq -17.22	PASS
11G	Ant1	2412	30~1000	30~1000	-67.79	\leq -25.05	PASS
		2412	1000~26500	1000~26500	-52.72	\leq -25.05	PASS
		2437	30~1000	30~1000	-68.7	\leq -25.34	PASS
		2437	1000~26500	1000~26500	-53.39	\leq -25.34	PASS
		2462	30~1000	30~1000	-68.87	\leq -26.43	PASS
		2462	1000~26500	1000~26500	-52.54	\leq -26.43	PASS
11N20SISO	Ant1	2412	30~1000	30~1000	-68.56	\leq -25.05	PASS
		2412	1000~26500	1000~26500	-53.37	\leq -25.05	PASS
		2437	30~1000	30~1000	-69.35	\leq -25	PASS
		2437	1000~26500	1000~26500	-53.07	\leq -25	PASS
		2462	30~1000	30~1000	-69.31	\leq -26.01	PASS
		2462	1000~26500	1000~26500	-53.5	\leq -26.01	PASS
11N40SISO	Ant1	2422	30~1000	30~1000	-62.25	\leq -28.08	PASS
		2422	1000~26500	1000~26500	-53.03	\leq -28.08	PASS
		2437	30~1000	30~1000	-63.54	\leq -28.47	PASS
		2437	1000~26500	1000~26500	-53.7	\leq -28.47	PASS
		2452	30~1000	30~1000	-63.71	\leq -28.99	PASS
		2452	1000~26500	1000~26500	-52.27	\leq -28.99	PASS

Test Graphs

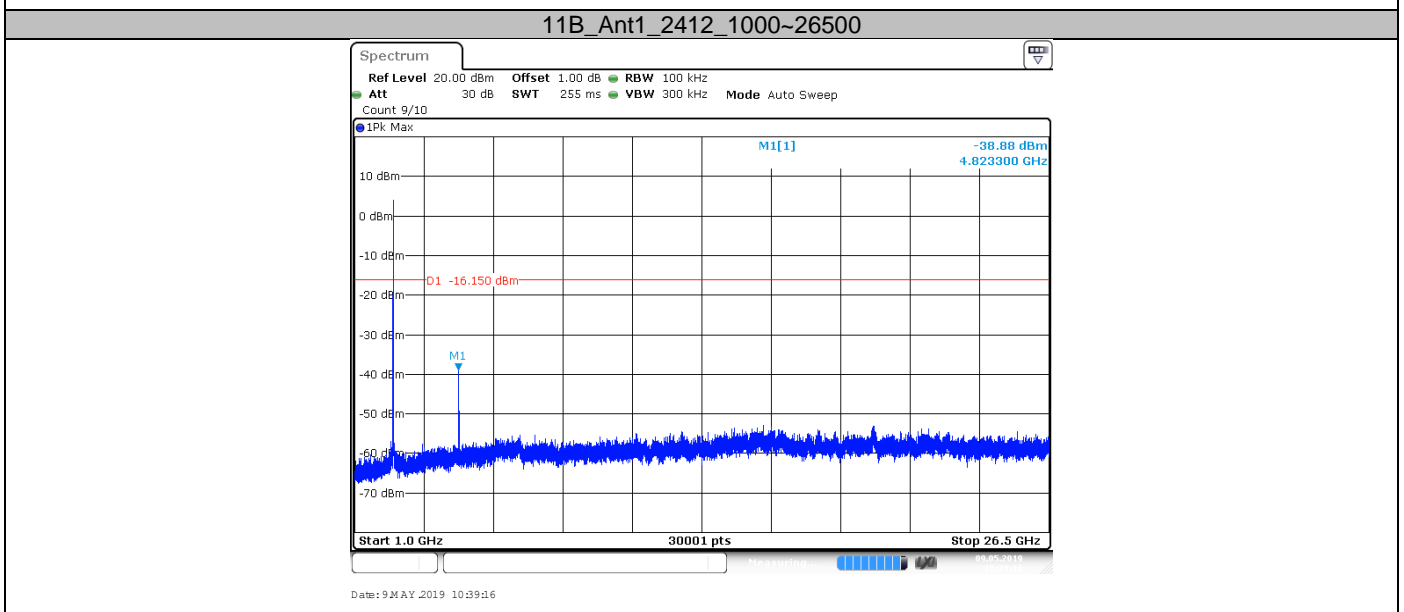
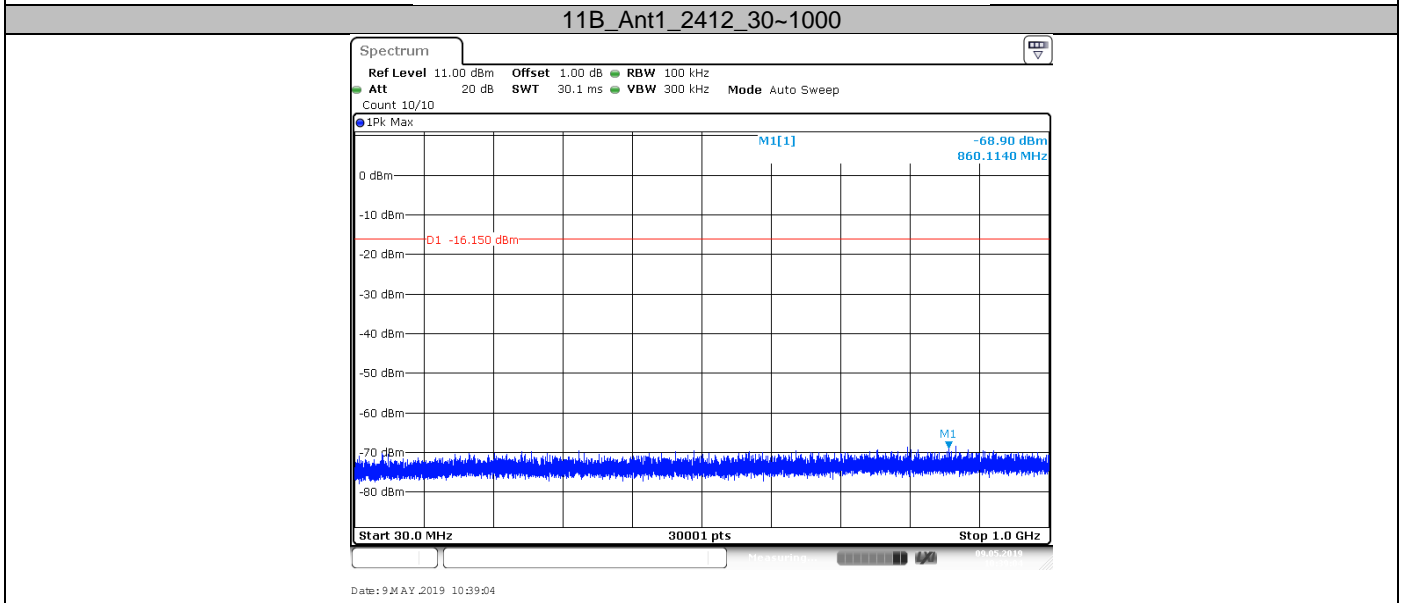
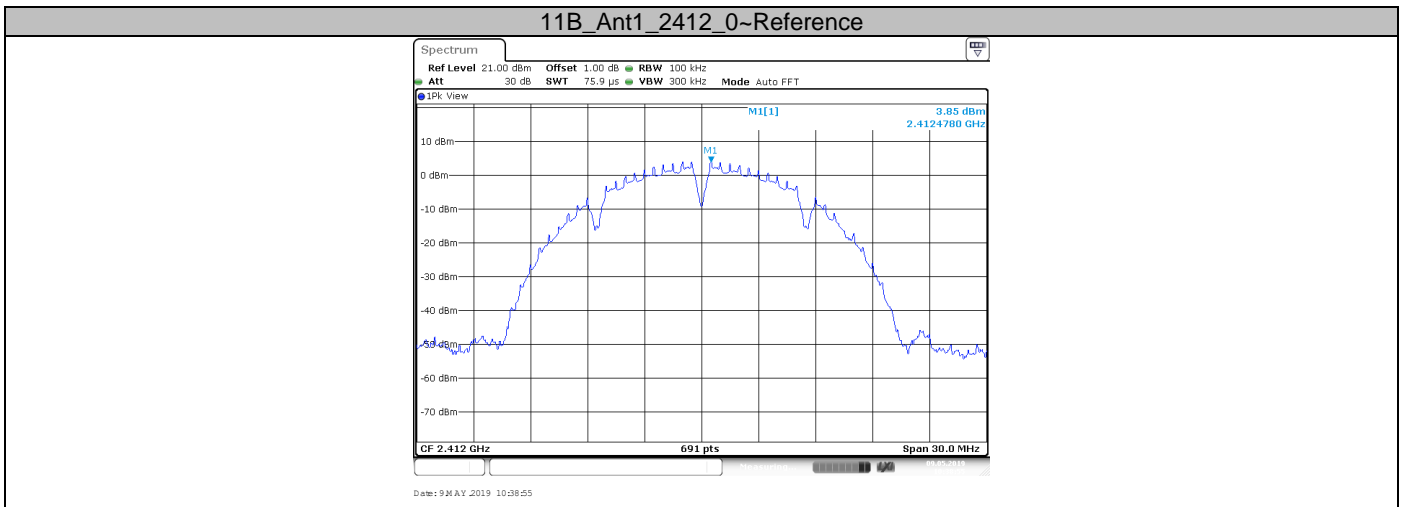

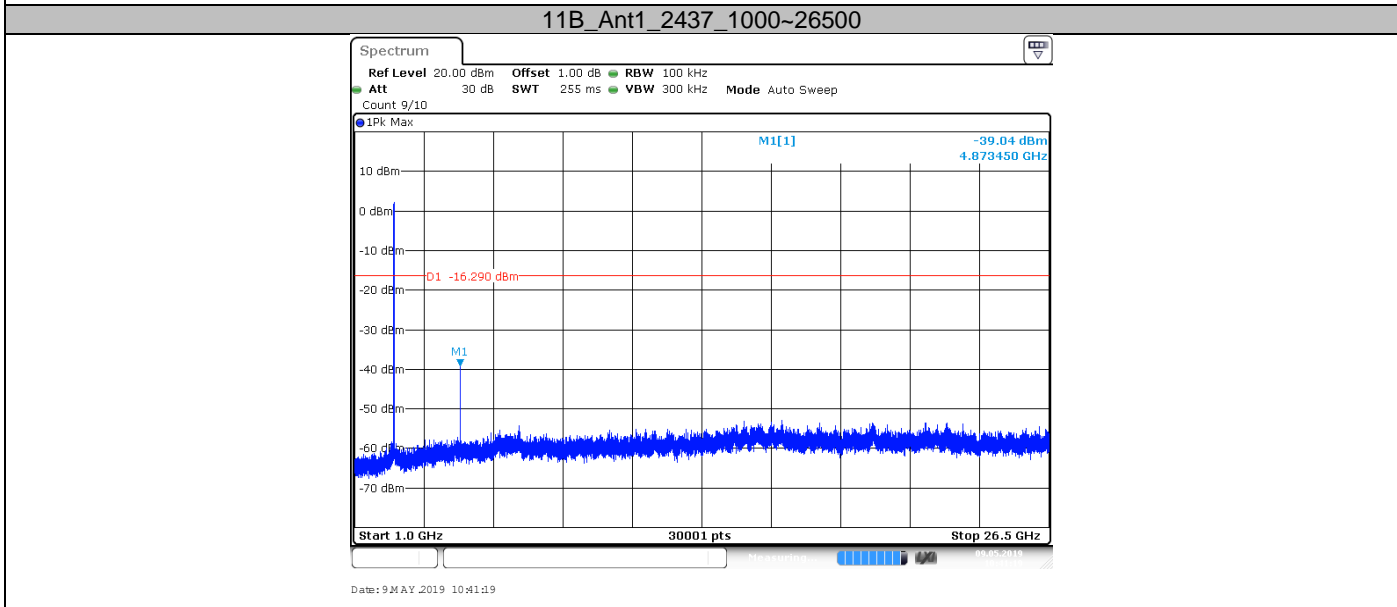
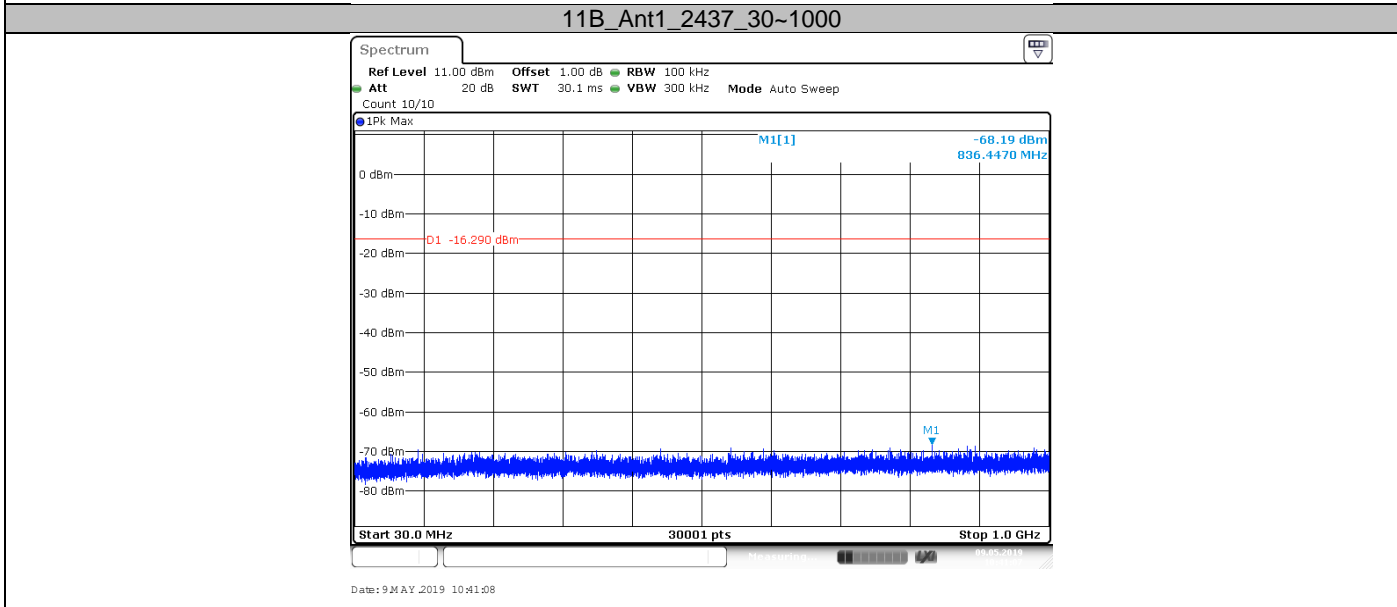
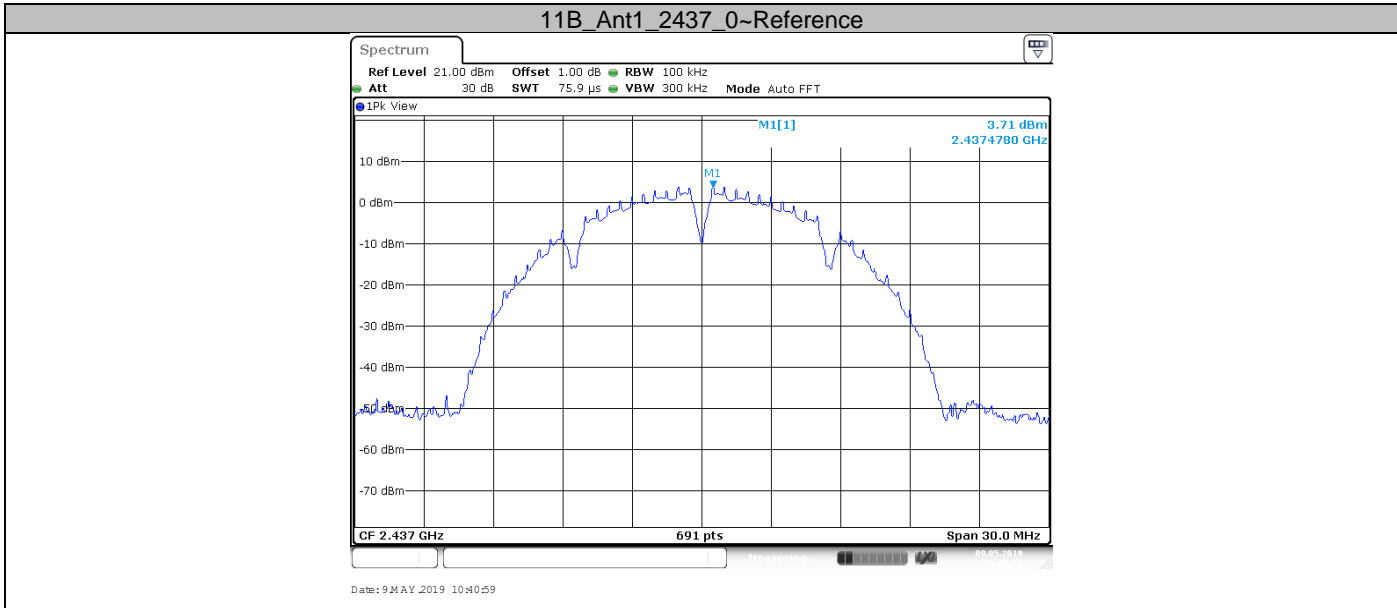

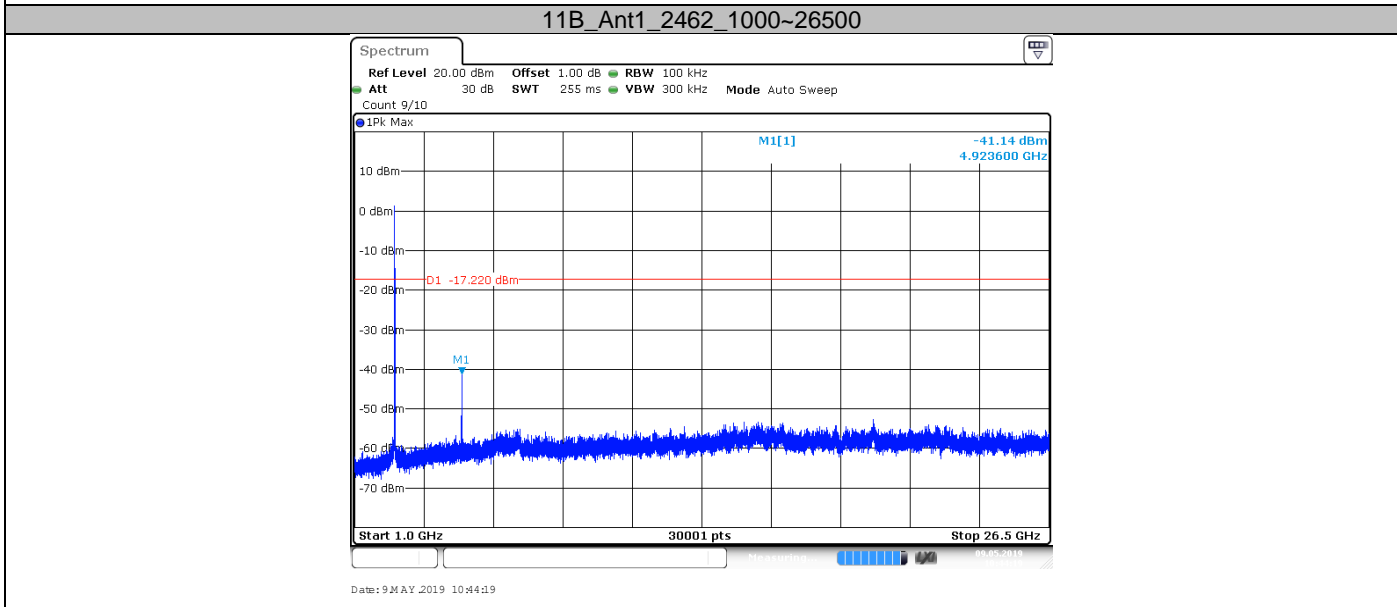
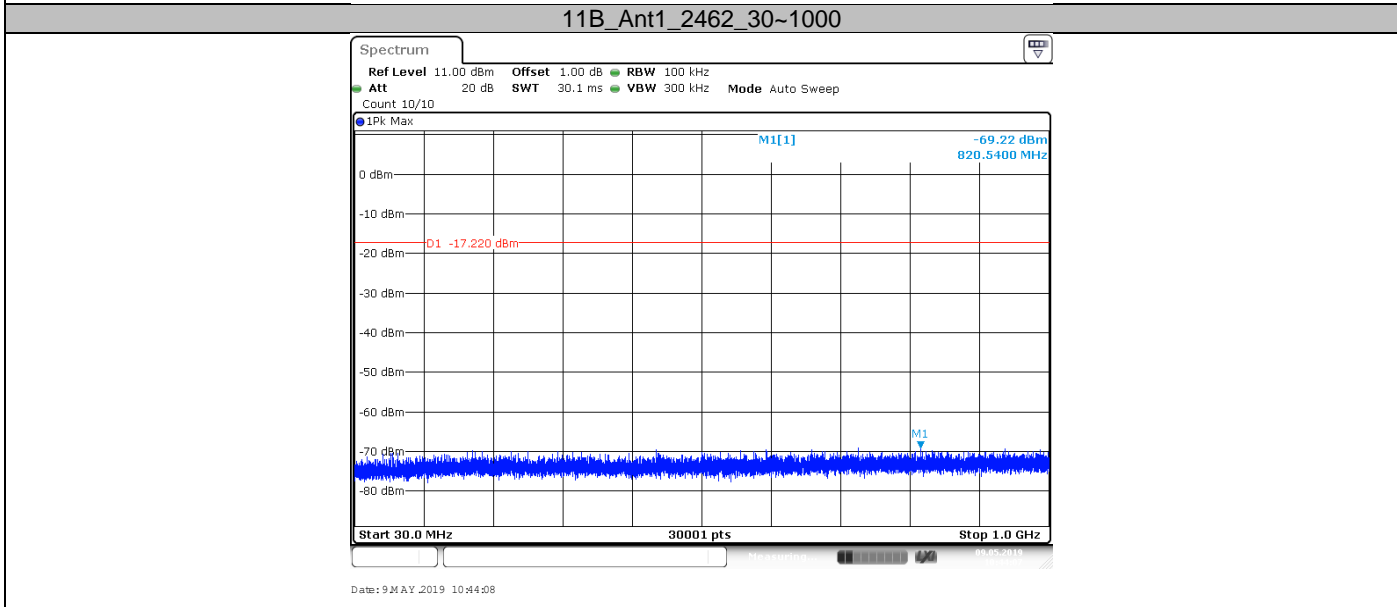
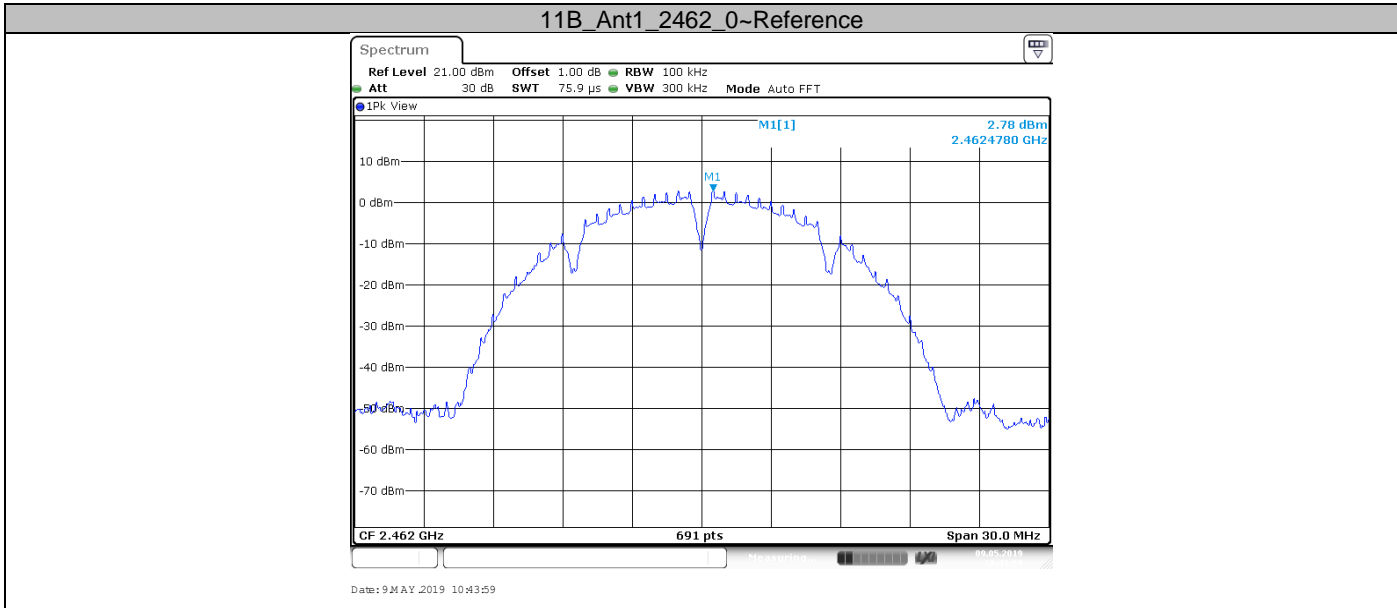

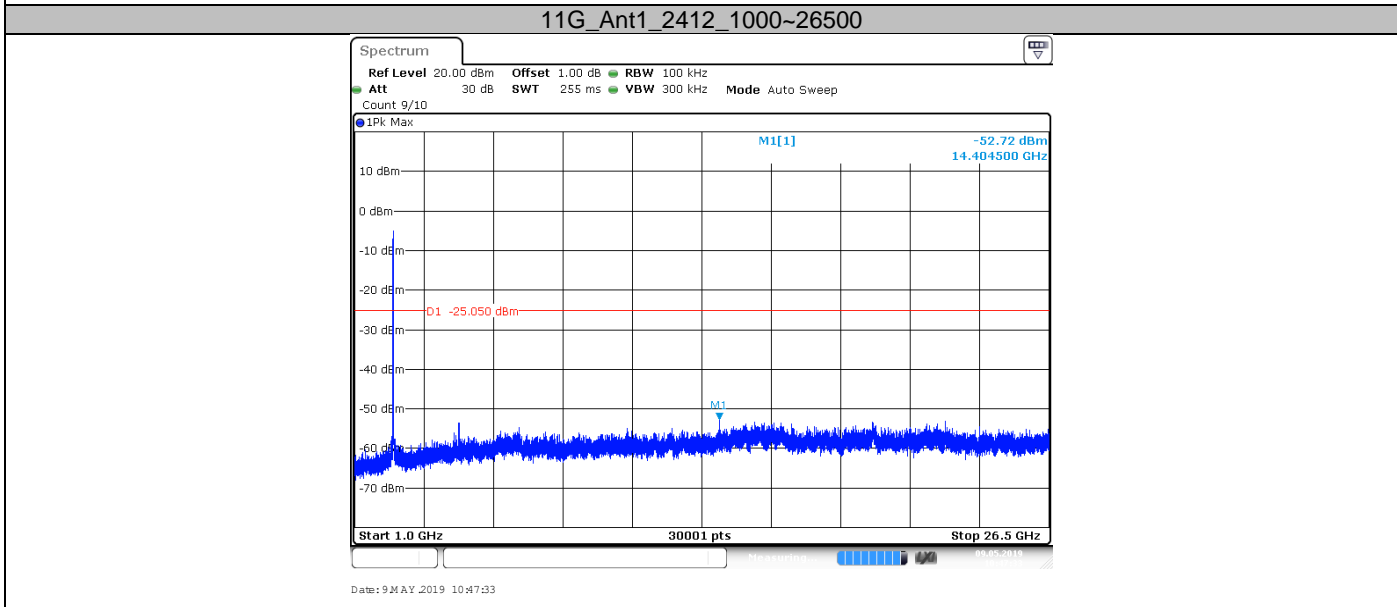
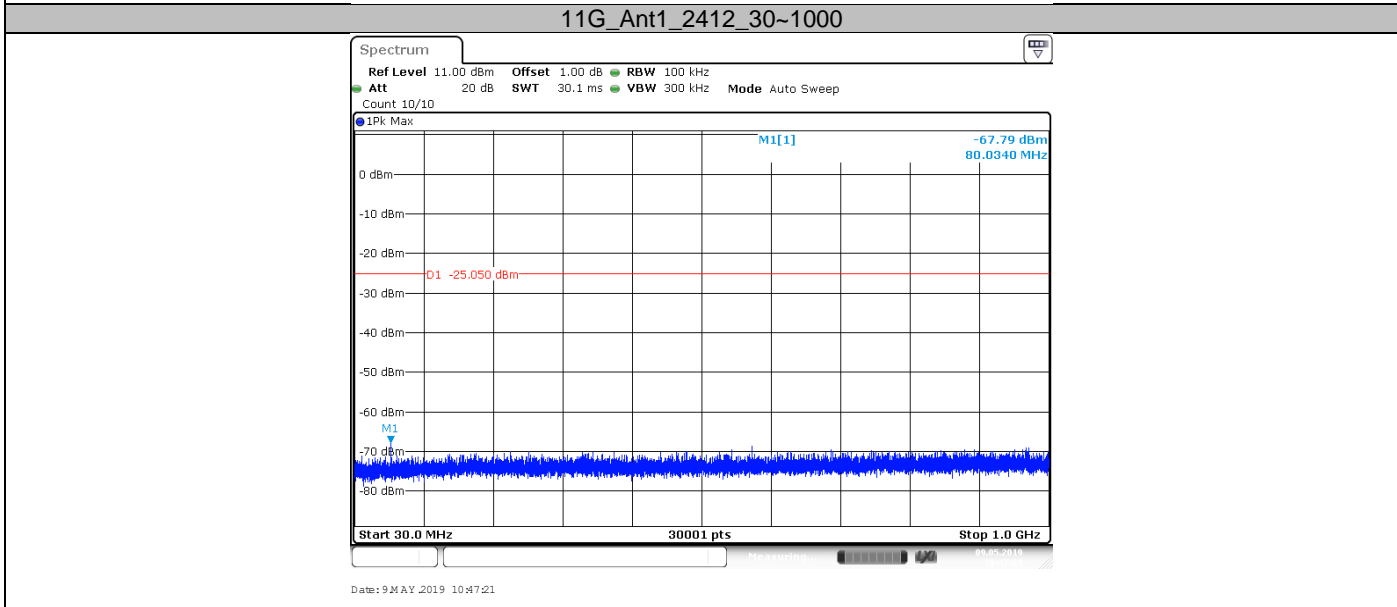
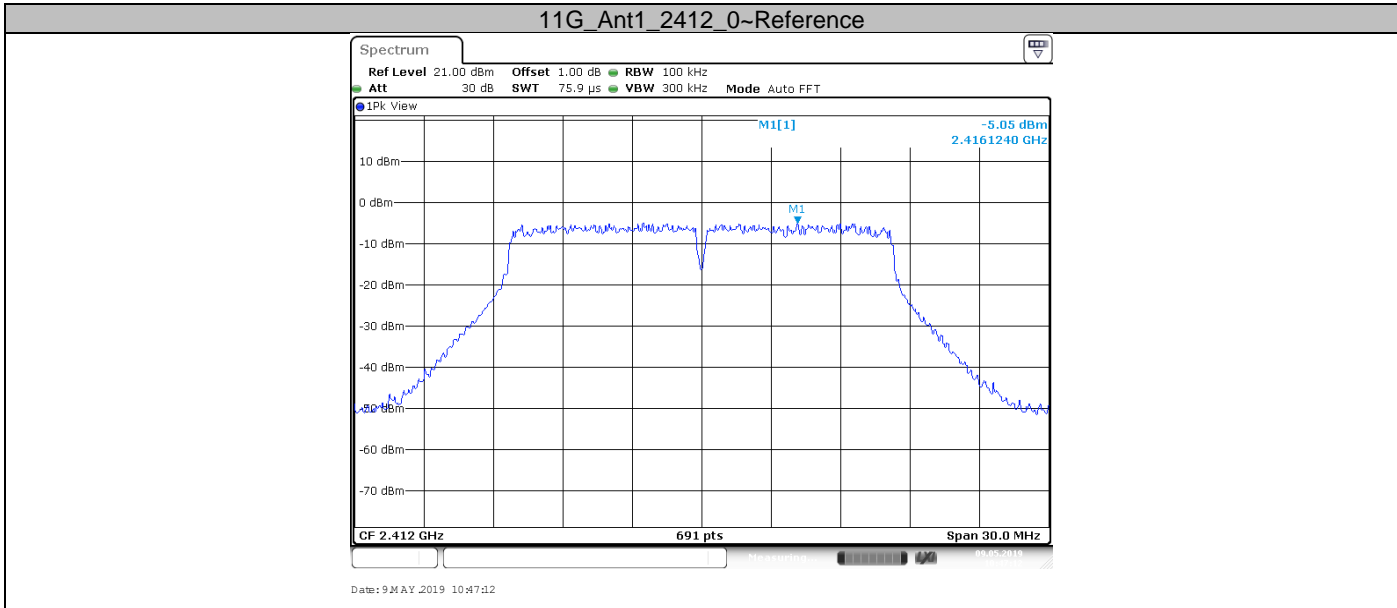

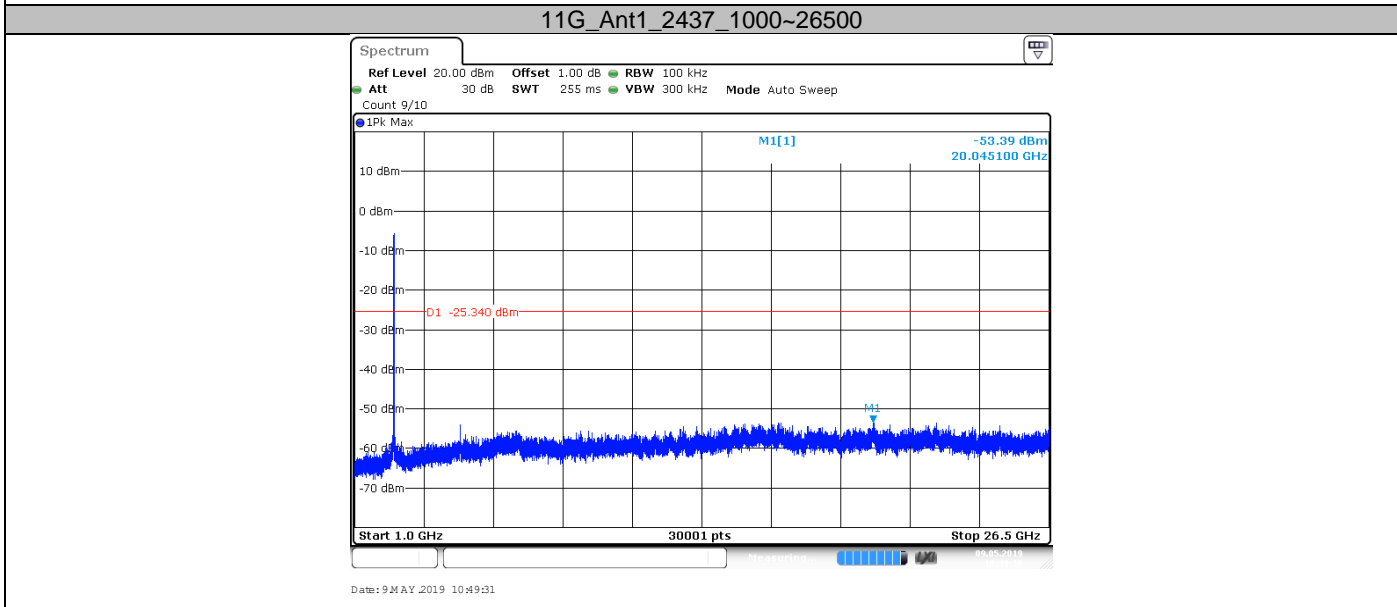
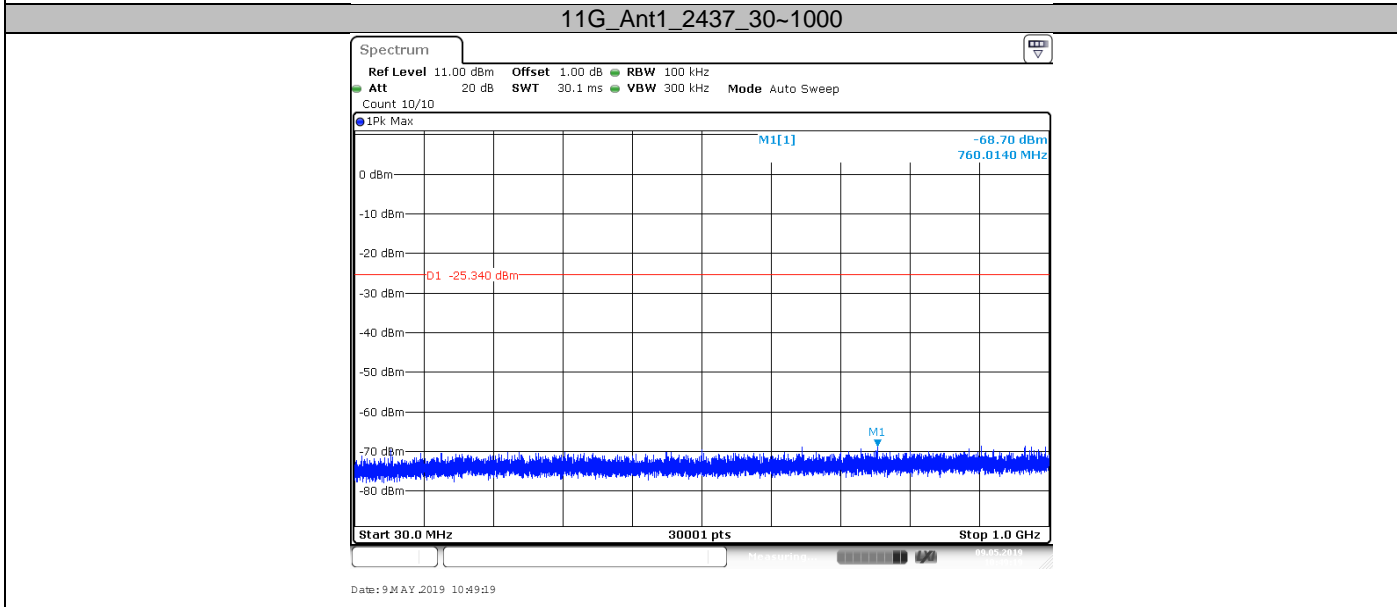
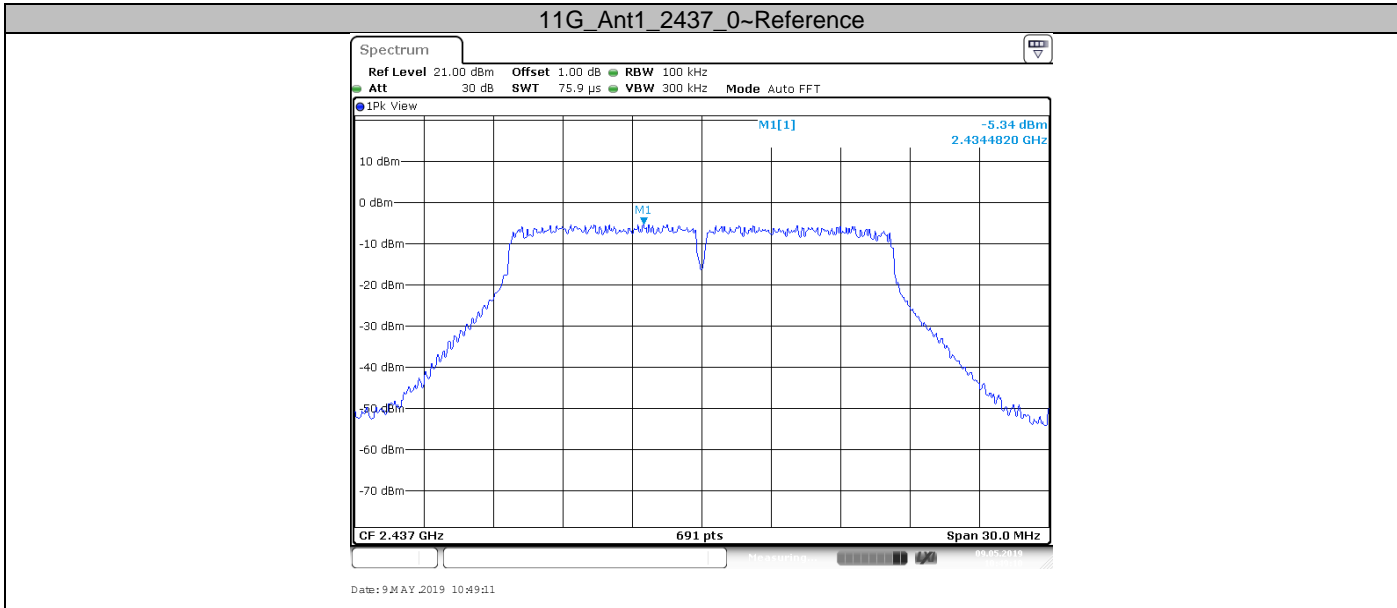

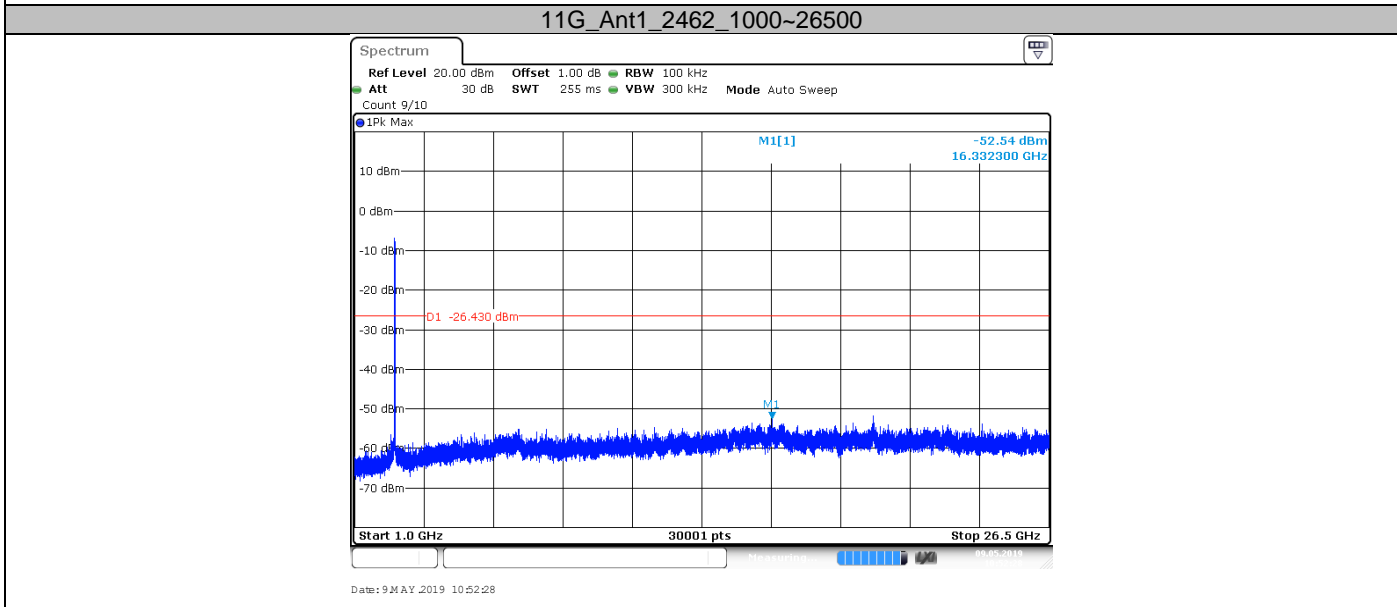
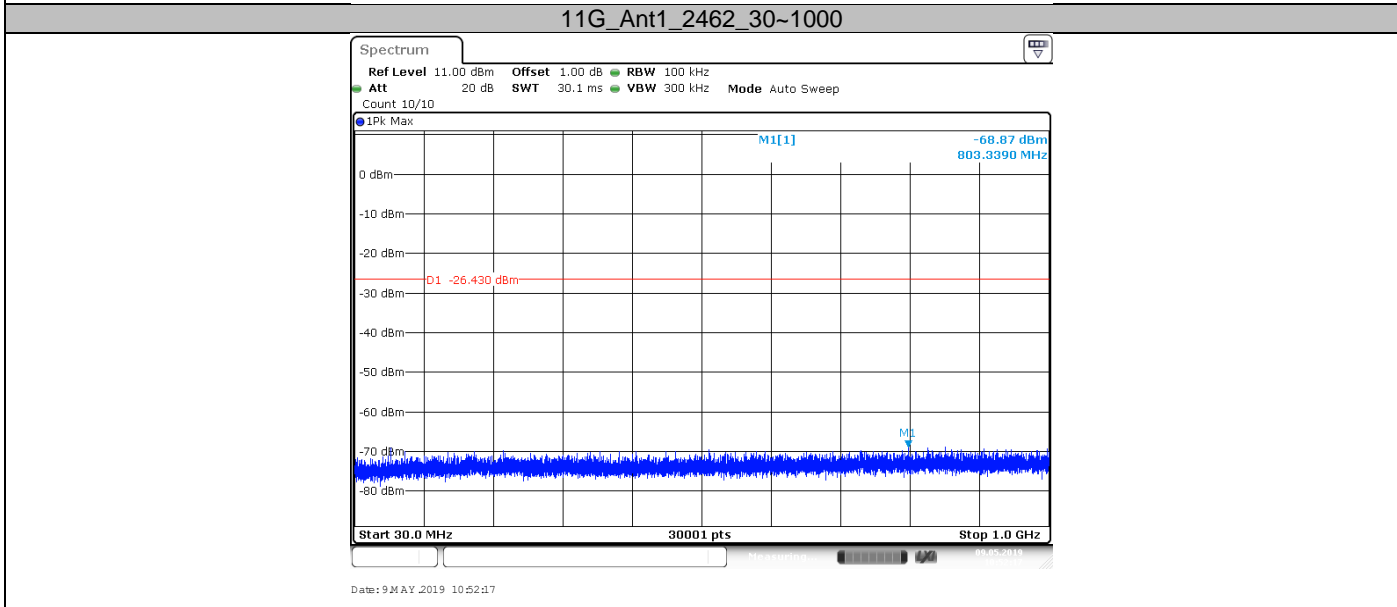
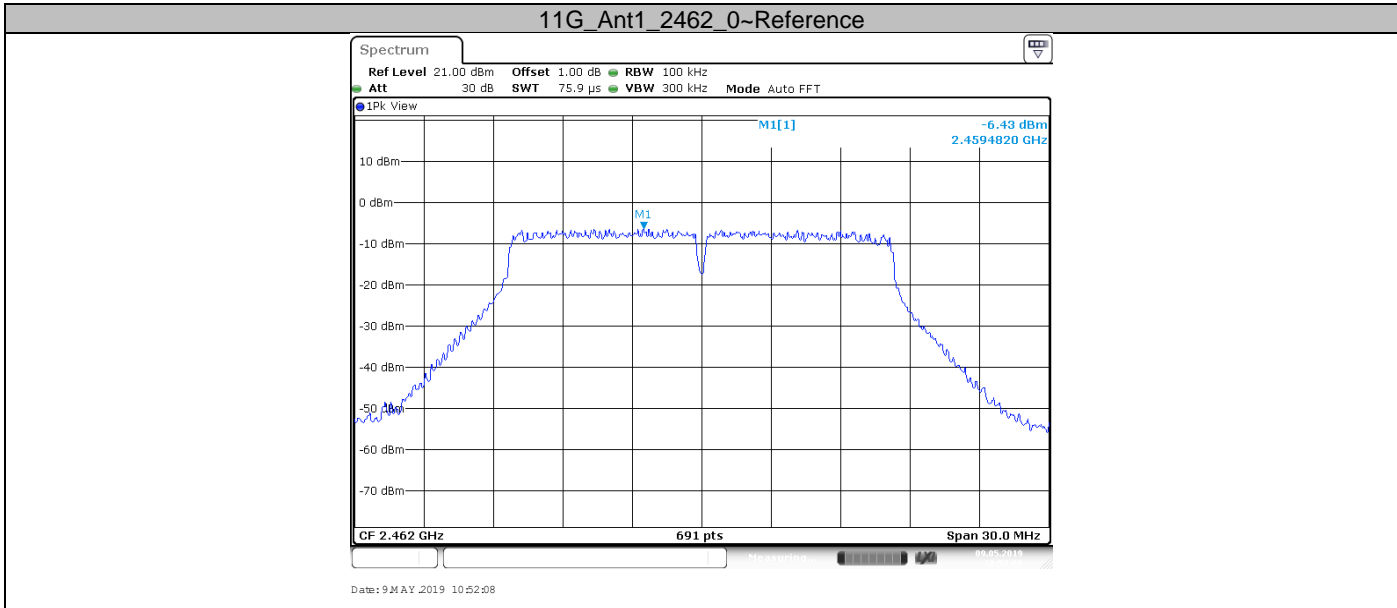

11N20SISO_Ant1_2412_0~Reference

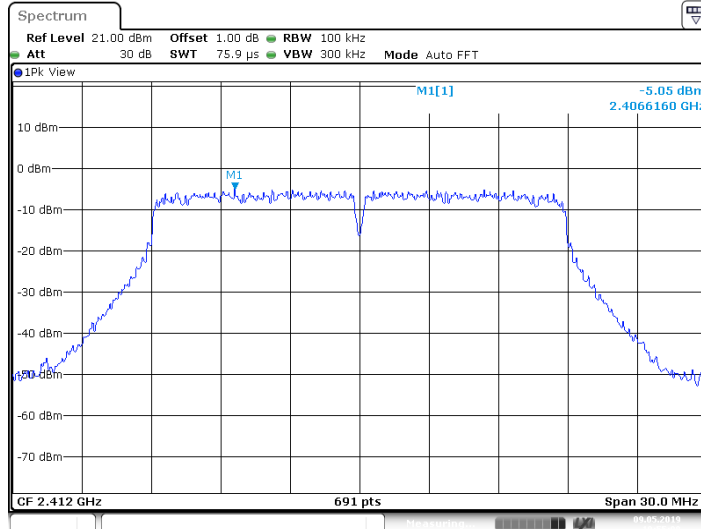

11N20SISO_Ant1_2412_30~1000

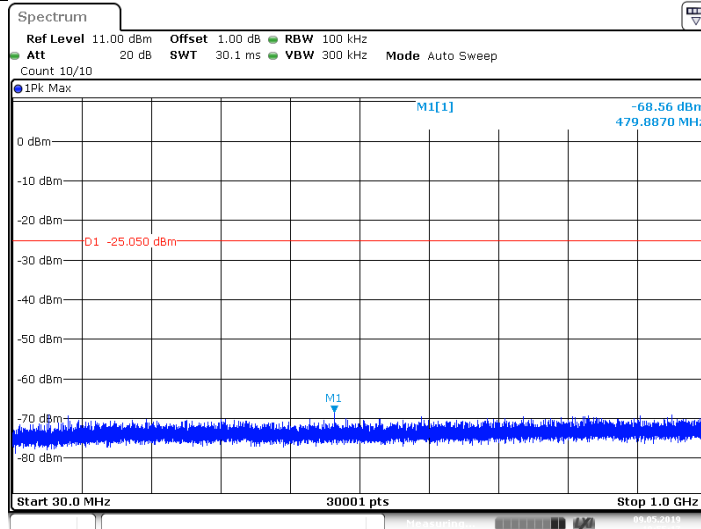

11N20SISO_Ant1_2412_1000~26500

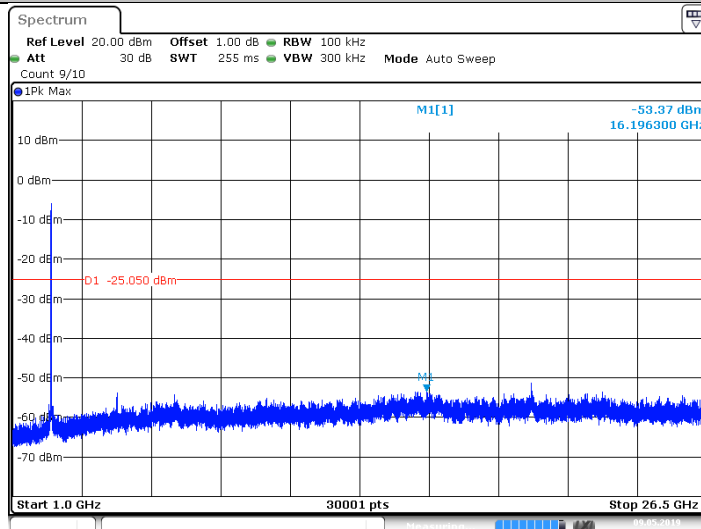



11N20SISO_Ant1_2437_0~Reference

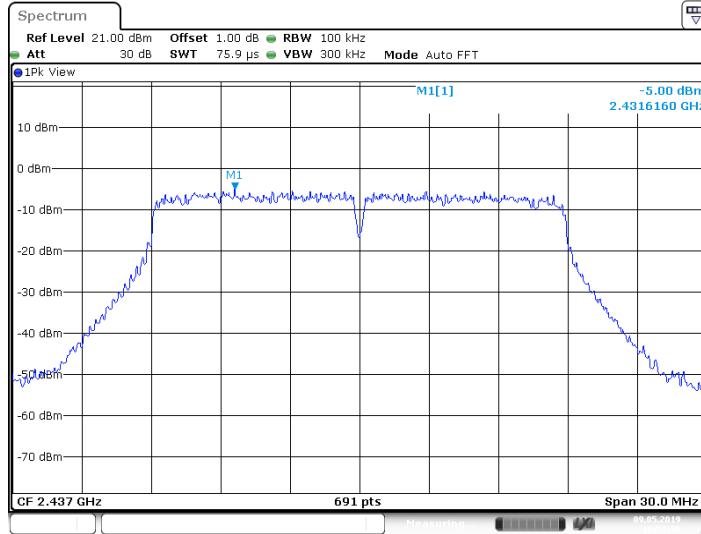

11N20SISO_Ant1_2437_30~1000

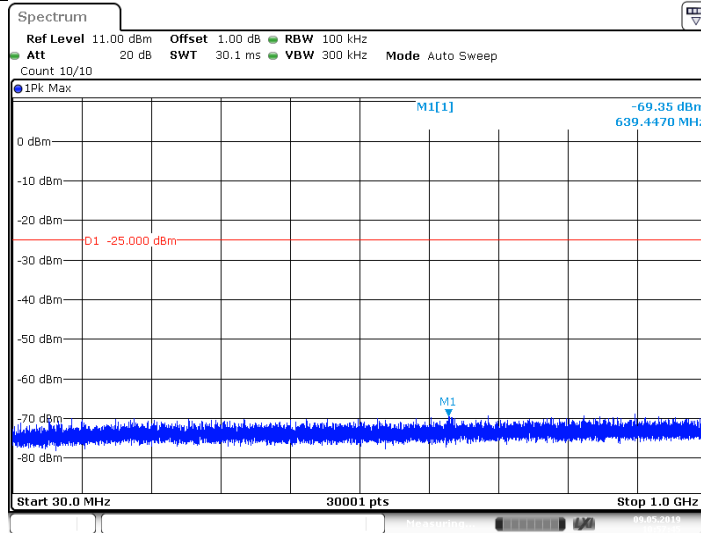

11N20SISO_Ant1_2437_1000~26500

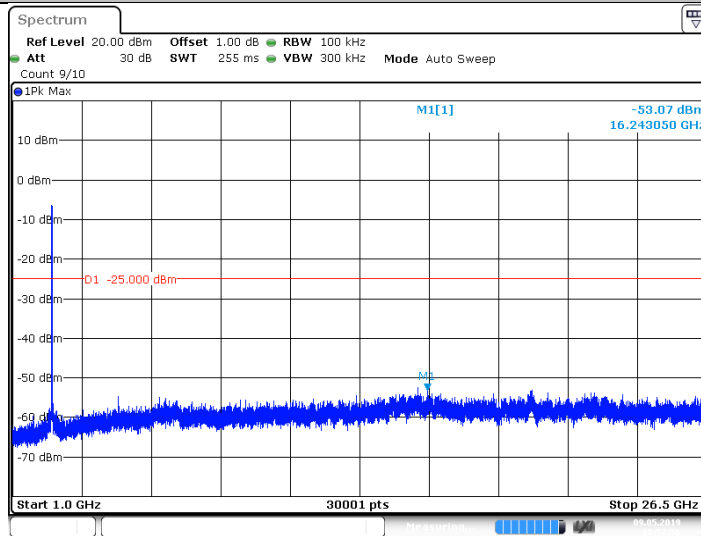

11N20SISO_Ant1_2462_0~Reference

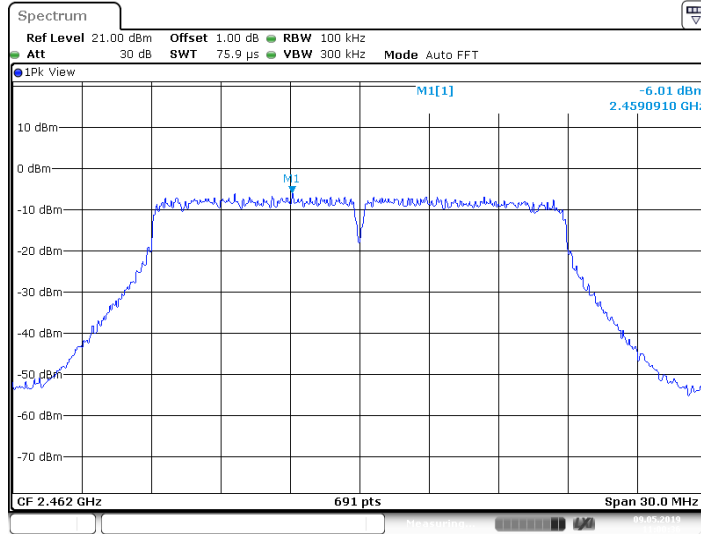

11N20SISO_Ant1_2462_30~1000

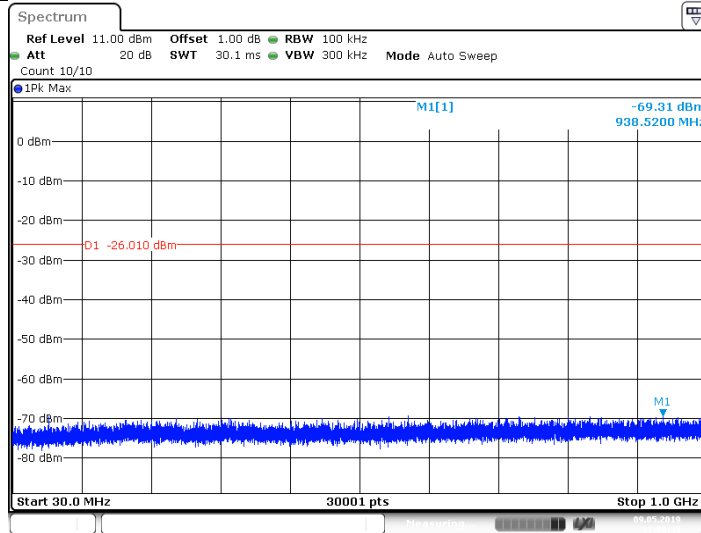

11N20SISO_Ant1_2462_1000~26500

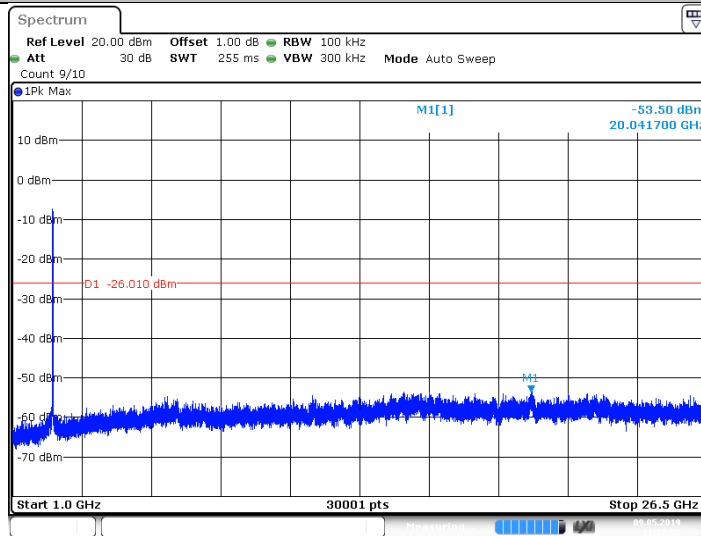

11N40SISO_Ant1_2422_0~Reference

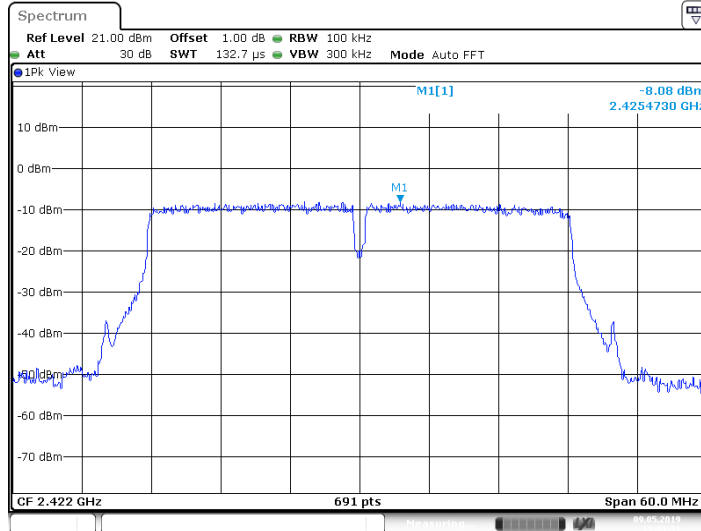

11N40SISO_Ant1_2422_30~1000

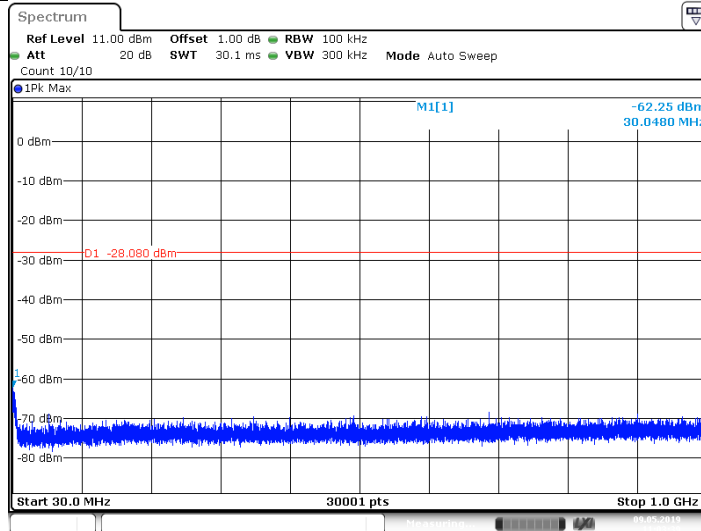

11N40SISO_Ant1_2422_1000~26500

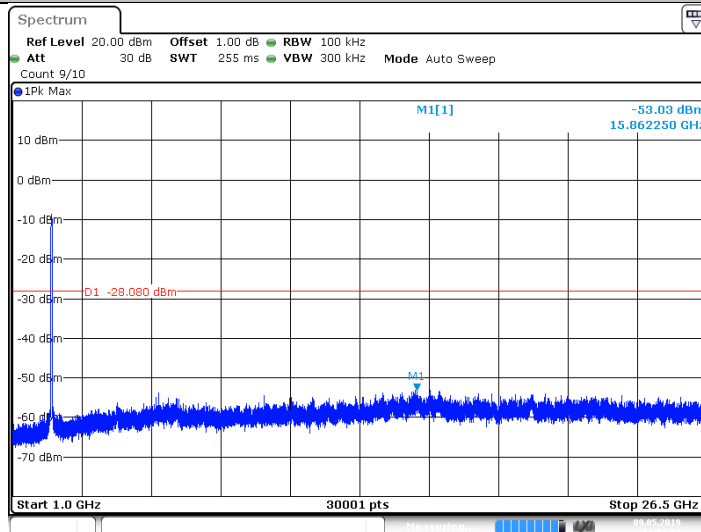

11N40SISO_Ant1_2437_0~Reference

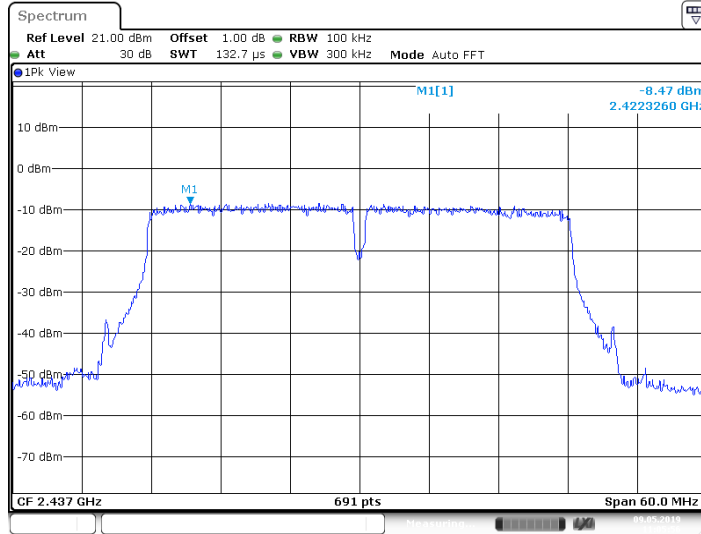

11N40SISO_Ant1_2437_30~1000

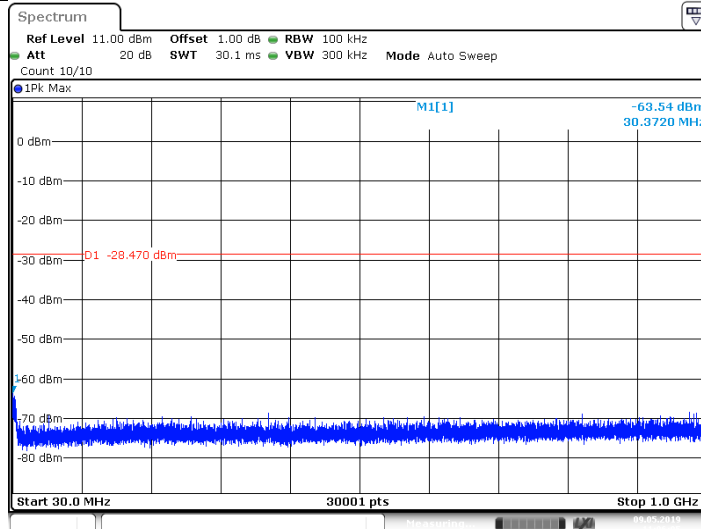

11N40SISO_Ant1_2437_1000~26500

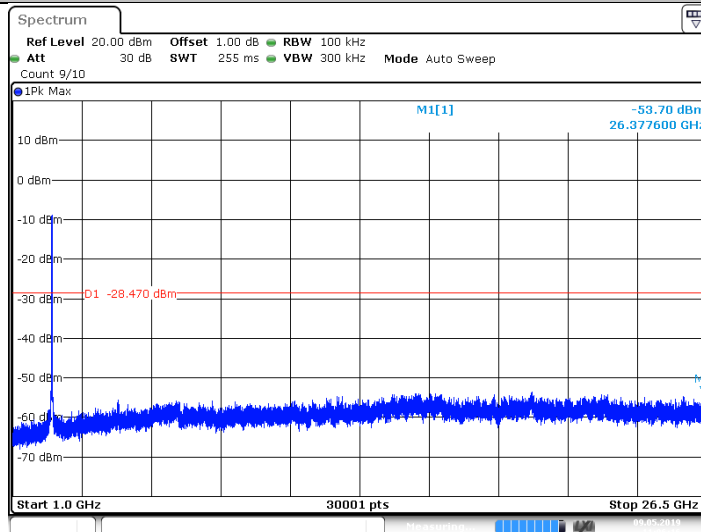

11N40SISO_Ant1_2452_0~Reference

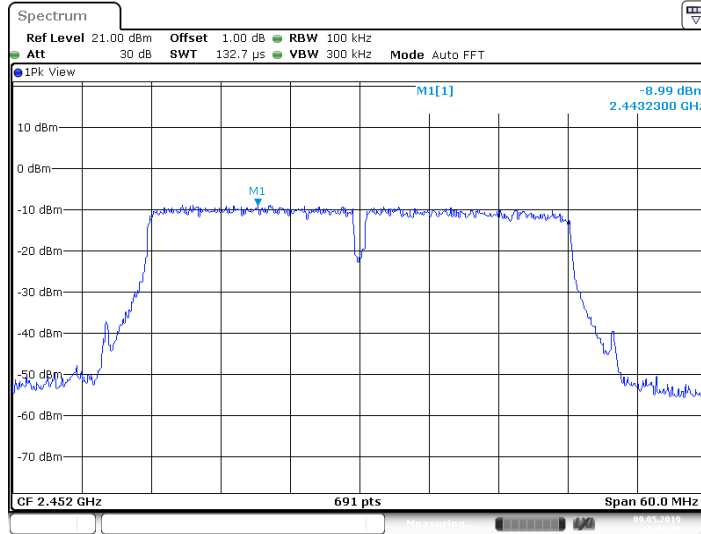

11N40SISO_Ant1_2452_30~1000

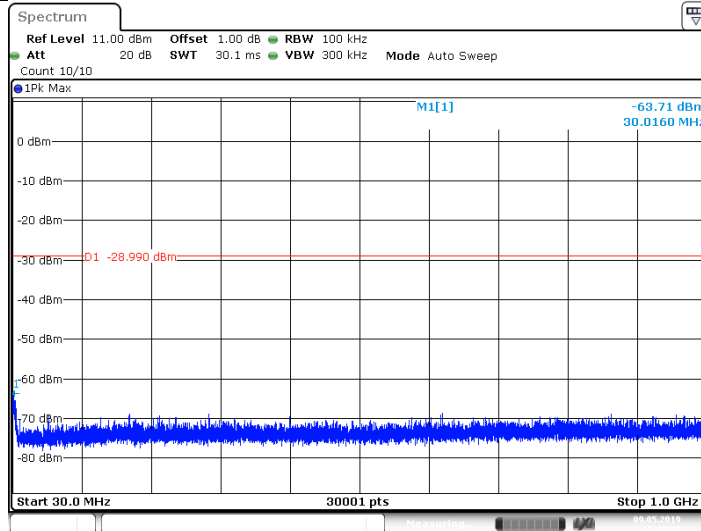

11N40SISO_Ant1_2452_1000~26500

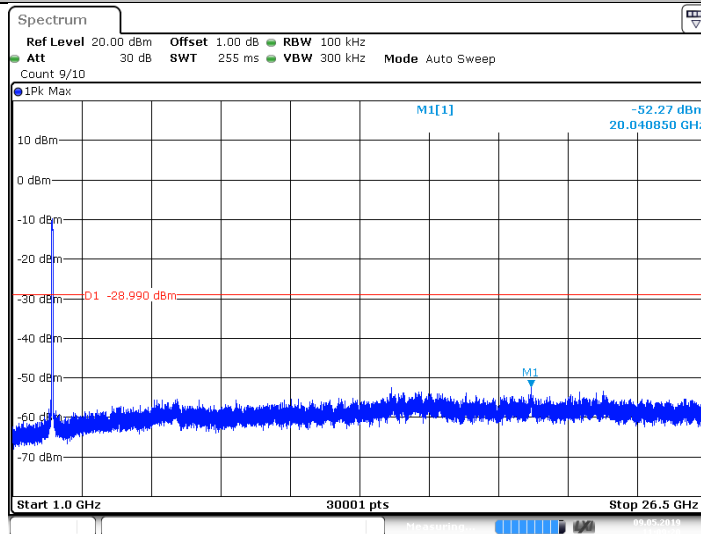



9.6 Band edge

Test Method

- 1 Use the following spectrum analyzer settings:
Span = wide enough to capture the peak level of the in-band emission and all spurious
RBW = 100 kHz, VBW ≥ RBW, Sweep = auto, Detector function = peak, Trace = max hold.
- 2 Allow the trace to stabilize, use the peak and delta measurement to record the result.
- 3 The level displayed must comply with the limit specified in this Section.

Limit

Frequency Range MHz	Limit (dBc)
30-25000	-20

Test result

Test Mode	Antenna	Ch Name	Channel	Ref Level	Result	Limit	Verdict
11B	Ant1	Low	2412	3.87	-48.47	≤-16.13	PASS
		High	2462	2.62	-56.46	≤-17.38	PASS
11G	Ant1	Low	2412	-5.23	-42.38	≤-25.23	PASS
		High	2462	-6.54	-55.15	≤-26.54	PASS
11N20SISO	Ant1	Low	2412	-4.77	-42.62	≤-24.77	PASS
		High	2462	-6.02	-56.31	≤-26.02	PASS
11N40SISO	Ant1	Low	2422	-8.08	-41.78	≤-28.08	PASS
		High	2452	-8.94	-53.31	≤-28.94	PASS

9.6.1 Test Graphs

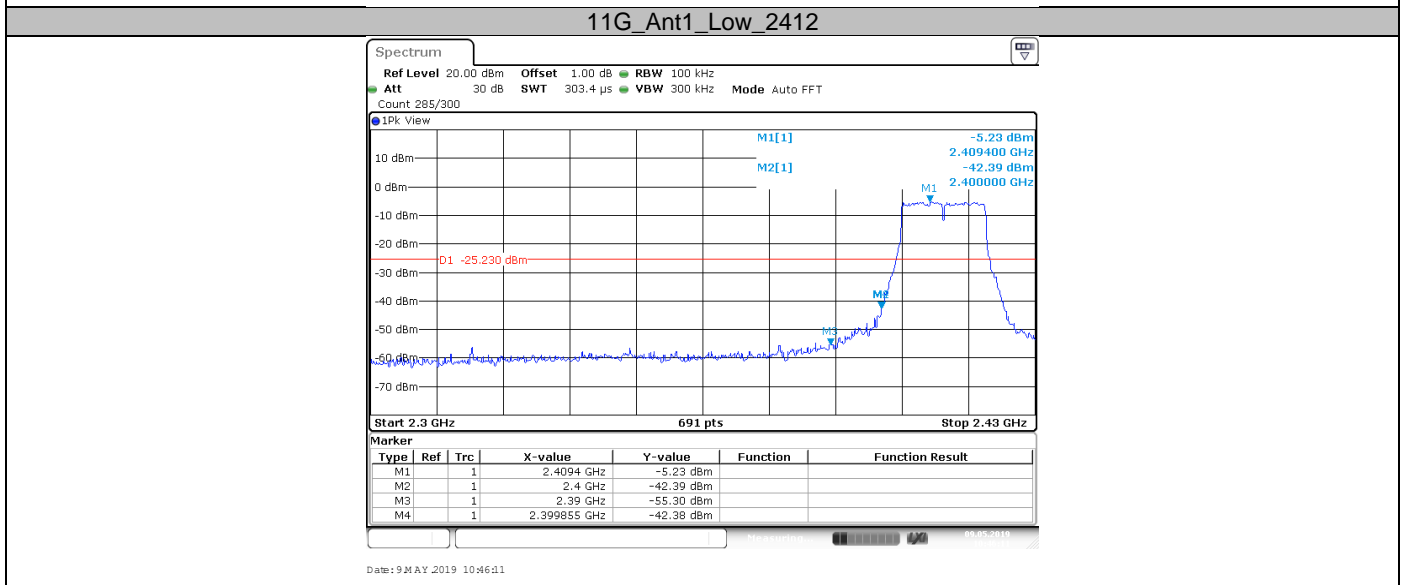
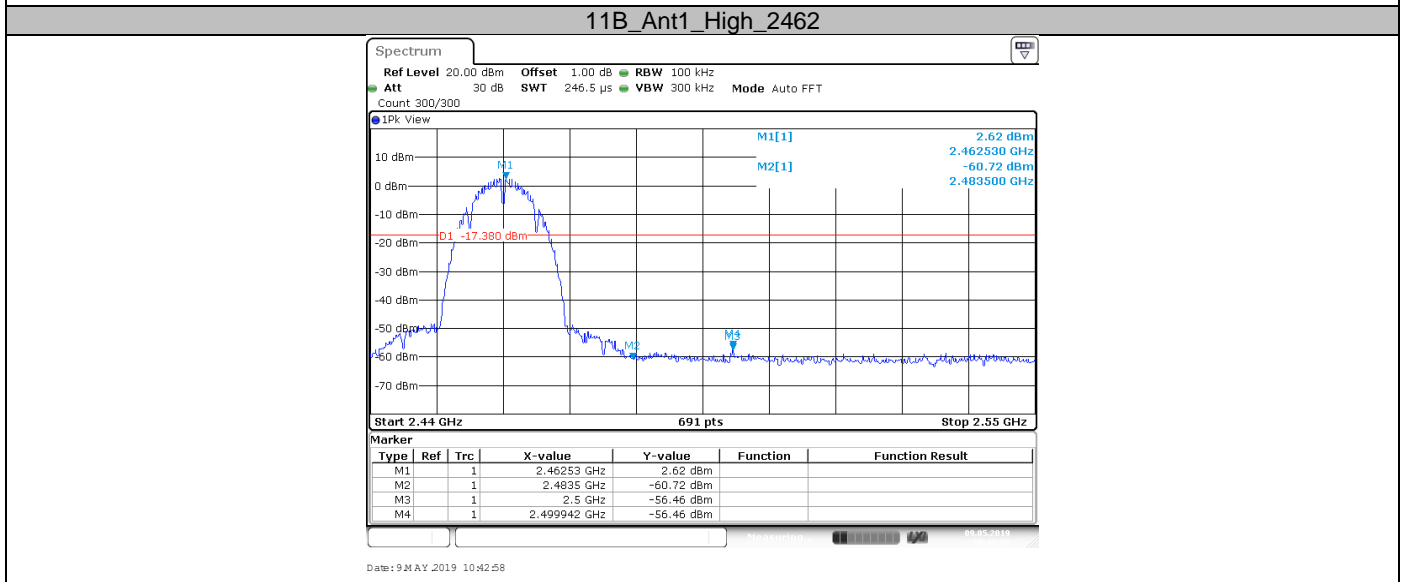
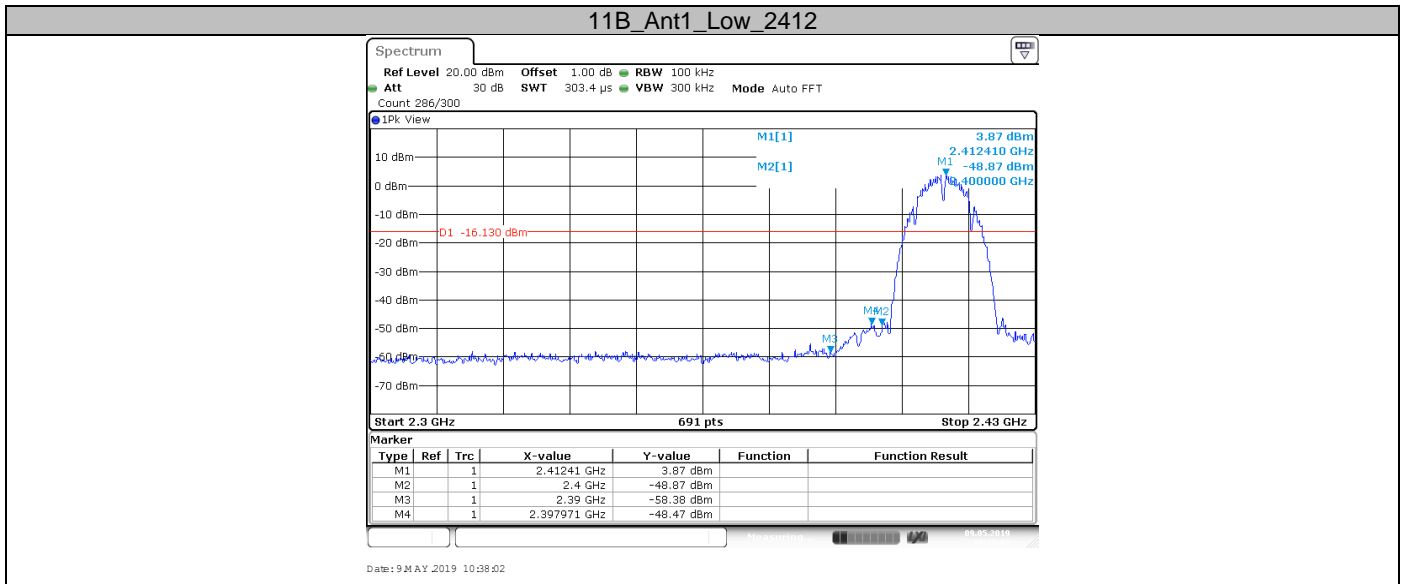

11G_Ant1_High_2462

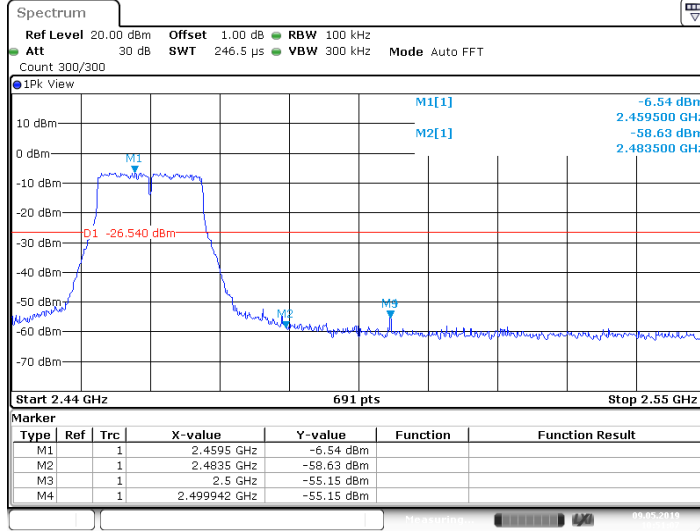

Date: 9 MAY 2019 10:51:07

11N20SISO_Ant1_Low_2412

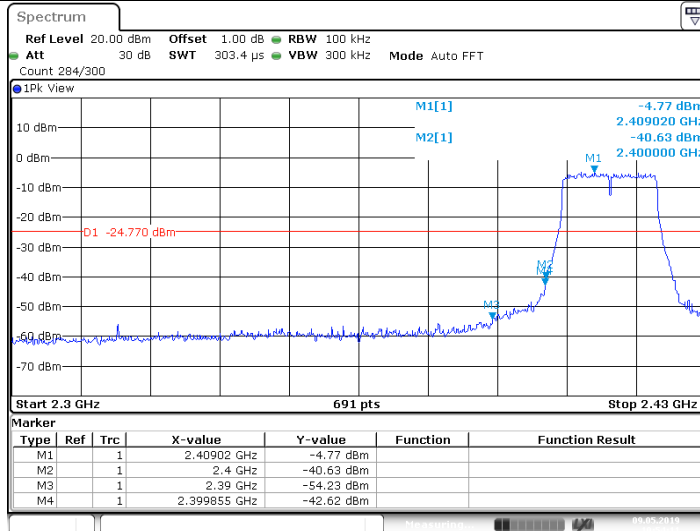

Date: 9 MAY 2019 10:54:12

11N20SISO_Ant1_High_2462

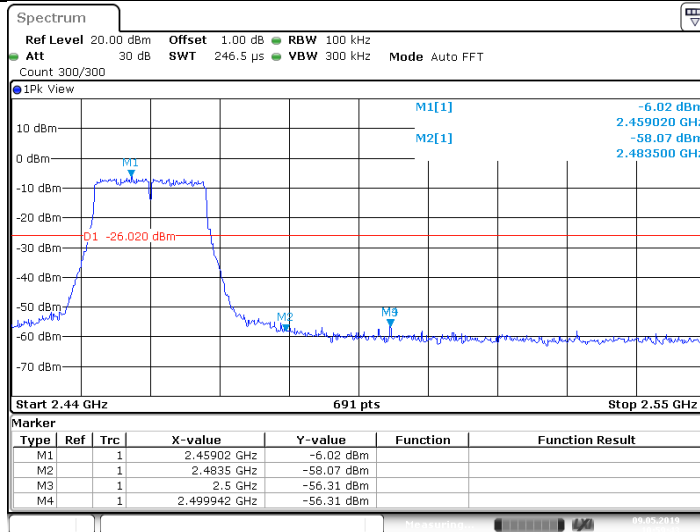

Date: 9 MAY 2019 10:59:44

11N40SISO_Ant1_Low_2422

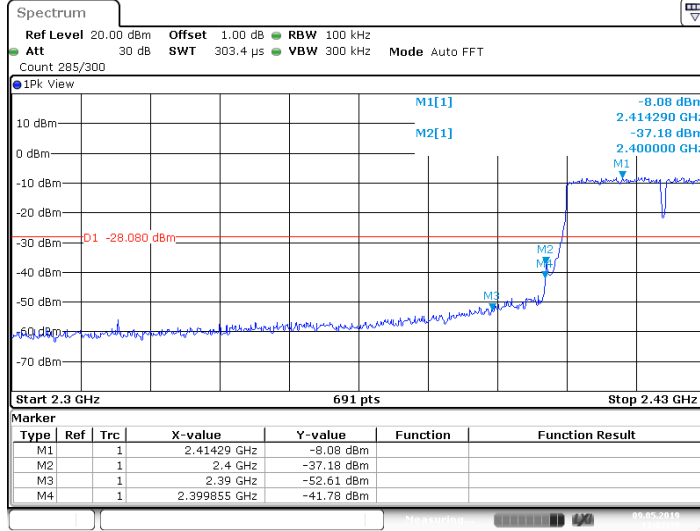

11N40SISO_Ant1_High_2452

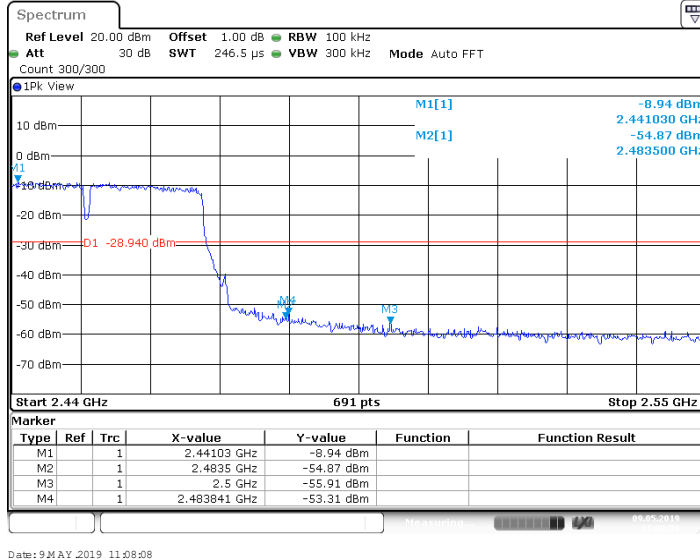

9.7 Spurious radiated emissions for transmitter

Test Method

- 1: The EUT was placed on a turn table which is 1.5m above ground plane for above 1GHz and 0.8m above ground for below 1GHz at 3meter chamber room for test. The table was rotated 360 degrees to determine the position of the highest radiation.
- 2: The EUT was set 3 meters away from the interference – receiving antenna, which was mounted on the top of a variable – height antenna tower.
- 3: The height of antenna is varied from one meter to four meters above the ground to determine the maximum value of the field strength. Both horizontal and vertical polarizations of the antenna are set to make the measurement.
- 4: For each suspected emission, the EUT was arranged to its worst case and then the antenna was tuned to heights from 1 meter to 4 meters and the rotatable table was turned from 0 degrees to 360 degrees to find the maximum reading.
- 5: Use the following spectrum analyzer settings According to C63.10:

For Above 1GHz

Span = wide enough to capture the peak level of the in-band emission and all spurious
RBW = 1MHz, $VBW \geq RBW$ for peak measurement and $VBW = 10Hz$ for average measurement, Sweep = auto, Detector function = peak, Trace = max hold.

For Below 1GHz

Use the following spectrum analyzer settings:

Span = wide enough to capture the peak level of the in-band emission and all spurious
RBW = 100 KHz, $VBW \geq RBW$ for peak measurement, Sweep = auto, Detector function = peak, Trace = max hold.

Note:

- 1: The resolution bandwidth and video bandwidth of test receiver/spectrum analyzer is 120 KHz for Quasi-peak detection (QP) at frequency below 1GHz.
- 2: The resolution bandwidth of test receiver/spectrum analyzer is 1MHz and the video bandwidth is 3MHz for peak detection (PK) at frequency above 1GHz.
- 3: The resolution bandwidth of test receiver/spectrum analyzer is 1MHz and the video bandwidth is 3MHz for RMS Average ((duty cycle < 98%) for Average detection (AV) at frequency above 1GHz, then the measurement results was added to a correction factor ($20\log(1/\text{duty cycle})$).
- 4: The resolution bandwidth of test receiver/spectrum analyzer is 1MHz and the video bandwidth is 10Hz (duty cycle > 98%) for Average detection (AV) at frequency above 1GHz.

Limit

The radio emission outside the operating frequency band shall be at least 20 dB below that in the 100 kHz bandwidth within the band that contains the highest level of the desired power. Radiated emissions which fall in the restricted bands, as defined in section 15.205, must comply with the radiated emission limits specified in section 15.209.

Frequency MHz	Field Strength uV/m	Field Strength dBµV/m	Detector
30-88	100	40	QP
88-216	150	43.5	QP
216-960	200	46	QP
960-1000	500	54	QP
Above 1000	500	54	AV
Above 1000	5000	74	PK

Spurious radiated emissions for transmitter

According to C63.10, if the peak (or quasi-peak) measured value complies with the average limit, it is unnecessary to perform an average measurement, so AV emission value did not show in below table if the peak value complies with average limit.

Transmitting spurious emission test result as below:

802.11b

2412MHz (30MHz – 1GHz)

Frequency MHz	Emission Level dBuV/m	Polarization	Limit dB μ V/m	Margin dB	Detector	Corr. dB	Result
879.612222	32.70	Horizontal	46.00	13.30	QP	-15.9	Pass
943.255000	33.40	Vertical	46.00	12.60	QP	-15.3	Pass

2412MHz (Above 1GHz)

Frequency MHz	Emission Level dBuV/m	Polarization	Limit dB μ V/m	Margin dB	Detector	Corr. dB/m	Result
17896.406250*	49.73	Horizontal	74.00	24.27	PK	21.5	Pass
17834.531250*	50.74	Vertical	74.00	23.26	PK	21.4	Pass

2437MHz (30MHz – 1GHz)

Frequency MHz	Emission Level dBuV/m	Polarization	Limit dB μ V/m	Margin dB	Detector	Corr. dB	Result
--	--	Horizontal	--	--	QP	--	Pass
--	--	Vertical	--	--	QP	--	Pass

2437MHz (Above 1GHz)

Frequency MHz	Emission Level dBuV/m	Polarization	Limit dB μ V/m	Margin dB	Detector	Corr. dB	Result
17845.312500*	49.71	Horizontal	74.00	24.29	Peak	21.4	Pass
17810.156250*	49.80	Vertical	74.00	24.20	Peak	21.4	Pass

2462MHz (30MHz – 1GHz)

Frequency MHz	Emission Level dBuV/m	Polarization	Limit dB μ V/m	Margin dB	Detector	Corr. dB	Result
--	--	Horizontal	--	--	QP	--	Pass
--	--	Vertical	--	--	QP	--	Pass

2462MHz (Above 1GHz)

Frequency MHz	Emission Level dBuV/m	Polarization	Limit dB μ V/m	Margin dB	Detector	Corr. dB	Result
17553.750000	49.73	Horizontal	74.00	24.27	Peak	21.1	Pass
17818.125000*	50.54	Vertical	74.00	23.46	Peak	21.4	Pass

802.11g

2412MHz (30MHz – 1GHz)

Frequency	Emission Level	Polarization	Limit	Margin	Detector	Corr.	Result
MHz	dBuV/m		dBµV/m	dB		dB	
--	--	Horizontal	--	--	QP	--	Pass
--	--	Vertical	--	--	QP	--	Pass

2412MHz (Above 1GHz)

Frequency	Emission Level	Polarization	Limit	Margin	Detector	Corr.	Result
MHz	dBuV/m		dBµV/m	dB		dB	
17624.062500	50.51	Horizontal	74.00	23.49	Peak	21.2	Pass
17895.000000*	49.66	Vertical	74.00	24.34	Peak	21.5	Pass

2437MHz (30MHz – 1GHz)

Frequency	Emission Level	Polarization	Limit	Margin	Detector	Corr.	Result
MHz	dBuV/m		dBµV/m	dB		dB	
--	--	Horizontal	--	--	QP	--	Pass
--	--	Vertical	--	--	QP	--	Pass

2437MHz (Above 1GHz)

Frequency	Emission Level	Polarization	Limit	Margin	Detector	Corr.	Result
MHz	dBuV/m		dBµV/m	dB		dB	
17542.500000	50.15	Horizontal	74.00	23.85	Peak	21.1	Pass
17668.125000	49.49	Vertical	74.00	24.51	Peak	21.2	Pass

2462MHz (30MHz – 1GHz)

Frequency	Emission Level	Polarization	Limit	Margin	Detector	Corr.	Result
MHz	dBuV/m		dBµV/m	dB		dB	
--	--	Horizontal	--	--	QP	--	Pass
--	--	Vertical	--	--	QP	--	Pass

2462MHz (Above 1GHz)

Frequency	Emission Level	Polarization	Limit	Margin	Detector	Corr.	Result
MHz	dBuV/m		dBµV/m	dB		dB	
17902.968750*	50.03	Horizontal	74.00	23.97	Peak	21.5	Pass
17778.750000*	50.04	Vertical	74.00	23.96	Peak	21.3	Pass

802.11nHT20

2412MHz (30MHz – 1GHz)

Frequency MHz	Emission Level dBuV/m	Polarization	Limit dBµV/m	Margin dB	Detector	Corr. dB	Result
--	--	Horizontal	--	--	QP	--	Pass
--	--	Vertical	--	--	QP	--	Pass

2412MHz (Above 1GHz)

Frequency MHz	Emission Level dBuV/m	Polarization	Limit dBµV/m	Margin dB	Detector	Corr. dB	Result
17220.000000	50.37	Horizontal	74.00	23.63	Peak	20.4	Pass
17790.468750*	50.24	Vertical	74.00	23.76	Peak	21.3	Pass

2437MHz (30MHz – 1GHz)

Frequency MHz	Emission Level dBuV/m	Polarization	Limit dBµV/m	Margin dB	Detector	Corr. dB	Result
--	--	Horizontal	--	--	QP	--	Pass
--	--	Vertical	--	--	QP	--	Pass

2437MHz (Above 1GHz)

Frequency MHz	Emission Level dBuV/m	Polarization	Limit dBµV/m	Margin dB	Detector	Corr. dB	Result
17070.468750	50.11	Horizontal	74.00	23.89	Peak	20.2	Pass
17578.125000	49.46	Vertical	74.00	24.54	Peak	21.1	Pass

2462MHz (30MHz – 1GHz)

Frequency MHz	Emission Level dBuV/m	Polarization	Limit dBµV/m	Margin dB	Detector	Corr. dB	Result
--	--	Horizontal	--	--	QP	--	Pass
--	--	Vertical	--	--	QP	--	Pass

2462MHz (Above 1GHz)

Frequency MHz	Emission Level dBuV/m	Polarization	Limit dBµV/m	Margin dB	Detector	Corr. dB	Result
17874.843750*	49.49	Horizontal	74.00	24.51	Peak	21.4	Pass
17902.031250*	50.24	Vertical	74.00	23.76	Peak	21.5	Pass

802.11nHT40

2422MHz (30MHz – 1GHz)

Frequency	Emission Level	Polarization	Limit	Margin	Detector	Corr.	Result
MHz	dBuV/m		dBuV/m	dB		dB	
--	--	Horizontal	--	--	QP	--	Pass
--	--	Vertical	--	--	QP	--	Pass

2422MHz (Above 1GHz)

Frequency	Emission Level	Polarization	Limit	Margin	Detector	Corr.	Result
MHz	dBuV/m		dBuV/m	dB		dB	
9516.562500	41.32	Horizontal	74.00	32.68	Peak	9.1	Pass
11282.812500*	39.51	Vertical	74.00	34.49	Peak	8.7	Pass

2437MHz (30MHz – 1GHz)

Frequency	Emission Level	Polarization	Limit	Margin	Detector	Corr.	Result
MHz	dBuV/m		dBuV/m	dB		dB	
--	--	Horizontal	--	--	QP	--	Pass
--	--	Vertical	--	--	QP	--	Pass

2437MHz (Above 1GHz)

Frequency	Emission Level	Polarization	Limit	Margin	Detector	Corr.	Result
MHz	dBuV/m		dBuV/m	dB		dB	
9369.843750*	41.55	Horizontal	74.00	32.45	Peak	8.6	Pass
13164.843750	43.99	Vertical	74.00	30.01	Peak	13.9	Pass

2452MHz (30MHz – 1GHz)

Frequency	Emission Level	Polarization	Limit	Margin	Detector	Corr.	Result
MHz	dBuV/m		dBuV/m	dB		dB	
--	--	Horizontal	--	--	QP	--	Pass
--	--	Vertical	--	--	QP	--	Pass

2452MHz (Above 1GHz)

Frequency	Emission Level	Polarization	Limit	Margin	Detector	Corr.	Result
MHz	dBuV/m		dBuV/m	dB		dB	
13175.625000	45.34	Horizontal	74.00	28.66	Peak	14.0	Pass
13519.218750	44.48	Vertical	74.00	29.52	Peak	13.2	Pass

Remark:

- (1) “**” means the emission(s) appear within the restrict bands shall follow the requirement of section 15.205.
- (2) Data of measurement within this frequency range shown “--” in the table above means the reading of emissions are the noise floor or attenuated more than 10dB below the permissible limits or the field strength is too small to be measured.
- (3) Below 1GHz: Level=Reading Level + Correction Factor
Correction Factor=Antenna Factor + Cable Loss
(The Reading Level is recorded by software which is not shown in the sheet)
- (4) Above 1GHz: Level=Reading Level + Correction Factor
Correction Factor=Antenna Factor + Cable Loss – Pre-amplifier
(The Reading Level is recorded by software which is not shown in the sheet)

10 Test Equipment List

Radiated Emission Test

DESCRIPTION	MANUFACTURER	MODEL NO.	SERIAL NO.	CAL. DUE DATE
EMI Test Receiver	Rohde & Schwarz	ESR 26	101269	2019-7-6
Trilog Super Broadband Test Antenna	Schwarzbeck	VULB 9163	707	2019-6-28
Horn Antenna	Rohde & Schwarz	HF907	102294	2019-6-28
Pre-amplifier	Rohde & Schwarz	SCU 18	102230	2019-7-6
Signal Generator	Rohde & Schwarz	SMY01	839369/005	2019-7-6
Attenuator	Agilent	8491A	MY39264334	2019-7-6
3m Semi-anechoic chamber	TDK	9X6X6	----	2020-7-7
Test software	Rohde & Schwarz	EMC32	Version 9.15.00	N/A

Conducted Emission Test

DESCRIPTION	MANUFACTURER	MODEL NO.	SERIAL NO.	CAL. DUE DATE
EMI Test Receiver	Rohde & Schwarz	ESR 3	101782	2019-7-6
LISN	Rohde & Schwarz	ENV4200	100249	2019-7-6
LISN	Rohde & Schwarz	ENV432	101318	2019-7-6
LISN	Rohde & Schwarz	ENV216	100326	2019-7-6
ISN	Rohde & Schwarz	ENY81	100177	2019-7-6
ISN	Rohde & Schwarz	ENY81-CA6	101664	2019-7-6
High Voltage Probe	Rohde & Schwarz	TK9420(VT9420)	9420-584	2019-6-30
RF Current Probe	Rohde & Schwarz	EZ-17	100816	2019-6-30
Attenuator	Shanghai Huaxiang	TS2-26-3	080928189	2019-7-6
Test software	Rohde & Schwarz	EMC32	Version9.15.00	N/A

RF Conducted Test

DESCRIPTION	MANUFACTURER	MODEL NO.	SERIAL NO.	CAL. DUE DATE
Signal Analyzer	Rohde & Schwarz	FSV40	101030	2019-7-6
RF Switch Module	Rohde & Schwarz	OSP120/OSP-B157	101226/100851	2019-7-6
Test software	Tonscend	System for BT/WIFI	Version 2.6	N/A



11 System Measurement Uncertainty

For a 95% confidence level, the measurement expanded uncertainties for defined systems, in accordance with the recommendations of ISO 17025 were:

System Measurement Uncertainty

System Measurement Uncertainty	
Items	Extended Uncertainty
Uncertainty for Radiated Spurious Emission 25MHz-3000MHz	Horizontal: 4.80dB; Vertical: 4.87dB;
Uncertainty for Radiated Spurious Emission 3000MHz-18000MHz	Horizontal: 4.59dB; Vertical: 4.58dB;
Uncertainty for Radiated Spurious Emission 18000MHz-40000MHz	Horizontal: 5.05dB; Vertical: 5.04dB;
Uncertainty for Conducted RF test with TS 8997	RF Power Conducted: 1.16dB Frequency test involved: 0.6x10 ⁻⁷ or 1%
Uncertainty for Conducted Emission 150kHz-30MHz (for test using AMN ENV432 or ENV4200)	3.21dB