

# Test Report

FCCID: 2AB22-ESWD16

Date of issue: June 03, 2019

Report Number:	MTi190531E194
Sample Description:	Smart WiFi Dimmer Switch
Model(s):	ESWD16
Applicant:	Etekcitey Corporation
Address:	1202 N Miller St. Suite A, Anaheim, CA 92806, USA
Date of Test:	May 20, 2019 to June 03, 2019

Shenzhen Microtest Co., Ltd.  
<http://www.mtitest.com>

## Table of Contents

<b>1</b>	<b>GENERAL INFORMATION</b>	<b>5</b>
1.1	DESCRIPTION OF EUT	5
1.2	OPERATION CHANNEL LIST	6
1.3	TEST CHANNEL LIST	6
1.4	ANCILLARY EQUIPMENT LIST	6
1.5	DESCRIPTION OF SUPPORT UNITS	6
<b>2</b>	<b>SUMMARY OF TEST RESULTS</b>	<b>7</b>
<b>3</b>	<b>TEST FACILITIES AND ACCREDITATIONS</b>	<b>8</b>
3.1	TEST LABORATORY	8
3.2	ENVIRONMENTAL CONDITIONS	8
3.3	MEASUREMENT UNCERTAINTY	8
3.4	TEST SOFTWARE	8
<b>4</b>	<b>EQUIPMENT LIST</b>	<b>9</b>
<b>5</b>	<b>TEST RESULT</b>	<b>10</b>
5.1	ANTENNA REQUIREMENT	10
5.1.1	<i>Standard requirement</i>	10
5.1.2	<i>EUT Antenna</i>	10
5.2	PEAK OUTPUT POWER	11
5.2.1	<i>Limit</i>	11
5.2.2	<i>Test setup</i>	11
5.2.3	<i>Test procedure</i>	11
5.2.4	<i>Test results</i>	12
5.3	POWER SPECTRAL DENSITY	13
5.3.1	<i>Limit</i>	13
5.3.2	<i>Test Setup</i>	13
5.3.3	<i>Test Procedure</i>	13
5.3.4	<i>Test Results</i>	14
5.4	CONDUCTED EMISSION	17
5.4.1	<i>Limits</i>	17
5.4.2	<i>Test setup</i>	17
5.4.3	<i>Test procedure</i>	18
5.4.4	<i>Test results</i>	19
5.5	RADIATED SPURIOUS	23
5.5.1	<i>Limits</i>	23
5.5.2	<i>Test setup</i>	24
5.5.3	<i>Test procedure</i>	25
5.5.4	<i>Test results</i>	26
5.5.4.1	<i>Radiation emission</i>	26
5.5.4.2	<i>Band edge - radiated</i>	30
5.5.4.3	<i>Spurious Emission in Restricted Band 3260MHz-18000MHz</i>	32
5.6	BAND EDGE - CONDUCTED	33
5.6.1	<i>Limits</i>	33
5.6.2	<i>Test setup</i>	33
5.6.3	<i>Test procedure</i>	33
5.6.4	<i>Test results</i>	34
5.7	6dB BANDWIDTH	37
5.7.1	<i>Limit</i>	37
5.7.2	<i>Test setup</i>	37
5.7.3	<i>Test procedure</i>	37
5.7.4	<i>Test results</i>	38
5.8	SPURIOUS RF CONDUCTED EMISSIONS	44
5.8.1	<i>Conformance Limit</i>	44
5.8.2	<i>Measuring Instruments</i>	44

5.8.3 Test Setup .....44  
5.8.4 Test Procedure.....44  
5.8.5 Test Results.....44

**PHOTOGRAPHS OF THE TEST SETUP..... 48**

**PHOTOGRAPHS OF THE EUT..... 50**

# Test Result Certification

Applicant's name: Etekcitey Corporation

Address: 1202 N Miller St. Suite A, Anaheim, CA 92806, USA

Manufacture's Name: Dongguan Raiwee Electronic Technology Co., Ltd

Address: Building 11, Antouling, Industry Avenue, Qinghu Village, Qishi Town, Dongguan, Guangdong, China

Product name: Smart WiFi Dimmer Switch

Trademark: ETEKCITY

Model name: ESWD16

Standards: FCC Part 15.247

Test Procedure: ANSI C63.10-2013  
KDB 558074 D01 DTS Meas Guidance v05r02

*This device described above has been tested by Shenzhen Microtest Co., Ltd. and the test results show that the equipment under test (EUT) compliance with the FCC requirements. And it is applicable only to the tested sample identified in the report.*

Tested by:



Jone Lee

June 03, 2019

Reviewed by:



Blue Zheng

June 03, 2019

Approved by:



Smith Chen

June 03, 2019

## 1 General information

### 1.1 Description of EUT

Product name:	Smart WiFi Dimmer Switch
Model name:	ESWD16
Serial Model:	N/A
Model difference:	N/A
Operation frequency:	802.11b/g/n20:2412~2462 MHz
Modulation type:	IEEE 802.11b : DSSS (DBPSK, DQPSK, CCK) IEEE 802.11g/n (HT20) : OFDM (64QAM, 16QAM, QPSK, BPSK)
Bit Rate of transmitter:	802.11b:11/5.5/2/1 Mbps 802.11g:54/48/36/24/18/12/9/6Mbps 802.11n(20MHz) use 800 ns GI: 65.0/58.5/52.0/39.0/26.0/19.5/13.0/6.5 Mbps (MCS0~MCS7)
Antenna type:	Spring Antenna
Antenna gain:	0.66dBi
Max. output power:	15.08dBm
Power supply:	AC 120V/60Hz
Battery:	N/A
Adapter information:	N/A
Hardware version:	V1.3
Software version:	V1.3
Duty Cycle:	100%

1.2 Operation channel list

Channel List for 802.11b/g/n(20)

Channel	Frequency (MHz)	Channel	Frequency (MHz)
01	2412	07	2442
02	2417	08	2447
03	2422	09	2452
04	2427	10	2457
05	2432	11	2462
06	2437	\	\

1.3 Test channel list

Channel List for 802.11b/g/n(20)

Channel	Channel	Frequency (MHz)
Low	01	2412
Middle	06	2437
High	11	2462

1.4 Ancillary equipment list

Equipment	Model	S/N	Manufacturer	Certificate type
/	/	/	/	/

1.5 Description of Support Units

The EUT has been tested as an independent unit together with other necessary accessories or support units. The following support units or accessories were used to form a representative test configuration during the tests.

Item	Equipment	Brand	Model/Type No.	Series No.	Note
/	/	/	/	/	/

Note:

- (1)The support equipment was authorized by Declaration of Confirmation.
- (2)For detachable type I/O cable should be specified the length in cm in 『Length』 column.

## 2 Summary of Test Results

Test procedures according to the technical standards:

No.	Standard Section	Test Item	Result	Remark
1	15.203	Antenna Requirement	Pass	
2	15.247 (b)	Peak Output Power	Pass	
3	15.247 (e)	Power Spectral Density	Pass	
4	15.207	Conducted Emission	Pass	
5	15.247 (d) & 15.209	Radiated Spurious Emission	Pass	
6	15.205	Band Edge Emission	Pass	
7	15.247 (a)(2)	6dB Bandwidth	Pass	
8	15.205	Spurious RF Conducted Emissions	Pass	

### 3 Test Facilities and Accreditations

#### 3.1 Test laboratory

Test Laboratory	Shenzhen Microtest Co., Ltd
Location	No.102A & 302A, East Block, Hengfang Industrial Park, Xingye Road, Xixiang, Bao'an District, Shenzhen, Guangdong, China
FCC Registration No.:	FCC Registration No.: 448573

#### 3.2 Environmental conditions

Temperature:	15°C~35°C
Humidity	20%~75%
Atmospheric pressure	98kPa~101kPa

#### 3.3 Measurement uncertainty

The reported uncertainty of measurement  $y \pm U$  where expanded uncertainty  $U$  is based on a standard uncertainty multiplied by a coverage factor of  $k=2$  providing a level of confidence of approximately 95 %

No.	Item	Uncertainty
1	Conducted Emission Test	$\pm 1.38\text{dB}$
2	RF power, conducted	$\pm 0.16\text{dB}$
3	Spurious emissions, conducted	$\pm 0.21\text{dB}$
4	All emissions, radiated(<1G)	$\pm 4.68\text{dB}$
5	All emissions, radiated(>1G)	$\pm 4.89\text{dB}$
6	Temperature	$\pm 0.5^\circ\text{C}$
7	Humidity	$\pm 2\%$

#### 3.4 Test software

Software Name	Manufacturer	Model	Version
RF Test System	Farad	LZ-RF	Lz_Rf 3A3



## 4 Equipment list

Equipment No.	Equipment Name	Manufacturer	Model	Serial No.	Calibration date	Due date
MTI-E001	Spectrum Analyzer	Agilent	E4407B	MY41441082	2018/09/18	2019/09/17
MTI-E003	Spectrum Analyzer	R&S	ESCI	MTI-E003	2018/09/18	2019/09/17
MTI-E004	EMI Test Receiver	Rohde&schwarz	ESPI	1000314	2018/09/18	2019/09/17
MTI-E006	Broadband antenna	schwarabeck	VULB9163	872	2018/09/18	2019/09/17
MTI-E007	Horn antenna	schwarabeck	BBHA9120D	1201	2018/09/18	2019/09/17
MTI-E014	amplifier	America	8447D	3113A06150	2018/09/18	2019/09/17
MTI-E015	Conduction Immunity Signal Generator	Schloder	CDG6000	126A1343/2015	2018/09/18	2019/09/17
MTI-E016	Coupled decoupling network	Schloder	CND M2/M3	A2210332/2015	2018/09/18	2019/09/17
MTI-E034	amplifier	Agilent	8449B	3008A02400	2018/09/18	2019/09/17
MTI-E037	Artificial power network	Schwarzbeck	NSLK8127	#841	2018/09/18	2019/09/17
MTI-E040	Spectrum analyzer	Agilent	N9020A	MY49100060	2018/09/18	2019/09/17
MTI-E041	Signal generator	Agilent	N5182A	MY49060455	2018/09/18	2019/09/17
MTI-E042	Analog signal generator	Agilent	E4421B	GB40051240	2018/09/18	2019/09/17
MTI-E043	Power sensor	Dare Instruments	RPR3006W	16I00054SN O16	2018/09/18	2019/09/17
MTI-E047	10dB attenuator	Mini-Circuits	UNAT-10+	15542	2018/09/18	2019/09/17
MTI-E049	spectrum analyzer	Rohde&schwarz	FSP-38	100019	2018/09/18	2019/09/17
MTI-E050	PSG Signal generator	Agilent	E8257D	MY46520873	2018/09/18	2019/09/17
MTI-E061	Active Loop Antenna 9kHz - 30MHz	Schwarzbeek	FMZB 1519 B	00044	2018/09/18	2019/09/17
MTI-E052	18-40GHz amplifier	Chengdu step Micro Technology	ZLNA-18-40G-21	1608001	2018/09/18	2019/09/17
MTI-E053	15-40G Antenna	Schwarzbeek	BBHA9170	BBHA9170582	2018/09/18	2019/09/17
MTI-E058	Artificial power network	Schwarzbeck	NSLK8127	#841	2018/09/18	2019/09/17

Note: the calibration interval of the above test instruments is 12 months and the calibrations are traceable to international system unit (SI).

## 5 Test Result

### 5.1 Antenna requirement

#### 5.1.1 Standard requirement

15.203 requirement: For intentional device, according to 15.203: an intentional radiator shall be designed to ensure that no antenna other than that furnished by the responsible party shall be used with the device

#### 5.1.2 EUT Antenna

The EUT antenna is Spring antenna (0.66dBi). It comply with the standard requirement. In case of replacement of broken antenna the same antenna type must be used.

## 5.2 Peak output power

### 5.2.1 Limit

FCC Part15 Subpart C				
Section	Test Item	Limit	Frequency Range (MHz)	Result
15.247(b)(3)	Peak output power	1 watt or 30dBm	2400-2483.5	Pass

### 5.2.2 Test setup

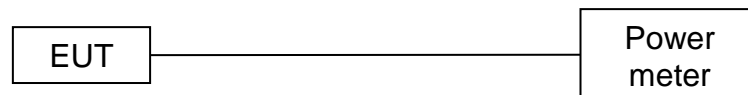

### 5.2.3 Test procedure

The EUT was directly connected to the Power meter.

5.2.4 Test results

802.11b

Test Channel	Frequency (MHz)	Maximum Peak Conducted Output Power(dBm)	Limit (dBm)
CH01	2412	15.08	30
CH06	2437	13.98	30
CH11	2462	14.88	30

802.11g

Test Channel	Frequency (MHz)	Maximum Peak Conducted Output Power(dBm)	Limit (dBm)
CH01	2412	12.10	30
CH06	2437	13.99	30
CH11	2462	12.96	30

802.11n20

Test Channel	Frequency (MHz)	Maximum Peak Conducted Output Power(dBm)	Limit (dBm)
CH01	2412	11.24	30
CH06	2437	10.48	30
CH11	2462	10.84	30

### 5.3 Power spectral density

#### 5.3.1 Limit

FCC Part15 Subpart C				
Section	Test Item	Limit	Frequency Range (MHz)	Result
15.247	Power Spectral Density	8 dBm (in any 3kHz)	2400-2483.5	Pass

#### 5.3.2 Test Setup



#### 5.3.3 Test Procedure

- a. The EUT tested system was configured as the statements of 2.1 unless otherwise a special operating condition is specified in the follows during the testing.
- b. Set analyzer center frequency to DTS channel center frequency.
- c. Set the span to 1.5 times the DTS channel bandwidth.
- d. Set the RBW  $\geq 3$  kHz.
- e. Set the VBW  $\geq 3 \times$  RBW.
- f. Detector = peak.
- g. Sweep time = auto couple.
- h. Trace mode = max hold.
- i. Allow trace to fully stabilize.
- j. Use the peak marker function to determine the maximum amplitude level.
- k. If measured value exceeds limit, reduce RBW (no less than 3 kHz) and repeat.

5.3.4 Test Results

802.11b			
Frequency	Power Density (dBm/3kHz)	Limit (dBm/3kHz)	Result
2412 MHz	-12.607	8	Pass
2437 MHz	-14.076	8	Pass
2462 MHz	-12.416	8	Pass

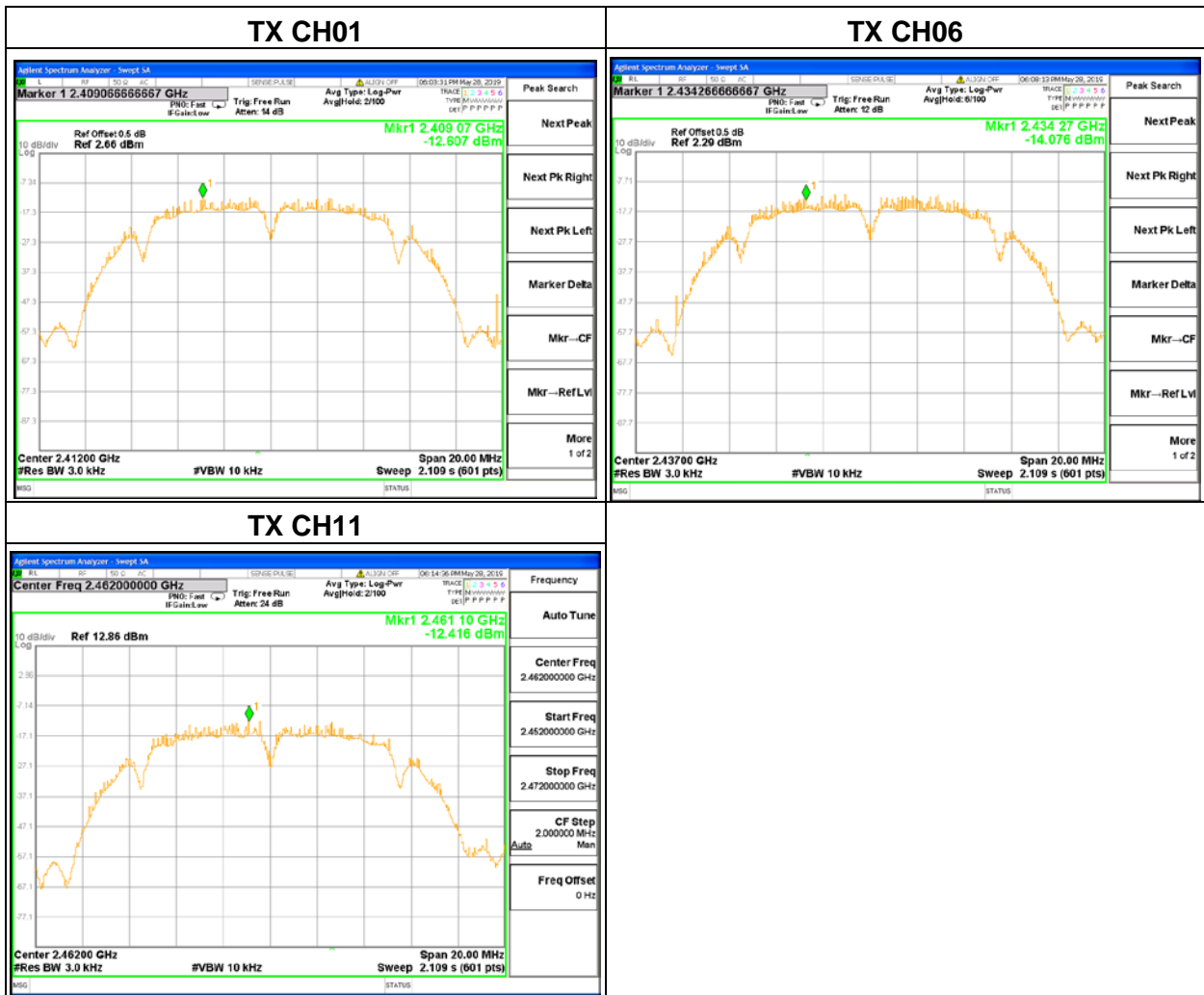

802.11g			
Frequency	Power Density (dBm/3kHz)	Limit 8(dBm/3kHz)	Result
2412 MHz	-13.737	8	Pass
2437 MHz	-12.461	8	Pass
2462 MHz	-14.638	8	Pass

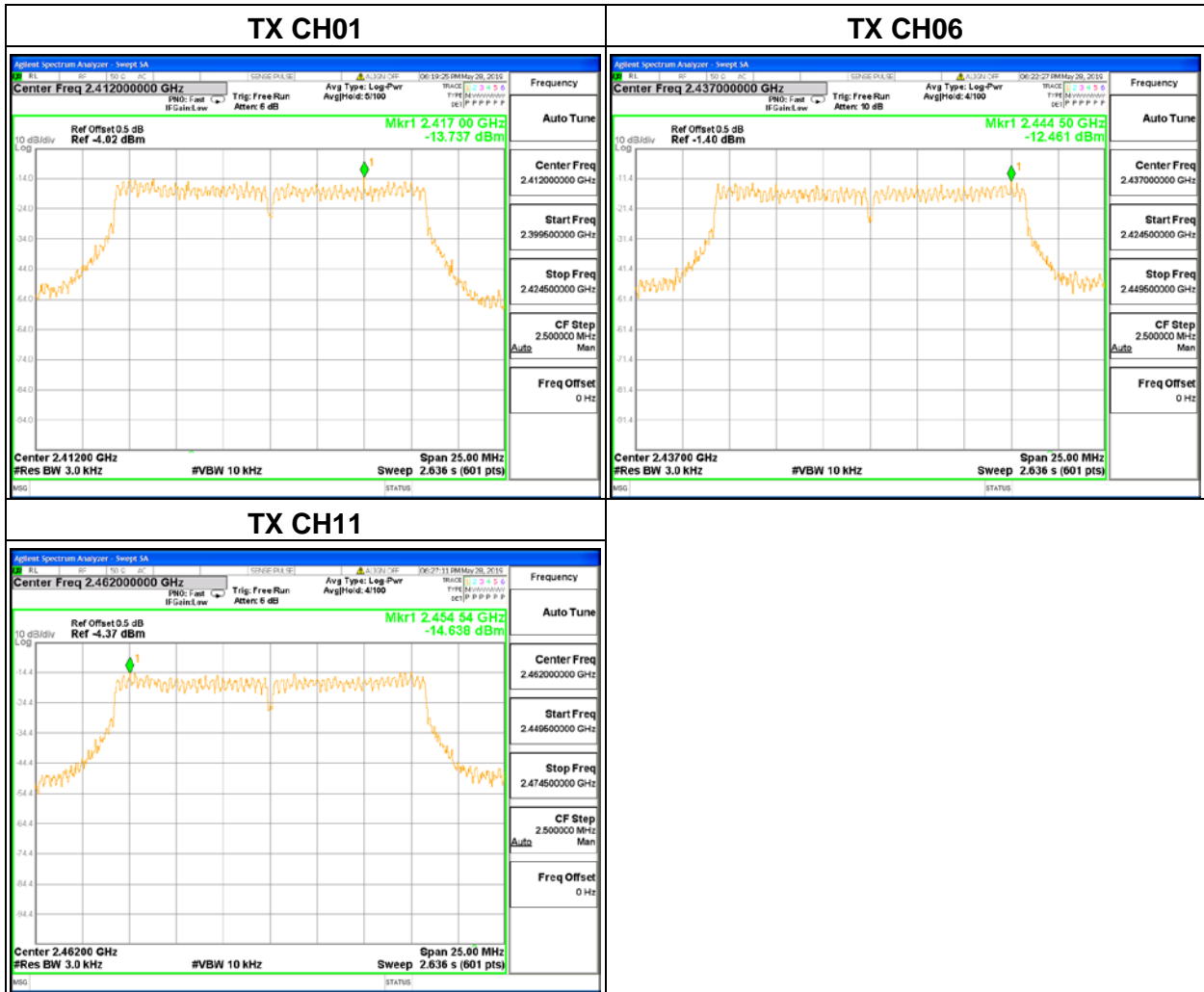

802.11n20			
Frequency	Power Density (dBm/3kHz)	Limit 8(dBm/3kHz)	Result
2412 MHz	-15.274	8	Pass
2437 MHz	-14.916	8	Pass
2462 MHz	-15.746	8	Pass

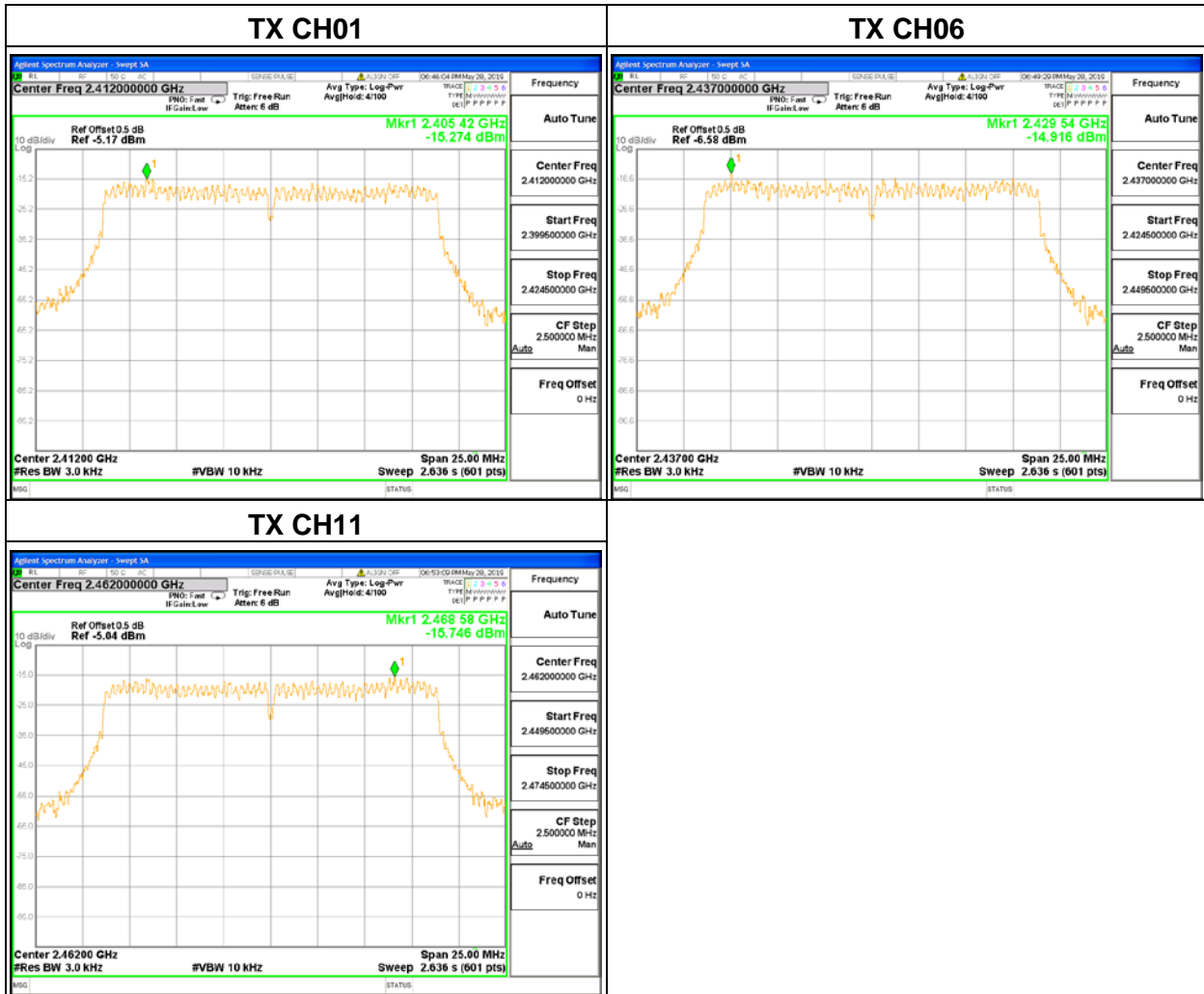



5.4 Conducted emission

5.4.1 Limits

According to FCC Part 15.207(a) and KDB 174176 D01 Line Conducted FAQ v01r01.

FREQUENCY (MHz)	Class B (dBuV)	
	Quasi-peak	Average
0.15 -0.5	66 - 56 *	56 - 46 *
0.50 -5.0	56.00	46.00
5.0 -30.0	60.00	50.00

Note

(1)The tighter limit applies at the band edges.

(2)The limit of " \* " marked band means the limitation decreases linearly with the logarithm of the frequency in the range.

5.4.2 Test setup

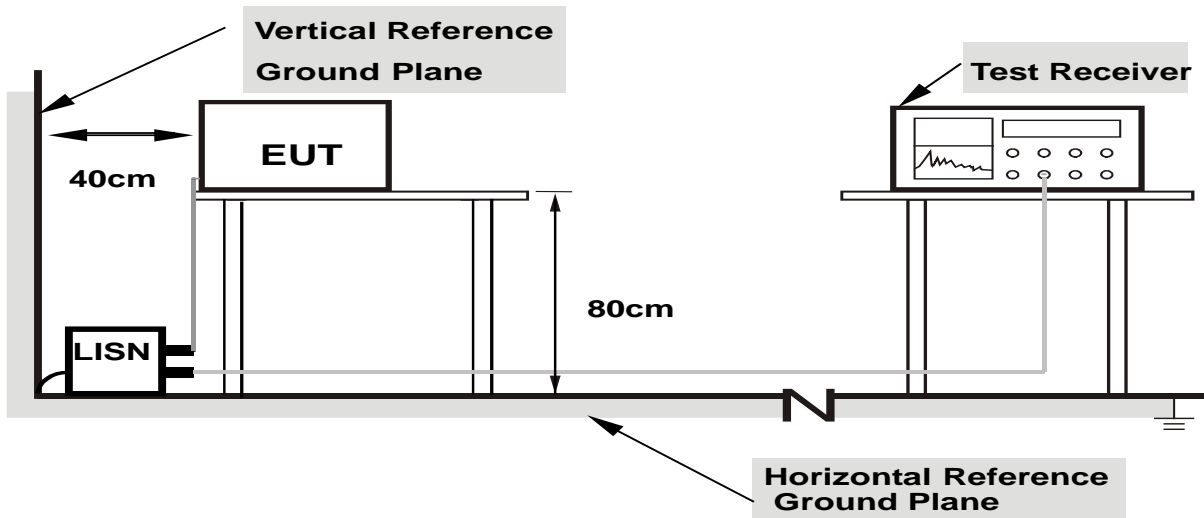

**Note: 1.Support units were connected to second LISN.**

**2.Both of LISNs (AMN) are 80 cm from EUT and at least 80 from other units and other metal planes**

### 5.4.3 Test procedure

#### a. EUT Operating Conditions

The EUT was configured for testing in a typical fashion (as a customer would normally use it). The EUT has been programmed to continuously transmit during test. This operating condition was tested and used to collect the included data.

#### b. The following table is the setting of the receiver

Receiver Parameters	Setting
Attenuation	10 dB
Start Frequency	0.15 MHz
Stop Frequency	30 MHz
IF Bandwidth	9 kHz

- c. The EUT was placed 0.8 meters from the horizontal ground plane with EUT being connected to the power mains through a line impedance stabilization network (LISN). All other support equipments powered from additional LISN(s). The LISN provide 50 Ohm/ 50uH of coupling impedance for the measuring instrument.
- d. Interconnecting cables that hang closer than 40 cm to the ground plane shall be folded back and forth in the center forming a bundle 30 to 40 cm long.
- e. I/O cables that are not connected to a peripheral shall be bundled in the center. The end of the cable may be terminated, if required, using the correct terminating impedance. The overall length shall not exceed 1 m.
- f. LISN at least 80 cm from nearest part of EUT chassis.

For the actual test configuration, please refer to the related Item –EUT Test Photos.

5.4.4 Test results

EUT :	Smart WiFi Dimmer Switch	Model Name. :	ESWD16
Temperature :	26.3 °C	Relative Humidity :	74%
Pressure :	1010hPa	Phase :	L
Test Voltage :	AC 120V/60Hz	Test Mode :	Normal link

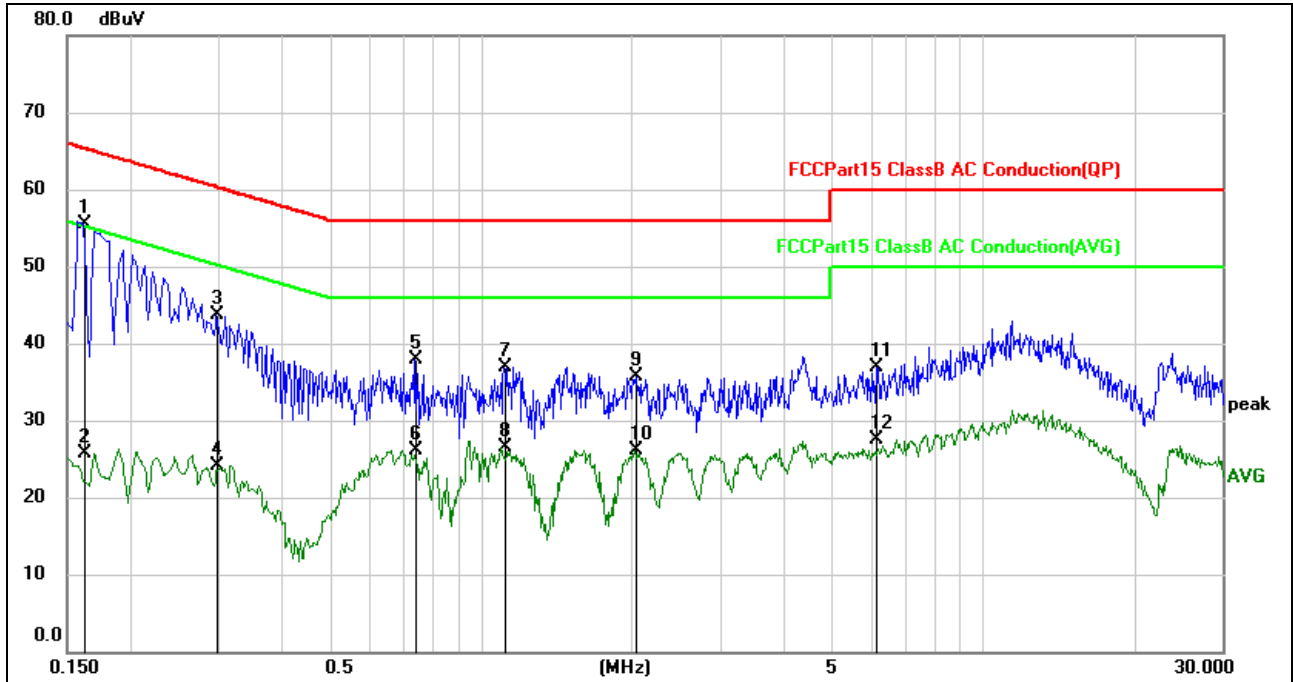

No.	Mk.	Freq. MHz	Reading Level dBuV	Correct Factor dB	Measure- ment dBuV	Limit dBuV	Over dB	Detector	Comment
1	*	0.1620	45.82	9.73	55.55	65.36	-9.81	QP	
2		0.1620	16.06	9.73	25.79	55.36	-29.57	AVG	
3		0.2980	33.97	9.76	43.73	60.30	-16.57	QP	
4		0.2980	14.37	9.76	24.13	50.30	-26.17	AVG	
5		0.7420	28.04	9.91	37.95	56.00	-18.05	QP	
6		0.7420	16.22	9.91	26.13	46.00	-19.87	AVG	
7		1.1140	27.05	9.95	37.00	56.00	-19.00	QP	
8		1.1140	16.57	9.95	26.52	46.00	-19.48	AVG	
9		2.0340	25.69	9.97	35.66	56.00	-20.34	peak	
10		2.0340	16.19	9.97	26.16	56.00	-29.84	peak	
11		6.1420	26.74	10.11	36.85	60.00	-23.15	QP	
12		6.1420	17.35	10.11	27.46	50.00	-22.54	AVG	

EUT :	Smart WiFi Dimmer Switch	Model Name. :	ESWD16
Temperature :	26.3 °C	Relative Humidity :	74%
Pressure :	1010hPa	Phase :	N
Test Voltage :	AC 120V/60Hz	Test Mode :	Normal link

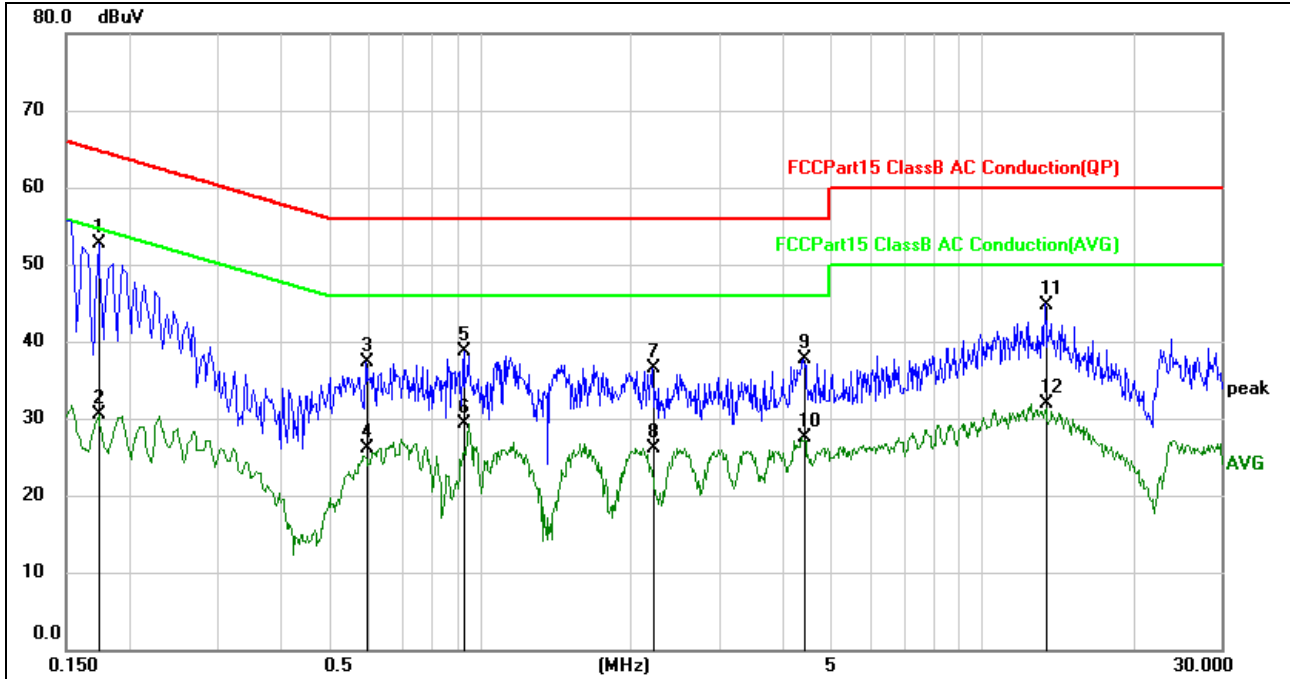

No.	Mk.	Freq.	Reading Level	Correct Factor	Measurement	Limit	Over	Detector	Comment
		MHz	dBuV	dB	dBuV	dBuV	dB		
1	*	0.1740	42.99	9.73	52.72	64.77	-12.05	QP	
2		0.1740	20.68	9.73	30.41	54.77	-24.36	AVG	
3		0.5940	27.49	9.89	37.38	56.00	-18.62	QP	
4		0.5940	16.24	9.89	26.13	46.00	-19.87	AVG	
5		0.9300	28.68	9.94	38.62	56.00	-17.38	QP	
6		0.9300	19.35	9.94	29.29	46.00	-16.71	AVG	
7		2.2060	26.58	9.98	36.56	56.00	-19.44	QP	
8		2.2060	16.12	9.98	26.10	46.00	-19.90	AVG	
9		4.4260	27.59	10.04	37.63	56.00	-18.37	QP	
10		4.4260	17.42	10.04	27.46	46.00	-18.54	AVG	
11		13.3860	34.58	10.22	44.80	60.00	-15.20	QP	
12		13.3860	21.62	10.22	31.84	50.00	-18.16	AVG	

EUT :	Smart WiFi Dimmer Switch	Model Name. :	ESWD16
Temperature :	26.3 °C	Relative Humidity :	74%
Pressure :	1010hPa	Phase :	L
Test Voltage :	AC 240V/60Hz	Test Mode :	Normal link

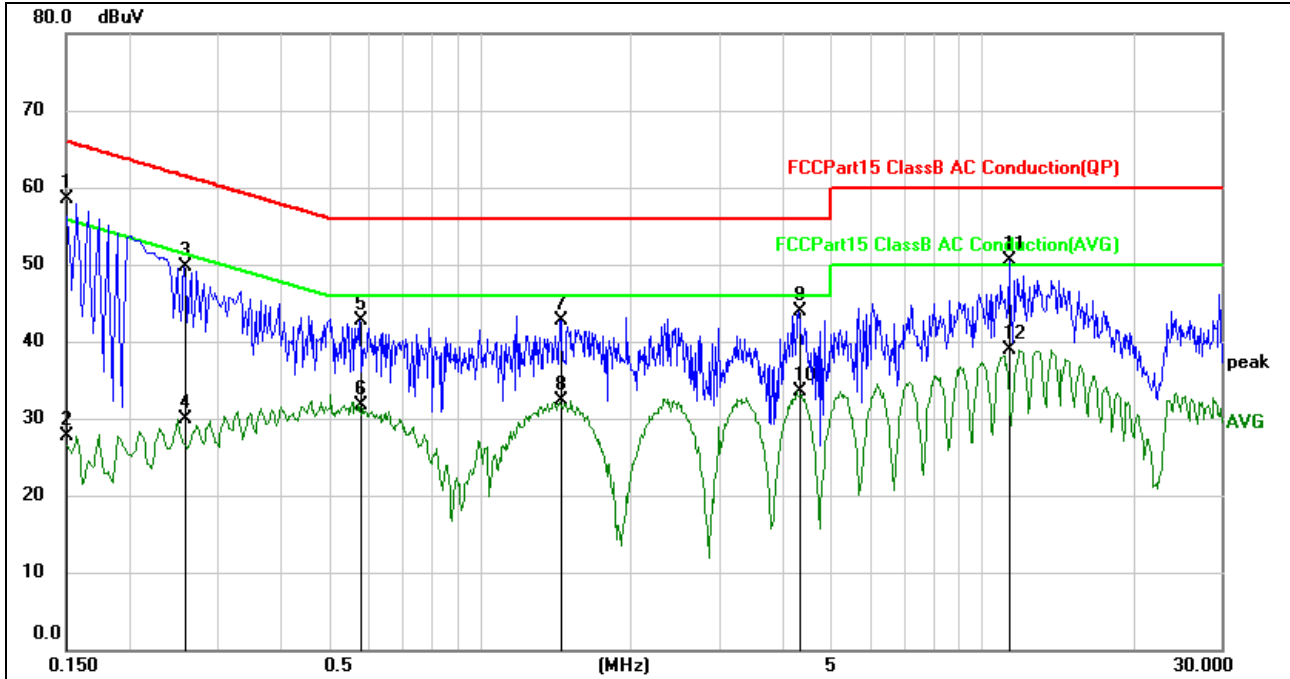

No.	Mk.	Freq. MHz	Reading Level dBuV	Correct Factor dB	Measure- ment dBuV	Limit dBuV	Over dB	Detector	Comment
1	*	0.1500	48.84	9.73	58.57	66.00	-7.43	QP	
2		0.1500	17.91	9.73	27.64	56.00	-28.36	AVG	
3		0.2580	39.95	9.74	49.69	61.50	-11.81	QP	
4		0.2580	20.16	9.74	29.90	51.50	-21.60	AVG	
5		0.5780	32.91	9.89	42.80	56.00	-13.20	QP	
6		0.5780	21.91	9.89	31.80	46.00	-14.20	AVG	
7		1.4540	32.80	9.96	42.76	56.00	-13.24	QP	
8		1.4540	22.28	9.96	32.24	46.00	-13.76	AVG	
9		4.3220	33.79	10.03	43.82	56.00	-12.18	QP	
10		4.3220	23.48	10.03	33.51	46.00	-12.49	AVG	
11		11.3580	40.24	10.26	50.50	60.00	-9.50	QP	
12		11.3580	28.60	10.26	38.86	50.00	-11.14	AVG	

EUT :	Smart WiFi Dimmer Switch	Model Name. :	ESWD16
Temperature :	26.3 °C	Relative Humidity :	74%
Pressure :	1010hPa	Phase :	N
Test Voltage :	AC 240V/60Hz	Test Mode :	Normal link

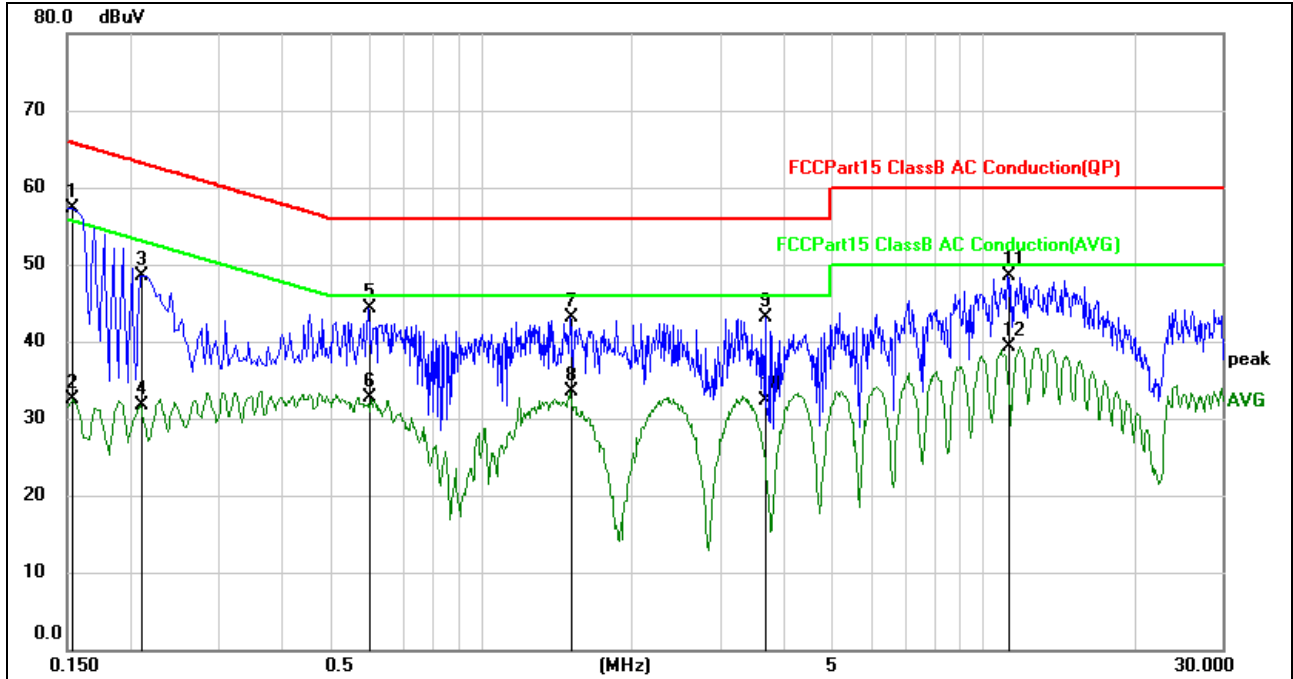

No.	Mk.	Freq. MHz	Reading Level dBuV	Correct Factor dB	Measure- ment dBuV	Limit dBuV	Over dB	Detector	Comment
1	*	0.1539	47.52	9.73	57.25	65.79	-8.54	QP	
2		0.1539	22.83	9.73	32.56	55.79	-23.23	AVG	
3		0.2100	38.86	9.73	48.59	63.21	-14.62	QP	
4		0.2100	21.95	9.73	31.68	53.21	-21.53	AVG	
5		0.5980	34.45	9.89	44.34	56.00	-11.66	QP	
6		0.5980	22.87	9.89	32.76	46.00	-13.24	AVG	
7		1.5060	33.11	9.96	43.07	56.00	-12.93	QP	
8		1.5060	23.57	9.96	33.53	46.00	-12.47	AVG	
9		3.6860	33.00	10.02	43.02	56.00	-12.98	QP	
10		3.6860	22.23	10.02	32.25	46.00	-13.75	AVG	
11		11.2020	38.27	10.26	48.53	60.00	-11.47	QP	
12		11.2020	28.97	10.26	39.23	50.00	-10.77	AVG	

## 5.5 Radiated spurious

### 5.5.1 Limits

20dBc in any 100 kHz bandwidth outside the operating frequency band. In case the emission fall within the restricted band specified on 15.205(a), then the 15.209(a) limit in the table below has to be followed.

Frequency (MHz)	Field Strength (micovolts/meter)	Measurement Distance (meters)
0.009~0.490	2400/F(KHz)	300
0.490~1.705	24000/F(KHz)	30
1.705~30.0	30	30
30~88	100	3
88~216	150	3
216~960	200	3
Above 960	500	3

Spectrum Parameter	Setting
Attenuation	Auto
Start Frequency	1000 MHz
Stop Frequency	10th carrier harmonic
RB / VB (emission in restricted band)	1 MHz / 1 MHz for Peak, 1 MHz / 10Hz for Average

Receiver Parameter	Setting
Attenuation	Auto
Start ~ Stop Frequency	9kHz~150kHz / RB 200Hz for QP
Start ~ Stop Frequency	150kHz~30MHz / RB 9kHz for QP
Start ~ Stop Frequency	30MHz~1000MHz / RB 120kHz for QP

5.5.2 Test setup

Radiated emission test-up frequency below 30MHz

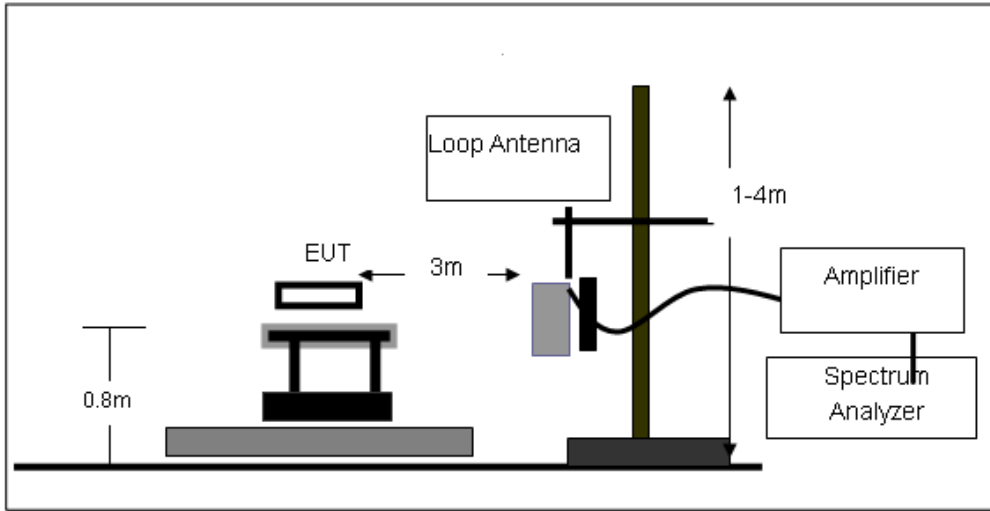

Radiated emission test-up frequency 30MHz~1GHz

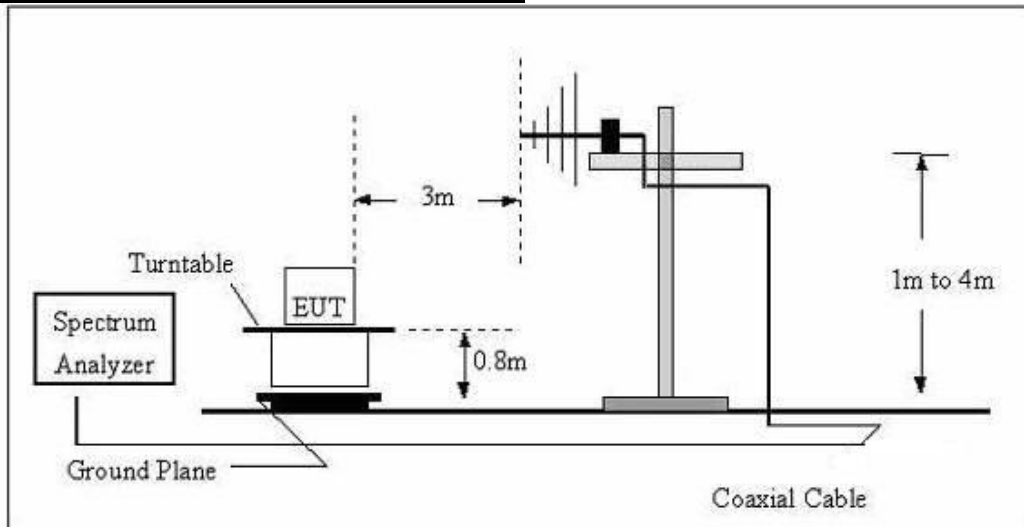

Radiated emission test-up frequency above 1GHz

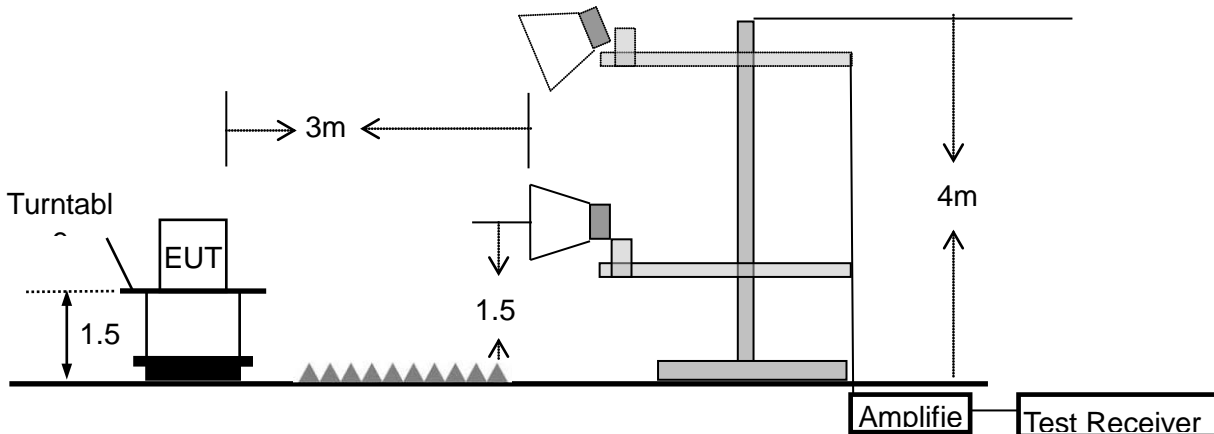



### 5.5.3 Test procedure

- a. EUT operating conditions. The EUT tested system was configured as the statements of 2.4 unless otherwise a special operating condition is specified in the follows during the testing.
- b. The measuring distance of at 3 m shall be used for measurements at frequency up to 1GHz. For frequencies above 1GHz, any suitable measuring distance may be used.
- c. The EUT was placed on the top of a rotating table 0.8 meters above the ground at a 3 meter open area test site. The table was rotated 360 degrees to determine the position of the highest radiation.
- d. The height of the equipment or of the substitution antenna shall be 0.8 m; the height of the test antenna shall vary between 1 m to 4 m. Both horizontal and vertical polarizations of the antenna are set to make the measurement.
- e. For emission measurements above 1 GHz, the EUT shall be placed at a height of 1.5 m above the floor on a support that is RF transparent for the frequencies of interest. Final measurements for the EUT require a measurement antenna height scan of 1 m to 4 m.
- f. The initial step in collecting conducted emission data is a spectrum analyzer peak detector mode pre-scanning the measurement frequency range. Significant peaks are then marked and then Quasi Peak detector mode re-measured.
- g. If the Peak Mode measured value compliance with and lower than Quasi Peak Mode Limit, the EUT shall be deemed to meet QP Limits and then no additional QP Mode measurement performed.
- h. For the actual test configuration, please refer to the related Item –EUT Test photos.

Note: Both horizontal and vertical antenna polarities were tested and performed pretest to three orthogonal axis. The worst case emissions were reported

5.5.4 Test results

5.5.4.1 Radiation emission

Below 30MHz

EUT :	Smart WiFi Dimmer Switch	Model Name :	ESWD16
Relative Humidity:	52%	Phase:	H
Pressure:	1010 hPa	Test Voltage :	AC 120V/60Hz
Test Mode :	TX		

Freq.	Reading	Limit	Margin	State
(MHz)	(dBuV/m)	(dBuV/m)	(dB)	P/F
--	--	--	--	Pass
--	--	--	--	Pass

Note:

The amplitude of spurious emissions which are attenuated by more than 20dB below the permissible value has no need to be reported.

Distance extrapolation factor =  $40 \log(\text{specific distance/test distance})$ (dB);

Limit line = specific limits(dBuV) + distance extrapolation factor.

Between 30MHz – 1GHz

All the modulation modes have been tested, the report only shows the worst mode.

The worst mode is 802.11b CH11, the worst result was report as below:

EUT :	Smart WiFi Dimmer Switch	Model Name :	ESWD16
Relative Humidity:	72%	Phase:	H
Pressure:	1010 hPa	Test Voltage :	AC 120V/60Hz
Test Mode :	Charging+TX		

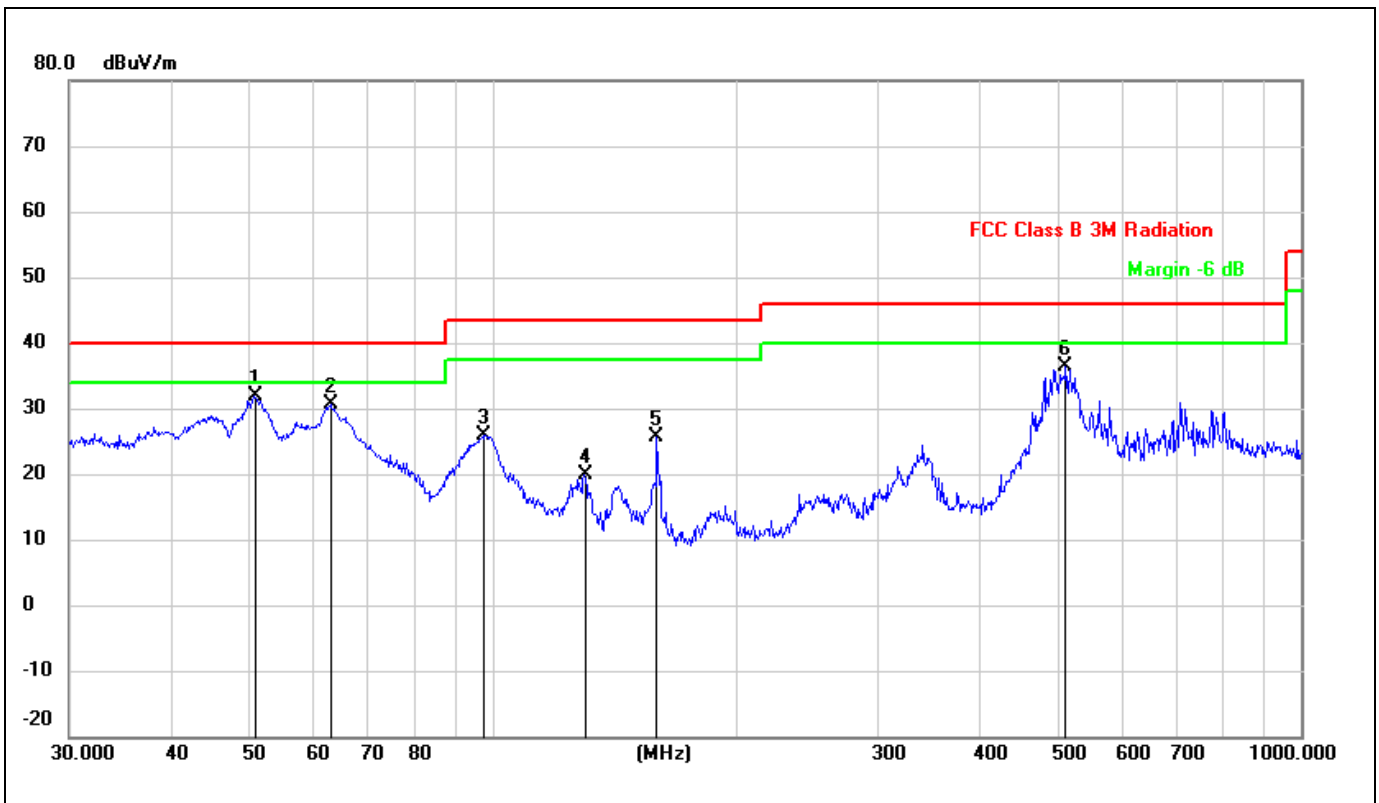

No.	Mk.	Freq. MHz	Reading Level dBuV	Correct Factor dBuV/m	Measure- ment dBuV/m	Limit dBuV/m	Over dB	Detector
1	*	50.7637	44.48	-12.64	31.84	40.00	-8.16	QP
2		63.0916	45.35	-14.68	30.67	40.00	-9.33	QP
3		97.7983	40.19	-14.23	25.96	43.50	-17.54	QP
4		129.9226	37.15	-17.19	19.96	43.50	-23.54	QP
5		159.7844	41.81	-16.29	25.52	43.50	-17.98	QP
6		511.8352	44.57	-8.28	36.29	46.00	-9.71	QP

EUT :	Smart WiFi Dimmer Switch	Model Name :	ESWD16
Relative Humidity:	72%	Phase:	V
Pressure:	1010 hPa	Test Voltage :	AC 120V/60Hz
Test Mode :	Charging+TX		

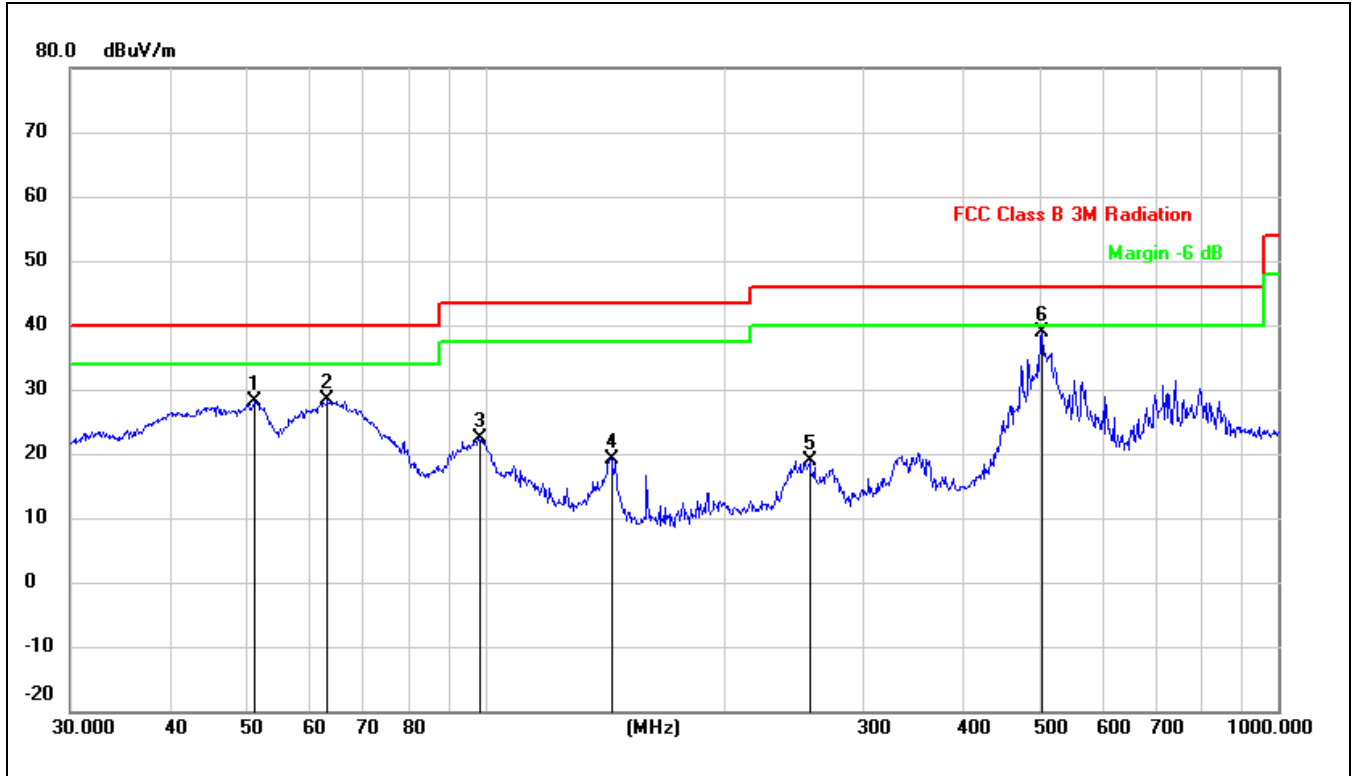

No. Mk.	Freq. MHz	Reading Level dBuV	Correct Factor dBuV/m	Measure- ment dBuV/m	Limit dBuV/m	Over dB	Detector
1	51.1209	40.71	-12.70	28.01	40.00	-11.99	QP
2	63.3132	43.01	-14.70	28.31	40.00	-11.69	QP
3	98.1419	36.61	-14.16	22.45	43.50	-21.05	QP
4	144.3348	35.89	-16.64	19.25	43.50	-24.25	QP
5	256.5211	30.70	-11.75	18.95	46.00	-27.05	QP
6 *	502.9395	47.14	-8.29	38.85	46.00	-7.15	QP

**1G-25GHz**

- Note: (1) All Readings are Peak Value (VBW=3MHz) and AV Value (VBW=10Hz).  
 (2) Emission Level= Antenna Factor + Cable Loss + Read Level - Preamp Factor  
 (3) All other emissions more than 20dB below the limit.

All the modulation modes have been tested, and the worst result was report as below:

**For 802.11b**

Frequency	Read Level	Cable loss	Antenna Factor	Preamp Factor	Emission Level	Limits	Margin	Remark	Comment
(MHz)	(dBμV)	(dB)	dB/m	(dB)	(dBμV/m)	(dBμV/m)	(dB)		
<b>Low Channel (2412 MHz)(802.11b)--Above 1G</b>									
4824.161	63.10	4.36	32.92	45.53	54.85	74.00	-19.15	Pk	Vertical
4824.161	40.51	4.36	32.92	45.53	32.26	54.00	-21.74	AV	Vertical
7236.396	60.58	5.02	37.63	45.56	57.67	74.00	-16.33	Pk	Vertical
7236.396	44.31	5.02	37.63	45.56	41.40	54.00	-12.60	AV	Vertical
4824.154	60.89	4.36	32.92	45.53	52.64	74.00	-21.36	Pk	Horizontal
4824.154	42.42	4.36	32.92	45.53	34.17	54.00	-19.83	AV	Horizontal
7236.168	63.22	5.02	37.63	45.56	60.31	74.00	-13.69	Pk	Horizontal
7236.168	46.66	5.02	37.63	45.56	43.75	54.00	-10.25	AV	Horizontal
<b>Middle Channel (2437 MHz)(802.11b)--Above 1G</b>									
4874.112	62.39	4.41	33.01	45.76	54.05	74.00	-19.95	Pk	Vertical
4874.112	42.57	4.41	33.01	45.76	34.23	54.00	-19.77	AV	Vertical
7311.247	60.03	5.02	37.68	45.59	57.14	74.00	-16.86	Pk	Vertical
7311.247	46.72	5.02	37.68	45.59	43.83	54.00	-10.17	AV	Vertical
4874.132	61.15	4.41	33.01	45.76	52.81	74.00	-21.19	Pk	Horizontal
4874.132	48.68	4.41	33.01	45.76	40.34	54.00	-13.66	AV	Horizontal
7311.085	59.55	5.02	37.68	45.59	56.66	74.00	-17.34	Pk	Horizontal
7311.085	41.42	5.02	37.68	45.59	38.53	54.00	-15.47	AV	Horizontal
<b>High Channel (2462 MHz)(802.11b)--Above 1G</b>									
4924.169	66.09	4.50	33.26	46.07	57.78	74.00	-16.22	Pk	Vertical
4924.169	42.43	4.50	33.26	46.07	34.12	54.00	-19.88	AV	Vertical
7386.215	60.74	5.02	37.78	45.77	57.77	74.00	-16.23	Pk	Vertical
7386.215	44.85	5.02	37.78	45.77	41.88	54.00	-12.12	AV	Vertical
4924.045	66.76	4.50	33.26	46.07	58.45	74.00	-15.55	Pk	Horizontal
4924.045	47.15	4.50	33.26	46.07	38.84	54.00	-15.16	AV	Horizontal
7386.132	60.62	5.02	37.78	45.77	57.65	74.00	-16.35	Pk	Horizontal
7386.132	45.02	5.02	37.78	45.77	42.05	54.00	-11.95	AV	Horizontal

5.5.4.2 Band edge - radiated

Note: (1) All Readings are Peak Value (VBW=3MHz) and AV Value (VBW=10Hz).  
 (2) Emission Level= Antenna Factor + Cable Loss + Read Level - Preamp Factor  
 (3) All other emissions more than 20dB below the limit.

Frequency	Meter Reading	Cable Loss	Antenna Factor	Preamp Factor	Emission Level	Limits	Margin	Detector	Comment
(MHz)	(dBμV)	(dB)	dB/m	(dB)	(dBμV/m)	(dBμV/m)	(dB)	Type	
802.11b									
2310.00	55.96	2.40	27.70	40.40	45.66	74	-28.34	Pk	Horizontal
2310.00	43.02	2.40	27.70	40.40	32.72	54	-21.28	AV	Horizontal
2310.00	59.03	2.40	27.70	40.40	48.73	74	-25.27	Pk	Vertical
2310.00	41.53	2.40	27.70	40.40	31.23	54	-22.77	AV	Vertical
2390.00	57.36	2.44	28.30	40.10	48.00	74	-26.00	Pk	Vertical
2390.00	41.89	2.44	28.30	40.10	32.53	54	-21.47	AV	Vertical
2390.00	56.90	2.44	28.30	40.10	47.54	74	-26.46	Pk	Horizontal
2390.00	41.45	2.44	28.30	40.10	32.09	54	-21.91	AV	Horizontal
2483.50	57.48	2.48	28.70	39.80	48.86	74	-25.14	Pk	Vertical
2483.50	43.12	2.48	28.70	39.80	34.50	54	-19.50	AV	Vertical
2483.50	58.65	2.48	28.70	39.80	50.03	74	-23.97	Pk	Horizontal
2483.50	41.72	2.48	28.70	39.80	33.10	54	-20.90	AV	Horizontal
802.11g									
2310.00	59.10	2.40	27.70	40.40	48.80	74	-25.20	Pk	Horizontal
2310.00	43.77	2.40	27.70	40.40	33.47	54	-20.53	AV	Horizontal
2310.00	56.37	2.40	27.70	40.40	46.07	74	-27.93	Pk	Vertical
2310.00	43.09	2.40	27.70	40.40	32.79	54	-21.21	AV	Vertical
2390.00	57.37	2.44	28.30	40.10	48.01	74	-25.99	Pk	Vertical
2390.00	42.27	2.44	28.30	40.10	32.91	54	-21.09	AV	Vertical
2390.00	58.03	2.44	28.30	40.10	48.67	74	-25.33	Pk	Horizontal
2390.00	43.76	2.44	28.30	40.10	34.40	54	-19.60	AV	Horizontal
2483.50	58.88	2.48	28.70	39.80	50.26	74	-23.74	Pk	Vertical
2483.50	44.40	2.48	28.70	39.80	35.78	54	-18.22	AV	Vertical
2483.50	58.81	2.48	28.70	39.80	50.19	74	-23.81	Pk	Horizontal
2483.50	42.42	2.48	28.70	39.80	33.80	54	-20.20	AV	Horizontal

802.11n20									
2310.00	57.62	2.40	27.70	40.40	47.32	74	-26.68	Pk	Horizontal
2310.00	43.92	2.40	27.70	40.40	33.62	54	-20.38	AV	Horizontal
2310.00	58.29	2.40	27.70	40.40	47.99	74	-26.01	Pk	Vertical
2310.00	41.93	2.40	27.70	40.40	31.63	54	-22.37	AV	Vertical
2390.00	58.13	2.44	28.30	40.10	48.77	74	-25.23	Pk	Vertical
2390.00	42.07	2.44	28.30	40.10	32.71	54	-21.29	AV	Vertical
2390.00	57.10	2.44	28.30	40.10	47.74	74	-26.26	Pk	Horizontal
2390.00	42.07	2.44	28.30	40.10	32.71	54	-21.29	AV	Horizontal
2483.50	57.95	2.48	28.70	39.80	49.33	74	-24.67	Pk	Vertical
2483.50	42.78	2.48	28.70	39.80	34.16	54	-19.84	AV	Vertical
2483.50	58.71	2.48	28.70	39.80	50.09	74	-23.91	Pk	Horizontal
2483.50	42.55	2.48	28.70	39.80	33.93	54	-20.07	AV	Horizontal

5.5.4.3 Spurious Emission in Restricted Band 3260MHz-18000MHz

All the modulation modes have been tested, and the worst result was report as below:

Frequency	Reading	Cable	Antenna	Preamp	Emission	Limits	Margin	Detector	Comment
(MHz)	(dB $\mu$ V)	(dB)	dB/m	(dB)	(dB $\mu$ V/m)	(dB $\mu$ V/m)	(dB)	Type	
3260	60.18	4.04	29.57	44.70	49.09	74	-24.91	Pk	Vertical
3260	55.96	4.04	29.57	44.70	44.87	54	-9.13	AV	Vertical
3260	61.51	4.04	29.57	44.70	50.42	74	-23.58	Pk	Horizontal
3260	56.79	4.04	29.57	44.70	45.70	54	-8.30	AV	Horizontal
3332	64.45	4.26	29.87	44.40	54.18	74	-19.82	Pk	Vertical
3332	53.75	4.26	29.87	44.40	43.48	54	-10.52	AV	Vertical
3332	62.65	4.26	29.87	44.40	52.38	74	-21.62	Pk	Horizontal
3332	52.72	4.26	29.87	44.40	42.45	54	-11.55	AV	Horizontal
17797	42.87	10.99	43.95	43.50	54.31	74	-19.69	Pk	Vertical
17797	32.39	10.99	43.95	43.50	43.83	54	-10.17	AV	Vertical
17788	43.93	11.81	43.69	44.60	54.83	74	-19.17	Pk	Horizontal
17788	32.26	11.81	43.69	44.60	43.16	54	-10.84	AV	Horizontal



## 5.6 Band edge - Conducted

### 5.6.1 Limits

In any 100 kHz bandwidth outside the frequency band in which the spread spectrum or digitally modulated intentional radiator is operating, the radio frequency power that is produced by the intentional radiator shall be at least 20 dB below that in the 100 kHz bandwidth within the band that contains the highest level of the desired power, based on either an RF conducted or a radiated measurement, provided the transmitter demonstrates compliance with the peak conducted power limits. If the transmitter complies with the conducted power limits based on the use of RMS averaging over a time interval, as permitted under paragraph (b)(3) of this section, the attenuation required under this paragraph shall be 30 dB instead of 20 dB. Attenuation below the general limits specified in §15.209(a) is not required. In addition, radiated emissions which fall in the restricted bands, as defined in §15.205(a), must also comply with the radiated emission limits specified in §15.209(a) (see §15.205(c)).

### 5.6.2 Test setup



### 5.6.3 Test procedure

- a) Check the calibration of the measuring instrument using either an internal calibrator or a known signal from an external generator.
- b) Position the EUT without connection to measurement instrument. Turn on the EUT and connect its antenna terminal to measurement instrument via a low loss cable. Then set it to any one measured frequency within its operating range, and make sure the instrument is operated in its linear range.
- c) Set RBW to 100 kHz and VBW of spectrum analyzer to 300 kHz with a convenient frequency span including 100 kHz bandwidth from band edge.
- d) Measure the highest amplitude appearing on spectral display and set it as a reference level. Plot the graph with marking the highest point and edge frequency.
- e) Repeat above procedures until all measured frequencies were complete.

#### EUT OPERATION CONDITIONS

The EUT tested system was configured as the statements of 2.4 unless otherwise a special operating condition is specified in the follows during the testing.

5.6.4 Test results

Test plots:

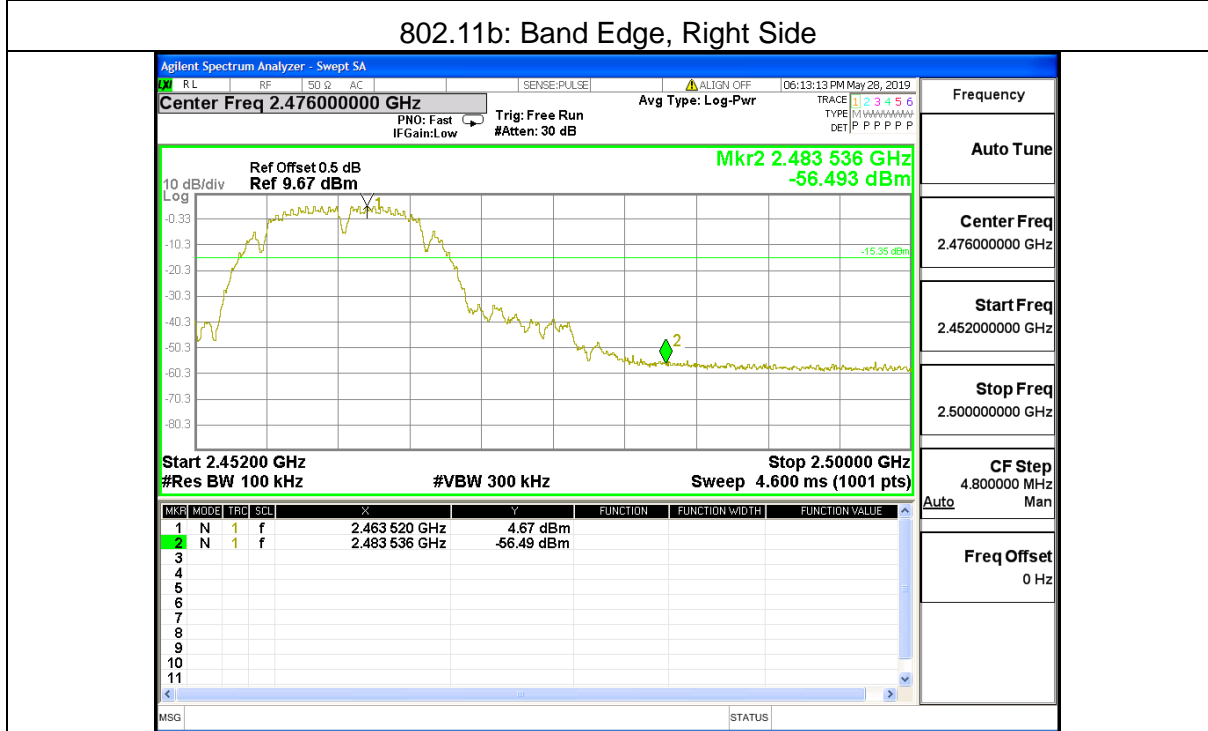
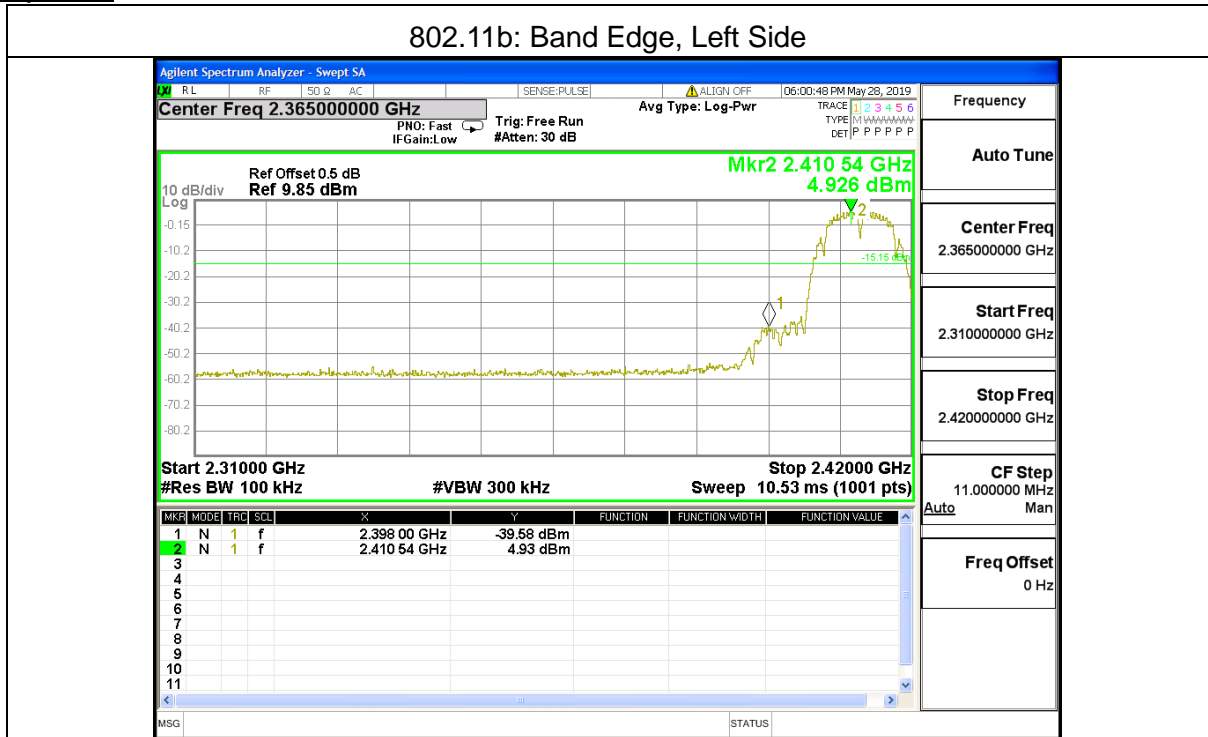

802.11g: Band Edge, Left Side

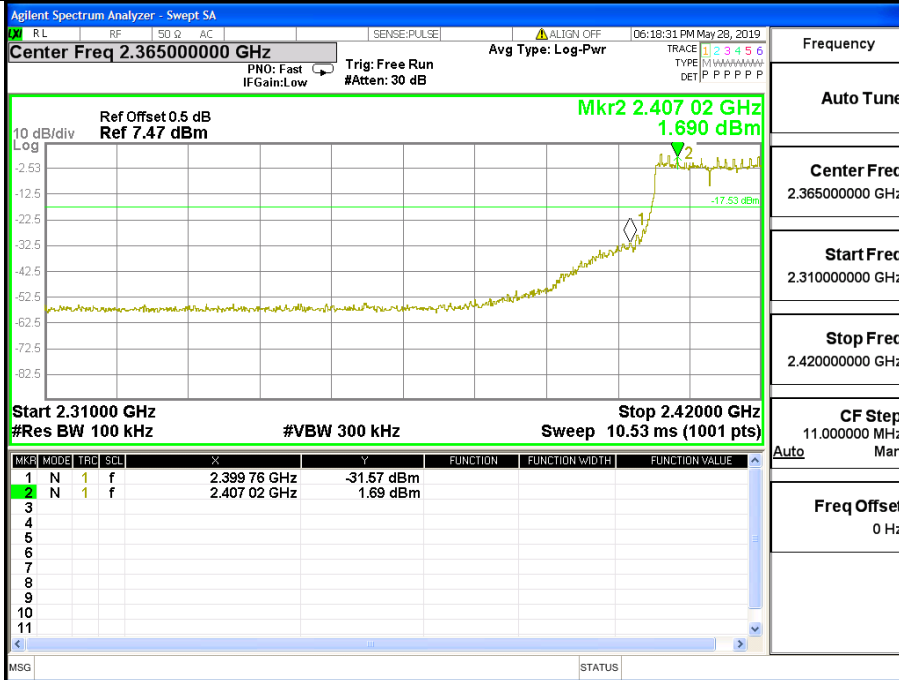

802.11g: Band Edge, Right Side

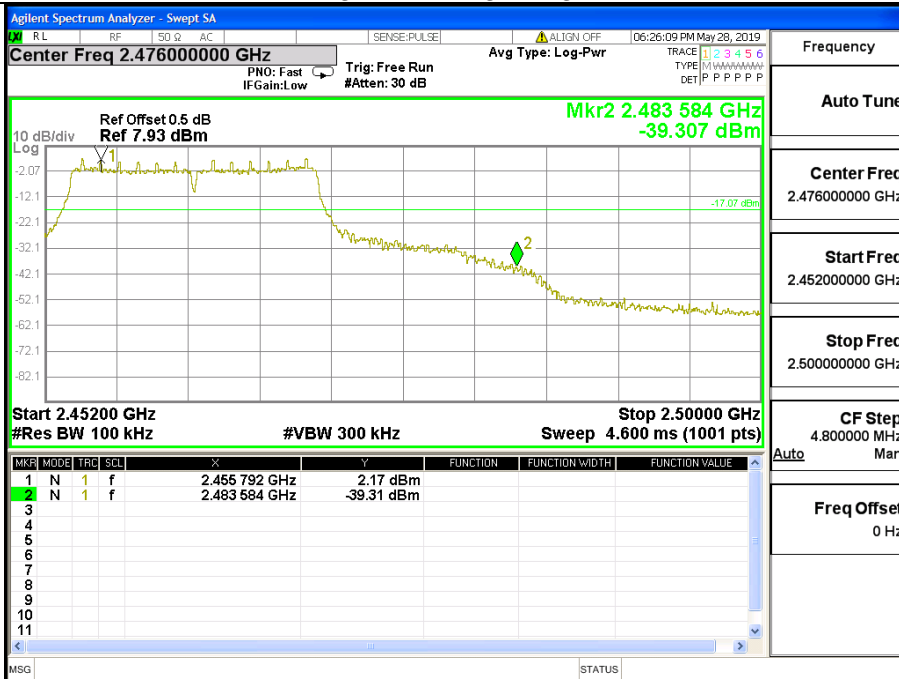

802.11n20: Band Edge, Left Side

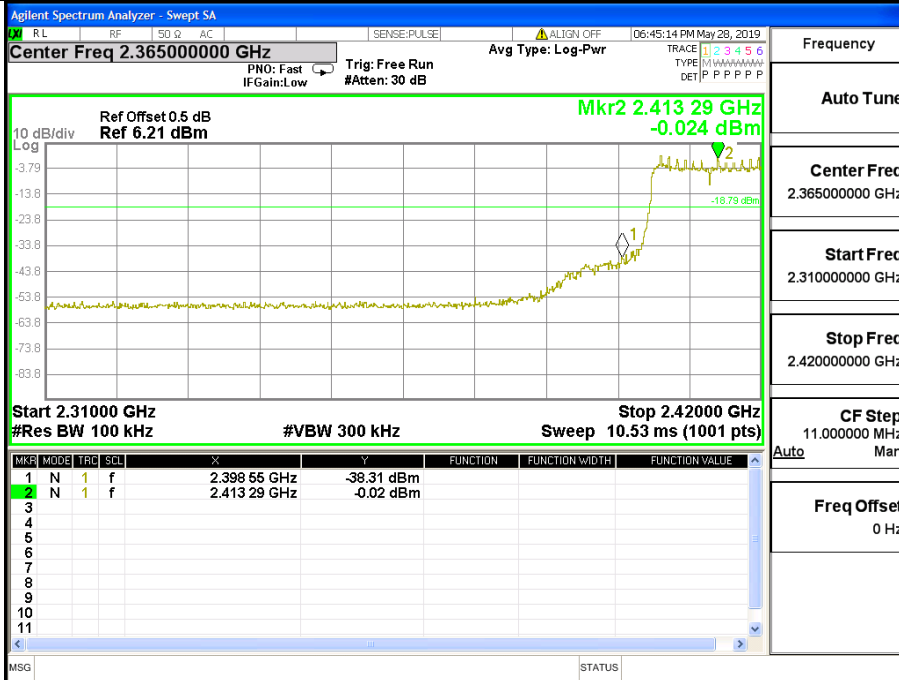

802.11n20: Band Edge, Right Side

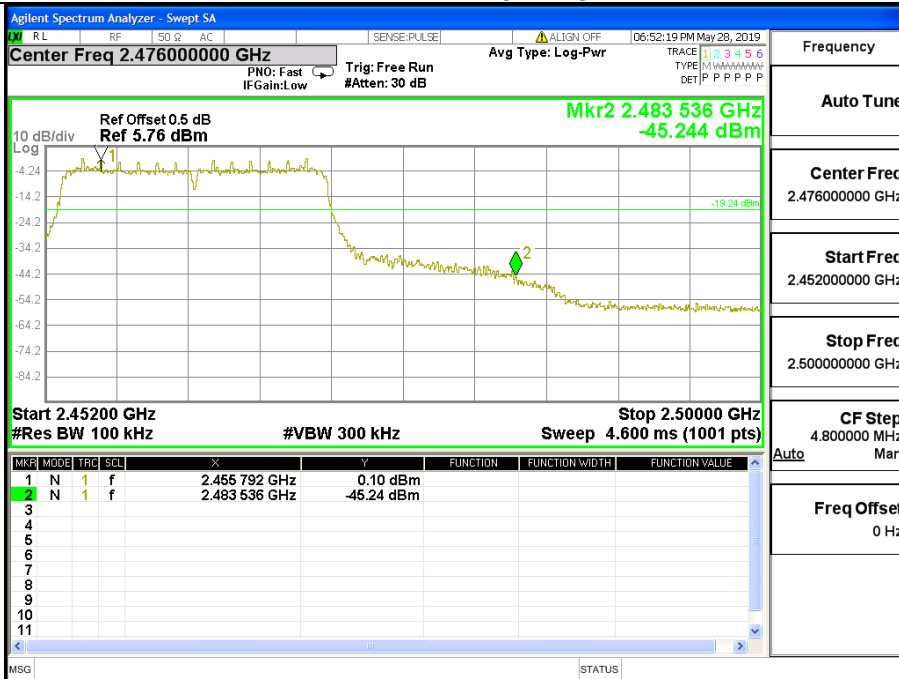

## 5.7 6dB bandwidth

### 5.7.1 Limit

FCC Part15 Subpart C				
Section	Test Item	Limit	Frequency Range (MHz)	Result
15.247(a)(2)	Bandwidth	$\geq 500\text{KHz}$ (6dB bandwidth)	2400-2483.5	Pass

### 5.7.2 Test setup



### 5.7.3 Test procedure

- a. Set RBW= 100 kHz.
- b. Set the video bandwidth (VBW)  $\geq 3 \times$  RBW.
- c. Detector = Peak.
- d. Trace mode = max hold.
- e. Sweep = auto couple.
- f. Allow the trace to stabilize.
- g. Measure the maximum width of the emission that is constrained by the frequencies associated with the two outermost amplitude points (upper and lower) that are attenuated by 6 dB relative to the maximum level measured in the fundamental emission.

#### EUT Operation Conditions

The EUT tested system was configured as the statements of 2.4 unless otherwise a special operating condition is specified in the follows during the testing.

5.7.4 Test results

EUT :	Smart WiFi Dimmer Switch	Model Name :	ESWD16
Temperature :	25 °C	Relative Humidity :	60%
Pressure :	1012 hPa	Test Voltage :	AC 120V/60Hz
Test Mode :	TX b Mode /CH01, CH06, CH11		

Channel	Frequency (MHz)	6dB bandwidth (MHz)	Limit (kHz)	Result
Low	2412	10.07	500	Pass
Middle	2437	10.08	500	Pass
High	2462	10.10	500	Pass

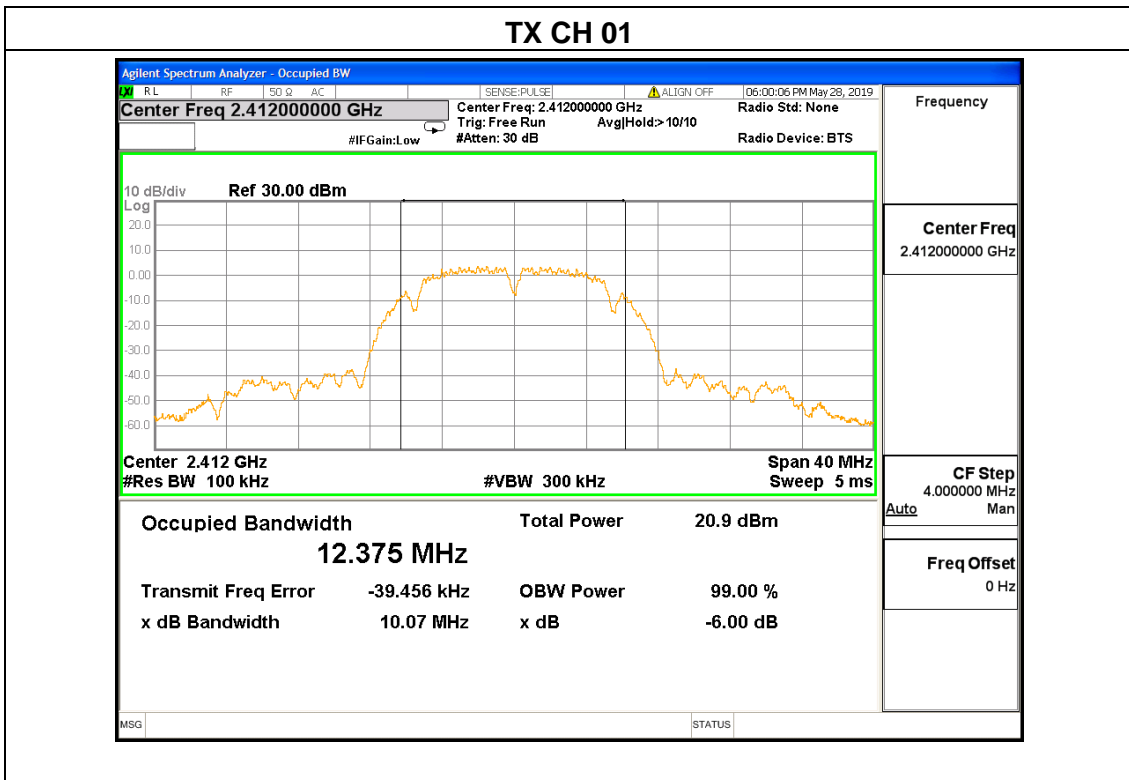

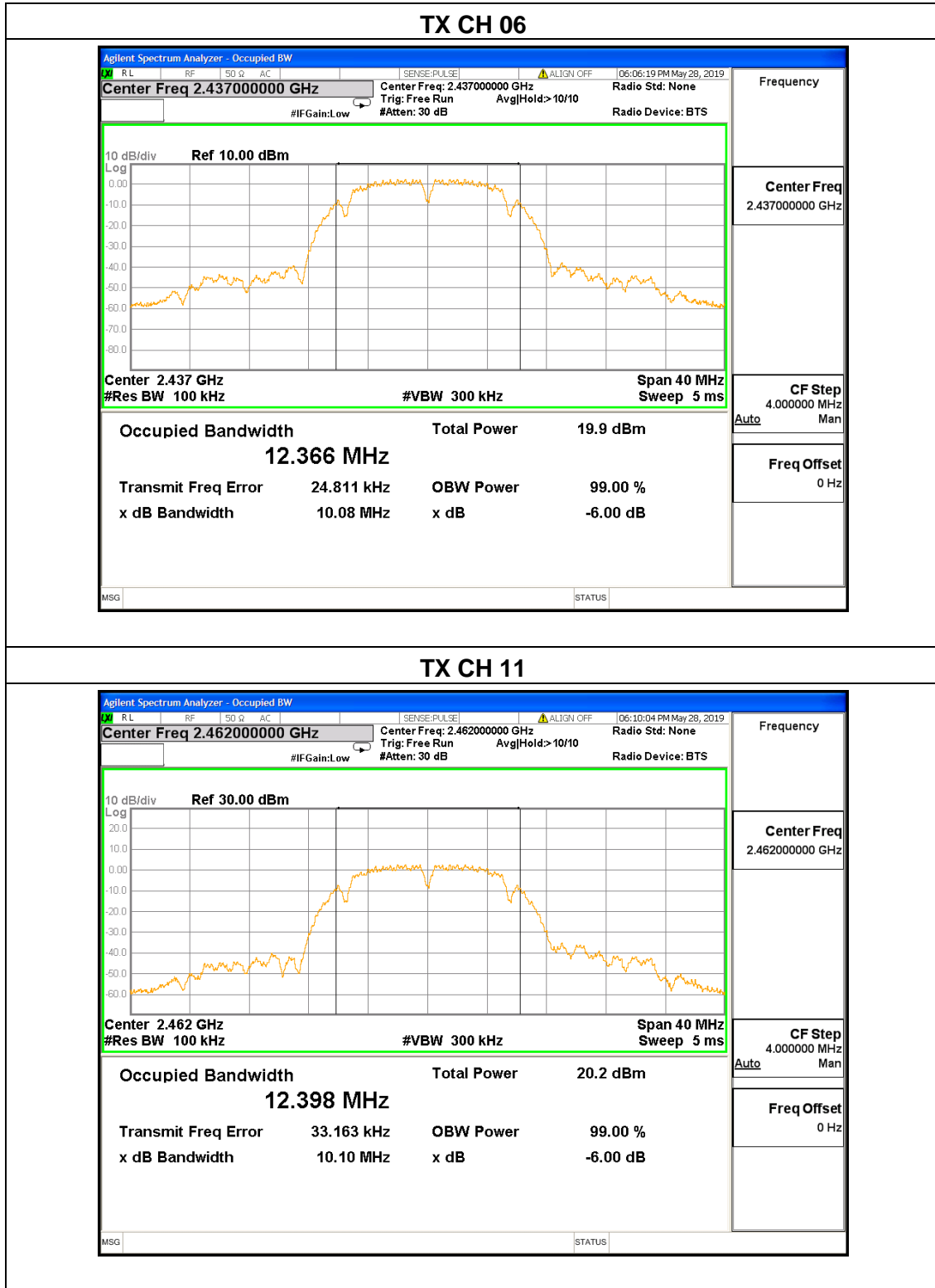

EUT :	Smart WiFi Dimmer Switch	Model Name :	ESWD16
Temperature :	25 °C	Relative Humidity :	60%
Pressure :	1012 hPa	Test Voltage :	AC 120V/60Hz
Test Mode :	TX g Mode /CH01, CH06, CH11		

Channel	Frequency (MHz)	6dB bandwidth (MHz)	Limit (kHz)	Result
Low	2412	16.38	500	Pass
Middle	2437	16.37	500	Pass
High	2462	16.36	500	Pass

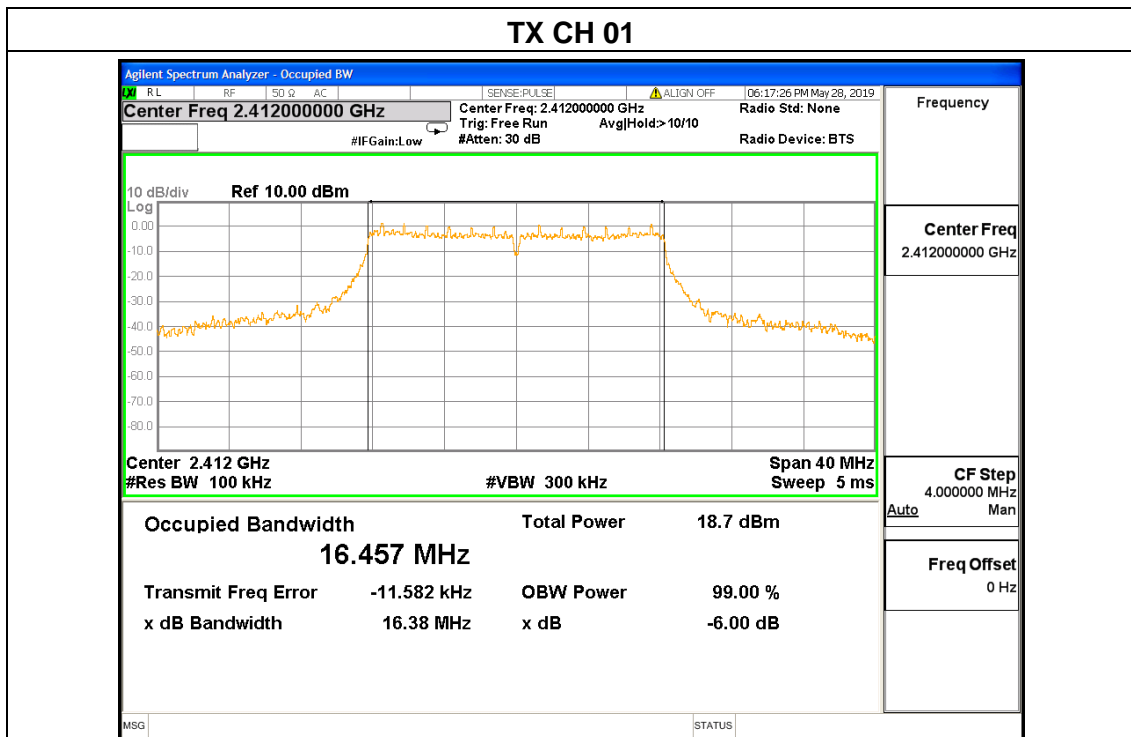



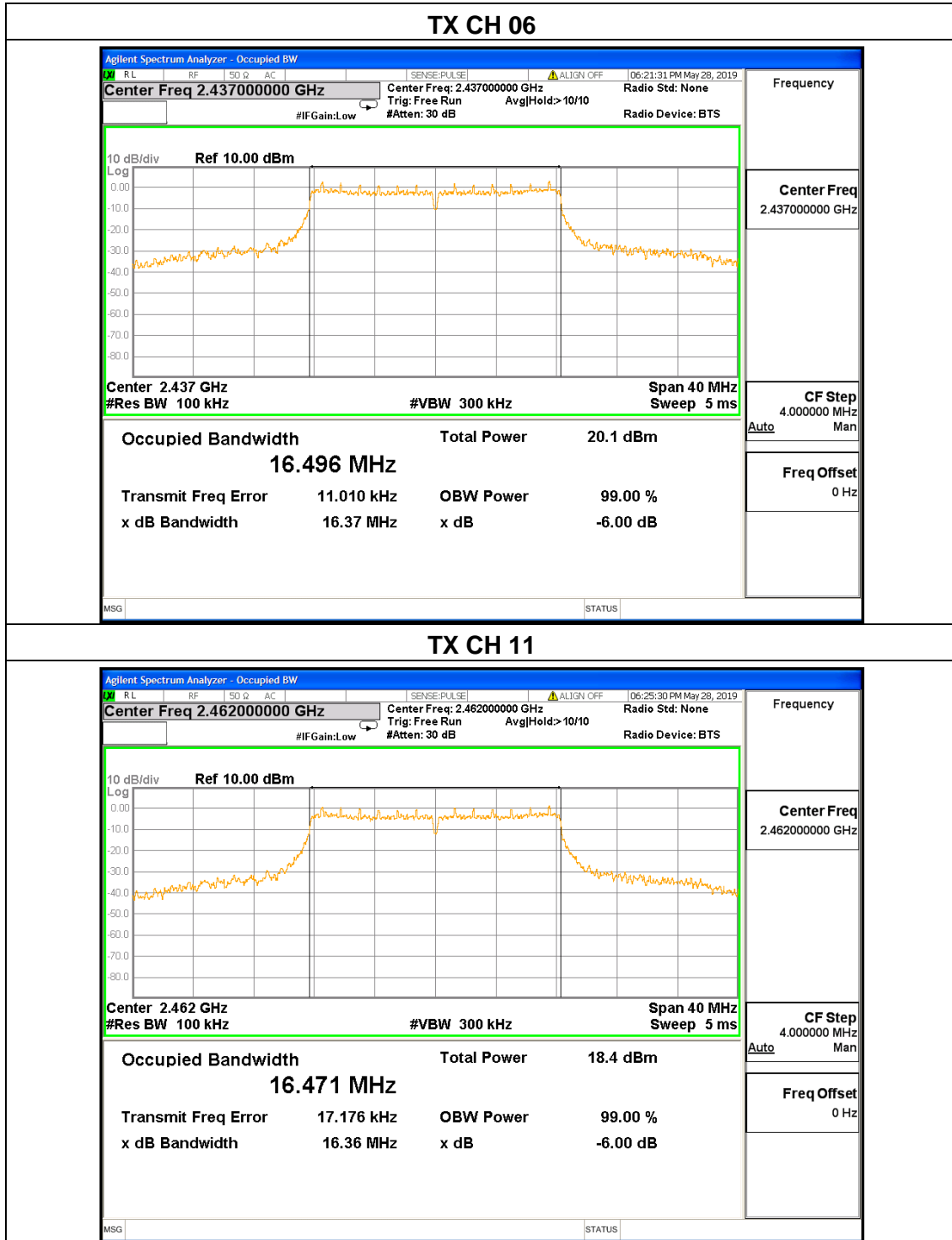

EUT :	Smart WiFi Dimmer Switch	Model Name :	ESWD16
Temperature :	25 °C	Relative Humidity :	60%
Pressure :	1012 hPa	Test Voltage :	AC 120V/60Hz
Test Mode :	TX n20 Mode /CH01, CH06, CH11		

Channel	Frequency (MHz)	6dB bandwidth (MHz)	Limit (kHz)	Result
Low	2412	16.98	500	Pass
Middle	2437	17.07	500	Pass
High	2462	17.06	500	Pass

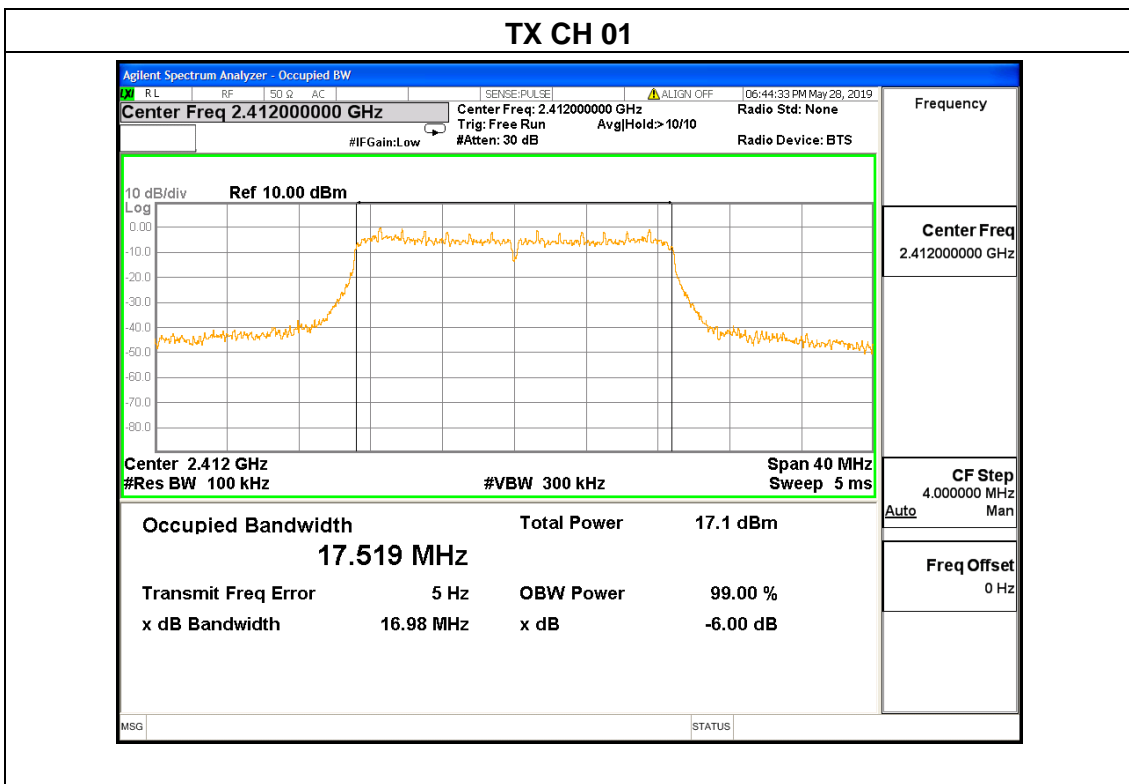

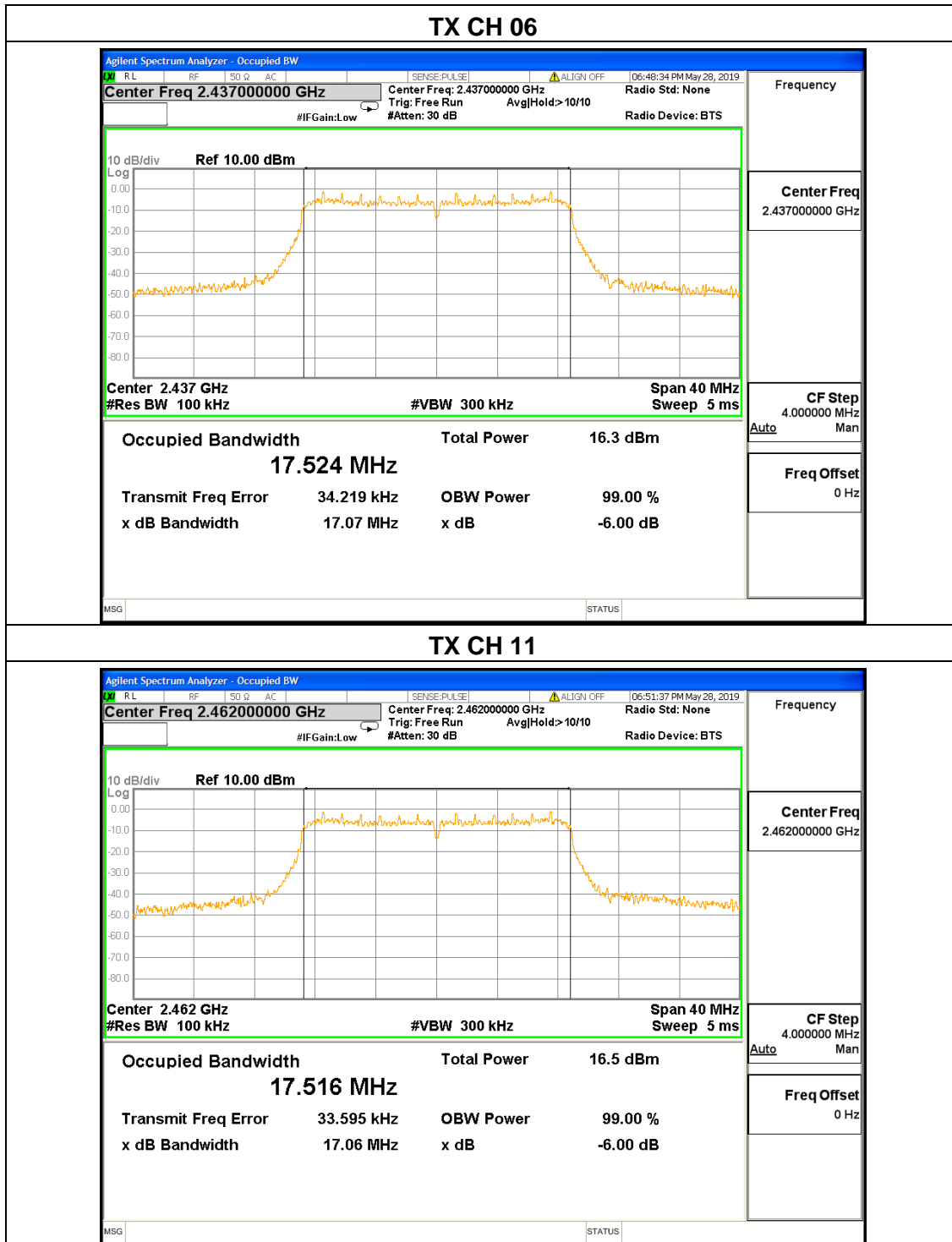

## 5.8 Spurious RF Conducted Emissions

### 5.8.1 Conformance Limit

Below -20dB of the highest emission level in operating band.

### 5.8.2 Measuring Instruments

The Measuring equipment is listed in the section 6.3 of this test report.

### 5.8.3 Test Setup

Please refer to Section 6.1 of this test report.

### 5.8.4 Test Procedure

The Spurious RF conducted emissions compliance of RF radiated emission should be measured by following the guidance in ANSI C63.10-2013 with respect to maximizing the emission by rotating the EUT, measuring the emission while the EUT is situated in three orthogonal planes (if appropriate), adjusting the measurement antenna height and polarization etc. Set RBW=100kHz and VBW=300kHz to measure the peak field strength, and measure frequency range from 9kHz to 26.5GHz.

### 5.8.5 Test Results

Remark: The measurement frequency range is from 9kHz to the 10th harmonic of the fundamental frequency. The lowest, middle and highest channels are tested to verify the spurious emissions and band edge measurement data.

Note1: The three modulated high, medium and low channels have been tested. The report only shows the worst mode. The worst mode is 802.11b.

802.11b on Channel 01

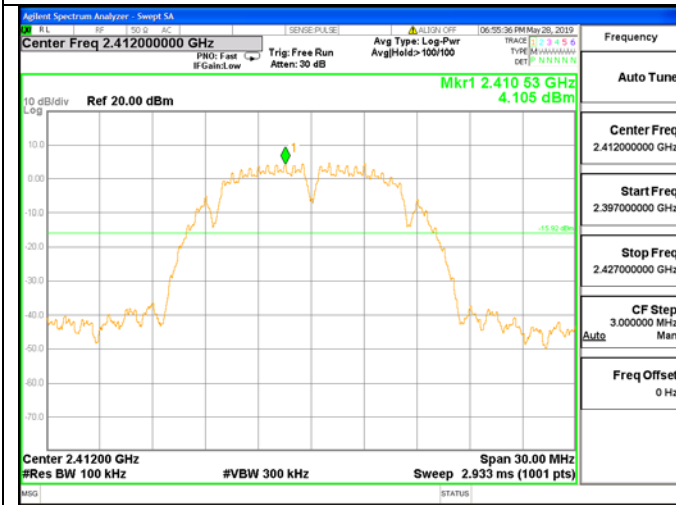

802.11b on Channel 01

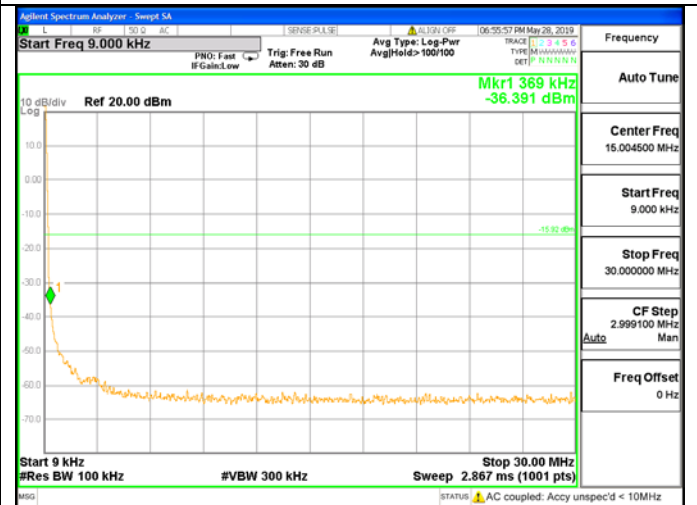

802.11b on Channel 01

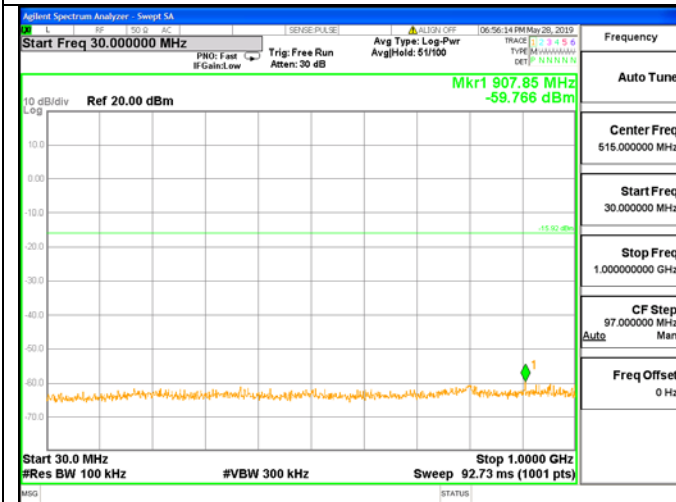

802.11b on Channel 01

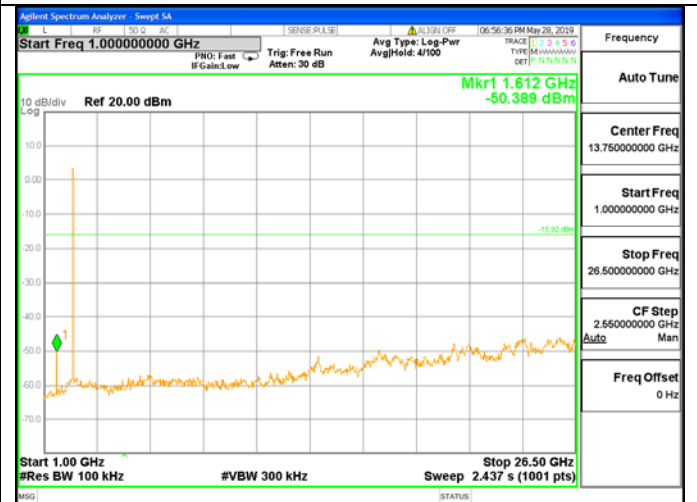

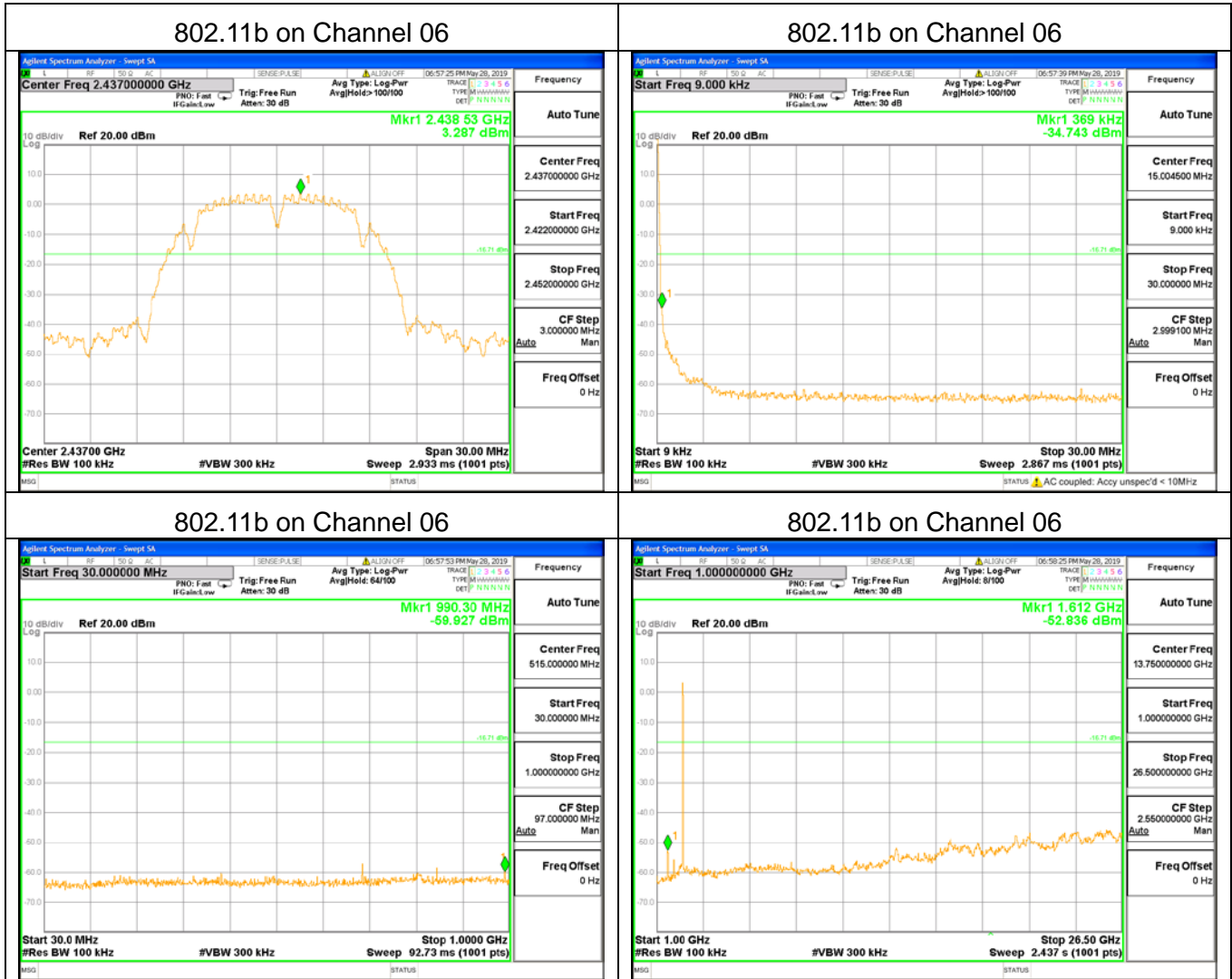

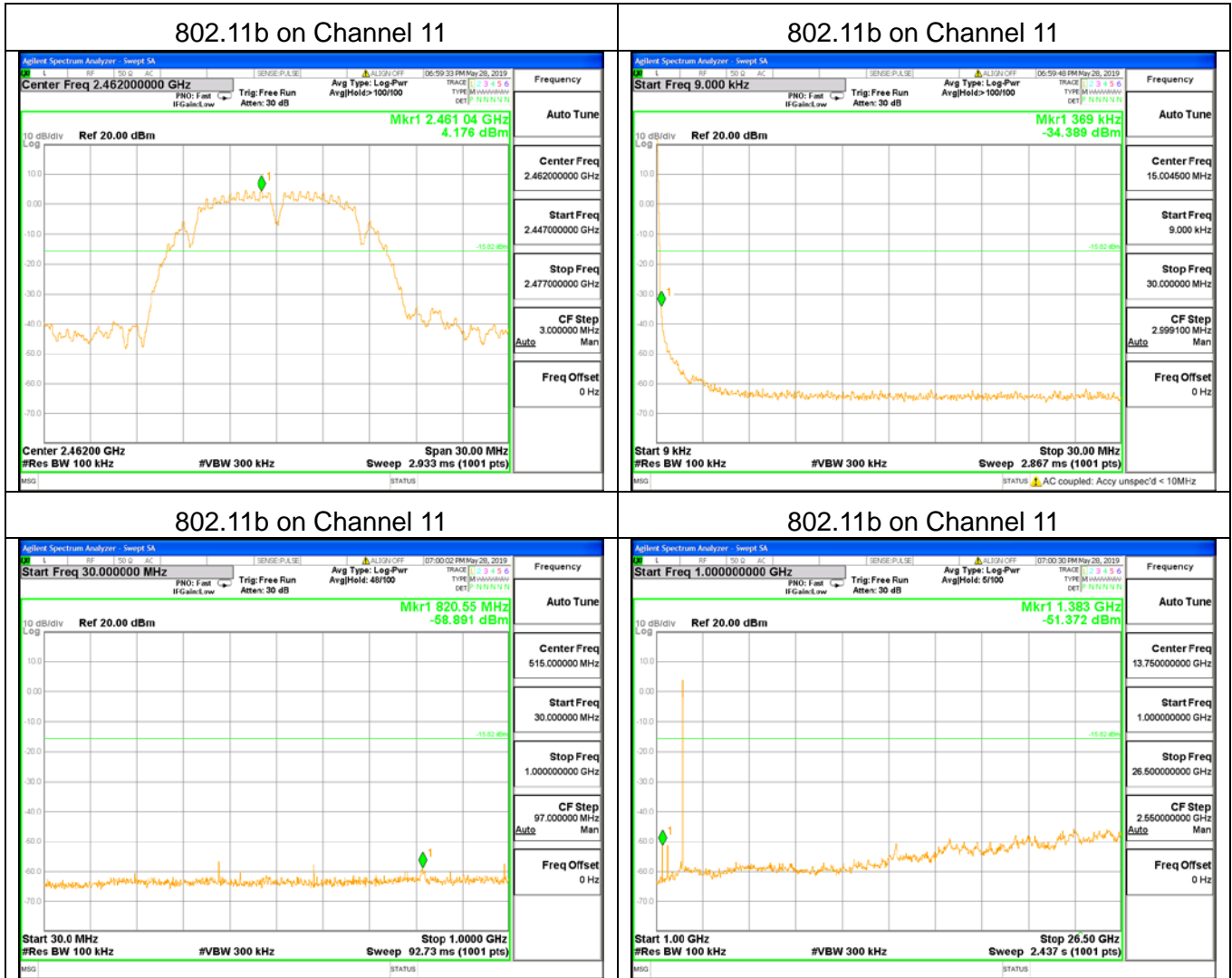

Photographs of the Test Setup

Radiated emission

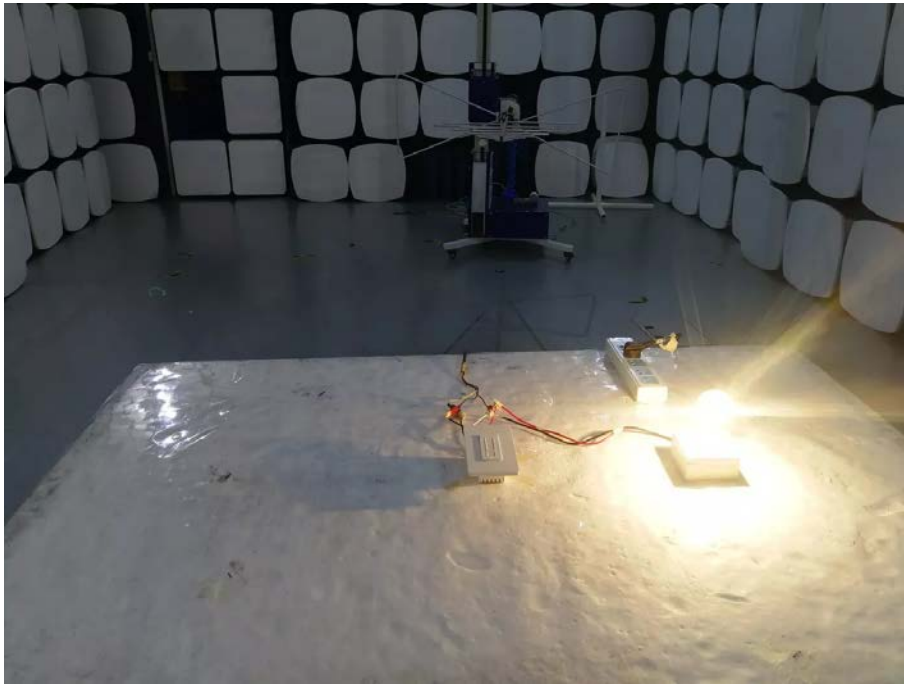



Conducted emission



**Photographs of the EUT**

See the APPENDIX 1: EUT PHOTO in the report No.: MTi190531E194-1.

**----END OF REPORT----**