



## FCC - TEST REPORT

Report Number : **68.910.24.0004.01** Date of Issue: **2024-03-19**

Model/HVIN : **ESF93**

Product Type : Etekcite Smart Fitness Scale

Applicant : Etekcite Corporation

Address : 1202 N. Miller St. Suite A, Anaheim, CA 92806, USA

Manufacturer : Etekcite Corporation

Address : 1202 N. Miller St. Suite A, Anaheim, CA 92806, USA

Factory : Shenzhen Unique Scales Co., Ltd

Address : 6th FL., Building A, Huafeng Green Energy Innovation Park,  
No.22 Longteng Road, Pingdi Street,  
Longgang District 518117, Shenzhen, China

Test Result :  **Positive**       **Negative**

Total pages including Appendices : **37**

*Any use for advertising purposes must be granted in writing. This technical report may only be quoted in full. This report is the result of a single examination of the object in question and is not generally applicable evaluation of the quality of other products in regular production. For further details, please see testing and certification regulation chapter A-3.4.*



# 1 Table of Contents

1	Table of Contents.....	2
2	Details about the Test Laboratory.....	3
3	Description of the Equipment Under Test.....	4
4	Summary of Test Standards.....	5
5	Summary of Test Results.....	6
6	General Remarks.....	7
7	Test Setups.....	8
7.1	Radiated test setups.....	8
7.2	Conducted RF test setups.....	9
7.3	AC Power Line Conducted Emission test setups.....	9
8	Systems test configuration.....	10
9	Technical Requirement.....	11
9.1	Conducted Emission.....	11
9.2	Conducted Output Power.....	14
9.3	6 dB Bandwidth.....	17
9.4	Power spectral density.....	20
9.5	Spurious RF conducted emissions.....	23
9.6	Band edge testing.....	28
9.7	Spurious radiated emissions for transmitter.....	30
10	Test Equipment List.....	36
11	System Measurement Uncertainty.....	37

## 2 Details about the Test Laboratory

### Details about the Test Laboratory

#### Test Site 1

Company name: TÜV SÜD Certification and Testing (China) Co., Ltd. Shenzhen Branch  
Building 12 & 13, Zhiheng Wisdomland Business Park,  
Guankou Erlu, Nantou, Nanshan District,  
Shenzhen, Guangdong, China

Telephone: 86 755 8828 6998

Fax: 86 755 8828 5299

FCC Registration No.: 514049

FCC Designation Number: CN5009

### 3 Description of the Equipment Under Test

Product:	Etekcitcity Smart Fitness Scale
Model no.:	ESF93
FCC ID:	2AB22-ESF932
Options and accessories:	NIL
Ratings:	DC 5V, 500mA Battery type: DC 3.7V, 300mAh Li-ion battery
RF Transmission Frequency:	2402MHz-2480MHz (for BLE-1Mbps)
No. of Operated Channel:	40
Modulation:	GFSK
Antenna Type:	PCB antenna
Antenna Gain:	-0.29dBi
Description of the EUT:	The EUT is an Etekcitcity Smart Fitness Scale, supports BLE-1Mbps function, operates at 2402 – 2480MHz.

NOTE 1: The above EUT's information is declared by manufacturer. Please refer to the specifications or user's manual for more detailed description.

## 4 Summary of Test Standards

Test Standards	
FCC Part 15 Subpart C 10-1-2023 Edition	PART 15 - RADIO FREQUENCY DEVICES Subpart C - Intentional Radiators

All the test methods were according to KDB 558074 D01 15.247 Meas Guidance v05r02 Measurement Guidance and ANSI C63.10-2020.

## 5 Summary of Test Results

Technical Requirements						
FCC Part 15 Subpart C						
Test Condition		Test Site	Test Result			Test Environment
			Pass	Fail	N/A	
§15.207	Conducted emission AC power port	Site 1	<input checked="" type="checkbox"/>	<input type="checkbox"/>	<input type="checkbox"/>	T: 23.1°C H: 51.2%
§15.247 (b) (3)	Conducted peak output power	Site 1	<input checked="" type="checkbox"/>	<input type="checkbox"/>	<input type="checkbox"/>	T: 23.4°C H: 52.7%
§15.247(a)(2)	6dB bandwidth and 99% Occupied Bandwidth	Site 1	<input checked="" type="checkbox"/>	<input type="checkbox"/>	<input type="checkbox"/>	T: 23.4°C H: 52.7%
§15.247(e)	Power spectral density	Site 1	<input checked="" type="checkbox"/>	<input type="checkbox"/>	<input type="checkbox"/>	T: 23.7°C H: 52.7%
§15.247(d)	Spurious RF conducted emissions	Site 1	<input checked="" type="checkbox"/>	<input type="checkbox"/>	<input type="checkbox"/>	T: 23.8°C H: 52.7%
§15.247(d)	Band edge	Site 1	<input checked="" type="checkbox"/>	<input type="checkbox"/>	<input type="checkbox"/>	T: 23.1°C H: 58.0%
§15.247(d) & §15.209 & §15.205	Spurious radiated emissions for transmitter	Site 1	<input checked="" type="checkbox"/>	<input type="checkbox"/>	<input type="checkbox"/>	T: 23.2°C H: 58.1%
§15.203	Antenna requirement	See note 2	<input checked="" type="checkbox"/>	<input type="checkbox"/>	<input type="checkbox"/>	--

Note 1: N/A=Not Applicable.

Note 2: The EUT use a PCB antenna, which gain of antenna is -0.29dBi. In accordance to §15.203, it is considered sufficiently to comply with the provisions of this section.

Note 3: T=Temperature, H=Humidity

## 6 General Remarks

This submittal(s) (test report) is intended for FCC ID: 2AB22-ESF932 complies with Section 15.207, 15.205, 15.209, 15.247 of the FCC Part 15, Subpart C rules.

### SUMMARY:

All tests according to the regulations cited on page 5 were:

■ - Performed

□ - **Not** Performed

The Equipment under Test

■ - **Fulfills** the general approval requirements.

□ - **Does not** fulfill the general approval requirements.

Sample Received Date: 2023-06-05

Testing Start Date: 2023-06-12

Testing End Date: 2023-06-25

- TÜV SÜD Certification and Testing (China) Co., Ltd. Shenzhen Branch –

Reviewed by:

Prepared by:

Tested by:

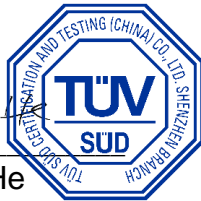

Jessie He  
Project Manager



Myron Yu  
Project Engineer



Carry Cai  
Test Engineer

## 7 Test Setups

### 7.1 Radiated test setups

9kHz - 30MHz

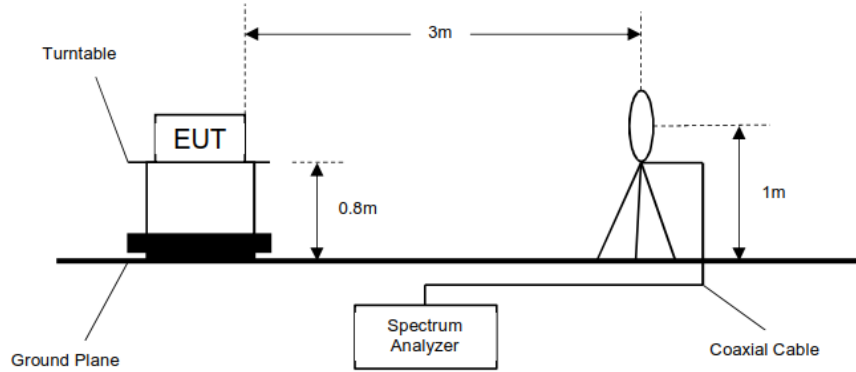

Below 1GHz

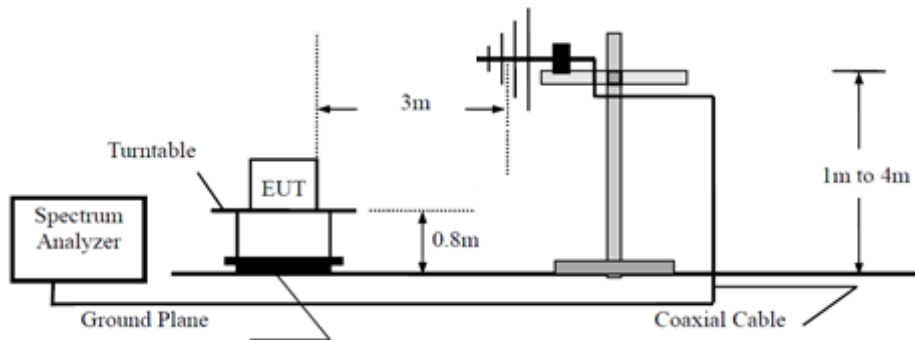

Above 1GHz

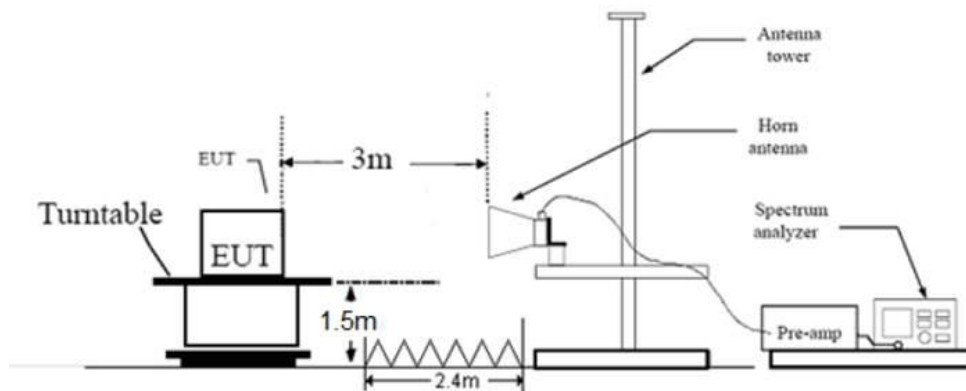



## 7.2 Conducted RF test setups

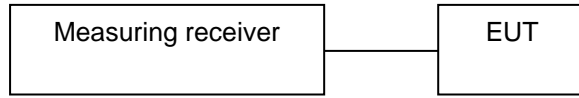

## 7.3 AC Power Line Conducted Emission test setups

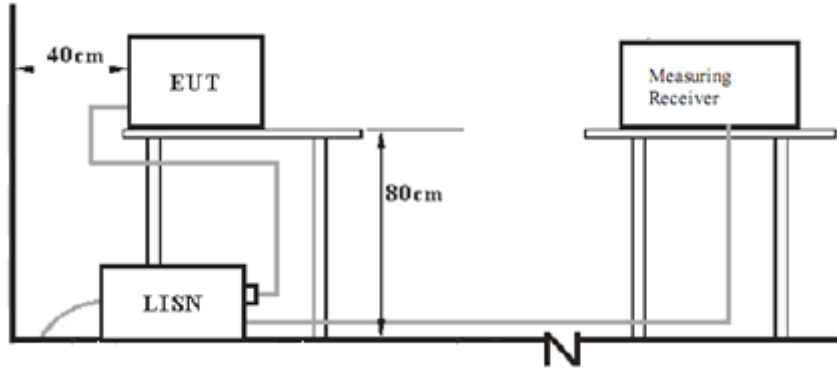

## 8 Systems test configuration

Auxiliary Equipment Used during Test:

DESCRIPTION	MANUFACTURER	MODEL NO.	REMARK
Notebook	LENOVO	X220	---

Test software information:

Test Software Version	BK32xx RF Test_V1.8.2		
Modulation	Setting TX Power	Packet Type	
GFSK	3	Pn9	

The system was configured to non-hopping mode, testing channel 0, 19, 39.

## 9 Technical Requirement

### 9.1 Conducted Emission

#### Test Method

1. The EUT was placed 0.4 meter from the conducting wall of the shielding room was kept at least 80 centimeters from any other grounded conducting surface.
2. Connect EUT to the power mains through a line impedance stabilization network (LISN).
3. All the support units are connecting to the other LISN.
4. The LISN provides 50 ohm coupling impedance for the measuring instrument.
5. Both sides of AC line were checked for maximum conducted interference.
6. The frequency range from 150 kHz to 30 MHz was searched.
7. Set the test-receiver system to Peak Detect Function and specified bandwidth (IF Bandwidth = 9kHz) with Maximum Hold Mode. Then measurement is also conducted by Average Detector and Quasi-Peak Detector Function respectively.

#### Limit

According to §15.207, conducted emissions limit as below:

Frequency MHz	QP Limit dB $\mu$ V	AV Limit dB $\mu$ V
0.150-0.500	66-56*	56-46*
0.500-5	56	46
5-30	60	50

Remark: “\*” Decreasing linearly with logarithm of the frequency

## Conducted Emission

Product Type : Etekcitty Smart Fitness Scale  
 M/N : ESF93  
 Operating Condition : BLE communication mode  
 Test Specification : L  
 Comment : AC 120V/60Hz

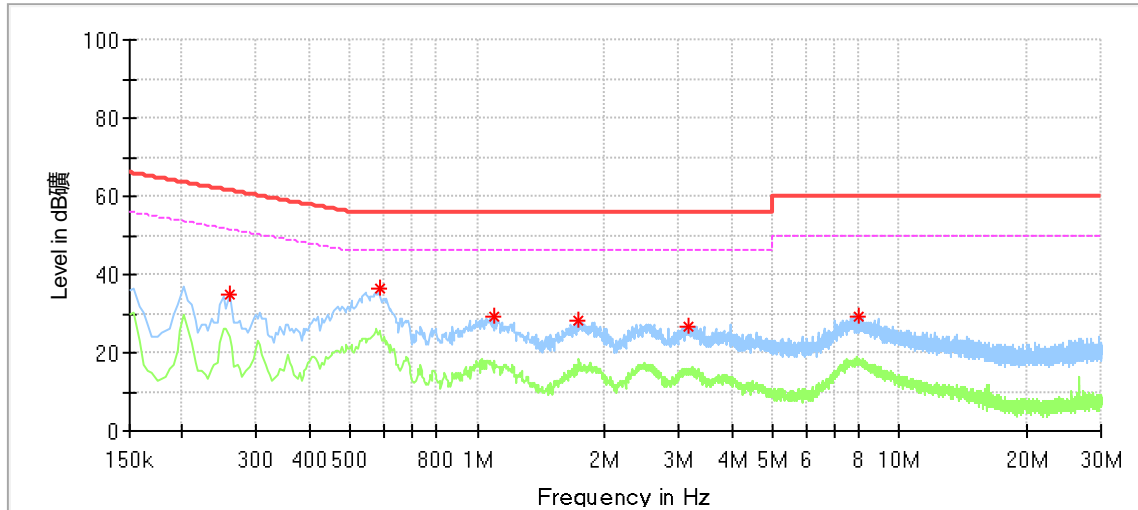

### Critical\_Freqs

Frequency (MHz)	MaxPeak (dBµV)	Average (dBµV)	Limit (dBµV)	Margin (dB)	Line	Corr. (dB)
0.258000	34.69	---	61.50	26.80	L1	9.56
0.586000	36.31	---	56.00	19.69	L1	9.60
1.094000	29.11	---	56.00	26.89	L1	9.60
1.742000	28.39	---	56.00	27.61	L1	9.61
3.154000	26.77	---	56.00	29.23	L1	9.66
7.966000	29.43	---	60.00	30.57	L1	9.88

## Conducted Emission

Product Type : Etekcitty Smart Fitness Scale  
 M/N : ESF93  
 Operating Condition : BLE communication mode  
 Test Specification : N  
 Comment : AC 120V/60Hz

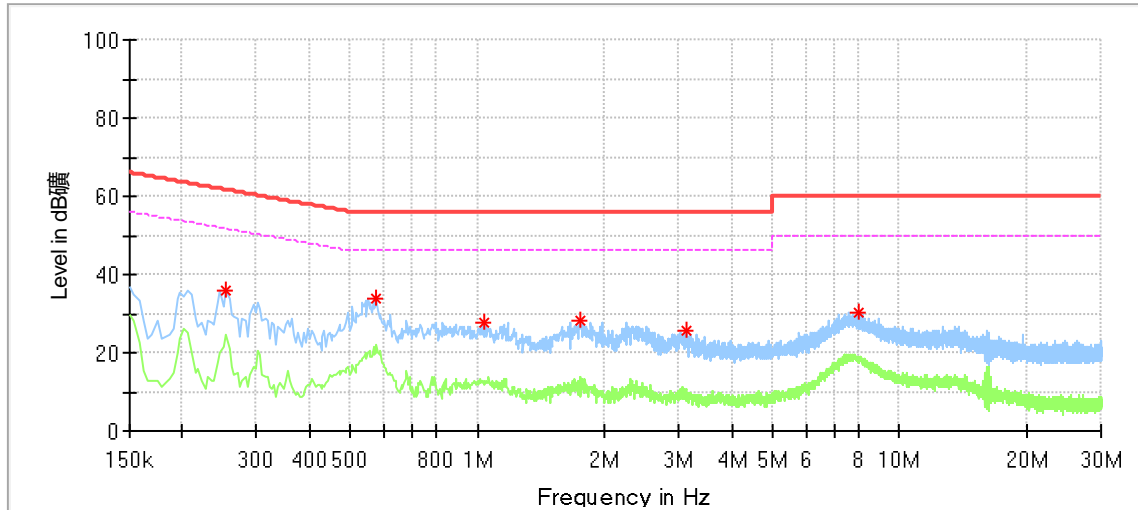

### Critical\_Freqs

Frequency (MHz)	MaxPeak (dBµV)	Average (dBµV)	Limit (dBµV)	Margin (dB)	Line	Corr. (dB)
0.254000	35.89	---	61.63	25.74	N	9.59
0.578000	34.00	---	56.00	22.00	N	9.63
1.034000	27.82	---	56.00	28.18	N	9.63
1.746000	27.96	---	56.00	28.04	N	9.65
3.122000	25.68	---	56.00	30.32	N	9.69
7.990000	30.12	---	60.00	29.88	N	9.90

## 9.2 Conducted Output Power

### Test Method

1. The RF output of EUT was connected to the spectrum analyzer by RF cable. The path loss was compensated to the results for each measurement.
2. Set to the maximum power setting and enable the EUT transmit continuously.
3. Use the following test receiver settings:  
 Span = approximately 5 times the 6dB bandwidth, centered on a channel need to test,  
 RBW > the 6dB bandwidth of the emission being measured, VBW≥3RBW,  
 Sweep = auto, Detector function = peak, Trace = max hold
4. Allow the trace to stabilize. Use the marker-to-peak function to set the marker to the peak of the emission. The indicated level is the peak output power and record the results in the test report.
5. Repeat above procedures until all frequencies measured were complete.

### Limit

According to §15.247 (b) (3), conducted output power limit as below:

Frequency Range MHz	Limit W	Limit dBm
2400-2483.5	≤1	≤30

### Test Results

Mode	TX Type	Frequency (MHz)	Maximum Peak Conducted Output Power (dBm)		Verdict
			ANT1	Limit	
1M	SISO	2402	3.22	≤30	Pass
		2440	3.30	≤30	Pass
		2480	3.06	≤30	Pass

### 1M\_LCH\_2402MHz\_Ant1\_NTNV

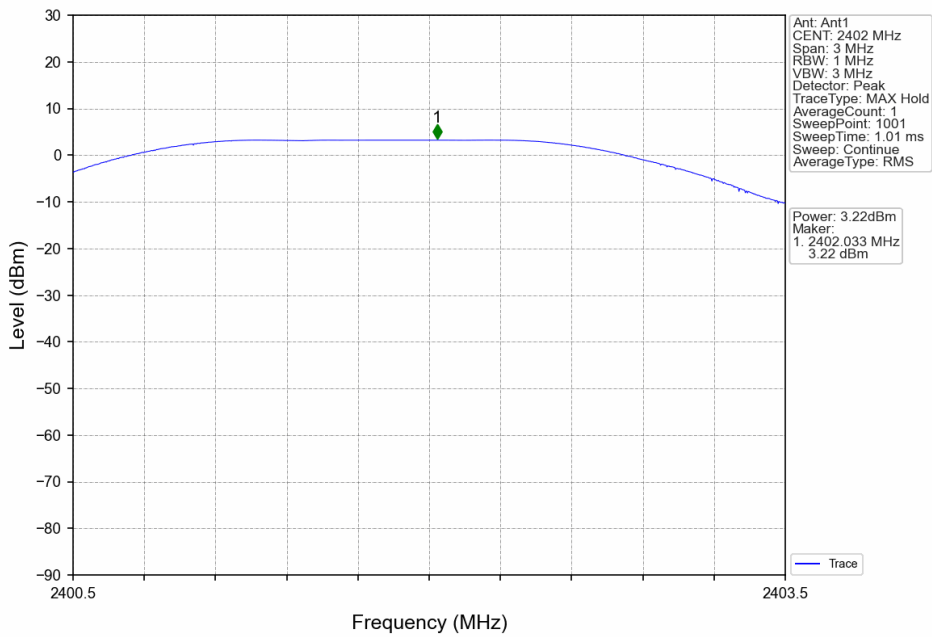

### 1M\_MCH\_2440MHz\_Ant1\_NTNV

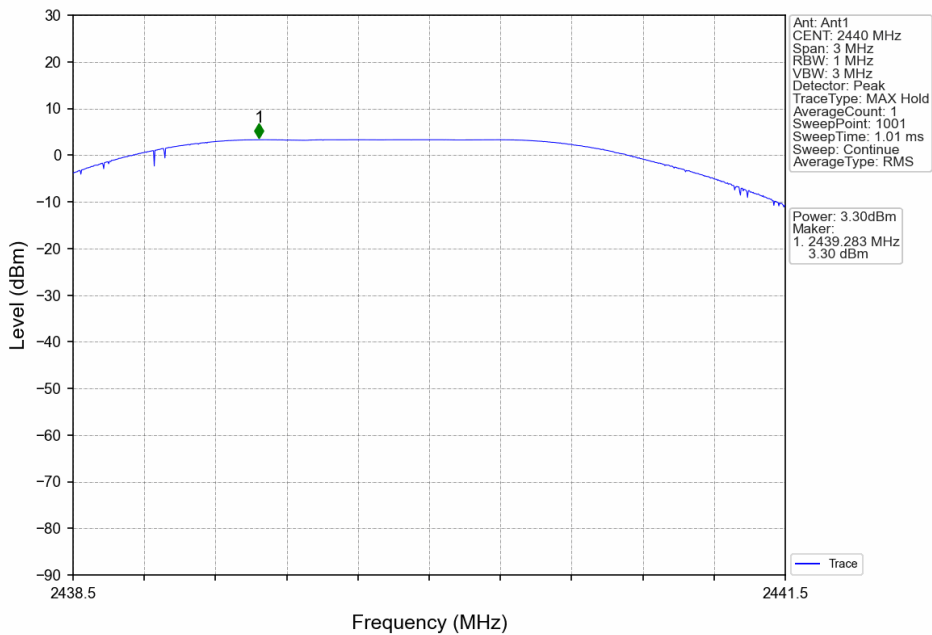

1M\_HCH\_2480MHz\_Ant1\_NTNV

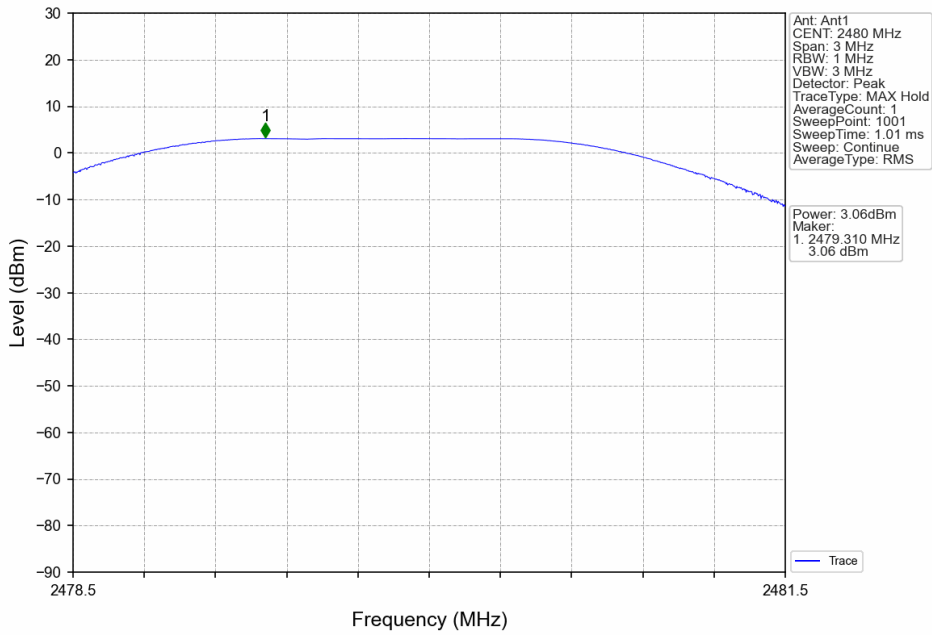



### 9.3 6 dB Bandwidth

#### Test Method for 6 dB Bandwidth

1. The RF output of EUT was connected to the spectrum analyzer. The path loss was compensated to the results for each measurement.
2. Set to the maximum power setting, the instrument center frequency is set to the nominal EUT channel center frequency enable the EUT transmit continuously.
3. Use the following spectrum analyzer settings:  
RBW=1% to 5% of the actual occupied, VBW $\geq$ 3RBW, Sweep = auto, Detector function = peak, Trace = max hold
4. Use the automatic bandwidth measurement capability of an instrument, use the X dB bandwidth mode with X set to 6 dB.
5. Allow the trace to stabilize, record the 6 dB Bandwidth value.

#### Limit

6dB bandwidth Limit [kHz]

$\geq 500$

#### Test result for 6 dB Bandwidth

Mode	TX Type	Frequency (MHz)	ANT	6dB Bandwidth (MHz)		Verdict
				Result	Limit	
1M	SISO	2402	1	0.790	$\geq 0.5$	Pass
		2440	1	0.796	$\geq 0.5$	Pass
		2480	1	0.812	$\geq 0.5$	Pass

1M\_LCH\_2402MHz\_Ant1\_NTNV

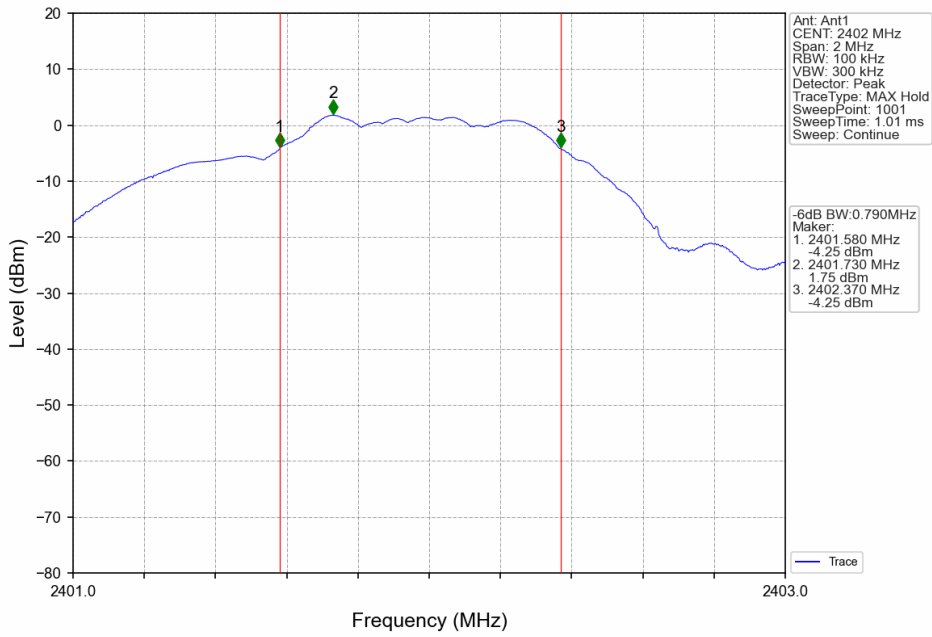

1M\_MCH\_2440MHz\_Ant1\_NTNV

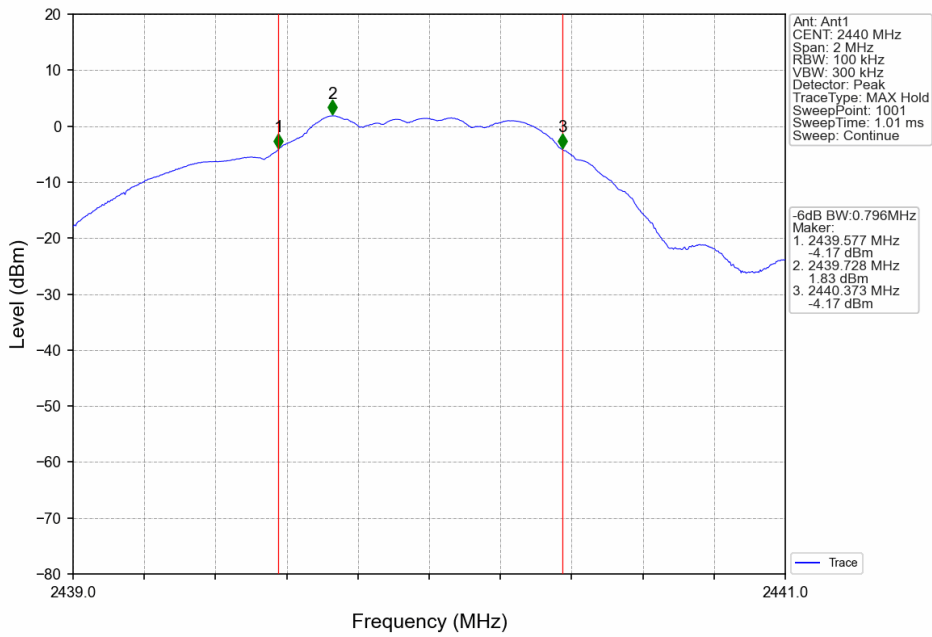

1M\_HCH\_2480MHz\_Ant1\_NTNV

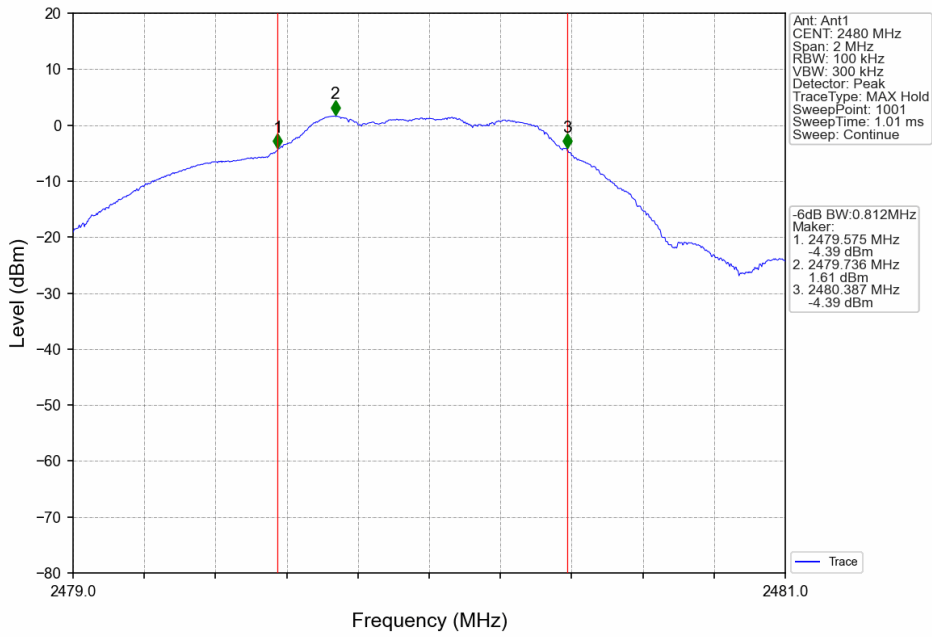

## 9.4 Power spectral density

### Test Method

This procedure shall be used if maximum peak conducted output power was used to demonstrate compliance:

1. The RF output of EUT was connected to the spectrum analyzer. The path loss was compensated to the results for each measurement.
2. Set to the maximum power setting, the instrument center frequency is set to the nominal EUT channel center frequency enable the EUT transmit continuously.
3. Use the following spectrum analyzer settings:
4. Set analyzer center frequency to DTS channel center frequency. RBW=3kHz, VBW≥3RBW, Span=1.5 times DTS bandwidth, Detector=Peak, Sweep=auto, Trace= max hold.
5. Allow trace to fully stabilize, use the peak marker function to determine the maximum amplitude level within the RBW.
6. Repeat above procedures until other frequencies measured were completed.

### Limit

**Limit [dBm/3kHz]**

\_\_\_\_\_

≤ 8

### Test Results

Mode	TX Type	Frequency (MHz)	Maximum PSD (dBm/3kHz)		Verdict
			ANT1	Limit	
1M	SISO	2402	-13.18	≤-8	Pass
		2440	-13.34	≤-8	Pass
		2480	-13.70	≤-8	Pass

1M\_LCH\_2402MHz\_Ant1\_NTNV

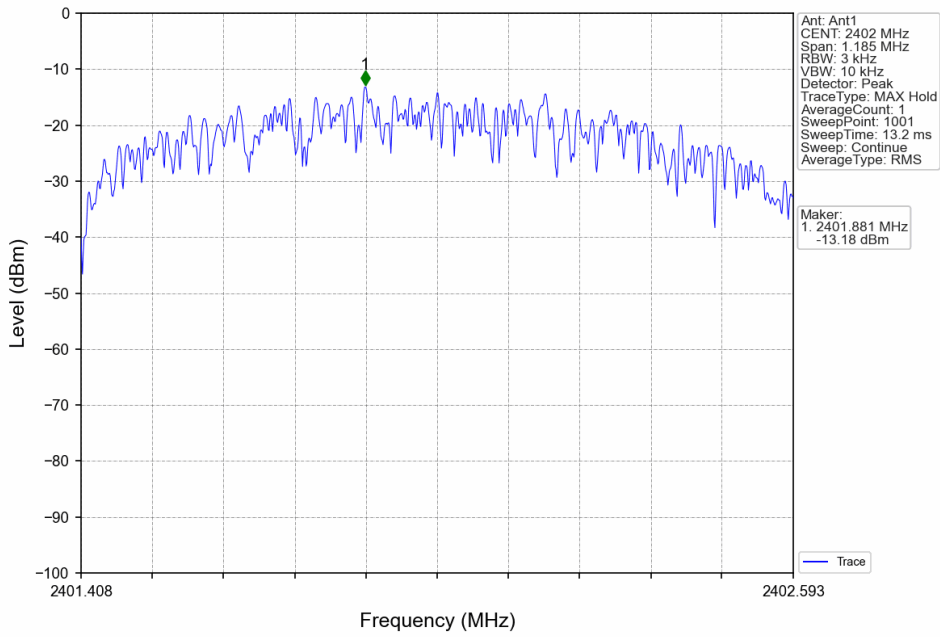

1M\_MCH\_2440MHz\_Ant1\_NTNV

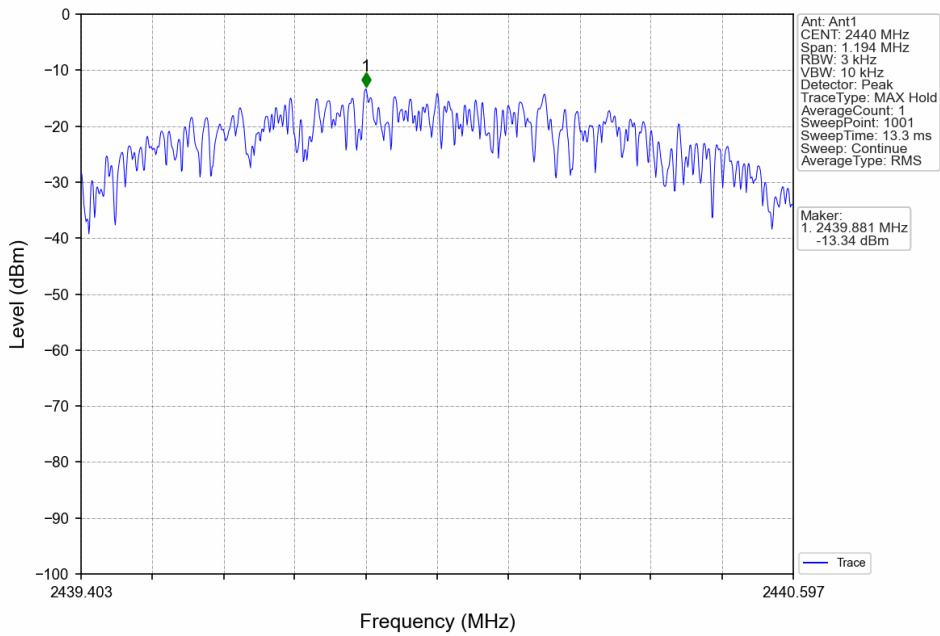

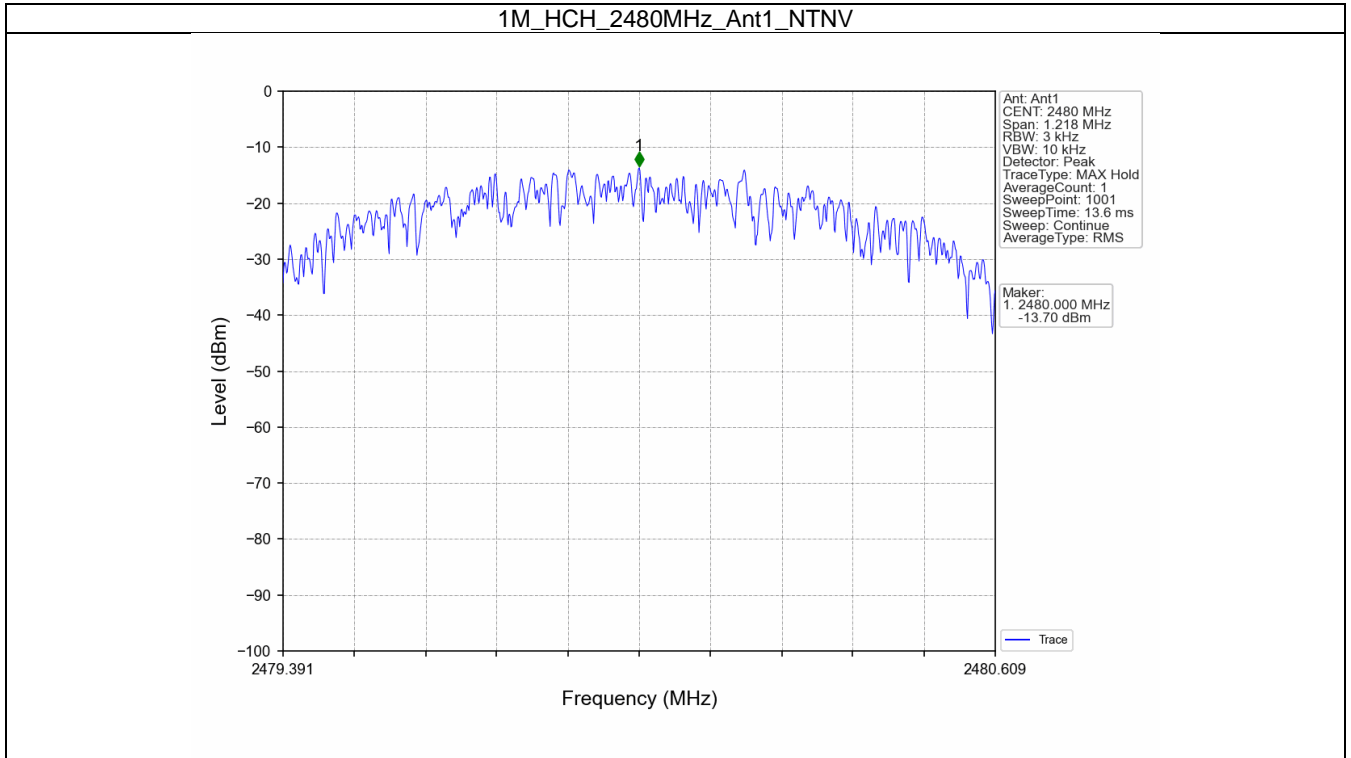

## 9.5 Spurious RF conducted emissions

### Test Method

1. The RF output of EUT was connected to the spectrum analyzer by RF cable. The path loss was compensated to the results for each measurement.
2. Set to the maximum power setting, the instrument center frequency is set to the nominal EUT channel center frequency enable the EUT transmit continuously.
3. Use the following spectrum analyzer settings:  
Span = wide enough to capture the peak level of the in-band emission and all spurious emissions (e.g., harmonics) from the lowest frequency generated in the EUT up through the 10<sup>th</sup> harmonic. Typically, several plots are required to cover this entire span.  
RBW = 100 kHz, VBW $\geq$ 3RBW, Sweep = auto, Detector function = peak, Trace = max hold
4. Allow the trace to stabilize. Set the marker on the peak of any spurious emission recorded.
5. The level displayed must comply with the limit specified in this Section. Submit these plots.
6. Repeat above procedures until all frequencies measured were complete.

### Limit

Frequency Range MHz	Limit (dBc)
30-25000	-20

### Test Result

Reference level:

Mode	TX Type	Frequency (MHz)	ANT	Level of Reference (dBm)
1M	SISO	2402	1	1.76
		2440	1	1.82
		2480	1	1.60

Note1: Refer to FCC Part 15.247 (d) and ANSI C63.10-2013, the channel contains the maximum PSD level was used to establish the reference level.

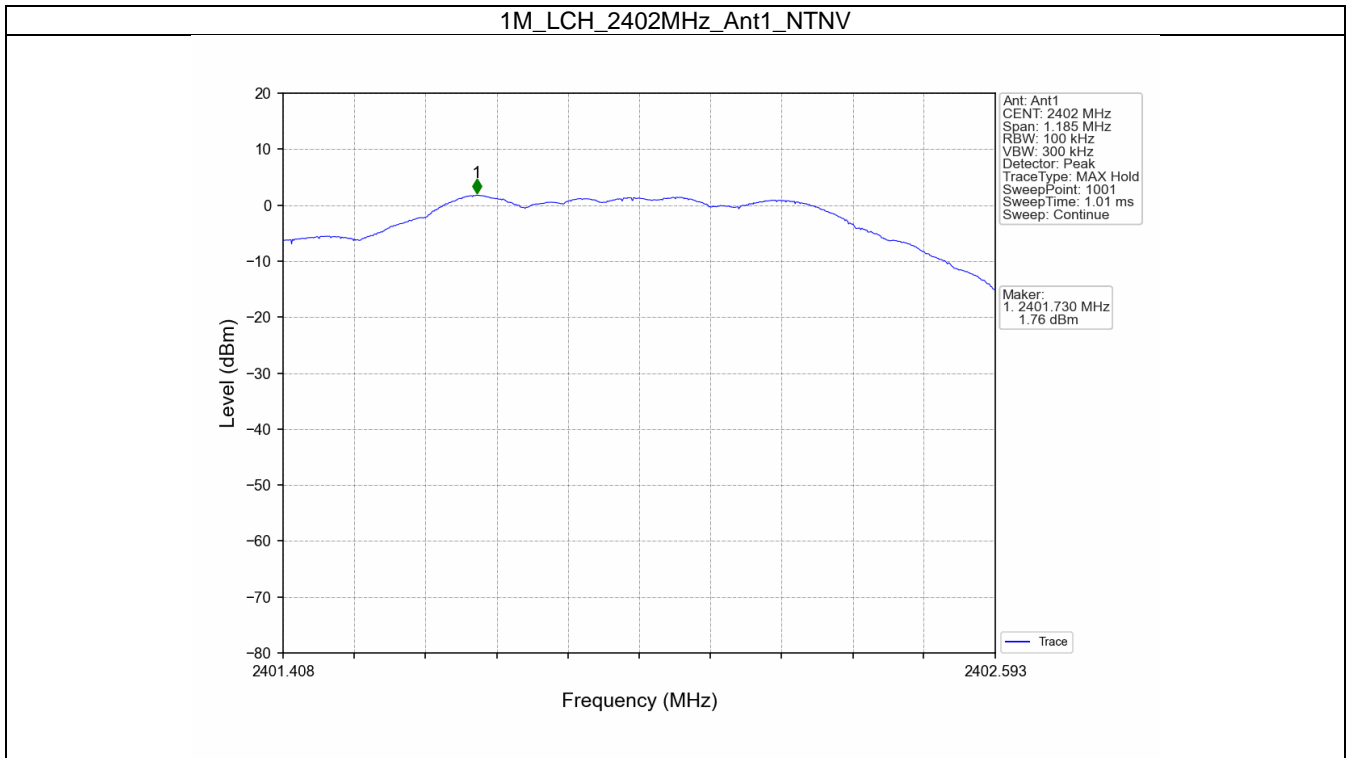



1M\_MCH\_2440MHz\_Ant1\_NTNV

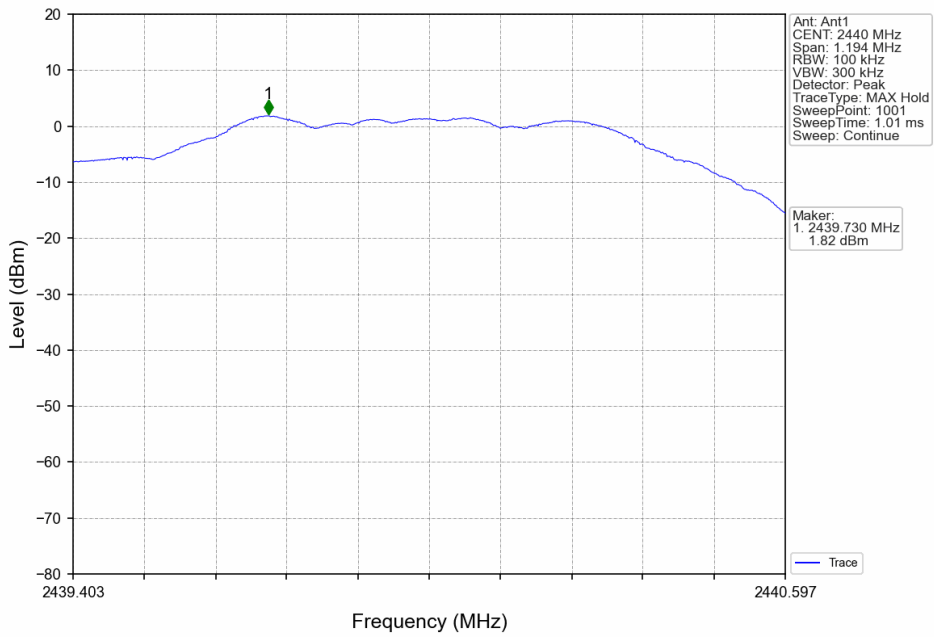

1M\_HCH\_2480MHz\_Ant1\_NTNV

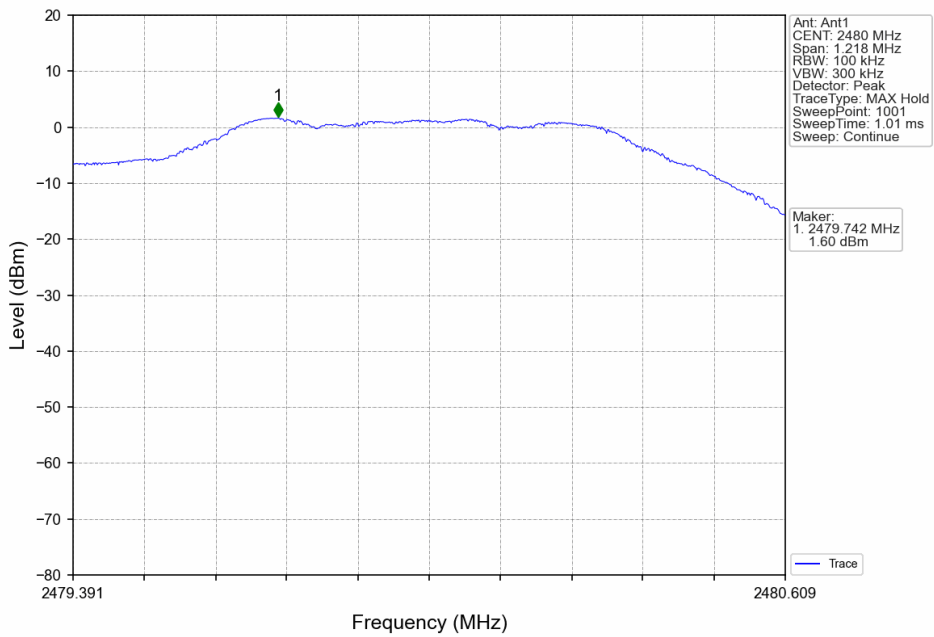

Conducted spurious emissions:

Mode	TX Type	Frequency (MHz)	ANT	Level of Reference (dBm)	Limit (dBm)	Verdict
1M	SISO	2402	1	1.76	-18.24	Pass
		2440	1	1.82	-18.18	Pass
		2480	1	1.60	-18.40	Pass

Note1: Refer to FCC Part 15.247 (d) and ANSI C63.10-2013, the channel contains the maximum PSD level was used to establish the reference level.

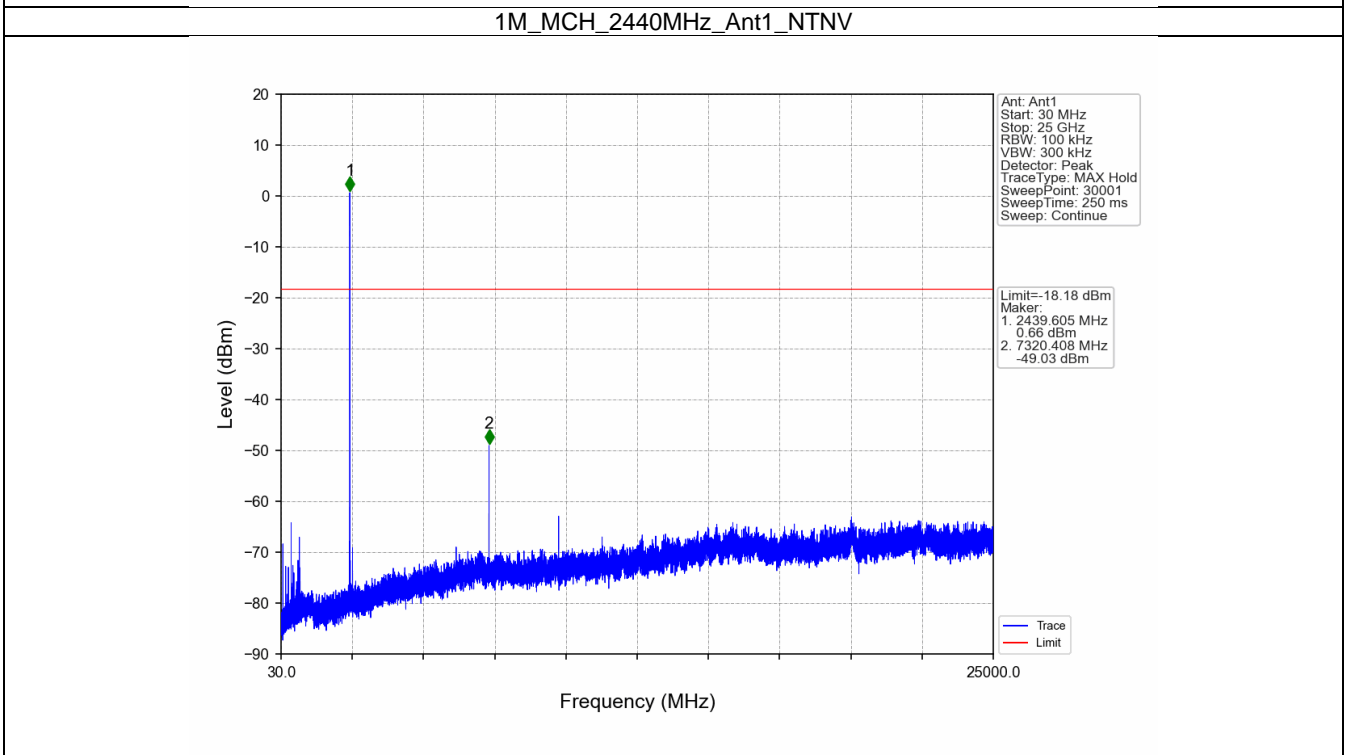
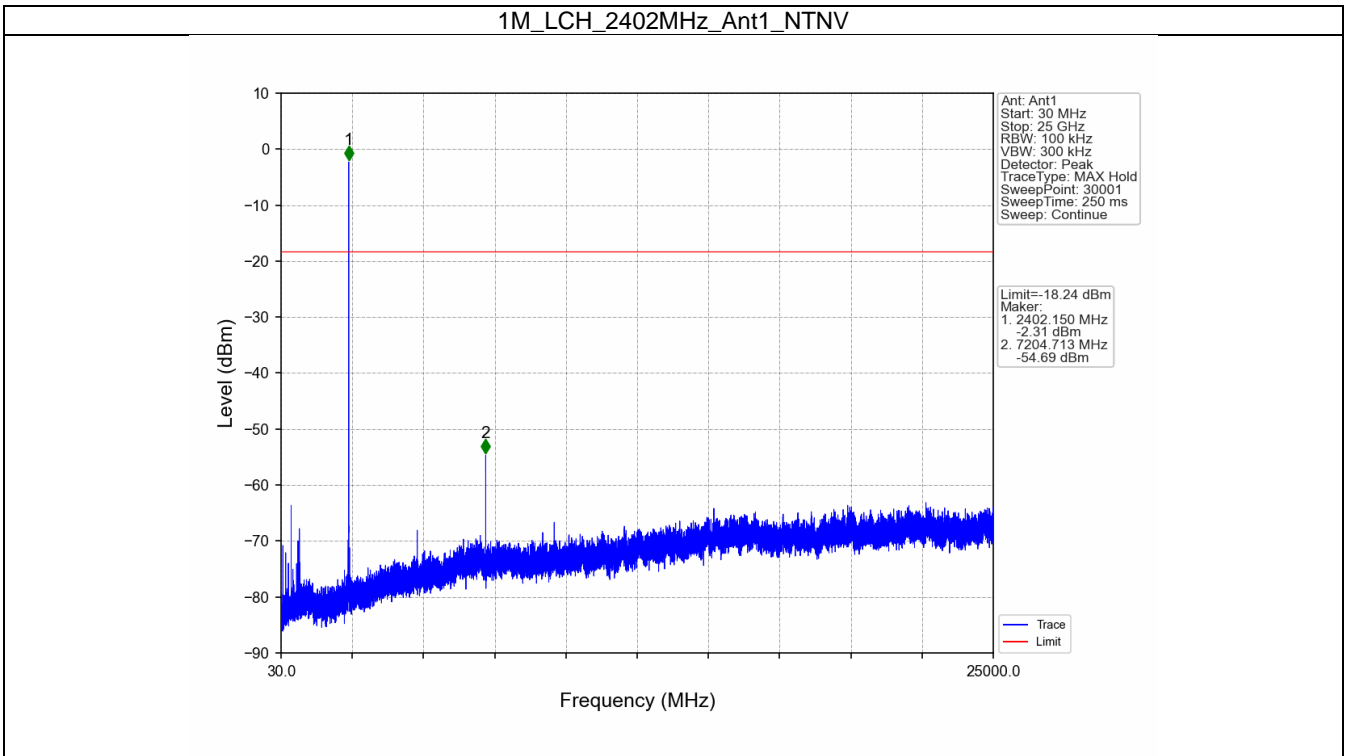

1M\_HCH\_2480MHz\_Ant1\_NTNV

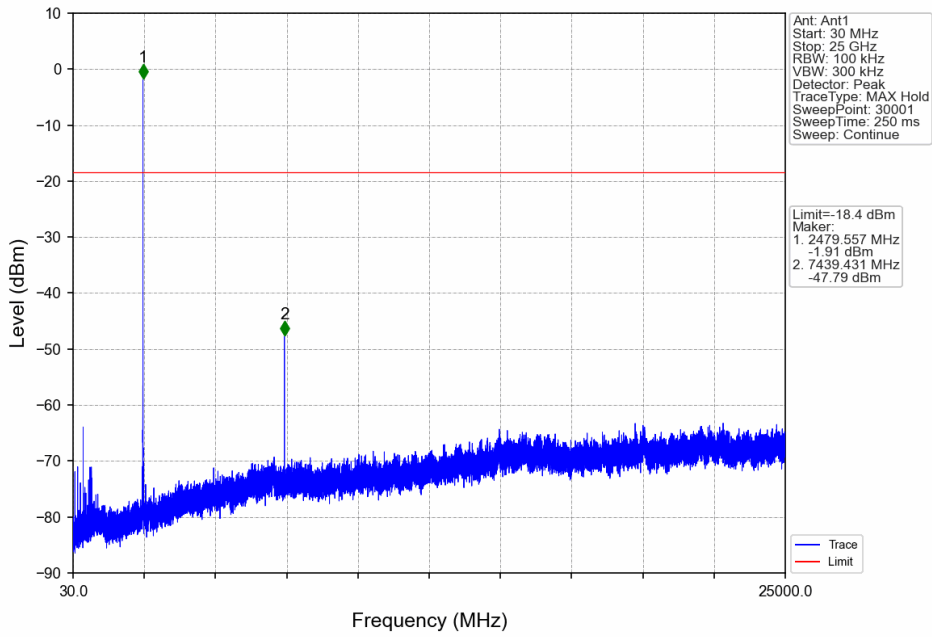

## 9.6 Band edge testing

### Test Method

1. The RF output of EUT was connected to the spectrum analyzer by RF cable. The path loss was compensated to the results for each measurement.
2. Set to the maximum power setting, the instrument center frequency is set to the nominal EUT channel center frequency enable the EUT transmit continuously.
3. Use the following spectrum analyzer settings:  
Span = wide enough to capture the peak level of the in-band emission and all spurious  
RBW = 100 kHz, VBW $\geq$ 3RBW, Sweep = auto, Detector function = peak, Trace = max hold
4. Allow the trace to stabilize, use the peak and delta measurement to record the result.
5. The level displayed must comply with the limit specified in this Section.
6. Repeat above procedures until all frequencies measured were complete and submit all the plots.

### Limit

In any 100 kHz bandwidth outside the frequency band in which the spread spectrum or digitally modulated device is operating, the RF power that is produced shall be at least 20 dB below that in the 100 kHz bandwidth within the band that contains the highest level of the desired power, based on either an RF conducted or a radiated measurement, provided that the transmitter demonstrates compliance with the peak conducted power limits. If the transmitter complies with the conducted power limits based on the use of RMS averaging over a time interval, as permitted under § 15.247(b)(3), the attenuation required shall be 30 dB instead of 20 dB.

Frequency Range MHz	Limit (dBc)
30-25000	-20

### Test result

Mode	TX Type	Frequency (MHz)	ANT	Level of Reference (dBm)	Limit (dBm)	Verdict
1M	SISO	2402	1	1.76	-18.24	Pass
		2440	1	1.82	-18.18	Pass
		2480	1	1.60	-18.40	Pass

1M\_LCH\_2402MHz\_Ant1\_NTNV

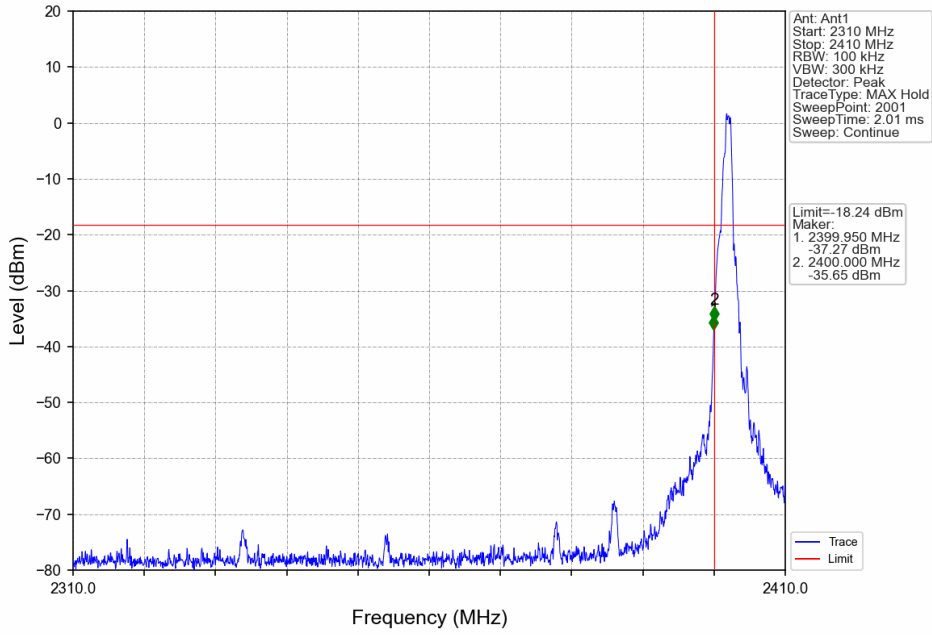

1M\_HCH\_2480MHz\_Ant1\_NTNV

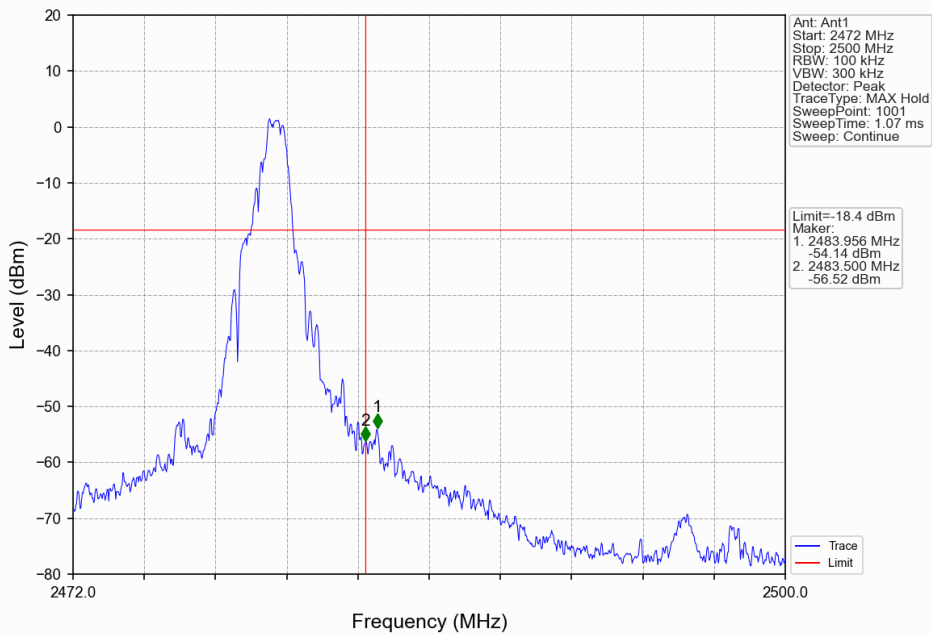

## 9.7 Spurious radiated emissions for transmitter

### Test Method

1. The EUT was placed on a turn table which is 1.5m above ground plane for above 1GHz and 0.8m above ground for below 1GHz at 3 meter chamber room for test. The table was rotated 360 degrees to determine the position of the highest radiation.
2. The EUT was set 3 meters away from the interference – receiving antenna, which was mounted on the top of a variable – height antenna tower.
3. The height of antenna is varied from one meter to four meters above the ground to determine the maximum value of the field strength. Both horizontal and vertical polarizations of the antenna are set to make the measurement.
4. For each suspected emission, the EUT was arranged to its worst case and then the antenna was tuned to heights from 1 meter to 4 meters and the rotatable table was turned from 0 degrees to 360 degrees to find the maximum reading.
5. Use the following spectrum analyzer settings According to C63.10:
  - 1) Procedure for Unwanted Emissions Measurements Below 1000 MHz  
Span = wide enough to capture the peak level of the in-band emission and all spurious  
RBW = 100 KHz to 120KHz, VBW ≥ RBW for peak measurement, Sweep = auto, Detector function = peak, Trace = max hold.
  - 2) For Peak unwanted emissions Above 1GHz:  
Span = wide enough to capture the peak level of the in-band emission and all spurious  
RBW = 1MHz, VBW ≥ RBW for peak measurement, Sweep = auto, Detector function = peak, Trace = max hold.
  - 3) Procedures for average unwanted emissions measurements above 1000 MHz
    - a) RBW = 1MHz.
    - b) VBW \ [3 × RBW].
    - c) Detector = RMS (power averaging), if [span / (# of points in sweep)] \ RBW / 2. Satisfying this condition can require increasing the number of points in the sweep or reducing the span. If the condition is not satisfied, then the detector mode shall be set to peak.
    - d) Averaging type = power (i.e., rms) (As an alternative, the detector and averaging type may be set for linear voltage averaging. Some instruments require linear display mode to use linear voltage averaging. Log or dB averaging shall not be used.)
    - e) Sweep time = auto.
    - f) Perform a trace average of at least 100 traces if the transmission is continuous. If the transmission is not continuous, then the number of traces shall be increased by a factor of 1 / D, where D is the duty cycle. For example, with 50% duty cycle, at least 200 traces shall be averaged. (If a specific emission is demonstrated to be continuous—i.e., 100% duty cycle—then rather than turning ON and OFF with the transmit cycle, at least 100 traces shall be averaged.)
    - g) If tests are performed with the EUT transmitting at a duty cycle less than 98%, then a correction factor shall be added to the measurement results prior to comparing with the emission limit, to compute the emission level that would have been measured had the test been performed at 100% duty cycle. The correction factor is computed as follows:
      - 1) If power averaging (rms) mode was used in the preceding step e), then the correction factor is  $[10 \log (1 / D)]$ , where D is the duty cycle. For example, if the transmit duty cycle was 50%, then 3 dB shall be added to the measured emission levels.

2) If linear voltage averaging mode was used in the preceding step e), then the correction factor is  $[20 \log (1 / D)]$ , where D is the duty cycle. For example, if the transmit duty cycle was 50%, then 6 dB shall be added to the measured emission levels.

3) If a specific emission is demonstrated to be continuous (100% duty cycle) rather than turning ON and OFF with the transmit cycle, then no duty cycle correction is required for that emission(AV) at frequency above 1GHz.

## Limit

In any 100 kHz bandwidth outside the frequency band in which the spread spectrum or digitally modulated device is operating, the RF power that is produced shall be at least 20 dB below that in the 100 kHz bandwidth within the band that contains the highest level of the desired power, based on either an RF conducted or a radiated measurement, provided that the transmitter demonstrates compliance with the peak conducted power limits. If the transmitter complies with the conducted power limits based on the use of RMS averaging over a time interval, as permitted under § 15.247(b)(3), the attenuation required shall be 30 dB instead of 20 dB. Attenuation below the general field strength limits specified in § 15.209(a) is not required. In addition, radiated emissions which fall in the restricted bands, as defined in § 15.205(a), must also comply with the radiated emission limits specified in § 15.209(a).

Frequency MHz	Field Strength $\mu\text{V/m}$	Field Strength $\text{dB}\mu\text{V/m}$	Detector	Measurement distance meters
0.009-0.490	2400/F(kHz)	48.5-13.8	AV	300
0.490-1.705	24000/F(kHz)	33.8-23.0	QP	30
1.705-30	30	29.5	QP	30
30-88	100	40	QP	3
88-216	150	43.5	QP	3
216-960	200	46	QP	3
960-1000	500	54	QP	3
Above 1000	500	54	AV	3
Above 1000	5000	74	PK	3

Note 1: Limit  $3\text{m}(\text{dB}\mu\text{V/m}) = \text{Limit } 300\text{m}(\text{dB}\mu\text{V/m}) + 40\text{Log}(300\text{m}/3\text{m})$  (Below 30MHz)

Note 2: Limit  $3\text{m}(\text{dB}\mu\text{V/m}) = \text{Limit } 30\text{m}(\text{dB}\mu\text{V/m}) + 40\text{Log}(30\text{m}/3\text{m})$  (Below 30MHz)

### Spurious radiated emissions for transmitter

According to C63.10, if the peak (or quasi-peak) measured value complies with the average limit, it is unnecessary to perform an average measurement, so AV emission value did not show in below table if the peak value complies with average limit.

#### Transmitting spurious emission test result as below:

Emission below 1GHz

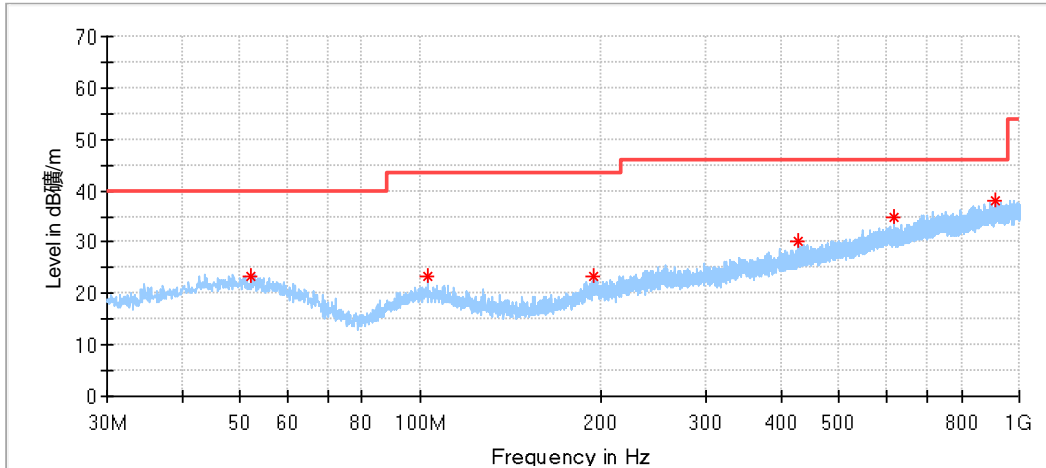

Frequency (MHz)	MaxPeak (dBµV/m)	Limit (dBµV/m)	Margin (dB)	Height (cm)	Pol	Azimuth (deg)	Corr. (dB/m)
52.310000	23.33	40.00	16.67	100.0	H	321.0	18.20
103.127222	23.19	43.50	20.31	100.0	H	279.0	16.00
194.199444	23.24	43.50	20.26	100.0	H	0.0	16.25
427.915556	30.28	46.00	15.72	100.0	H	263.0	21.73
615.987778	34.85	46.00	11.15	100.0	H	247.0	25.31
912.376667	37.93	46.00	8.07	100.0	H	4.0	29.43

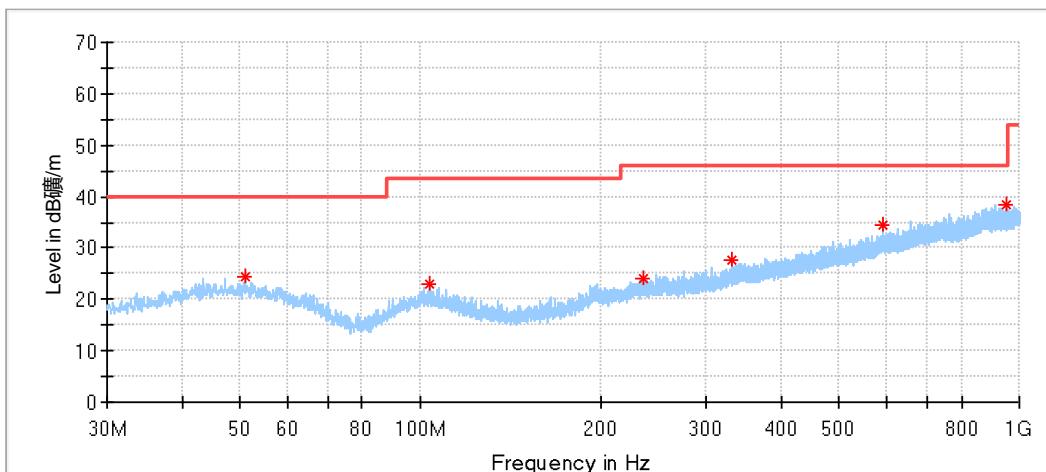

Frequency (MHz)	MaxPeak (dBµV/m)	Limit (dBµV/m)	Margin (dB)	Height (cm)	Pol	Azimuth (deg)	Corr. (dB/m)
50.908889	24.58	40.00	15.42	100.0	V	229.0	18.22
103.989444	22.83	43.50	20.67	100.0	V	326.0	16.10
235.316667	24.10	46.00	21.90	100.0	V	137.0	17.04
332.155000	27.51	46.00	18.49	100.0	V	271.0	19.46
591.306667	34.42	46.00	11.58	100.0	V	167.0	24.95
953.493889	38.40	46.00	7.60	100.0	V	14.0	29.59



Emission above 1GHz  
BLE\_1Mbps\_Low Channel: 2402MHz

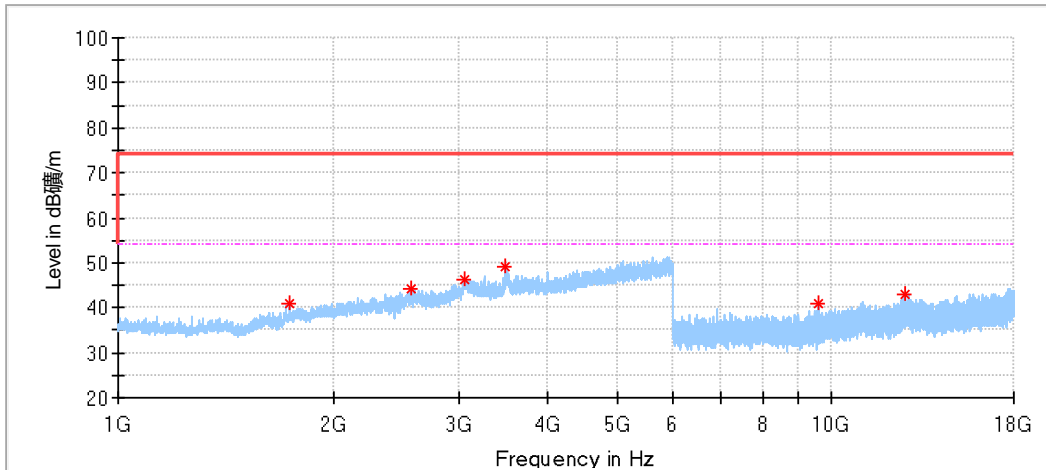

Frequency (MHz)	MaxPeak (dBµV/m)	Limit (dBµV/m)	Margin (dB)	Height (cm)	Pol	Azimuth (deg)	Corr. (dB/m)
1740.500000	40.93	74.00	33.07	150.0	H	4.0	-5.99
2571.000000	44.30	74.00	29.70	150.0	H	271.0	-1.21
3060.000000	46.31	74.00	27.69	150.0	H	66.0	1.61
3491.000000	49.18	74.00	24.82	150.0	H	148.0	3.80
9608.000000	40.85	74.00	33.15	150.0	H	240.0	8.87
12710.500000	42.91	74.00	31.09	150.0	H	6.0	12.82

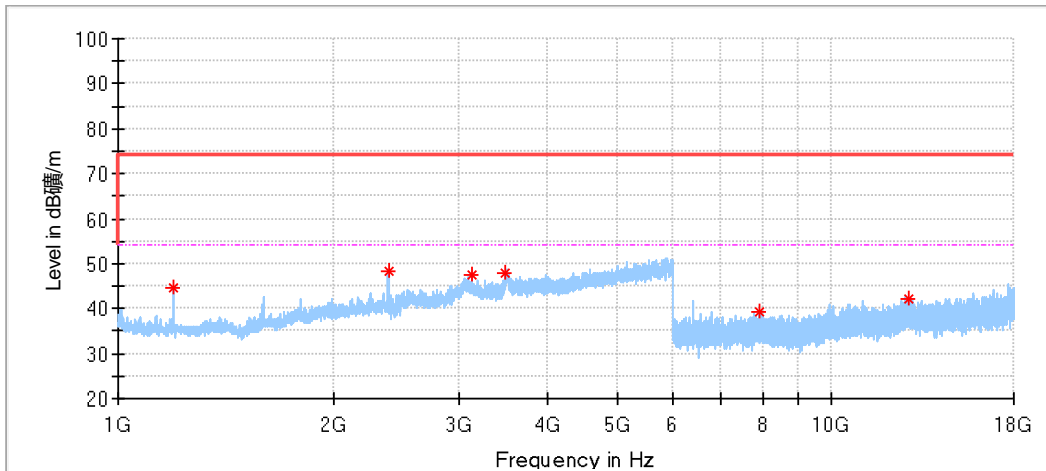

Frequency (MHz)	MaxPeak (dBµV/m)	Limit (dBµV/m)	Margin (dB)	Height (cm)	Pol	Azimuth (deg)	Corr. (dB/m)
1194.500000	44.46	74.00	29.54	150.0	V	247.0	-8.77
2390.000000	48.34	74.00	25.66	150.0	V	233.0	-2.45
3133.000000	47.42	74.00	26.58	150.0	V	358.0	1.24
3494.000000	48.02	74.00	25.98	150.0	V	52.0	4.03
7916.500000	39.26	74.00	34.74	150.0	V	302.0	7.22
12818.000000	42.31	74.00	31.69	150.0	V	302.0	12.96

BLE\_1Mbps\_Middle Channel: 2440MHz

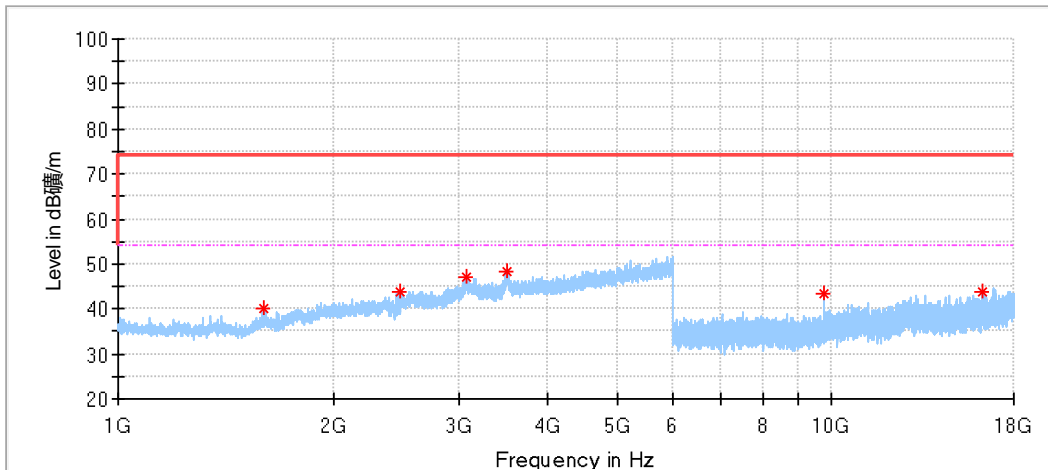

Frequency (MHz)	MaxPeak (dBµV/m)	Limit (dBµV/m)	Margin (dB)	Height (cm)	Pol	Azimuth (deg)	Corr. (dB/m)
1600.000000	39.96	74.00	34.04	150.0	H	233.0	-6.84
2491.000000	43.88	74.00	30.12	150.0	H	4.0	-1.83
3080.000000	47.23	74.00	26.77	150.0	H	189.0	1.53
3501.500000	48.39	74.00	25.61	150.0	H	274.0	4.41
9760.000000	43.29	74.00	30.71	150.0	H	215.0	9.20
16272.000000	43.74	74.00	30.26	150.0	H	55.0	16.77

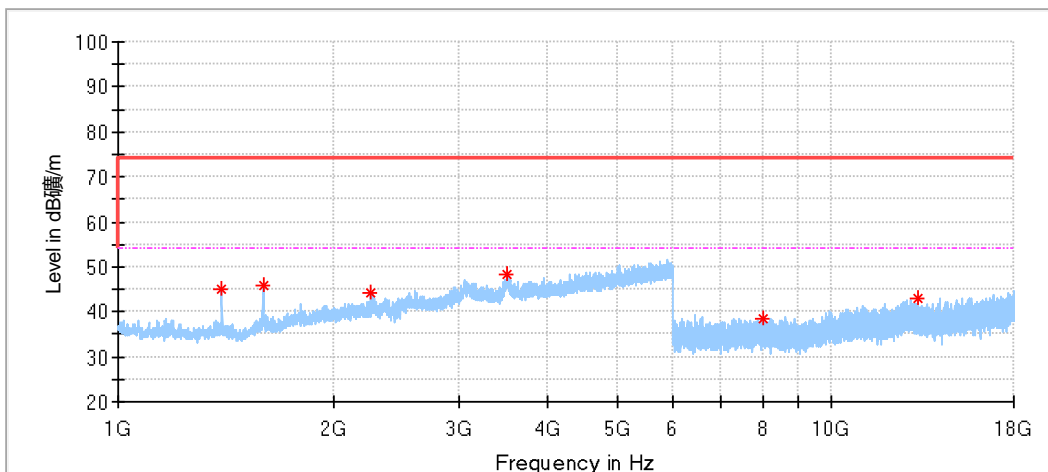

Frequency (MHz)	MaxPeak (dBµV/m)	Limit (dBµV/m)	Margin (dB)	Height (cm)	Pol	Azimuth (deg)	Corr. (dB/m)
1397.500000	45.16	74.00	28.84	150.0	V	216.0	-7.99
1595.000000	45.85	74.00	28.15	150.0	V	203.0	-6.92
2259.000000	44.14	74.00	29.86	150.0	V	203.0	-3.25
3501.000000	48.19	74.00	25.81	150.0	V	107.0	4.43
7995.000000	38.60	74.00	35.40	150.0	V	216.0	7.45
13224.000000	43.15	74.00	30.85	150.0	V	190.0	12.89

BLE\_1Mbps\_High Channel: 2480MHz

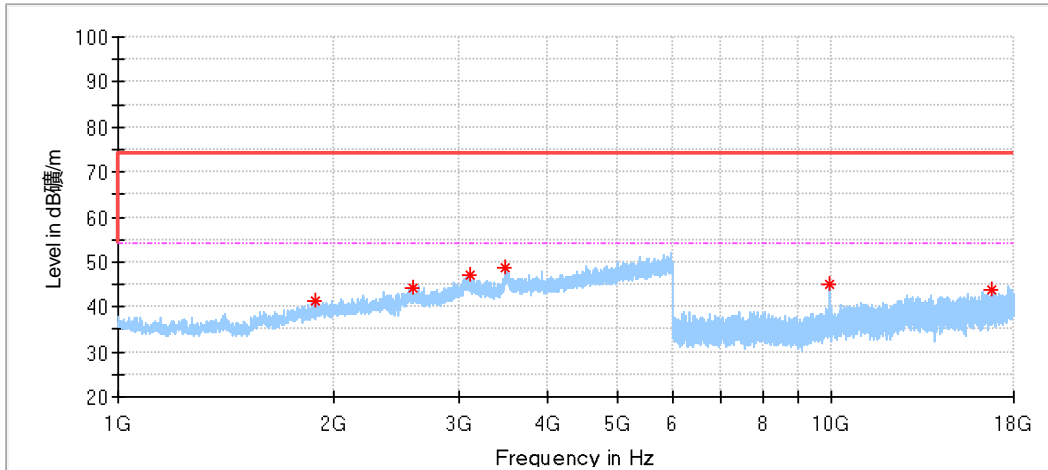

Frequency (MHz)	MaxPeak (dBµV/m)	Limit (dBµV/m)	Margin (dB)	Height (cm)	Pol	Azimuth (deg)	Corr. (dB/m)
1884.500000	41.27	74.00	32.73	150.0	H	78.0	-5.07
2591.500000	44.20	74.00	29.80	150.0	H	92.0	-1.09
3119.500000	46.97	74.00	27.03	150.0	H	133.0	1.39
3496.500000	48.53	74.00	25.47	150.0	H	215.0	4.22
9920.000000	45.02	74.00	28.98	150.0	H	216.0	9.39
16803.000000	43.92	74.00	30.08	150.0	H	246.0	18.41

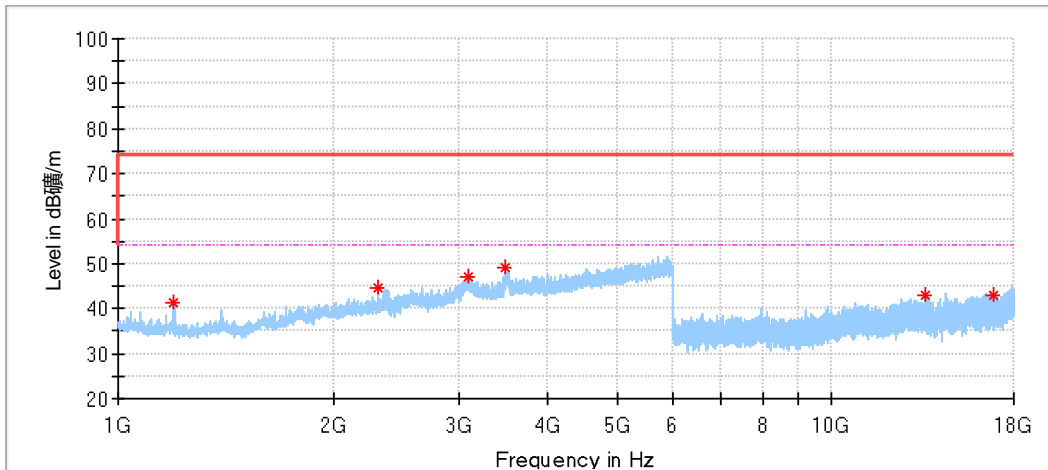

Frequency (MHz)	MaxPeak (dBµV/m)	Limit (dBµV/m)	Margin (dB)	Height (cm)	Pol	Azimuth (deg)	Corr. (dB/m)
1198.000000	41.42	74.00	32.58	150.0	V	189.0	-8.77
2313.000000	44.66	74.00	29.34	150.0	V	203.0	-3.16
3102.500000	47.28	74.00	26.72	150.0	V	13.0	1.61
3496.000000	49.10	74.00	24.90	150.0	V	25.0	4.18
13547.000000	43.13	74.00	30.87	150.0	V	109.0	12.84
16816.500000	43.18	74.00	30.82	150.0	V	302.0	18.43

Remark:

- (1) "\*" means the emission(s) appear within the restrict bands shall follow the requirement of section 15.205.
- (2) Data of measurement within frequency ranges 9kHz-30MHz and 18-26GHz are the noise floor or attenuated more than 20dB below the permissible limits or the field strength is too small to be measured, so test data does not present in this report,
- (3) Level= Reading Level + Correction Factor
- (4) Above 1GHz: Corrector factor = Antenna Factor + Cable Loss- Amplifier Gain  
Below 1GHz: Corrector factor = Antenna Factor + Cable Loss  
(The Reading Level is recorded by software which is not shown in the sheet)

## 10 Test Equipment List

### Conducted Emission Test

Description	Manufacturer	Model no.	Equipment ID	Serial no.	Cal interval (year)	Cal. due date
EMI Test Receiver	Rohde & Schwarz	ESR 3	68-4-74-19-002	102590	1	2024-5-19
LISN	Rohde & Schwarz	ENV216	68-4-87-19-001	102472	1	2024-5-20
Attenuator	Shanghai Huaxiang	TS2-26-3	68-4-81-16-003	080928189	1	2024-5-19
Test software	Rohde & Schwarz	EMC32	68-4-90-19-005-A01	Version 10.35.02	N/A	N/A
Shielding Room	TDK	CSR #2	68-4-90-19-005	----	3	2025-10-15

### Radiated Emission Test, SAC-3 #1

Description	Manufacturer	Model no.	Equipment ID	Serial no.	Cal interval (year)	Cal. due date
EMI Test Receiver	Rohde & Schwarz	ESR 7	68-4-74-19-001	102176	1	2024-5-20
Loop Antenna	Rohde & Schwarz	HFH2-Z2	68-4-80-14-006	100398	1	2024-8-7
Pre-amplifier	Rohde & Schwarz	SCU 18	68-4-29-14-001	102230	1	2024-5-19
Attenuator	Mini-circuits	UNAT-6+	68-4-81-21-001	15542	1	2024-5-19
3m Semi-anechoic chamber	TDK	SAC-3 #1	68-4-90-14-001	----	3	2024-5-28
Test software	Rohde & Schwarz	EMC32	68-4-90-14-001-A10	Version10.35.02	N/A	N/A

### Radiated Emission Test, SAC-3 #2

Description	Manufacturer	Model no.	Equipment ID	Serial no.	Cal interval (year)	Cal. due date
EMI Test Receiver	Rohde & Schwarz	ESR 26	68-4-74-14-002	101269	1	2024-5-20
Trilog Super Broadband Test Antenna	Schwarzbeck	VULB 9162	68-4-80-19-003	284	1	2024-3-5
Wave Guide Antenna	ETS	3117	68-4-80-19-001	00218954	1	2024-4-26
Pre-amplifier	Rohde & Schwarz	SCU 18F	68-4-29-19-001	100745	1	2024-5-19
Pre-amplifier	Rohde & Schwarz	SCU 18F	68-4-29-19-002	100746	1	2024-5-19
Sideband Horn Antenna	Q-PAR	QWH-SL-18-40-K-SG	68-4-80-14-008	12827	1	2024-7-11
Pre-amplifier	Rohde & Schwarz	SCU 40A	68-4-29-14-002	100432	1	2024-8-1
Attenuator	Mini-circuits	UNAT-6+	68-4-81-21-002	15542	1	2024-5-19
3m Semi-anechoic chamber	TDK	SAC-3 #2	68-4-90-19-006	----	2	2024-5-28
Test software	Rohde & Schwarz	EMC32	68-4-90-19-006-A01	Version10.35.02	N/A	N/A

### RF Conducted Test

Description	Manufacturer	Model no.	Equipment ID	Serial no.	Cal interval (year)	Cal. due date
Signal Analyzer	Rohde & Schwarz	FSV40	68-4-74-14-004	101030	1	2024-5-19
Test software	Tonscend	System for BT/WIFI	68-4-74-14-006-A13	Version 2.6.77.0518	N/A	N/A

## 11 System Measurement Uncertainty

For a 95% confidence level, the measurement expanded uncertainties for defined systems, in accordance with the recommendations of ISO 17025 were:

System Measurement Uncertainty	
Test Items	Extended Uncertainty
Uncertainty for Conducted Emission in new shielding room (68-4-90-19-005) 150kHz-30MHz (for test using AMN ENV216)	3.33dB
Uncertainty for Radiated Emission in 3m chamber (68-4-90-14-001) 9kHz-30MHz	4.70dB
Uncertainty for Radiated Emission in new 3m chamber (68-4-90-19-006) 30MHz-1000MHz	Horizontal: 4.59dB; Vertical: 4.75dB
Uncertainty for Radiated Emission in new 3m chamber (68-4-90-19-006) 1000MHz-18000MHz	Horizontal: 5.08dB; Vertical: 5.09dB
Uncertainty for Radiated Emission in new 3m chamber (68-4-90-19-006) above 18000MHz	Horizontal: 3.14dB; Vertical: 3.12dB
Uncertainty for Conducted RF test with TS 8997	RF Power Conducted: 1.31dB Frequency test involved: 0.6×10 <sup>-8</sup> or 1%

### Measurement Uncertainty Decision Rule:

Determination of conformity with the specification limits is based on the decision rule according to IEC Guide 115:2021, clause 4.4.3 and 4.5.1.

--- END OF REPORT---