



Smart Fitness Scale

Model: ESF14

User Manual



Questions or Concerns?

Mon-Fri, 9:00 am-5:00 pm PST/PDT
support@etekcity.com • (855) 686-3835

Table of Contents

Package Contents	3
Specifications	3
Safety Information	4
Function Diagram	6
Digital Display	7
VeSync App Setup	8
Before First Use	9
Using the Smart Scale	10
Maintenance	11
• Calibrating the Smart Scale	11
• Cleaning the Smart Scale	11
• Replacing the Batteries	12
Display Messages	13
Troubleshooting	14
FCC Statement	16
Warranty Information	17
Customer Support	19

Package Contents

- 1 x Smart Fitness Scale
- 3 x 1.5V AAA Batteries (Pre-Installed)
- 1 x Quick Start Guide
- 1 x Measuring Tape

Specifications

Weight Capacity	400 lb / 28 st / 180 kg
Increments	0.1 lb / 0.05 kg
Weight Units	lb / st / kg
Platform	Tempered glass
Dimensions	11 x 11 x 1 in / 28 x 28 x 2.5 cm
Battery Type	3 x 1.5V AAA batteries
Auto-Off	30 seconds

Safety Information

Please read and follow all instructions and safety guidelines in this manual.

Medical

- This scale should not be used to diagnose or treat any medical condition.
- Scale data should not be used as a substitute for medical advice from a healthcare professional.
- This scale uses a harmless electrical current to measure body fat. Consult a healthcare professional before using the smart scale if you use medical electronic equipment such as a pacemaker.

General Use

- Check the scale before using. **Do not** use the scale if it is damaged in any way.
- **Do not** strike or hit the scale. **Do not** use the scale if the glass is cracked or broken. Due to the nature of tempered glass, the glass will shatter if there is even a slight crack. If you see a crack, contact **Customer Support** immediately (page 19).
- The glass platform is slippery when wet. **Always** make sure the platform and your feet are dry before stepping on for measurement.
- Place the scale on a hard, flat surface to avoid tipping.
- To weigh safely and accurately, stand with your feet shoulder-width apart while on the scale. **Do not** stand on the edge of the scale or jump on the scale.
- Avoid standing on the scale for a long period of time, or when not weighing yourself.
- **Do not** overload the scale. Maximum weight capacity is 400 lb / 28 st / 180 kg.
- Keep the scale in a cool area with low humidity. Keep the scale away from heat sources, such as ovens or heaters. Avoid temperature fluctuations. Store the scale in a horizontal position, not a vertical position.
- Handle with care.
- Not for commercial use. Household use **only**.

Batteries

- **Do not** mix new and old batteries.
- If the low battery indicator “Lo” appears on the display, replace the batteries.
- If the scale is not in use for a long period of time, remove the batteries to extend the lifetime of the scale.

SAVE THESE INSTRUCTIONS

Function Diagram

- A. Display
- B. Weighing Platform
- C. Anti-Skid Padding
- D. Battery Compartment

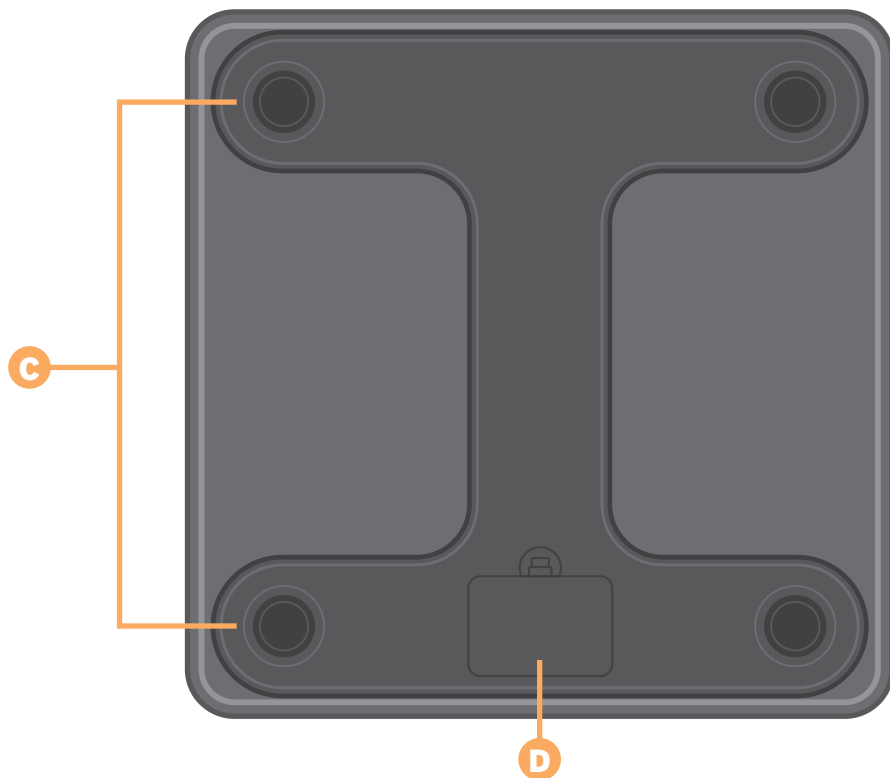
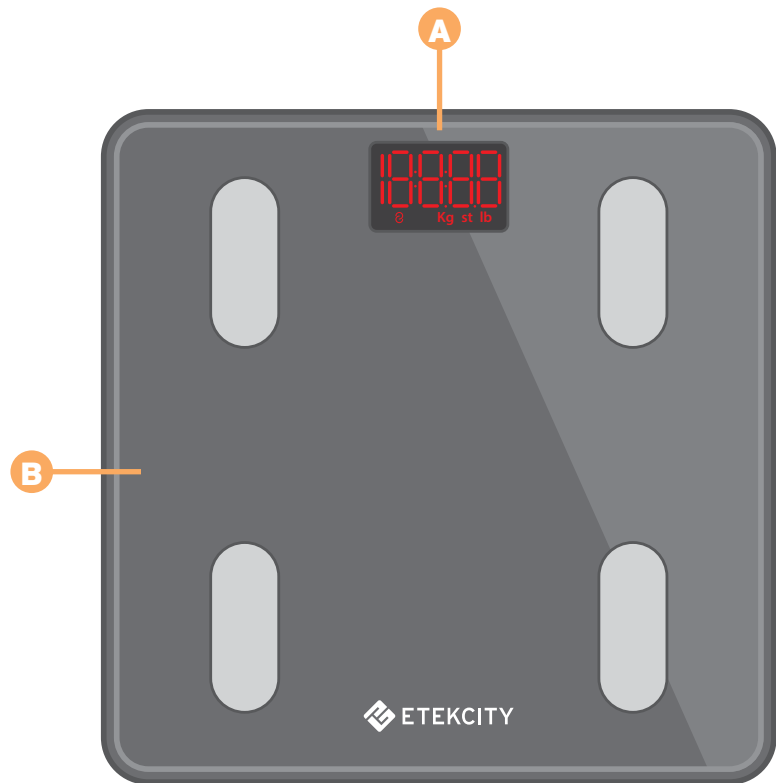

Digital Display

- A. Weight Measurement
- B. Wireless Connection Icon
- C. Weight Units

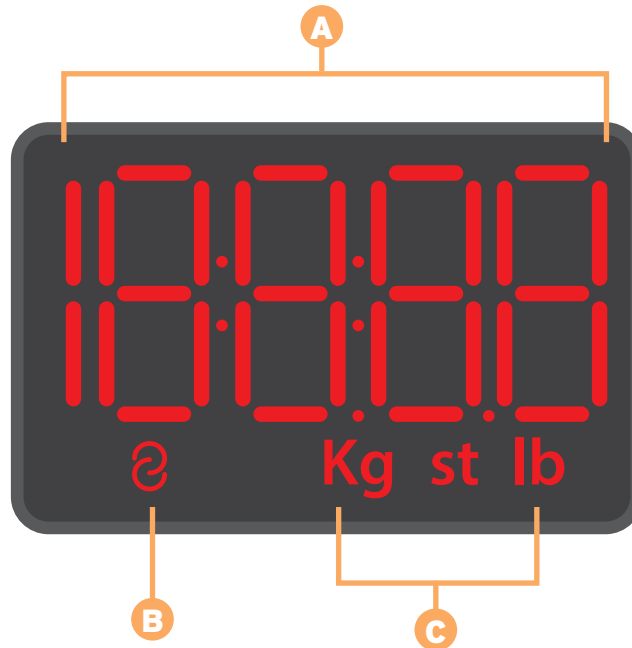

VeSync App Setup

Note: Due to app updates and improvements, the contents of this manual may change without notice. The VeSync app user interface may appear slightly different.

1. To download the VeSync app, scan the QR code or search “VeSync” in the Apple App Store® or Google Play Store.

Note:

- This smart scale uses the VeSync app, not the VeSyncFit app.
 - For Android™ users, you may need to select “Allow” to use VeSync.
2. Open the VeSync app. If you already have an account, tap **Log In**. To create a new account, tap **Sign Up**.



3. Make sure your phone has Bluetooth® turned on.
4. Follow the in-app instructions to add your smart scale.

Creating a User

If you are a new user, you will need to enter physical information before weighing yourself for the first time so the scale can calculate your body metrics. Follow the in-app instructions to add a user.

Note:

- *Entering inaccurate information will make the scale's measurements less accurate.*
- *If you don't identify with the available gender options, or are unsure, pick the choice that you think best physically matches you. This choice is used for physical measurements, such as body fat percentages.*

Before First Use

1. Open the battery compartment on the underside of the scale. Remove the included AAA batteries.
2. Remove the plastic insulator strip from the battery compartment.
3. Replace the batteries (see **Replacing the Batteries**, page 12). Follow the guidelines in the battery compartment to match the + and - terminals.

Using the Smart Scale

Note:

- To switch between pounds (lb), stone (st), and kilograms (kg), select the weight unit in the Device Settings menu in the VeSync app.
- If you are pregnant, scale measurements will not be accurate.

1. Place the scale on a hard, flat surface. [\[Figure 1.1\]](#)
2. Make sure your feet are dry. Place bare feet on the scale's conductive areas. The scale will automatically turn on and start measuring your weight.
3. Continue standing on the scale until the digits on the screen flash 3 times, showing your final measurement. If you've set up your smart scale in the VeSync app, additional results (such as BMI, body fat, etc) will show on the app. [\[Figure 1.2\]](#)

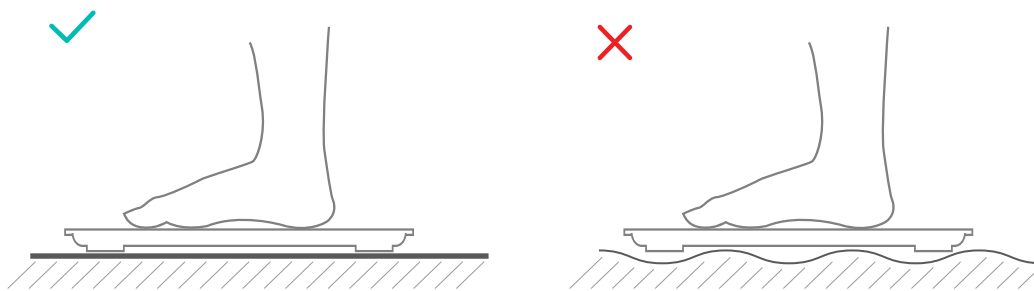

Figure 1.1

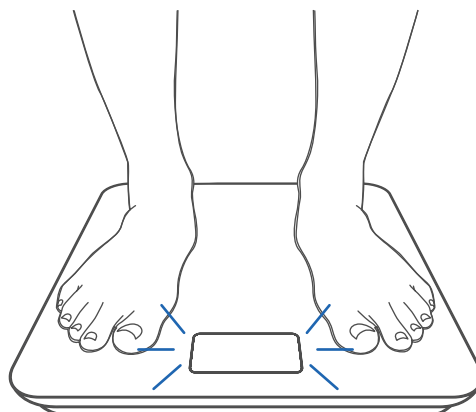

Figure 1.2

Maintenance

Calibrating the Smart Scale

If the scale has been moved or flipped upside down, it must be calibrated to ensure accurate results.

1. Place the scale on a hard, flat surface.
2. Step on the scale with 1 foot until digits appear on the display. *[Figure 2.1]* Then, step off.
3. The scale will show "CAL" while calibrating, then "00" when complete. *[Figure 2.2]*

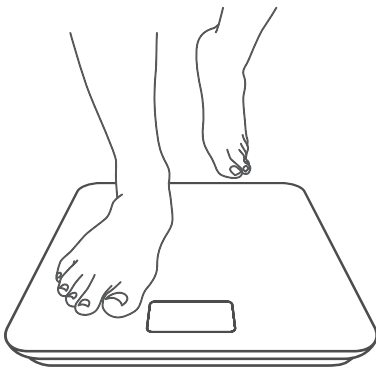

Figure 2.1



Figure 2.2

Cleaning the Smart Scale

- Use a slightly damp cloth to clean the surface of the scale, followed by a soft, dry cloth to wipe away any remaining moisture.
- **Do not** use chemical or abrasive cleaning agents to clean the scale.

Replacing the Batteries

The display will show “Lo” when the batteries need to be replaced.

1. Open the battery compartment on the underside of the scale.
2. Remove the old batteries and dispose of them properly.
3. Install 3 new 1.5V AAA batteries. Follow the guidelines in the battery compartment to match the + and - terminals.
4. After closing the battery compartment, calibrate the scale (see **Calibrating the Smart Scale**, page 11).

Display Messages

48.65

Ⓜ

Wireless Connection

Lo

Change Battery

CAL

Calibrating

Err

Overload

Troubleshooting

The scale doesn't turn on.

- Check if the batteries are properly installed. If using the scale for the first time, remove the plastic insulator strip from the battery compartment.

Information flashes on the screen and then disappears.

- The batteries are low and may need to be replaced.

The smart scale doesn't connect with the VeSync app.

- Make sure your phone's operating system is running iOS® 9.0+ or Android™ 5.0+.
- Close and relaunch the VeSync app. Make sure you're using the latest version.
- Make sure your phone has Bluetooth turned on and is not currently connected to another Bluetooth device. For Android users, make sure your Location is turned on as well.
- Make sure your scale and phone are within 30 ft / 10 m of each other.
- Make sure the scale is not currently connected to any other phone or app.

My scale only measures my weight, not my body fat or other metrics.

- Set up your smart scale in the VeSync app. Your weight will show on the scale display, and more results will show on the app.
- Make sure your phone has Bluetooth turned on.
- If you're wearing shoes or socks, the scale cannot measure health metrics such as body fat. Step on the scale with bare feet. *[Figure 3.1]*

Note: *If the scale has errors on the display, will not turn off automatically, or has a problem not listed here, try removing the batteries for 3 seconds, then replacing them.*

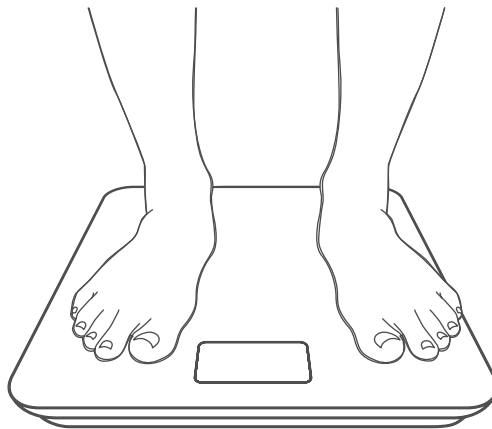

Figure 3.1

If you still need help, please contact **Customer Support** (page 19).

FCC Statement

This device complies with Part 15 of the FCC Rules. Operation is subject to the following two conditions:

- (1) This device may not cause harmful interference, and
- (2) This device must accept any interference received, including interference that may cause undesired operation.

Any changes or modifications not expressly approved by the party responsible for compliance could void the user's authority to operate this equipment.

This equipment has been tested and found to comply with the limits for a Class B digital device, pursuant to Part 15 of the FCC Rules. These limits are designed to provide reasonable protection against harmful interference in a residential installation. This equipment generates, uses and can radiate radio frequency energy and, if not installed and used in accordance with the instructions, may cause harmful interference to radio communications. However, there is no guarantee that interference will not occur in a particular installation. If this equipment does cause harmful interference to radio or television reception, which can be determined by turning the equipment off and on, the user is encouraged to try to correct the interference by one of the following measures:

- Reorient or relocate the receiving antenna.
- Connect the equipment into an outlet on a circuit different from that to which the receiver is connected.
- Increase the separation between the equipment and receiver.
- Consult the dealer or an experienced radio/TV technician for help.

FCC Radiation Exposure Statement

This equipment complies with FCC radiation exposure limits set forth for an uncontrolled environment. End users must follow the specific operating instructions for satisfying RF exposure compliance. To maintain compliance with FCC RF exposure compliance requirements, please follow operation instructions as documented in this manual. This transmitter must not be co-located or operating in conjunction with any other antenna or transmitter. This equipment should be installed and operated with a minimum distance of 20 cm between the radiator and your body. The availability of some specific channels and/or operational frequency bands are country dependent and are firmware programmed at the factory to match the intended destination. The firmware setting is not accessible by the end user.

Warranty Information

Product	Smart Fitness Scale
Model	ESF14
Default Warranty Period	1 year

For your own reference, we strongly recommend that you record your order ID and date of purchase.

Terms & Policy

Etekcitec warrants this product to the original purchaser to be free from defects in material and workmanship, under normal use and conditions, for a period of one year from the date of original purchase.

Etekcitec agrees, at our option during the warranty period, to repair any defect in material or workmanship or furnish an equal product in exchange without charge, subject to verification of the defect or malfunction and proof of the date of purchase.

There is no other express warranty. This warranty does not apply:

If the product has been modified from its original condition;

- If the product has been modified from its original condition;
- If the product has not been used in accordance with directions and instructions in the user manual;
- To damages or defects caused by accident, abuse, misuse or improper or inadequate maintenance;
- To damages or defects caused by service or repair of the product performed by an unauthorized service provider or by anyone other than Etekcitec;
- To damages or defects occurring during commercial use, rental use, or any use for which the product is not intended;
- To damages or defects exceeding the cost of the product.

Warranty Information (cont.)

Etekcitey will not be liable for indirect, incidental, or consequential damages in connection with the use of the product covered by this warranty.

This warranty extends only to the original consumer purchaser of the product and is not transferable to any subsequent owner of the product regardless of whether the product is transferred during the specified term of the warranty.

This warranty does not extend to products purchased from unauthorized sellers. Etekcitey's warranty extends only to products purchased from authorized sellers that are subject to Etekcitey's quality controls and have agreed to follow its quality controls.

All implied warranties are limited to the period of this limited warranty.

This warranty gives you specific legal rights and you may also have other rights which vary from state to state. Some states do not allow the exclusion or limitation of incidental or consequential damages, so the above limitation or exclusion may not apply to you.

If you discover that your product is defective within the specified warranty period, please contact Customer Support via support@etekcity.com. DO NOT dispose of your product before contacting us. Once our Customer Support Team has approved your request, please return the product with a copy of the invoice and order ID.

Extend Your Warranty by 1 Year

Register your product within 14 days of purchase at www.etekcity.com/warranty to extend your 1-year warranty by an additional year.

This warranty is made by:

Etekcitey Corporation
1202 N. Miller St. Suite A
Anaheim, CA 93806

Customer Support

If you encounter any issues or have any questions about your new product, please contact our helpful Customer Support Team.

Etekcitey Corporation

1202 N. Miller St., Suite A
Anaheim, CA 92806

Support Hours

Monday–Friday
9:00 am–5:00 pm PST/PDT

Email: support@etekcity.com

Toll-Free: (855) 686-3835

*Please have your invoice and order ID ready before contacting Customer Support.

Trademark Information

Google Play and Android are trademarks of Google LLC.

Apple App Store is a trademark of Apple Inc.

iOS® is a registered trademark of Cisco Systems, Inc. and/or its affiliates in the United States and certain other countries.

The Bluetooth® word mark and logos are registered trademarks owned by Bluetooth SIG, Inc. and any use of such marks by Etekcitey Corporation is under license.

Connect with us @Etekcity



