

APPLICATION CERTIFICATION
On Behalf of
Carewell Electric Technology (Zhongshan) Co., Ltd.

REMOTE CONTROL
Model No.: FAN61T-4SP1

FCC ID: 2AAZPFAN61T4SP1

Prepared for : Carewell Electric Technology (Zhongshan) Co., Ltd.
Address : Torch Development Zone, No.2, Ouya Road, Zhongshan,
Guangdong, China

Prepared by : ACCURATE TECHNOLOGY CO., LTD
Address : F1, Bldg. A, Changyuan New Material Port, Keyuan Rd.
Science & Industry Park, Nanshan, Shenzhen, Guangdong
P.R. China

Tel: (0755) 26503290
Fax: (0755) 26503396

Report Number : ATE20162255
Date of Test : Oct. 27, 2016-Nov. 24, 2016
Date of Report : Nov. 24, 2015

TABLE OF CONTENTS

Description	Page
Test Report Certification	
1. GENERAL INFORMATION	4
1.1. Description of Device (EUT).....	4
1.2. Description of Test Facility	5
1.3. Measurement Uncertainty	5
2. MEASURING DEVICE AND TEST EQUIPMENT	6
3. SUMMARY OF TEST RESULTS.....	7
4. THE FIELD STRENGTH OF RADIATION EMISSION	8
4.1. Block Diagram of Test Setup.....	8
4.2. The Field Strength of Radiation Emission Measurement Limits.....	9
4.3. Configuration of EUT on Measurement	10
4.4. Operating Condition of EUT	10
4.5. Test Procedure	10
4.6. The Field Strength of Radiation Emission Measurement Results	11
5. 20DB OCCUPIED BANDWIDTH	13
5.1. Block Diagram of Test Setup.....	13
5.2. The Bandwidth of Emission Limit According To FCC Part 15 Section 15.231(c).....	13
5.3. EUT Configuration on Measurement	13
5.4. Operating Condition of EUT	13
5.5. Test Procedure	14
5.6. Measurement Result	14
6. RELEASE TIME MEASUREMENT.....	15
6.1. Block Diagram of Test Setup.....	15
6.2. Release Time Measurement According To FCC Part 15 Section 15.231(a)	15
6.3. EUT Configuration on Measurement	15
6.4. Operating Condition of EUT	16
6.5. Test Procedure	16
6.6. Measurement Result	16
7. AVERAGE FACTOR MEASUREMENT	17
7.1. Block Diagram of Test Setup.....	17
7.2. Average factor Measurement according to ANSI C63.10-2013.....	17
7.3. EUT Configuration on Measurement	17
7.4. Operating Condition of EUT	18
7.5. Test Procedure	18
7.6. Measurement Result	18
8. ANTENNA REQUIREMENT.....	19
8.1. The Requirement	19
8.2. Antenna Construction	19

Test Report Certification

Applicant : Carewell Electric Technology (Zhongshan) Co., Ltd.
Manufacturer : Carewell Electric Technology (Zhongshan) Co., Ltd.
EUT Description : REMOTE CONTROL
(A) MODEL NO.: FAN61T-4SP1
(B) SERIAL NO.: N/A
(C) POWER SUPPLY: DC 3V (Battery)

Measurement Procedure Used:

FCC Rules and Regulations Part 15 Subpart C Section 15.231a ANSI C63.10-2013

The device described above is tested by ACCURATE TECHNOLOGY CO., LTD to determine the maximum emission levels emanating from the device. The maximum emission levels are compared to the FCC Part 15 Subpart C Section 15.231a. The measurement results are contained in this test report and ACCURATE TECHNOLOGY CO., LTD is assumed full responsibility for the accuracy and completeness of these measurements. Also, this report shows that the Equipment Under Test (EUT) is to be technically compliant with the FCC requirements.

This report applies to above tested sample only. This report shall not be reproduced in part without written approval of ACCURATE TECHNOLOGY CO., LTD.

Date of Test : Oct. 27, 2016-Nov. 24, 2016
Date of Report : Nov. 24, 2016

Prepared by : Tim Zhang
(Tim.zhang, Engineer)

Approved & Authorized Signer : Sean Liu
(Sean Liu, Manager)

1. GENERAL INFORMATION

1.1. Description of Device (EUT)

EUT	:	REMOTE CONTROL
Model Number	:	FAN61T-4SP1
Power Supply	:	DC 3V (powered by battery)
Modulation:	:	ASK
Operation Frequency	:	315MHz
Antenna type	:	PCB antenna
Antenna gain	:	0dBi
Applicant	:	Carewell Electric Technology (Zhongshan) Co., Ltd.
Address	:	Torch Development Zone, No.2, Ouya Road, Zhongshan, Guangdong, China
Manufacturer	:	Carewell Electric Technology (Zhongshan) Co., Ltd.
Address	:	Torch Development Zone, No.2, Ouya Road, Zhongshan, Guangdong, China
Date of sample received	:	Oct. 27, 2016
Date of Test	:	Oct. 27, 2016-Nov. 24, 2016

1.2. Description of Test Facility

EMC Lab : Accredited by TUV Rheinland Shenzhen

Listed by FCC
The Registration Number is 752051

Listed by Industry Canada
The Registration Number is 5077A-2

Accredited by China National Accreditation Committee
for Laboratories
The Certificate Registration Number is L3193

Name of Firm : ACCURATE TECHNOLOGY CO., LTD
Site Location : F1, Bldg. A, Changyuan New Material Port, Keyuan Rd.
Science & Industry Park, Nanshan, Shenzhen, Guangdong
P.R. China

1.3. Measurement Uncertainty

Conducted Emission Expanded Uncertainty = 2.23dB, k=2

Radiated emission expanded uncertainty = 3.08dB, k=2
(9kHz-30MHz)

Radiated emission expanded uncertainty = 4.42dB, k=2
(30MHz-1000MHz)

Radiated emission expanded uncertainty = 4.06dB, k=2
(Above 1GHz)

2. MEASURING DEVICE AND TEST EQUIPMENT

Table 1: List of Test and Measurement Equipment

Kind of equipment	Manufacturer	Type	S/N	Calibrated dates	Cal. Interval
EMI Test Receiver	Rohde&Schwarz	ESCS30	100307	Jan. 09, 2016	One Year
EMI Test Receiver	Rohde&Schwarz	ESPI3	101526/003	Jan. 09, 2016	One Year
Spectrum Analyzer	Agilent	E7405A	MY45115511	Jan. 09, 2016	One Year
Pre-Amplifier	Rohde&Schwarz	CBLU118354 0-01	3791	Jan. 09, 2016	One Year
Loop Antenna	Schwarzbeck	FMZB1516	1516131	Jan. 14, 2016	One Year
Bilog Antenna	Schwarzbeck	VULB9163	9163-323	Jan. 14, 2016	One Year
Horn Antenna	Schwarzbeck	BBHA9120D	9120D-655	Jan. 14, 2016	One Year
Horn Antenna	Schwarzbeck	BBHA9120D	9120D-1067	Jan. 14, 2016	One Year
LISN	Rohde&Schwarz	ESH3-Z5	100305	Jan. 09, 2016	One Year
LISN	Schwarzbeck	NSLK8126	8126431	Jan. 09, 2016	One Year
Highpass Filter	Wainwright Instruments	WHKX3.6/18 G-10SS	N/A	Jan. 09, 2016	One Year
Band Reject Filter	Wainwright Instruments	WRCG2400/2 485-2375/2510 -60/11SS	N/A	Jan. 09, 2016	One Year

3. SUMMARY OF TEST RESULTS

FCC Rules	Description of Test	Result
Section 15.207	Conducted Emission	N/A
Section 15.231(b)	Radiated Emission	Compliant
Section 15.231(c)	20dB Bandwidth	Compliant
Section 15.231(a)(1)	Release Time Measurement	Compliant
Section 15.203	Antenna Requirement	Compliant

The product is a manually operated transmitter.
Section 15.231 (a) (2), (3), (4) and (5) are not applicable.

Note: The power supply mode of the EUT is DC 3V, According to the FCC standard requirements, conducted emission is not applicable

All normal using modes of the normal function were tested but only the worst test data of the worst mode is recorded by this report.

4. THE FIELD STRENGTH OF RADIATION EMISSION

4.1. Block Diagram of Test Setup

4.1.1. Block diagram of connection between the EUT and simulators



(EUT: REMOTE CONTROL)

4.1.2. Semi-Anechoic Chamber Test Setup Diagram

(A) Radiated Emission Test Set-Up, Frequency below 30MHz

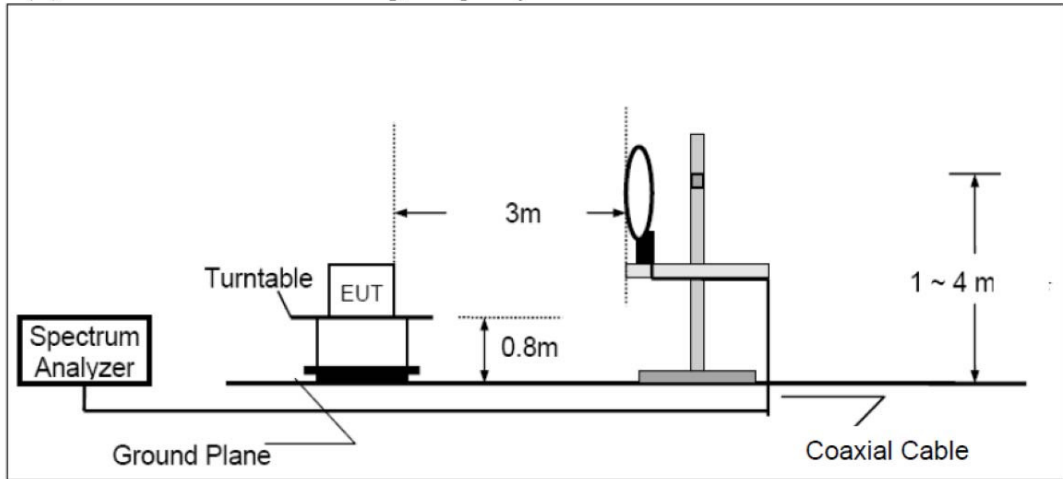

(B) Radiated Emission Test Set-Up, Frequency 30-1000MHz

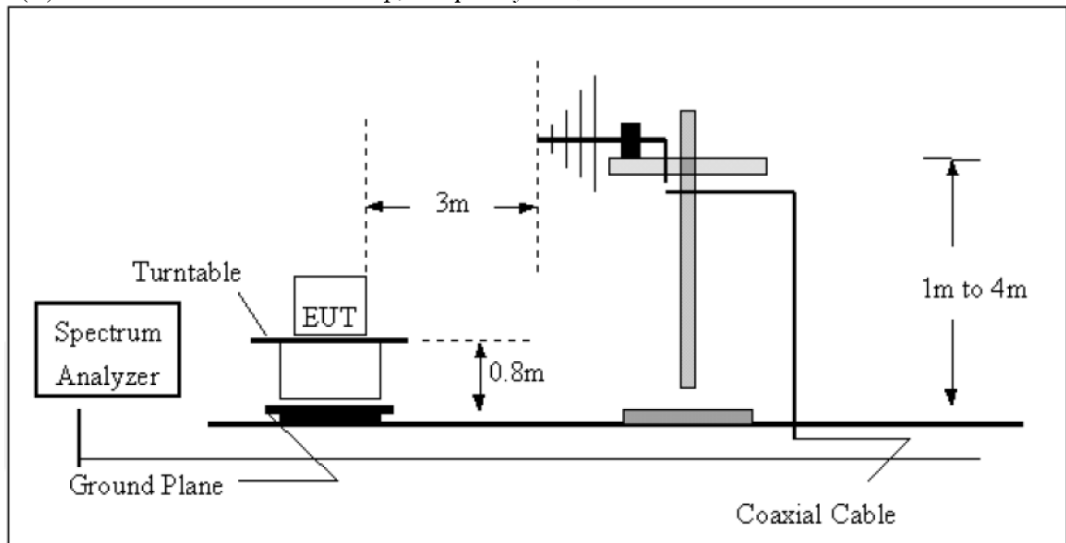

(C) Radiated Emission Test Set-Up, Frequency above 1GHz

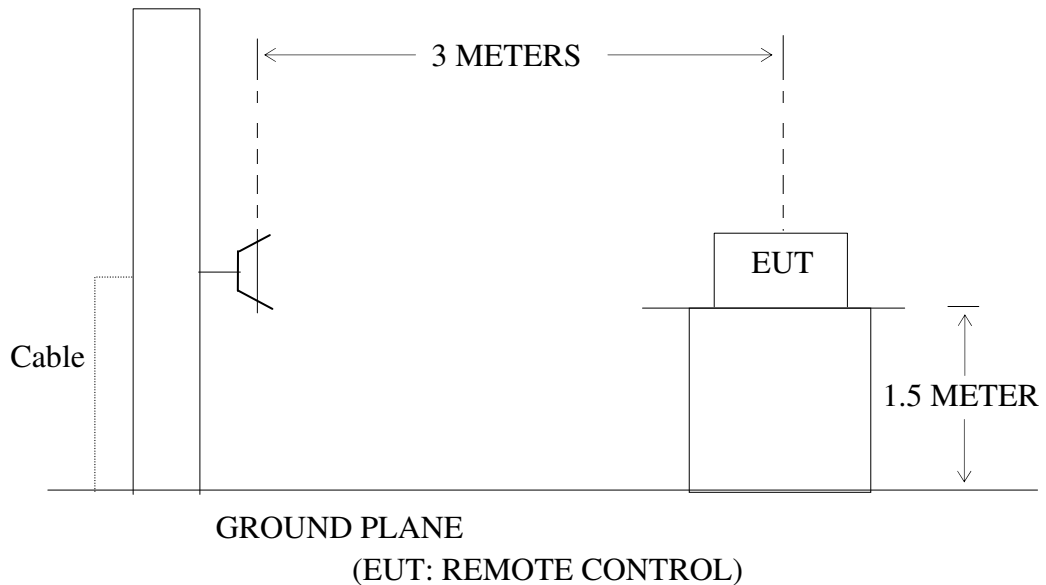

4.2. The Field Strength of Radiation Emission Measurement Limits

4.2.1. Radiation Emission Measurement Limits According to FCC Part 15 Section 15.231(b)

Frequency Range of Fundamental [MHz]	Field Strength of Fundamental Emission [Average] [$\mu\text{V}/\text{m}$]	Field Strength of Spurious Emission [Average] [$\mu\text{V}/\text{m}$]
40.66-40.70	2250	225
70-130	1250	125
130-174	1250-3750	125-375
174-260	3750	375
260-470	3750-12500	375-1250
Above 470	12500	1250

Where F is the frequency in MHz, the formulas for calculating the maximum permitted fundamental field strengths are as follows: for the band 130-174 MHz, $\mu\text{V}/\text{m}$ at 3 meters = $56.81818(F) - 6136.3636$; for the band 260-470 MHz, $\mu\text{V}/\text{m}$ at 3 meters = $41.6667(F) - 7083.3333$. The maximum permitted unwanted emission level is 20 dB below the maximum permitted fundamental level.

4.2.2. Restricted Band Radiation Emission Measurement Limits According to FCC part 15 Section 15.205 and Section 15.209.

4.3. Configuration of EUT on Measurement

The following equipment is installed on Radiated Emission Measurement to meet the commission requirements and operating regulations in a manner which tends to maximize its emission characteristics in normal application.

4.3.1. REMOTE CONTROL (EUT)

Model Number : FAN61T-4SP1
Serial Number : N/A
Manufacturer : Carewell Electric Technology (Zhongshan) Co., Ltd.

4.4. Operating Condition of EUT

4.4.1. Setup the EUT and simulator as shown as Section 4.1.

4.4.2. Turn on the power of all equipment.

4.4.3. Let the EUT work in TX mode measure it.

4.5. Test Procedure

The EUT and its simulators are placed on a turntable, which is 0.8 meter high above ground (Below 1GHz). The EUT and its simulators are placed on a turntable, which is 1.5 meter high above ground (Above 1GHz). The turntable can rotate 360 degrees to determine the position of the maximum emission level. EUT is set 3.0 meters away from the receiving antenna, which is mounted on an antenna tower. The antenna can be moved up and down between 1.0 meter and 4 meters to find out the maximum emission level. Broadband antenna (calibrated bi-log antenna) is used as receiving antenna. Both horizontal and vertical polarizations of the antenna are set on measurement. In order to find the maximum emission levels, all of the EUT location must be manipulated according to ANSI C63.10:2013 on radiated emission measurement. The EUT was tested in 3 orthogonal planes.

The bandwidth of test receiver is set at 120 kHz in 30-1000 MHz, and 1 MHz in 1000-4000 MHz.

The frequency range from 30 MHz to 4000 MHz is checked.

4.6. The Field Strength of Radiation Emission Measurement Results

PASS.

Note: The radiation emissions from 9KHz-30MHz are not reported, because the test values lower than the limits of 20dB.

EUT:	<u>REMOTE CONTROL</u>		
Model No.:	<u>FAN61T-4SP1</u>	Power Supply:	<u>DC 3V</u>
Test Mode:	<u>TX</u>	Test Engineer:	<u>Star</u>

Frequency (MHz)	Reading (dBμV/m)	Factor Corr. (dB)	Average Factor (dB)	Result(dBμV/m)		Limit(dBμV/m)		Margin(dB)		Polarization
	PEAK			AV	PEAK	AV	AV	PEAK		
315.06	92.72	-16.05	-7.03	69.64	76.67	75.62	95.62	-5.92	-18.95	Horizontal
630.12	64.21	-9.21	-7.03	47.97	55.00	55.62	75.62	-7.65	-20.62	
945.18	53.72	-3.56	-7.03	43.13	50.16	55.62	75.62	-12.49	-25.46	
1260.25	45.67	-5.83	-7.03	32.81	39.84	55.62	75.62	-22.81	-35.78	
1890.65	39.94	-3.70	-7.03	29.21	36.24	55.62	75.62	-26.41	-39.38	
315.06	78.22	-16.05	-7.03	55.14	62.17	75.62	95.62	-20.48	-33.45	Vertical
630.12	63.68	-9.21	-7.03	47.44	54.47	55.62	75.62	-8.18	-21.15	
945.18	51.09	-3.56	-7.03	40.50	47.53	55.62	75.62	-15.12	-28.09	
1260.25	40.11	-5.83	-7.03	27.25	34.24	55.62	75.62	-28.37	-41.34	
1890.65	35.93	-3.70	-7.03	25.20	32.23	55.62	75.62	-30.42	-43.39	

Note:

1. Emissions attenuated more than 20 dB below the permissible value are not reported.
2. The field strength is calculated by adding the antenna factor, high pass filter loss(if used) and cable loss, and subtracting the amplifier gain(if any)from the measured reading. The basic equation calculation is as follows:
Result = Reading + Corrected Factor
Where Corrected Factor = Antenna Factor + Cable Loss + High Pass Filter Loss – Amplifier Gain
3. FCC Limit for Average Measurement = $41.6667(315)-7083.3333 = 6041.6772 \mu\text{V/m} = 75.62 \mu\text{V/m}$
4. The spectral diagrams in appendix I display the measurement of peak values.
5. Average value= PK value + Average Factor (duty factor)
6. If the peak-detected amplitude can be shown to comply with the average limit, then it is not necessary to perform a separate average measurement.
7. The EUT is tested radiation emission in three axes(X,Y,Z). The worst emissions are reported in three axes.

8. Pulse Desensitization Correction Factor

Pulse Width (PW) = 0.38ms

$2/PW = 2/0.38\text{ms} = 5.26\text{kHz}$

RBW (100 kHz) > 2/PW (5.26 kHz)

Therefore PDCF is not needed

5. 20DB OCCUPIED BANDWIDTH

5.1. Block Diagram of Test Setup

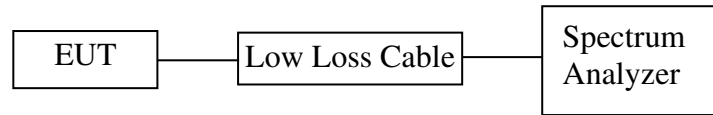

(EUT: REMOTE CONTROL)

5.2. The Bandwidth of Emission Limit According To FCC Part 15 Section

15.231(c)

The bandwidth of emission shall be no wider than 0.25% of the center frequency. Therefore, the bandwidth of the emission limit is $315 \text{ MHz} \times 0.25\% = 787.5 \text{ kHz}$. Bandwidth is determined at the two points 20 dB down from the top of modulated carrier.

5.3. EUT Configuration on Measurement

The following equipment are installed on the bandwidth of emission Measurement to meet the commission requirements and operating regulations in a manner which tends to maximize its emission characteristics in normal application.

5.3.1. REMOTE CONTROL (EUT)

Model Number : FAN61T-4SP1
Serial Number : N/A
Manufacturer : Carewell Electric Technology (Zhongshan) Co., Ltd.

5.4. Operating Condition of EUT

5.4.1. Setup the EUT and simulator as shown as Section 5.1.

5.4.2. Turn on the power of all equipment.

5.4.3. Let the EUT work in TX mode measure it.

5.5. Test Procedure

5.5.1. Set SPA Center Frequency = Fundamental frequency, RBW = 10 kHz, VBW = 30 kHz, Span = 1MHz.

5.5.2. Set SPA Max hold, Mark peak, -20 dB.

5.6. Measurement Result

The EUT does meet the FCC requirement.

-20 dB bandwidth = 60 kHz < 787.5 kHz.

The spectral diagrams in appendix I.

6. RELEASE TIME MEASUREMENT

6.1. Block Diagram of Test Setup



(EUT: REMOTE CONTROL)

6.2. Release Time Measurement According To FCC Part 15 Section 15.231(a)

Section 15.231(a) (1) A manually operated transmitter shall employ a switch that will automatically deactivate the transmitter within not more than 5 seconds of being released.

6.3. EUT Configuration on Measurement

The following equipment are installed on Release Time Measurement to meet the commission requirements and operating regulations in a manner which tends to maximize its emission characteristics in normal application.

6.3.1. REMOTE CONTROL (EUT)

Model Number : FAN61T-4SP1
Serial Number : N/A
Manufacturer : Carewell Electric Technology (Zhongshan) Co., Ltd.

6.4. Operating Condition of EUT

6.4.1. Setup the EUT and simulator as shown as Section 6.1.

6.4.2. Turn on the power of all equipment.

6.4.3. Let the EUT work in TX mode measure it.

6.5. Test Procedure

6.5.1. Set SPA Center Frequency = Fundamental frequency, RBW = 100 kHz, VBW = 300 kHz, Span = 0 Hz. Sweep time = 10 s.

6.5.2. Set EUT as normal operation and press Transmitter button.

6.5.3. Set SPA View. Delta Mark time.

6.6. Measurement Result

The release time less than 5 seconds.

Release Time = 3.18s

The spectral diagrams in appendix I.

7. AVERAGE FACTOR MEASUREMENT

7.1. Block Diagram of Test Setup

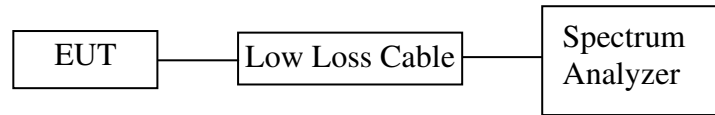

(EUT: REMOTE CONTROL)

7.2. Average factor Measurement according to ANSI C63.10-2013

ANSI C63.10-2013 Section 7.5 Unless otherwise specified, when the radiated emission limits are expressed in terms of the average value of the emission, and pulsed operation is employed, the measurement field strength shall be determined by averaging over one complete pulse train, including blanking intervals, as long as the pulse train does not exceed 0.1 s (100 ms). In cases where the pulse train exceeds 0.1 s, the measured field strength shall be determined during a 0.1 s interval.⁶⁴ The following procedure is an example of how the average value may be determined. The average field strength may be found by measuring the peak pulse amplitude (in log equivalent units) and determining the duty cycle correction factor (in dB) associated with the pulse modulation as shown in Equation (10):

Average factor in dB = 20 log (duty cycle)

7.3. EUT Configuration on Measurement

The following equipment are installed on average factor Measurement to meet the commission requirements and operating regulations in a manner which tends to maximize its emission characteristics in normal application.

7.3.1. REMOTE CONTROL

Model Number : FAN61T-4SP1
Serial Number : N/A
Manufacturer : Carewell Electric Technology (Zhongshan) Co., Ltd.

7.4. Operating Condition of EUT

7.4.1. Setup the EUT and simulator as shown as Section 7.1.

7.4.2. Turn on the power of all equipment.

7.4.3. Let the EUT work in TX mode measure it.

7.5. Test Procedure

7.5.1. The time period over which the duty cycle is measured is 100 milliseconds, or the repetition cycle, whichever is a shorter time frame. The worst case (highest percentage on) duty cycle is used for the calculation.

7.5.2. Set SPA Center Frequency = Fundamental frequency, RBW = 100 kHz, VBW = 300 kHz, Span = 0 Hz.

7.5.3. Set EUT as normal operation.

7.5.4. Set SPA View. Delta Mark time.

7.6. Measurement Result

The duty cycle is simply the on time divided by the period:

The duration of one cycle = 34.3ms

Effective period of the cycle = $(0.68 \times 18) + (0.38 \times 8)$ ms = 15.28 ms

DC = $15.28\text{ms} / 34.3\text{ms} = 0.445$

Therefore, the average factor is found by $20\log 0.445 = -7.03\text{dB}$

The spectral diagrams in appendix I.

8. ANTENNA REQUIREMENT

8.1.The Requirement

According to Section 15.203, an intentional radiator shall be designed to ensure that no antenna other than that furnished by the responsible party shall be used with the device.

8.2.Antenna Construction

Device is equipped with permanent attached antenna, which isn't displaced by other antenna. The Antenna gain of EUT is 0dBi. Therefore, the equipment complies with the antenna requirement of Section 15.203.

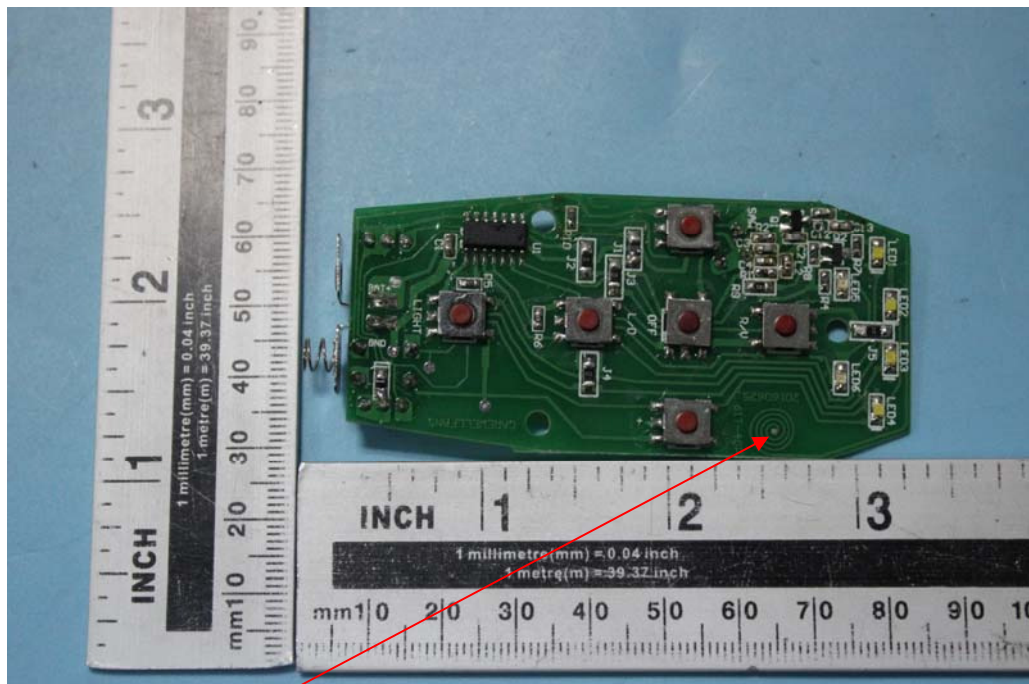

Antenna

APPENDIX I (Test Curves)



ACCURATE TECHNOLOGY CO., LTD.

F1,Bldg,A,Changyuan New Material Port Keyuan Rd,
Science & Industry Park,Nanshan Shenzhen,P.R.China

Site: 1# Chamber
Tel:+86-0755-26503290
Fax:+86-0755-26503396

Job No.: DING #2828
Standard: FCC 15.231a 3M Radiated
Test item: Radiation Test
Temp.(C)/Hum.(%) 25 C / 55 %
EUT: REMOTE CONTROL
Mode: TX 315MHz
Model: FAN61T-4SP1
Manufacturer: CAREWELL

Polarization: Horizontal
Power Source: DC 3V
Date: 16/11/10/
Time: 8/56/39
Engineer Signature: DING
Distance: 3m

Note: Report NO.:ATE20162255

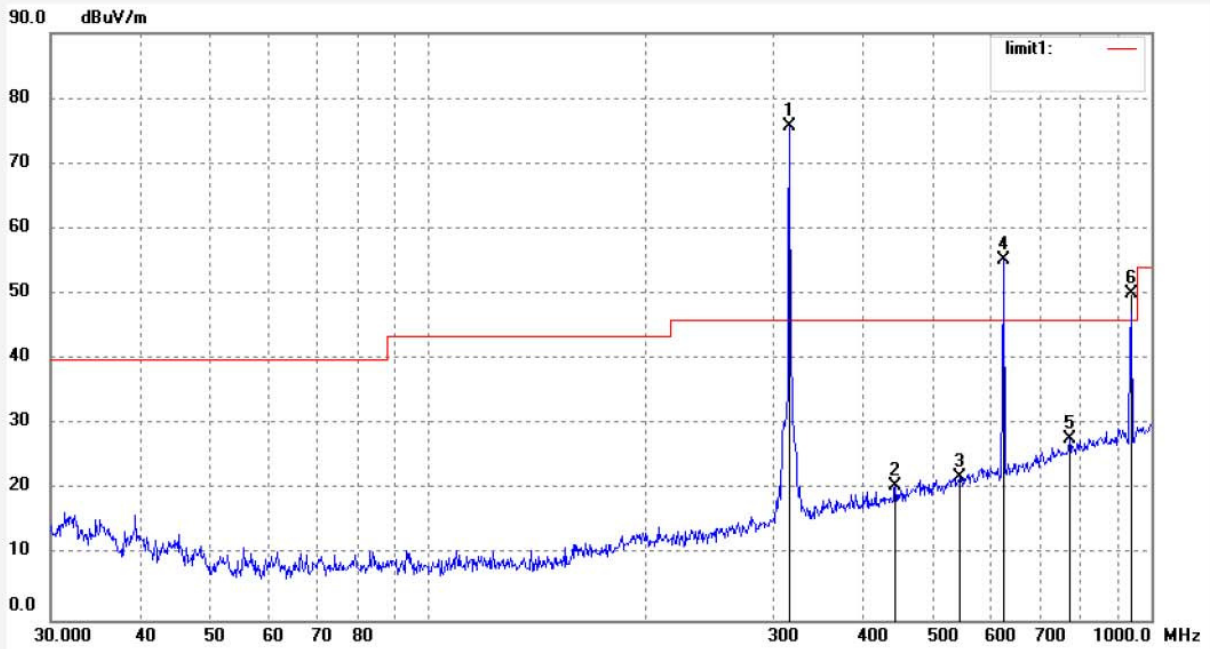

No.	Freq. (MHz)	Reading (dBuV/m)	Factor (dB)	Result (dBuV/m)	Limit (dBuV/m)	Margin (dB)	Detector	Height (cm)	Degree (deg.)	Remark
1	315.0601	92.72	-16.05	76.67			peak			
2	442.5722	32.77	-12.07	20.70	46.00	-25.30	QP			
3	544.5202	31.71	-9.83	21.88	46.00	-24.12	QP			
4	630.1205	64.21	-9.21	55.00			peak			
5	771.0475	32.52	-4.73	27.79	46.00	-18.21	QP			
6	945.1839	53.72	-3.56	50.16			peak			



ACCURATE TECHNOLOGY CO., LTD.

F1,Bldg,A,Changyuan New Material Port Keyuan Rd,
Science & Industry Park,Nanshan Shenzhen,P.R.China

Site: 1# Chamber
Tel:+86-0755-26503290
Fax:+86-0755-26503396

Job No.: DING #2829	Polarization: Vertical
Standard: FCC 15.231a 3M Radiated	Power Source: DC 3V
Test item: Radiation Test	Date: 16/11/10/
Temp.(C)/Hum.(%) 25 C / 55 %	Time: 8/58/01
EUT: REMOTE CONTROL	Engineer Signature: DING
Mode: TX 315MHz	Distance: 3m
Model: FAN61T-4SP1	
Manufacturer: CAREWELL	

Note: Report NO.:ATE20162255

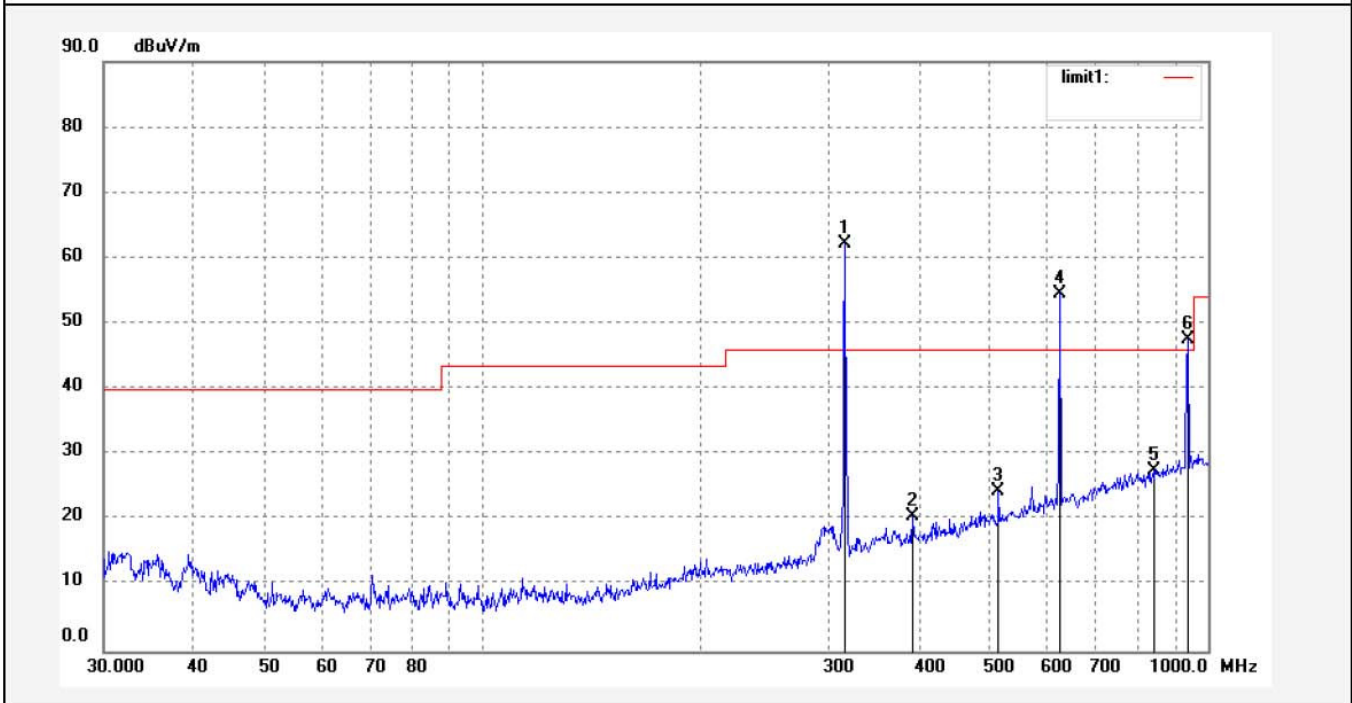

No.	Freq. (MHz)	Reading (dBuV/m)	Factor (dB)	Result (dBuV/m)	Limit (dBuV/m)	Margin (dB)	Detector	Height (cm)	Degree (deg.)	Remark
1	315.0601	78.22	-16.05	62.17			peak			
2	391.3601	33.62	-13.12	20.50	46.00	-25.50	QP			
3	514.7533	34.89	-10.55	24.34	46.00	-21.66	QP			
4	630.1205	63.68	-9.21	54.47			peak			
5	844.8028	30.94	-3.33	27.61	46.00	-18.39	QP			
6	945.1839	51.09	-3.56	47.53			peak			



ACCURATE TECHNOLOGY CO., LTD.

F1,Bldg,A,Changyuan New Material Port Keyuan Rd,
Science & Industry Park,Nanshan Shenzhen,P.R.China

Site: 1# Chamber
Tel:+86-0755-26503290
Fax:+86-0755-26503396

Job No.: DING #2831	Polarization: Horizontal
Standard: FCC 15.231a 3M Radiated	Power Source: DC 3V
Test item: Radiation Test	Date: 16/11/10/
Temp.(C)/Hum.(%) 25 C / 55 %	Time: 9/04/11
EUT: REMOTE CONTROL	Engineer Signature: DING
Mode: TX 315MHz	Distance: 3m
Model: FAN61T-4SP1	
Manufacturer: CAREWELL	

Note: Report NO.:ATE20162255

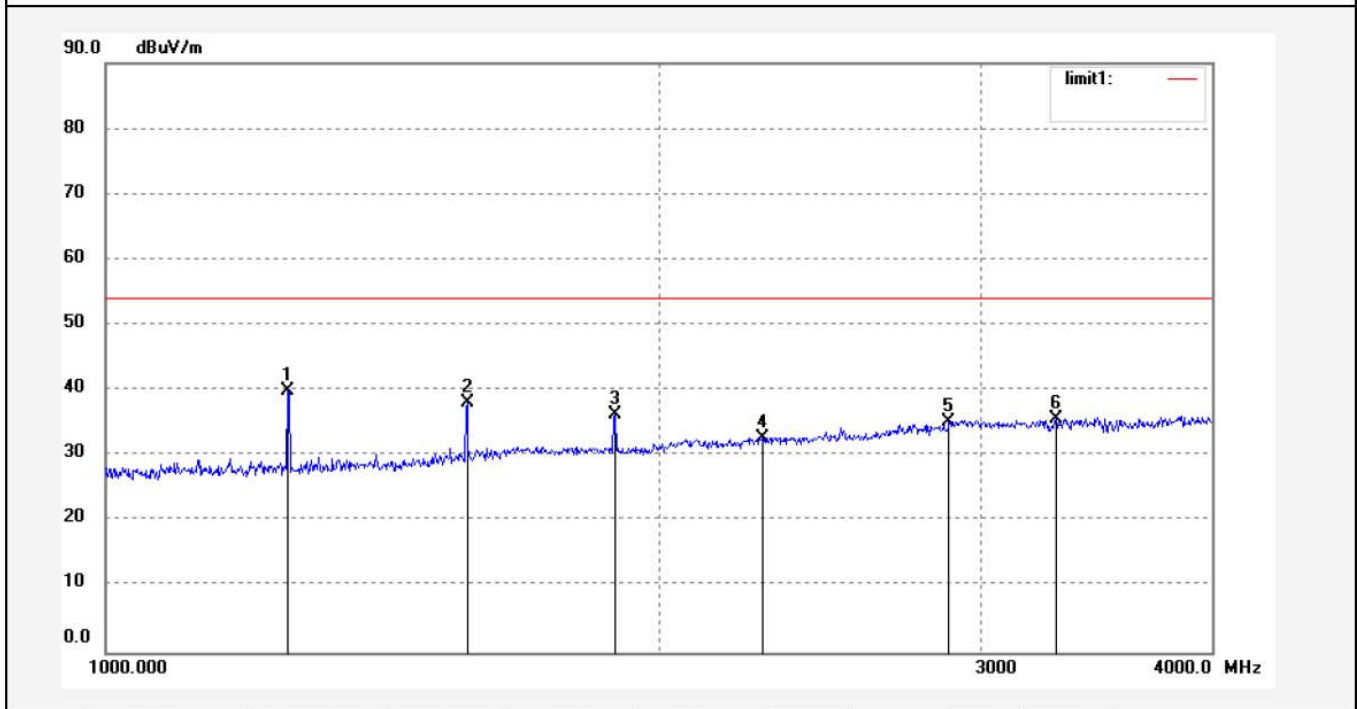

No.	Freq. (MHz)	Reading (dBuV/m)	Factor (dB)	Result (dBuV/m)	Limit (dBuV/m)	Margin (dB)	Detector	Height (cm)	Degree (deg.)	Remark
1	1260.250	45.67	-5.83	39.84			peak			
2	1575.441	42.91	-4.83	38.08			peak			
3	1890.646	39.94	-3.70	36.28			peak			
4	2276.982	34.35	-1.51	32.84	74.00	-41.16	peak			
5	2835.350	33.22	2.09	35.31			peak			
6	3290.507	31.24	4.52	35.76	74.00	-38.24	peak			



ACCURATE TECHNOLOGY CO., LTD.

F1,Bldg,A,Changyuan New Material Port Keyuan Rd,
Science & Industry Park,Nanshan Shenzhen,P.R.China

Site: 1# Chamber
Tel:+86-0755-26503290
Fax:+86-0755-26503396

Job No.: DING #2830	Polarization: Vertical
Standard: FCC 15.231a 3M Radiated	Power Source: DC 3V
Test item: Radiation Test	Date: 16/11/10/
Temp.(C)/Hum.(%) 25 C / 55 %	Time: 9/00/46
EUT: REMOTE CONTROL	Engineer Signature: DING
Mode: TX 315MHz	Distance: 3m
Model: FAN61T-4SP1	
Manufacturer: CAREWELL	

Note: Report NO.:ATE20162255

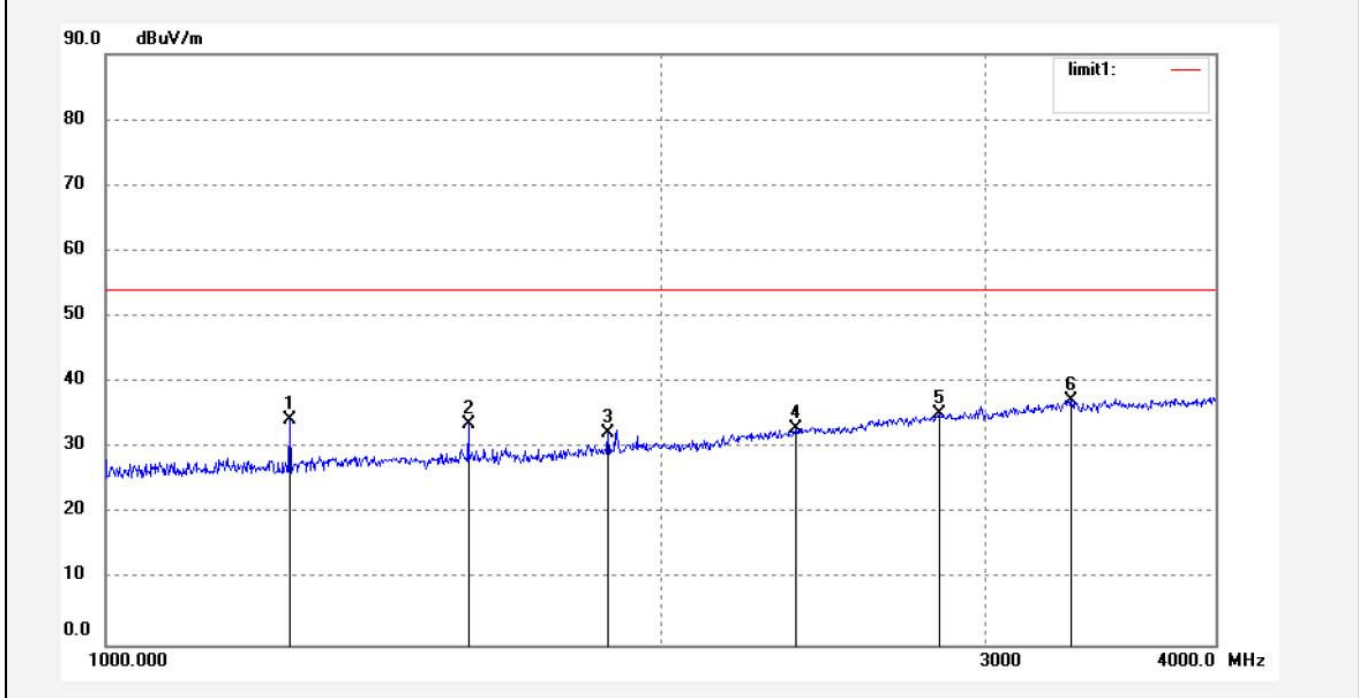

No.	Freq. (MHz)	Reading (dBuV/m)	Factor (dB)	Result (dBuV/m)	Limit (dBuV/m)	Margin (dB)	Detector	Height (cm)	Degree (deg.)	Remark
1	1260.250	40.11	-5.83	34.28			peak			
2	1575.441	38.41	-4.83	33.58			peak			
3	1890.646	35.93	-3.70	32.23			peak			
4	2367.658	34.30	-1.29	33.01	74.00	-40.99	peak			
5	2835.350	37.29	2.09	35.20			peak			
6	3341.377	42.00	4.68	37.32	74.00	-36.68	peak			

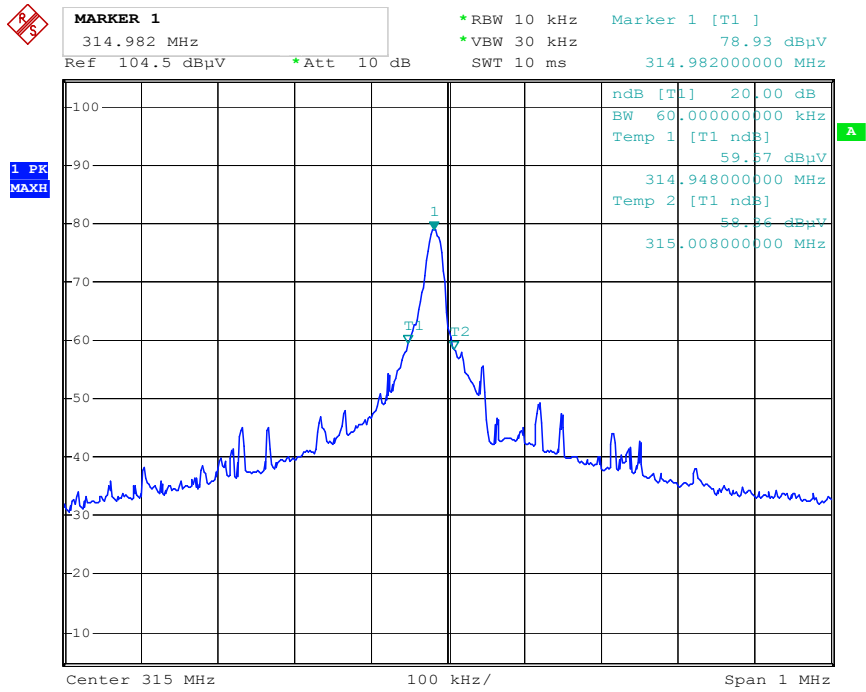

Date: 24.NOV.2016 17:39:51

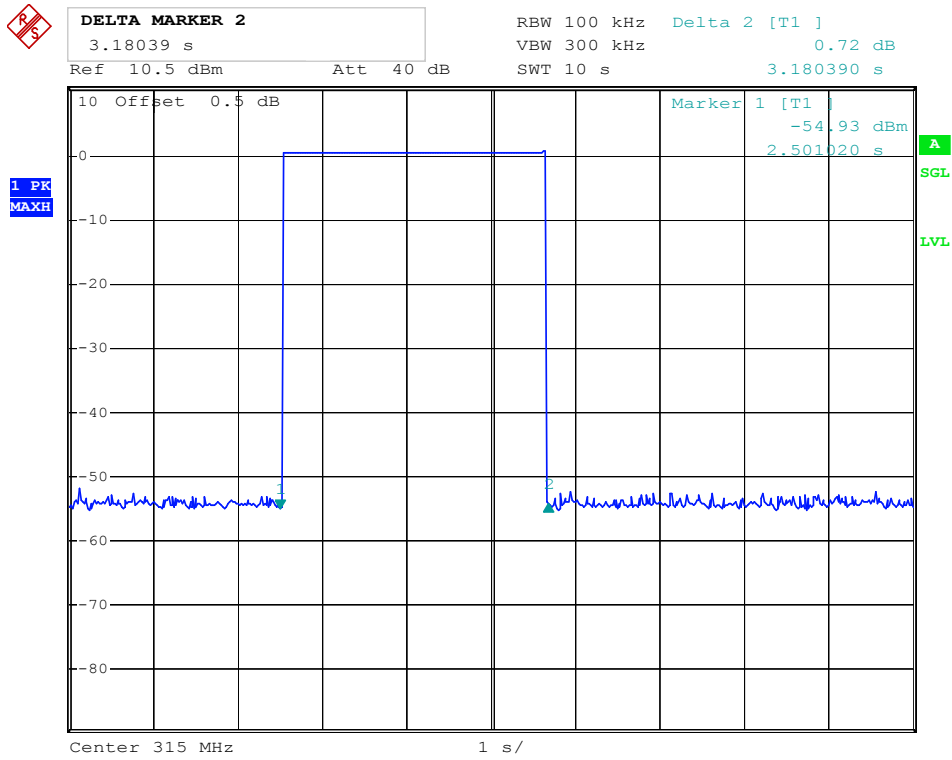

Date: 07.Nov.2015 10:53:43

Release Time = 3.18s

The graph shows the pattern of coding during the signal transmission.
The duration of one cycle = 34.3 ms.

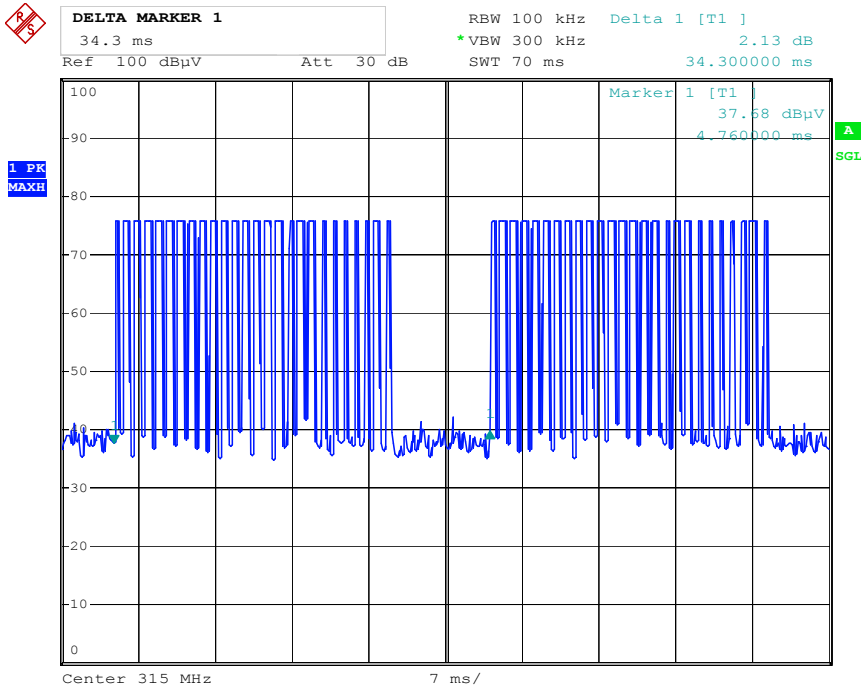

Date: 24.NOV.2016 17:45:23

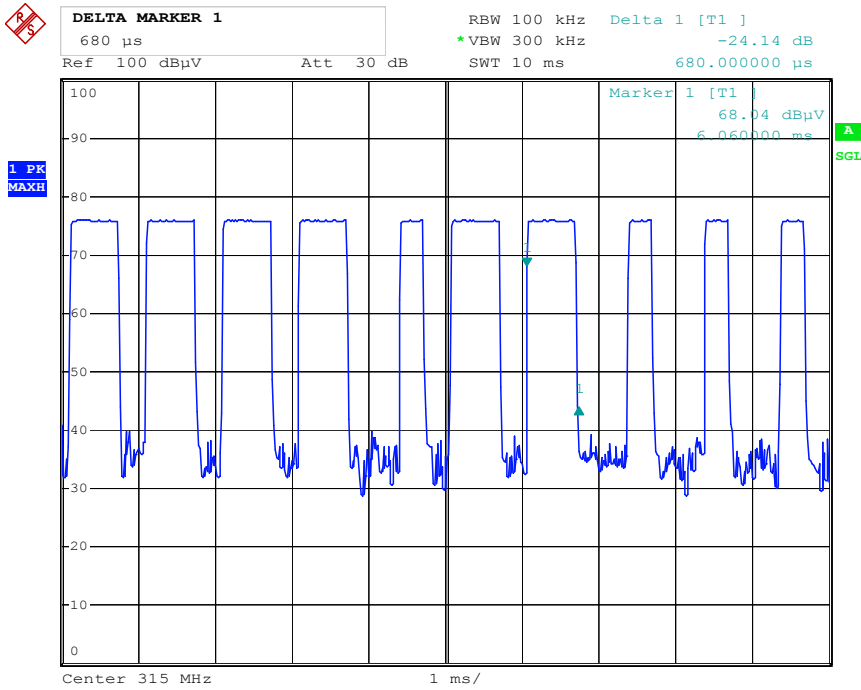

Date: 24.NOV.2016 17:47:55

The graph shows the duration of 'on' signal. From marker 1 to marker 2, duration is 0.68ms.

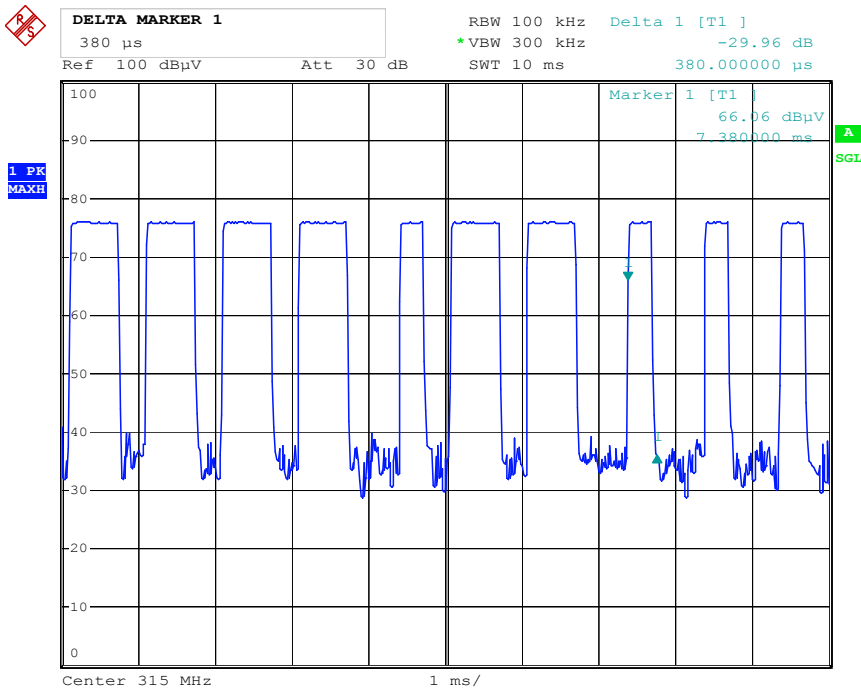

Date: 24.NOV.2016 17:48:21

The graph shows the duration of 'on' signal. From marker 1 to marker 2, duration is 0.38ms.