



FCC RADIO TEST REPORT

Applicant : Protop International Inc.

Address : 10F-8, No.237, Sec.,1, Datong Rd., Xizhi Dist., 22161New Taipei City,
Taiwan

Equipment : OTTERBOX 3-in-1 Charging Station

Model No. : OBFTC-0092-A, 78-80598, 78-80599, 78-80533, 78-80565

Trademark : OTTERBOX

FCC ID : 2AAYX0092A

I HEREBY CERTIFY THAT :

The sample was received on Aug. 12, 2021 and the test items were conducted during Sept. 06, 2021 at CerpPASS Technology Corp. The test result refers exclusively to the test presented test model / sample. Without written approval of CerpPASS Technology Corp., the test report shall not be reproduced except in full.

Approved by:

Leevin Li / Supervisor



Contents

1. Report of Measurements and Examinations	4
1.1 List of Measurements and Examinations	4
2. Test Configuration of Equipment under Test	5
2.1 Feature of Equipment under Test	5
2.2 Description of the test mode	6
2.3 Description of Test System	7
2.4 General Information of Test	8
2.5 Measurement Uncertainty	8
3. Test Equipment and Ancillaries Used for Tests	9
4. Antenna Requirements	10
4.1 Standard Applicable	10
4.2 Antenna Construction	10
4.3 Result	10
5. Test of Conducted Emission	11
5.1 Test Limit	11
5.2 Test Procedures	11
5.3 Typical Test Setup	12
5.4 Test Result and Data	13
6. Test of Radiated Emission	15
6.1 Test Limit	15
6.2 Test Procedures	16
6.3 Typical Test Setup	17
6.4 Test Result and Data	18
7. 20dB Bandwidth	24
7.1 Test Limit	24
7.2 Test Procedures	24
7.3 Typical Test Setup	24
7.4 Test Result and Data	25



History of this test report

Original.

Additional attachment as following record:

Attachment No.	Issue Date	Description
DEFC2107126	Sept. 06, 2021	Initial Issue



1. Report of Measurements and Examinations

1.1 List of Measurements and Examinations

FCC CFR Title 47 Part 15 Subpart C Section 15.209

FCC Rule	Description of Test	Result
§ 15.203	. Antenna Requirement	Pass
§ 15.207(a)	. Conducted Emission	Pass
§ 15.209(a)	. Radiated Emission	Pass
§ 15.215	20dB Bandwidth	Pass

Note: Deviations Yes No
*The lab has reduced the uncertainty risk factor from test equipment, environment and staff technicians which according to the standard on contract. Therefore, the test result will only be determined by standard requirement.



2. Test Configuration of Equipment under Test

2.1 Feature of Equipment under Test

Product	OTTERBOX 3-in-1 Charging Station
Test Model	OBFTC-0092-A, 78-80598, 78-80599, 78-80533, 78-80565
Model Discrepancy	All models are identical to each other except for model name. The tested model: OBFTC-0092-A
Frequency Range	111KHz~147KHz
Antenna Type	Coil antenna
Modulation Type	ASK
Power Rating	Input:5V $\overline{\text{---}}$ 3A /9V $\overline{\text{---}}$ 3A/ 12V $\overline{\text{---}}$ 3A Input power: 36W Max Output Wireless 1:15W(Max) Output Wireless 2:5W(Max) Output USB A: 5V $\overline{\text{---}}$ 1A 5W (Max)
Temperature	Operating Temp:0°C~+35°C Storage Temp:-20°C~+70°C

Note: For more details, please refer to the User's manual of the EUT.



2.2 Description of the test mode

To investigate the maximum EMI emission characteristics generates from EUT, the test system was pre-scanning tested base on the consideration of following EUT operation mode or test configuration mode which possible have effect on EMI emission level. Each of these EUT operation mode(s) or test configuration mode(s) mentioned above was evaluated respectively.

The EUT was tested under the following modes, the worst mode was recorded in this report.

Pre-tested Mode:	Description
Mode 1	Wireless1 Charging for 0W+Wireless2 Charging for 0W for AC120V
Mode 2	Wireless1 Charging for 5W+Wireless2 Charging for 5W for AC120V
Mode 3	Wireless1 Charging for 7.5W+Wireless2 Charging for 5W for AC120V
Mode 4	Wireless1 Charging for 10W+Wireless2 Charging for 5W for AC120V
Mode 5	Wireless1 Charging for 15W+Wireless2 Charging for 5W for AC120V
Mode 6	Wireless1 Charging for 15W+Wireless2 Charging for 5W for AC240V
For Conducted Emission	
Final test Mode	Description
Mode 5	Wireless1 Charging for 15W+Wireless2 Charging for 5W for AC120V
For Radiated Emission	
Final test Mode	Description
Mode 5	Wireless1 Charging for 15W+Wireless2 Charging for 5W for AC120V

Note: The EUT Have two coils, the specific location is shown below:

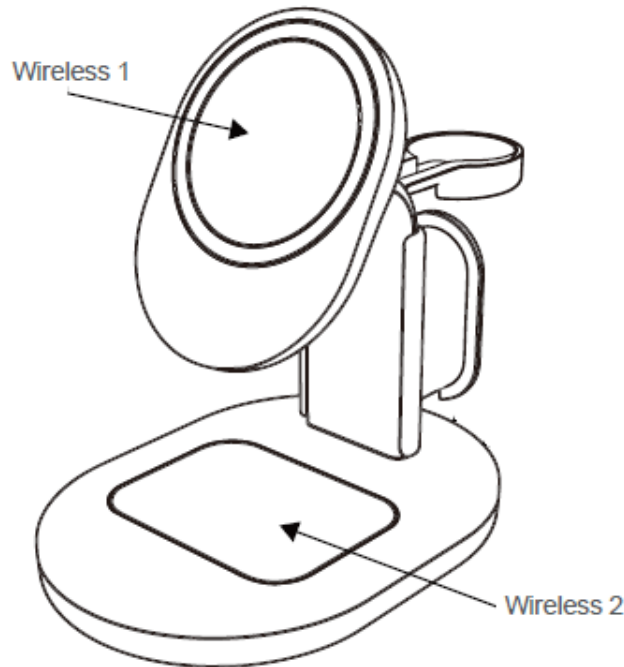



2.3 Description of Test System

Product	Manufacturer	Model No.	Serial No.	Power Cord
1 Adapter	Protop	OBFTC-0067-A	N/A	N/A
2 Wireless Load 1	N/A	N/A	N/A	N/A
3 Wireless Load 2	N/A	N/A	N/A	N/A

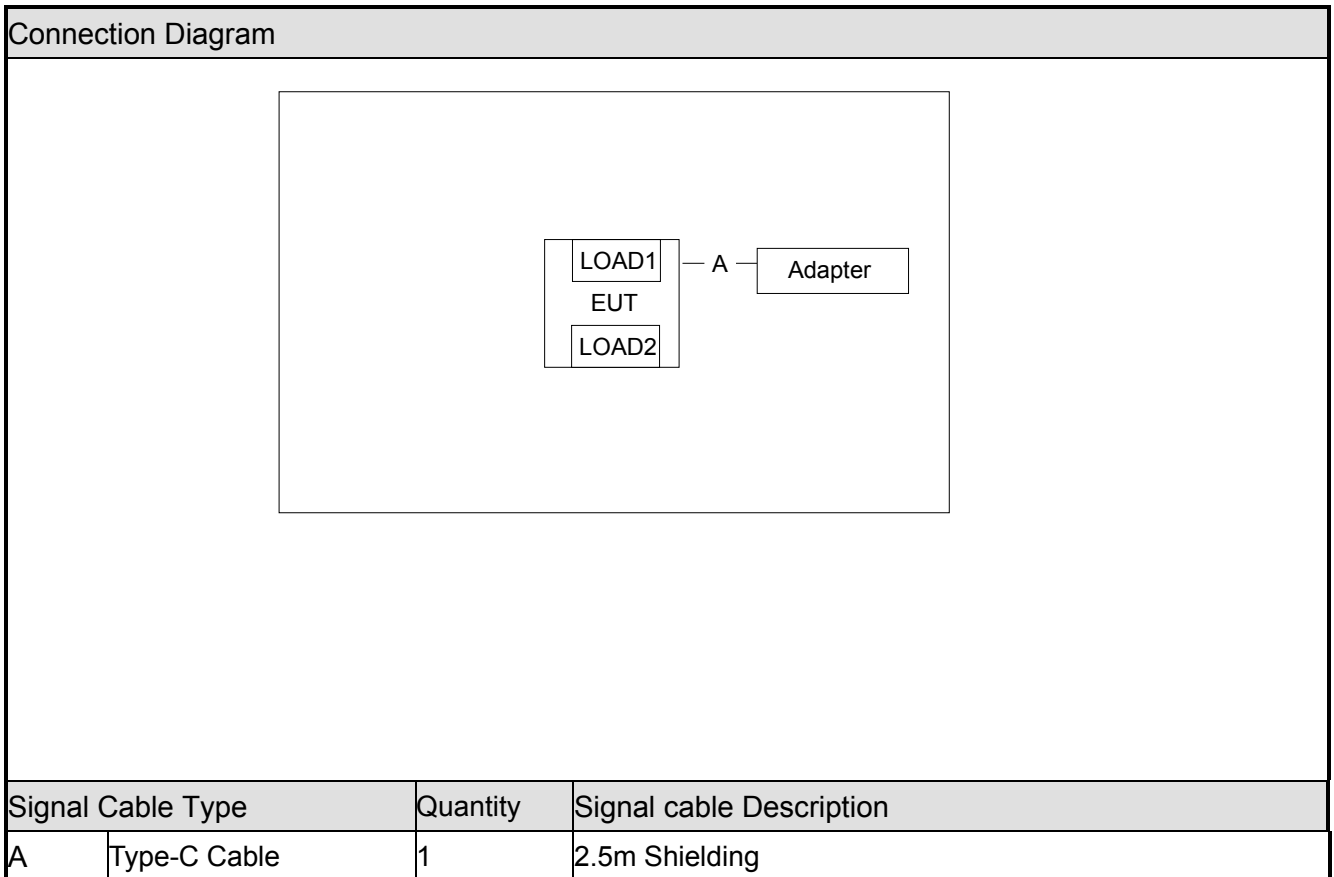



2.4 General Information of Test

Test Site	CerpPASS Technology Corporation(CerpPASS Laboratory) Address: Room 102, No. 5, Xing'an Road, Chang'an Town, Dongguan City, Guangdong Province Tel: +86-769-8547-1212 Fax: +86-769-8547-1912
FCC Designation No.:	CN1288
Frequency Range Investigated:	Conducted: from 150kHz to 30 MHz Radiation: from 30 MHz to 40,000MHz
Test Distance:	9KHz~30MHz: radiated emission from antenna to EUT is 1 M. 30MHz~1GHz: radiated emission from antenna to EUT is 3 M.

Test Item	Test Site	Test period	Environmental Conditions	Tested By
Radiated Emissions	3M02-DG	2021/08/05~2021/08/19	22~25°C / 50~60%	Amos Zhang
AC Power Line Conducted Emission	CON01-DG	2021/08/05~2021/08/19	22~25°C / 50~60%	Amos Zhang

2.5 Measurement Uncertainty

Conducted Emission	
The measurement uncertainty is evaluated as ± 2.88 dB.	
Radiated Emission	
(9KHz -30MHz)	The measurement uncertainty is evaluated as ± 2.15 dB.
(30MHz -200MHz)	The measurement uncertainty is evaluated as ± 3.90 dB.
(200M-1000M)	The measurement uncertainty is evaluated as ± 4.95 dB.
(1000M-6000M)	The measurement uncertainty is evaluated as ± 3.24 dB.
(6000M-18000M)	The measurement uncertainty is evaluated as ± 3.22 dB.



3. Test Equipment and Ancillaries Used for Tests

AC Power Line Conducted Emission					
Instrument/Ancillary	Manufacturer	Model No.	Serial No.	Calibration Date	Valid Date.
Test Receiver	R&S	ESCI	100564	2021.01.07	2022.01.06
LISN	SCHWARZBECK	NSLK 8127	8127748	2021.01.07	2022.01.06
LISN	SCHWARZBECK	NSLK 8127	8127749	2021.01.07	2022.01.06
ISN	TESEQ	ISN T800	42809	2021.05.10	2022.05.09
Pulse Limiter with 10dB Attenuation	SCHWARZBECK	VTSD 9561-F	9561-F106	2021.01.07	2022.01.06
Temperature/ Humidity Meter	GEMLEAD	STH200A	N/A	2020.08.20	2021.08.19

Radiated Emissions					
Instrument	Manufacturer	Model No.	Serial No.	Calibration Date	Valid Date
EMI Test Receiver	R&S	ESCI	100563	2021.05.14	2022.05.13
H64 Preamplifier	HP	8447F	3113A05582	2021.01.07	2022.01.06
Loop Antenna	R&S	HFH2-Z2	100150	2020.06.08	2022.06.07
Bilog Antenna	Sunol Science	JB1	A072414-1	2020.06.08	2022.06.07
Temperature/ Humidity Meter	GEMLEAD	STH200A	N/A	2020.08.20	2021.08.19



4. Antenna Requirements

4.1 Standard Applicable

For intentional device, according to FCC 47 CFR Section 15.203, an intentional radiator shall be designed to ensure that no antenna other than that furnished by the responsible party shall be used with the device.

4.2 Antenna Construction

The antenna is Coil Antenna, and the antenna connector is de-signed with permanent attachment and on consideration of replacement. Please see the EUT photo for details.

4.3 Result

The EUT antenna is Loop Antenna. It complies with the standard requirement.



5. Test of Conducted Emission

5.1 Test Limit

According to §15.207: For all the consumer devices which is designed to be connected to the public utility (AC) power line, the radio frequency voltage that is conducted back onto the AC power line on any frequency or frequencies within the band 150 kHz to 30 MHz shall not exceed 250 microvolts (The limit decreases linearly with the logarithm of the frequency in the range 0.15 MHz to 0.50 MHz). The limits at specific frequency range are listed as follows:

Frequency (MHz)	Quasi Peak (dB μ V)	Average (dB μ V)
0.15 – 0.5	66-56*	56-46*
0.5 – 5.0	56	46
5.0 – 30.0	60	50

Remark: (1)*Decreases with the logarithm of the frequency.

(2)The lower limit shall apply at the transition frequency.

5.2 Test Procedures

- a. The EUT was placed 0.4 meter from the conducting wall of the shielding room was kept at least 80 centimeters from any other grounded conducting surface.
- b. Connect EUT to the power mains through a line impedance stabilization network (LISN).
- c. All the support units are connecting to the other LISN.
- d. The LISN provides 50 ohm coupling impedance for the measuring instrument.
- e. The FCC states that a 50 ohm, 50 micro-Henry LISN should be used.
- f. Both sides of AC line were checked for maximum conducted interference.
- g. The frequency range from 150 kHz to 30 MHz was searched.
- h. Set the test-receiver system to Peak Detect Function and Specified Bandwidth with Maximum Hold Mode.



5.3 Typical Test Setup

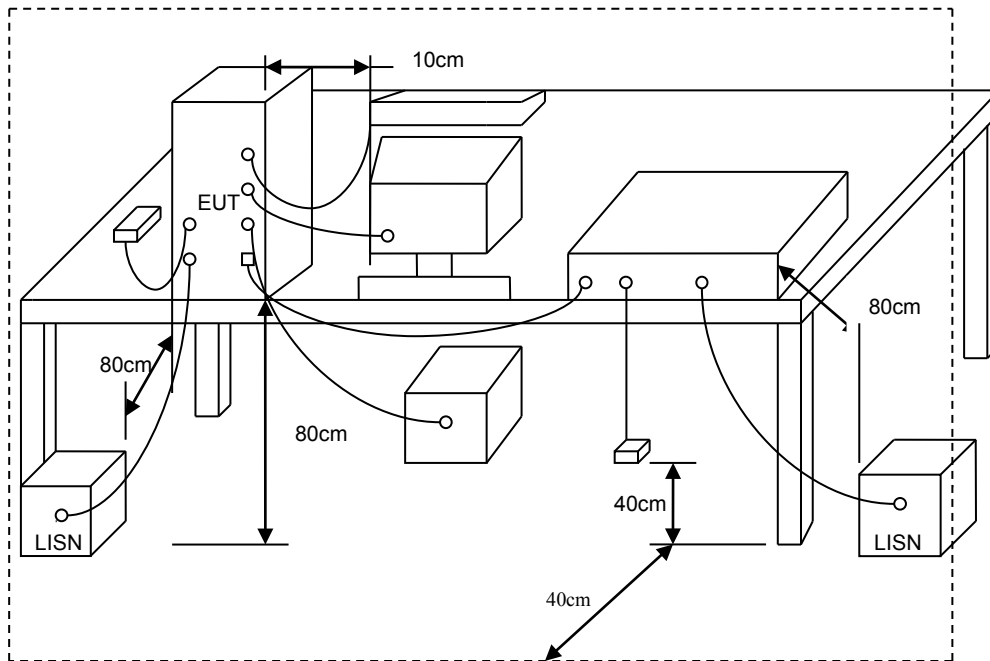



5.4 Test Result and Data

Test Mode :	Mode 5	Phase :	Line
Power :	AC 120V/60Hz		

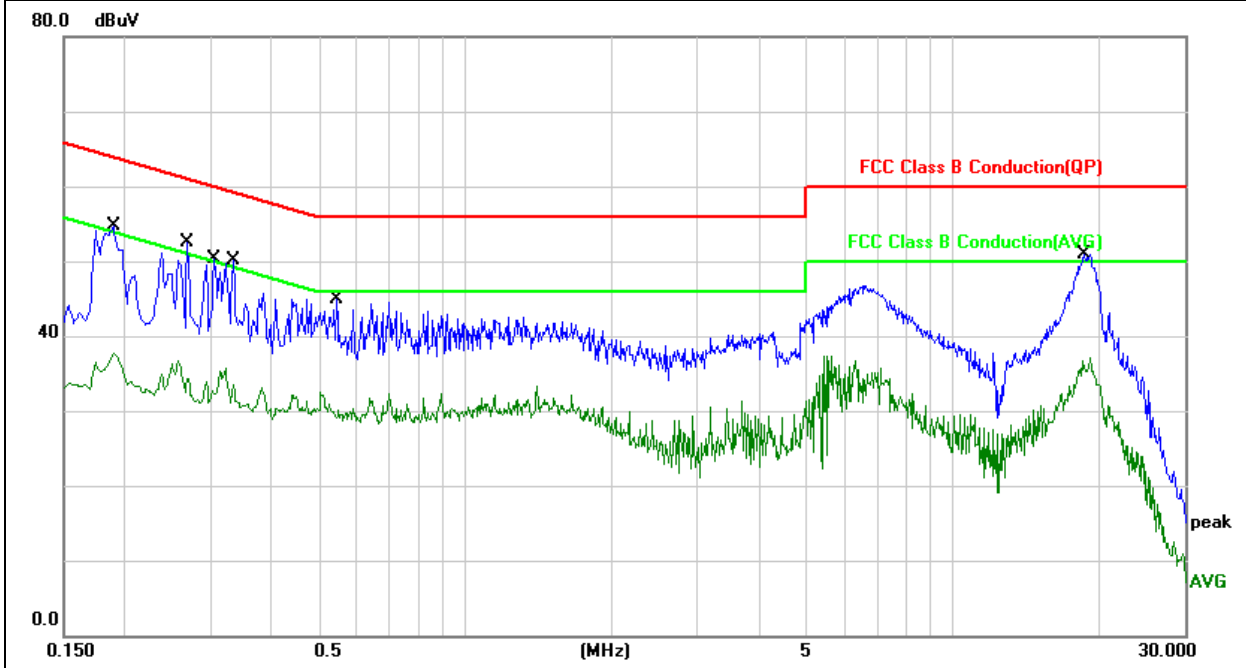

No.	Frequency (MHz)	Factor (dB)	Reading (dBuV)	Level (dBuV)	Limit (dBuV)	Margin (dB)	Detector
1	0.1900	10.05	39.66	49.71	64.03	-14.32	QP
2	0.1900	10.05	26.79	36.84	54.03	-17.19	AVG
3	0.2700	10.11	33.27	43.38	61.12	-17.74	QP
4	0.2700	10.11	22.63	32.74	51.12	-18.38	AVG
5	0.3060	10.12	32.93	43.05	60.08	-17.03	QP
6	0.3060	10.12	22.25	32.37	50.08	-17.71	AVG
7	0.3339	10.11	29.07	39.18	59.35	-20.17	QP
8	0.3339	10.11	21.09	31.20	49.35	-18.15	AVG
9	0.5460	10.10	25.89	35.99	56.00	-20.01	QP
10	0.5460	10.10	19.00	29.10	46.00	-16.90	AVG
11	18.6660	9.99	36.24	46.23	60.00	-13.77	QP
12	18.6660	9.99	24.62	34.61	50.00	-15.39	AVG

Note: Measurement Level = Reading Level + Correct Factor+ Attenuator



Test Mode :	Mode 5	Phase :	Neutral
Power :	AC 120V/60Hz		

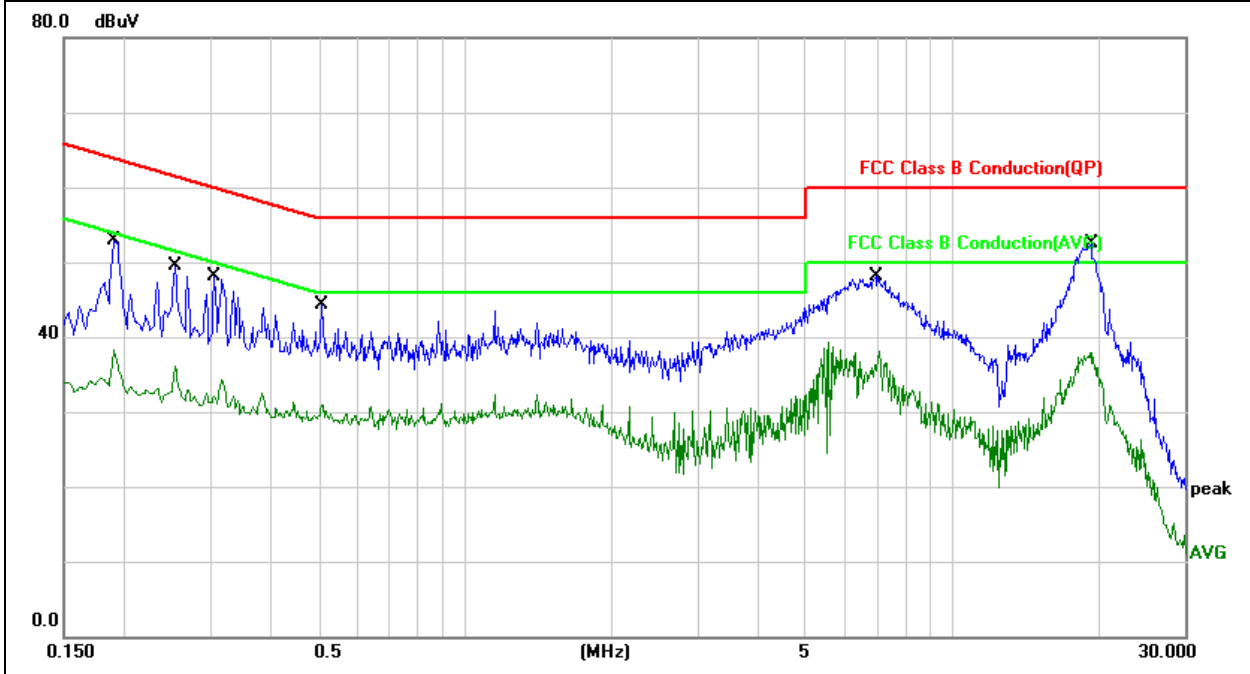

No.	Frequency (MHz)	Factor (dB)	Reading (dBuV)	Level (dBuV)	Limit (dBuV)	Margin (dB)	Detector
1	0.1900	10.13	31.78	41.91	64.03	-22.12	QP
2	0.1900	10.13	23.43	33.56	54.03	-20.47	AVG
3	0.2540	10.09	34.09	44.18	61.62	-17.44	QP
4	0.2540	10.09	23.90	33.99	51.62	-17.63	AVG
5	0.3060	10.07	29.98	40.05	60.08	-20.03	QP
6	0.3060	10.07	21.54	31.61	50.08	-18.47	AVG
7	0.5100	10.14	26.16	36.30	56.00	-19.70	QP
8	0.5100	10.14	19.98	30.12	46.00	-15.88	AVG
9	6.9740	9.92	34.66	44.58	60.00	-15.42	QP
10	6.9740	9.92	25.40	35.32	50.00	-14.68	AVG
11	19.3140	9.97	32.17	42.14	60.00	-17.86	QP
12	19.3140	9.97	22.96	32.93	50.00	-17.07	AVG

Note: Measurement Level = Reading Level + Correct Factor+ Attenuator



6. Test of Radiated Emission

6.1 Test Limit

In any 100kHz bandwidth outside the frequency band, the radio frequency power produced by According to §15.209(a), for a intentional device, the general requirement of field strength of radiated emissions from intentional radiators at a distance of 3 meters shall not exceed the following values:

Radiated Emission Limit (9KHz~1000MHz)

FREQUENCIES(MHz)	FIELD STRENGTH(microvolts/meter)	MEASUREMENT DISTANCE(meters)
0.009~0.490	2400/F(kHz)	300
0.490~1.705	24000/F(kHz)	30
1.705~30.0	30	30
30~88	100	3
88~216	150	3
216~960	200	3
Above 960	500	3

Note:

- (1) The tighter limit applies at the band edges.
- (2) Emission Level (dBuV/m)=20log Emission Level(uV/m)



6.2 Test Procedures

- a. The EUT was placed on a rotatable table top 0.8 meter above ground.
- b. The EUT was set 1/3 meters from the interference receiving antenna which was mounted on the top of a variable height antenna tower.
- c. The table was rotated 360 degrees to determine the position of the highest radiation.
- d. The antenna is a broadband antenna and its height is varied between one meter and four meters above ground to find the maximum value of the field strength both horizontal polarization and vertical polarization of the antenna are set to make the measurement.
- e. For each suspected emission the EUT was arranged to its worst case and then tune the antenna tower (from 1 M to 4 M) and turn table (from 0 degree to 360 degrees) to find the maximum reading.
- f. Set the test-receiver system to Peak or CISPR quasi-peak Detect Function and specified bandwidth with Maximum Hold Mode.
- g. If the emission level of the EUT in peak mode was 3 dB lower than the limit specified, then testing will be stopped and peak values of EUT will be reported, otherwise, the emissions which do not have 3 dB margin will be repeated one by one using the quasi-peak method and reported.
- h. For testing above 1GHz, the emission level of the EUT in peak mode was 20dB lower than average limit (that means the emission level in peak mode also complies with the limit in average mode), then testing will be stopped and peak values of EUT will be reported, otherwise, the emissions will be measured in average mode again and reported.



6.3 Typical Test Setup

Below 30MHz Test Setup

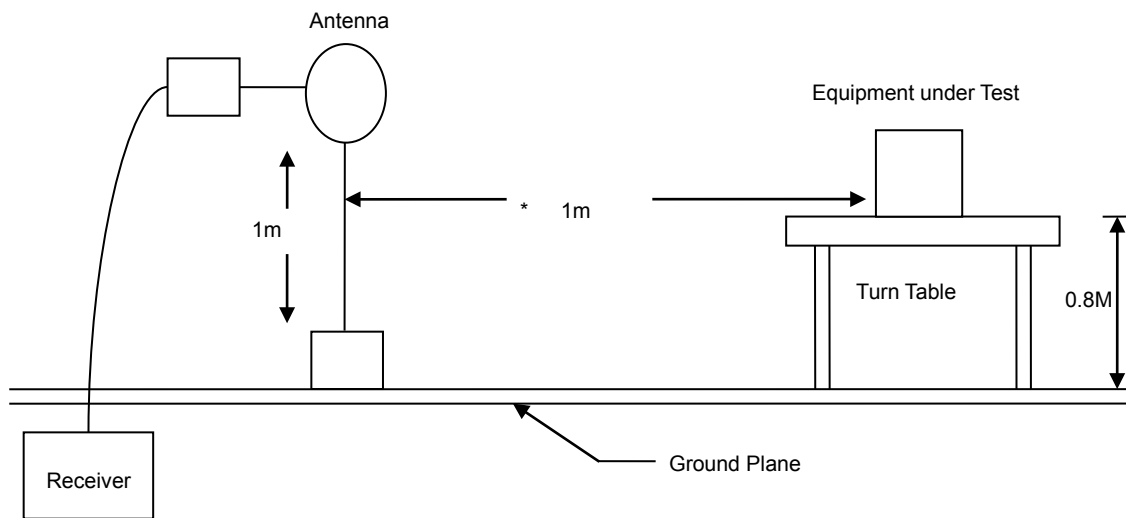

30M - 1GHz Test Setup

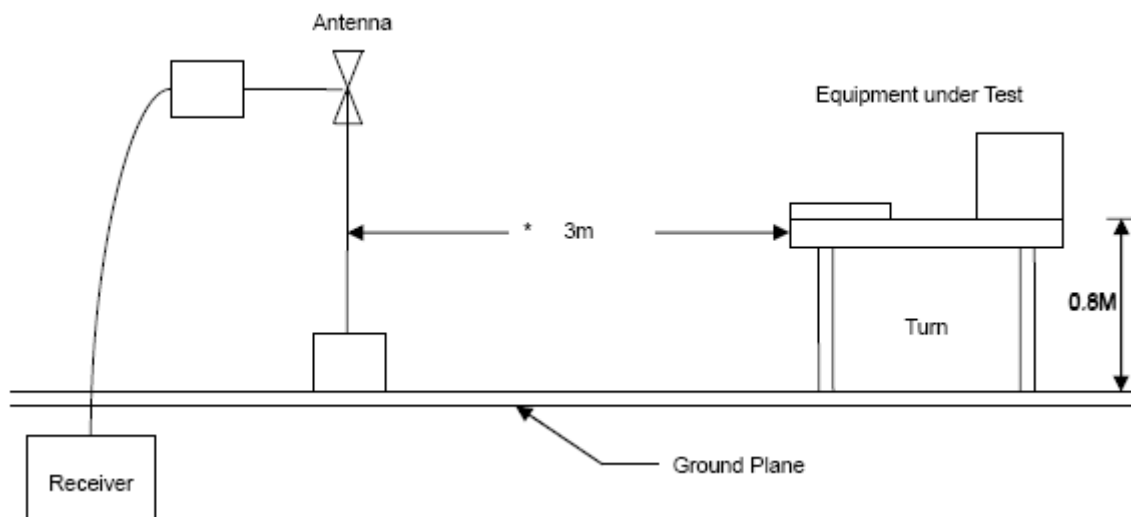



6.4 Test Result and Data

For 9KHz~30MHz

Test Mode	: Mode 5	Polarization	: X
Power	: AC 120V/60HZ	Frequency range	: 9KHz-150KHz

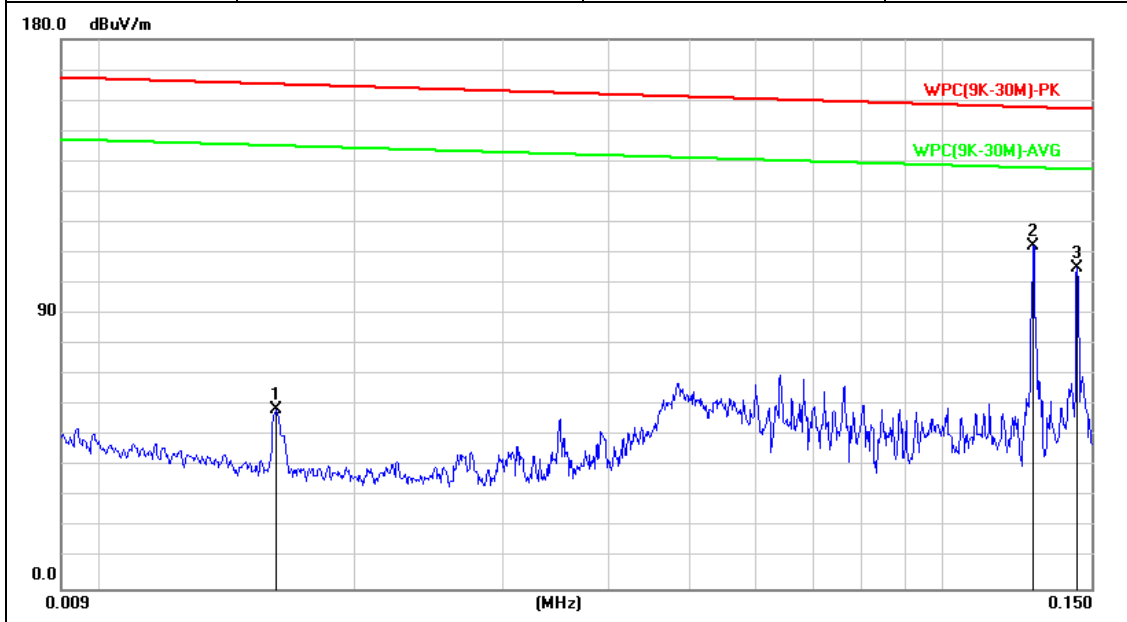

N o.	Frequency (MHz)	Factor (dB/m)	Reading (dBuV)	Level (dBuV/m)	Limit (dBuV/m)	Margin (dB)	Det.
1	0.0162	20.73	37.88	58.61	142.49	-64.43	AVG
2	0.1278	20.33	91.79	112.12	124.55	-31.72	AVG
3	0.1442	20.16	84.92	105.08	123.50	-18.42	AVG

Note: Level = Reading + Factor
 Margin = Level – Limit
 Factor= Antenna Factor + Cable Loss - Amplifier Factor



Test Mode	: Mode 5	Polarization	: X
Power	: AC 120V/60HZ	Frequency range	: 150KHz-30MHz

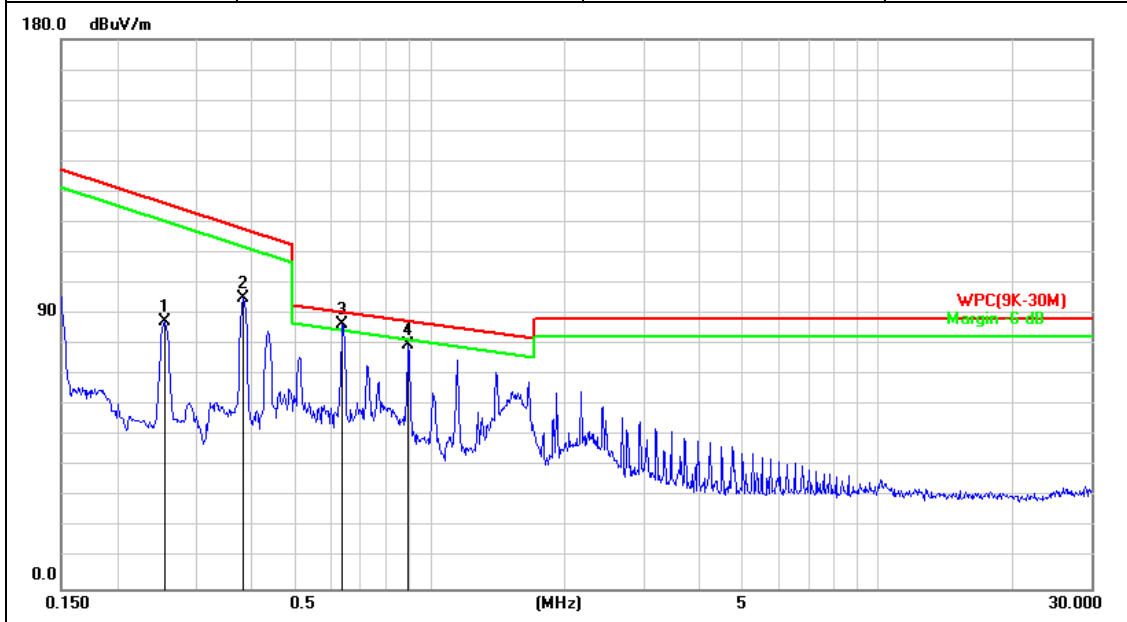

N	Frequency (MHz)	Factor (dB/m)	Reading (dBuV)	Level (dBuV/m)	Limit (dBuV/m)	Margin (dB)	Det.
1	0.2548	20.34	66.99	87.33	118.56	-31.23	AVG
2	0.3832	20.63	74.53	95.16	115.02	-19.86	AVG
3	0.6372	20.85	65.58	86.43	90.60	-4.17	QP
4	0.8944	20.74	58.97	79.71	87.65	-7.94	QP

Note: Level = Reading + Factor
 Margin = Level – Limit
 Factor= Antenna Factor + Cable Loss - Amplifier Factor



Test Mode	: Mode 5	Polarization	: Y
Power	: AC 120V/60HZ	Frequency range	: 9KHz-150KHz

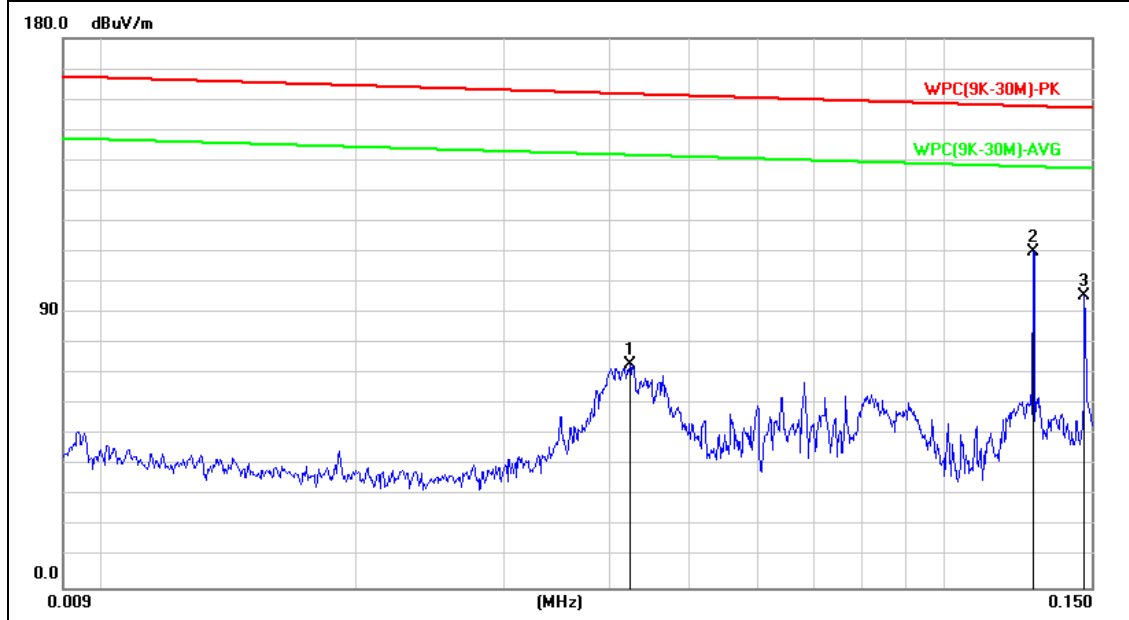

N o.	Frequency (MHz)	Factor (dB/m)	Reading (dBuV)	Level (dBuV/m)	Limit (dBuV/m)	Margin (dB)	Det.
1	0.0424	21.04	52.09	73.13	134.14	-61.01	AVG
2	0.1276	20.34	89.78	110.12	124.57	-14.45	AVG
3	0.1470	20.13	75.47	95.60	123.34	-27.74	AVG

Note: Level = Reading + Factor
Margin = Level – Limit
Factor= Antenna Factor + Cable Loss - Amplifier Factor



Test Mode	: Mode 5	Polarization	: Y
Power	: AC 120V/60HZ	Frequency range	: 150KHz-30MHz

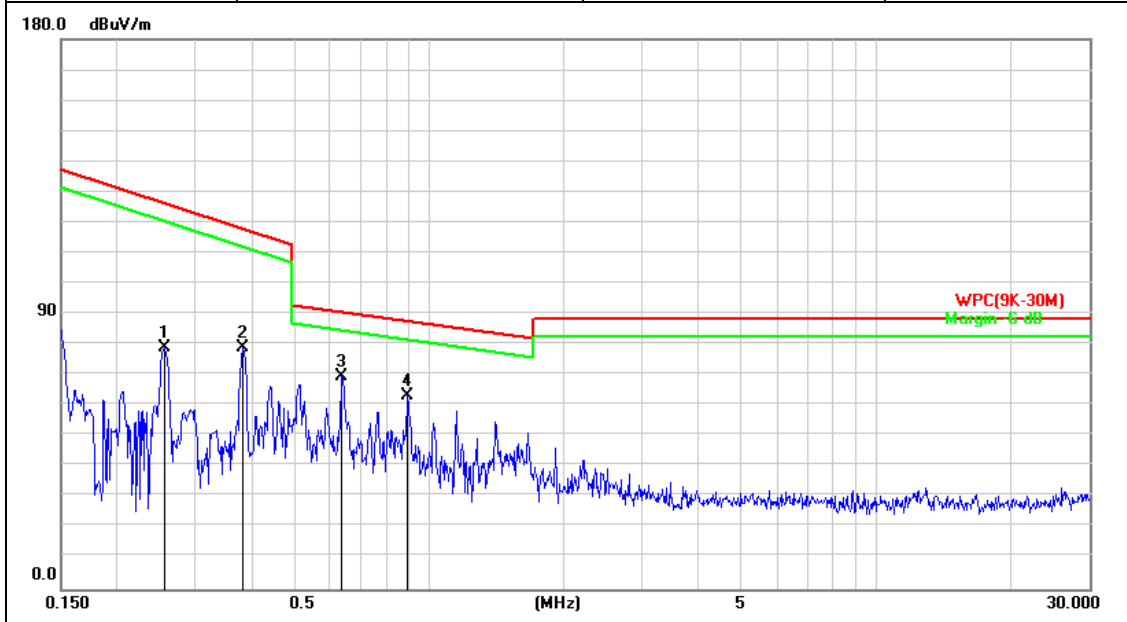

N	Frequency (MHz)	Factor (dB/m)	Reading (dBuV)	Level (dBuV/m)	Limit (dBuV/m)	Margin (dB)	Det.
1	0.2548	20.34	58.44	78.78	118.56	-39.78	AVG
2	0.3832	20.63	58.38	79.01	115.02	-36.01	AVG
3	0.6372	20.85	48.76	69.61	90.60	-20.99	QP
4	0.8944	20.74	42.51	63.25	87.65	-24.40	QP

Note: Level = Reading + Factor
Margin = Level – Limit
Factor= Antenna Factor + Cable Loss - Amplifier Factor



For 30MHz~1GHz

Test Mode	: Mode 5	Pol/Phase	: VERTICAL
Power	: AC 120V/60Hz		

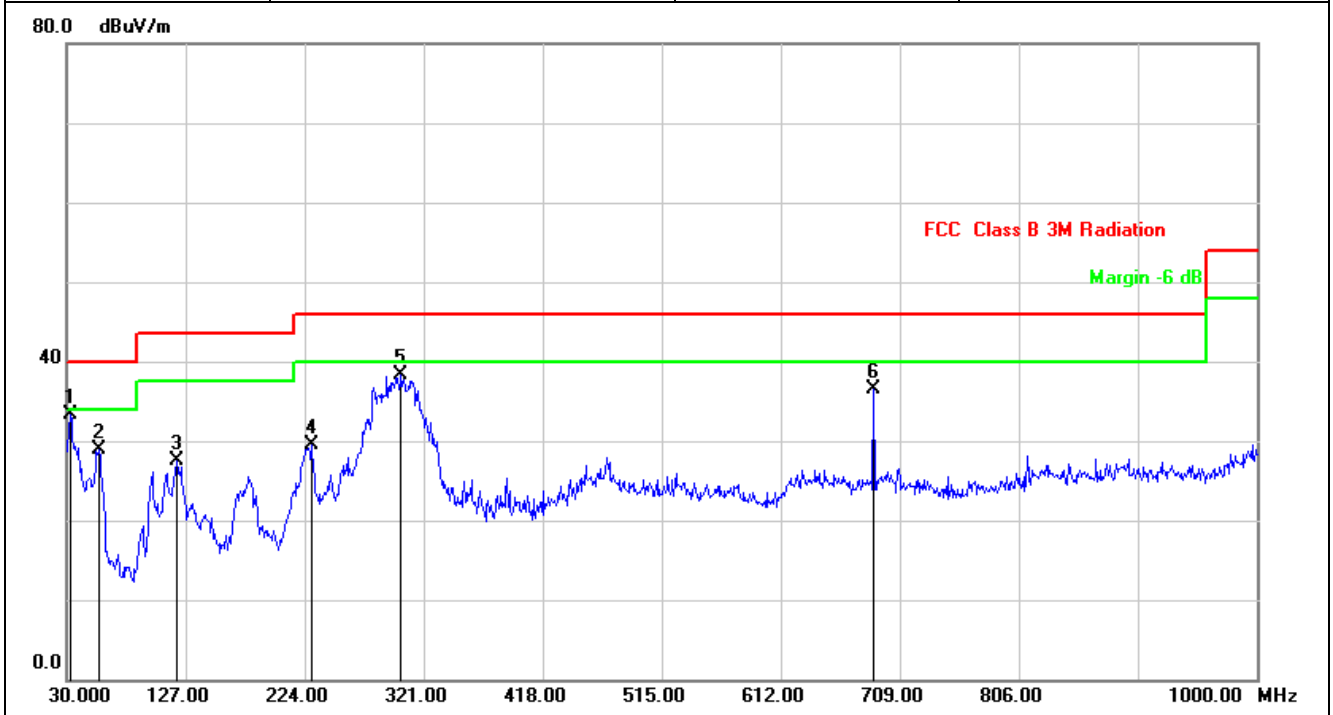

No.	Frequency (MHz)	Factor (dB/m)	Reading (dBuV)	Level (dBuV/m)	Limit (dBuV/m)	Margin (dB)	Det.	Height (cm)	Azimuth (deg)
1	32.9100	-5.93	39.20	33.27	40.00	-6.73	peak	100	224
2	56.1900	-17.04	45.90	28.86	40.00	-11.14	peak	200	317
3	120.2100	-10.71	38.15	27.44	43.50	-16.06	peak	100	102
4	229.8200	-12.42	41.86	29.44	46.00	-16.56	peak	200	185
5	302.5700	-9.19	47.57	38.38	46.00	-7.62	peak	100	356
6	687.6599	-1.76	38.19	36.43	46.00	-9.57	peak	100	293

Note: Level = Reading + Factor
 Margin = Level – Limit
 Factor= Antenna Factor + Cable Loss - Amplifier Factor



Test Mode	: Mode 5	Pol/Phase	: Horizontal
Power	: AC 120V/60Hz		

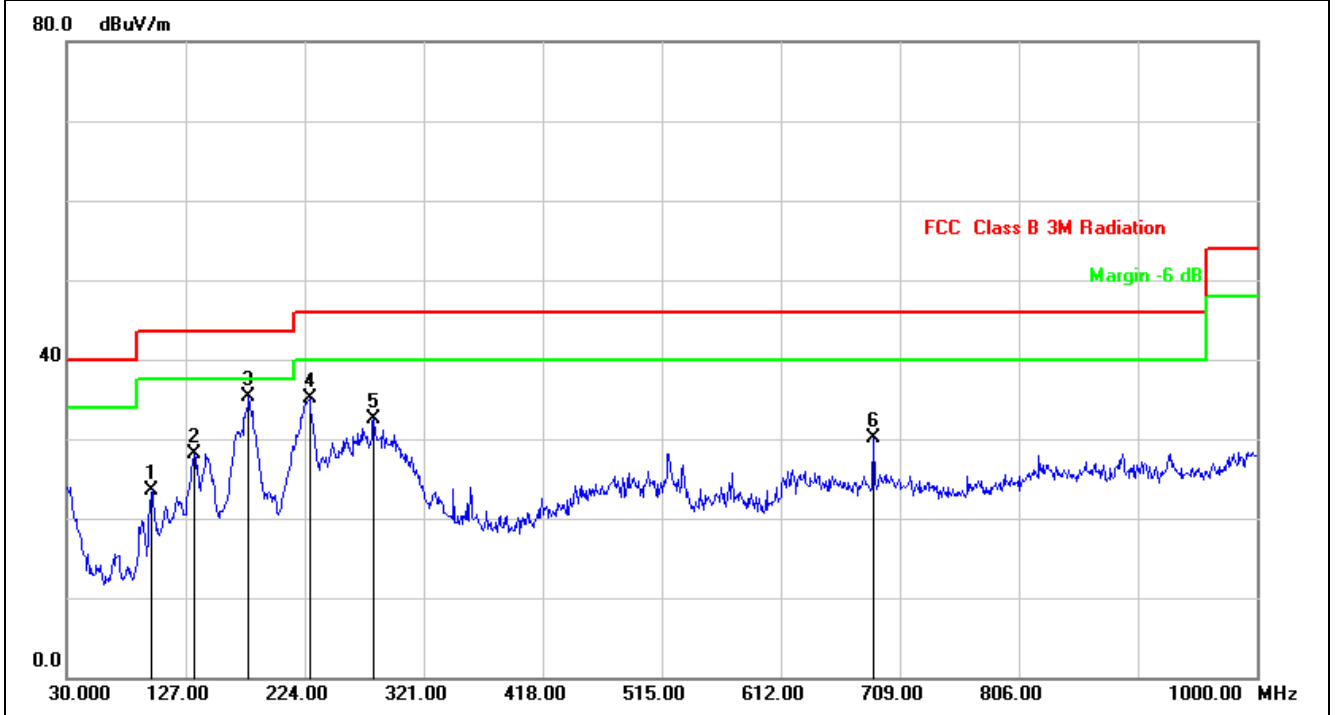

No.	Frequency (MHz)	Factor (dB/m)	Reading (dBuV)	Level (dBuV/m)	Limit (dBuV/m)	Margin (dB)	Det.	Height (cm)	Azimuth (deg)
1	99.8399	-15.06	38.58	23.52	43.50	-19.98	peak	200	143
2	133.7899	-10.57	38.67	28.10	43.50	-15.40	peak	200	269
3	178.4100	-12.92	48.20	35.28	43.50	-8.22	peak	200	224
4	227.8800	-12.45	47.61	35.16	46.00	-10.84	peak	100	302
5	280.2600	-10.37	42.80	32.43	46.00	-13.57	peak	200	198
6	687.6599	-1.76	31.80	30.04	46.00	-15.96	peak	100	351

Note: Level = Reading + Factor
 Margin = Level – Limit
 Factor= Antenna Factor + Cable Loss - Amplifier Factor



7. 20dB Bandwidth

7.1 Test Limit

None: for reporting purposed only.

7.2 Test Procedures

Intentional radiators operating under the alternative provisions to the general emission limits, as contained in §15.215, must be designed to ensure that 20dB bandwidth of the emission, or whatever bandwidth may otherwise be specified in the specific rule section under which the equipment operates is contained within the frequency band designated in the rule section under which the equipment is operated.

7.3 Typical Test Setup

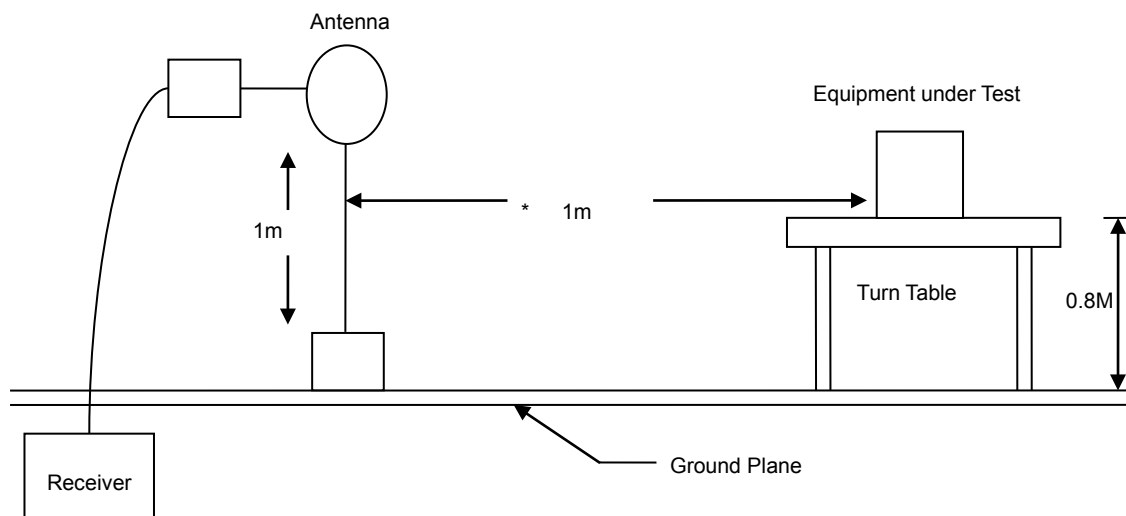



7.4 Test Result and Data

Wireless1

Frequency (KHz)	20 dB bandwidth (KHz)	PASS / FAIL
127.7767KHz	0.050	PASS

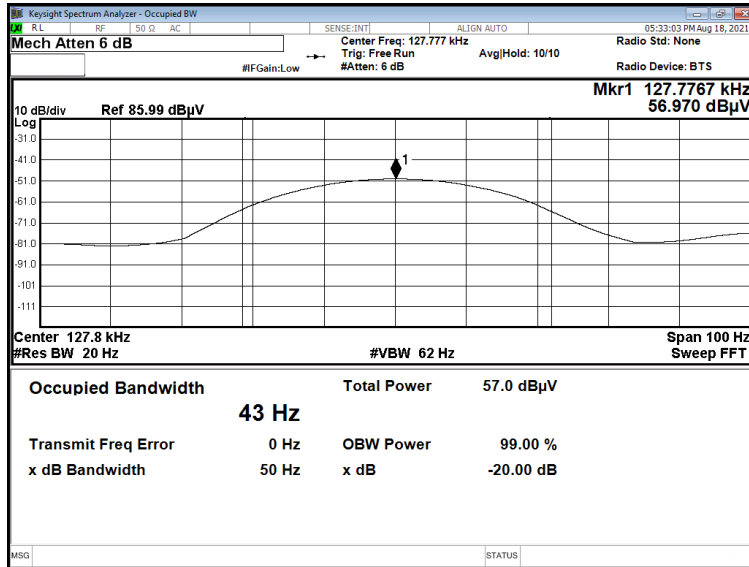

Wireless2

Frequency (KHz)	20 dB bandwidth (KHz)	PASS / FAIL
127.7765KHz	0.051	PASS

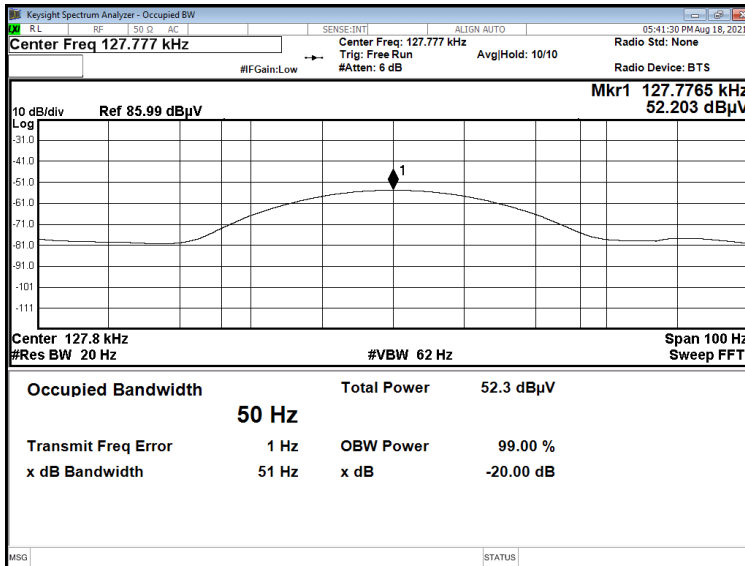

----- End of the report -----