



singing machine®

creating Joy through music™

iSM1080

INSTRUCTION MANUAL/MANUAL DE INSTRUCCIONES
/MODE D'EMPLOI

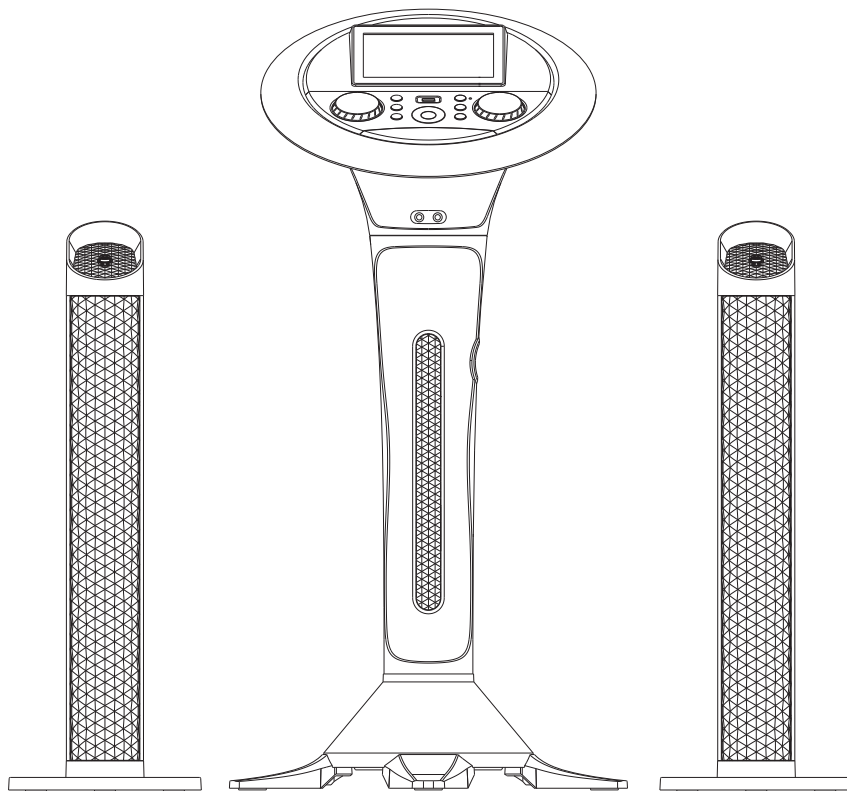



www.singingmachine.com

The Singing Machine® is a registered trademark of The Singing Machine Co., Inc.

The Singing Machine® es marca registrada de The Singing Machine Co., Inc.

The Singing Machine® est une marque déposée de The Singing Machine Co., Inc.

Warnings

	CAUTION RISK OF ELECTRIC SHOCK DO NOT OPEN	
CAUTION: TO REDUCE THE RISK OF ELECTRIC SHOCK, DO NOT REMOVE COVER (OR BACK). NO USER-SERVICEABLE PARTS INSIDE. REFER SERVICING TO QUALIFIED SERVICE PERSONNEL.		



DANGEROUS VOLTAGE: The lightning flash with arrowhead symbol within an equilateral triangle is intended to alert the user to the presence of uninsulated dangerous voltage within the product's enclosure that may be of sufficient magnitude to constitute a risk of electric shock to persons.



ATTENTION: The exclamation point within an equilateral triangle is intended to alert the user to the presence of important operating and maintenance (servicing) instructions in the literature accompanying this product.

DRIPPING WARNING: This product shall not be exposed to dripping or splashing, and no objects filled with liquids, such as vases, shall be placed on the product.

VENTILATION WARNING: The normal ventilation of the product shall not be impeded for intended use.

CAUTION: TO PREVENT ELECTRIC SHOCK, MATCH WIDE BLADE OF PLUG TO WIDE SLOT AND FULLY INSERT.

WARNING: TO PREVENT FIRE OR SHOCK HAZARD, DO NOT EXPOSE THIS UNIT TO RAIN OR MOISTURE.

FCC WARNING: This equipment may generate or use radio frequency energy. Changes or modifications to this equipment may cause harmful interference unless the modifications are expressly approved in the instruction manual. The user could lose the authority to operate this equipment if an unauthorized change or modification is made.

This device complies with part 15 of the FCC Rules. Operation is subject to the following two conditions: (1) This device may not cause harmful interference, and (2) this device must accept any interference received, including interference that may cause undesired operation.

NOTE: This equipment has been tested and found to comply with the limits for a Class B digital device, pursuant to part 15 of the FCC Rules. These limits are designed to provide reasonable protection against harmful interference in a residential installation. This equipment generates, uses and can radiate radio frequency energy and, if not installed and used in accordance with the instructions, may cause harmful interference to radio communications. However, there is no guarantee that interference will not occur in a particular installation. If this equipment does cause harmful interference to radio or television reception, which can be determined by turning the equipment off and on, the user is encouraged to try to correct the interference by one or more of the following measures:

- Reorient or relocate the receiving antenna.
 - Increase the separation between the equipment and receiver.
 - Connect the equipment into an outlet on a circuit different from that to which the receiver is connected.
 - Consult the dealer or an experienced radio/TV technician for help.
- The rating information is located at the rear of the unit.

Warning: Changes or modifications to this unit not expressly approved by the party responsible for compliance could void the user's authority to operate the equipment.

Important Safety Information

1. Read these Instructions.
2. Keep these Instructions.
3. Heed all Warnings.
4. Follow all Instructions.
5. Do not use this apparatus near water.
6. Clean only with a dry cloth.
7. Do not block any of the ventilation openings. Install in accordance with the Manufacturer's instructions.
8. Do not install near any heat sources such as radiators, heat registers, stoves, or other apparatus (including amplifiers) that produce heat.
9. Do not defeat the safety purpose of the polarized or grounding-type plug. A polarized plug has two blades with one wider than the other. A grounding type plug has two blades and a third grounding prong. The wide blade or the third prong are provided for your safety. When the provided plug does not fit into your outlet, consult an electrician for replacement of the obsolete outlet.
10. Protect the power cord from being walked on or pinched particularly at plugs, convenience receptacles, and the point where they exit from the apparatus.
11. Only use attachments/accessories specified by the manufacturer.
12. Use only with a cart, stand, tripod, bracket, or table specified by the manufacturer, or sold with the apparatus. When a cart is used, use caution when moving the cart/apparatus combination to avoid injury from tip-over. PORTABLE CART WARNING
(symbol provided by RETAC)
13. Unplug this apparatus during lightning storms or when unused for long periods of time. 
14. Refer all servicing to qualified service personnel. Servicing is required when the apparatus has been damaged in any way, such as power-supply cord or plug is damaged, liquid has been spilled or objects have fallen into the apparatus, the apparatus has been exposed to rain or moisture, does not operate normally, or has been dropped.
15. **WARNING:** To reduce the risk of fire or electric shock, do not expose this apparatus to rain or moisture. Do not place objects filled with water, such as a vase, on the apparatus.
16. The AC mains plug is used as the power disconnect device and it should remain readily accessible and operable during intended use. In order to completely disconnect the apparatus from power, the mains plug should be completely removed from the AC outlet socket.
17. **CAUTION:** To reduce the risk of fire or explosion, do not expose batteries to excessive heat such as sunshine, fire or other heat sources.

Included

Please make sure that the following items are included.

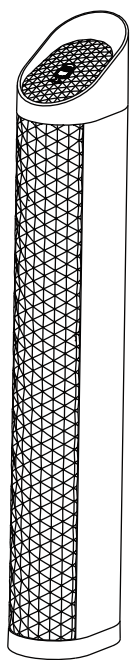

Tower Speaker x 2

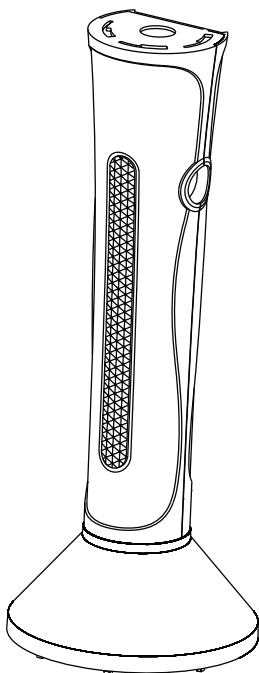

Pedestal

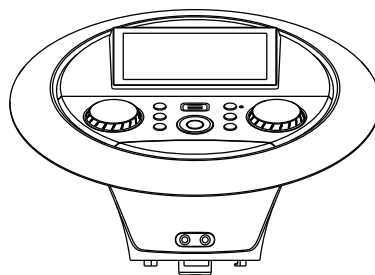

Main Unit



Pedestal Feet x 4

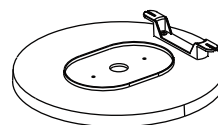

Speaker Stand x 2



Pedestal jack cover

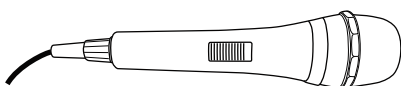

Wired Microphone x 2



Speaker Stand
Screws x 4

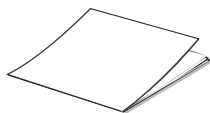

Manual

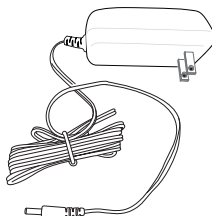

AC Adapter



Pedestal
Screws x 5

Assembly

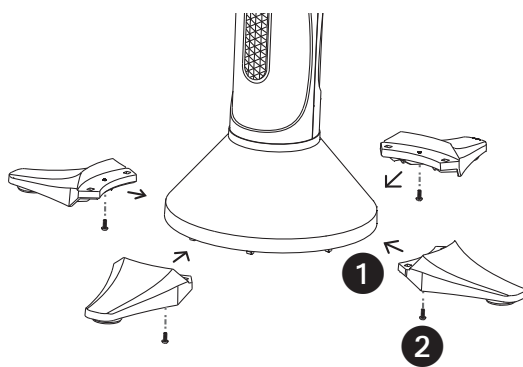

- 1 Install the four pedestal feet **1** into the pedestal base and secure each with one screw **2**.

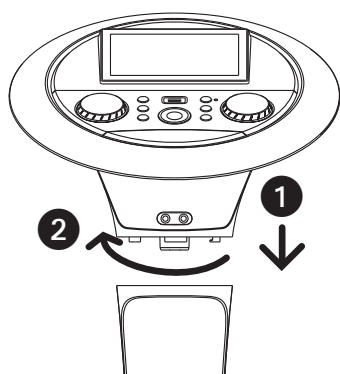

- 2 Insert the main unit into the pedestal **1** and then gently rotate clockwise **2** until the screw hole on the base aligns with the screw hole on the pedestal.

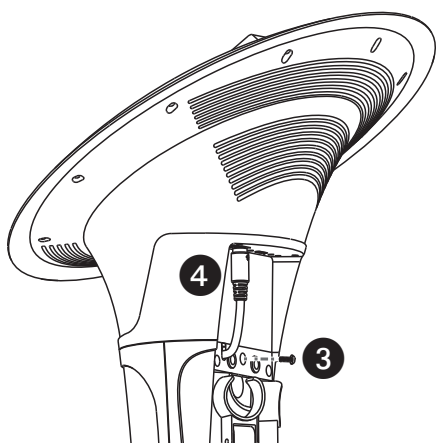

- 3 Insert and tighten the last screw on the rear of the pedestal to secure the main unit in position.

- 4 Plug the woofer cable of the pedestal into the woofer jack located on the main unit.

Assembly

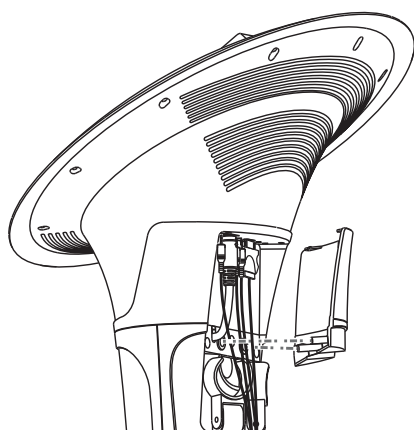

5

Connect to AC power, HDMI (if desired) and speakers as shown on page 7. Put the pedestal jack cover onto the rear of the main unit. You will hear a "click" sound when locked. Ensure you have plugged the DC jack, speaker jacks and HDMI cable before installing the pedestal jack cover.

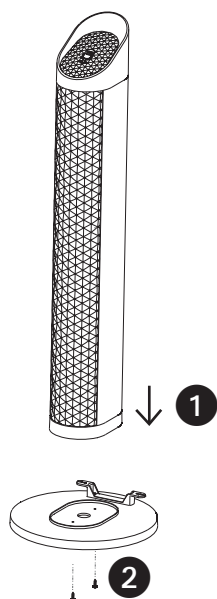

6

Place the tower speaker on the speaker stand while aligning the screw holes ①. Then insert and tighten the speaker screws ② from the bottom of the stand. Repeat the same process on the second tower speaker.

Location of Controls (Top)

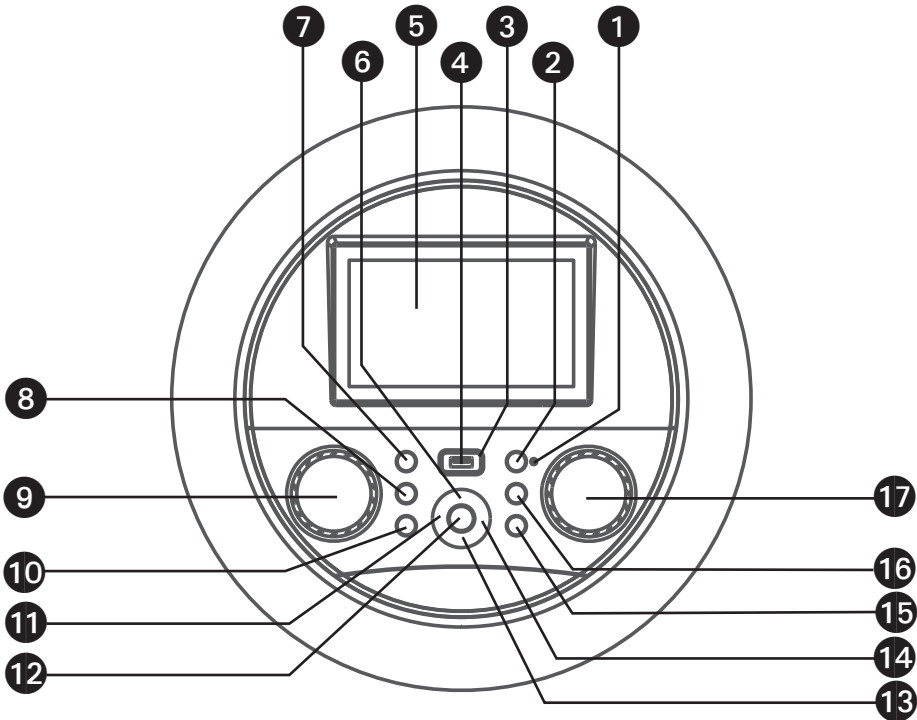

- | | | |
|-----------------------------|--|-----------------------------|
| 1. Bluetooth Indicator | 9. MUSIC VOLUME Control | 16. ● (RECORD) Button |
| 2. Bluetooth Button | 10. 🏠 HOME Button | 17. MIC/ECHO VOLUME Control |
| 3. FUNCTION Indicator | 11. ◀ (Back / Navigation Left) Button | |
| 4. USB Port | 12. ▶▶ (PLAY/PAUSE)/ ENTER button | |
| 5. Touch Screen | 13. ▼ (Navigation Down) Button | |
| 6. ▲ (Navigation Up) Button | 14. ▶ (Next / Navigation Right) Button | |
| 7. ⏻ ON/STANDBY Button | 15. ↶ RETURN Button | |
| 8. 💡 LIGHTS Button | | |

Location of Controls

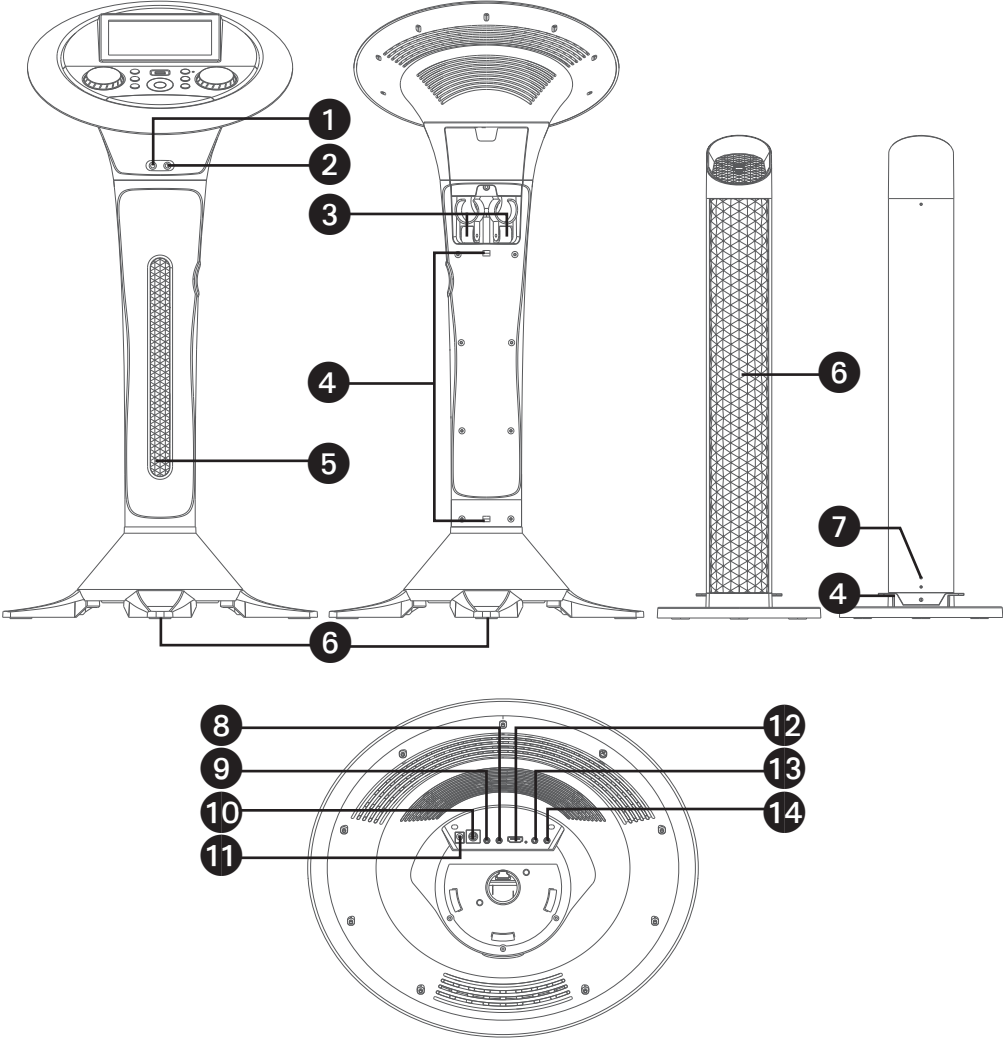

- | | |
|----------------------------|-----------------------------|
| 1. Mic 1 Jack | 8. Left Tower Speaker Jack |
| 2. Mic 2 Jack | 9. Right Tower Speaker Jack |
| 3. Retractable MIC holders | 10. Subwoofer Jack |
| 4. Cord management clamps | 11. DC IN Jack |
| 5. Lights | 12. HDMI Jack (Video only) |
| 6. Speaker | 13. Line Out Jack |
| 7. Speaker cable | 14. Line In Jack |

Connections

Connecting the Microphone(s)

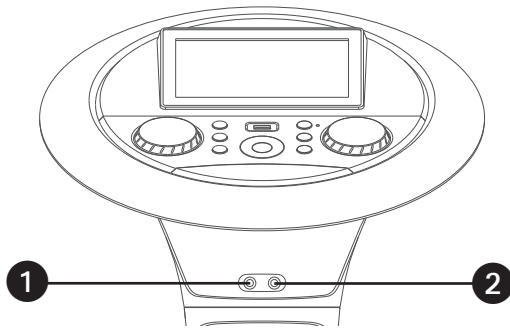

Microphones:

Connect a microphone into Mic jack 1 **1** as well as Mic jack 2 **2** (when desired).

Note: Do not drop or tap the Mic as damage to the Mic or speakers may occur. Do not twirl the microphone cord as it will cause damage to the encased wiring.

Connecting the Tower Speakers

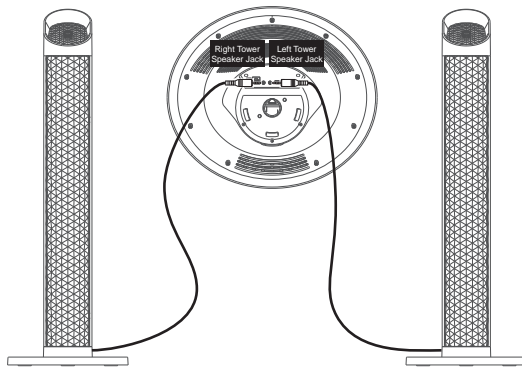

1 To protect the speakers, make sure the unit is off and the **MUSIC VOLUME** and **MIC VOLUME** controls are set to minimum.

2 Connect the Right and Left Tower Speakers to the jacks on back of the unit as illustrated.

3 Turn the power on and slowly raise the **MUSIC VOLUME** and **MIC VOLUME** controls to a comfortable level.

Connecting to AC Power

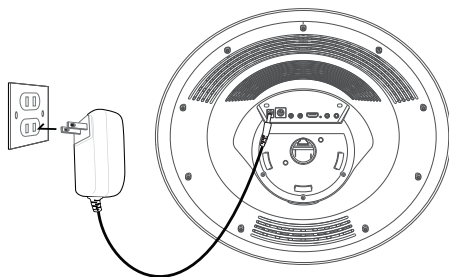

1 Insert the DC plug of the adapter **into** the DC IN Jack located on the main unit.

2 Insert the AC adapter into a conveniently located AC outlet having 120V AC, 60Hz.

3 Secure the power cord into the **pre-installed Power Cord Clamps**.

Note:

- Make all connections prior to plugging the AC adaptor into a power outlet.
- The AC adaptor has a polarized plug that fits into the AC outlet only one way. If the plug does not fit properly, turn it over and try again. Do not force and do not file or cut the wide blade.

Connections

Connecting to Line Out Jack

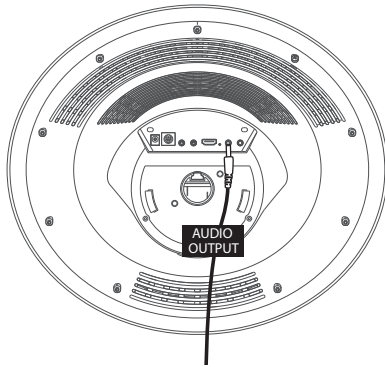

This unit can be connected to another audio system for greater audio output via 3.5mm AUX cord (not included).

Plug one end of AUX cord into the **LINE OUT** jack located on the rear of the machine.

Plug the other end of the AUX cord into the Line In jack on your separate audio device. You may need to refer the instructions of your separate audio device for more details.

Connecting the Unit to a TV

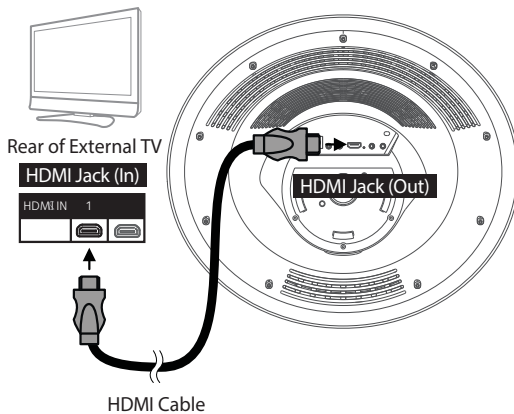

The video and lyrics will be displayed on the built-in screen. You may also want to connect a TV to display a larger image (follow the steps below):

Plug the HDMI cable (not included) into the HDMI Jack on the back of the unit. Plug the other end of the HDMI cable into the HDMI input on your TV.

Notes:

- This unit can be used with or without a TV.
- Also refer to the TV's or external unit's User Guide.

Connections

TFT Touch Screen

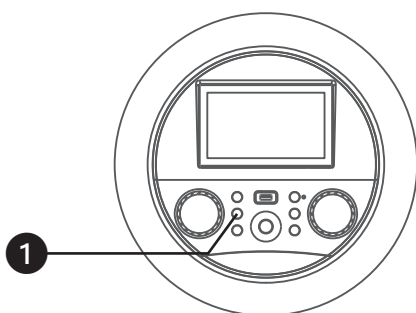

The TFT touch screen will be switched on automatically when the unit is powered on. To turn the screen off, press and hold the  (**LIGHTS**) button. Repeat the same step to turn the screen on again.

Lights Mode

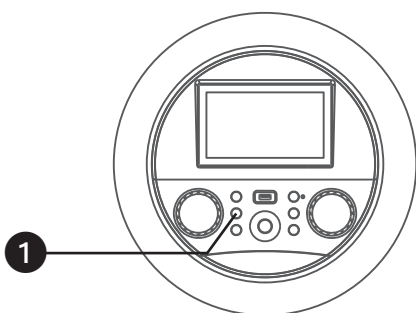

There are three Light modes. Repeatedly press the  (**LIGHTS**) button to select a mode as follows:

Light Mode 1: The unit will synchronize to the music being played.

Light Mode 2: The unit will light up with random colors and patterns.

Light Mode 3: The light effects will be turned off.

Energy Saving (Auto Power System-APS)

This unit will automatically turn to Screen Saver mode after 10 minutes of inactivity, and automatically turn off after 15 minutes. The unit can be powered back on by pressing the  ON/STANDBY button once. APS is for energy saving purposes.

Note: You can change the energy saving setting in the Wi-Fi & Setting option, see the section of **Wi-Fi & setting**.

Operation

WiFi & Settings



1 Connect the unit as described previously. Press the **⏻ (ON/STANDBY)** button to turn the unit on. The set up Wi-Fi connection window will pop up. Select **SET UP** icon on the touch screen or **▶|| (PLAY/PAUSE/ENTER)** button on the control panel.



2 Select your Wi-Fi network using the touch screen or **▲/▼** Navigation buttons on the control panel.

Note: This unit supports 2.4GHz WiFi only.

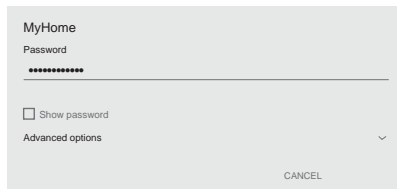

3 Use the keyboard on the touch screen to enter your WiFi password and press the **ENTER** button. "Connected" will appear if the connection is successful. If unsuccessful, check your password and Wi-Fi frequency and re-connect again.

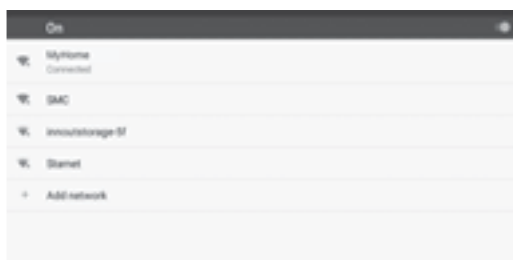

4 Press the **↶ (RETURN)** button on the control panel to go back to the previous screen.

5 Press the **🏠 (HOME)** button on the control panel to go to the home screen. Press and hold the **🏠 (HOME)** button to go to menu.

Operation

WiFi & Settings



6 You can always change the Wi-Fi network, by selecting the **WiFi & SETTINGS** icon on the touch screen or by using the ▲/▼ navigation buttons then press ►|| (**PLAY/PAUSE/ENTER**) button on the control panel to enter the WiFi settings mode.

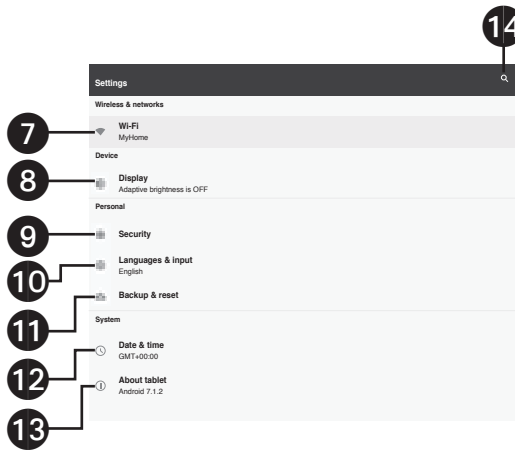

7 Select **Wi-Fi** and connect as previously described, if you want to connect another network.

8 To adjust the brightness, sleep time, font size, display size of touch screen, and HDMI, select **Display**.

9 This unit has a setting to block installing unknown apps, you can turn it on or off from **Security**.

10 Select **LANGUAGES & INPUT** to change the Languages & Input.

11 Select to reset this unit to factory settings.

12 Select to set the date and time.

13 Select to check the version of this unit.

14 Select to search the settings.

Operation

Accessing the Singing Machine Karaoke Catalog

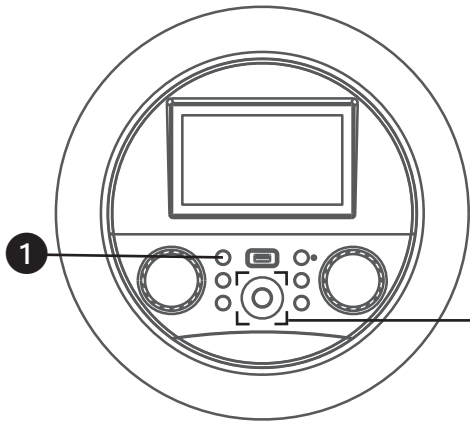

1 Connect the unit as described previously. Press the **⏻ (ON/STANDBY)** button to turn the unit on. The function indicator will light up.



2 **Singing Machine Karaoke** icon using the touch screen or **◀/▶/▲/▼** Navigation and **▶|| (PLAY/PAUSE/ENTER)** buttons to enter Singing Machine Karaoke Store page.

3 Select **"Sign up"** and follow the on screen instructions to register your machine.



4 After signing up, select "Log In" to log into your account. **Select** Singing Machine Karaoke icon at home screen to go to the Singing Machine Karaoke Store home screen directly.

5 Select your favorite songs using the touch screen to playback.

Operation

Accessing the Singing Machine Karaoke Catalog (Continued)

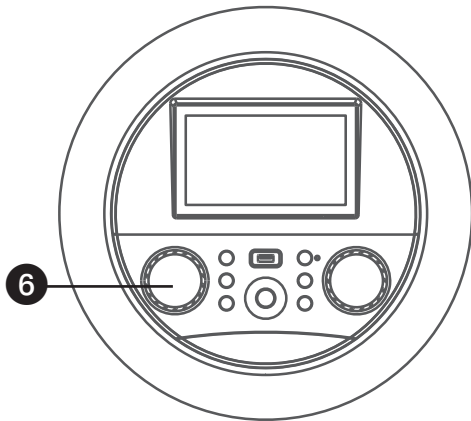

6 Adjust the **MUSIC VOLUME** control as desired.

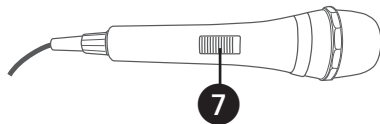

7 Connect the microphone(s) and slide the **ON/OFF** switch on the microphone to the ON position.

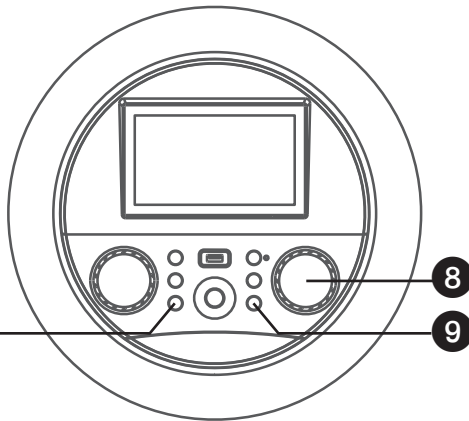

8 Adjust the **MIC/ECHO VOLUME** control as desired. Increasing this control will increase the volume of both microphones. Press then rotate the **MIC/ECHO VOLUME** control as desired to add an echo effect to your voice. Rotate towards MAX to increase the echo.

9 Press ↵ (**RETURN**) button to go back to the previous screen.

10 Press 🏠 (**HOME**) button to go to the home screen while in any mode or screen. Press and hold the 🏠 (**HOME**) button to go to menu.

Operation

Accessing the Singing Machine Karaoke Catalog (Continued)

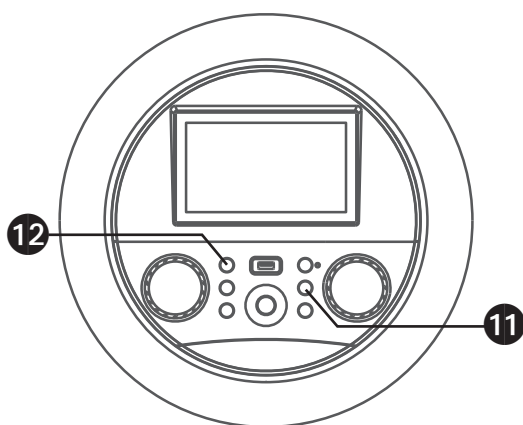

RECORD YOUR VOCAL PERFORMANCE:

11 To record your singing as well as the music, press the ● **(RECORD)** button. Recording will begin and the recording indicator will display on-screen and the function indicator will begin flashing red. When done recording, press the ● **(RECORD)** button again; the function indicator will stop flashing.

Notes:

- You cannot start recording until the USB drive is inserted.
- Insert the USB flash drive into the USB slot on the unit with the face towards the top of the unit.

12 Press the ⏻ **(ON/STANDBY)** button to turn off the unit. The function indicator will turn off.

Operation

Applications

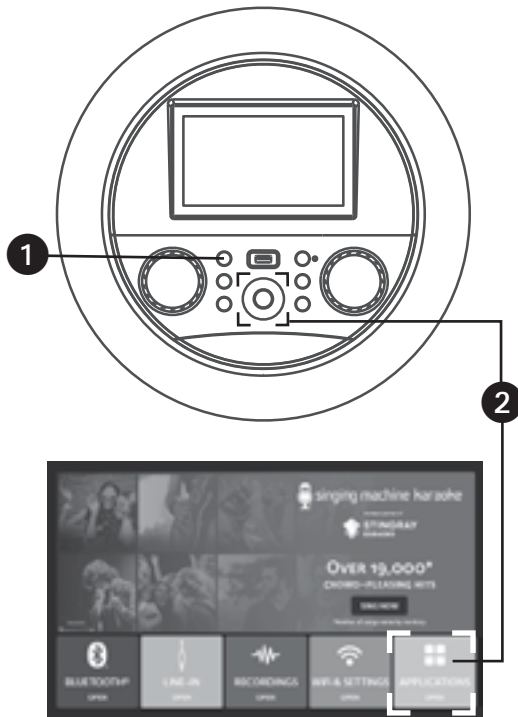

1 Connect the unit as described previously. Press the **⏻ (ON/STANDBY)** button to turn the unit on. The function indicator will light up.

2 Select **APPLICATIONS** icon using the touch screen or **◀/▶/▲/▼** navigation and **▶|| (PLAY/PAUSE/ENTER)** buttons on the control panel. All the built-in Apps will be shown.

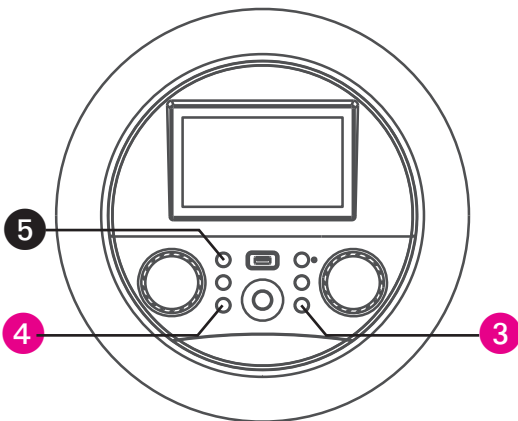

3 Press the **↶ (RETURN)** button on the panel to go back to the previous screen.

4 Press the **🏠 (HOME)** button on the panel to go to the home screen. Press and hold the **🏠 (HOME)** button to go to menu.

5 Press the **⏻ (ON/STANDBY)** button to turn off the unit. The function indicator will turn off.

Operation

Using a Bluetooth Device

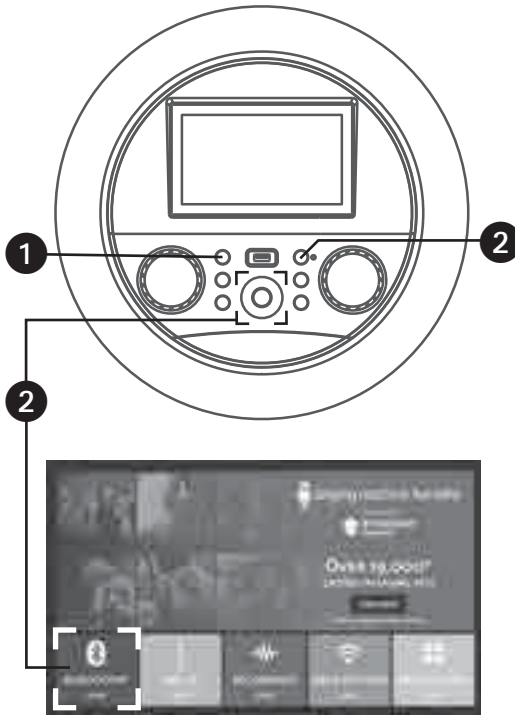

1 Connect the unit as described previously. Press the **⏻ (ON/STANDBY)** button to turn the unit on. The function indicator will light blue.

2 Select **BLUETOOTH** icon using the touch screen or **◀/▶/▲/▼** navigation and **▶|| (PLAY/PAUSE/ENTER)** buttons to enter the bluetooth mode. The unit automatically searches for and pairs a previously paired Bluetooth device (if previously paired). If no previously paired devices are present and/or you want to connect a new device, press and hold the **ⓧ** button; the indicator will flash alternatively blue and red for 60 seconds.

Note: You can also press and hold the **ⓧ** button to disconnect any paired devices in order to pair another device.

3 Turn on your device's Bluetooth option in settings to search for a discoverable device with a Bluetooth signal. Select "**Singing Machine**" from the device results on the Bluetooth menu.

Note: Also refer to the user manual of your Bluetooth device for detailed instructions.

Operation

Using a Bluetooth Device (Continued)

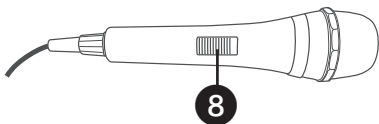
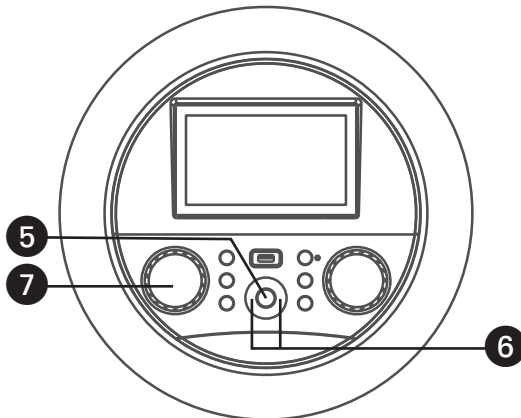
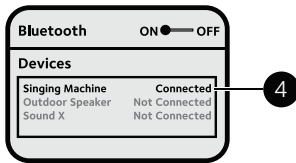
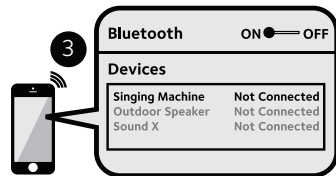

4 The screen will show that your Bluetooth device is connected successfully followed by a paired sound.

Notes:

- If your Bluetooth prompts you for a passcode during the pairing process, please enter "0000" to connect.
- On some Bluetooth devices, once pairing is complete, select your Bluetooth device as "Use as Audio Device" or similar.
- If connection is lost after successful pairing, check to make sure the distance between speaker and Bluetooth enabled device does not exceed 30 feet/10 meters.

5 To control your Bluetooth device from this unit, press the **▶|| (PLAY/PAUSE/ENTER)** button to start playback (music app must be open). Press the **▶|| (PLAY/PAUSE/ENTER)** button during playback to pause the song.

6 **SKIP:** Advance or go back one track by pressing the **◀** or **▶** (Navigation) button.

7 Adjust the **MUSIC VOLUME** control as desired.

8 Connect microphone(s) and slide the **ON/OFF** switch on the microphone to the ON position.

Operation

Using a Bluetooth Device (Continued)

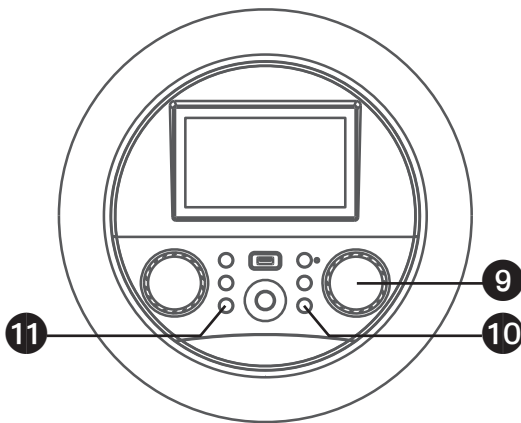

9 Adjust the **MIC/ECHO VOLUME** control as desired. Increasing this control will increase the volume of both microphones. Press then rotate the **MIC/ECHO VOLUME** control as desired to add an echo effect to your voice. Rotate towards MAX to increase the echo.

10 Press the **↶ (RETURN)** button to go back to the previous screen.

11 Press the **🏠 (HOME)** button to go to the home screen from any mode or screen. Press and hold the **🏠 (HOME)** button to go to menu.

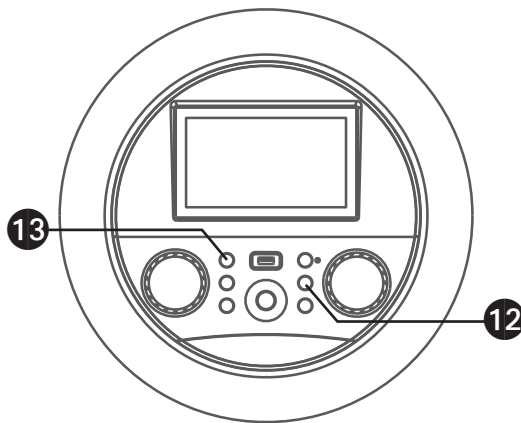

RECORD YOUR VOCAL PERFORMANCE:
12 To record your singing as well as the music, press the **● (RECORD)** button. Recording will begin and the recording indicator will show on-screen and the function indicator will start flashing red. When done recording, press the **● (RECORD)** button again; the function indicator will stop flashing.

Notes:

- You cannot start recording until the USB drive is inserted.
- Insert the USB flash drive into the USB slot on the unit with the face towards the top of the unit.

13 Press the **⏻ (ON/STANDBY)** button to turn off the unit. The function indicator will turn off.

Operation

Using the LINE IN Jack

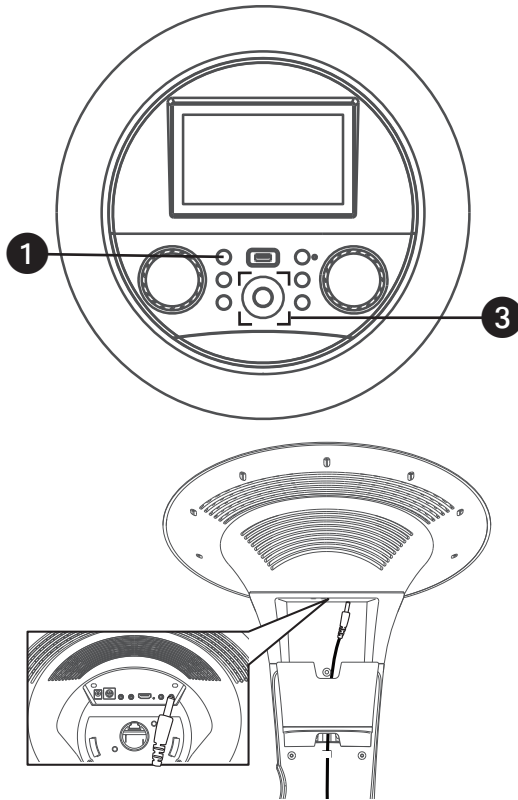

1 Connect the unit as described previously. Press the **⏻ (ON/STANDBY)** button to turn the unit on. The function indicator will light up.

2 Connect the external device by using an appropriate cable (3.5mm audio cable not included) to the **LINE IN Jack** on the rear of this unit as previous described. Connecting an external unit will allow the audio to be played through your Singing Machine.

Notes:

- It is highly recommended to set the volume on the auxiliary unit to 1/3 or lower to avoid distortion.
- Skipping files/tracks is not possible on this unit when using an external device.



3 Select **LINE IN** icon using the touch screen or **◀/▶/▲/▼** navigation and **▶|| (PLAY/PAUSE/ENTER)** buttons to enter the line in mode. The function indicator will light green.

Operation

Using the LINE IN Jack (Continued)

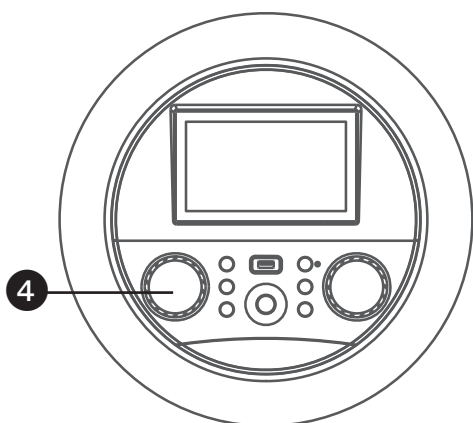

4 Adjust the **MUSIC VOLUME** control as desired.

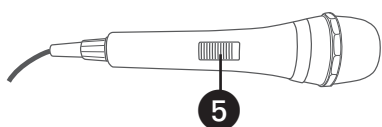

5 Connect microphone(s) and slide the **ON/OFF** switch on the microphone to the ON position.

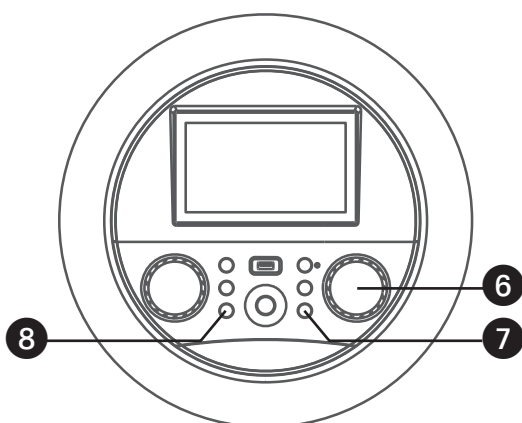

6 Adjust the **MIC/ECHO VOLUME** control as desired. Increasing this control will increase the volume of both microphones. Press then rotate the **MIC/ECHO VOLUME** control as desired to add an echo effect to your voice. Rotate towards MAX to increase the echo.

7 Press the **↩ (RETURN)** button to go back to the previous screen.

8 Press the **🏠 (HOME)** button to go to the home screen from any mode or screen. Press and hold the **🏠 (HOME)** button to go to menu.

Operation

Using the LINE IN Jack (Continued)

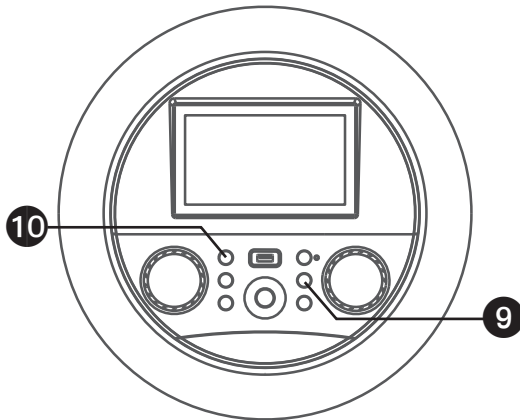

RECORD YOUR VOCAL PERFORMANCE:

- 9** To record your singing as well as the music, press the **● (RECORD)** button. Recording will begin and the recording indicator will show on-screen and the function indicator will start flashing red. When done recording, press the **● (RECORD)** button again; the function indicator will stop flashing.

Notes:

- You cannot start recording until the USB drive is inserted.
- Insert the USB flash drive into the USB slot on the unit with the face towards the top of the unit.

- 10** Press the **⏻ (ON/STANDBY)** button to turn off the unit. The function indicator will turn off.

Operation

Playing Songs from the Recorded Files

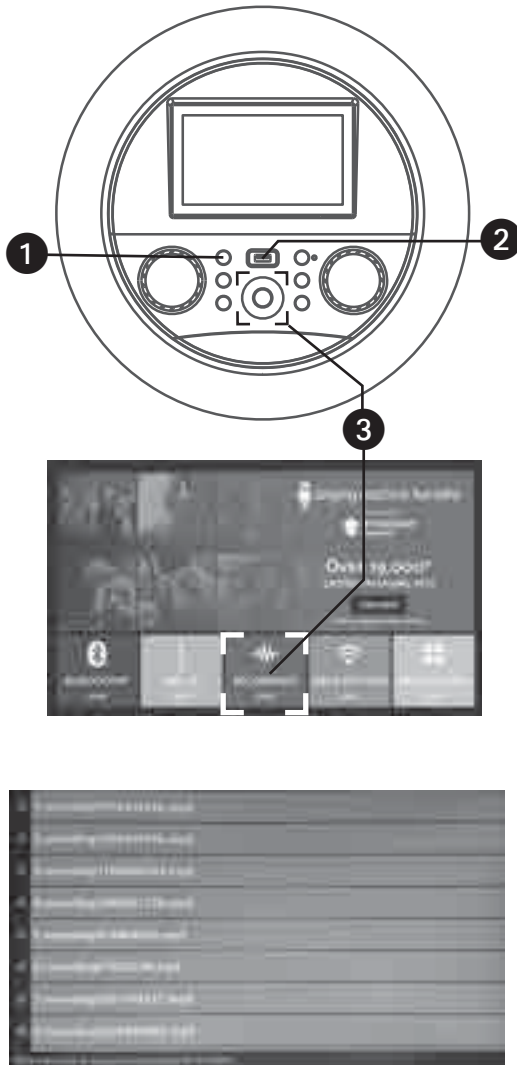

1 Connect the unit as described previously. Press the **⏻ (ON/STANDBY)** button to turn the unit on. The function indicator will light up.

2 Insert a USB flash drive into the USB port on the unit.

3 Select **RECORDINGS** icon using the touch screen or **◀/▶/▲/▼** Navigation and **▶|| (PLAY/PAUSE/ENTER)** buttons to enter. The function indicator will light orange.

4 Select a recorded audio file from the USB drive's song list using the touch screen or **▲/▼** Navigation buttons. Then press the **▶||/ENTER** button on the control panel to start the recorded audio file playback. Press the **▶||/ENTER** button during playback to pause the file.

Note: To delete a file, select and hold it on the touch screen.

Operation

Playing Songs from the Recorded Files (Continued)

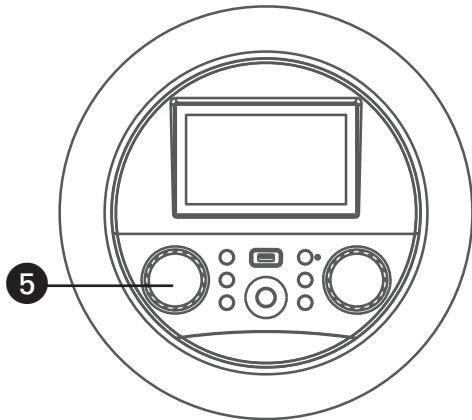

5 Adjust the **MUSIC VOLUME** control as desired.

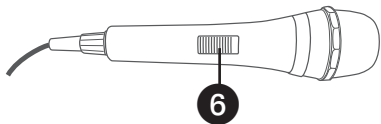

6 Connect microphone(s) and slide the **ON/OFF** switch on the microphone to the ON position.

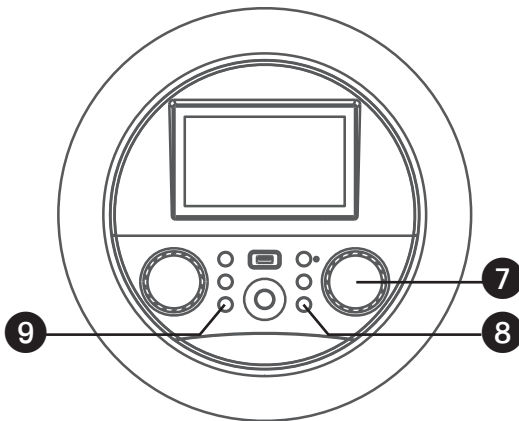

7 Adjust the **MIC/ECHO VOLUME** control as desired. Increasing this control will increase the volume of both microphones. Press then rotate the **MIC/ECHO VOLUME** control as desired to add an echo effect to your voice. Rotate towards **MAX** to increase the echo.

8 Press the **↩ (RETURN)** button to go back to the previous screen.

9 Press the **🏠 (HOME)** button to go to the home screen from any mode or screen. Press and hold the **🏠 (HOME)** button to go to menu.

Operation

Playing Songs from the Recorded Files (Continued)

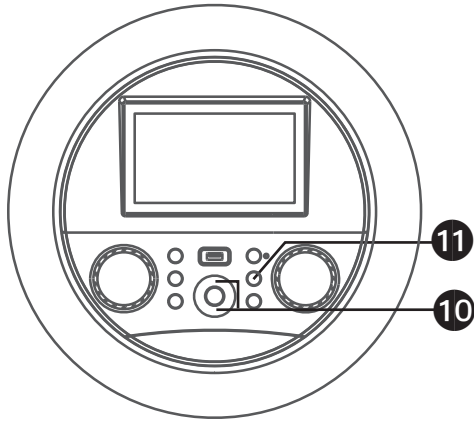

10 SKIP: Advance or go back one track by pressing the ▲ or ▼ (navigation) button.

RECORD YOUR VOCAL PERFORMANCE:

11 To record your singing as well as the music, press the ● (**RECORD**) button. Recording will begin and the recording indicator will display on-screen and the function indicator will begin flashing red. When done recording, press the ● (**RECORD**) button again; the function indicator will stop flashing.

Notes:

- You cannot start recording until the USB drive is inserted.
- Insert the USB flash drive into the USB slot on the unit with the face towards the top of the unit.

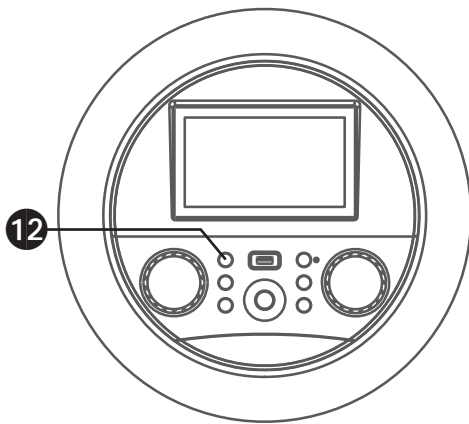

12 Press the ⏻ (**ON/STANDBY**) button to turn off the unit. The function indicator will turn off.

Troubleshooting Guide

Should this unit exhibit a problem, check the following before seeking service:

No Power

- Power is not on; press the **ON/STANDBY** button to turn power on.
- Confirm that the AC adapter is connected securely to the rear of the unit.
- Connect the unit to a different outlet.
- The normal function of the product may be disturbed by strong Electro-Magnetic Interference. If so, simply restart the product to resume normal operation by following the instruction manual. In case the function could not resume, please use the product in another location.

No Sound – General

- Music Volume is set to minimum; raise volume.
- If using an external device, raise the volume.

No sound from the microphone

- Make sure the microphone is firmly connected to the MIC 1 or MIC 2 jack.
- Make sure the mic's **ON/OFF** switch is set to the ON position.
- Make sure the **MIC/ECHO VOLUME** control is not set too low.

File(s) on USB jack not playing

- The file is corrupted; replace the file.
- The file is not in a format this unit will play.
- The connected USB device is not supported by the product.

The Bluetooth device cannot be paired or connected with the unit

- Ensure any other Bluetooth devices are turned off to avoid accidental pairing.
- You have not activated the Bluetooth function of your device; see page E16 or refer to the Bluetooth device user's manual.
- The system is not in pairing mode; press and hold the **Bluetooth** button to restart pairing.

The Music is not available on the unit after successfully connecting the Bluetooth

- Ensure your Bluetooth device can support the A2DP Bluetooth profile.
- The volume on the external Bluetooth device is set too low or muted; raise as desired.

The unit will not record

- No USB drive inserted or the USB drive is full. Move all recordings to your computer to make room.

Failed to connect to the Wifi network

- The unit is not within the WiFi signal range.
- Check that your WiFi frequency is 2.4GHz.
- Ensure you have entered the correct password.

Specifications

AUDIO

Output Power 60 Watts (RMS)

BLUETOOTH

Bluetooth VersionV5.0

Working Distance..... Up to 30 feet/10 meters measured in open space

USB

Format..... FAT32

Maximum Compatibility32GB

Wi-Fi frequency 2.4GHz

GENERAL

Power 100-240V, 50-60Hz

Output DC16.1V 3.5A Positive Center

Dimensions - Main Unit 18.7 x 18.7 x 36.7 inches (47.5 x 47.5 x 93.2cm)

Speaker tower 9.1 x 9.1 x 26.8 inches (23 x 23 x 68cm)

Weight - Main Unit..... 8.7Lbs (4.0kgs)

Microphone..... -74 dB 600 Ohms impedance with 6.3 mm Dynamic Microphone

Line In 3.5mm Stereo Jack

Line Out 3.5mm Stereo Jack

Internal memory 1GB RAM, 8GB flash

Specifications are subject to change without notice.



The terms HDMI and HDMI High-Definition Multimedia Interface, and the HDMI Logo are trademarks or registered trademarks of HDMI Licensing Administrator, Inc. in the United States and other countries.



The Bluetooth® word mark and logos are registered trademarks owned by Bluetooth SIG, Inc. and any use of such marks and logos by The Singing Machine Company, Inc. is under license. Other trademarks and trade names are those of their respective owners.

Visit Our Website: www.singingmachine.com
Visite Nuestra Pagina de Internet: www.singingmachine.com
Visitez notre site Web : www.singingmachine.com

Copyright © 2020 All Rights Reserved.
Derechos de autor © 2020 Todos los derechos reservados.
Droit d'auteur© 2020 - Tous droits réservés.

The Singing Machine Company, Inc.
4060 E Jurupa Street, Unit B
Ontario, CA 91761-1413 USA

U.S. Representative

Company Name : The Singing Machine Company, Inc.
Address : 6301 NW 5th Way, Suite 2900, Fort Lauderdale,
FL33309, USA
Telephone : 954 -596-1000
Website : www.singingmachine.com

PRINTED IN CHINA
IMPRESO EN CHINA
Imprimé en Chine
1080-20xx-ENG01-US