



Shenzhen Certification Technology Service Co., Ltd
2F, Building B, East Area of Nanchang Second Industrial Zone,
Gushu 2nd Road, Bao'an District, Shenzhen 518126, P.R. China.

TEST REPORT

FCC ID: 2AAX4-WSE-JF1

Applicant : Zhejiang Runva Mechanical & Electrical Co., Ltd.
Address : 10F Int'l Trad Bldg, 369 Shuangxi West Road, Jinhua Zhejiang

Equipment under Test (EUT):

Name : WIRELESS REMOTE
Model : WSE-JF1+WSR1

Standards : FCC PART 15, SUBPART C : 2012 (Section 15.231)

Report No. : STI130724120
Date of Test : March 3-10, 2014
Date of Issue : March 11, 2014

Test Result :	PASS *
----------------------	---------------

* In the configuration tested, the EUT complied with the standards specified above

Authorized Signature

(Mark Zhu)
General Manager

The manufacture should ensure that all the products in series production are in conformity with the product sample detailed in this report.

If the product in this report is used in any configuration other than that detailed in the report, the manufacturer must ensure the new system complies with all relevant standards. Any mention of Shenzhen Certification Technology Service Co., Ltd. Or test done by Shenzhen Certification Technology Service Co., Ltd. Approvals in connection with, distribution or use of the product described in this report must be approved by Shenzhen Certification Technology Service Co., Ltd. Approvals in writing.

TABLE OF CONTENT

Description	Page
1 General Information-----	3
1.1 Description of Device (EUT) -----	3
1.2 Description of Test Facility -----	3
2 EMC Equipment List -----	4
3 Test Procedure -----	5
4 Summary of Measurement-----	6
4.1 Summary of test result -----	6
4.2 Block Diagram -----	6
4.3 Assistant equipment used for test -----	6
4.4 Test Conditions -----	7
4.5 Measurement Uncertainty (95% confidence levels, k=2)-----	7
5 Radiation Emission -----	8
5.1 Radiation Emission Limits(15.209&231)-----	8
5.2 Test Setup-----	8
5.3 Test Procedure -----	10
5.4 Test Equipment Setting For emission test.-----	11
5.5 Test Condition -----	11
5.6 Test Result-----	11
6 POWER LINE CONDUCTED EMISSION -----	17
6.1 Conducted Emission Limits(15.209) -----	17
6.2 Test Setup-----	17
6.3 Test Procedure -----	18
6.4 Test Results-----	18
7 Occupied bandwidth-----	19
7.1 Test limit-----	19
7.2 Method of measurement -----	19
7.3 Test Setup-----	19
7.4 Test Results-----	19
8 Transmission time-----	21
8.1 Test limit-----	21
8.2 Method of measurement -----	21
8.3 Test Setup-----	21
8.4 Test Results-----	21
9 Band Edge Check-----	23
9.1 Test limit-----	23
9.2 Test Procedure -----	23
9.3 Test Setup-----	23
9.4 Test Result-----	23
10 Antenna Requirement -----	24
10.1 Standard Requirement -----	24
10.2 Antenna Connected Construction -----	24
10.3 Result-----	24
11 Photographs of Test Setup -----	25
12 Photographs of EUT -----	26

1 General Information

1.1 Description of Device (EUT)

Trade Name : N/A

EUT : WIRELESS REMOTE

Model No. : WSE-JF1+WSR1

Type of Antenna : PCB antenna, Max Gain 0dBi.

Operation Frequency : 315 MHz

Channel number : 1

Modulation type : FSK

Power Supply : DC 3V Supply by battery

Rated PF
output Power : 71.93 dBuV (Peak detector)

Applicant : Zhejiang Runva Meachanical & Electrial Co., Ltd.

Address : 10F Int'l Trad Bldg, 369 Shuangxi West Road, Jinhua Zhejiang

Manufacturer : Zhejiang Runva Meachanical & Electrial Co., Ltd.

Address : No.1 Jin Long Road, Jinhua, Zhejiang

1.2 Description of Test Facility

Shenzhen Certification Technology Service Co., Ltd.
2F, Building B, East Area of Nanchang Second Industrial Zone,
Gushu 2nd Road, Bao'an District, Shenzhen 518126, P.R. China
FCC Registered No.:197647

2 EMC Equipment List

Equipment	Manufacture	Model No.	Serial No.	Last cal.	Cal Interval
3m Semi-Anechoic	ETS-LINDGREN	N/A	SEL0017	Nov 16, 13	1Year
Spectrum analyzer	Agilent	E4407B	MY49510055	Oct. 31, 13	1Year
Receiver	R&S	ESCI	101202	Oct. 31, 13	1Year
Bilog Antenna	SCHWARZBECK	VULB 9168	9168-438	Mar.12, 13	1Year
Horn Antenna	SCHWARZBECK	BBHA 9120 D	BBHA 9120 D(1201)	Mar.12, 13	1Year
Active Loop Antenna	Beijing Daze	ZN30900A	SEL0097	Mar.12, 13	1Year
Pre-amplifier	SCHWARZBECK	BBV9743	9743-019	Oct. 31, 13	1Year
Pre-amplifier	Quietek	AP-180C	CHM-0602012	Oct. 31, 13	1Year

3 Test Procedure

POWER LINE CONDUCTED INTERFERENCE: The test procedure used was ANSI Standard C63.4-2003 using a 50 u H LISN. Both Lines were observed. The bandwidth of the receiver was 10kHz with an appropriate sweep speed. The ambient temperature of the EUT was 25°C with a humidity of 58%.

RADIATION INTERFERENCE: The test procedure used was ANSI Standard C63.4-2003 using a ANRITSU spectrum analyzer with a pre-selector. The analyzer was calibrated in dB above a micro volt at the output of the antenna. The resolution bandwidth was 100kHz and the video bandwidth was 300 kHz up to 1 GHz and 1 MHz with a video BW of 3MHz above 1 GHz. The ambient temperature of the EUT was 25°C with a humidity of 58%.

FORMULA OF CONVERSION FACTORS: The Field Strength at 3m was established by adding the meter reading of the spectrum analyzer (which is set to read in units of dBuV) to the antenna correction factor supplied by the antenna manufacturer and cable loss. The antenna correction factors and cable loss are stated in terms of dB. The gain of the Pre-selector was accounted for in the Spectrum Analyzer Meter Reading.

Example:

Freq (MHz) METER READING + ACF + CABLE = FS

33.20 dBuV + 10.36 dB + 0.9 dB= 44.46 dBuV/m @ 3m

ANSI STANDARD C63.4-2003 10.1.7 MEASUREMENT PROCEDURES: The EUT was placed on a table 80 cm high and with dimensions of 1m by 1.5m. The EUT was placed in the center of the table (1.5m side). The table used for radiated measurements is capable of continuous rotation. When an emission was found, the table was rotated to produce the maximum signal strength. At this point, the antenna was raised and lowered from 1m to 4m. The antenna was placed in both the horizontal and vertical planes. The situation was similar for the conducted measurement except that the table did not rotate. The EUT was setup as described in ANSI Standard C63.4-2003 10.1.7 with the EUT 40 cm from the vertical ground wall.

4 Summary of Measurement

4.1 Summary of test result

Test Item	Test Requirement	Standard Paragraph	Result
Spurious Emission	FCC PART 15: 2012	Section 15.231&15.209	Compliance
Conduction Emission	FCC PART 15: 2012	Section 15.207	Not applicable
Occupied bandwidth	FCC PART 15: 2012	Section 15.231	Compliance
Transmission time	FCC PART 15: 2012	Section 15.231	Compliance
Band Edge	FCC PART 15: 2012	Section 15.231	Not applicable
Antenna Requirement	FCC PART 15 : 2012	Section 15.203	Compliance

Note: 1. All buttons of the EUT have been tested and only worst case reported. The EUT has been tested as an independent unit. And Continual Transmitting in maximum power (The new battery be used during Test)

2. we also estimated location of the XYZ 3 axis, the X axis is the worst mode.

4.2 Block Diagram



4.3 Assistant equipment used for test

Description : N/A
 Manufacturer : N/A
 Model No. : N/A

4.4 Test Conditions

Temperature range	21-25°C
Humidity range	40-75%
Pressure range	86-106kPa

4.5 Measurement Uncertainty (95% confidence levels, k=2)

Item	MU	Remark
Uncertainty for Power point Conducted Emissions Test	2.50dB	
Uncertainty for Radiation Emission test in 3m chamber (below 30MHz)	2.13 dB	Polarize: V
	2.57dB	Polarize: H
Uncertainty for Radiation Emission test in 3m chamber (30MHz to 1GHz)	3.04dB	Polarize: V
	3.02dB	Polarize: H
Uncertainty for Radiation Emission test in 3m chamber (1GHz to 25GHz)	3.84dB	Polarize: H
	3.56dB	Polarize: V
Uncertainty for radio frequency	1×10^{-9}	
Uncertainty for temperature	0.2°C	
Uncertainty for humidity	3%	
Uncertainty for DC and low frequency voltages	0.06%	

5 Radiation Emission

5.1 Radiation Emission Limits(15.209&231)

Frequency (MHz)	Field Strength Limits at 3 metres (watts, e.i.r.p.)		
	uV/m	dB uV/m	Measurement distance(m)
0.009-0.490	2400/F(kHz)	XX	300
0.490-1.705	24000/F(kHz)	XX	30
1.705-30	30	29.5	30
30~88	100(3nW)	40	3
88~216	150(6.8nW)	43.5	3
216~960	200(12nW)	46	3
Above960	500(75nW)	54	3
Carrier frequency		75.62(AV)	3
Carrier frequency		95.62(PK)	3

NOTE:

- The tighter limit applies at the band edges.
- Emission Level(dB uV/m)=20log Emission Level(Uv/m)

5.2 Test Setup

See the next page.

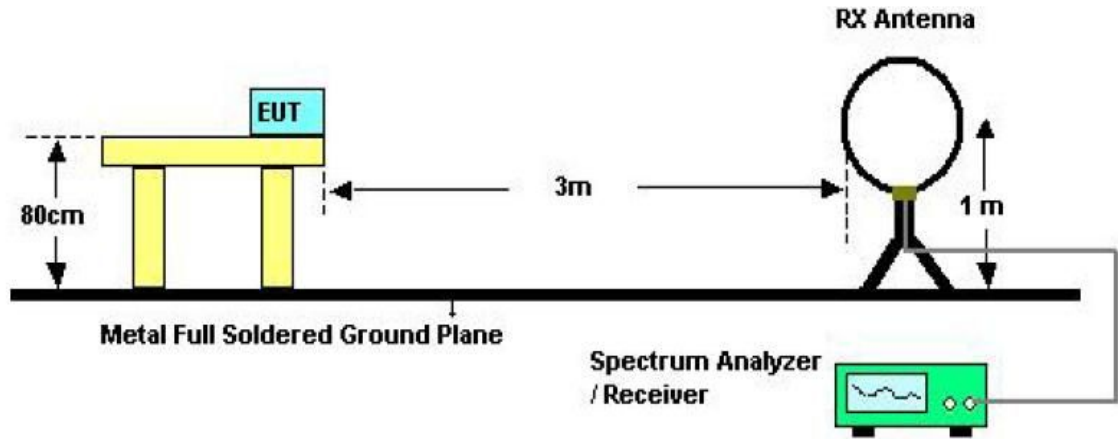

Below 30MHz Test Setup

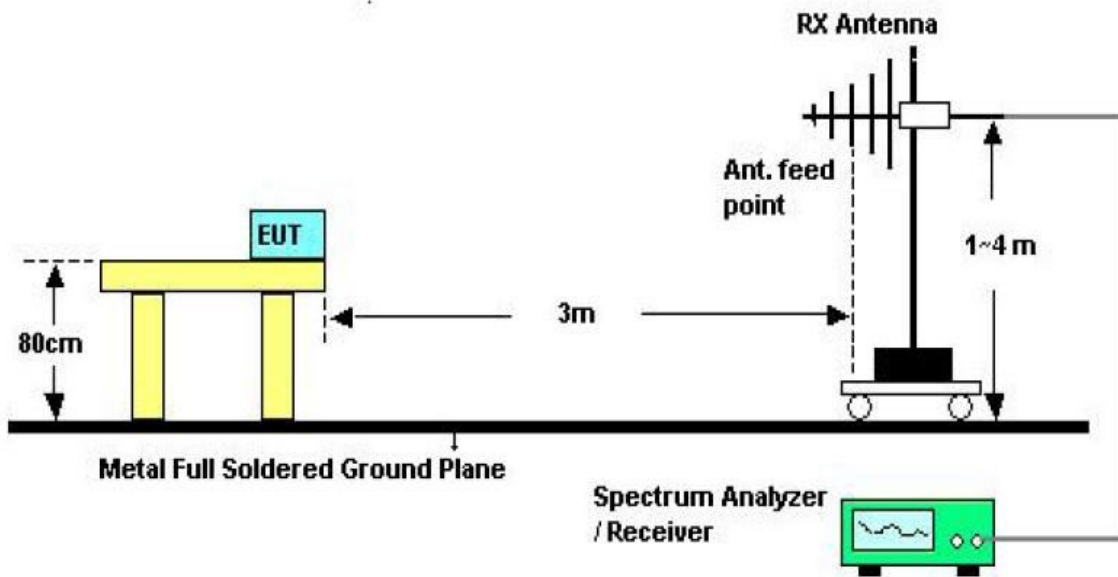

Above 30MHz Test Setup

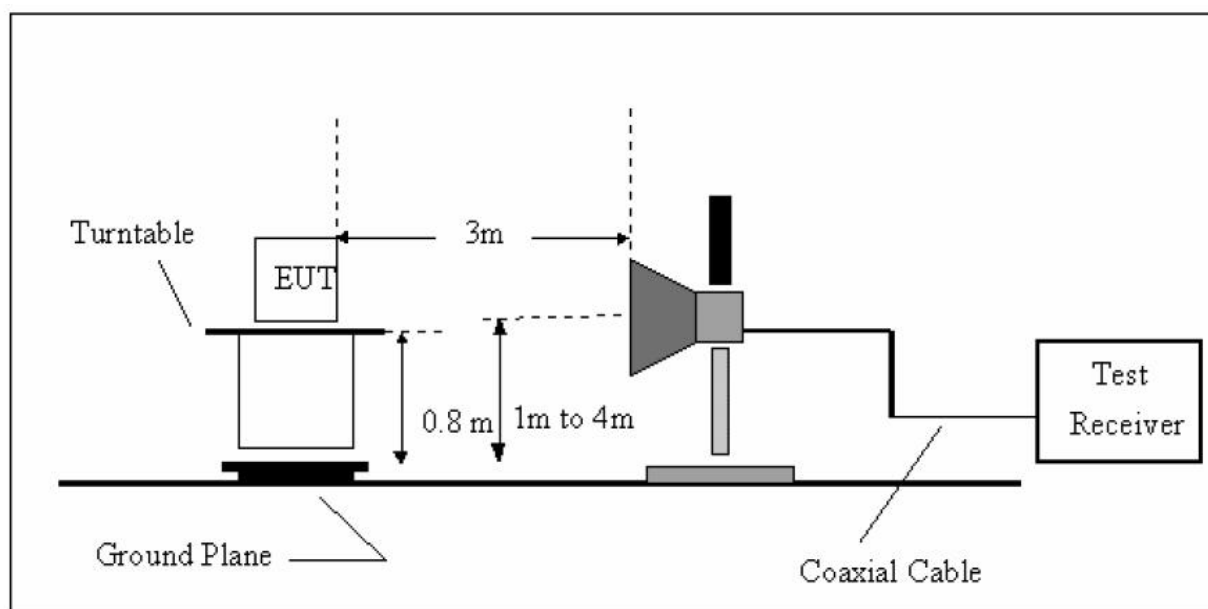

Above 1GHz Test Setup

5.3 Test Procedure

- a) The measuring distance of 3m shall be used for measurements at frequency up to 1GHz and above 1GHz, The EUT was placed on a rotating 0.8 m high above ground, The table was rotated 360 degrees to determine the position of the highest radiation
- b) The Test antenna shall vary between 1m and 4m, Both Horizontal and Vertical antenna are set to make measurement.
- c) The initial step in collecting conducted emission data is a spectrum analyzer Peak detector mode pre-scanning the measurement frequency range. Significant Peaks are then marked. and then Quasi Peak Detector mode remeasured
- d) If Peak value comply with QP limit Below 1GHz. The EUT deemed to comply with QP limit. But the Peak value and average value both need to comply with applicable limit above 1GHz.
- e) For the actual test configuration, please see the test setup photo.

5.4 Test Equipment Setting For emission test.

9KHz~150KHz	RBW 200Hz	VBW1KHz
150KHz~30MHz	RBW 9KHz	VBW 30KHz
30MHz~1GHz	RBW 120KHz	VBW 300KHz
Above 1GHz	RBW 1MHz	VBW 3MHz

5.5 Test Condition

Continual Transmitting in maximum power(The new battery be used during Test)

5.6 Test Result

We have scanned the 10th harmonic from 9KHz to the EUT.
Detailed information please see the following page.

From 9KHz to 30MHz: Conclusion: **PASS**

Note: The amplitude of spurious emissions which are attenuated by more than 20dB below the permissible value has no need to be reported.



Shenzhen Certification Technology Service Co., Ltd.
 2F, Building B, East Area of Nanchang Second Industrial Zone,
 Gushu 2nd Road, Bao'an District, Shenzhen 518126, P.R. China
 Tel: 4006786199 FAX: +86-755-26736857
 Website: <http://www.cessz.com> Email: Service@cessz.com

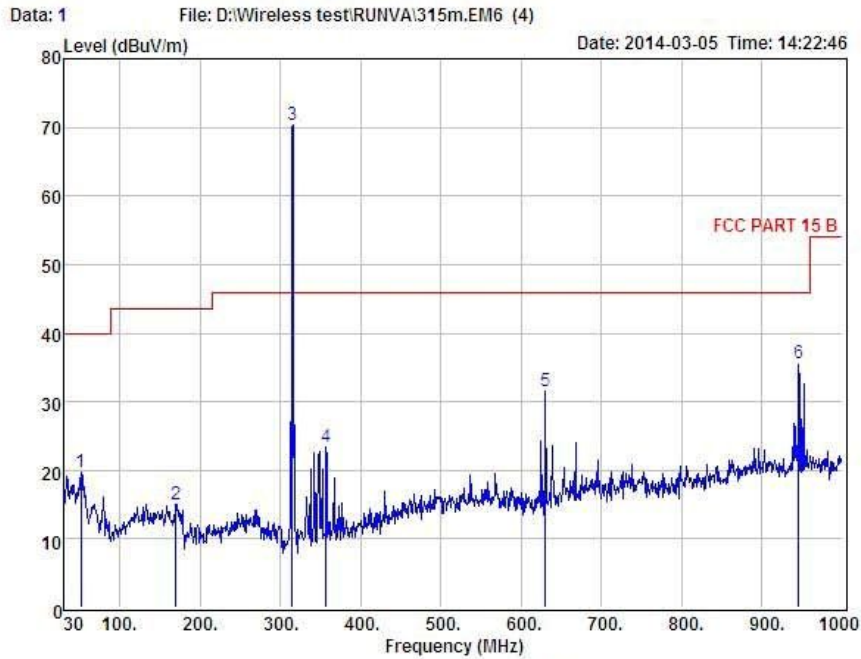

Condition : FCC PART 15 B 3m POL: HORIZONTAL
 EUT : WIRELESS REMOTE
 Model No : WSE-JF1+WAR1
 Test Mode : TX 315MHz
 Power : DC 3V from battery
 Test Engineer : Simple
 Remark :
 Temp : 25.2°C
 Hum : 56%

Item	Freq MHz	Read Level dBuV	Antenna Factor dB	Preamp Factor dB	Cable Loss dB	Level dBuV	Limit dBuV	Margin dBuV	Remark
1	51.34	34.00	13.38	27.83	0.25	19.80	40.00	-20.20	Peak
2	169.68	28.12	13.18	26.92	0.59	14.97	43.50	-28.53	Peak
3	315.00	83.76	13.19	27.22	0.37	70.30			
4	356.89	35.99	13.95	27.29	0.66	23.31	46.00	-22.69	Peak
5	630.43	39.59	18.85	27.82	0.96	31.58	46.00	-14.42	Peak
6	945.68	39.74	22.11	27.62	1.29	35.52	46.00	-10.48	Peak

Remark: Level = Read Level + Antenna Factor - Preamp Factor + Cable Loss



Shenzhen Certification Technology Service Co., Ltd.
 2F, Building B, East Area of Nanchang Second Industrial Zone,
 Gushu 2nd Road, Bao'an District, Shenzhen 518126, P.R. China
 Tel: 4006786199 FAX: +86-755-26736857
 Website: <http://www.cessz.com> Email: Service@cessz.com

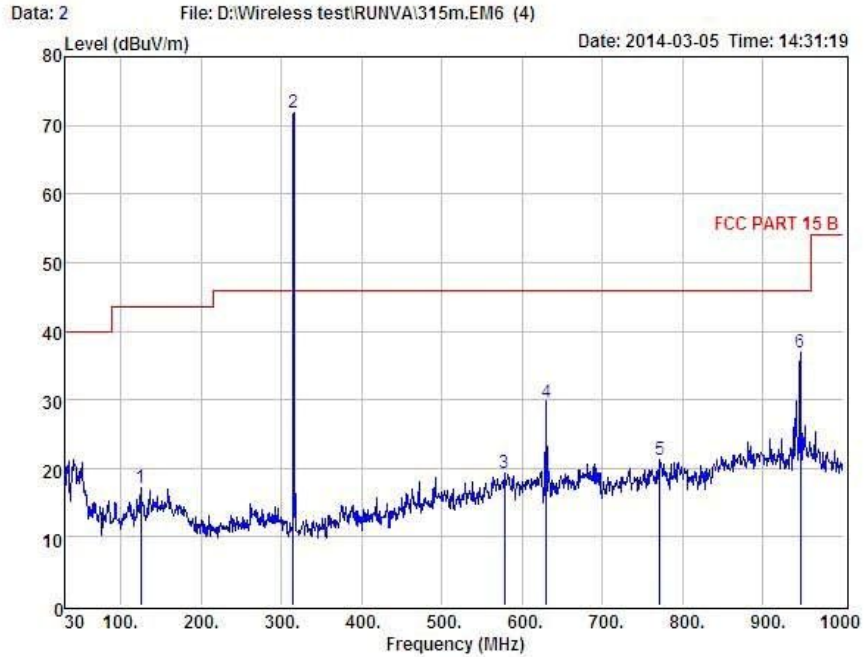

Condition : FCC PART 15 B 3m POL: VERTICAL
 EUT : WIRELESS REMOTE
 Model No : WSE-JF1+WAR1
 Test Mode : TX 315MHz
 Power : DC 3V from battery
 Test Engineer : Simple
 Remark :
 Temp : 25.2°C
 Hum : 56%

Item	Freq MHz	Read Level dBuV	Antenna Factor dB	Preamp Factor dB	Cable Loss dB	Level dBuV	Limit dBuV	Margin dBuV	Remark
1	125.06	31.23	12.46	26.88	0.28	17.09	43.50	-26.41	Peak
2	315.00	88.39	13.19	27.22	0.57	71.93			
3	578.05	27.99	17.89	27.77	1.15	19.26	46.00	-26.74	Peak
4	630.43	37.65	18.85	27.82	0.96	29.64	46.00	-16.36	Peak
5	771.08	27.23	20.50	27.67	1.23	21.29	46.00	-24.71	Peak
6	946.65	40.96	22.11	27.62	1.36	36.81	46.00	-9.19	Peak

Remark: Level = Read Level + Antenna Factor - Preamp Factor + Cable Loss



Shenzhen Certification Technology Service Co., Ltd.
 2F, Building B, East Area of Nanchang Second Industrial Zone,
 Gushu 2nd Road, Bao'an District, Shenzhen 518126, P.R. China
 Tel: 4006786199 FAX: +86-755-26736857
 Website: <http://www.cessz.com> Email: Service@cessz.com

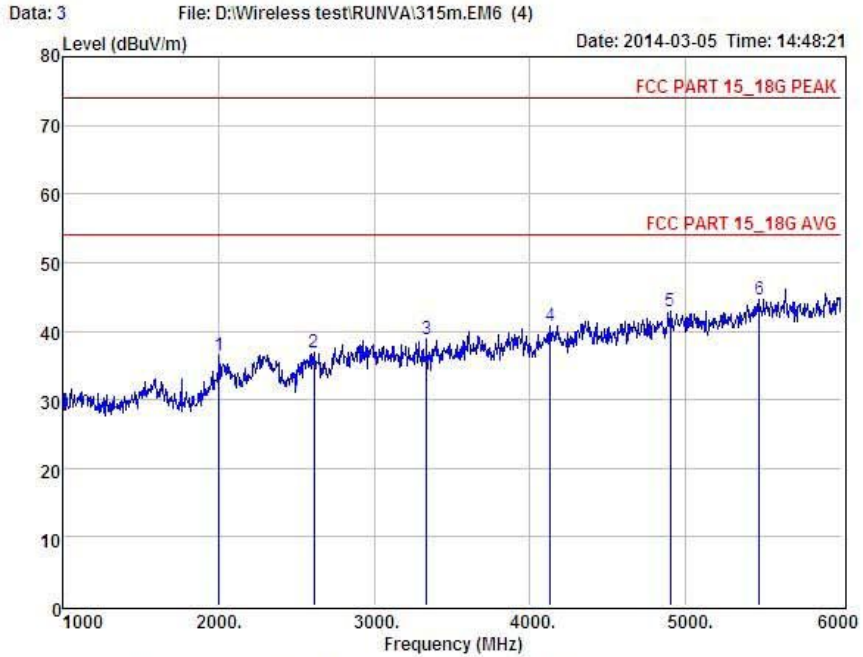

Condition : FCC PART 15_18G PEAK 3m POL: HORIZONTAL
 EUT : WIRELESS REMOTE
 Model No : WSE-JF1+WAR1
 Test Mode : TX 315MHz
 Power : DC 3V from battery
 Test Engineer : Simple
 Remark :
 Temp : 25.2°C
 Hum : 56%

Item	Freq MHz	Read Level dBuV	Antenna Factor dB	Preamp Factor dB	Cable Loss dB	Level dBuV	Limit dBuV	Margin dBuV	Remark
1	2005.00	41.85	25.89	34.94	3.61	36.41	74.00	-37.59	Peak
2	2615.00	39.98	27.77	34.98	4.12	36.89	74.00	-37.11	Peak
3	3335.00	41.18	27.84	34.93	4.71	38.80	74.00	-35.20	Peak
4	4130.00	40.23	29.89	34.64	5.26	40.74	74.00	-33.26	Peak
5	4900.00	39.89	31.41	34.12	5.76	42.94	74.00	-31.06	Peak
6	5475.00	40.31	31.84	33.63	6.12	44.64	74.00	-29.36	Peak

Remark: Level = Read Level + Antenna Factor - Preamp Factor + Cable Loss



Shenzhen Certification Technology Service Co., Ltd.
 2F, Building B, East Area of Nanchang Second Industrial Zone,
 Gushu 2nd Road, Bao'an District, Shenzhen 518126, P.R. China
 Tel: 4006786199 FAX: +86-755-26736857
 Website: <http://www.cessz.com> Email: Service@cessz.com

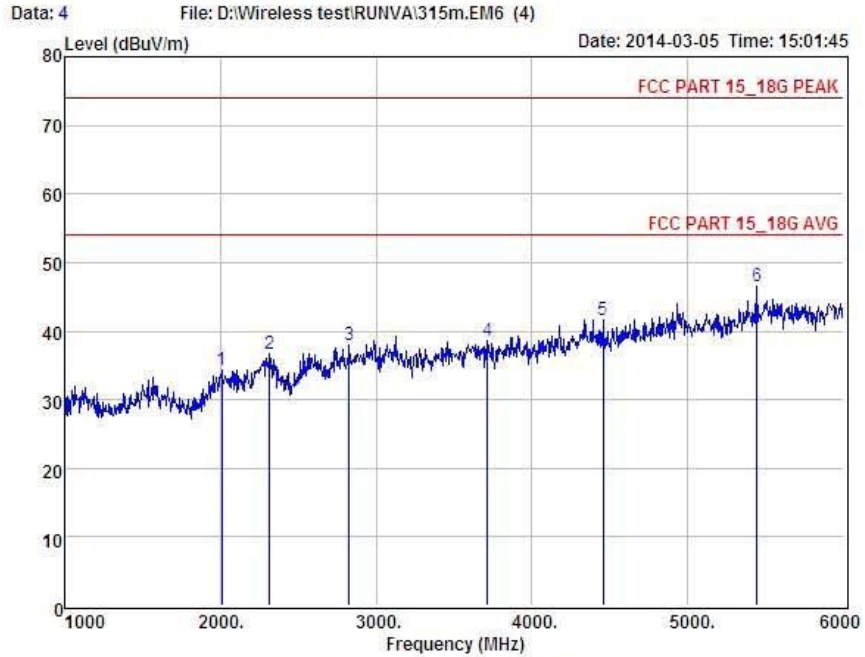

Condition : FCC PART 15_18G PEAK 3m POL: VERTICAL
 EUT : WIRELESS REMOTE
 Model No : WSE-JF1+WAR1
 Test Mode : TX 315MHz
 Power : DC 3V from battery
 Test Engineer : Simple
 Remark :
 Temp : 25.2°C
 Hum : 56%

Item	Freq MHz	Read Level dBuV	Antenna Factor dB	Preamp Factor dB	Cable Loss dB	Level dBuV	Limit dBuV	Margin dBuV	Remark
1	2010.00	39.82	25.89	34.94	3.61	34.38	74.00	-39.62	Peak
2	2315.00	40.08	27.77	34.96	3.87	36.76	74.00	-37.24	Peak
3	2825.00	40.64	27.92	34.98	4.28	37.86	74.00	-36.14	Peak
4	3715.00	39.50	28.93	34.83	5.00	38.60	74.00	-35.40	Peak
5	4455.00	40.20	30.50	34.47	5.47	41.70	74.00	-32.30	Peak
6	5445.00	42.28	31.79	33.66	6.10	46.51	74.00	-27.49	Peak

Remark: Level = Read Level + Antenna Factor - Preamp Factor + Cable Loss

Radiated Emissions Result of Inside band (315MHz)

EUT	WIRELESS REMOTE	Model Name	WSE-JF1+WSR1
Temperature	25°C	Relative Humidity	56%
Pressure	960hPa	Test voltage	DC 3V Supply by battery
Test Mode	TX	Antenna polarization	Horizontal/Vertical

Channel (315MHz)									
Fre. MHz	Plority H/V	Reading dBuV	Antenna Factor dB	Cable Loss dB	Amplifier Gain dB	Correct Factor dB	Measure Result dBuV/m	Limit dBuV/m	Margin dB
315	H	83.76 (PK)	13.19	0.25	27.22	-13.46	70.30	95.62 (PK)	-25.32
315	H	83.76 (PK)	13.19	0.25	27.22	-13.46	70.30	75.62 (AV)	-5.32
--	H	--	--	--	--	--	--	--	--
315	V	85.39 (PK)	13.19	0.25	27.22	-13.46	71.93	95.62 (PK)	-23.69
315	V	85.39 (PK)	13.19	0.25	27.22	-13.46	71.93	75.62 (AV)	-3.69
--	V	--	--	--	--	--	--	--	--

Notes: 1 --Means other frequency and mode comply with standard requirements and at least have 20dB margin.

Correct Factor=Cable Loss+Antenna Factor-Amplifier Gain

Measurement Result=Reading + Correct Factor

Margin=Measurement Result-Limit

2 -Spectrum setting:

a. Peak setting 30MHz-1GHz, RBW=120KHz,VBW=300KHz.

b. AV setting 30MHz-1GHz, RBW=1MHz,VBW=10Hz.

6 POWER LINE CONDUCTED EMISSION

6.1 Conducted Emission Limits(15.209)

Frequency MHz	Limits dB(μ V)	
	Quasi-peak Level	Average Level
0.15 -0.50	66 -56*	56 - 46*
0.50 -5.00	56	46
5.00 -30.00	60	50

- Notes: 1. *Decreasing linearly with logarithm of frequency.
 2. The lower limit shall apply at the transition frequencies.

3.The limit decreases in line with the logarithm of the frequency in the rang of 0.15 to 0.50 MHz.

6.2 Test Setup

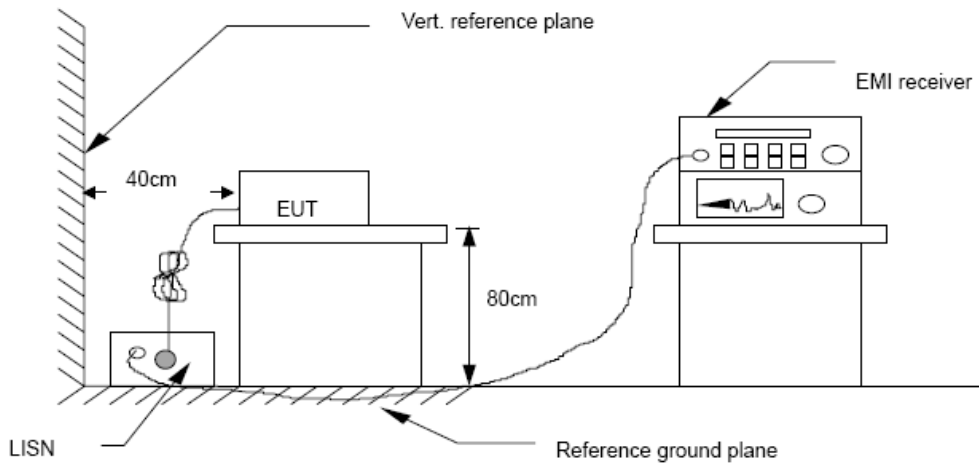

6.3 Test Procedure

The EUT is put on the plane 0.8m high above the ground by insulating support and is connected to the power mains through a line impedance stabilization network (L.I.S.N.). This provides a 50ohm coupling impedance for the EUT system. Please refer the block diagram of the test setup and photographs. Both sides of AC lines are checked to find out the maximum conducted emission. In order to find the maximum emission levels, the relative positions of equipment and all of the interface cables shall be changed according to ANSI C63.4-2003 on Conducted Emission Measurement.

The bandwidth of test receiver (R & S ESCS30) is set at 9 kHz.

6.4 Test Results

EUT power supply by battery, so the test not applicable.

7 Occupied bandwidth

7.1 Test limit

Please refer section 15.231

According to §15.231(C), The bandwidth of the emission shall be no wider than 0.25% of the center frequency for devices operating above 70MHz and below 900MHz.

7.2 Method of measurement

- a) The bandwidth is measured at an amplitude level reduced 20dB from the reference level. The reference level is the level of the highest amplitude signal observed from the transmitter at the fundamental frequency. Once the reference level is established, the equipment is conditioned with typical modulating signal to produce the worst-case (i.e. the widest) bandwidth.
- b) The test receiver RBW set 30KHz, VBW set 30KHz, Sweep time set auto.

7.3 Test Setup

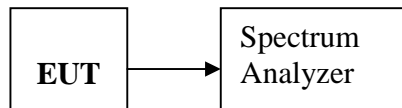

7.4 Test Results

PASS.

Detailed information please see the following page.

Frequency	Test Result	Limit	Result
315MHz	110KHz	<0.78MHz	Pass

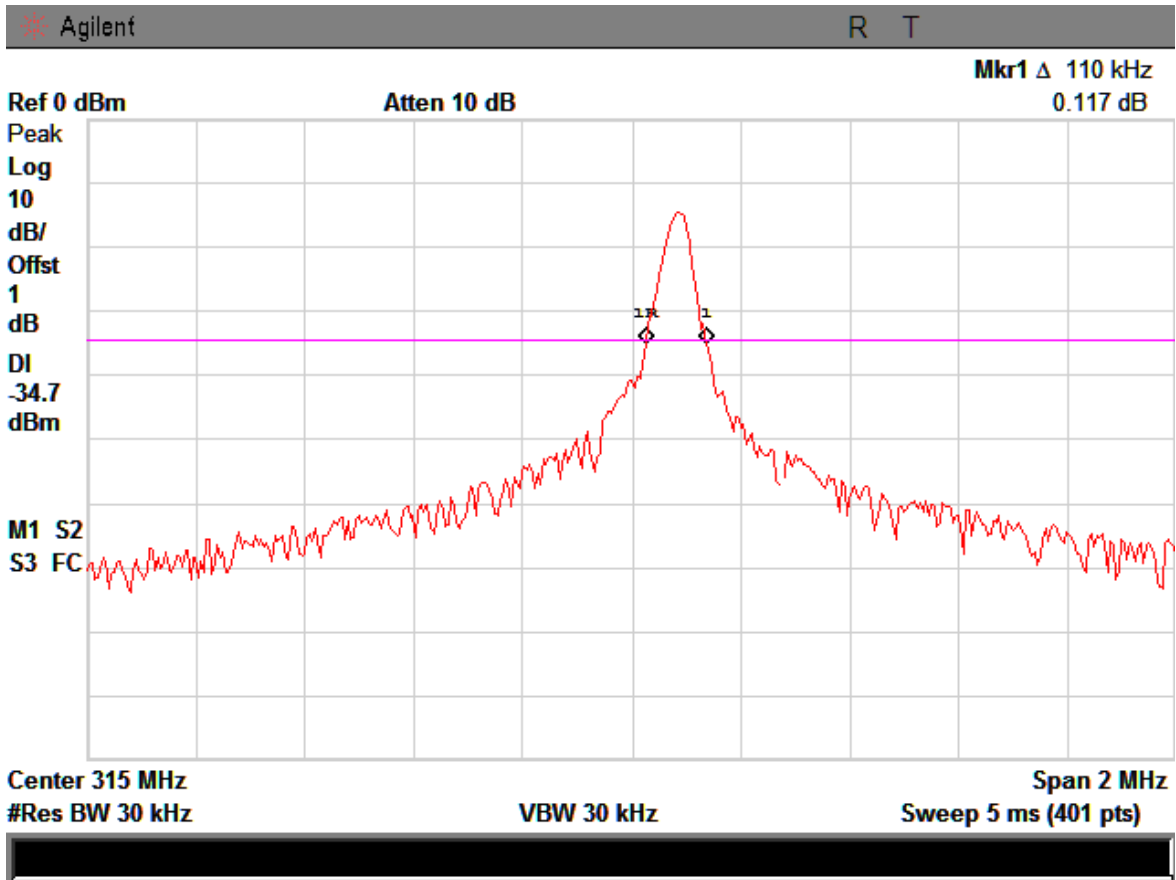

8 Transmission time

8.1 Test limit

Please refer section 15.231

According to §15.231(a)(1), A manually operated transmitter shall employ a switch that will automatically deactivate the transmitter within not more than 5 seconds of being released.

According to §15.231(a)(2), A transmitter activated automatically shall cease transmission within 5 seconds after activation.

8.2 Method of measurement

7.2.1. Place the EUT on the table and set it in transmitting mode.

7.2.2. Remove the antenna from the EUT and then connect a low loss RF cable from the antenna port to the spectrum analyzer.

7.2.3. Set spectrum analyzer Center=433.9MHz, Span = 0MHz, Sweep = 200ms.

7.2.4. Set the spectrum analyzer as RBW, VBW=1MHz,

7.2.5. Max hold, view and count how many channel in the band.

8.3 Test Setup

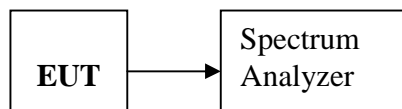

8.4 Test Results

PASS.

Detailed information please see the following page.

Frequency	Test Result	Limit	Result
433.92MHz	0.825s	< 5s	Pass

After Release the button, EUT emission Continue 0.825 seconds

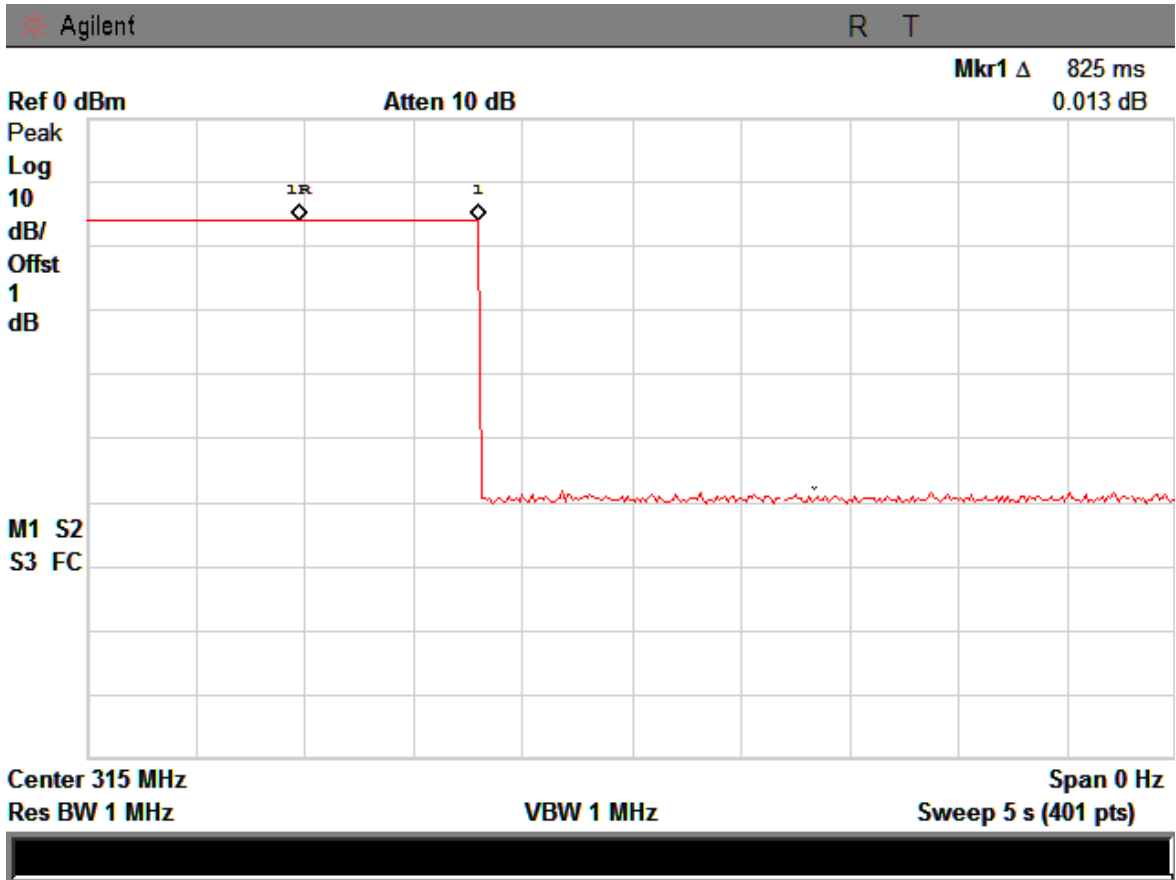

9 Band Edge Check

9.1 Test limit

Please refer section 15.231 and section 15.205.

Emissions radiated outside of the specified frequency bands, except for harmonics, shall be attenuated by at least 50 dB below the level of the fundamental or to the general radiated emission limits in Section 15.209, whichever is the lesser attenuation.

9.2 Test Procedure

- 11.2.1 Put the EUT on a 0.8m high table, power on the EUT. Emissions were scanned and measured rotating the EUT to 360 degrees, Find the maximum Emission
- 11.2.2 Turning to Low and High frequency, then reduced 50dB from the reference level. The reference level is the level of the highest amplitude signal observed from the transmitter at the fundamental frequency.
- 11.2.3 Check the spurious emissions out of band.
- 11.2.4 RBW, VBW Setting, please see the following test plot.

9.3 Test Setup

Same to 5.2

9.4 Test Result

The Restricted bands is 240-265MHz and 322-335.4MHz, The EUT operation frequency is 315MHz and the Occupied bandwidth is 110KHz, so the test is not applicable.

10 Antenna Requirement

10.1 Standard Requirement

An intentional radiator shall be designed to ensure that no antenna other than that furnished by the responsible party shall be used with the device. The use of a permanently attached antenna or of an antenna that uses a unique coupling to the intentional radiator shall be considered sufficient to comply with the provisions of this Section. The manufacturer may design the unit so that a broken antenna can be replaced by the user, but the use of a standard antenna jack or electrical connector is prohibited.

10.2 Antenna Connected Construction

The directional gains of antenna used for transmitting is 0 dBi, and the antenna connector is designed with permanent attachment and no consideration of replacement. Please see EUT photo for details.

10.3 Result

The EUT antenna is PCB antenna, So it comply with the standard requirement.

11 Photographs of Test Setup

Photographs-Radiated Emission Test Setup in Chamber

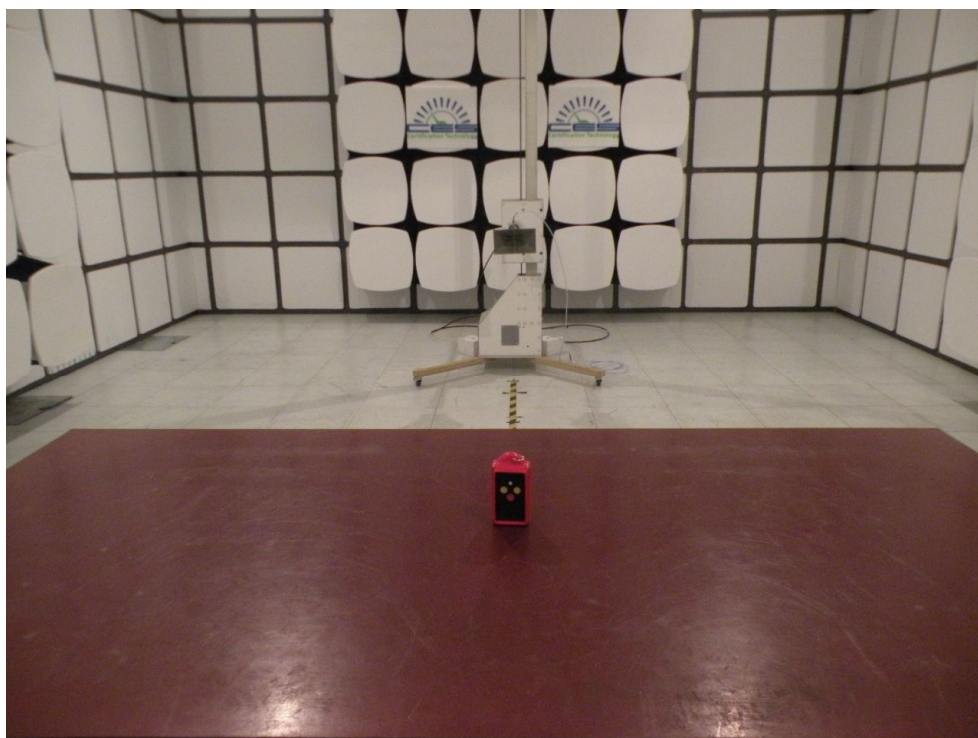
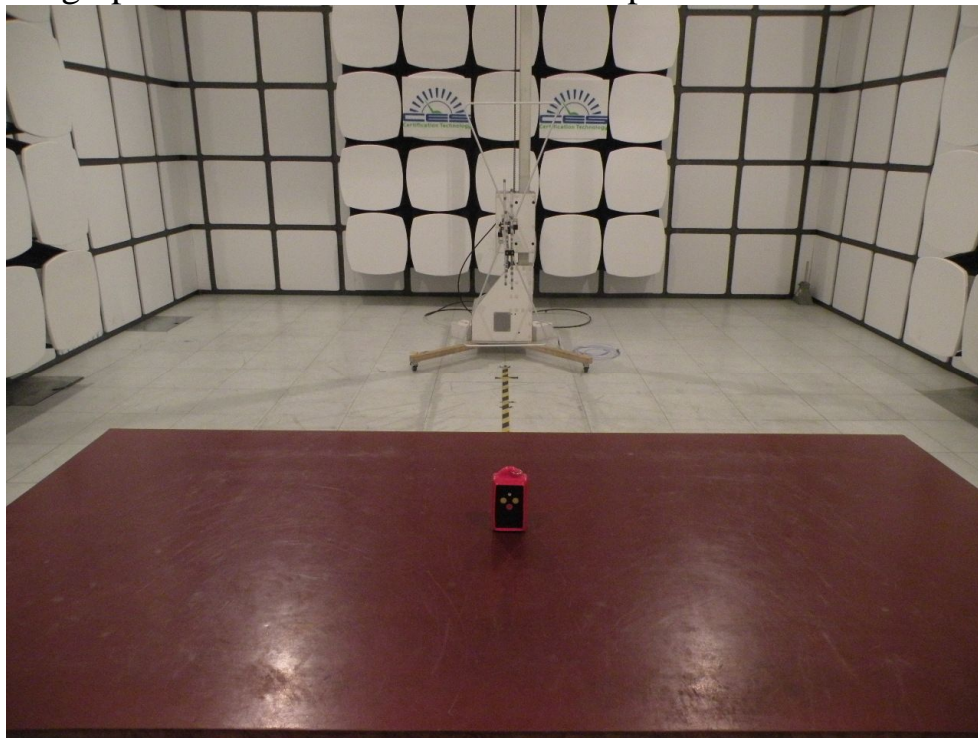

12 Photographs of EUT







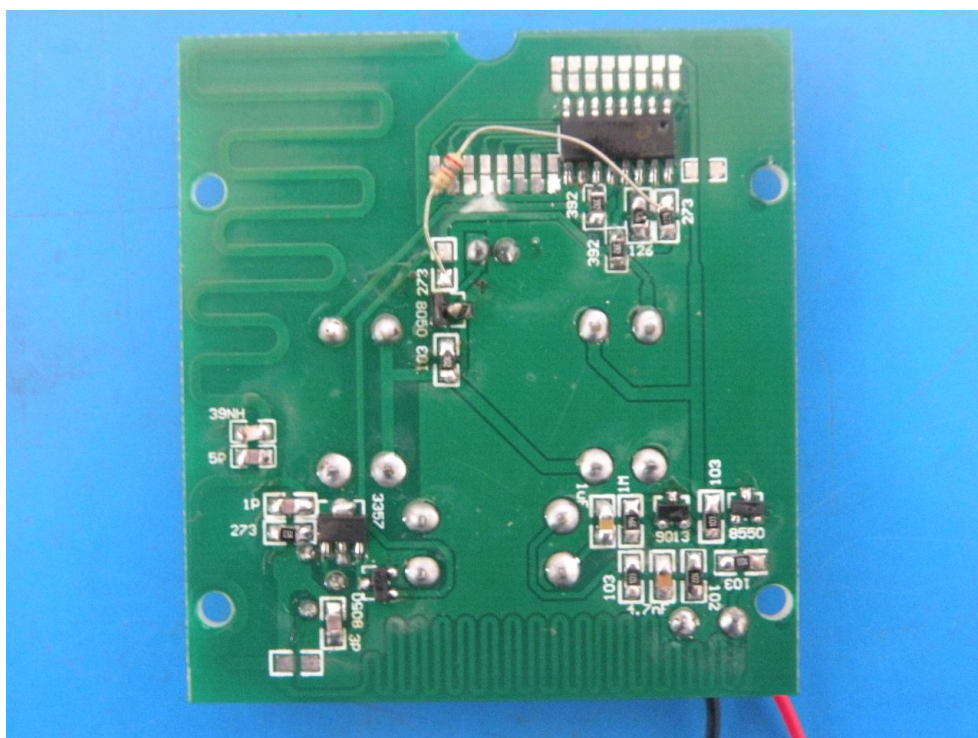
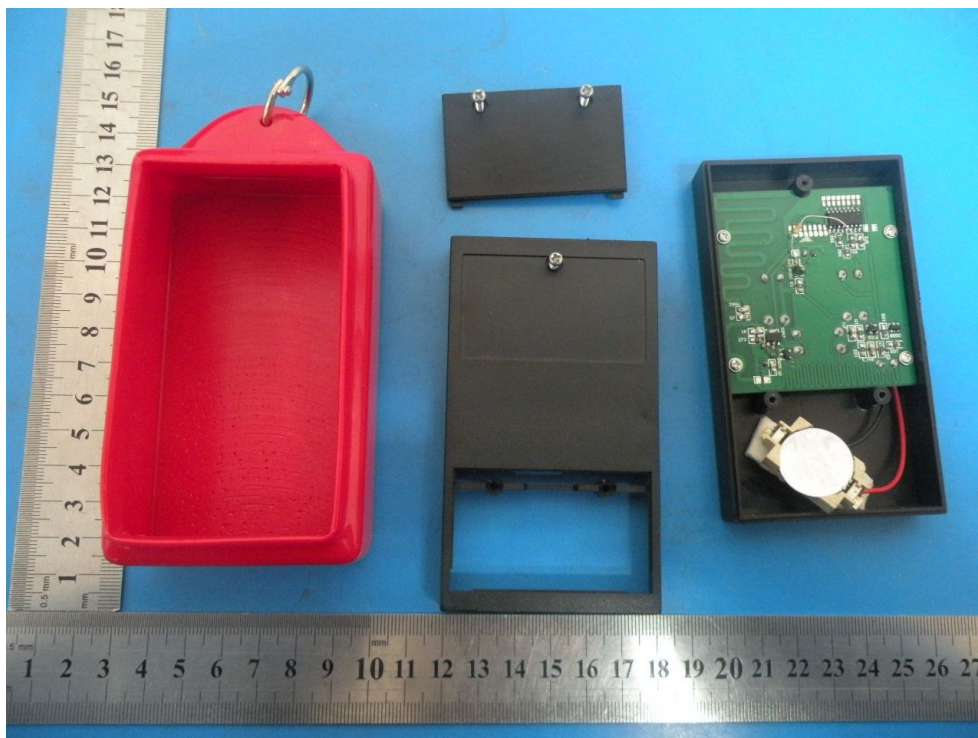

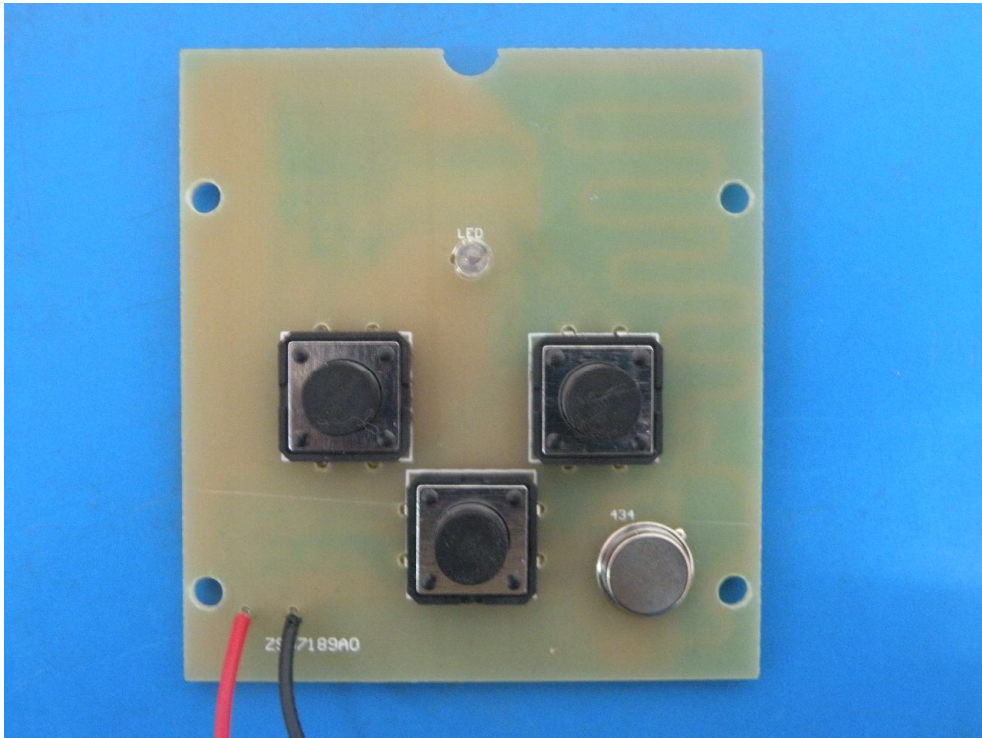

-----END OF THE REPORT-----