

FCC 47 CFR PART 15 SUBPART C

Product Type : phorus wifi / Bluetooth Speaker
Applicant : Phorus,Inc.
Address : 16255 Ventura Boulevard, Encino, California, 91436, United States
Trade Name : phorus
Model Number : PS5 SPEAKER
Test Specification : FCC 47 CFR PART 15 SUBPART C: Oct., 2013
ANSI C63.4:2009
Receive Date : Oct. 22, 2014
Test Period : Oct. 24~Oct.28, 2014
Issue Date : Dec. 09, 2014

Issue by

A Test Lab Techno Corp.
No. 140-1, Changan Street, Bade City,
Taoyuan County 334, Taiwan R.O.C.
Tel : +886-3-2710188 / Fax : +886-3-2710190



Taiwan Accreditation Eoundation accreditation number: 1330
FCC Test Firm Information: 510205
IC Test Firm Information: 7381A-1

Note: This report shall not be reproduced except in full, without the written approval of A Test Lab Techno Corp. This document may be altered or revised by A Test Lab Techno Corp. personnel only, and shall be noted in the revision section of the document. The client should not use it to claim product endorsement by TAF, or any government agencies. The test results in the report only apply to the tested sample.

Revision History

Rev.	Issue Date	Revisions	Revised By
00	Nov. 14, 2014	Initial Issue	
01	Dec. 09, 2014	Revised report information.	Snow Wang

Verification of Compliance

Issued Date: 12/09/2014

Product Type : phorus wifi / Bluetooth Speaker
Applicant : Phorus, Inc.
Address : 16255 Ventura Boulevard, Encino, California, 91436, United States
Trade Name : phorus
Model Number : PS5 SPEAKER
FCC ID : 2AAWQ-PS5SPEAKER
EUT Rated Voltage : DC 12V, 2A
Test Voltage : 120 Vac / 60 Hz
Applicable Standard : FCC 47 CFR PART 15 SUBPART C: Oct., 2013
ANSI C63.4:2009
Test Result : Complied

Performing Lab. : A Test Lab Techno Corp.
No. 140-1, Changan Street, Bade City,
Taoyuan County 334, Taiwan R.O.C.
Tel : +886-3-2710188 / Fax : +886-3-2710190
Taiwan Accreditation Foundation accreditation number: 1330
FCC Test Firm Information: 510205
IC Test Firm Information: 7381A-1
<http://www.atl-lab.com.tw/e-index.htm>



The above equipment was tested by A Test Lab Techno Corp. The test data, data evaluation, test procedures, and equipment configurations shown in this report were made in accordance with the procedures given in ANSI C63.4: 2009 and the energy emitted by the sample tested as described in this report is in compliance with the requirements of FCC Rules Part 15.207, 15.209, 15.247 .

The test results of this report relate only to the tested sample identified in this report.

Approved By : Fly Lu Reviewed By : Eric Ou Yang
(Manager) (Fly Lu) (Testing Engineer) (Eric Ou Yang)

TABLE OF CONTENTS

1	General Information	6
2	EUT Description	7
3	Test Methodology	8
	3.1. Mode of Operation.....	8
	3.2. EUT Exercise Software	8
	3.3. Configuration of Test System Details	9
	3.4. Test Site Environment	9
4	Conducted Emission Measurement	10
	4.1. Limit	10
	4.2. Test Instruments	10
	4.3. Test Setup.....	10
	4.4. Test Procedure	11
	4.5. Test Result.....	12
5	Radiated Emission Measurement.....	14
	5.1. Limit	14
	5.2. Test Instruments	14
	5.3. Setup	15
	5.4. Test Procedure	16
	5.5. Test Result.....	18
6	Maximum Conducted Output Power Measurement.....	25
	6.1. Limit	25
	6.2. Test Setup.....	25
	6.3. Test Instruments	25
	6.4. Test Procedure	25
	6.5. Test Result.....	26
7	6dB RF Bandwidth and 99 % Occupied Bandwidth Measurement	28
	7.1. Limit	28
	7.2. Test Setup.....	28
	7.3. Test Instruments	28
	7.4. Test Procedure	28
	7.5. Test Result.....	29
	7.6. Test Graphs	30
8	Maximum Power Density Measurement	34
	8.1. Limit	34
	8.2. Test Setup.....	34
	8.3. Test Instruments	34
	8.4. Test Procedure	34
	8.5. Test Result.....	35
	8.6. Test Graphs	36

9	Out of Band Conducted Emissions Measurement	40
9.1.	Limit	40
9.2.	Test Setup.....	40
9.3.	Test Instruments	40
9.4.	Test Procedure	40
9.5.	Test Graphs	41
10	Band Edges Measurement	53
10.1.	Limit	53
10.2.	Test Setup.....	53
10.3.	Test Instruments	53
10.4.	Test Procedure	54
10.5.	Test Result.....	55
11	Antenna Measurement.....	59
11.1.	Limit	59
11.2.	Antenna Connector Construction	59

1 General Information

1.1 Summary of Test Result

Standard	Item	Result	Remark
15.247			
15.207	AC Power Conducted Emission	PASS	----
Standard	Item	Result	Remark
15.247			
15.247(d)	Transmitter Radiated Emissions	PASS	----
15.247(b)(3)	Max. Output Power	PASS	----
15.247(a)(2)	6dB RF Bandwidth	PASS	----
15.247(e)	Power Spectral Density	PASS	----
15.247(d)	Out of Band Conducted Spurious Emission	PASS	----
15.247(d)	Band Edge Measurement	PASS	----
15.203	Antenna Requirement	PASS	----

The test results of this report relate only to the tested sample(s) identified in this report. Manufacturer or whom it may concern should recognize the pass or fail of the test result.

1.2 Measurement Uncertainty

Test Item	Frequency Range	Uncertainty (dB)	
Conducted Emission	9kHz ~ 30MHz	± 2.02	
Radiated Emission	30MHz ~ 1000MHz	Horizontal	± 3.98
		Vertical	± 3.62
	1000MHz ~ 18000MHz	Horizontal	± 3.11
		Vertical	± 3.07
	18000MHz ~ 40000MHz	Horizontal	± 3.66
		Vertical	± 3.54

2 EUT Description

Product Type	phorus wifi / Bluetooth Speaker			
Trade Name	phorus			
Model No.	PS5 SPEAKER			
Applicant	Phorus, Inc. 16255 Ventura Boulevard, Encino, California, 91436, United States			
Manufacturer	Fugang Electronic(Dongguan) Co., LTD Industry Street, Dong-Keng, Dong-Guan, Guang-Dong, China			
FCC ID	2AAWQ-PS5SPEAKER			
Frequency Range	IEEE 802.11b / 802.11g / 802.11n 2.4GHz 20MHz: 2412 ~ 2462 MHz IEEE 802.11n 2.4GHz 40MHz: 2422 ~ 2452 MHz			
Modulation Type	IEEE 802.11b:DSSS IEEE 802.11g:DSSS + OFDM IEEE 802.11n 2.4GHz 20MHz: OFDM IEEE 802.11n 2.4GHz 40MHz: OFDM			
Antenna used	Antenna Port	Model	Type	Max. Gain
	ANT 0	MSA-3510-25GC4-A1	PIFA	3.37dBi
	ANT 1	MSA-3310-25GC4-A1	PIFA	2.78dBi
Antenna Delivery	1TX + 1RX			
RF Output Power	IEEE 802.11b: 0.050 W / 16.99 dBm IEEE 802.11g: 0.198 W / 22.97 dBm IEEE 802.11n 2.4GHz 20MHz: 0.140 W / 21.46 dBm IEEE 802.11n 2.4GHz 40MHz: 0.129 W / 21.10 dBm			

3 Test Methodology

3.1. Mode of Operation

Decision of Test ATL has verified the construction and function in typical operation. All the test modes were carried out with the EUT in normal operation, which was shown in this test report and defined as:

Test Mode
Mode 1: Normal Operation Mode
Mode 2: IEEE 802.11b Link Mode
Mode 3: IEEE 802.11g Link Mode
Mode 4: IEEE 802.11n 2.4GHz 20MHz Link Mode
Mode 5: IEEE 802.11n 2.4GHz 40MHz Link Mode

Software used to control the EUT for staying in continuous transmitting mode was programmed.

After verification, all tests were carried out with the worst case test modes as shown below except radiated spurious emission below 1GHz and power line conducted emissions below 30MHz, which worst case was in normal link mode only.

IEEE 802.11b mode: (ANT 0)

Channel Low (2412MHz), Channel Mid (2437MHz) and Channel High (2462MHz) with 1Mbps data rate were chosen for full testing.

IEEE 802.11g mode: (ANT 0)

Channel Low (2412MHz), Channel Mid (2437MHz) and Channel High (2462MHz) with 6Mbps data rate were chosen for full testing.

IEEE 802.11n 2.4GHz 20MHz mode: (ANT 0)

Channel Low (2412MHz), Channel Mid (2437MHz) and Channel High (2462MHz) with 6.5Mbps data rate were chosen for full testing.

IEEE 802.11n 2.4GHz 40MHz mode: (ANT 0)

Channel Low (2422MHz), Channel Mid (2437MHz) and Channel High (2452MHz) with 13.5Mbps data rate were chosen for full testing.

3.2. EUT Exercise Software

1. Setup the EUT shown on 3.3.
2. Turn on the power of all equipment.
3. Turn on Wi-Fi function link to AP.
4. EUT run test program.

3.3. Configuration of Test System Details

Conducted Emissions

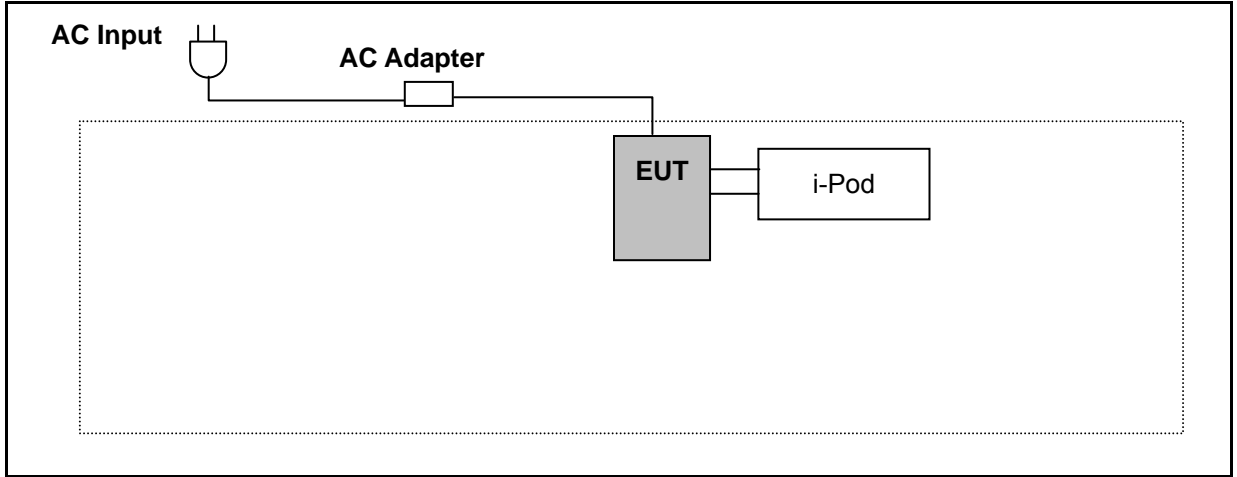

Radiated Emissions

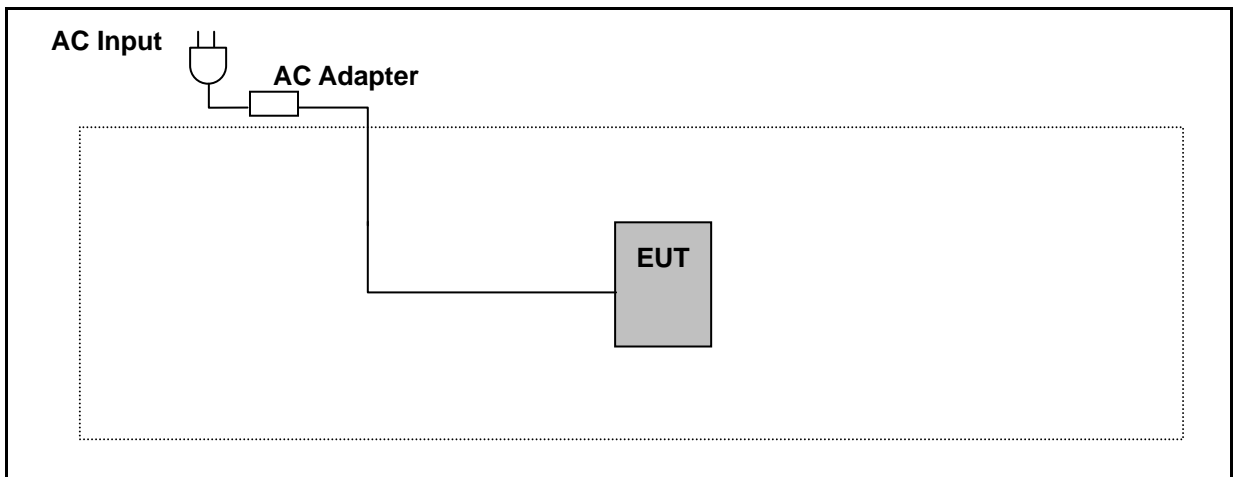

3.4. Test Site Environment

Items	Required (IEC 60068-1)	Actual
Temperature (°C)	15-35	26
Humidity (%RH)	25-75	60
Barometric pressure (mbar)	860-1060	950

4 Conducted Emission Measurement

4.1. Limit

Frequency (MHz)	Quasi-peak	Average
0.15 - 0.5	66 to 56	56 to 46
0.50 - 5.0	56	46
5.0 - 30.0	60	50

4.2. Test Instruments

Describe	Manufacturer	Model Number	Serial Number	Cal. Date	Remark
Test Receiver	R&S	ESCI	100367	06/12/2014	(1)
LISN	R&S	ENV216	101040	03/07/2014	(1)
LISN	R&S	ENV216	101041	03/07/2014	(1)
Test Site	ATL	TE02	TE02	N.C.R.	-----

Remark: (1) Calibration period 1 year. (2) Calibration period 2 years. (3) Calibration period 3 years.

Note: N.C.R. = No Calibration Request.

4.3. Test Setup

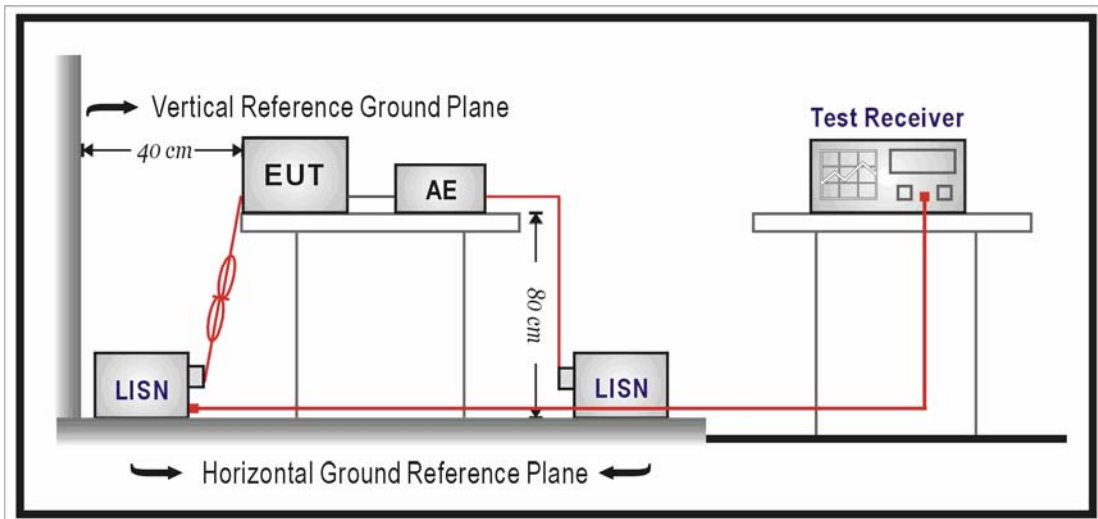

4.4. Test Procedure

The power line conducted emission measurements were performed in a shielded enclosure. The EUT was assembled on a wooden table which is 80 centimeters high, was placed 40 centimeters from the back wall and at least 1 meter from the sidewall.

Power was fed to the EUT from the public utility power grid through a line filter and EMCO Model 3162/2 SH Line Impedance Stabilization Networks (LISN). The LISN housing, measuring instrumentation case, ground plane, etc., were electrically bonded together at the same RF potential. The Spectrum analyzer was connected to the AC line through an isolation transformer. The 50-ohm output of the LISN was connected to the spectrum analyzer directly. Conducted emission levels were in the CISPR quasi-peak detection mode. The analyzer's 6 dB bandwidth was set to 9 KHz. No post-detector video filter was used.

The spectrum was scanned from 150 KHz to 30 MHz. The physical arrangement of the test system and associated cabling was varied (within the scope of arrangements likely to be encountered in actual use) to determine the effect on the unit's emanations in amplitude and frequency. All spurious emission frequencies were observed. The highest emission amplitudes relative to the appropriate limit were measured and have been recorded in paragraph 4.1.

4.5. Test Result

Standard:	FCC Part 15C	Line:	L1
Test item:	Conducted Emission	Power:	AC 120V/60Hz
Model Number:	PS5 SPEAKER	Temp.(°C)/Hum.(%RH):	26(°C)/60%RH
Mode:	1	Date:	10/24/2014
		Test By:	Eric Ou Yang
Description:			

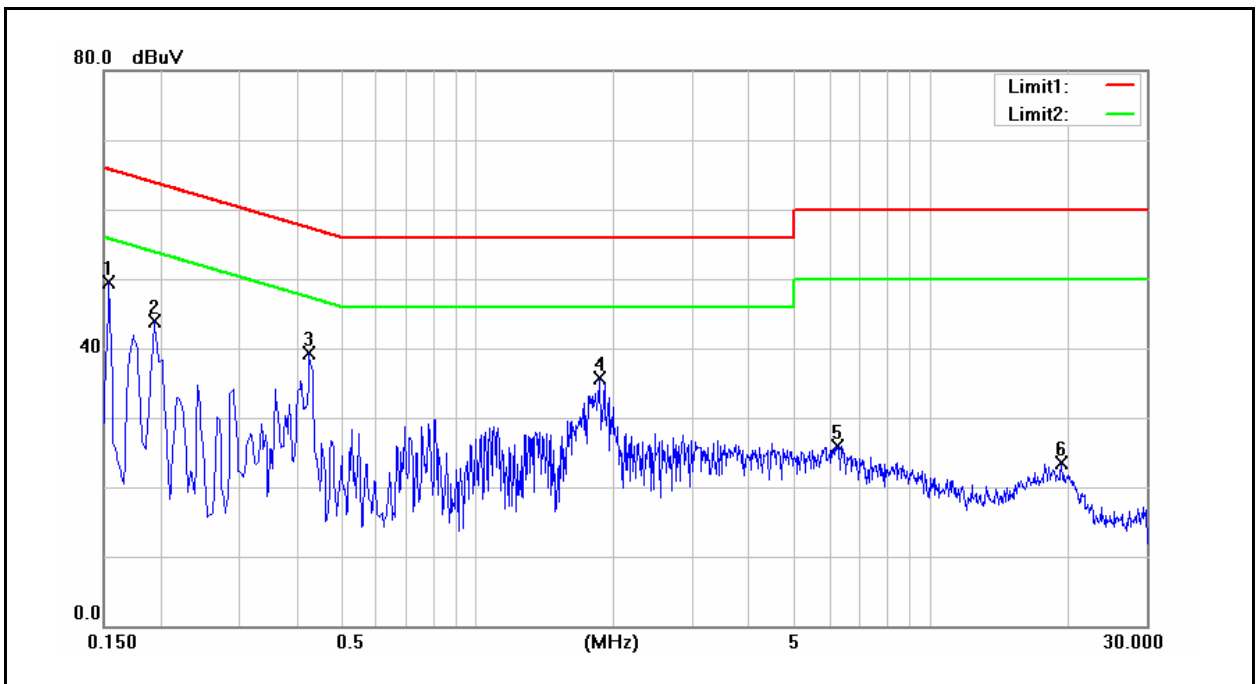

No.	Frequency (MHz)	QP reading (dBuV)	AVG reading (dBuV)	Correction factor (dB)	QP result (dBuV)	AVG result (dBuV)	QP limit (dBuV)	AVG limit (dBuV)	QP margin (dB)	AVG margin (dB)	Remark
1	0.1540	36.97	19.06	9.60	46.57	28.66	65.78	55.78	-19.21	-27.12	Pass
2	0.1940	32.51	17.82	9.60	42.11	27.42	63.86	53.86	-21.75	-26.44	Pass
3	0.4260	27.75	18.11	9.61	37.36	27.72	57.33	47.33	-19.97	-19.61	Pass
4	1.8660	23.23	13.82	9.68	32.91	23.50	56.00	46.00	-23.09	-22.50	Pass
5	6.2260	10.39	3.45	9.83	20.22	13.28	60.00	50.00	-39.78	-36.72	Pass
6	19.5060	7.00	-0.35	10.23	17.23	9.88	60.00	50.00	-42.77	-40.12	Pass

Note: 1. Result (dBuV) = Correction factor (dB) + Reading(dBuV).

2. Correction factor (dB) = Cable loss (dB) + L.I.S.N. factor (dB).

Standard:	FCC Part 15C	Line:	N
Test item:	Conducted Emission	Power:	AC 120V/60Hz
Model Number:	PS5 SPEAKER	Temp.(°C)/Hum.(%RH):	26(°C)/60%RH
Mode:	1	Date:	10/24/2014
		Test By:	Eric Ou Yang
Description:			

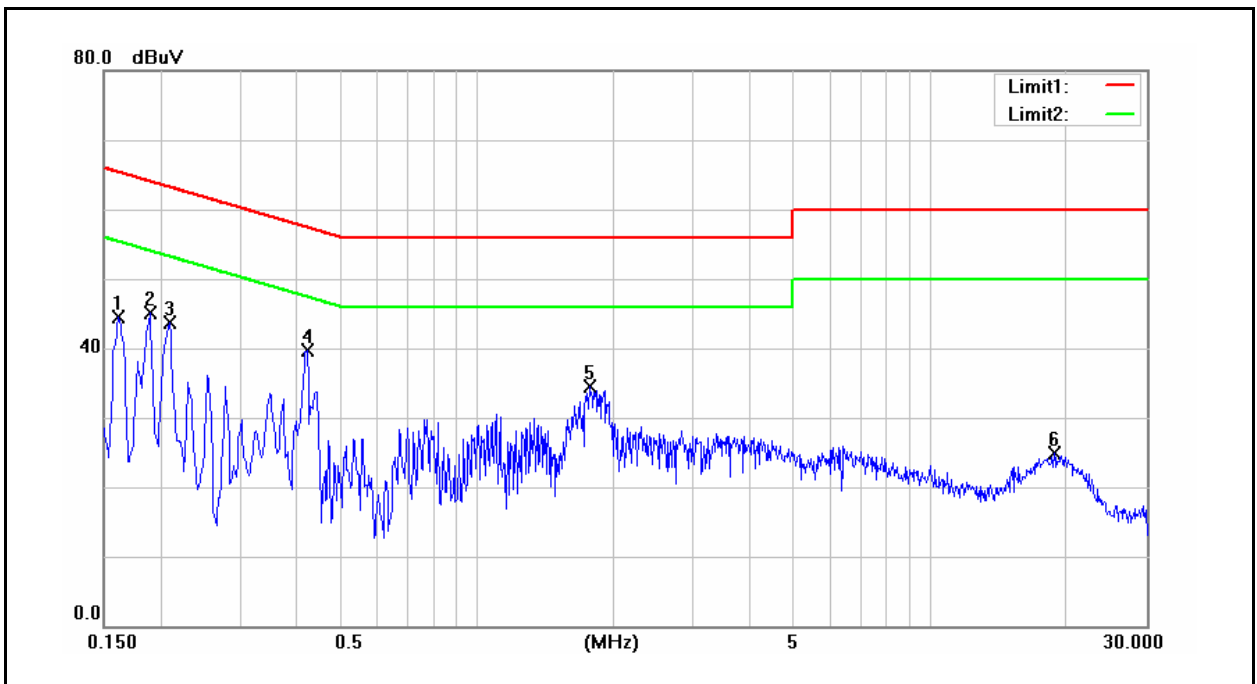

No.	Frequency (MHz)	QP reading (dBuV)	AVG reading (dBuV)	Correction factor (dB)	QP result (dBuV)	AVG result (dBuV)	QP limit (dBuV)	AVG limit (dBuV)	QP margin (dB)	AVG margin (dB)	Remark
1	0.1620	35.57	16.82	9.60	45.17	26.42	65.36	55.36	-20.19	-28.94	Pass
2	0.1900	33.05	18.50	9.60	42.65	28.10	64.04	54.04	-21.39	-25.94	Pass
3	0.2100	30.36	17.95	9.60	39.96	27.55	63.21	53.21	-23.25	-25.66	Pass
4	0.4220	28.27	19.47	9.61	37.88	29.08	57.41	47.41	-19.53	-18.33	Pass
5	1.7740	17.48	12.73	9.69	27.17	22.42	56.00	46.00	-28.83	-23.58	Pass
6	18.7820	9.69	2.94	10.20	19.89	13.14	60.00	50.00	-40.11	-36.86	Pass

Note: 1. Result (dBuV) = Correction factor (dB) + Reading(dBuV).

2. Correction factor (dB) = Cable loss (dB) + L.I.S.N. factor (dB).

5 Radiated Emission Measurement

5.1. Limit

According to §15.209(a), except as provided elsewhere in this subpart, the emissions from an intentional radiator shall not exceed the field strength levels specified in the following table:

Frequency (MHz)	Field Strength ($\mu\text{V}/\text{m}$ at meter)	Measurement Distance (meters)
0.009 – 0.490	2400 / F (kHz)	300
0.490 – 1.705	24000 / F (kHz)	30
1.705 – 30.0	30	30
30 - 88	100**	3
88-216	150**	3
216-960	200**	3
Above 960	500	3

** Except as provided in paragraph (g), fundamental emissions from intentional radiators operating under this Section shall not be located in the frequency bands 54-72 MHz, 76-88 MHz, 174-216 MHz or 470-806 MHz. However, operation within these frequency bands is permitted under other sections of this Part, e.g., Sections 15.231 and 15.241.

5.2. Test Instruments

3 Meter Chamber					
Equipment	Manufacturer	Model Number	Serial Number	Cal. Date	Remark
RF Pre-selector	Agilent	N9039A	MY46520256	01/10/2014	(1)
Spectrum Analyzer	Agilent	E4446A	MY46180578	01/10/2014	(1)
Pre Amplifier	Agilent	8449B	3008A02237	02/21/2014	(1)
Pre Amplifier	Agilent	8447D	2944A10961	02/21/2014	(1)
Broadband Antenna (30MHz~1GHz)	SCHWARZBECK MESS-ELEKTRONIK	VULB9163	9163-270	07/22/2014	(1)
Horn Antenna (1~18GHz)	SCHWARZBECK MESS-ELEKTRONIK	BBHA9120D	9120D-550	06/11/2014	(1)
Horn Antenna (18~40GHz)	SCHWARZBECK MESS-ELEKTRONIK	BBHA9170	9170-320	07/02/2014	(1)
Loop Antenna	COM-POWER CORPORATION	AL-130	121014	08/14/2012	(3)
Test Site	ATL	TE01	888001	08/28/2014	(1)

Remark: (1) Calibration period 1 year. (2) Calibration period 2 years. (3) Calibration period 3 years.

Note: N.C.R. = No Calibration Request.

5.3. Setup

Below 1GHz

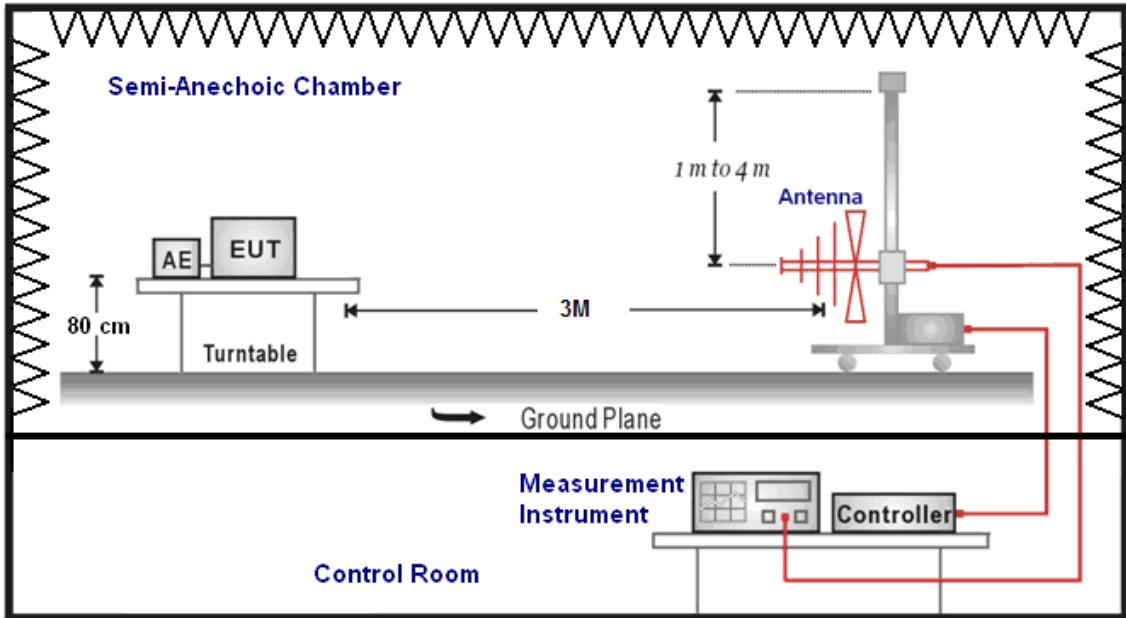

Above 1GHz

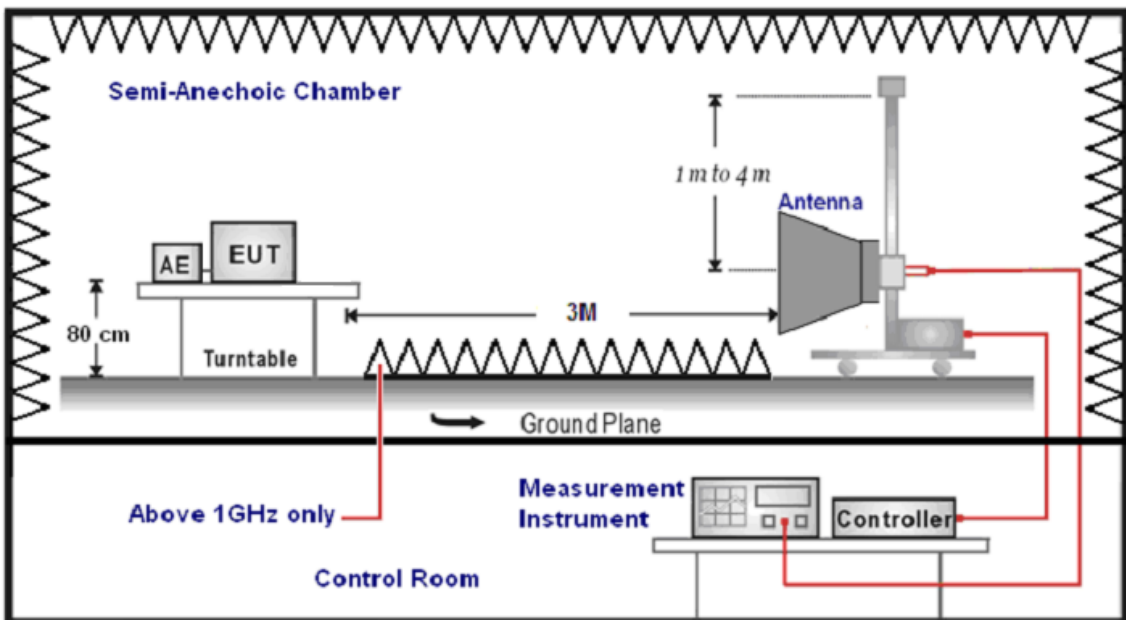

5.4. Test Procedure

Final radiation measurements were made on a three-meter, Semi Anechoic Chamber. The EUT system was placed on a nonconductive turntable which is 0.8 meters height, top surface 1.0 x 1.5 meter. The spectrum was examined from 250 MHz to 2.5 GHz in order to cover the whole spectrum below 10th harmonic which could generate from the EUT. During the test, EUT was set to transmit continuously & Measurements spectrum range from 9 kHz to 26.5 GHz is investigated.

For measurements below 1 GHz the resolution bandwidth is set to 100 kHz for peak detection measurements or 120 kHz for quasi-peak detection measurements. Peak detection is used unless otherwise noted as quasi-peak.

For measurements above 1 GHz the resolution bandwidth is set to 1 MHz, and then the video bandwidth is set to 1 MHz for peak measurements and 10 Hz for average measurements.

A nonconductive material surrounded the EUT to supporting the EUT for standing on three orthogonal planes. At each condition, the EUT was rotated 360 degrees, and the antenna was raised and lowered from one to four meters to find the maximum emission levels. Measurements were taken using both horizontal and vertical antenna polarization.

SCHWARZBECK MESS-ELEKTRONIK Biconilog Antenna (mode VULB9163) at 3 Meter and the SCHWARZBECK Double Ridged Guide Antenna (model BBHA9120D&9170) was used in frequencies 1 – 26.5 GHz at a distance of 1 meter. All test results were extrapolated to equivalent signal at 3 meters utilizing an inverse linear distance extrapolation Factor (20dB/decade).

For testing above 1GHz, the emission level of the EUT in peak mode was 20dB lower than average limit (that means the emission level in peak mode also complies with the limit in average mode), then testing will be stopped and peak values of EUT will be reported, otherwise, the emissions will be measured in average mode again and reported.

Appropriate preamplifiers were used for improving sensitivity and precautions were taken to avoid overloading or desensitizing the spectrum analyzer. No post – detector video filters were used in the test.

The spectrum analyzer's 6 dB bandwidth was set to 1 MHz, and the analyzer was operated in the peak detection mode, for frequencies both below and up 1 GHz. The average levels were obtained by subtracting the duty cycle correction factor from the peak readings.

The following procedures were used to convert the emission levels measured in decibels referenced to 1 microvolt (dBuV) into field intensity in micro volts pre meter (uV/m).

The actual field intensity in decibels referenced to 1 microvolt in to field intensity in micro volts per meter (dBuV/m).

The actual field intensity in referenced to 1 microvolt per meter (dBuV/m) is determined by algebraically adding the measured reading in dBuV, the antenna factor (dB), and cable loss (dB) and Subtracting the gain of preamplifier (dB) is auto calculate in spectrum analyzer.

(1) $\text{Amplitude (dBuV/m)} = \text{FI (dBuV)} + \text{AF (dBuV)} + \text{CL (dBuV)} - \text{Gain (dB)}$

FI= Reading of the field intensity.

AF= Antenna factor.

CL= Cable loss.

P.S Amplitude is auto calculate in spectrum analyzer.

(2) $\text{Actual Amplitude (dBuV/m)} = \text{Amplitude (dBuV)} - \text{Dis(dB)}$

The FCC specified emission limits were calculated according the EUT operating frequency and by following linear interpolation equations:

(a) For fundamental frequency : Transmitter Output < +30dBm

(b) For spurious frequency : Spurious emission limits = fundamental emission limit /10

Data of measurement within this frequency range without mark in the table above means the reading of emissions are attenuated more than 20dB below the permissible limits or the field strength is too small to be measured.

5.5. Test Result

Below 1GHz

Standard:	FCC Part 15C	Test Distance:	3m
Test item:	Radiated Emission	Power:	AC 120V/60Hz
Model Number:	PS5 SPEAKER	Temp.(°C)/Hum.(%RH):	26(°C)/60%RH
Mode:	1	Date:	10/28/2014
		Test By:	Eric Ou Yang

Frequency (MHz)	Reading (dBuV)	Correct Factor (dB/m)	Result (dBuV/m)	Limit (dBuV/m)	Margin (dB)	Remark	Ant.Polar. H / V
144.0000	42.49	-17.31	25.18	43.50	-18.32	QP	H
300.0000	36.14	-10.53	25.61	46.00	-20.39	QP	H
444.0000	29.77	-8.01	21.76	46.00	-24.24	QP	H
624.0000	26.65	-4.55	22.10	46.00	-23.90	QP	H
744.0000	27.88	-2.63	25.25	46.00	-20.75	QP	H
875.0000	27.62	-0.30	27.32	46.00	-18.68	QP	H
136.5000	41.22	-17.32	23.90	43.50	-19.60	QP	V
260.0000	34.90	-11.97	22.93	46.00	-23.07	QP	V
386.5000	36.02	-8.64	27.38	46.00	-18.62	QP	V
558.5000	38.42	-6.33	32.09	46.00	-13.91	QP	V
730.0000	30.41	-2.98	27.43	46.00	-18.57	QP	V
931.5000	26.07	0.84	26.91	46.00	-19.09	QP	V

Note: No emission found between lowest internal used/generated frequency to 30MHz (9kHz~30MHz).

Above 1GHz

Standard:	FCC Part 15C	Test Distance:	3m
Test item:	Radiated Emission	Power:	AC 120V/60Hz
Model Number:	PS5 SPEAKER	Temp.(°C)/Hum.(%RH):	26(°C)/60%RH
Mode:	2	Date:	10/28/2014
Frequency:	2412MHz	Test By:	Eric Ou Yang

Frequency (MHz)	Reading (dBuV)	Correct Factor (dB/m)	Result (dBuV/m)	Limit (dBuV/m)	Margin (dB)	Remark	Ant.Polar. H / V
2869.000	38.37	5.57	43.94	74.00	-30.06	peak	H
4521.000	36.15	10.93	47.08	74.00	-26.92	peak	H
6005.000	33.52	15.90	49.42	74.00	-24.58	peak	H
2925.000	37.11	5.73	42.84	74.00	-31.16	peak	V
4500.000	35.35	10.88	46.23	74.00	-27.77	peak	V
5872.000	34.27	15.49	49.76	74.00	-24.24	peak	V

Standard:	FCC Part 15C	Test Distance:	3m
Test item:	Radiated Emission	Power:	AC 120V/60Hz
Model Number:	PS5 SPEAKER	Temp.(°C)/Hum.(%RH):	26(°C)/60%RH
Mode:	2	Date:	10/28/2014
Frequency:	2437MHz	Test By:	Eric Ou Yang

Frequency (MHz)	Reading (dBuV)	Correct Factor (dB/m)	Result (dBuV/m)	Limit (dBuV/m)	Margin (dB)	Remark	Ant.Polar. H / V
3065.000	36.92	6.06	42.98	74.00	-31.02	peak	H
4874.000	42.14	11.84	53.98	74.00	-20.02	peak	H
4874.000	41.35	11.84	53.19	54.00	-0.81	AVG	H
6194.000	32.85	16.47	49.32	74.00	-24.68	peak	H
3002.000	38.72	5.91	44.63	74.00	-29.37	peak	V
4465.000	35.78	10.75	46.53	74.00	-27.47	peak	V
6005.000	33.96	15.90	49.86	74.00	-24.14	peak	V

Standard:	FCC Part 15C	Test Distance:	3m
Test item:	Radiated Emission	Power:	AC 120V/60Hz
Model Number:	PS5 SPEAKER	Temp.(°C)/Hum.(%RH):	26(°C)/60%RH
Mode:	2	Date:	10/28/2014
Frequency:	2462MHz	Test By:	Eric Ou Yang

Frequency (MHz)	Reading (dBuV)	Correct Factor (dB/m)	Result (dBuV/m)	Limit (dBuV/m)	Margin (dB)	Remark	Ant.Polar. H / V
2953.000	38.43	5.79	44.22	74.00	-29.78	peak	H
4924.000	39.34	11.97	51.31	74.00	-22.69	peak	H
6047.000	33.68	16.03	49.71	74.00	-24.29	peak	H
2995.000	38.26	5.90	44.16	74.00	-29.84	peak	V
4493.000	35.37	10.86	46.23	74.00	-27.77	peak	V
6082.000	33.49	16.13	49.62	74.00	-24.38	peak	V

Standard:	FCC Part 15C	Test Distance:	3m
Test item:	Radiated Emission	Power:	AC 120V/60Hz
Model Number:	PS5 SPEAKER	Temp.(°C)/Hum.(%RH):	26(°C)/60%RH
Mode:	3	Date:	10/28/2014
Frequency:	2412MHz	Test By:	Eric Ou Yang

Frequency (MHz)	Reading (dBuV)	Correct Factor (dB/m)	Result (dBuV/m)	Limit (dBuV/m)	Margin (dB)	Remark	Ant.Polar. H / V
3002.000	38.20	5.91	44.11	74.00	-29.89	peak	H
4542.000	36.47	10.99	47.46	74.00	-26.54	peak	H
6215.000	34.09	16.54	50.63	74.00	-23.37	peak	H
3002.000	38.79	5.91	44.70	74.00	-29.30	peak	V
4493.000	35.16	10.86	46.02	74.00	-27.98	peak	V
5998.000	33.66	15.88	49.54	74.00	-24.46	peak	V

Standard:	FCC Part 15C			Test Distance:	3m		
Test item:	Radiated Emission			Power:	AC 120V/60Hz		
Model Number:	PS5 SPEAKER			Temp.(°C)/Hum.(%RH):	26(°C)/60%RH		
Mode:	3			Date:	10/28/2014		
Frequency:	2437MHz			Test By:	Eric Ou Yang		
Frequency (MHz)	Reading (dBuV)	Correct Factor (dB/m)	Result (dBuV/m)	Limit (dBuV/m)	Margin (dB)	Remark	Ant.Polar. H / V
3079.000	38.88	6.08	44.96	74.00	-29.04	peak	H
4874.000	39.63	11.84	51.47	74.00	-22.53	peak	H
6061.000	33.76	16.07	49.83	74.00	-24.17	peak	H
3072.000	38.33	6.07	44.40	74.00	-29.60	peak	V
4472.000	36.57	10.79	47.36	74.00	-26.64	peak	V
5984.000	34.78	15.83	50.61	74.00	-23.39	peak	V

Standard:	FCC Part 15C			Test Distance:	3m		
Test item:	Radiated Emission			Power:	AC 120V/60Hz		
Model Number:	PS5 SPEAKER			Temp.(°C)/Hum.(%RH):	26(°C)/60%RH		
Mode:	3			Date:	10/28/2014		
Frequency:	2462MHz			Test By:	Eric Ou Yang		
Frequency (MHz)	Reading (dBuV)	Correct Factor (dB/m)	Result (dBuV/m)	Limit (dBuV/m)	Margin (dB)	Remark	Ant.Polar. H / V
2939.000	39.57	5.75	45.32	74.00	-28.68	peak	H
4535.000	35.95	10.97	46.92	74.00	-27.08	peak	H
5683.000	35.03	14.91	49.94	74.00	-24.06	peak	H
2890.000	36.89	5.63	42.52	74.00	-31.48	peak	V
4542.000	34.65	10.99	45.64	74.00	-28.36	peak	V
6166.000	33.32	16.39	49.71	74.00	-24.29	peak	V

Standard:	FCC Part 15C			Test Distance:	3m		
Test item:	Radiated Emission			Power:	AC 120V/60Hz		
Model Number:	PS5 SPEAKER			Temp.(°C)/Hum.(%RH):	26(°C)/60%RH		
Mode:	4			Date:	10/28/2014		
Frequency:	2412MHz			Test By:	Eric Ou Yang		
Frequency (MHz)	Reading (dBuV)	Correct Factor (dB/m)	Result (dBuV/m)	Limit (dBuV/m)	Margin (dB)	Remark	Ant.Polar. H / V
3051.000	38.82	6.02	44.84	74.00	-29.16	peak	H
4493.000	36.68	10.86	47.54	74.00	-26.46	peak	H
5921.000	34.71	15.63	50.34	74.00	-23.66	peak	H
2981.000	39.67	5.86	45.53	74.00	-28.47	peak	V
4479.000	36.94	10.81	47.75	74.00	-26.25	peak	V
5914.000	35.28	15.61	50.89	74.00	-23.11	peak	V

Standard:	FCC Part 15C			Test Distance:	3m		
Test item:	Radiated Emission			Power:	AC 120V/60Hz		
Model Number:	PS5 SPEAKER			Temp.(°C)/Hum.(%RH):	26(°C)/60%RH		
Mode:	4			Date:	10/28/2014		
Frequency:	2437MHz			Test By:	Eric Ou Yang		
Frequency (MHz)	Reading (dBuV)	Correct Factor (dB/m)	Result (dBuV/m)	Limit (dBuV/m)	Margin (dB)	Remark	Ant.Polar. H / V
3044.000	37.51	6.00	43.51	74.00	-30.49	peak	H
4871.000	39.66	11.83	51.49	74.00	-22.51	peak	H
5998.000	34.49	15.88	50.37	74.00	-23.63	peak	H
2953.000	38.04	5.79	43.83	74.00	-30.17	peak	V
4451.000	36.12	10.71	46.83	74.00	-27.17	peak	V
5991.000	33.98	15.85	49.83	74.00	-24.17	peak	V

Standard:	FCC Part 15C			Test Distance:	3m		
Test item:	Radiated Emission			Power:	AC 120V/60Hz		
Model Number:	PS5 SPEAKER			Temp.(°C)/Hum.(%RH):	26(°C)/60%RH		
Mode:	4			Date:	10/28/2014		
Frequency:	2462MHz			Test By:	Eric Ou Yang		
Frequency (MHz)	Reading (dBuV)	Correct Factor (dB/m)	Result (dBuV/m)	Limit (dBuV/m)	Margin (dB)	Remark	Ant.Polar. H / V
3009.000	37.97	5.93	43.90	74.00	-30.10	peak	H
4924.000	38.06	11.97	50.03	74.00	-23.97	peak	H
6257.000	32.43	16.66	49.09	74.00	-24.91	peak	H
3023.000	37.05	5.96	43.01	74.00	-30.99	peak	V
4563.000	35.31	11.05	46.36	74.00	-27.64	peak	V
6110.000	32.64	16.21	48.85	74.00	-25.15	peak	V

Standard:	FCC Part 15C			Test Distance:	3m		
Test item:	Radiated Emission			Power:	AC 120V/60Hz		
Model Number:	PS5 SPEAKER			Temp.(°C)/Hum.(%RH):	26(°C)/60%RH		
Mode:	5			Date:	10/28/2014		
Frequency:	2422MHz			Test By:	Eric Ou Yang		
Frequency (MHz)	Reading (dBuV)	Correct Factor (dB/m)	Result (dBuV/m)	Limit (dBuV/m)	Margin (dB)	Remark	Ant.Polar. H / V
2890.000	37.58	5.63	43.21	74.00	-30.79	peak	H
4844.000	39.66	11.77	51.43	74.00	-22.57	peak	H
6145.000	33.30	16.32	49.62	74.00	-24.38	peak	H
3016.000	38.25	5.95	44.20	74.00	-29.80	peak	V
4563.000	35.86	11.05	46.91	74.00	-27.09	peak	V
5921.000	34.34	15.63	49.97	74.00	-24.03	peak	V

Standard:	FCC Part 15C			Test Distance:	3m		
Test item:	Radiated Emission			Power:	AC 120V/60Hz		
Model Number:	PS5 SPEAKER			Temp.(°C)/Hum.(%RH):	26(°C)/60%RH		
Mode:	5			Date:	10/28/2014		
Frequency:	2437MHz			Test By:	Eric Ou Yang		
Frequency (MHz)	Reading (dBuV)	Correct Factor (dB/m)	Result (dBuV/m)	Limit (dBuV/m)	Margin (dB)	Remark	Ant.Polar. H / V
2974.000	37.51	5.84	43.35	74.00	-30.65	peak	H
4874.000	38.04	11.84	49.88	74.00	-24.12	peak	H
6229.000	33.53	16.58	50.11	74.00	-23.89	peak	H
3037.000	37.92	5.99	43.91	74.00	-30.09	peak	V
4514.000	35.45	10.92	46.37	74.00	-27.63	peak	V
6250.000	33.95	16.64	50.59	74.00	-23.41	peak	V

Standard:	FCC Part 15C			Test Distance:	3m		
Test item:	Radiated Emission			Power:	AC 120V/60Hz		
Model Number:	PS5 SPEAKER			Temp.(°C)/Hum.(%RH):	26(°C)/60%RH		
Mode:	5			Date:	10/28/2014		
Frequency:	2452MHz			Test By:	Eric Ou Yang		
Frequency (MHz)	Reading (dBuV)	Correct Factor (dB/m)	Result (dBuV/m)	Limit (dBuV/m)	Margin (dB)	Remark	Ant.Polar. H / V
3149.000	38.13	6.24	44.37	74.00	-29.63	peak	H
4535.000	36.33	10.97	47.30	74.00	-26.70	peak	H
6201.000	33.89	16.49	50.38	74.00	-23.62	peak	H
2967.000	37.88	5.82	43.70	74.00	-30.30	peak	V
4591.000	35.93	11.11	47.04	74.00	-26.96	peak	V
6040.000	34.59	16.00	50.59	74.00	-23.41	peak	V

6 Maximum Conducted Output Power Measurement

6.1. Limit

For systems using digital modulation in the 2400-2483.5MHz, the limit for peak output power is 30dBm.

6.2. Test Setup

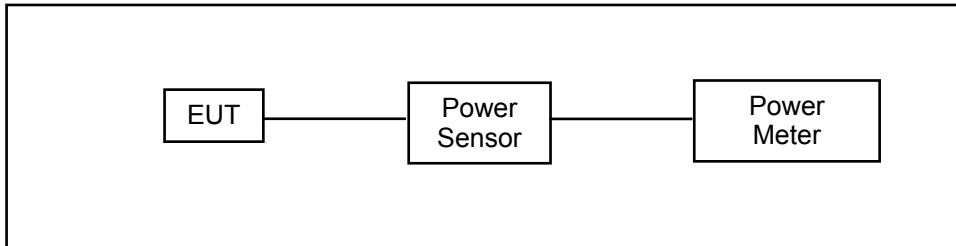

6.3. Test Instruments

Equipment	Manufacturer	Model Number	Serial Number	Cal. Date	Remark
Power Sensor	Anritsu	MA2411B	1126022	08/21/2014	(1)
Power Meter	Anritsu	ML2495A	1135009	08/21/2014	(1)
Test Site	ATL	TE05	TE05	N.C.R.	-----

Remark: (1) Calibration period 1 year. (2) Calibration period 2 years. (3) Calibration period 3 years.

Note: N.C.R. = No Calibration Request.

6.4. Test Procedure

The tests below are run with the EUT's transmitter set at high power in TX mode. The EUT is needed to force selection of output power level and channel number. While testing, EUT was set to transmit continuously. Remove the Subjective device's antenna and connect the RF output port to power sensor. The maximum peak output power shall not exceed 1 watt.

Use a direct connection between the antenna port of transmitter and the power sensor, for prevent the power sensor input attenuation 40-50 dB. Set the RBW Bandwidth of the emission or use a channel power meter mode.

For antennas with gains of 6 dBi or less, maximum allowed transmitter output is 1 watt (+30 dBm). For antennas with gains greater than 6 dBi, transmitter output level must be decreased by an amount equal to (GAIN - 6)/3 dBm.

The antenna port of the EUT was connected to the input of a power sensor. Power was read directly and cable loss correction was added to the reading to obtain power at the EUT antenna terminals.

6.5. Test Result

Model Number		PS5 SPEAKER								
Test Item		Maximum Conducted Output Power								
Test Mode		Mode 2: IEEE 802.11b Link Mode								
Date of Test		10/24/2014				Test Site		TE05		
Frequency (MHz)	Data Rate	Ant 0				Ant 1				Limit (dBm)
		Average Power		Peak Power		Average Power		Peak Power		
		(dBm)	(W)	(dBm)	(W)	(dBm)	(W)	(dBm)	(W)	
2412	1M	14.40	0.028	16.99	0.050	14.30	0.027	16.86	0.049	< 30
2437		13.71	0.023	16.38	0.043	13.61	0.023	16.25	0.042	< 30
2462		13.75	0.024	16.45	0.044	13.65	0.023	16.32	0.043	< 30

Model Number		PS5 SPEAKER								
Test Item		Maximum Conducted Output Power								
Test Mode		Mode 3: IEEE 802.11g Link Mode								
Date of Test		10/24/2014				Test Site		TE05		
Frequency (MHz)	Data Rate	Ant 0				Ant 1				Limit (dBm)
		Average Power		Peak Power		Average Power		Peak Power		
		(dBm)	(W)	(dBm)	(W)	(dBm)	(W)	(dBm)	(W)	
2412	6M	13.06	0.020	22.73	0.187	12.93	0.020	22.59	0.182	< 30
2437		13.73	0.024	22.97	0.198	13.60	0.023	22.83	0.192	< 30
2462		13.37	0.022	22.81	0.191	13.24	0.021	22.67	0.185	< 30

Model Number		PS5 SPEAKER								
Test Item		Maximum Conducted Output Power								
Test Mode		Mode 4: IEEE 802.11n 2.4GHz 20MHz Link Mode								
Date of Test		10/24/2014				Test Site		TE05		
Frequency (MHz)	Data Rate	Ant 0				Ant 1				Limit (dBm)
		Average Power		Peak Power		Average Power		Peak Power		
		(dBm)	(W)	(dBm)	(W)	(dBm)	(W)	(dBm)	(W)	
2412	6.5M	12.47	0.018	21.46	0.140	12.33	0.017	21.33	0.136	< 30
2437		12.19	0.017	21.14	0.130	12.05	0.016	21.01	0.126	< 30
2462		12.42	0.017	21.29	0.135	12.28	0.017	21.16	0.131	< 30

Model Number	PS5 SPEAKER									
Test Item	Maximum Conducted Output Power									
Test Mode	Mode 5: IEEE 802.11n 2.4GHz 40MHz Link Mode									
Date of Test	10/24/2014					Test Site		TE05		
Frequency (MHz)	Data Rate	Ant 0				Ant 1				Limit (dBm)
		Average Power		Peak Power		Average Power		Peak Power		
		(dBm)	(W)	(dBm)	(W)	(dBm)	(W)	(dBm)	(W)	
2422	13.5M	11.88	0.015	21.10	0.129	11.72	0.015	20.92	0.124	< 30
2437		11.68	0.015	20.93	0.124	11.52	0.014	20.75	0.119	< 30
2452		11.20	0.013	20.52	0.113	11.04	0.013	20.34	0.108	< 30

7 6dB RF Bandwidth Measurement

7.1. Limit

6dB RF Bandwidth: Systems using digital modulation techniques may operate in the 2400–2483.5 MHz bands. The minimum 6 dB band-width shall be at least 500 kHz.

99 % Occupied Bandwidth: N/A

7.2. Test Setup

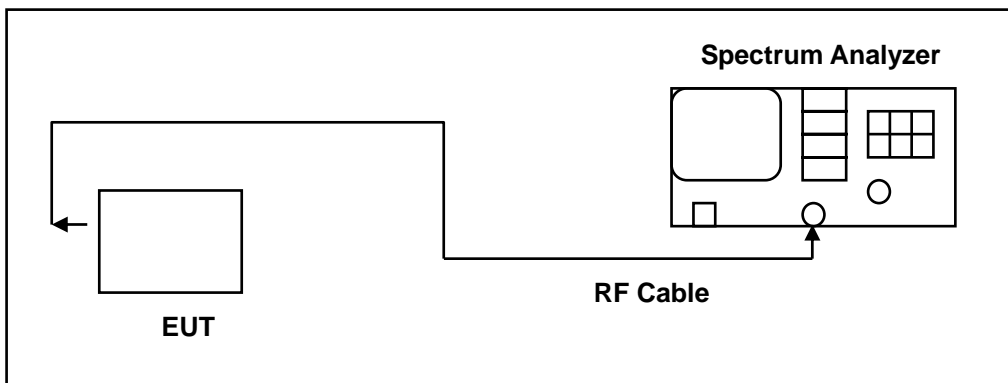

7.3. Test Instruments

Equipment	Manufacturer	Model Number	Serial Number	Cal. Date	Remark
Spectrum Analyzer	Agilent	E4445A	MY45300744	12/19/2012	(2)
Test Site	ATL	TE05	TE05	N.C.R.	-----

dRemark: (1) Calibration period 1 year. (2) Calibration period 2 years. (3) Calibration period 3 years.

Note: N.C.R. = No Calibration Request.

7.4. Test Procedure

The EUT was setup to ANSI C63.4, 2009; tested to DTS test procedure of KDB558074D01 for compliance to FCC 47CFR 15.247 requirements.

6dB RF Bandwidth: The antenna port of the EUT was connected to the input of a spectrum analyzer. Analyzer RES BW was set to 100 kHz. For each RF output channel investigated, the spectrum analyzer center frequency was set to the channel carrier. A peak output reading was taken, a DISPLAY line was drawn 6 dB lower than peak level. The 6 dB bandwidth was determined from where the channel output spectrum intersected the display line.

The test was performed at 3 channels (Channel low, middle, high)

99 % Occupied Bandwidth: The transmitter shall be operated at its maximum carrier power measured under normal test conditions.

The video bandwidth shall be set to 3 times the resolution bandwidth. Video averaging is not permitted. Where practical, a sampling detector shall be used since a peak or, peak hold, may produce a wider bandwidth than actual.

The trace data points are recovered and are directly summed in linear terms. The recovered amplitude data points, beginning at the lowest frequency, are placed in a running sum until 0.5% of the total is reached and that frequency recorded. The process is repeated for the highest frequency data points. This frequency is recorded.

7.5. Test Result

Model Number	PS5 SPEAKER		
Test Item	6dB RF Bandwidth		
Test Mode	Mode 2: IEEE 802.11b Link Mode		
Date of Test	10/24/2014	Test Site	TE05
Frequency (MHz)	6dB RF Bandwidth (MHz)	6dB RF Bandwidth Limit (MHz)	
2412	10.051	> 0.500	
2437	10.041	> 0.500	
2462	10.036	> 0.500	

Model Number	PS5 SPEAKER		
Test Item	6dB RF Bandwidth		
Test Mode	Mode 3: IEEE 802.11g Link Mode		
Date of Test	10/24/2014	Test Site	TE05
Frequency (MHz)	6dB RF Bandwidth (MHz)	6dB RF Bandwidth Limit (MHz)	
2412	16.603	> 0.500	
2437	16.448	> 0.500	
2462	16.603	> 0.500	

Model Number	PS5 SPEAKER		
Test Item	6dB RF Bandwidth		
Test Mode	Mode 4: IEEE 802.11n 2.4GHz 20MHz Link Mode		
Date of Test	10/24/2014	Test Site	TE05
Frequency (MHz)	6dB RF Bandwidth (MHz)	6dB RF Bandwidth Limit (MHz)	
2412	17.837	> 0.500	
2437	17.839	> 0.500	
2462	17.858	> 0.500	

Model Number	PS5 SPEAKER		
Test Item	6dB RF Bandwidth		
Test Mode	Mode 5: IEEE 802.11n 2.4GHz 40MHz Link Mode		
Date of Test	10/24/2014	Test Site	TE05
Frequency (MHz)	6dB RF Bandwidth (MHz)	6dB RF Bandwidth Limit (MHz)	
2422	36.660	> 0.500	
2437	36.652	> 0.500	
2452	36.650	> 0.500	

7.6. Test Graphs

Mode 2: IEEE 802.11b Link Mode	
2412	<p>Agilent R T</p> <p>Ch Freq 2.412 GHz Trig Free</p> <p>Center Freq 2.41200000 GHz</p> <p>Start Freq 2.39700000 GHz</p> <p>Stop Freq 2.42700000 GHz</p> <p>CF Step 3.00000000 MHz Auto Man</p> <p>Freq Offset 0.00000000 Hz</p> <p>Signal Track On Off</p> <p>Ref 20 dBm Atten 20 dB</p> <p>Peak</p> <p>Log</p> <p>10 dB/Offst 11.3 dB</p> <p>Center 2.412 00 GHz Span 30 MHz</p> <p>Res BW 100 kHz VBW 300 kHz Sweep 2.88 ms (601 pts)</p> <p>Occupied Bandwidth 13.6885 MHz</p> <p>Occ BW % PWR 99.00 % x dB -6.00 dB</p> <p>Transmit Freq Error -11.512 kHz</p> <p>x dB Bandwidth 10.051 MHz</p> <p>Copyright 2000-2005 Agilent Technologies</p>
2437	<p>Agilent T</p> <p>Ch Freq 2.437 GHz Trig Free</p> <p>Center Freq 2.43700000 GHz</p> <p>Start Freq 2.42200000 GHz</p> <p>Stop Freq 2.45200000 GHz</p> <p>CF Step 3.00000000 MHz Auto Man</p> <p>Freq Offset 0.00000000 Hz</p> <p>Signal Track On Off</p> <p>Ref 20 dBm Atten 20 dB</p> <p>Peak</p> <p>Log</p> <p>10 dB/Offst 11.3 dB</p> <p>Center 2.437 00 GHz Span 30 MHz</p> <p>Res BW 100 kHz VBW 300 kHz Sweep 2.88 ms (601 pts)</p> <p>Occupied Bandwidth 13.6555 MHz</p> <p>Occ BW % PWR 99.00 % x dB -6.00 dB</p> <p>Transmit Freq Error -3.850 kHz</p> <p>x dB Bandwidth 10.041 MHz</p> <p>Copyright 2000-2005 Agilent Technologies</p>
2462	<p>Agilent T</p> <p>Ch Freq 2.462 GHz Trig Free</p> <p>Center Freq 2.46200000 GHz</p> <p>Start Freq 2.44700000 GHz</p> <p>Stop Freq 2.47700000 GHz</p> <p>CF Step 3.00000000 MHz Auto Man</p> <p>Freq Offset 0.00000000 Hz</p> <p>Signal Track On Off</p> <p>Ref 20 dBm Atten 20 dB</p> <p>Peak</p> <p>Log</p> <p>10 dB/Offst 11.3 dB</p> <p>Center 2.462 00 GHz Span 30 MHz</p> <p>Res BW 100 kHz VBW 300 kHz Sweep 2.88 ms (601 pts)</p> <p>Occupied Bandwidth 13.6827 MHz</p> <p>Occ BW % PWR 99.00 % x dB -6.00 dB</p> <p>Transmit Freq Error 5.060 kHz</p> <p>x dB Bandwidth 10.036 MHz</p> <p>Copyright 2000-2005 Agilent Technologies</p>

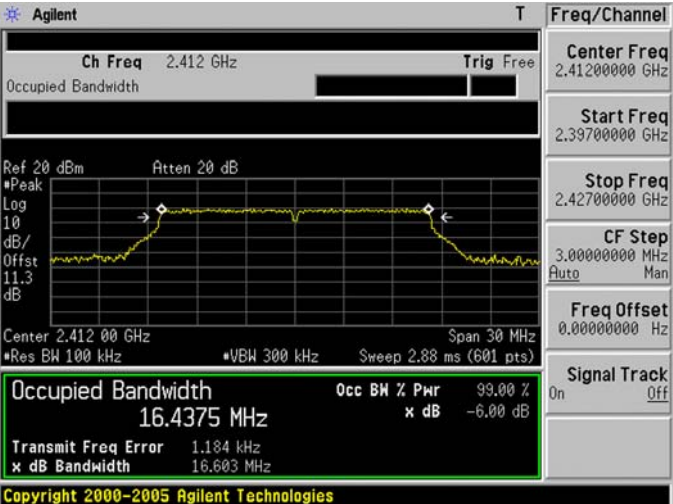
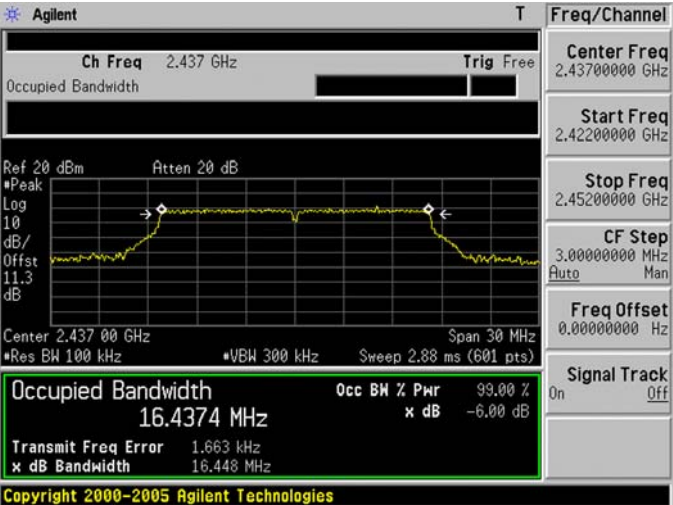
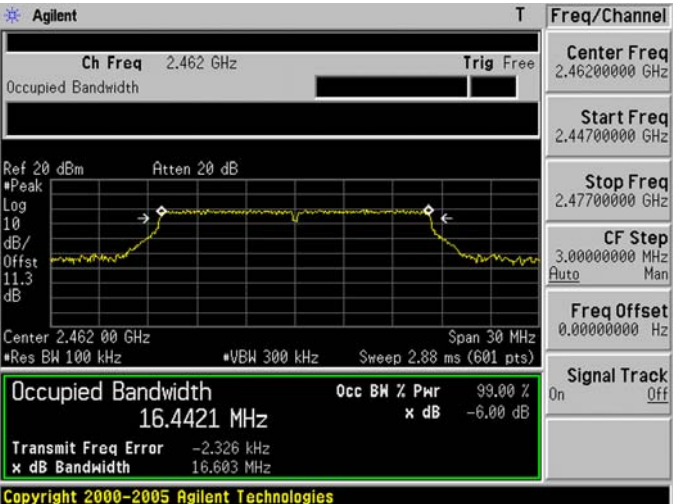
Mode 3: IEEE 802.11g Link Mode	
2412	 <p>Agilent T</p> <p>Ch Freq 2.412 GHz Trig Free</p> <p>Center Freq 2.41200000 GHz</p> <p>Start Freq 2.39700000 GHz</p> <p>Stop Freq 2.42700000 GHz</p> <p>CF Step 3.00000000 MHz Auto Man</p> <p>Freq Offset 0.00000000 Hz</p> <p>Signal Track On Off</p> <p>Ref 20 dBm Atten 20 dB</p> <p>Peak</p> <p>Log</p> <p>10</p> <p>dB/</p> <p>Offst</p> <p>11.3</p> <p>dB</p> <p>Center 2.412 00 GHz Span 30 MHz</p> <p>Res BW 100 kHz VBW 300 kHz Sweep 2.88 ms (601 pts)</p> <p>Occupied Bandwidth 16.4375 MHz Occ BW % PWR 99.00 % x dB -6.00 dB</p> <p>Transmit Freq Error 1.184 kHz</p> <p>x dB Bandwidth 16.603 MHz</p> <p>Copyright 2000-2005 Agilent Technologies</p>
2437	 <p>Agilent T</p> <p>Ch Freq 2.437 GHz Trig Free</p> <p>Center Freq 2.43700000 GHz</p> <p>Start Freq 2.42200000 GHz</p> <p>Stop Freq 2.45200000 GHz</p> <p>CF Step 3.00000000 MHz Auto Man</p> <p>Freq Offset 0.00000000 Hz</p> <p>Signal Track On Off</p> <p>Ref 20 dBm Atten 20 dB</p> <p>Peak</p> <p>Log</p> <p>10</p> <p>dB/</p> <p>Offst</p> <p>11.3</p> <p>dB</p> <p>Center 2.437 00 GHz Span 30 MHz</p> <p>Res BW 100 kHz VBW 300 kHz Sweep 2.88 ms (601 pts)</p> <p>Occupied Bandwidth 16.4374 MHz Occ BW % PWR 99.00 % x dB -6.00 dB</p> <p>Transmit Freq Error 1.663 kHz</p> <p>x dB Bandwidth 16.448 MHz</p> <p>Copyright 2000-2005 Agilent Technologies</p>
2462	 <p>Agilent T</p> <p>Ch Freq 2.462 GHz Trig Free</p> <p>Center Freq 2.46200000 GHz</p> <p>Start Freq 2.44700000 GHz</p> <p>Stop Freq 2.47700000 GHz</p> <p>CF Step 3.00000000 MHz Auto Man</p> <p>Freq Offset 0.00000000 Hz</p> <p>Signal Track On Off</p> <p>Ref 20 dBm Atten 20 dB</p> <p>Peak</p> <p>Log</p> <p>10</p> <p>dB/</p> <p>Offst</p> <p>11.3</p> <p>dB</p> <p>Center 2.462 00 GHz Span 30 MHz</p> <p>Res BW 100 kHz VBW 300 kHz Sweep 2.88 ms (601 pts)</p> <p>Occupied Bandwidth 16.4421 MHz Occ BW % PWR 99.00 % x dB -6.00 dB</p> <p>Transmit Freq Error -2.326 kHz</p> <p>x dB Bandwidth 16.603 MHz</p> <p>Copyright 2000-2005 Agilent Technologies</p>

Mode 4: IEEE 802.11n 2.4GHz 20MHz Link Mode

2412	<p>Agilent T</p> <p>Ch Freq 2.412 GHz Trig Free</p> <p>Center Freq 2.41200000 GHz</p> <p>Start Freq 2.39700000 GHz</p> <p>Stop Freq 2.42700000 GHz</p> <p>CF Step 3.00000000 MHz Auto Man</p> <p>Freq Offset 0.00000000 Hz</p> <p>Signal Track On Off</p> <p>Ref 20 dBm Atten 20 dB</p> <p>Peak</p> <p>Log</p> <p>10</p> <p>dB/</p> <p>Offst</p> <p>11.3</p> <p>dB</p> <p>Center 2.412 00 GHz Span 30 MHz</p> <p>Res BW 100 kHz VBW 300 kHz Sweep 2.88 ms (601 pts)</p> <p>Occupied Bandwidth 17.6691 MHz</p> <p>Occ BW % PWR 99.00 % x dB -6.00 dB</p> <p>Transmit Freq Error 8.516 kHz</p> <p>x dB Bandwidth 17.837 MHz</p> <p>Copyright 2000-2005 Agilent Technologies</p>
2437	<p>Agilent T</p> <p>Ch Freq 2.437 GHz Trig Free</p> <p>Center Freq 2.43700000 GHz</p> <p>Start Freq 2.42200000 GHz</p> <p>Stop Freq 2.45200000 GHz</p> <p>CF Step 3.00000000 MHz Auto Man</p> <p>Freq Offset 0.00000000 Hz</p> <p>Signal Track On Off</p> <p>Ref 20 dBm Atten 20 dB</p> <p>Peak</p> <p>Log</p> <p>10</p> <p>dB/</p> <p>Offst</p> <p>11.3</p> <p>dB</p> <p>Center 2.437 00 GHz Span 30 MHz</p> <p>Res BW 100 kHz VBW 300 kHz Sweep 2.88 ms (601 pts)</p> <p>Occupied Bandwidth 17.6776 MHz</p> <p>Occ BW % PWR 99.00 % x dB -6.00 dB</p> <p>Transmit Freq Error 12.037 kHz</p> <p>x dB Bandwidth 17.839 MHz</p> <p>Copyright 2000-2005 Agilent Technologies</p>
2462	<p>Agilent T</p> <p>Ch Freq 2.462 GHz Trig Free</p> <p>Center Freq 2.46200000 GHz</p> <p>Start Freq 2.44700000 GHz</p> <p>Stop Freq 2.47700000 GHz</p> <p>CF Step 3.00000000 MHz Auto Man</p> <p>Freq Offset 0.00000000 Hz</p> <p>Signal Track On Off</p> <p>Ref 20 dBm Atten 20 dB</p> <p>Peak</p> <p>Log</p> <p>10</p> <p>dB/</p> <p>Offst</p> <p>11.3</p> <p>dB</p> <p>Center 2.462 00 GHz Span 30 MHz</p> <p>Res BW 100 kHz VBW 300 kHz Sweep 2.88 ms (601 pts)</p> <p>Occupied Bandwidth 17.6799 MHz</p> <p>Occ BW % PWR 99.00 % x dB -6.00 dB</p> <p>Transmit Freq Error 12.986 kHz</p> <p>x dB Bandwidth 17.858 MHz</p> <p>Copyright 2000-2005 Agilent Technologies</p>

Mode 5: IEEE 802.11n 2.4GHz 40MHz Link Mode

2422	<p>Agilent T</p> <p>Ch Freq 2.422 GHz Trig Free</p> <p>Occupied Bandwidth</p> <p>Ref 20 dBm Atten 20 dB</p> <p>Peak</p> <p>Log</p> <p>10</p> <p>dB/</p> <p>Offst</p> <p>11.3</p> <p>dB</p> <p>Center 2.422 00 GHz Span 60 MHz</p> <p>Res BW 100 kHz VBW 300 kHz Sweep 5.76 ms (601 pts)</p> <p>Occupied Bandwidth 36.2666 MHz</p> <p>Occ BW % PWR 99.00 %</p> <p>x dB -6.00 dB</p> <p>Transmit Freq Error 10.621 kHz</p> <p>x dB Bandwidth 36.660 MHz</p> <p>Copyright 2000-2005 Agilent Technologies</p> <p>Freq/Channel</p> <p>Center Freq 2.42200000 GHz</p> <p>Start Freq 2.39200000 GHz</p> <p>Stop Freq 2.45200000 GHz</p> <p>CF Step 6.00000000 MHz</p> <p>Auto Man</p> <p>Freq Offset 0.00000000 Hz</p> <p>Signal Track On Off</p>
2437	<p>Agilent T</p> <p>Ch Freq 2.437 GHz Trig Free</p> <p>Occupied Bandwidth</p> <p>Ref 20 dBm Atten 20 dB</p> <p>Peak</p> <p>Log</p> <p>10</p> <p>dB/</p> <p>Offst</p> <p>11.3</p> <p>dB</p> <p>Center 2.437 00 GHz Span 60 MHz</p> <p>Res BW 100 kHz VBW 300 kHz Sweep 5.76 ms (601 pts)</p> <p>Occupied Bandwidth 36.2276 MHz</p> <p>Occ BW % PWR 99.00 %</p> <p>x dB -6.00 dB</p> <p>Transmit Freq Error 12.394 kHz</p> <p>x dB Bandwidth 36.652 MHz</p> <p>Copyright 2000-2005 Agilent Technologies</p> <p>Freq/Channel</p> <p>Center Freq 2.43700000 GHz</p> <p>Start Freq 2.40700000 GHz</p> <p>Stop Freq 2.46700000 GHz</p> <p>CF Step 6.00000000 MHz</p> <p>Auto Man</p> <p>Freq Offset 0.00000000 Hz</p> <p>Signal Track On Off</p>
2452	<p>Agilent T</p> <p>Ch Freq 2.452 GHz Trig Free</p> <p>Occupied Bandwidth</p> <p>Ref 20 dBm Atten 20 dB</p> <p>Peak</p> <p>Log</p> <p>10</p> <p>dB/</p> <p>Offst</p> <p>11.3</p> <p>dB</p> <p>Start 2.422 00 GHz Stop 2.482 00 GHz</p> <p>Res BW 100 kHz VBW 300 kHz Sweep 5.76 ms (601 pts)</p> <p>Occupied Bandwidth 36.2283 MHz</p> <p>Occ BW % PWR 99.00 %</p> <p>x dB -6.00 dB</p> <p>Transmit Freq Error 4.611 kHz</p> <p>x dB Bandwidth 36.650 MHz</p> <p>Copyright 2000-2005 Agilent Technologies</p> <p>Freq/Channel</p> <p>Center Freq 2.45200000 GHz</p> <p>Start Freq 2.42200000 GHz</p> <p>Stop Freq 2.48200000 GHz</p> <p>CF Step 6.00000000 MHz</p> <p>Auto Man</p> <p>Freq Offset 0.00000000 Hz</p> <p>Signal Track On Off</p>

8 Maximum Power Density Measurement

8.1. Limit

For digitally modulated systems, the power spectral density conducted from the intentional radiator to the antenna shall not be greater than 8 dBm in any 3 kHz band during any time interval of continuous transmission.

8.2. Test Setup

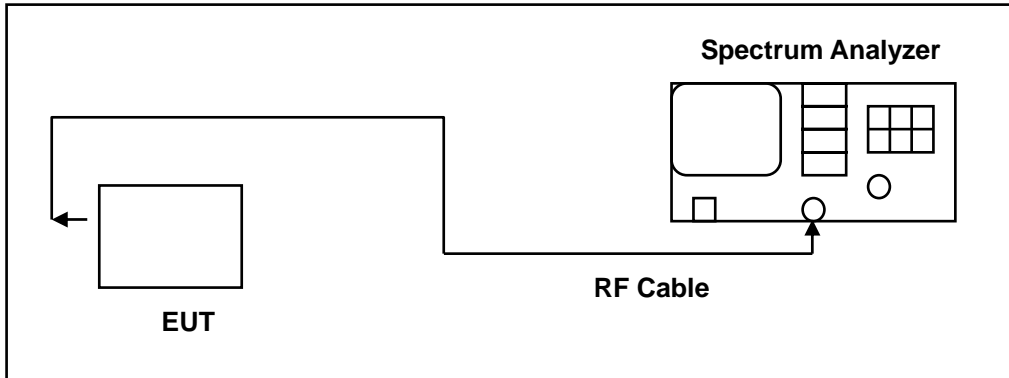

8.3. Test Instruments

Equipment	Manufacturer	Model Number	Serial Number	Cal. Date	Remark
Spectrum Analyzer	Agilent	E4445A	MY45300744	12/19/2012	(2)
Test Site	ATL	TE05	TE05	N.C.R.	-----

Remark: (1) Calibration period 1 year. (2) Calibration period 2 years. (3) Calibration period 3 years.

Note: N.C.R. = No Calibration Request.

8.4. Test Procedure

The EUT was setup to ANSI C63.4, 2009; tested to DTS test procedure of KDB558074D01 for compliance to FCC 47CFR 15.247 requirements.

1. Set analyzer center frequency to DTS channel center frequency.
2. Set the span to 1.5 times the DTS bandwidth.
3. Set the RBW to: $3 \text{ kHz} \leq \text{RBW} \leq 100 \text{ kHz}$.
4. Set the VBW $\geq 3 \times \text{RBW}$.
5. Detector = peak.
6. Sweep time = auto couple.
7. Trace mode = max hold.
8. Allow trace to fully stabilize.
9. Use the peak marker function to determine the maximum amplitude level within the RBW.
10. If measured value exceeds limit, reduce RBW (no less than 3 kHz) and repeat.

8.5. Test Result

Model Number	PS5 SPEAKER		
Test Item	Maximum Power Density		
Test Mode	Mode 2: IEEE 802.11b Link Mode		
Date of Test	10/24/2014	Test Site	TE05
Frequency (MHz)	Reading (dBm/3KHz)		Limit (dBm)
2412	4.08		< 8
2437	3.38		< 8
2462	3.68		< 8

Model Number	PS5 SPEAKER		
Test Item	Maximum Power Density		
Test Mode	Mode 3: IEEE 802.11g Link Mode		
Date of Test	10/24/2014	Test Site	TE05
Frequency (MHz)	Reading (dBm/3KHz)		Limit (dBm)
2412	-0.71		< 8
2437	-0.53		< 8
2462	-0.28		< 8

Model Number	PS5 SPEAKER		
Test Item	Maximum Power Density		
Test Mode	Mode 4: IEEE 802.11n 2.4GHz 20MHz Link Mode		
Date of Test	10/24/2014	Test Site	TE05
Frequency (MHz)	Reading (dBm/3KHz)		Limit (dBm)
2412	-1.28		< 8
2437	-1.30		< 8
2462	-1.11		< 8

Model Number	PS5 SPEAKER		
Test Item	Maximum Power Density		
Test Mode	Mode 5: IEEE 802.11n 2.4GHz 40MHz Link Mode		
Date of Test	10/24/2014	Test Site	TE05
Frequency (MHz)	Reading (dBm/3KHz)		Limit (dBm)
2422	-5.24		< 8
2437	-5.45		< 8
2452	-6.11		< 8

8.6. Test Graphs

Mode 2: IEEE 802.11b Link Mode	
2412	<p>Agilent T Freq/Channel Ref 20 dBm Atten 20 dB Mkr1 2.411 50 GHz *Peak 2.4120000 GHz Log 10 dB/Offst 11.3 dB LgAv M1 S2 S3 FC AL E(f): F Tun Swp Center 2.412 00 GHz Span 15 MHz *Res BW 100 kHz *VBW 300 kHz Sweep 1.44 ms (601 pts) Copyright 2000-2005 Agilent Technologies</p> <p>Center Freq 2.4120000 GHz Start Freq 2.40450000 GHz Stop Freq 2.41950000 GHz CF Step 1.50000000 MHz Auto Man Freq Offset 0.00000000 Hz Signal Track On Off</p>
2437	<p>Agilent T Freq/Channel Ref 20 dBm Atten 20 dB Mkr1 2.435 50 GHz *Peak 2.4370000 GHz Log 10 dB/Offst 11.3 dB LgAv M1 S2 S3 FC AL E(f): F Tun Swp Center 2.437 00 GHz Span 15 MHz *Res BW 100 kHz *VBW 300 kHz Sweep 1.44 ms (601 pts) Copyright 2000-2005 Agilent Technologies</p> <p>Center Freq 2.4370000 GHz Start Freq 2.42950000 GHz Stop Freq 2.44450000 GHz CF Step 1.50000000 MHz Auto Man Freq Offset 0.00000000 Hz Signal Track On Off</p>
2462	<p>Agilent T Freq/Channel Ref 20 dBm Atten 20 dB Mkr1 2.461 50 GHz *Peak 2.4620000 GHz Log 10 dB/Offst 11.3 dB LgAv M1 S2 S3 FC AL E(f): F Tun Swp Center 2.462 00 GHz Span 15 MHz *Res BW 100 kHz *VBW 300 kHz Sweep 1.44 ms (601 pts) Copyright 2000-2005 Agilent Technologies</p> <p>Center Freq 2.4620000 GHz Start Freq 2.45450000 GHz Stop Freq 2.46950000 GHz CF Step 1.50000000 MHz Auto Man Freq Offset 0.00000000 Hz Signal Track On Off</p>

Mode 3: IEEE 802.11g Link Mode

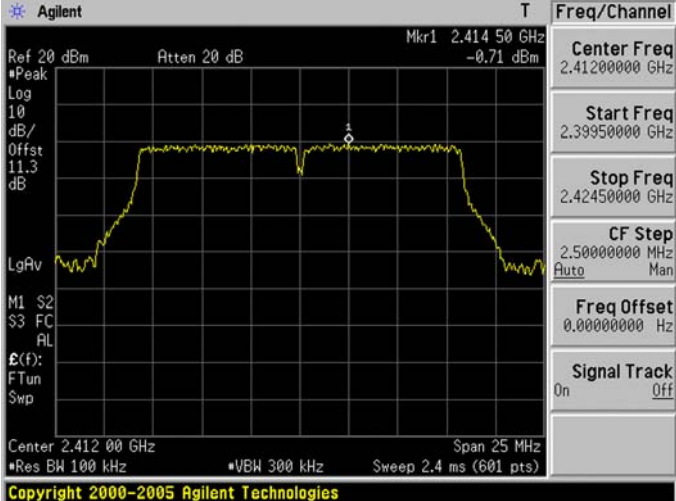
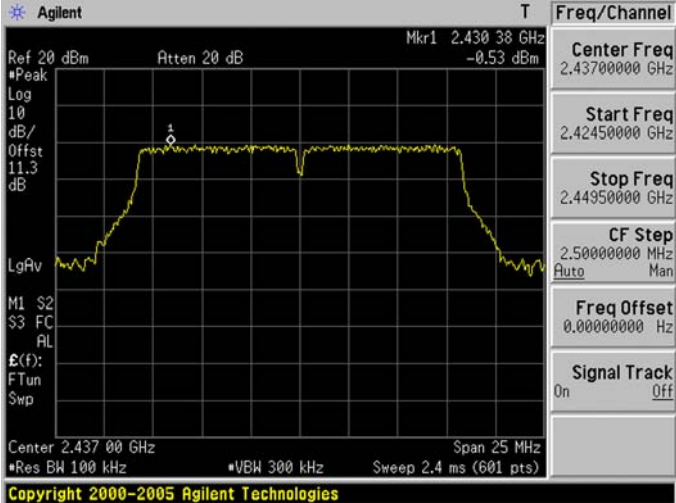
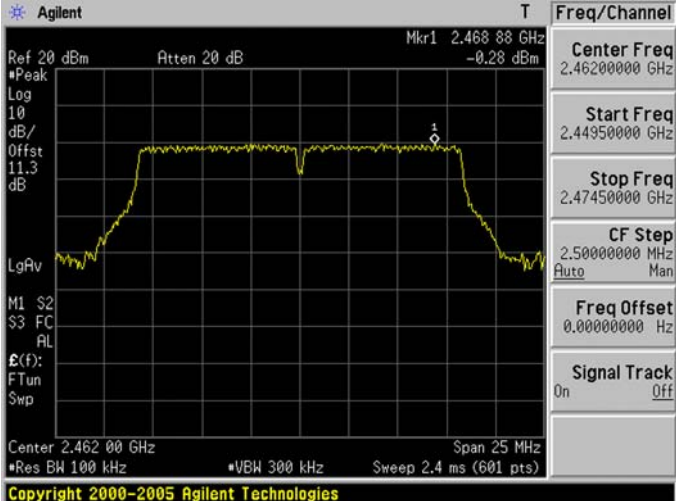
<p>2412</p>	 <p>Agilent T</p> <p>Ref 20 dBm Atten 20 dB Mkr1 2.414 50 GHz -0.71 dBm</p> <p>*Peak</p> <p>Log</p> <p>10</p> <p>dB/</p> <p>Offst</p> <p>11.3</p> <p>dB</p> <p>LgAv</p> <p>M1 S2</p> <p>S3 FC</p> <p>AL</p> <p>E(f):</p> <p>F Tun</p> <p>Swp</p> <p>Center 2.412 00 GHz Span 25 MHz</p> <p>*Res BW 100 kHz *VBW 300 kHz Sweep 2.4 ms (601 pts)</p> <p>Copyright 2000-2005 Agilent Technologies</p> <p>Freq/Channel</p> <p>Center Freq 2.41200000 GHz</p> <p>Start Freq 2.39950000 GHz</p> <p>Stop Freq 2.42450000 GHz</p> <p>CF Step 2.50000000 MHz Auto Man</p> <p>Freq Offset 0.00000000 Hz</p> <p>Signal Track On Off</p>
<p>2437</p>	 <p>Agilent T</p> <p>Ref 20 dBm Atten 20 dB Mkr1 2.430 38 GHz -0.53 dBm</p> <p>*Peak</p> <p>Log</p> <p>10</p> <p>dB/</p> <p>Offst</p> <p>11.3</p> <p>dB</p> <p>LgAv</p> <p>M1 S2</p> <p>S3 FC</p> <p>AL</p> <p>E(f):</p> <p>F Tun</p> <p>Swp</p> <p>Center 2.437 00 GHz Span 25 MHz</p> <p>*Res BW 100 kHz *VBW 300 kHz Sweep 2.4 ms (601 pts)</p> <p>Copyright 2000-2005 Agilent Technologies</p> <p>Freq/Channel</p> <p>Center Freq 2.43700000 GHz</p> <p>Start Freq 2.42450000 GHz</p> <p>Stop Freq 2.44950000 GHz</p> <p>CF Step 2.50000000 MHz Auto Man</p> <p>Freq Offset 0.00000000 Hz</p> <p>Signal Track On Off</p>
<p>2462</p>	 <p>Agilent T</p> <p>Ref 20 dBm Atten 20 dB Mkr1 2.468 88 GHz -0.28 dBm</p> <p>*Peak</p> <p>Log</p> <p>10</p> <p>dB/</p> <p>Offst</p> <p>11.3</p> <p>dB</p> <p>LgAv</p> <p>M1 S2</p> <p>S3 FC</p> <p>AL</p> <p>E(f):</p> <p>F Tun</p> <p>Swp</p> <p>Center 2.462 00 GHz Span 25 MHz</p> <p>*Res BW 100 kHz *VBW 300 kHz Sweep 2.4 ms (601 pts)</p> <p>Copyright 2000-2005 Agilent Technologies</p> <p>Freq/Channel</p> <p>Center Freq 2.46200000 GHz</p> <p>Start Freq 2.44950000 GHz</p> <p>Stop Freq 2.47450000 GHz</p> <p>CF Step 2.50000000 MHz Auto Man</p> <p>Freq Offset 0.00000000 Hz</p> <p>Signal Track On Off</p>

Mode 4: IEEE 802.11n 2.4GHz 20MHz Link Mode

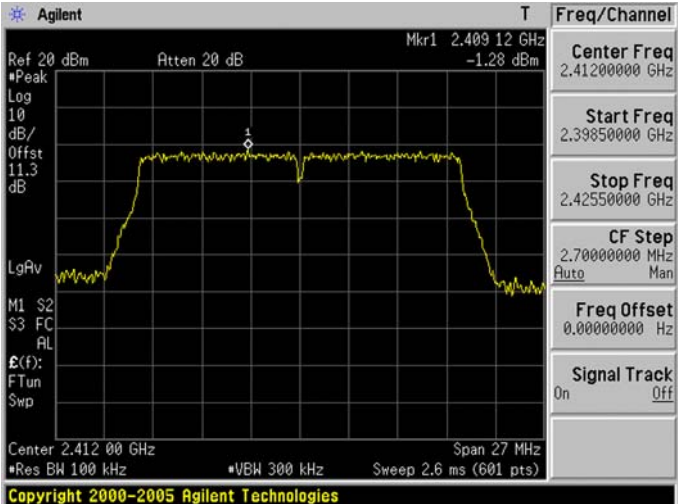
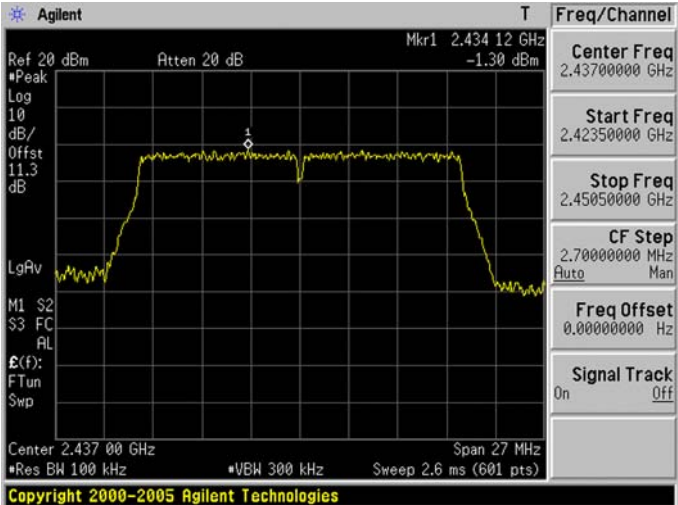
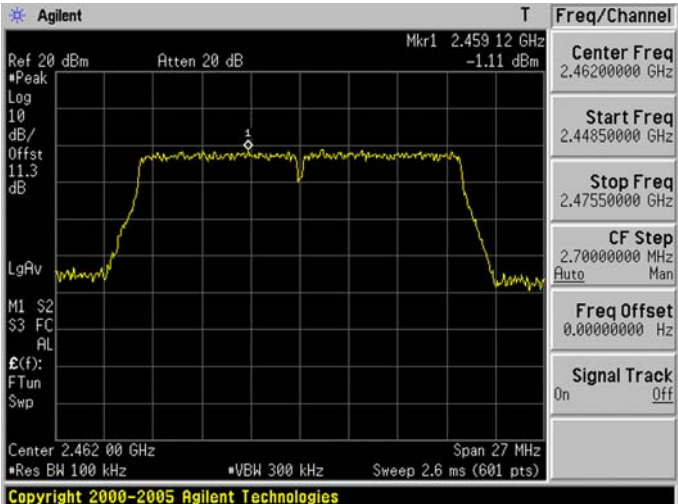
<p>2412</p>	 <p>Agilent T</p> <p>Ref 20 dBm Atten 20 dB Mkr1 2.409 12 GHz -1.28 dBm</p> <p>*Peak</p> <p>Log</p> <p>10</p> <p>dB/</p> <p>Offst</p> <p>11.3</p> <p>dB</p> <p>LgAv</p> <p>M1 S2</p> <p>S3 FC</p> <p>AL</p> <p>E(f):</p> <p>F Tun</p> <p>Swp</p> <p>Center 2.412 00 GHz Span 27 MHz</p> <p>*Res BW 100 kHz *VBW 300 kHz Sweep 2.6 ms (601 pts)</p> <p>Copyright 2000-2005 Agilent Technologies</p> <table border="1"> <thead> <tr> <th colspan="2">Freq/Channel</th> </tr> </thead> <tbody> <tr> <td>Center Freq</td> <td>2.41200000 GHz</td> </tr> <tr> <td>Start Freq</td> <td>2.39850000 GHz</td> </tr> <tr> <td>Stop Freq</td> <td>2.42550000 GHz</td> </tr> <tr> <td>CF Step</td> <td>2.70000000 MHz</td> </tr> <tr> <td></td> <td>Auto Man</td> </tr> <tr> <td>Freq Offset</td> <td>0.00000000 Hz</td> </tr> <tr> <td>Signal Track</td> <td>On Off</td> </tr> </tbody> </table>	Freq/Channel		Center Freq	2.41200000 GHz	Start Freq	2.39850000 GHz	Stop Freq	2.42550000 GHz	CF Step	2.70000000 MHz		Auto Man	Freq Offset	0.00000000 Hz	Signal Track	On Off
Freq/Channel																	
Center Freq	2.41200000 GHz																
Start Freq	2.39850000 GHz																
Stop Freq	2.42550000 GHz																
CF Step	2.70000000 MHz																
	Auto Man																
Freq Offset	0.00000000 Hz																
Signal Track	On Off																
<p>2437</p>	 <p>Agilent T</p> <p>Ref 20 dBm Atten 20 dB Mkr1 2.434 12 GHz -1.30 dBm</p> <p>*Peak</p> <p>Log</p> <p>10</p> <p>dB/</p> <p>Offst</p> <p>11.3</p> <p>dB</p> <p>LgAv</p> <p>M1 S2</p> <p>S3 FC</p> <p>AL</p> <p>E(f):</p> <p>F Tun</p> <p>Swp</p> <p>Center 2.437 00 GHz Span 27 MHz</p> <p>*Res BW 100 kHz *VBW 300 kHz Sweep 2.6 ms (601 pts)</p> <p>Copyright 2000-2005 Agilent Technologies</p> <table border="1"> <thead> <tr> <th colspan="2">Freq/Channel</th> </tr> </thead> <tbody> <tr> <td>Center Freq</td> <td>2.43700000 GHz</td> </tr> <tr> <td>Start Freq</td> <td>2.42350000 GHz</td> </tr> <tr> <td>Stop Freq</td> <td>2.45050000 GHz</td> </tr> <tr> <td>CF Step</td> <td>2.70000000 MHz</td> </tr> <tr> <td></td> <td>Auto Man</td> </tr> <tr> <td>Freq Offset</td> <td>0.00000000 Hz</td> </tr> <tr> <td>Signal Track</td> <td>On Off</td> </tr> </tbody> </table>	Freq/Channel		Center Freq	2.43700000 GHz	Start Freq	2.42350000 GHz	Stop Freq	2.45050000 GHz	CF Step	2.70000000 MHz		Auto Man	Freq Offset	0.00000000 Hz	Signal Track	On Off
Freq/Channel																	
Center Freq	2.43700000 GHz																
Start Freq	2.42350000 GHz																
Stop Freq	2.45050000 GHz																
CF Step	2.70000000 MHz																
	Auto Man																
Freq Offset	0.00000000 Hz																
Signal Track	On Off																
<p>2462</p>	 <p>Agilent T</p> <p>Ref 20 dBm Atten 20 dB Mkr1 2.459 12 GHz -1.11 dBm</p> <p>*Peak</p> <p>Log</p> <p>10</p> <p>dB/</p> <p>Offst</p> <p>11.3</p> <p>dB</p> <p>LgAv</p> <p>M1 S2</p> <p>S3 FC</p> <p>AL</p> <p>E(f):</p> <p>F Tun</p> <p>Swp</p> <p>Center 2.462 00 GHz Span 27 MHz</p> <p>*Res BW 100 kHz *VBW 300 kHz Sweep 2.6 ms (601 pts)</p> <p>Copyright 2000-2005 Agilent Technologies</p> <table border="1"> <thead> <tr> <th colspan="2">Freq/Channel</th> </tr> </thead> <tbody> <tr> <td>Center Freq</td> <td>2.46200000 GHz</td> </tr> <tr> <td>Start Freq</td> <td>2.44850000 GHz</td> </tr> <tr> <td>Stop Freq</td> <td>2.47550000 GHz</td> </tr> <tr> <td>CF Step</td> <td>2.70000000 MHz</td> </tr> <tr> <td></td> <td>Auto Man</td> </tr> <tr> <td>Freq Offset</td> <td>0.00000000 Hz</td> </tr> <tr> <td>Signal Track</td> <td>On Off</td> </tr> </tbody> </table>	Freq/Channel		Center Freq	2.46200000 GHz	Start Freq	2.44850000 GHz	Stop Freq	2.47550000 GHz	CF Step	2.70000000 MHz		Auto Man	Freq Offset	0.00000000 Hz	Signal Track	On Off
Freq/Channel																	
Center Freq	2.46200000 GHz																
Start Freq	2.44850000 GHz																
Stop Freq	2.47550000 GHz																
CF Step	2.70000000 MHz																
	Auto Man																
Freq Offset	0.00000000 Hz																
Signal Track	On Off																

Mode 5: IEEE 802.11n 2.4GHz 40MHz Link Mode

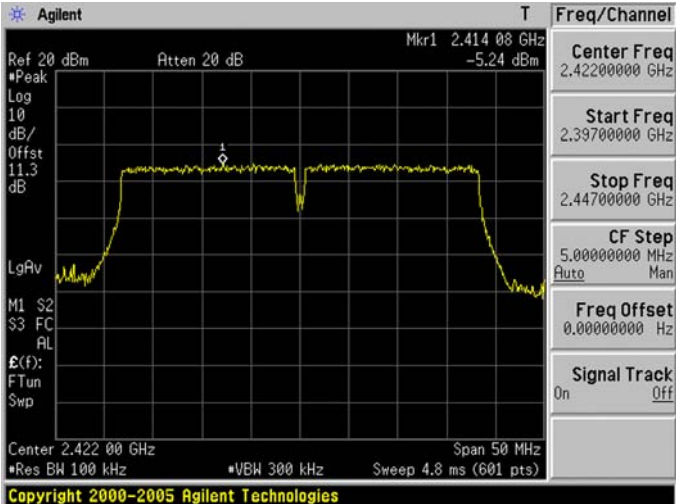
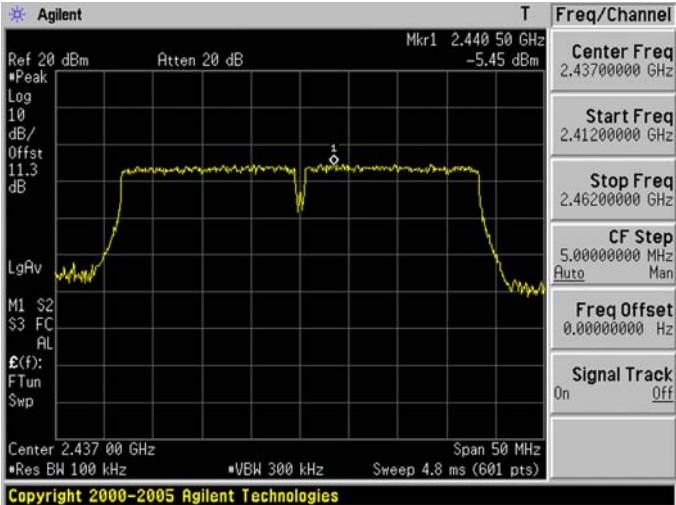
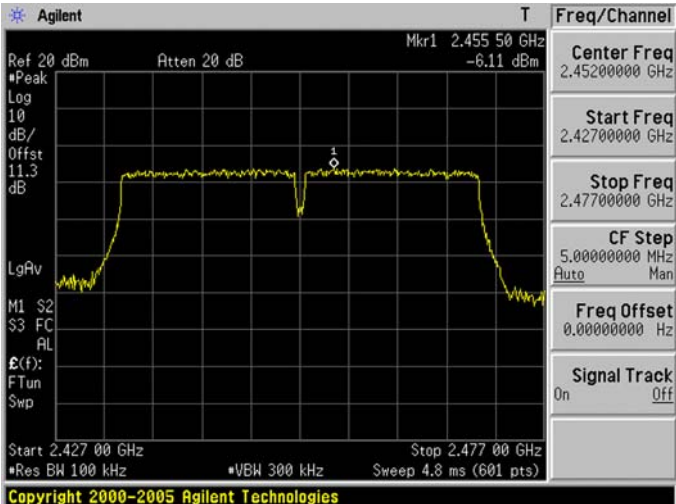
<p>2422</p>	 <p>Agilent T</p> <p>Ref 20 dBm Atten 20 dB Mkr1 2.414 08 GHz -5.24 dBm</p> <p>*Peak</p> <p>Log</p> <p>10</p> <p>dB/</p> <p>Offst</p> <p>11.3</p> <p>dB</p> <p>LgAv</p> <p>M1 S2</p> <p>S3 FC</p> <p>AL</p> <p>E(f):</p> <p>F Tun</p> <p>Swp</p> <p>Center 2.422 00 GHz Span 50 MHz</p> <p>*Res BW 100 kHz *VBW 300 kHz Sweep 4.8 ms (601 pts)</p> <p>Copyright 2000-2005 Agilent Technologies</p> <p>Freq/Channel</p> <p>Center Freq 2.42200000 GHz</p> <p>Start Freq 2.39700000 GHz</p> <p>Stop Freq 2.44700000 GHz</p> <p>CF Step 5.00000000 MHz Auto Man</p> <p>Freq Offset 0.00000000 Hz</p> <p>Signal Track On Off</p>
<p>2437</p>	 <p>Agilent T</p> <p>Ref 20 dBm Atten 20 dB Mkr1 2.440 50 GHz -5.45 dBm</p> <p>*Peak</p> <p>Log</p> <p>10</p> <p>dB/</p> <p>Offst</p> <p>11.3</p> <p>dB</p> <p>LgAv</p> <p>M1 S2</p> <p>S3 FC</p> <p>AL</p> <p>E(f):</p> <p>F Tun</p> <p>Swp</p> <p>Center 2.437 00 GHz Span 50 MHz</p> <p>*Res BW 100 kHz *VBW 300 kHz Sweep 4.8 ms (601 pts)</p> <p>Copyright 2000-2005 Agilent Technologies</p> <p>Freq/Channel</p> <p>Center Freq 2.43700000 GHz</p> <p>Start Freq 2.41200000 GHz</p> <p>Stop Freq 2.46200000 GHz</p> <p>CF Step 5.00000000 MHz Auto Man</p> <p>Freq Offset 0.00000000 Hz</p> <p>Signal Track On Off</p>
<p>2452</p>	 <p>Agilent T</p> <p>Ref 20 dBm Atten 20 dB Mkr1 2.455 50 GHz -6.11 dBm</p> <p>*Peak</p> <p>Log</p> <p>10</p> <p>dB/</p> <p>Offst</p> <p>11.3</p> <p>dB</p> <p>LgAv</p> <p>M1 S2</p> <p>S3 FC</p> <p>AL</p> <p>E(f):</p> <p>F Tun</p> <p>Swp</p> <p>Start 2.427 00 GHz Stop 2.477 00 GHz</p> <p>*Res BW 100 kHz *VBW 300 kHz Sweep 4.8 ms (601 pts)</p> <p>Copyright 2000-2005 Agilent Technologies</p> <p>Freq/Channel</p> <p>Center Freq 2.45200000 GHz</p> <p>Start Freq 2.42700000 GHz</p> <p>Stop Freq 2.47700000 GHz</p> <p>CF Step 5.00000000 MHz Auto Man</p> <p>Freq Offset 0.00000000 Hz</p> <p>Signal Track On Off</p>

9 Out of Band Conducted Emissions Measurement

9.1. Limit

In any 100 kHz bandwidth outside the frequency band in which the spread spectrum or digitally modulated intentional radiator is operating, the radio frequency power that is produced by the intentional radiator shall be at least 20 dB below that in the 100 kHz bandwidth within the band that contains the highest level of the desired power

9.2. Test Setup

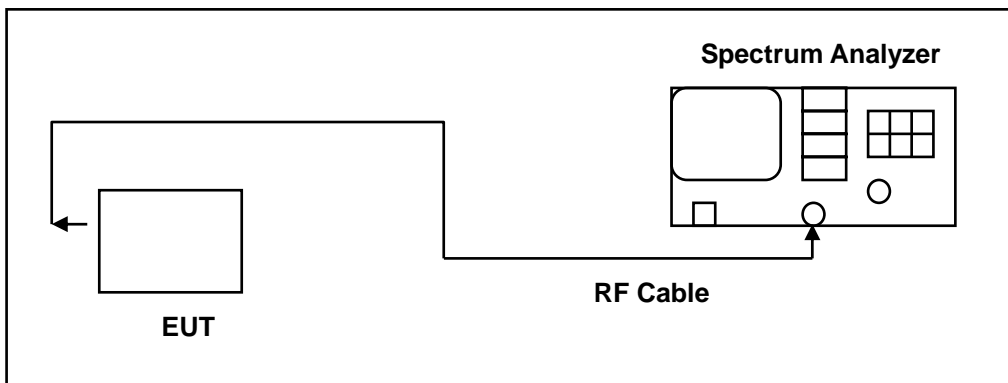

9.3. Test Instruments

Equipment	Manufacturer	Model Number	Serial Number	Cal. Date	Remark
Spectrum Analyzer	Agilent	E4445A	MY45300744	12/19/2012	(2)
Spectrum Analyzer	Agilent	E4408B	MY45107753	07/24/2014	(1)
Test Site	ATL	TE05	TE05	N.C.R.	-----

Remark: (1) Calibration period 1 year. (2) Calibration period 2 years. (3) Calibration period 3 years.

Note: N.C.R. = No Calibration Request.

9.4. Test Procedure

In any 100 kHz bandwidth outside the EUT pass band, the RF power produced by the modulation products of the spreading sequence, the information sequence, and the carrier frequency shall be at least 20 dB below that of the maximum in-band 100 kHz emission, antenna output of the EUT was coupled directly to spectrum analyzer; if an external attenuator and/or cable was used, these losses are compensated for with the analyzer OFFSET function.

All other types of emissions from the EUT shall meet the general limits for radiated frequencies outside the pass band.

The test was performed at 3 channels.

9.5. Test Graphs

Reference level

Mode 2: IEEE 802.11b Link Mode	
2412	
2437	
2462	

Mode 3: IEEE 802.11g Link Mode

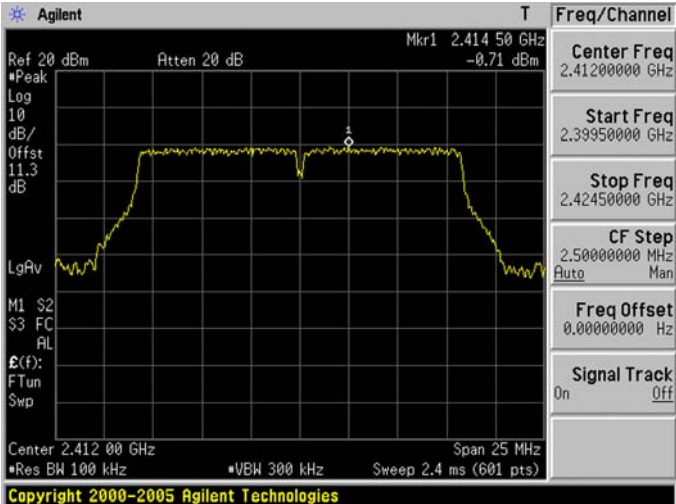
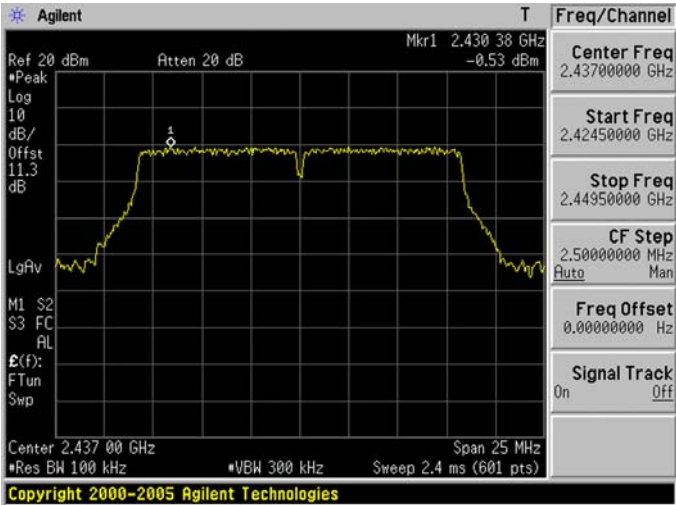
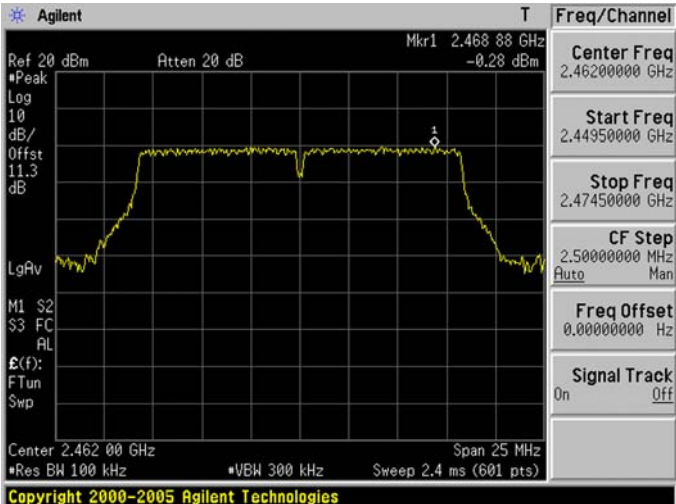
2412	 <p>Agilent T Freq/Channel</p> <p>Ref 20 dBm Atten 20 dB Mkr1 2.414 50 GHz *Peak -0.71 dBm Center Freq 2.41200000 GHz</p> <p>Start Freq 2.39950000 GHz</p> <p>Stop Freq 2.42450000 GHz</p> <p>CF Step 2.50000000 MHz Auto Man</p> <p>Freq Offset 0.00000000 Hz</p> <p>Signal Track On Off</p> <p>Center 2.412 00 GHz Span 25 MHz *Res BW 100 kHz *VBW 300 kHz Sweep 2.4 ms (601 pts)</p> <p>Copyright 2000-2005 Agilent Technologies</p>
2437	 <p>Agilent T Freq/Channel</p> <p>Ref 20 dBm Atten 20 dB Mkr1 2.430 38 GHz *Peak -0.53 dBm Center Freq 2.43700000 GHz</p> <p>Start Freq 2.42450000 GHz</p> <p>Stop Freq 2.44950000 GHz</p> <p>CF Step 2.50000000 MHz Auto Man</p> <p>Freq Offset 0.00000000 Hz</p> <p>Signal Track On Off</p> <p>Center 2.437 00 GHz Span 25 MHz *Res BW 100 kHz *VBW 300 kHz Sweep 2.4 ms (601 pts)</p> <p>Copyright 2000-2005 Agilent Technologies</p>
2462	 <p>Agilent T Freq/Channel</p> <p>Ref 20 dBm Atten 20 dB Mkr1 2.468 88 GHz *Peak -0.28 dBm Center Freq 2.46200000 GHz</p> <p>Start Freq 2.44950000 GHz</p> <p>Stop Freq 2.47450000 GHz</p> <p>CF Step 2.50000000 MHz Auto Man</p> <p>Freq Offset 0.00000000 Hz</p> <p>Signal Track On Off</p> <p>Center 2.462 00 GHz Span 25 MHz *Res BW 100 kHz *VBW 300 kHz Sweep 2.4 ms (601 pts)</p> <p>Copyright 2000-2005 Agilent Technologies</p>

Mode 4: IEEE 802.11n 2.4GHz 20MHz Link Mode

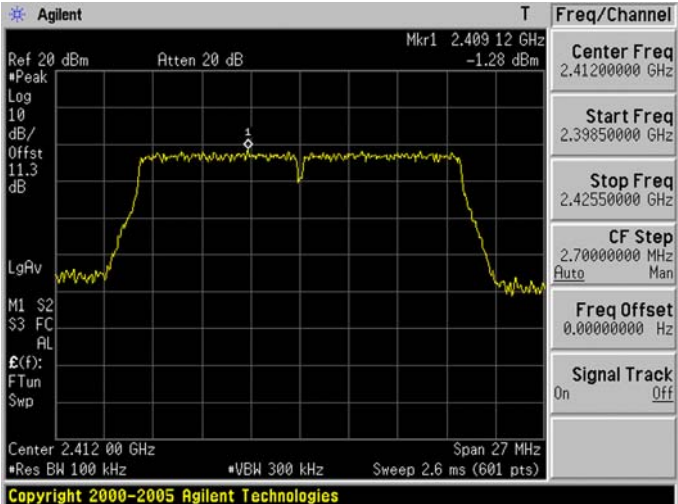
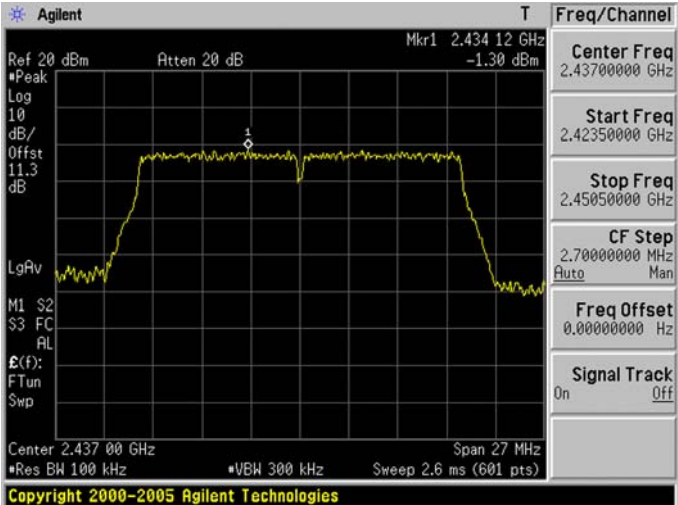
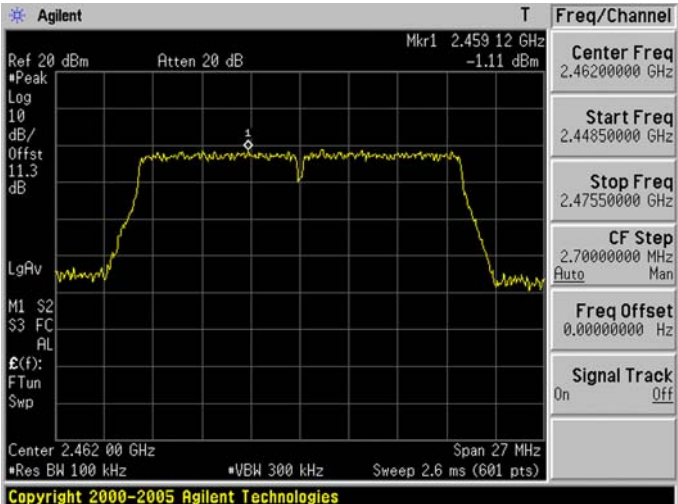
<p>2412</p>	 <p>Agilent T</p> <p>Ref 20 dBm Atten 20 dB Mkr1 2.409 12 GHz -1.28 dBm</p> <p>*Peak</p> <p>Log</p> <p>10</p> <p>dB/</p> <p>Offst</p> <p>11.3</p> <p>dB</p> <p>LgAv</p> <p>M1 S2</p> <p>S3 FC</p> <p>AL</p> <p>E(f):</p> <p>F Tun</p> <p>Swp</p> <p>Center 2.412 00 GHz Span 27 MHz</p> <p>*Res BW 100 kHz *VBW 300 kHz Sweep 2.6 ms (601 pts)</p> <p>Copyright 2000-2005 Agilent Technologies</p> <p>Freq/Channel</p> <p>Center Freq 2.41200000 GHz</p> <p>Start Freq 2.39850000 GHz</p> <p>Stop Freq 2.42550000 GHz</p> <p>CF Step 2.70000000 MHz Auto Man</p> <p>Freq Offset 0.00000000 Hz</p> <p>Signal Track On Off</p>
<p>2437</p>	 <p>Agilent T</p> <p>Ref 20 dBm Atten 20 dB Mkr1 2.434 12 GHz -1.30 dBm</p> <p>*Peak</p> <p>Log</p> <p>10</p> <p>dB/</p> <p>Offst</p> <p>11.3</p> <p>dB</p> <p>LgAv</p> <p>M1 S2</p> <p>S3 FC</p> <p>AL</p> <p>E(f):</p> <p>F Tun</p> <p>Swp</p> <p>Center 2.437 00 GHz Span 27 MHz</p> <p>*Res BW 100 kHz *VBW 300 kHz Sweep 2.6 ms (601 pts)</p> <p>Copyright 2000-2005 Agilent Technologies</p> <p>Freq/Channel</p> <p>Center Freq 2.43700000 GHz</p> <p>Start Freq 2.42350000 GHz</p> <p>Stop Freq 2.45050000 GHz</p> <p>CF Step 2.70000000 MHz Auto Man</p> <p>Freq Offset 0.00000000 Hz</p> <p>Signal Track On Off</p>
<p>2462</p>	 <p>Agilent T</p> <p>Ref 20 dBm Atten 20 dB Mkr1 2.459 12 GHz -1.11 dBm</p> <p>*Peak</p> <p>Log</p> <p>10</p> <p>dB/</p> <p>Offst</p> <p>11.3</p> <p>dB</p> <p>LgAv</p> <p>M1 S2</p> <p>S3 FC</p> <p>AL</p> <p>E(f):</p> <p>F Tun</p> <p>Swp</p> <p>Center 2.462 00 GHz Span 27 MHz</p> <p>*Res BW 100 kHz *VBW 300 kHz Sweep 2.6 ms (601 pts)</p> <p>Copyright 2000-2005 Agilent Technologies</p> <p>Freq/Channel</p> <p>Center Freq 2.46200000 GHz</p> <p>Start Freq 2.44850000 GHz</p> <p>Stop Freq 2.47550000 GHz</p> <p>CF Step 2.70000000 MHz Auto Man</p> <p>Freq Offset 0.00000000 Hz</p> <p>Signal Track On Off</p>

Mode 5: IEEE 802.11n 2.4GHz 40MHz Link Mode

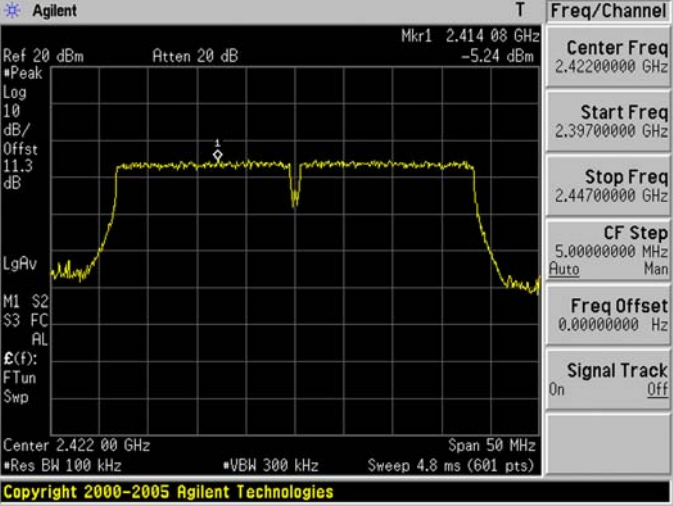
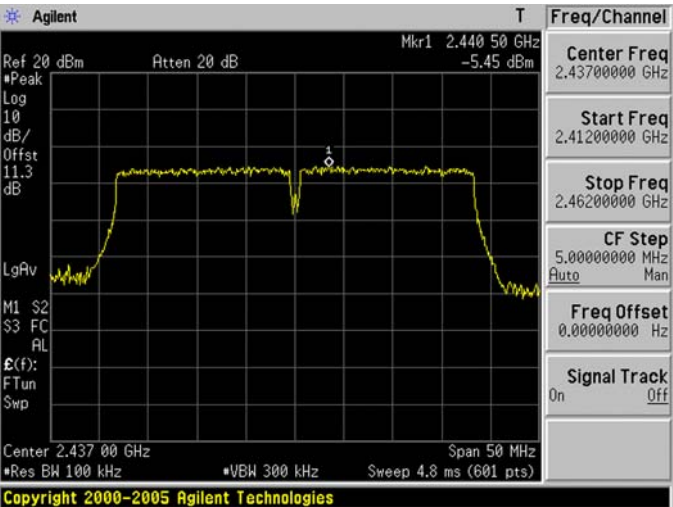
<p>2422</p>	 <p>Copyright 2000-2005 Agilent Technologies</p>
<p>2437</p>	 <p>Copyright 2000-2005 Agilent Technologies</p>
<p>2452</p>	 <p>Copyright 2000-2005 Agilent Technologies</p>

Out of Band Conducted Emissions

Mode 2: IEEE 802.11b Link Mode

2412



2437

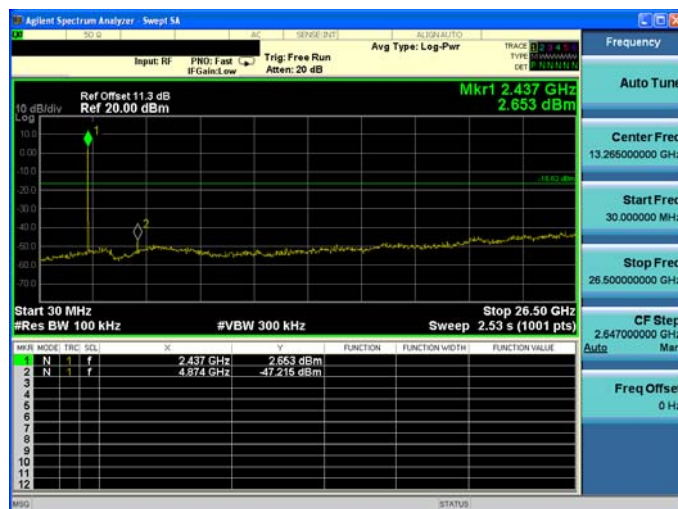

2462

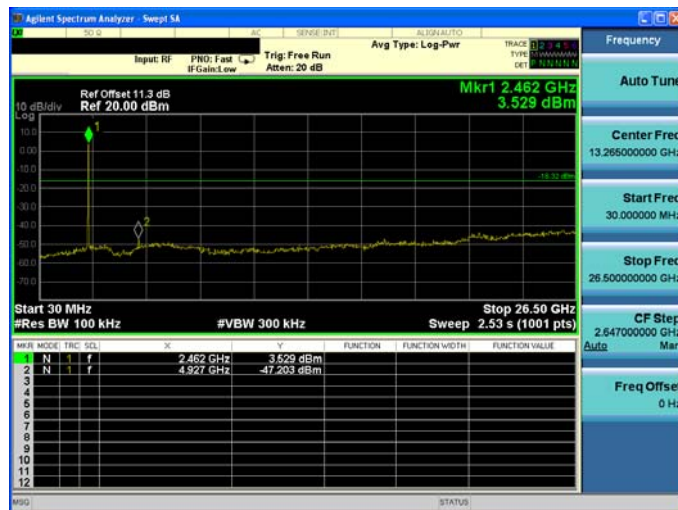

Mode 3: IEEE 802.11g Link Mode

2412

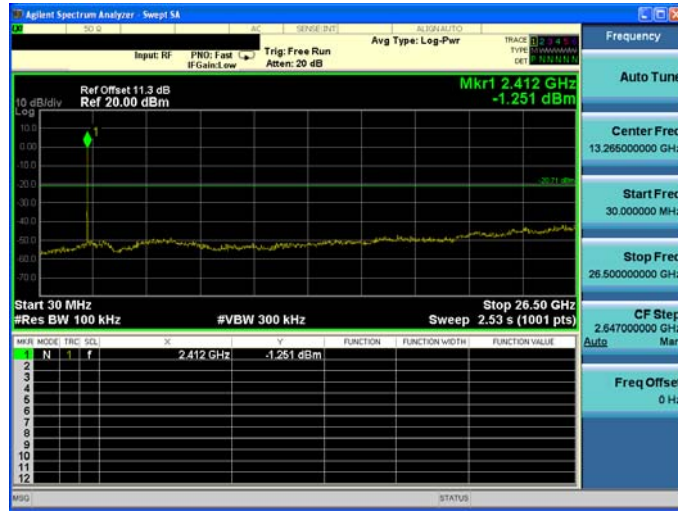

2437

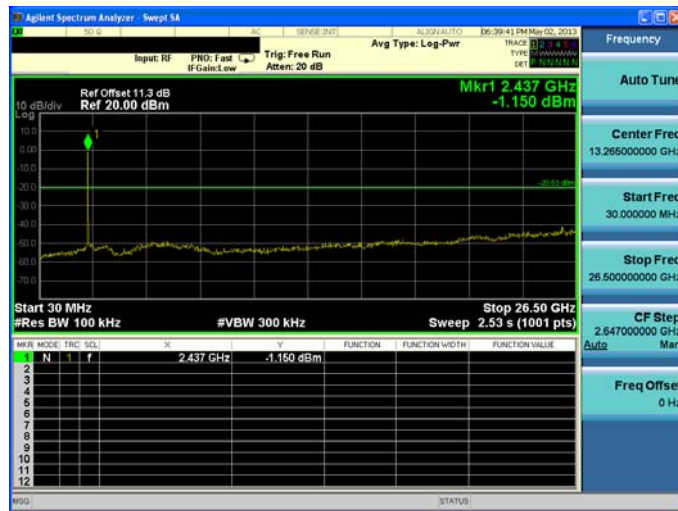

2462

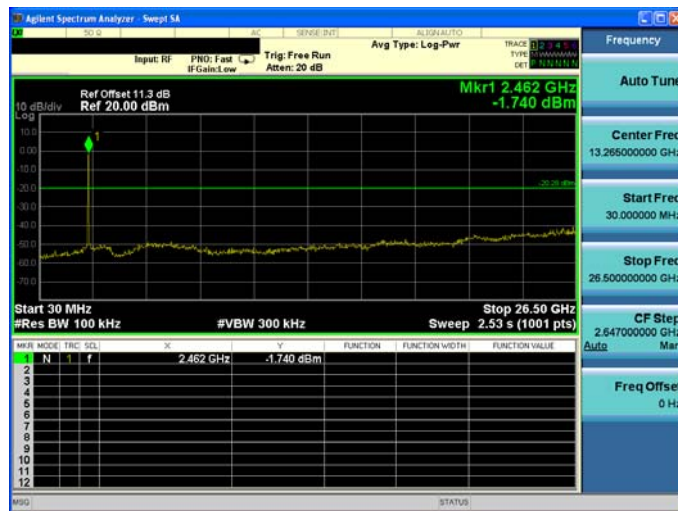

Mode 4: IEEE 802.11n 2.4GHz 20MHz Link Mode

2412



2437



2462

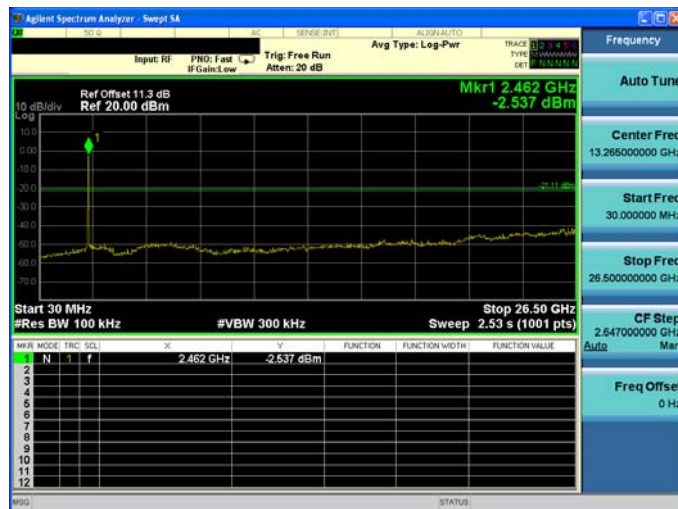

Mode 5: IEEE 802.11n 2.4GHz 40MHz Link Mode

2422



2437



2452



Conducted Band Edge

Mode 2: IEEE 802.11b Link Mode

2412

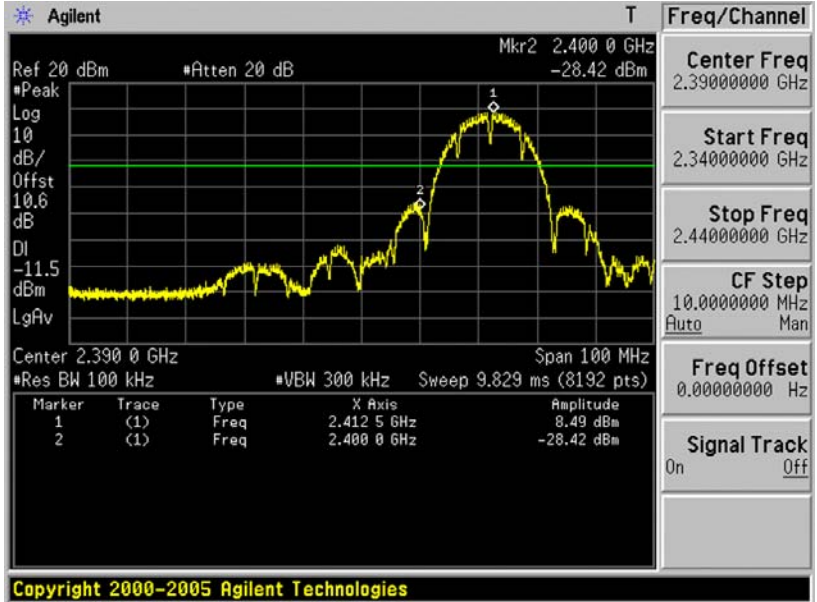

2462

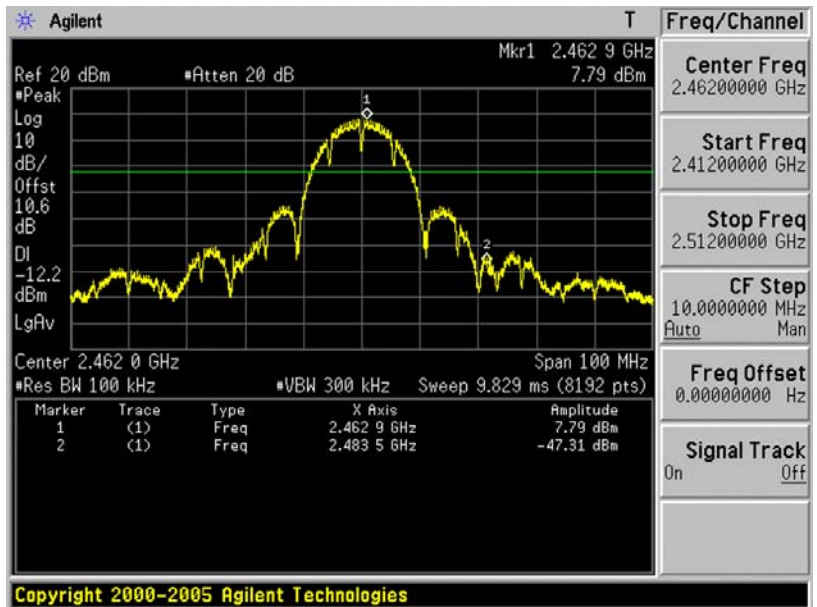

Mode 3: IEEE 802.11g Link Mode

2412

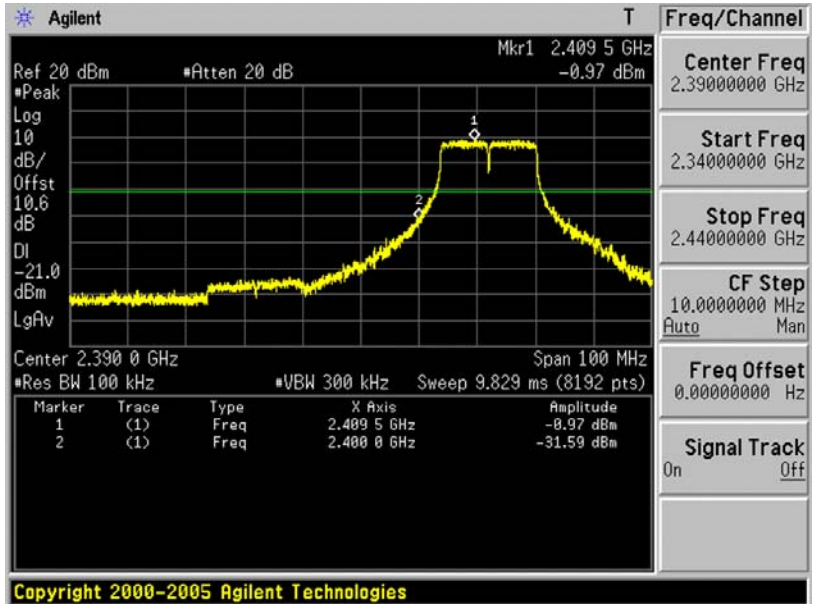

2462

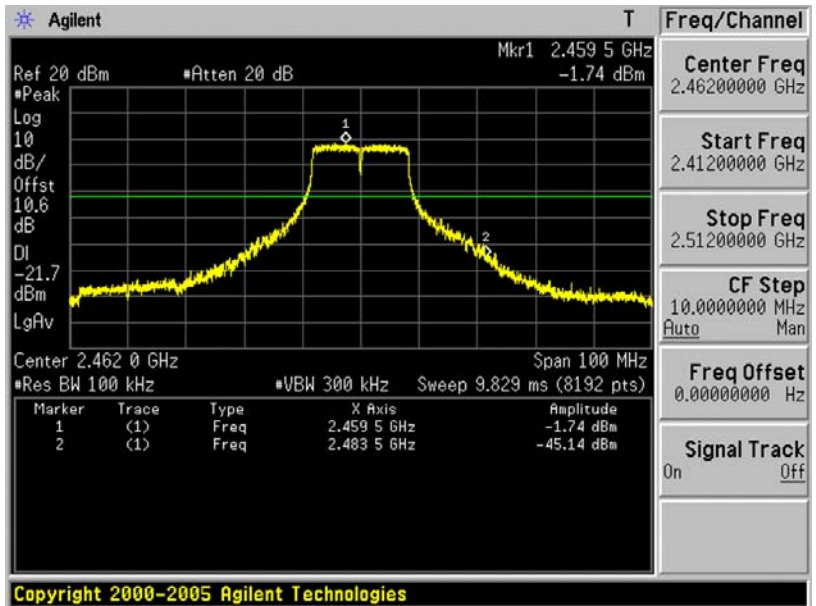

Mode 4: IEEE 802.11n 2.4GHz 20MHz Link Mode

2412

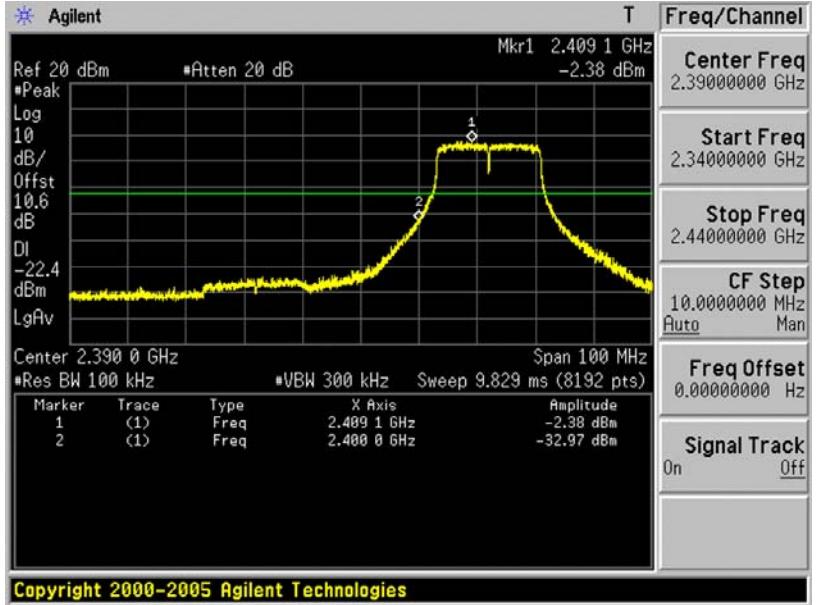

2462

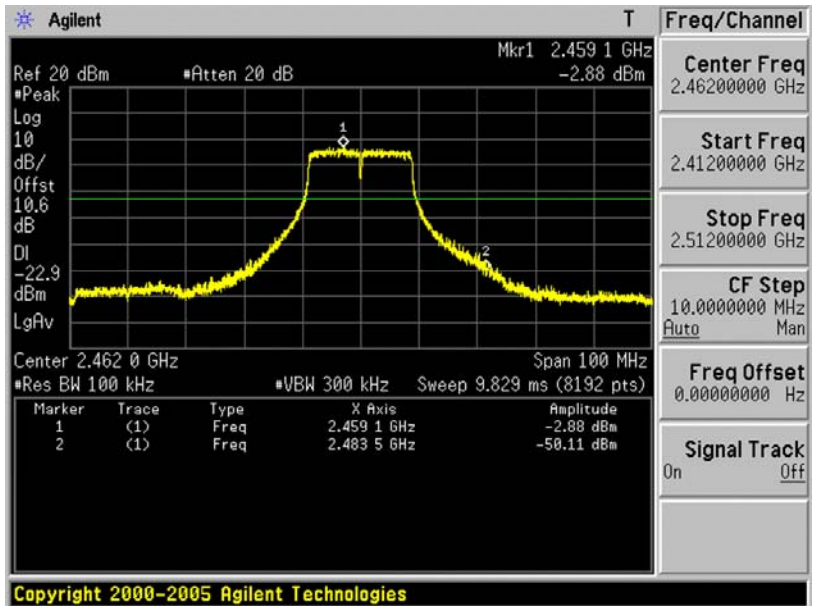

Mode 5: IEEE 802.11n 2.4GHz 40MHz Link Mode

2422

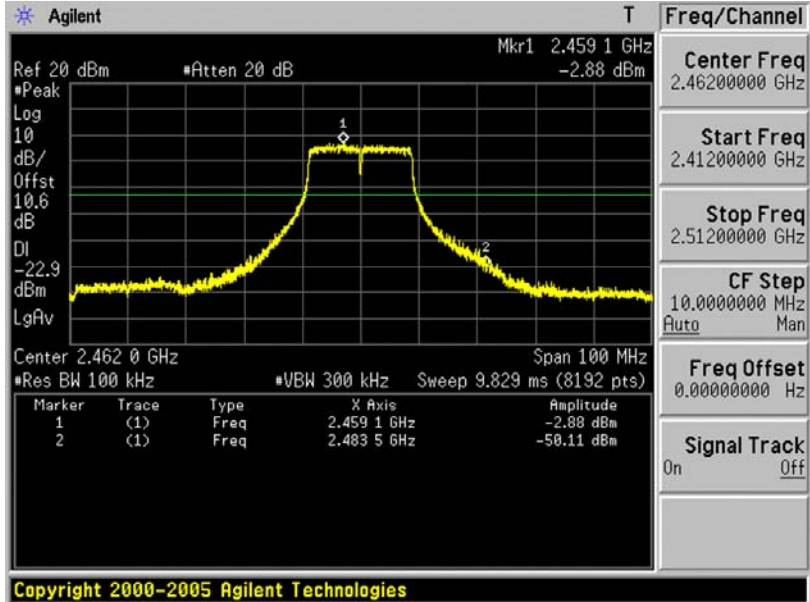

2452

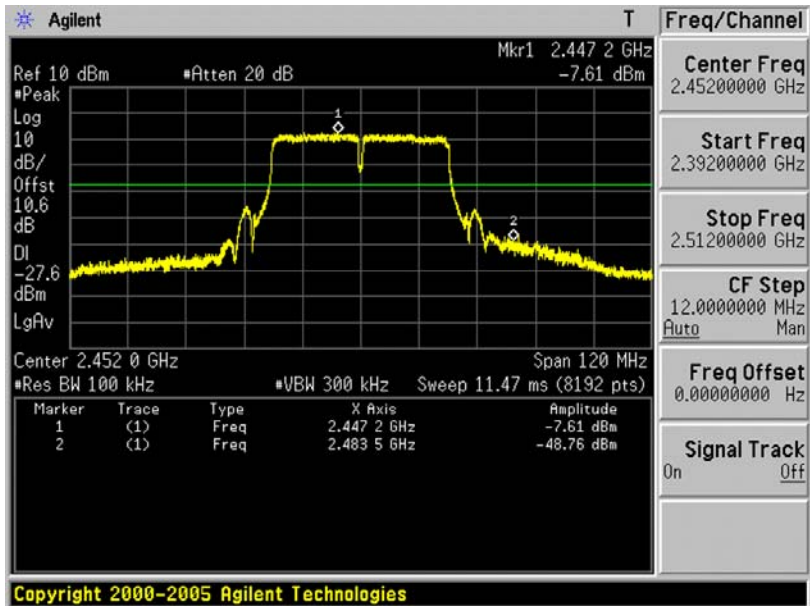

10 Band Edges Measurement

10.1.Limit

In any 100 kHz bandwidth outside the intentional radiation frequency band, the radio frequency power shall be at least 20 dB below the highest level of the radiated power. In addition, radiated emissions which fall in the restricted bands must also comply with the radiated emission limits.

10.2.Test Setup

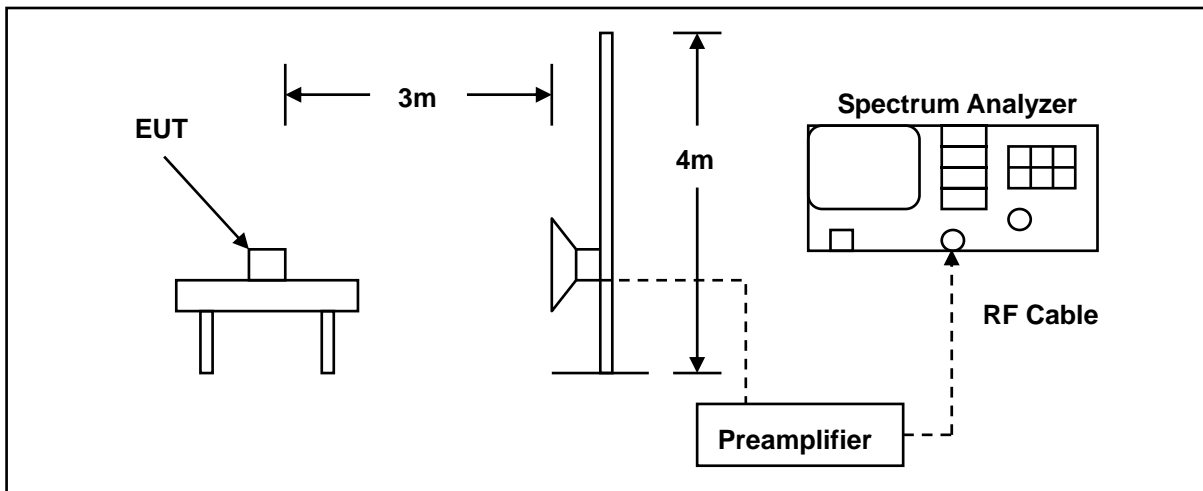

10.3.Test Instruments

3 Meter Chamber					
Equipment	Manufacturer	Model Number	Serial Number	Cal. Date	Remark
RF Pre-selector	Agilent	N9039A	MY46520256	01/10/2014	(1)
Spectrum Analyzer	Agilent	E4446A	MY46180578	01/10/2014	(1)
Pre Amplifier	Agilent	8449B	3008A02237	02/21/2014	(1)
Pre Amplifier	Agilent	8447D	2944A10961	02/21/2014	(1)
Horn Antenna (1~18GHz)	SCHWARZBECK MESS-ELEKTRONIK	BBHA9120D	9120D-550	06/11/2014	(1)
Test Site	ATL	TE01	888001	08/28/2014	(1)

Remark: (1) Calibration period 1 year. (2) Calibration period 2 years. (3) Calibration period 3 years.

Note: N.C.R. = No Calibration Request.

10.4. Test Procedure

The EUT was setup to ANSI C63.4, 2009; tested to DTS test procedure of KDB558074D01 for compliance to FCC 47CFR 15.247 requirements.

The emissions on the harmonics frequencies, the limits, and the margin of compliance are presented. These tests were made when the transmitter was in full radiated power. The additional test was performed to show compliance with the requirement at the band-edge frequency 2483.5 MHz and up to 2500 MHz and at 2390.0 MHz.

The transmitter was configured with the worst case antenna and setup to transmit at the highest channel. Then the field strength was measured at 2483.5 MHz.

The transmitter was then configured with the worst case antenna and setup to transmit at the lowest channel. Then the field strength was measured at 2390.0 MHz. These tests were performed at 4 different bit rates.

For measurements the resolution bandwidth is set to 1 MHz, and then the video bandwidth is set to 1 MHz for peak measurements and 10 Hz for average measurements.

10.5. Test Result

Standard:	FCC Part 15C		Test Distance:	3m			
Test item:	Radiated Emission		Power:	AC 120V/60Hz			
Model Number:	PS5 SPEAKER		Temp.(°C)/Hum.(%RH):	26(°C)/60%RH			
Mode:	2		Date:	10/28/2014			
Frequency:	2412 MHz		Test By:	Eric Ou Yang			
Frequency (MHz)	Reading (dBuV)	Correct Factor (dB/m)	Result (dBuV/m)	Limit (dBuV/m)	Margin (dB)	Remark	Ant.Polar. H / V
2389.310	49.47	3.88	53.35	74.00	-20.65	peak	H
2389.310	38.39	3.88	42.27	54.00	-11.73	AVG	H
2390.000	48.76	3.88	52.64	74.00	-21.36	peak	H
2390.000	38.41	3.88	42.29	54.00	-11.71	AVG	H
2376.990	49.37	3.79	53.16	74.00	-20.84	peak	V
2376.990	36.55	3.79	40.34	54.00	-13.66	AVG	V
2390.000	47.95	3.88	51.83	74.00	-22.17	peak	V

Standard:	FCC Part 15C		Test Distance:	3m			
Test item:	Radiated Emission		Power:	AC 120V/60Hz			
Model Number:	PS5 SPEAKER		Temp.(°C)/Hum.(%RH):	26(°C)/60%RH			
Mode:	2		Date:	10/28/2014			
Frequency:	2462 MHz		Test By:	Eric Ou Yang			
Frequency (MHz)	Reading (dBuV)	Correct Factor (dB/m)	Result (dBuV/m)	Limit (dBuV/m)	Margin (dB)	Remark	Ant.Polar. H / V
2483.500	48.25	4.50	52.75	74.00	-21.25	peak	H
2483.500	37.08	4.50	41.58	54.00	-12.42	AVG	H
2483.960	50.26	4.51	54.77	74.00	-19.23	peak	H
2483.960	37.01	4.51	41.52	54.00	-12.48	AVG	H
2483.500	47.08	4.50	51.58	74.00	-22.42	peak	V
2488.840	49.81	4.55	54.36	74.00	-19.64	peak	V
2488.840	36.87	4.55	41.42	54.00	-12.58	AVG	V

Standard:	FCC Part 15C			Test Distance:	3m		
Test item:	Radiated Emission			Power:	AC 120V/60Hz		
Model Number:	PS5 SPEAKER			Temp.(°C)/Hum.(%RH):	26(°C)/60%RH		
Mode:	3			Date:	10/28/2014		
Frequency:	2412 MHz			Test By:	Eric Ou Yang		
Frequency (MHz)	Reading (dBuV)	Correct Factor (dB/m)	Result (dBuV/m)	Limit (dBuV/m)	Margin (dB)	Remark	Ant.Polar. H / V
2388.980	58.38	3.88	62.26	74.00	-11.74	peak	H
2388.980	45.26	3.88	49.14	54.00	-4.86	AVG	H
2390.000	56.89	3.88	60.77	74.00	-13.23	peak	H
2390.000	46.28	3.88	50.16	54.00	-3.84	AVG	H
2389.530	54.36	3.88	58.24	74.00	-15.76	peak	V
2389.530	42.73	3.88	46.61	54.00	-7.39	AVG	V
2390.000	53.61	3.88	57.49	74.00	-16.51	peak	V
2390.000	43.07	3.88	46.95	54.00	-7.05	AVG	V

Standard:	FCC Part 15C			Test Distance:	3m		
Test item:	Radiated Emission			Power:	AC 120V/60Hz		
Model Number:	PS5 SPEAKER			Temp.(°C)/Hum.(%RH):	26(°C)/60%RH		
Mode:	3			Date:	10/28/2014		
Frequency:	2462 MHz			Test By:	Eric Ou Yang		
Frequency (MHz)	Reading (dBuV)	Correct Factor (dB/m)	Result (dBuV/m)	Limit (dBuV/m)	Margin (dB)	Remark	Ant.Polar. H / V
2483.500	59.15	4.50	63.65	74.00	-10.35	peak	H
2483.500	44.98	4.50	49.48	54.00	-4.52	AVG	H
2483.680	59.09	4.50	63.59	74.00	-10.41	peak	H
2483.680	44.74	4.50	49.24	54.00	-4.76	AVG	H
2483.500	57.53	4.50	62.03	74.00	-11.97	peak	V
2483.500	44.97	4.50	49.47	54.00	-4.53	AVG	V
2483.920	57.13	4.51	61.64	74.00	-12.36	peak	V
2483.920	44.11	4.51	48.62	54.00	-5.38	AVG	V

Standard:	FCC Part 15C		Test Distance:	3m			
Test item:	Radiated Emission		Power:	AC 120V/60Hz			
Model Number:	PS5 SPEAKER		Temp.(°C)/Hum.(%RH):	26(°C)/60%RH			
Mode:	4		Date:	10/28/2014			
Frequency:	2412 MHz		Test By:	Eric Ou Yang			
Frequency (MHz)	Reading (dBuV)	Correct Factor (dB/m)	Result (dBuV/m)	Limit (dBuV/m)	Margin (dB)	Remark	Ant.Polar. H / V
2389.530	56.65	3.88	60.53	74.00	-13.47	peak	H
2389.530	44.63	3.88	48.51	54.00	-5.49	AVG	H
2390.000	55.45	3.88	59.33	74.00	-14.67	peak	H
2390.000	45.20	3.88	49.08	54.00	-4.92	AVG	H
2383.260	53.22	3.83	57.05	74.00	-16.95	peak	V
2383.260	39.09	3.83	42.92	54.00	-11.08	AVG	V
2390.000	52.05	3.88	55.93	74.00	-18.07	peak	V
2390.000	41.91	3.88	45.79	54.00	-8.21	AVG	V

Standard:	FCC Part 15C		Test Distance:	3m			
Test item:	Radiated Emission		Power:	AC 120V/60Hz			
Model Number:	PS5 SPEAKER		Temp.(°C)/Hum.(%RH):	26(°C)/60%RH			
Mode:	4		Date:	10/28/2014			
Frequency:	2462 MHz		Test By:	Eric Ou Yang			
Frequency (MHz)	Reading (dBuV)	Correct Factor (dB/m)	Result (dBuV/m)	Limit (dBuV/m)	Margin (dB)	Remark	Ant.Polar. H / V
2483.500	53.10	4.50	57.60	74.00	-16.40	peak	H
2483.500	42.00	4.50	46.50	54.00	-7.50	AVG	H
2484.760	56.48	4.51	60.99	74.00	-13.01	peak	H
2484.760	41.21	4.51	45.72	54.00	-8.28	AVG	H
2483.500	53.49	4.50	57.99	74.00	-16.01	peak	V
2483.500	42.69	4.50	47.19	54.00	-6.81	AVG	V
2485.160	54.61	4.52	59.13	74.00	-14.87	peak	V
2485.160	41.59	4.52	46.11	54.00	-7.89	AVG	V

Standard:	FCC Part 15C			Test Distance:	3m		
Test item:	Radiated Emission			Power:	AC 120V/60Hz		
Model Number:	PS5 SPEAKER			Temp.(°C)/Hum.(%RH):	26(°C)/60%RH		
Mode:	5			Date:	10/28/2014		
Frequency:	2422 MHz			Test By:	Eric Ou Yang		
Frequency (MHz)	Reading (dBuV)	Correct Factor (dB/m)	Result (dBuV/m)	Limit (dBuV/m)	Margin (dB)	Remark	Ant.Polar. H / V
2385.720	59.57	3.85	63.42	74.00	-10.58	peak	H
2385.720	46.26	3.85	50.11	54.00	-3.89	AVG	H
2390.000	59.43	3.88	63.31	74.00	-10.69	peak	H
2390.000	48.86	3.88	52.74	54.00	-1.26	AVG	H
2388.120	55.72	3.86	59.58	74.00	-14.42	peak	V
2388.120	43.60	3.86	47.46	54.00	-6.54	AVG	V
2390.000	54.89	3.88	58.77	74.00	-15.23	peak	V
2390.000	44.61	3.88	48.49	54.00	-5.51	AVG	V

Standard:	FCC Part 15C			Test Distance:	3m		
Test item:	Radiated Emission			Power:	AC 120V/60Hz		
Model Number:	PS5 SPEAKER			Temp.(°C)/Hum.(%RH):	26(°C)/60%RH		
Mode:	5			Date:	10/28/2014		
Frequency:	2452 MHz			Test By:	Eric Ou Yang		
Frequency (MHz)	Reading (dBuV)	Correct Factor (dB/m)	Result (dBuV/m)	Limit (dBuV/m)	Margin (dB)	Remark	Ant.Polar. H / V
2483.500	54.85	4.50	59.35	74.00	-14.65	peak	H
2483.500	45.03	4.50	49.53	54.00	-4.47	AVG	H
2487.900	57.03	4.53	61.56	74.00	-12.44	peak	H
2487.900	42.99	4.53	47.52	54.00	-6.48	AVG	H
2483.500	54.22	4.50	58.72	74.00	-15.28	peak	V
2483.500	45.60	4.50	50.10	54.00	-3.90	AVG	V
2487.950	57.10	4.53	61.63	74.00	-12.37	peak	V
2487.950	43.72	4.53	48.25	54.00	-5.75	AVG	V

11 Antenna Measurement

11.1.Limit

For intentional device, according to 15.203, an intentional radiator shall be designed to ensure that no antenna other than that furnished by the responsible party shall be used with the device.

And According to 15.247 (b), if transmitting antennas of directional gain greater than 6 dBi are used, the power shall be reduced by the amount in dB that the directional gain of the antenna exceeds 6dBi.

11.2.Antenna Connector Construction

Antenna Port	Model	Type	Max. Gain
ANT 0	MSA-3510-25GC4-A1	PIFA	3.37dBi
ANT 1	MSA-3310-25GC4-A1	PIFA	2.78dBi