



DFS Test Report

Applicant : Phorus Inc.
Product Type : Phorus Play-Fi Module
Trade Name : phorus
Model Number : CAPRICA2XL
Applicable Standard : FCC 47 CFR PART 15 SUBPART E
ANSI C63.10:2013
Receive Date : Jun. 08, 2017
Test Period : Jul. 06 ~ Jul. 07, 2017
Issue Date : Aug. 18, 2017

Issue by

A Test Lab Techno Corp.
No. 140-1, Changan Street, Bade District,
Taoyuan City 33465, Taiwan (R.O.C)
Tel : +886-3-2710188 / Fax : +886-3-2710190



Taiwan Accreditation Eoundation accreditation number: 1330
Test Firm MRA designation number: TW0010

Note: This report shall not be reproduced except in full, without the written approval of A Test Lab Techno Corp. This document may be altered or revised by A Test Lab Techno Corp. personnel only, and shall be noted in the revision section of the document. The client should not use it to claim product endorsement by TAF, or any government agencies. The test results in the report only apply to the tested sample.



Revision History

Rev.	Issue Date	Revisions	Revised By
00	Aug. 04, 2017	Initial Issue	Nina Lin
01	Aug. 10, 2017	Revised report information.	Nina Lin
02	Aug. 18, 2017	Revised report information.	Nina Lin

Verification of Compliance

Issued Date: Aug. 18, 2017

Applicant : Phorus Inc.
Product Type : Phorus Play-Fi Module
Trade Name : phorus
Model Number : CAPRICA2XL
FCC ID : 2AAWQ-CAPRICA2XL
EUT Rated Voltage : DC 5V / DC 3.3V / DC 1.8V / DC 1.1V
Test Voltage : DC 5V
Applicable Standard : FCC 47 CFR PART 15 SUBPART E
ANSI C63.10:2013
Test Result : Complied

Performing Lab. : A Test Lab Techno Corp.
No. 140-1, Changan Street, Bade District,
Taoyuan City 33465, Taiwan (R.O.C)
Tel : +886-3-2710188 / Fax : +886-3-2710190
Taiwan Accreditation Foundation accreditation number: 1330
<http://www.atl-lab.com.tw/e-index.htm>



A Test Lab Techno Corp. tested the above equipment in accordance with the requirements set forth in the above standards. All indications of Pass/Fail in this report are opinions expressed by A Test Lab Techno Corp. based on interpretations and/or observations of test results. Measurement Uncertainties were not taken into account and are published for informational purposes only. The test results show that the equipment tested is capable of demonstrating compliance with the requirements as documented in this report.

Approved By : Fly Lu Reviewed By : Eric Ou Yang
(Manager) (Fly Lu) (Testing Engineer) (Eric Ou Yang)



TABLE OF CONTENTS

1	EUT Description	5
2	Test Methodology	7
3	Dynamic Frequency Selection	7
	3.1. Limits.....	7
	3.2. Test and Measurement System	11
	3.3. Test Instruments	12
4	Test Methodology	13
	4.1. Mode of Operation.....	13
	4.2. EUT Exercise Software.....	13
	4.3. Test Site Environment.....	13
5	Test Results	14
	5.1. Radar Waveforms and Traffic	14
	5.2. Channel Move Time and Channel Closing Transmission Time	18
	5.3. Non-Occupancy Period.....	19
	5.4. Non-Associated Test.....	20



1 EUT Description

Applicant	Phorus Inc. 16255 Ventura Boulevard, Encino, California, 91436, United States			
Manufacturer	Phorus, Inc. 16255 Ventura Boulevard, Suite 310, Encino, United States, 91436			
Product Type	Phorus Play-Fi Module			
Trade Name	phorus			
Model Number	CAPRICA2XL			
FCC ID	2AAWQ-CAPRICA2XL			
Operate Frequency	Frequency Band		Frequency Range (MHz)	Number of Channels
	IEEE 802.11a	U-NII Band II-A	5260 – 5320	4
		U-NII Band II-C	5500 – 5700	8
	IEEE 802.11n 5GHz 20 MHz	U-NII Band II-A	5260 – 5320	4
		U-NII Band II-C	5500 – 5700	8
	IEEE 802.11n 5GHz 40 MHz	U-NII Band II-A	5270 – 5310	2
U-NII Band II-C		5510 – 5670	4	
Modulation Type	OFDM			
Equipment Type (DFS)	Client without radar detection			
Antenna information	ANT	Model	Type	Max. Gain (dBi)
	ANT-0	MSA-3310-25GC4-A25	PIFA Antenna	6.06
	ANT-1	MSA-3310-25GC4-A26	PIFA Antenna	6.06
	ANT-0 / ANT-1	EDA-1713-25GC1-A14	Dipole Antenna	5.18
Antenna Delivery	1TX / 1RX (Diversity)			
Operate Temp. Range	0 ~ 35 °C			

Keypart list :

Description	Manufacturer	Part Number	Remarks
Flash memory(1)	TOSHIBA	TC58NVG1S3 ETA00	Flash, 256MB, 2Gb
Flash memory(2)	WINBOND	W29N02GVSIAA	Flash, 256MB, 2Gb
Flash memory(3)	ESMT	F59L2G81LA	Flash, 256MB, 2Gb



Items	Description	
Communication Mode	<input checked="" type="checkbox"/> IP Based (Load Based)	<input type="checkbox"/> Frame Based
TPC Function	<input type="checkbox"/> With TPC	<input checked="" type="checkbox"/> Without TPC
Weather Band (5600 ~ 5650 MHz)	<input type="checkbox"/> With 5600 ~ 5650 MHz	<input checked="" type="checkbox"/> Without 5600 ~ 5650 MHz
Beamforming Function	<input type="checkbox"/> With Beamforming	<input checked="" type="checkbox"/> Without Beamforming
Equipment Type	<input type="checkbox"/> Outdoor access point	
	<input type="checkbox"/> Indoor access point	
	<input type="checkbox"/> Fixed point-to-point access points	
	<input checked="" type="checkbox"/> Client devices	
Operating mode	<input type="checkbox"/> Master	
	<input type="checkbox"/> Client with radar detection	
	<input checked="" type="checkbox"/> Client without radar detection	
	<input type="checkbox"/> Ad-Hoc	
	<input type="checkbox"/> Bridge	
	<input type="checkbox"/> MESH	
Test AP FCC ID	PY315100319	



2 Test Methodology

The tests documented in this report were performed in accordance with ANSI C63.10-2013, FCC CFR 47 Part 2, FCC CFR 47 Part 15.

The tests documented in this report were performed in accordance with FCC KDB request:

- FCC KDB 905462 D02 UNII DFS Compliance Procedures New Rules v02
- FCC KDB 905462 D03 UNII Clients Without Radar Detection New Rules v01r02

3 Dynamic Frequency Selection

3.1. Limits

§15.407 (h) and FCC KDB 905462 D02 UNII DFS Compliance Procedures New Rules v02 Compliance measurement procedures for unlicensed-national information infrastructure devcies operating in the 5250-5350 MHz and 5470-5725 MHz bands incorporating dynamic frequency selection.

Table 1: Applicability of DFS Requirements Prior to Use of a Channel			
Requirement	Operational Mode		
	Master	Client (without radar detection)	Client (with radar detection)
Non-Occupancy Period	Yes	Not required	Yes
DFS Detection Threshold	Yes	Not required	Yes
Channel Availability Check Time	Yes	Not required	Not required
U-NII Detection Bandwidth	Yes	Not required	Yes

Table 2: Applicability of DFS requirements during normal operation		
Requirement	Operational Mode	
	Master Device or Client With Radar Detection	Client without Radar Detection
DFS Detection Threshold	Yes	Not required
Channel Closing Transmission Time	Yes	Yes
Channel Move Time	Yes	Yes
U-NII Detection Bandwidth	Yes	Not required

Additional requirements for devices with multiple bandwidth modes	Master Device or Client With Radar Detection	Client without Radar Detection
U-NII Detection Bandwidth and Statistical Performance Check	All BW modes must be tested	Not required
Channel Move Time and Channel Closing Transmission Time	Test using widest BW mode available	Test using the widest BW mode available for the link
All other tests	Any single BW mode	Not required
Note : Frequencies selected for statistical performance check (Section 7.8.4) should include several frequencies within the radar detection bandwidth and frequencies near the edge of the radar detection bandwidth. For 802.11 devices it is suggested to select frequencies in all 20 MHz channel blocks and a null frequencies between the bonded 20 MHz channel blocks		



Table 3: DFS Detection Thresholds for Master Devices and Client Devices With Radar Detection	
Maximum Transmit Power	Value (See Notes 1,2 and 3)
EIRP ≥ 200 milliwatt	-64 dBm
EIRP < 200 milliwatt and Power spectral density < 10 dBm/MHz	-62 dBm
EIRP < 200 milliwatt that do not meet the power spectral density requirement	-64 dBm
<p>Note 1: This is the level at the input of the receiver assuming a 0 dBi receive antenna.</p> <p>Note 2: Throughout these test procedures an additional 1 dB has been added to the amplitude of the test transmission waveforms to account for variations in measurement equipment. This will ensure that the test signal is at or above the detection threshold level to trigger a DFS response.</p> <p>Note 3: EIRP is based on the highest antenna gain. For MIMO devices refer to FCC KDB Publication 662911 D01.</p>	

Table 4: DFS Response Requirement Values	
Parameter	Value
Non-occupancy period	Minimum 30 minutes
Channel Availability Check Time	60 seconds
Channel Move Time	10 seconds See Note 1.
Channel Closing Transmission Time	200 milliseconds + an aggregate of 60 milliseconds over remaining 10 second period. See Notes 1 and 2.
U-NII Detection Bandwidth	Minimum 100% of the U-NII 99% transmission power bandwidth. See Note 3.
<p>Note 1: Channel Move Time and the Channel Closing Transmission Time should be performed with Radar Type 0. The measurement timing begins at the end of the Radar Type 0 burst.</p> <p>Note 2: The Channel Closing Transmission Time is comprised of 200 milliseconds starting at the beginning of the Channel Move Time plus any additional intermittent control signals required to facilitate a Channel move (an aggregate of 60 milliseconds) during the remainder of the 10 second period. The aggregate duration of control signals will not count quiet periods in between transmissions.</p> <p>Note 3: During the U-NII Detection Bandwidth detection test, radar type 0 should be used. For each frequency step the minimum percentage of detection is 90 percent. Measurements are performed with no data traffic.</p>	



Table 5: Short Pulse Radar Test Waveforms					
Radar Type	Pulse Width (μsec)	PRI (μsec)	Number of Pulses	Minimum Percentage of Successful Detection	Minimum Number of Trials
0	1	1428	18	See Note 1	See Note 1
1	1	<p>Test A: 15 unique PRI values randomly selected from the list of 23 PRI values in Table 5a</p> <p>Test B: 15 unique PRI values randomly selected within the range of 518-3066 μsec, with a minimum increment of 1 μsec, excluding PRI values selected in Test A</p>	$\text{Roundup} \left\{ \left\{ \frac{1}{360} \right\}, \left\{ \frac{19 \cdot 10^6}{\text{PRI}_{\mu\text{sec}}} \right\} \right\}$	60%	30
2	1-5	150-230	23-29	60%	30
3	6-10	200-500	16-18	60%	30
4	11-20	200-500	12-16	60%	30
Aggregate (Radar Types 1-4)				80%	120
Note 1: Short Pulse Radar Type 0 should be used for the detection bandwidth test, channel move time, and channel closing time tests.					



Table 5a: Pulse Repetition Intervals Values for Test A		
Pulse Repetition Frequency Number	Pulse Repetition Frequency (Pulses Per Second)	Pulse Repetition Interval (Microseconds)
1	1930.5	518
2	1858.7	538
3	1792.1	558
4	1730.1	578
5	1672.2	598
6	1618.1	618
7	1567.4	638
8	1519.8	658
9	1474.9	678
10	1432.7	698
11	1392.8	718
12	1355	738
13	1319.3	758
14	1285.3	778
15	1253.1	798
16	1222.5	818
17	1193.3	838
18	1165.6	858
19	1139	878
20	1113.6	898
21	1089.3	918
22	1066.1	938
23	326.2	3066

Table 6 – Long Pulse Radar Test Signal							
Radar Waveform	Bursts	Pulses per Burst	Pulse Width (µsec)	Chirp Width (MHz)	PRI (µsec)	Minimum Percentage of Successful Detection	Minimum Trials
5	8-20	1-3	50-100	5-20	1000-2000	80%	30

Table 7 – Frequency Hopping Radar Test Signal							
Radar Waveform	Pulse Width (µsec)	PRI (µsec)	Burst Length (ms)	Pulses per Hop	Hopping Rate (kHz)	Minimum Percentage of Successful Detection	Minimum Trials
6	1	333	300	9	0.333	70%	30

3.2. Test and Measurement System

3.2.1. Setup for Client with injection at the Master

Example Radiated Setup where UUT is a Client and Radar Test Waveforms are injected into the Master

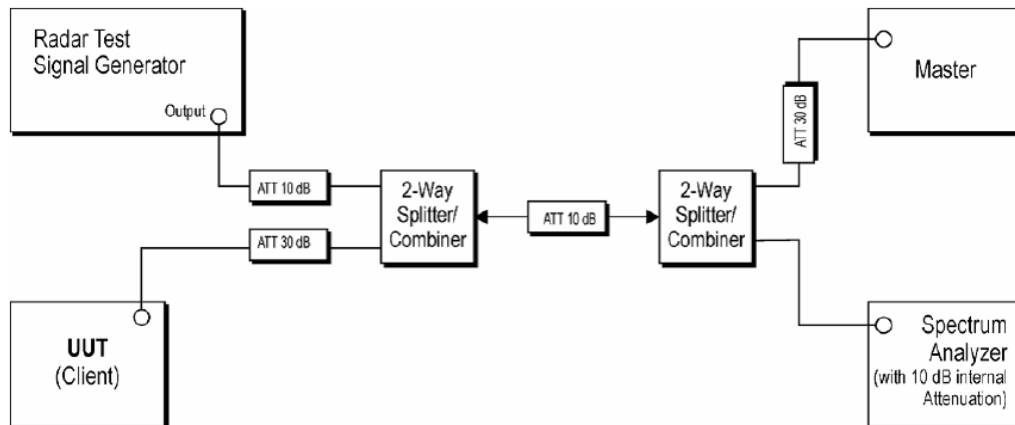

3.2.2. System Calibration

The short pulse types 0,1,2, 3 and 4, and the long pulse type 5 parameters are randomized at run-time. The hopping type 6 pulse parameters are fixed while the hopping sequence is based on the May 2014 NTIA Hopping Frequency List. The initial starting point randomized at run-time and each subsequent starting point is incremented by 475. Each frequency in the 100-length segment is compared to the boundaries of the EUT Detection Bandwidth and the software creates a hopping burst pattern in accordance with Section 7.4.1.3 Method #2 Simulated Frequency Hopping Radar Waveform Generating Subsystem of FCC KDB 905462 D02 UNII DFS Compliance Procedures New Rules v02. The frequency of the signal generator is incremented in 1 MHz steps from FL to FH for each successive trial. This incremental sequence is repeated as required to generate a minimum of 30 total trials and to maintain a uniform frequency distribution over the entire Detection Bandwidth.

The signal monitoring equipment consists of a spectrum analyzer. The aggregate ON time is calculated by multiplying the number of bins above a threshold during a particular observation period by the dwell time per bin, with the analyzer set to peak detection and max hold.



3.2.3. System Calibration

The Interference Radar Detection Threshold Level is (-64dBm), The above equipment setup was used to calibrate the radiated Radar Waveform. A vector signal generator was utilized to establish the test signal level for each radar type. During this process there were replace 50ohm terminal form Master and Client device and no transmissions by either the Master or Client Device. The spectrum analyzer was switched to the zero span (Time Domain) at the frequency of the Radar Waveform generator. Peak detection was used. The spectrum analyzer resolution bandwidth (RBW) and video bandwidth (VBW) were set to at least 3 MHz.

The vector signal generator amplitude was set so that the power level measured at the spectrum analyzer was (-64dBm). Capture the spectrum analyzer plots on short pulse radar types, long pulse radar type and hopping radar waveform.

3.2.4. Adjustment of Displayed Traffic Level

A link is established between the Master and Slave and the distance between the units is adjusted as needed to provide a suitable received level at the Master and Slave devices. Software to ping the client is permitted to simulate data transfer but must have random ping intervals. The monitoring antenna is adjusted so that the WLAN traffic level, as displayed on the spectrum analyzer, is at lower amplitude than the radar detection threshold.

3.3. Test Instruments

Equipment	Manufacturer	Model Number	Serial Number	Cal. Date	Remark
EXA Spectrum Analyzer	Agilent	N9010A	MY48030518	11/04/2016	1 year
Signal Generator	Agilent	N5182B	MY53050382	05/24/2017	1 year
Double-Ridged Waveguide Horn	ETS-Lindgren	3117	00128055	09/08/2016	1 year
Double Ridged Horn Antenna	ETS	3117	00152321	08/23/2016	1 year
DFS Cable	ATL	DFS	009	10/12/2016	1 year
Microwave Cable	EMCI	EMC104-SM-SM-10000	150401	12/28/2016	1 year
Test Site	ATL	TE02	TE02	N.C.R.	-----

Note N.C.R. = No Calibration Request.

4 Test Methodology

4.1. Mode of Operation

Decision of Test ATL has verified the construction and function in typical operation. All the test modes were carried out with the EUT in normal operation, which was shown in this test report and defined as:

Test Mode
Mode 1: IEEE 802.11n 5GHz 40MHz Continuous TX mode

IEEE 802.11n 5GHz 40MHz Continuous TX mode

Unless otherwise noted, all tests were performed with the radar burst at the channel center frequency of 5550 MHz.

Tested System Details

The types for all equipments, plus descriptions of all cables used in the tested system (including inserted cards) are:

	Product	Manufacturer	Model No.	ID
1.	Netgear Access Point	Netgear	R7800	FCC : PY35100319

4.2. EUT Exercise Software

1.	Setup the EUT shown on 3.2.1
2.	Turn on the power of all equipment.
3.	Turn on Wi-Fi function link to Notebook.
4.	The EUT is operated in the engineering mode to fix the TX frequency for the purposes of measurement.

4.3. Test Site Environment

Items	Required (IEC 60068-1)	Actual
Temperature (°C)	15-35	26
Humidity (%RH)	25-75	60
Barometric pressure (mbar)	860-1060	950



5 Test Results

5.1. Radar Waveforms and Traffic

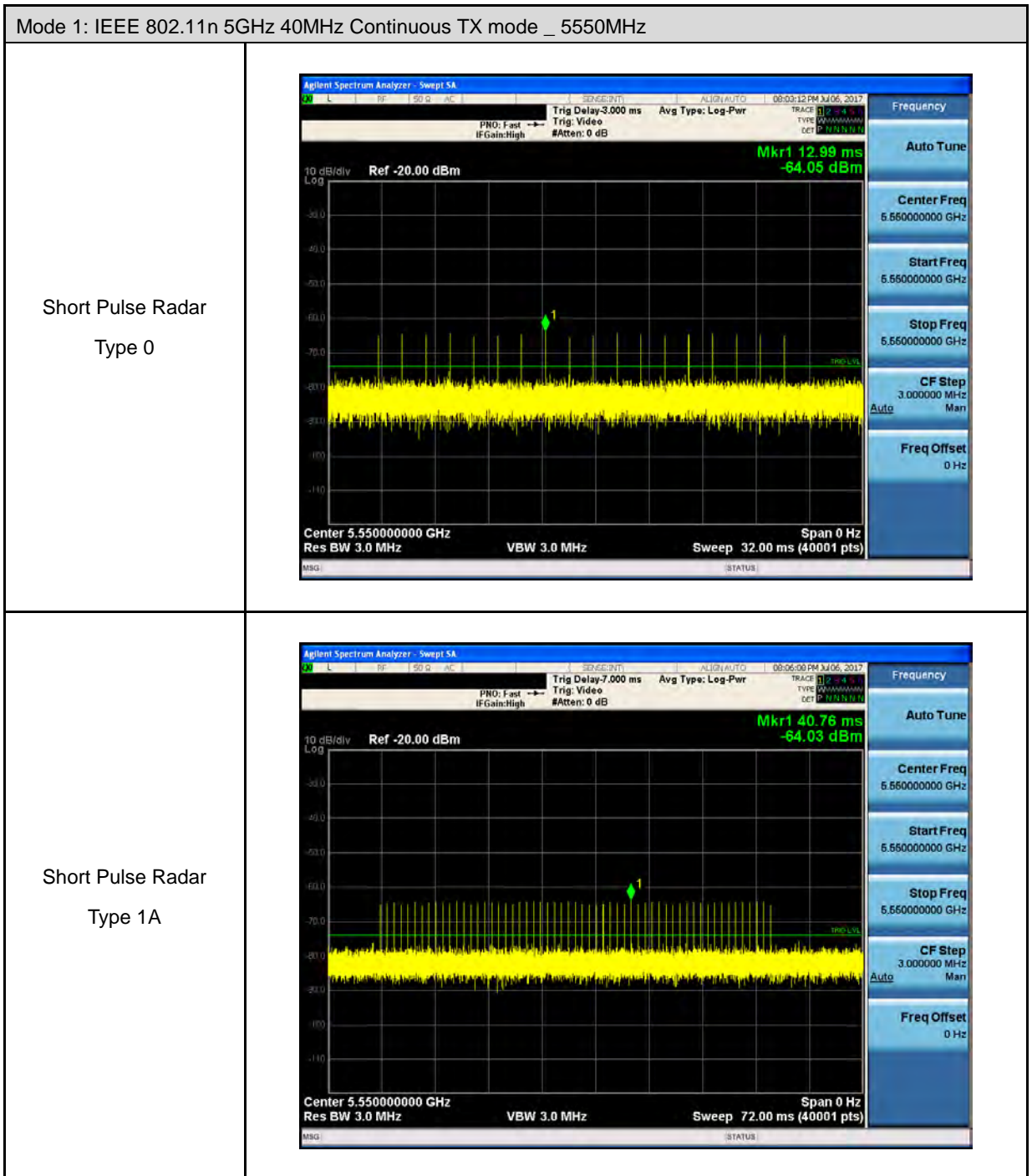

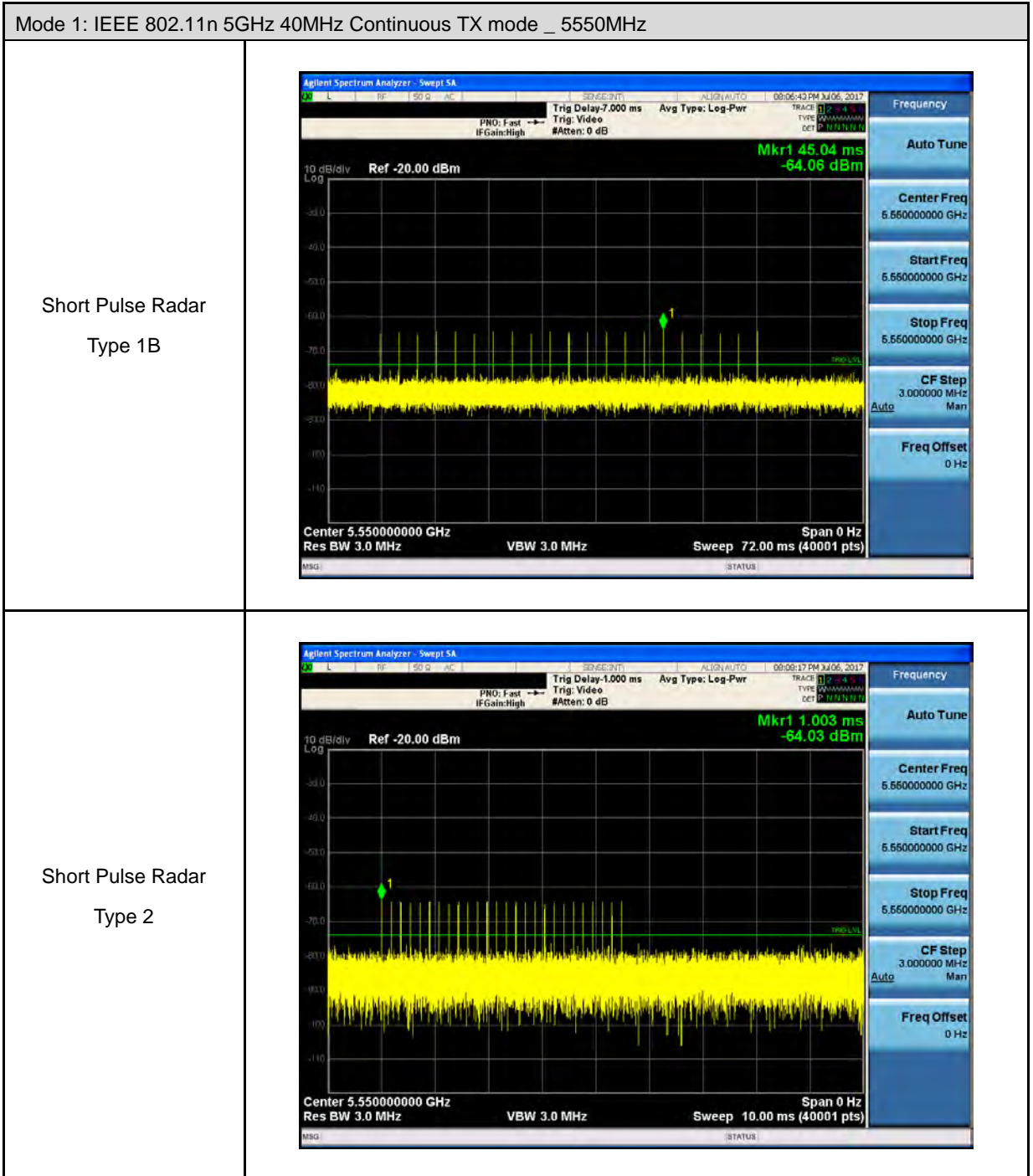

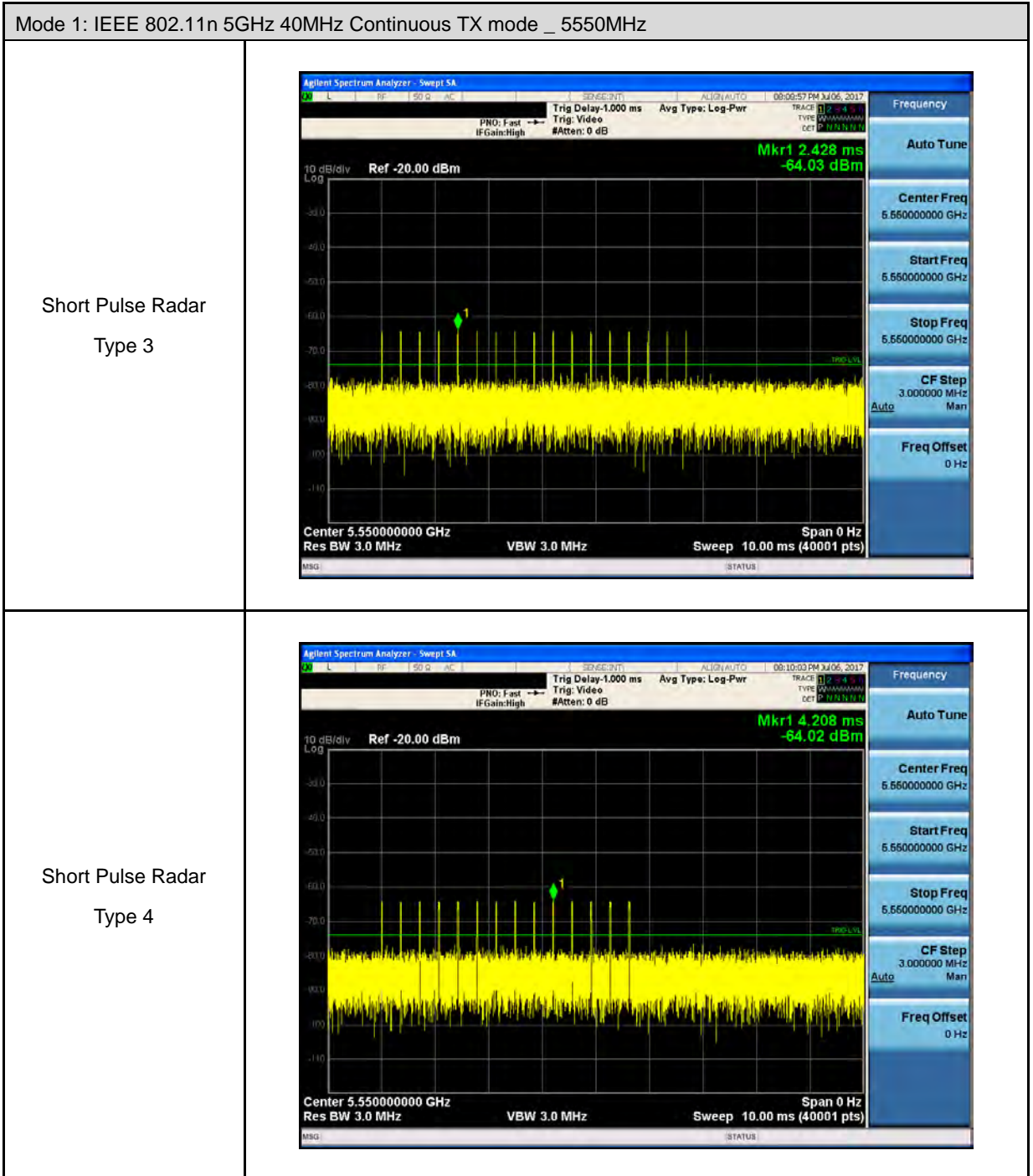

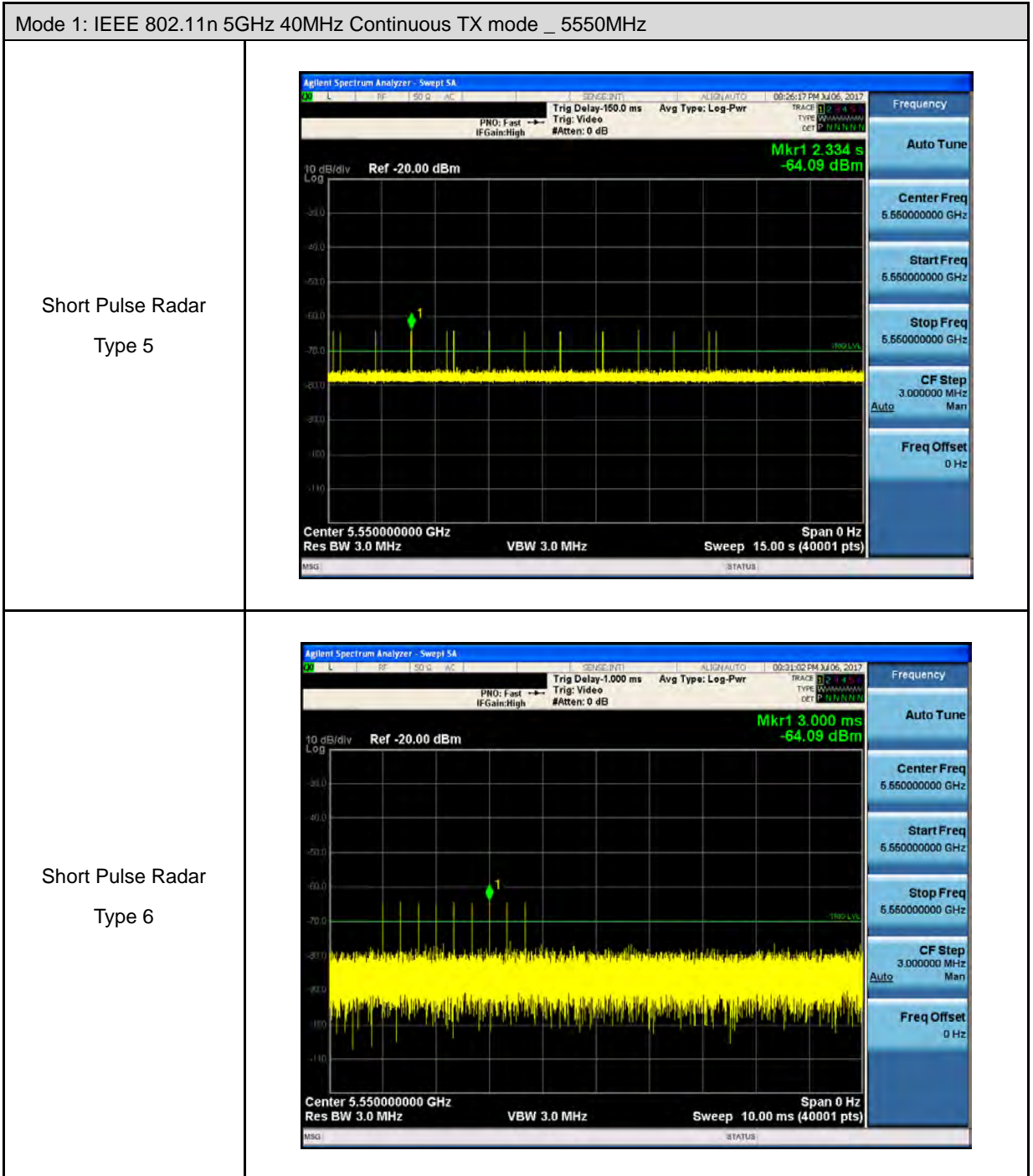



5.2. Channel Move Time and Channel Closing Transmission Time

5.2.1. Reporting Notes

The reference marker is set at the end of last radar pulse.

The delta marker is set at the end of the last WLAN transmission following the radar pulse.
This delta is the channel move time.

The aggregate channel closing transmission time is calculated as follows:

Aggregate Transmission Time = (Number of analyzer bins showing transmission) * (dwell time per bin)

The Channel Closing Transmission Time is comprised of 200 milliseconds starting at the beginning of the Channel Move Time plus any additional intermittent control signals required to facilitate a Channel move (an aggregate of 60 milliseconds) during the remainder of the 10 second period. The aggregate duration of control signals will not count quiet periods in between transmissions.

Results

Frequency (MHz)	Radar Type	Channel Move Time (sec)	Limit (sec)
5550	Type 0	0.4620	10

Frequency (MHz)	Radar Type	Aggregate Channel Closing Transmission Time (msec)	Limit (msec)
5550	Type 0	0.5000	60

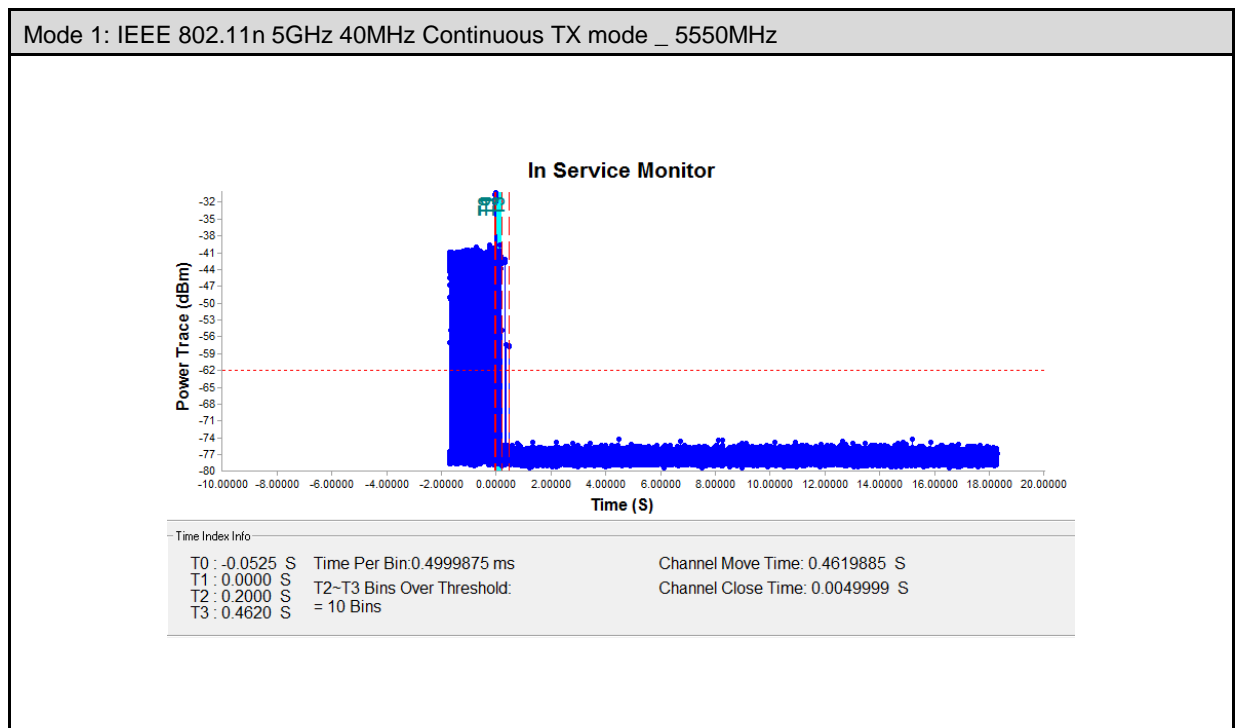

5.3. Non-Occupancy Period

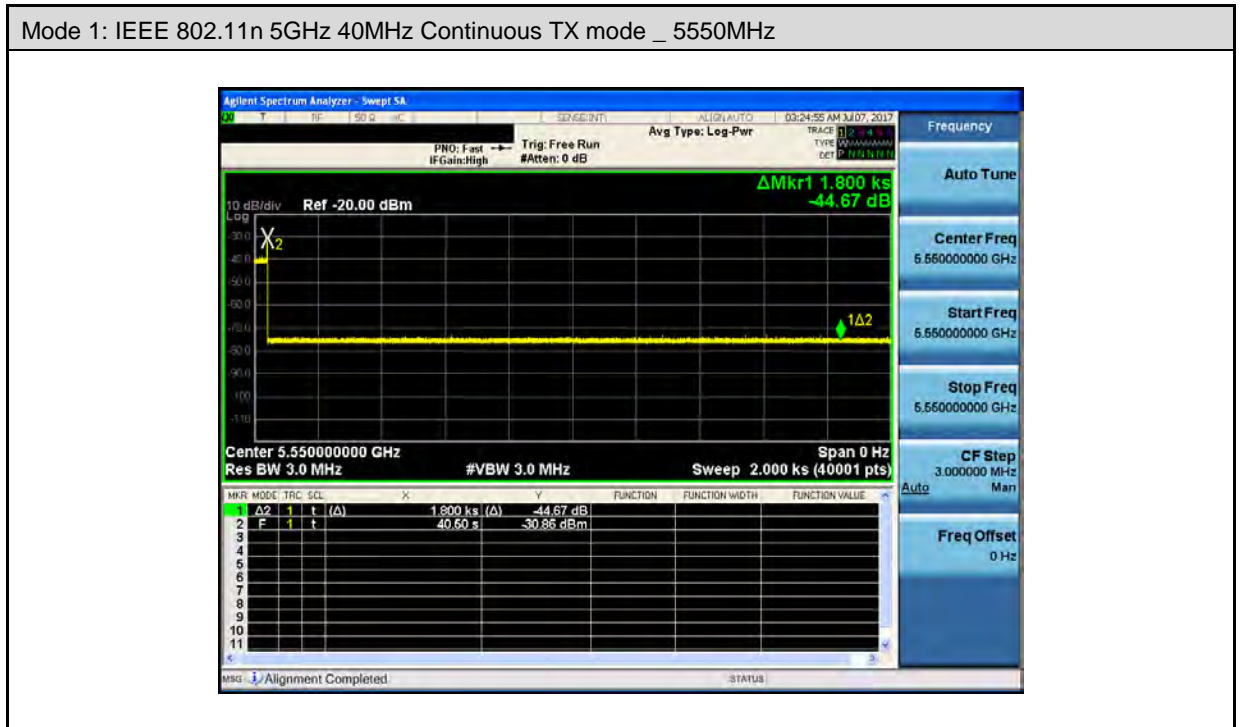

Note: Non-Occupancy Period time is 30 minute during which a Channel will not be utilized after a Radar Waveform is detected on that Channel.

5.4. Non-Associated Test

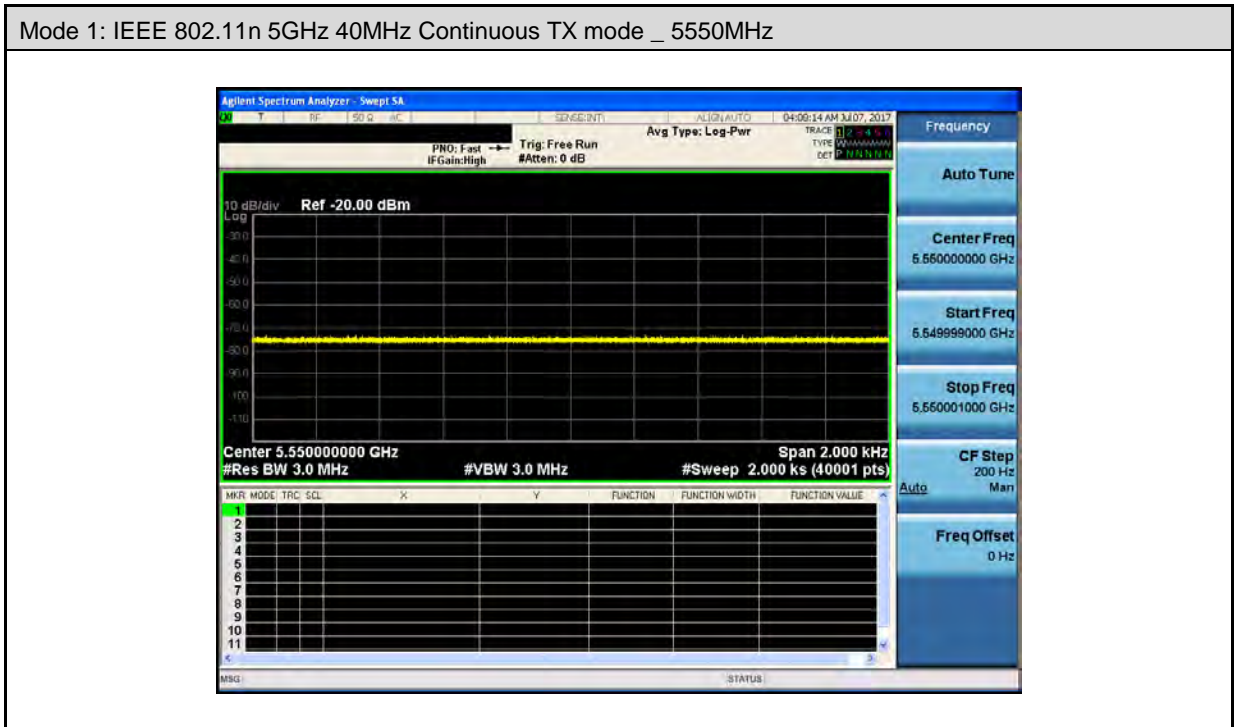

Note: The non-associated Client Beacon Test is during the 30 minutes observation time. The EUT should not make any transmissions in the DFS band after EUT power up.